

## FCC Test Report (BT-LE)

**Report No.:** RFBAOZ-WTW-P21030111C-1

**FCC ID:** 2AEUPBHASC071

**Test Model:** 5UM7E5

**Received Date:** July 21, 2021

**Test Date:** July 29 to 31, 2021

**Issued Date:** Aug. 13, 2021

**Applicant:** Ring LLC

**Address:** 1523 26th Street, Santa Monica, CA 90404 United States

**Issued By:** Bureau Veritas Consumer Products Services (H.K.) Ltd., Taoyuan Branch  
Hsin Chu Laboratory

**Lab Address:** E-2, No.1, Li Hsin 1st Road, Hsinchu Science Park, Hsinchu City 300,  
Taiwan

**Test Location:** E-2, No.1, Li Hsin 1st Road, Hsinchu Science Park, Hsinchu City 300,  
Taiwan

**FCC Registration /  
Designation Number:** 723255 / TW2022



This report is for your exclusive use. Any copying or replication of this report to or for any other person or entity, or use of our name or trademark, is permitted only with our prior written permission. This report sets forth our findings solely with respect to the test samples identified herein. The results set forth in this report are not indicative or representative of the quality or characteristics of the lot from which a test sample was taken or any similar or identical product unless specifically and expressly noted. Our report includes all of the tests requested by you and the results thereof based upon the information that you provided to us. You have 60 days from date of issuance of this report to notify us of any material error or omission caused by our negligence, provided, however, that such notice shall be in writing and shall specifically address the issue you wish to raise. A failure to raise such issue within the prescribed time shall constitute your unqualified acceptance of the completeness of this report, the tests conducted and the correctness of the report contents. Unless specific mention, the uncertainty of measurement has been explicitly taken into account to declare the compliance or non-compliance to the specification.

## Table of Contents

<b>Release Control Record</b> .....	<b>3</b>
<b>1 Certificate of Conformity</b> .....	<b>4</b>
<b>2 Summary of Test Results</b> .....	<b>5</b>
2.1 Measurement Uncertainty .....	5
2.2 Modification Record .....	5
<b>3 General Information</b> .....	<b>6</b>
3.1 General Description of EUT (BT-LE) .....	6
3.2 Description of Test Modes .....	8
3.2.1 Test Mode Applicability and Tested Channel Detail .....	9
3.3 Duty Cycle of Test Signal .....	11
3.4 Description of Support Units .....	12
3.4.1 Configuration of System under Test .....	12
3.5 General Description of Applied Standards and References .....	13
<b>4 Test Types and Results</b> .....	<b>14</b>
4.1 Radiated Emission and Bandedge Measurement .....	14
4.1.1 Limits of Radiated Emission and Bandedge Measurement .....	14
4.1.2 Test Instruments .....	15
4.1.3 Test Procedures .....	17
4.1.4 Deviation from Test Standard .....	17
4.1.5 Test Setup .....	18
4.1.6 EUT Operating Conditions .....	19
4.1.7 Test Results .....	20
4.2 Conducted Emission Measurement .....	25
4.2.1 Limits of Conducted Emission Measurement .....	25
4.2.2 Test Instruments .....	25
4.2.3 Test Procedures .....	26
4.2.4 Deviation from Test Standard .....	26
4.2.5 Test Setup .....	26
4.2.6 EUT Operating Conditions .....	26
4.2.7 Test Results .....	27
4.3 Conducted Output Power Measurement .....	29
4.3.1 Limits of Conducted Output Power Measurement .....	29
4.3.2 Test Setup .....	29
4.3.3 Test Instruments .....	29
4.3.4 Test Procedures .....	29
4.3.5 Deviation from Test Standard .....	29
4.3.6 EUT Operating Conditions .....	29
4.3.7 Test Results .....	30
<b>5 Pictures of Test Arrangements</b> .....	<b>31</b>
<b>Annex A - Band-Edge Measurement</b> .....	<b>32</b>
<b>Appendix – Information of the Testing Laboratories</b> .....	<b>33</b>

### Release Control Record

Issue No.	Description	Date Issued
RFBAOZ-WTW-P21030111C-1	Original release.	Aug. 13, 2021

## 1 Certificate of Conformity

**Product:** Stick Up Cam Plug-In, Stick Up Cam Battery

**Brand:** Ring

**Test Model:** 5UM7E5

**Sample Status:** Engineering sample

**Applicant:** Ring LLC

**Test Date:** July 29 to 31, 2021

**Standards:** 47 CFR FCC Part 15, Subpart C (Section 15.247)  
ANSI C63.10: 2013

The above equipment has been tested by **Bureau Veritas Consumer Products Services (H.K.) Ltd., Taoyuan Branch**, and found compliance with the requirement of the above standards. The test record, data evaluation & Equipment Under Test (EUT) configurations represented herein are true and accurate accounts of the measurements of the sample's EMC characteristics under the conditions specified in this report.

**Prepared by :** Cherry Chuo , **Date:** Aug. 13, 2021  
Cherry Chuo / Specialist

**Approved by :** Clark Lin , **Date:** Aug. 13, 2021  
Clark Lin / Technical Manager

## 2 Summary of Test Results

47 CFR FCC Part 15, Subpart C (Section 15.247)			
FCC Clause	Test Item	Result	Remarks
15.207	AC Power Conducted Emission	PASS	Meet the requirement of limit. Minimum passing margin is -21.07 dB at 0.36094 MHz.
15.205 / 15.209 / 15.247(d)	Radiated Emissions and Band Edge Measurement	PASS	Meet the requirement of limit. Minimum passing margin is -6.4 dB at 34.03 MHz.
15.247(d)	Antenna Port Emission	NA	Refer to Note 1 below
15.247(a)(2)	6dB bandwidth	NA	Refer to Note 1 below
15.247(b)	Conducted power	NA	Refer to Note 1 below
15.247(e)	Power Spectral Density	NA	Refer to Note 1 below
15.203	Antenna Requirement	PASS	No antenna connector is used.

### Note:

1. Conducted Output Power, AC Power Conducted Emission and Radiated Emissions Measurement were performed for this addendum. The others testing data refer to original test report.
2. For 2.4 GHz band compliance with rule 15.247(d) of the band-edge items, the test plots were recorded in Annex A.
3. Determining compliance based on the results of the compliance measurement, not taking into account measurement instrumentation uncertainty.
4. This report is prepared for supplementary report.

### 2.1 Measurement Uncertainty

Where relevant, the following measurement uncertainty levels have been estimated for tests performed on the EUT as specified in CISPR 16-4-2:

Measurement	Frequency	Expanded Uncertainty (k=2) ( $\pm$ )
Conducted Emissions at mains ports	150kHz ~ 30MHz	1.9 dB
Conducted Emission	-	2.5 dB
Radiated Emissions up to 1 GHz	9kHz ~ 30MHz	3.1 dB
	30MHz ~ 1GHz	5.5 dB
Radiated Emissions above 1 GHz	1GHz ~ 18GHz	5.1 dB
	18GHz ~ 40GHz	5.3 dB

### 2.2 Modification Record

There were no modifications required for compliance.

### 3 General Information

#### 3.1 General Description of EUT (BT-LE)

Product	Stick Up Cam Plug-In, Stick Up Cam Battery
Brand	Ring
Test Model	5UM7E5
Status of EUT	Engineering sample
Power Supply Rating	DC 3.65V from battery or DC 5V from power adapter
Modulation Type	GFSK
Modulation Technology	DTS
Transfer Rate	Up to 1Mbps
Operating Frequency	2402MHz ~ 2480MHz
Number of Channel	40
Output Power	2.904 mW
Antenna Type	Refer to Note
Antenna Connector	Refer to Note
Accessory Device	Adapter x 1, Battery x 1
Cable Supplied	Extension cord x 1 (AC cable: Unshielded, 4.4m) USB cable x 1 (Unshielded, 0.52m)

Note:

- This report is prepared for FCC Class II permissive change. The difference compared with the Report No.: RF190529E02C-1 design is as the following information:
  - ◆ Changed Bluetooth antenna. (Refer to Note 6)
- According to above conditions, only Conducted Output Power, AC Power Conducted Emission and Radiated Emissions test need to be performed. And all data are verified to meet the requirements.
- The EUT has below product names, which are identical to each other in all aspects except for the following table:

Product	Brand	Model	Difference
Stick Up Cam Plug-In	Ring	5UM7E5	For marketing purpose.
Stick Up Cam Battery			

- The device of WLAN and Bluetooth technology can't transmit simultaneously.

5. The EUT could be supplied with a battery and power adapter, and following below different model names could be chosen:

No.	Brand Name	Model Name.	Model name of supplier	Spec.
1	ring	V4	EXAP021A2002	3.65 Vdc, 6040mAh, 22.046Wh
2			EXAP011A2002	3.65 Vdc, 6040mAh, 22.046Wh
3			9.05.186501-2PGH-15	3.65 Vdc, 6040mAh, 22.046Wh
4			9.05.186501-2PGH-14	3.65 Vdc, 6040mAh, 22.046Wh

Adapter

No.	Brand Name	Model No.	Spec.
1	ring	E013-1A050250D5	AC Input: 100-240Vac, 0.5A, 50/60Hz DC Output: 5.0V, 2.5A DC Output Cable: unshielded, 2.6 m

6. The antenna provided to the EUT, please refer to the following table:

WLAN						
Brand	Model	Antenna Gain (dBi)	Frequency range (GHz)	Antenna Type	Connector Type	Cable Length (cm)
RF LINK	RF11C02698S	2.7	2.4~2.4835	FPC	i-pex(MHF)	10
Bluetooth						
Brand	Model	Antenna Gain (dBi)	Frequency range (GHz)	Antenna Type	Connector Type	
Walsin Technology Corporation	RFECA3216060AM9FNH	3.37	2.4~2.4835	Chip	None	

7. In the original report, for radiated emissions, the EUT was pre-tested under the following test modes:

Test Mode	Description
Mode A	Power from adapter without extension cord
<b>Mode B</b>	<b>Power from adapter with extension cord</b>
Mode C	Power from Battery

From the above modes, **Mode B** was selected as representative. Therefore only the test data of the mode was recorded in this report.

8. The above EUT information is declared by manufacturer and for more detailed features description, please refers to the manufacturer's specifications or user's manual.

9. The above Antenna information is declared by manufacturer and for more detailed features description, please refer to the manufacturer's specifications, the laboratory shall not be held responsible.

### 3.2 Description of Test Modes

40 channels are provided to this EUT:

Channel	Frequency (MHz)	Channel	Frequency (MHz)	Channel	Frequency (MHz)	Channel	Frequency (MHz)
0	2402	10	2422	20	2442	30	2462
1	2404	11	2424	21	2444	31	2464
2	2406	12	2426	22	2446	32	2466
3	2408	13	2428	23	2448	33	2468
4	2410	14	2430	24	2450	34	2470
5	2412	15	2432	25	2452	35	2472
6	2414	16	2434	26	2454	36	2474
7	2416	17	2436	27	2456	37	2476
8	2418	18	2438	28	2458	38	2478
9	2420	19	2440	29	2460	39	2480



### 3.2.1 Test Mode Applicability and Tested Channel Detail

EUT CONFIGURE MODE	APPLICABLE TO				DESCRIPTION
	RE $\geq$ 1G	RE $<$ 1G	PLC	APCM	
-	√	√	√	√	-

Where **RE $\geq$ 1G**: Radiated Emission above 1GHz & Bandedge Measurement

**RE $<$ 1G**: Radiated Emission below 1GHz

**PLC**: Power Line Conducted Emission

**APCM**: Antenna Port Conducted Measurement

**Note:** In the original report, the EUT had been pre-tested on the positioned of each 3 axis. The worst case was found when positioned on **Y-plane (below 1GHz) & X-plane (above 1GHz)**

#### **Radiated Emission Test (Above 1GHz):**

- Pre-Scan has been conducted to determine the worst-case mode from all possible combinations between available modulations, data rates and antenna ports (if EUT with antenna diversity architecture).
- Following channel(s) was (were) selected for the final test as listed below.

AVAILABLE CHANNEL	TESTED CHANNEL	MODULATION TYPE	DATA RATE (Mbps)
0 to 39	0, 19, 39	GFSK	1

#### **Radiated Emission Test (Below 1GHz):**

- Pre-Scan has been conducted to determine the worst-case mode from all possible combinations between available modulations, data rates and antenna ports (if EUT with antenna diversity architecture).
- Following channel(s) was (were) selected for the final test as listed below.

AVAILABLE CHANNEL	TESTED CHANNEL	MODULATION TYPE	DATA RATE (Mbps)
0 to 39	0	GFSK	1

#### **Power Line Conducted Emission Test:**

- Pre-Scan has been conducted to determine the worst-case mode from all possible combinations between available modulations, data rates and antenna ports (if EUT with antenna diversity architecture).
- Following channel(s) was (were) selected for the final test as listed below.

AVAILABLE CHANNEL	TESTED CHANNEL	MODULATION TYPE	DATA RATE (Mbps)
0 to 39	0	GFSK	1

**Antenna Port Conducted Measurement:**

- Pre-Scan has been conducted to determine the worst-case mode from all possible combinations between available modulations, data rates and antenna ports (if EUT with antenna diversity architecture).
- Following channel(s) was (were) selected for the final test as listed below.

AVAILABLE CHANNEL	TESTED CHANNEL	MODULATION TYPE	DATA RATE (Mbps)
0 to 39	0, 19, 39	GFSK	1
0 to 39	0, 19, 39	GFSK	2

**Test Condition:**

APPLICABLE TO	ENVIRONMENTAL CONDITIONS	INPUT POWER (System)	TESTED BY
RE $\geq$ 1G	25deg. C, 75%RH	120Vac, 60Hz	Sampson Chen
RE $<$ 1G	25deg. C, 66%RH	120Vac, 60Hz	Sampson Chen
PLC	25deg. C, 70%RH	120Vac, 60Hz	Sampson Chen
APCM	25deg. C, 60%RH	120Vac, 60Hz	Anderson Chen

### 3.3 Duty Cycle of Test Signal

Duty cycle of test signal is < 98 %, duty factor shall be considered.

Duty cycle =  $0.389 \text{ ms} / 0.625 \text{ ms} = 0.622$ , Duty factor =  $10 * \log(1/\text{Duty cycle}) = 2.06 \text{ dB}$

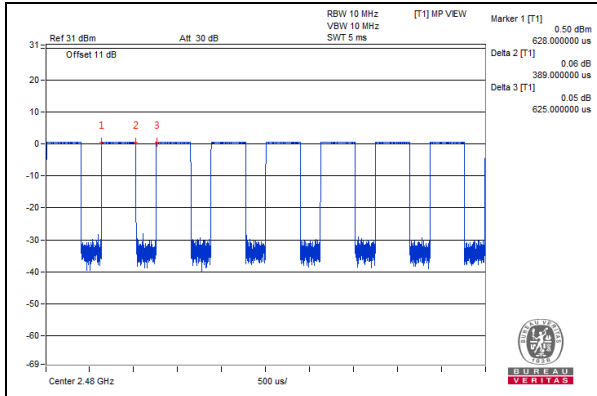

### 3.4 Description of Support Units

The EUT has been tested as an independent unit together with other necessary accessories or support units. The following support units or accessories were used to form a representative test configuration during the tests.

ID	Descriptions	Qty.	Length (m)	Shielding (Yes/No)	Cores (Qty.)	Remarks
1.	DC Cable	1	2.6	No	0	Supplied by client

#### 3.4.1 Configuration of System under Test

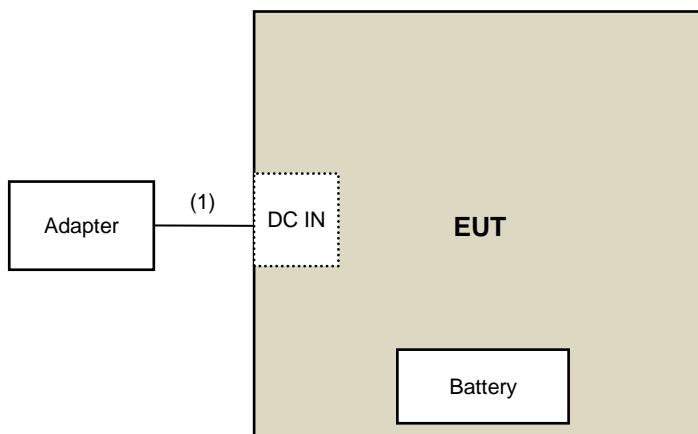

### 3.5 General Description of Applied Standards and References

The EUT is a RF Product. According to the specifications of the manufacturer, it must comply with the requirements of the following standards and references:

**Test Standard:**

**FCC Part 15, Subpart C (15.247)**

**ANSI C63.10-2013**

All test items have been performed and recorded as per the above standards.

**References Test Guidance:**

**KDB 558074 D01 15.247 Meas Guidance v05r02**

All test items have been performed as a reference to the above KDB test guidance.

## 4 Test Types and Results

### 4.1 Radiated Emission and Bandedge Measurement

#### 4.1.1 Limits of Radiated Emission and Bandedge Measurement

Radiated emissions which fall in the restricted bands must comply with the radiated emission limits specified as below table. Other emissions shall be at least 20dB below the highest level of the desired power:

Frequencies (MHz)	Field Strength (microvolts/meter)	Measurement Distance (meters)
0.009 ~ 0.490	2400/F(kHz)	300
0.490 ~ 1.705	24000/F(kHz)	30
1.705 ~ 30.0	30	30
30 ~ 88	100	3
88 ~ 216	150	3
216 ~ 960	200	3
Above 960	500	3

**Note:**

1. The lower limit shall apply at the transition frequencies.
2. Emission level (dBuV/m) = 20 log Emission level (uV/m).
3. For frequencies above 1000MHz, the field strength limits are based on average detector, however, the peak field strength of any emission shall not exceed the maximum permitted average limits, specified above by more than 20dB under any condition of modulation.

## 4.1.2 Test Instruments

**For Radiated Emission and Bandedge test:**

DESCRIPTION & MANUFACTURER	MODEL NO.	SERIAL NO.	CALIBRATED DATE	CALIBRATED UNTIL
Test Receiver Agilent	N9038A	MY51210202	Dec. 01, 2020	Nov. 30, 2021
Pre-Amplifier EMCI	EMC001340	980142	May 24, 2021	May 23, 2022
Loop Antenna Electro-Metrics	EM-6879	264	Mar. 05, 2021	Mar. 04, 2022
RF Cable	5D-FB	LOOPCAB-001	Jan. 07, 2021	Jan. 06, 2022
RF Cable	5D-FB	LOOPCAB-002	Jan. 07, 2021	Jan. 06, 2022
Pre-Amplifier EMCI	EMC330N	980701	Mar. 10, 2021	Mar. 09, 2022
Trilog Broadband Antenna SCHWARZBECK	VULB 9168	9168-406	Nov. 06, 2020	Nov. 05, 2021
RF Cable	8D	966-4-1	Mar. 17, 2021	Mar. 16, 2022
RF Cable	8D	966-4-2	Mar. 17, 2021	Mar. 16, 2022
RF Cable	8D	966-4-3	Mar. 17, 2021	Mar. 16, 2022
Fixed attenuator Mini-Circuits	UNAT-5+	PAD-ATT5-03	Jan. 11, 2021	Jan. 10, 2022
Horn_Antenna SCHWARZBECK	BBHA 9120D	9120D-783	Nov. 22, 2020	Nov. 21, 2021
Pre-Amplifier EMCI	EMC 12630 SE	980638	Apr. 07, 2021	Apr. 06, 2022
RF Cable	EMC104-SM-SM-1200	160922	Dec. 25, 2020	Dec. 24, 2021
RF Cable	EMC104-SM-SM-2000	180502	Apr. 26, 2021	Apr. 25, 2022
RF Cable	EMC104-SM-SM-6000	180418	Apr. 26, 2021	Apr. 25, 2022
Pre-Amplifier EMCI	EMC184045SE	980387	Jan. 11, 2021	Jan. 10, 2022
Horn_Antenna SCHWARZBECK	BBHA 9170	BBHA9170519	Nov. 22, 2020	Nov. 21, 2021
RF Cable	EMC102-KM-KM-1200	160924	Jan. 11, 2021	Jan. 10, 2022
RF Cable	EMC-KM-KM-4000	200214	Mar. 10, 2021	Mar. 09, 2022
Software	ADT_Radiated_V8.7.08	NA	NA	NA
Boresight Antenna Tower & Turn Table Max-Full	MF-7802BS	MF780208530	NA	NA

**Note:**

1. The calibration interval of the above test instruments is 12 months and the calibrations are traceable to NML/ROC and NIST/USA.
2. The test was performed in 966 Chamber No. 4.
3. Tested Date: July 29 to 30, 2021

**For other test:**

DESCRIPTION & MANUFACTURER	MODEL NO.	SERIAL NO.	CALIBRATED DATE	CALIBRATED UNTIL
Spectrum Analyzer R&S	FSV40	101516	Mar. 08, 2021	Mar. 07, 2022
Power meter Anritsu	ML2495A	1529002	June 21, 2021	June 20, 2022
Power sensor Anritsu	MA2411B	1339443	May 31, 2021	May 30, 2022
10dB Attenuator Woken	MDCS18N-10	MDCS18N-10-01	Apr. 13, 2021	Apr. 12, 2022
Software	ADT_RF Test Software V6.6.5.4	NA	NA	NA

- NOTE:**
1. The test was performed in Oven room 2.
  2. The calibration interval of the above test instruments is 12 months and the calibrations are traceable to NML/ROC and NIST/USA.
  3. Tested Date: July 31, 2021



#### 4.1.3 Test Procedures

##### **For Radiated emission below 30MHz**

- a. The EUT was placed on the top of a rotating table 0.8 meters above the ground at a 3 meter chamber room. The table was rotated 360 degrees to determine the position of the highest radiation.
- b. The EUT was set 3 meters away from the interference-receiving antenna, which was mounted on the top of a variable-height antenna tower.
- c. Parallel, perpendicular, and ground-parallel orientations of the antenna are set to make the measurement.
- d. For each suspected emission, the EUT was arranged to its worst case and the rotatable table was turned from 0 degrees to 360 degrees to find the maximum reading.
- e. The test-receiver system was set to Quasi-Peak Detect Function and Specified Bandwidth with Maximum Hold Mode.

##### **Note:**

1. The resolution bandwidth and video bandwidth of test receiver/spectrum analyzer is 9kHz at frequency below 30MHz.

##### **For Radiated emission above 30MHz**

- a. The EUT was placed on the top of a rotating table 0.8 meters (for 30MHz ~ 1GHz) / 1.5 meters (for above 1GHz) above the ground at 3 meter chamber room for test. The table was rotated 360 degrees to determine the position of the highest radiation.
- b. The EUT was set 3 meters away from the interference-receiving antenna, which was mounted on the top of a variable-height antenna tower.
- c. The height of antenna is varied from one meter to four meters above the ground to determine the maximum value of the field strength. Both horizontal and vertical polarizations of the antenna are set to make the measurement.
- d. For each suspected emission, the EUT was arranged to its worst case and then the antenna was tuned to heights from 1 meter to 4 meters and the rotatable table was turned from 0 degrees to 360 degrees to find the maximum reading.
- e. The test-receiver system was set to quasi-peak detect function and specified bandwidth with maximum hold mode when the test frequency is below 1 GHz.
- f. The test-receiver system was set to peak and average detects function and specified bandwidth with maximum hold mode when the test frequency is above 1 GHz. If the peak reading value also meets average limit, measurement with the average detector is unnecessary.

##### **Note:**

1. The resolution bandwidth and video bandwidth of test receiver/spectrum analyzer is 120kHz for Quasi-peak detection (QP) at frequency below 1GHz.
2. The resolution bandwidth of test receiver/spectrum analyzer is 1 MHz and the video bandwidth is 3 MHz for Peak detection (PK) at frequency above 1GHz.
3. The resolution bandwidth of test receiver/spectrum analyzer is 1MHz and the video bandwidth is  $\geq 1/T$  (Duty cycle < 98%) or 10Hz (Duty cycle  $\geq 98\%$ ) for Average detection (AV) at frequency above 1GHz.
4. All modes of operation were investigated and the worst-case emissions are reported.

#### 4.1.4 Deviation from Test Standard

No deviation.

#### 4.1.5 Test Setup

##### For Radiated emission below 30MHz

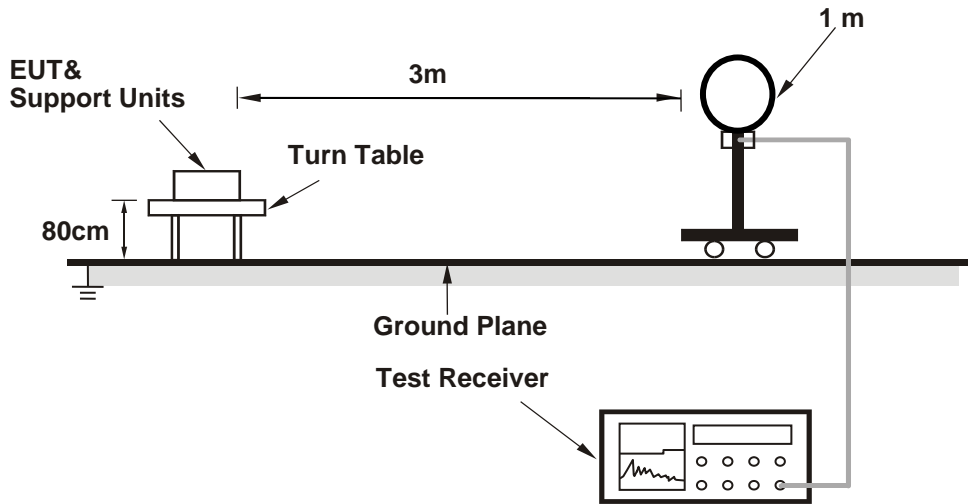

##### For Radiated emission 30MHz to 1GHz

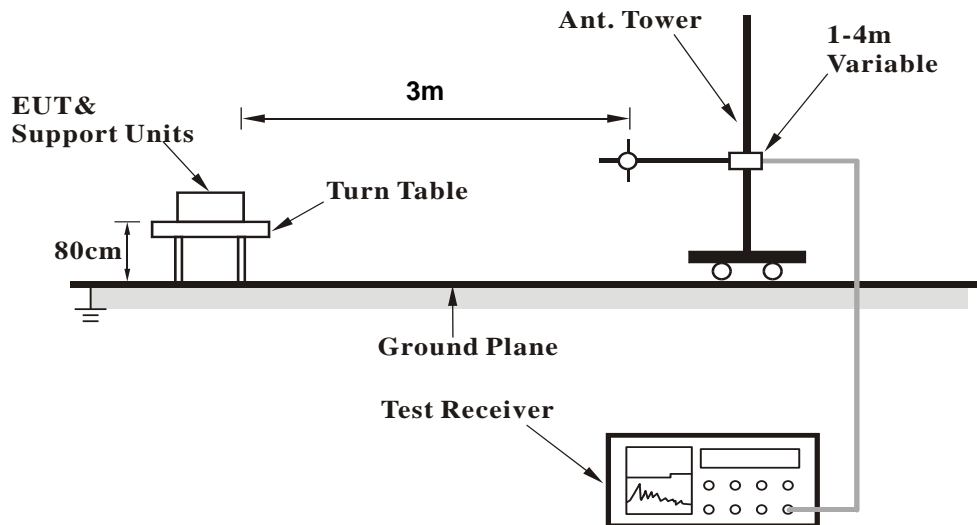

### For Radiated emission above 1GHz

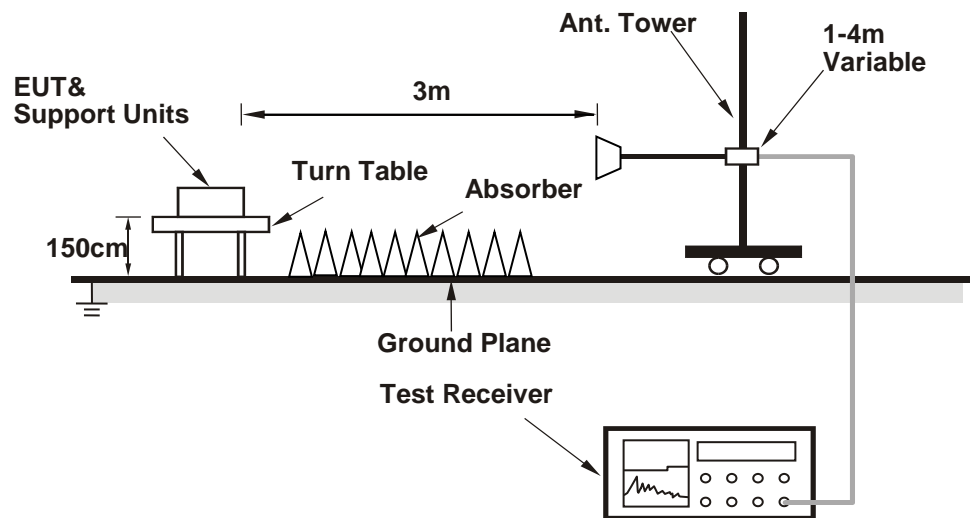

For the actual test configuration, please refer to the attached file (Test Setup Photo).

#### 4.1.6 EUT Operating Conditions

- Placed the EUT on the testing table.
- Controlling software (RF\_BLE.txt) has been activated to set the EUT under transmission condition continuously.

4.1.7 Test Results

Above 1GHz Data:

<b>RF Mode</b>	TX BT_LE-1M	<b>Channel</b>	CH 0 : 2402 MHz
<b>Frequency Range</b>	1GHz ~ 25GHz	<b>Detector Function</b>	Peak (PK) Average (AV)

Antenna Polarity & Test Distance : Horizontal at 3 m								
No	Frequency (MHz)	Emission Level (dBuV/m)	Limit (dBuV/m)	Margin (dB)	Antenna Height (m)	Table Angle (Degree)	Raw Value (dBuV)	Correction Factor (dB/m)
1	2390.00	54.8 PK	74.0	-19.2	1.05 H	108	59.1	-4.3
2	2390.00	42.1 AV	54.0	-11.9	1.05 H	108	46.4	-4.3
3	*2402.00	98.1 PK			1.05 H	108	102.4	-4.3
4	*2402.00	96.8 AV			1.05 H	108	101.1	-4.3
5	4804.00	43.2 PK	74.0	-30.8	1.51 H	86	42.8	0.4
6	4804.00	32.1 AV	54.0	-21.9	1.51 H	86	31.7	0.4

Antenna Polarity & Test Distance : Vertical at 3 m								
No	Frequency (MHz)	Emission Level (dBuV/m)	Limit (dBuV/m)	Margin (dB)	Antenna Height (m)	Table Angle (Degree)	Raw Value (dBuV)	Correction Factor (dB/m)
1	2390.00	54.1 PK	74.0	-19.9	2.84 V	339	58.4	-4.3
2	2390.00	42.3 AV	54.0	-11.7	2.84 V	339	46.6	-4.3
3	*2402.00	94.0 PK			2.84 V	339	98.3	-4.3
4	*2402.00	92.5 AV			2.84 V	339	96.8	-4.3
5	4804.00	42.0 PK	74.0	-32.0	1.22 V	330	41.6	0.4
6	4804.00	33.1 AV	54.0	-20.9	1.22 V	330	32.7	0.4

Remarks:

1. Emission Level(dBuV/m) = Raw Value(dBuV) + Correction Factor(dB/m)
2. Correction Factor(dB/m) = Antenna Factor(dB/m) + Cable Factor(dB) – Pre-Amplifier Factor(dB)
3. Margin value = Emission Level – Limit value
4. The other emission levels were very low against the limit.
5. " \* ": Fundamental frequency.

<b>RF Mode</b>	TX BT_LE-1M	<b>Channel</b>	CH 19 : 2440 MHz
<b>Frequency Range</b>	1GHz ~ 25GHz	<b>Detector Function</b>	Peak (PK) Average (AV)

**Antenna Polarity & Test Distance : Horizontal at 3 m**

No	Frequency (MHz)	Emission Level (dBuV/m)	Limit (dBuV/m)	Margin (dB)	Antenna Height (m)	Table Angle (Degree)	Raw Value (dBuV)	Correction Factor (dB/m)
1	*2440.00	96.9 PK			1.16 H	57	101.2	-4.3
2	*2440.00	95.2 AV			1.16 H	57	99.5	-4.3
3	4880.00	43.7 PK	74.0	-30.3	1.53 H	79	43.2	0.5
4	4880.00	32.1 AV	54.0	-21.9	1.53 H	79	31.6	0.5
5	7320.00	44.8 PK	74.0	-29.2	1.74 H	178	38.0	6.8
6	7320.00	33.5 AV	54.0	-20.5	1.74 H	178	26.7	6.8

**Antenna Polarity & Test Distance : Vertical at 3 m**

No	Frequency (MHz)	Emission Level (dBuV/m)	Limit (dBuV/m)	Margin (dB)	Antenna Height (m)	Table Angle (Degree)	Raw Value (dBuV)	Correction Factor (dB/m)
1	*2440.00	91.8 PK			2.89 V	331	96.1	-4.3
2	*2440.00	90.7 AV			2.89 V	331	95.0	-4.3
3	4880.00	41.9 PK	74.0	-32.1	1.14 V	325	41.4	0.5
4	4880.00	32.8 AV	54.0	-21.2	1.14 V	325	32.3	0.5
5	7320.00	43.9 PK	74.0	-30.1	1.50 V	215	37.1	6.8
6	7320.00	32.5 AV	54.0	-21.5	1.50 V	215	25.7	6.8

**Remarks:**

1. Emission Level(dBuV/m) = Raw Value(dBuV) + Correction Factor(dB/m)
2. Correction Factor(dB/m) = Antenna Factor(dB/m) + Cable Factor(dB) – Pre-Amplifier Factor(dB)
3. Margin value = Emission Level – Limit value
4. The other emission levels were very low against the limit.
5. " \* ": Fundamental frequency.

<b>RF Mode</b>	TX BT_LE-1M	<b>Channel</b>	CH 39 : 2480 MHz
<b>Frequency Range</b>	1GHz ~ 25GHz	<b>Detector Function</b>	Peak (PK) Average (AV)

Antenna Polarity & Test Distance : Horizontal at 3 m								
No	Frequency (MHz)	Emission Level (dBuV/m)	Limit (dBuV/m)	Margin (dB)	Antenna Height (m)	Table Angle (Degree)	Raw Value (dBuV)	Correction Factor (dB/m)
1	*2480.00	94.9 PK			1.28 H	111	99.3	-4.4
2	*2480.00	93.5 AV			1.28 H	111	97.9	-4.4
3	2483.50	58.0 PK	74.0	-16.0	1.28 H	111	62.4	-4.4
4	2483.50	41.9 AV	54.0	-12.1	1.28 H	111	46.3	-4.4
5	4960.00	42.7 PK	74.0	-31.3	1.59 H	78	41.8	0.9
6	4960.00	31.9 AV	54.0	-22.1	1.59 H	78	31.0	0.9
7	7440.00	44.0 PK	74.0	-30.0	1.80 H	160	36.7	7.3
8	7440.00	33.0 AV	54.0	-21.0	1.80 H	160	25.7	7.3

Antenna Polarity & Test Distance : Vertical at 3 m								
No	Frequency (MHz)	Emission Level (dBuV/m)	Limit (dBuV/m)	Margin (dB)	Antenna Height (m)	Table Angle (Degree)	Raw Value (dBuV)	Correction Factor (dB/m)
1	*2480.00	91.0 PK			2.92 V	359	95.4	-4.4
2	*2480.00	89.7 AV			2.92 V	359	94.1	-4.4
3	2483.50	53.7 PK	74.0	-20.3	2.92 V	359	58.1	-4.4
4	2483.50	41.8 AV	54.0	-12.2	2.92 V	359	46.2	-4.4
5	4960.00	41.9 PK	74.0	-32.1	1.14 V	335	41.0	0.9
6	4960.00	32.9 AV	54.0	-21.1	1.14 V	335	32.0	0.9
7	7440.00	44.0 PK	74.0	-30.0	1.48 V	257	36.7	7.3
8	7440.00	33.2 AV	54.0	-20.8	1.48 V	257	25.9	7.3

**Remarks:**

1. Emission Level(dBuV/m) = Raw Value(dBuV) + Correction Factor(dB/m)
2. Correction Factor(dB/m) = Antenna Factor(dB/m) + Cable Factor(dB) – Pre-Amplifier Factor(dB)
3. Margin value = Emission Level – Limit value
4. The other emission levels were very low against the limit.
5. " \* ": Fundamental frequency.

### Below 1GHz Data:

RF Mode	TX BT_LE-1M	Channel	CH 0 : 2402 MHz
Frequency Range	9kHz ~ 1GHz	Detector Function	Quasi-Peak (QP)

Antenna Polarity & Test Distance : Horizontal at 3 m								
No	Frequency (MHz)	Emission Level (dBuV/m)	Limit (dBuV/m)	Margin (dB)	Antenna Height (m)	Table Angle (Degree)	Raw Value (dBuV)	Correction Factor (dB/m)
1	30.99	25.3 QP	40.0	-14.7	1.00 H	95	39.1	-13.8
2	108.85	25.7 QP	43.5	-17.8	2.00 H	274	40.9	-15.2
3	149.68	28.7 QP	43.5	-14.8	1.00 H	68	40.6	-11.9
4	210.94	25.6 QP	43.5	-17.9	1.00 H	350	40.7	-15.1
5	289.68	26.1 QP	46.0	-19.9	2.00 H	359	37.2	-11.1
6	464.37	27.6 QP	46.0	-18.4	1.50 H	15	33.4	-5.8

### Remarks:

1. Emission Level(dBuV/m) = Raw Value(dBuV) + Correction Factor(dB/m)
2. Correction Factor(dB/m) = Antenna Factor(dB/m) + Cable Factor(dB) – Pre-Amplifier Factor(dB)
3. Margin value = Emission Level – Limit value
4. The other emission levels were very low against the limit of frequency range 30MHz~1000MHz.
5. The emission levels were very low against the limit of frequency range 9kHz~30MHz: the amplitude of spurious emissions attenuated more than 20 dB below the permissible value to be report.

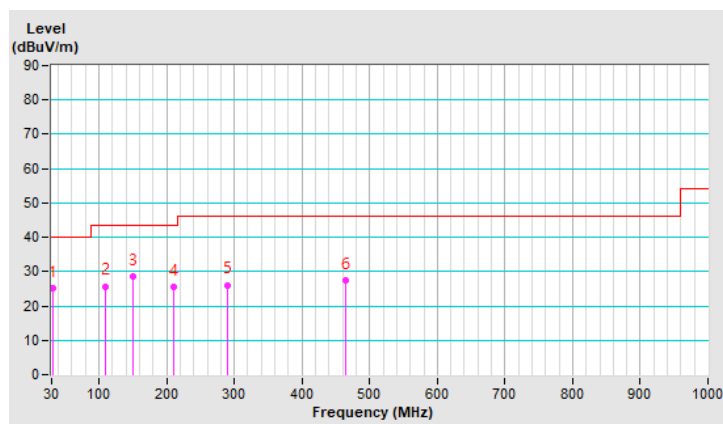

RF Mode	TX BT_LE-1M	Channel	CH 0 : 2402 MHz
Frequency Range	9kHz ~ 1GHz	Detector Function	Quasi-Peak (QP)

**Antenna Polarity & Test Distance : Vertical at 3 m**

No	Frequency (MHz)	Emission Level (dBuV/m)	Limit (dBuV/m)	Margin (dB)	Antenna Height (m)	Table Angle (Degree)	Raw Value (dBuV)	Correction Factor (dB/m)
1	34.03	33.6 QP	40.0	-6.4	1.50 V	117	46.9	-13.3
2	73.52	31.3 QP	40.0	-8.7	1.00 V	346	47.1	-15.8
3	148.98	28.6 QP	43.5	-14.9	2.00 V	267	40.6	-12.0
4	210.02	27.1 QP	43.5	-16.4	2.00 V	26	42.2	-15.1
5	326.92	25.4 QP	46.0	-20.6	1.00 V	202	35.3	-9.9
6	520.56	27.3 QP	46.0	-18.7	1.00 V	343	31.7	-4.4

**Remarks:**

1. Emission Level(dBuV/m) = Raw Value(dBuV) + Correction Factor(dB/m)
2. Correction Factor(dB/m) = Antenna Factor(dB/m) + Cable Factor(dB) – Pre-Amplifier Factor(dB)
3. Margin value = Emission Level – Limit value
4. The other emission levels were very low against the limit of frequency range 30MHz~1000MHz.
5. The emission levels were very low against the limit of frequency range 9kHz~30MHz: the amplitude of spurious emissions attenuated more than 20 dB below the permissible value to be report.

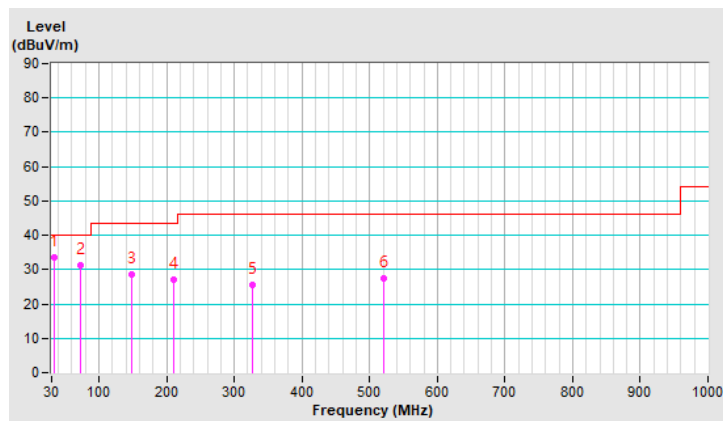



## 4.2 Conducted Emission Measurement

### 4.2.1 Limits of Conducted Emission Measurement

Frequency (MHz)	Conducted Limit (dBuV)	
	Quasi-peak	Average
0.15 - 0.5	66 - 56	56 - 46
0.50 - 5.0	56	46
5.0 - 30.0	60	50

Note: 1. The lower limit shall apply at the transition frequencies.

2. The limit decreases in line with the logarithm of the frequency in the range of 0.15 to 0.50MHz.

### 4.2.2 Test Instruments

DESCRIPTION & MANUFACTURER	MODEL NO.	SERIAL NO.	CALIBRATED DATE	CALIBRATED UNTIL
Test Receiver R&S	ESCS 30	847124/029	Oct. 20, 2020	Oct. 19, 2021
Line-Impedance Stabilization Network (for EUT) R&S	ESH3-Z5	848773/004	Oct. 27, 2020	Oct. 26, 2021
Line-Impedance Stabilization Network (for Peripheral) R&S	ESH3-Z5	835239/001	Mar. 26, 2021	Mar. 25, 2022
50 ohms Terminator	50	3	Oct. 26, 2020	Oct. 25, 2021
RF Cable	5D-FB	COCCAB-001	Sep. 26, 2020	Sep. 25, 2021
Fixed attenuator EMCI	STI02-2200-10	005	Aug. 29, 2020	Aug. 28, 2021
Software BVADT	BVADT_Cond_ V7.3.7.4	NA	NA	NA

**Note:**

1. The calibration interval of the above test instruments are 12 months and the calibrations are traceable to NML/ROC and NIST/USA.
2. The test was performed in Conduction 1.
3. Tested Date: July 30, 2021

#### 4.2.3 Test Procedures

- The EUT was placed 0.4 meters from the conducting wall of the shielded room with EUT being connected to the power mains through a line impedance stabilization network (LISN). Other support units were connected to the power mains through another LISN. The two LISNs provide 50 ohm/ 50uH of coupling impedance for the measuring instrument.
- Both lines of the power mains connected to the EUT were checked for maximum conducted interference.
- The frequency range from 150kHz to 30MHz was searched. Emission levels under (Limit - 20dB) was not recorded.

**Note:** The resolution bandwidth and video bandwidth of test receiver is 9kHz for quasi-peak detection (QP) and average detection (AV) at frequency 0.15MHz-30MHz.

#### 4.2.4 Deviation from Test Standard

No deviation.

#### 4.2.5 Test Setup

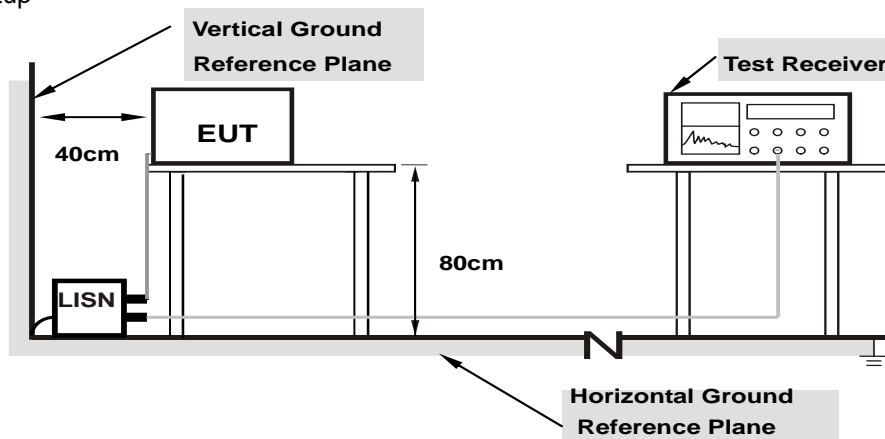

**Note:** 1.Support units were connected to second LISN.

For the actual test configuration, please refer to the attached file (Test Setup Photo).

#### 4.2.6 EUT Operating Conditions

Same as 4.1.6.

#### 4.2.7 Test Results

<b>RF Mode</b>	TX BT_LE-1M	<b>Channel</b>	CH 0 : 2402 MHz
<b>Frequency Range</b>	150kHz ~ 30MHz	<b>Detector Function &amp; Resolution Bandwidth</b>	Quasi-Peak (QP) / Average (AV), 9kHz

Phase Of Power : Line (L)										
No	Frequency (MHz)	Correction Factor (dB)	Reading Value (dBuV)		Emission Level (dBuV)		Limit (dBuV)		Margin (dB)	
			Q.P.	AV.	Q.P.	AV.	Q.P.	AV.	Q.P.	AV.
1	0.15000	9.97	34.46	17.58	44.43	27.55	66.00	56.00	-21.57	-28.45
2	0.24766	10.01	29.58	13.16	39.59	23.17	61.84	51.84	-22.25	-28.67
<b>3</b>	<b>0.36094</b>	<b>10.02</b>	<b>27.62</b>	<b>13.36</b>	<b>37.64</b>	<b>23.38</b>	<b>58.71</b>	<b>48.71</b>	<b>-21.07</b>	<b>-25.33</b>
4	0.45469	10.03	25.22	15.55	35.25	25.58	56.79	46.79	-21.54	-21.21
5	2.15234	10.13	8.09	2.10	18.22	12.23	56.00	46.00	-37.78	-33.77
6	11.59766	10.82	11.08	1.75	21.90	12.57	60.00	50.00	-38.10	-37.43

#### Remarks:

1. Q.P. and AV. are abbreviations of quasi-peak and average individually.
2. The emission levels of other frequencies were very low against the limit.
3. Margin value = Emission level – Limit value
4. Correction factor = Insertion loss + Cable loss
5. Emission Level = Correction Factor + Reading Value

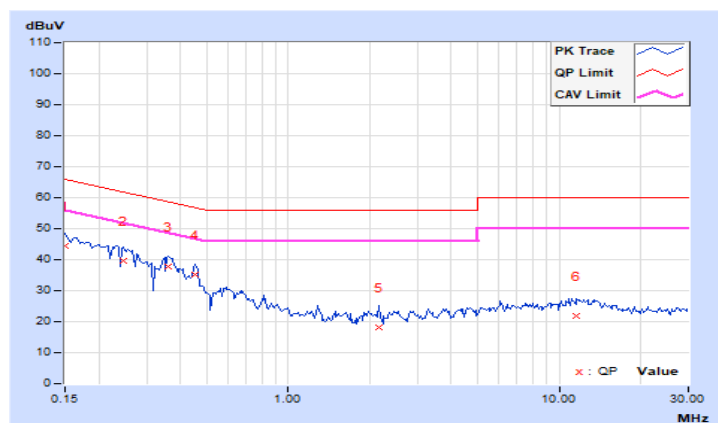

<b>RF Mode</b>	TX BT_LE-1M	<b>Channel</b>	CH 0 : 2402 MHz
<b>Frequency Range</b>	150kHz ~ 30MHz	<b>Detector Function &amp; Resolution Bandwidth</b>	Quasi-Peak (QP) / Average (AV), 9kHz

Phase Of Power : Neutral (N)										
No	Frequency (MHz)	Correction Factor (dB)	Reading Value (dBuV)		Emission Level (dBuV)		Limit (dBuV)		Margin (dB)	
			Q.P.	AV.	Q.P.	AV.	Q.P.	AV.	Q.P.	AV.
1	0.15000	9.95	34.84	17.02	44.79	26.97	66.00	56.00	-21.21	-29.03
2	0.23984	10.00	29.78	12.47	39.78	22.47	62.10	52.10	-22.32	-29.63
3	0.36484	10.02	25.78	9.60	35.80	19.62	58.62	48.62	-22.82	-29.00
4	0.45469	10.02	24.61	11.43	34.63	21.45	56.79	46.79	-22.16	-25.34
5	2.16406	10.14	10.69	-2.08	20.83	8.06	56.00	46.00	-35.17	-37.94
6	12.06641	10.72	12.64	-1.43	23.36	9.29	60.00	50.00	-36.64	-40.71

**Remarks:**

1. Q.P. and AV. are abbreviations of quasi-peak and average individually.
2. The emission levels of other frequencies were very low against the limit.
3. Margin value = Emission level – Limit value
4. Correction factor = Insertion loss + Cable loss
5. Emission Level = Correction Factor + Reading Value

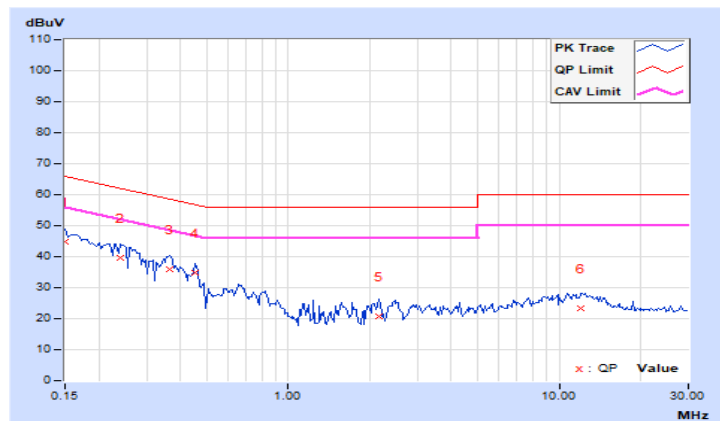

### 4.3 Conducted Output Power Measurement

#### 4.3.1 Limits of Conducted Output Power Measurement

For systems using digital modulation in the 2400–2483.5 MHz bands: 1 Watt (30dBm)

#### 4.3.2 Test Setup

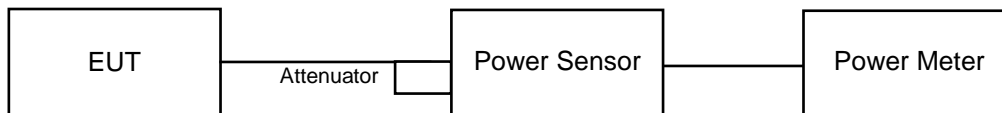

#### 4.3.3 Test Instruments

Refer to section 4.1.2 to get information of above instrument.

#### 4.3.4 Test Procedures

A peak power sensor was used on the output port of the EUT. A power meter was used to read the response of the peak power sensor. Record the power level.

Average power sensor was used to perform output power measurement, trigger and gating function of wide band power meter is enabled to measure max output power of TX on burst. Duty factor is not added to measured value.

#### 4.3.5 Deviation from Test Standard

No deviation.

#### 4.3.6 EUT Operating Conditions

Same as 4.1.6.

#### 4.3.7 Test Results

##### FOR PEAK POWER

Channel	Frequency (MHz)	Peak Power (mW)	Peak Power (dBm)	Limit (dBm)	Pass/Fail
0	2402	2.904	4.63	30	Pass
19	2440	2.831	4.52	30	Pass
39	2480	2.767	4.42	30	Pass

##### FOR AVERAGE POWER

Channel	Frequency (MHz)	Average Power (mW)	Average Power (dBm)
0	2402	2.877	4.59
19	2440	2.805	4.48
39	2480	2.742	4.38

## 5 Pictures of Test Arrangements

Please refer to the attached file (Test Setup Photo).

### Annex A - Band-Edge Measurement

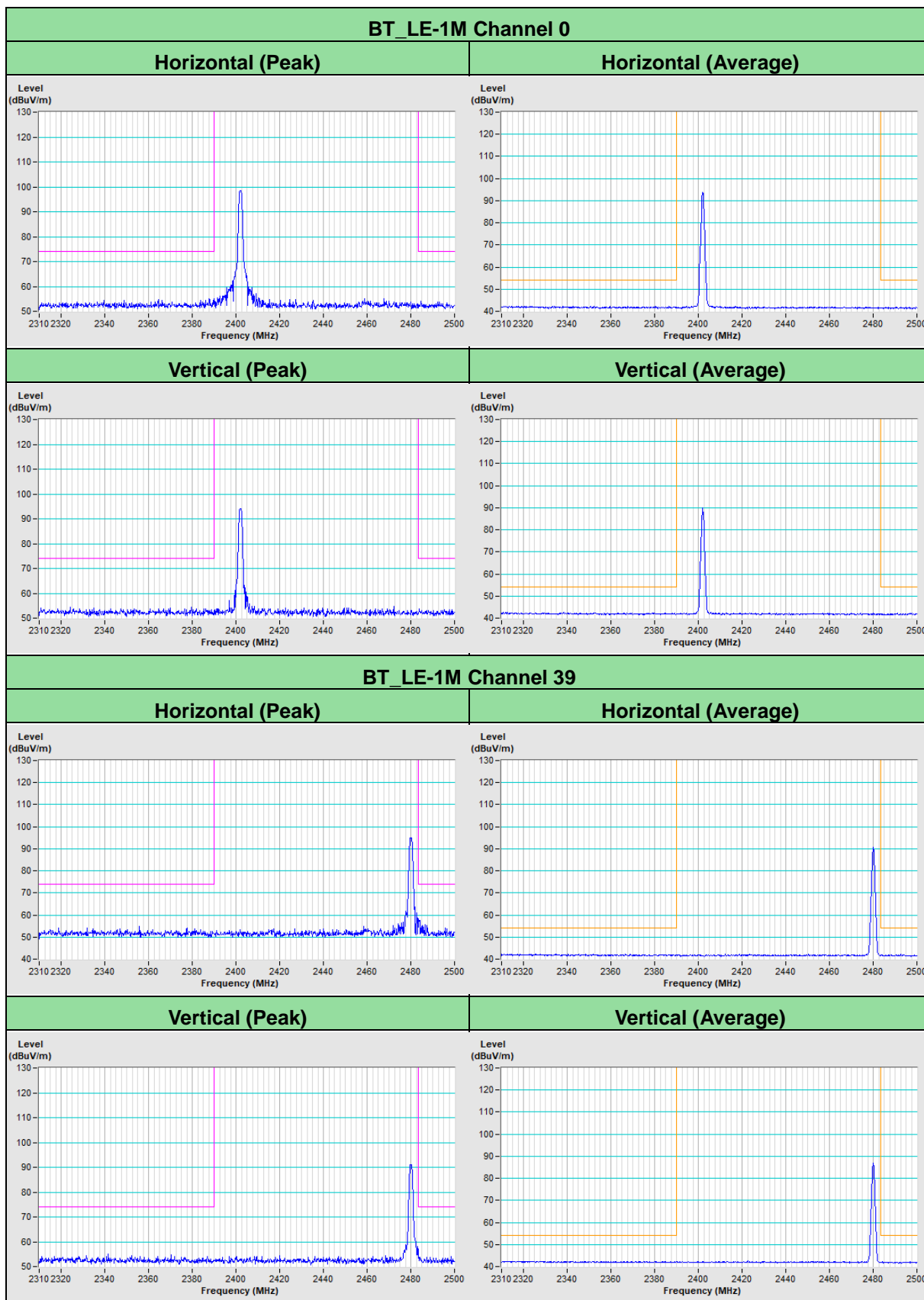



## Appendix – Information of the Testing Laboratories

We, Bureau Veritas Consumer Products Services (H.K.) Ltd., Taoyuan Branch, were founded in 1988 to provide our best service in EMC, Radio, Telecom and Safety consultation. Our laboratories are FCC recognized accredited test firms and accredited according to ISO/IEC 17025.

If you have any comments, please feel free to contact us at the following:

**Lin Kou EMC/RF Lab**

Tel: 886-2-26052180

Fax: 886-2-26051924

**Hsin Chu EMC/RF/Telecom Lab**

Tel: 886-3-6668565

Fax: 886-3-6668323

**Hwa Ya EMC/RF/Safety Lab**

Tel: 886-3-3183232

Fax: 886-3-3270892

**Email:** [service.adt@tw.bureauveritas.com](mailto:service.adt@tw.bureauveritas.com)

**Web Site:** [www.bureauveritas-adt.com](http://www.bureauveritas-adt.com)

The address and road map of all our labs can be found in our web site also.

--- END ---