

FCC DFS Test Report

FCC ID : 2AEUPBHASC052
Equipment : Stick Up Cam Elite
Brand Name : Ring LLC
Model Name : Stick Up Cam Elite
Applicant : Ring LLC
12515 Cerise Ave Hawthorne, CA 90250,
USA
Manufacturer : Chicony Electronics Co.,Ltd.
No.69, Sec. 2, Guangfu Rd., Sanchong
Dist. New Taipei City 241 Taiwan
Standard : 47 CFR FCC Part 15.407

The product was received on Oct. 17, 2019, and testing was started from Oct. 29, 2019 and completed on Oct. 29, 2019. We, SPORTON INTERNATIONAL INC. Hsinhua Laboratory, would like to declare that the tested sample has been evaluated in accordance with the procedures given in KDB 905462 D02 UNII DFS Compliance Procedures New Rules v02 and shown compliance with the applicable technical standards.

The test results in this report apply exclusively to the tested model / sample. Without written approval of SPORTON INTERNATIONAL INC. Hsinhua Laboratory, the test report shall not be reproduced except in full.



Approved by: Jackson Tsai

SPORTON INTERNATIONAL INC. Hsinhua Laboratory

No.52, Huaya 1st Rd., Guishan Dist., Taoyuan City 333411, Taiwan (R.O.C.)



Table of Contents

HISTORY OF THIS TEST REPORT3

SUMMARY OF TEST RESULT4

1 GENERAL DESCRIPTION5

1.1 Information.....5

1.2 Testing Applied Standards8

1.3 Testing Location Information8

2 TEST CONFIGURATION OF EUT.....9

2.1 Test Channel Frequencies Configuration.....9

2.2 The Worst Case Measurement Configuration.....9

2.3 Accessories9

2.4 Support Equipment.....10

3 DYNAMIC FREQUENCY SELECTION (DFS) TEST RESULT11

3.1 General DFS Information11

3.2 Radar Test Waveform Calibration14

3.3 In-service Monitoring21

4 TEST EQUIPMENT AND CALIBRATION DATA.....26

5 MEASUREMENT UNCERTAINTY27

Appendix A. Test Photos

Photographs of EUT V01



Summary of Test Result

| Report Clause | Ref. Std. Clause | Test Items | Result (PASS/FAIL) | Remark |
|---------------|------------------|---|--------------------|------------------------------------|
| 3.3 | KDB 905462 7.8.3 | DFS: In-Service Monitoring for Channel Move Time (CMT) | PASS | CMT ≤ 10sec |
| 3.3 | KDB 905462 7.8.3 | DFS: In-Service Monitoring for Channel Closing Transmission Time (CCTT) | PASS | CCTT ≤ 60 ms starting at CMT 200ms |
| 3.3 | KDB 905462 7.8.3 | DFS: In-Service Monitoring for Non-Occupancy Period (NOP) | PASS | NOP ≥ 30 min |

Note: Since the product is client without radar detection function, only Channel Move Time, Channel Closing Transmission Time and Non-Occupancy Period are required to perform.

| |
|--|
| Declaration of Conformity: |
| The test results with all measurement uncertainty excluded are presented in accordance with the regulation limits or requirements declared by manufacturers. |
| Comments and explanations: |
| According to the manufacturer's declaration of product application, the RF Function and FW are same as FCC ID: 2AEUPBHASC051. Therefore the test data could leverage as FCC ID: 2AEUPBHASC052. |

Reviewed by: Ben Tseng
Report Producer: Debby Hung



1 General Description

1.1 Information

1.1.1 RF General Information

| Specification Items | Description |
|--|---|
| Product Type | WLAN (1TX, 1RX) |
| Radio Type | Intentional Transceiver |
| Power Type | From Battery / Transformer |
| Modulation | IEEE 802.11a: OFDM (BPSK / QPSK / 16QAM / 64QAM) IEEE 802.11n: see the below table |
| Data Rate (Mbps) | IEEE 802.11a: OFDM (6/9/12/18/24/36/48/54) IEEE 802.11n: see the below table |
| Channel Bandwidth | 20/40 MHz operating channel bandwidth |
| Operating Mode | <input type="checkbox"/> Master |
| | <input type="checkbox"/> Client with radar detection |
| | <input checked="" type="checkbox"/> Client without radar detection |
| Communication Mode | <input checked="" type="checkbox"/> IP Based (Load Based) <input type="checkbox"/> Frame Based |
| TPC Function | <input type="checkbox"/> With TPC <input checked="" type="checkbox"/> Without TPC |
| Weather Band (5600~5650MHz) | <input checked="" type="checkbox"/> With 5600~5650MHz <input type="checkbox"/> Without 5600~5650MHz |
| Software / Firmware Version | 6.53.15 |
| Note: TPC is not required since the maximum EIRP is less than 500mW (27dBm). | |

| Type of EUT | |
|-------------------------------------|---|
| <input checked="" type="checkbox"/> | Stand-alone |
| <input type="checkbox"/> | Combined (EUT where the radio part is fully integrated within another device) |
| | Combined Equipment - Brand Name / Model No.: ... |
| <input type="checkbox"/> | Plug-in radio (EUT intended for a variety of host systems) |
| | Host System - Brand Name / Model No.: |
| <input type="checkbox"/> | Other: |



Antenna & Bandwidth

| Antenna | One (TX) | | |
|-----------------|----------|--------|--------|
| | 20 MHz | 40 MHz | 80 MHz |
| Band width Mode | | | |
| IEEE 802.11a | V | X | X |
| IEEE 802.11n | V | V | X |

IEEE 11n Spec.

| Protocol | Number of Transmit Chains (NTX) | Data Rate / MCS |
|----------------|---------------------------------|-----------------|
| 802.11n (HT20) | 1 | MCS 0-7 |
| 802.11n (HT40) | 1 | MCS 0-7 |

Note 1: IEEE Std. 802.11n modulation consists of HT20 and HT40 (HT: High Throughput). Then EUT support HT20 and HT40.
Note 2: HT20 and HT40 use a combination of OFDM-BPSK, QPSK, 16QAM, 64QAM modulation.
Note 3: Modulation modes consist of below configuration:
11a: IEEE 802.11a, HT20/HT40: IEEE 802.11n.



1.1.2 Antenna Information

| Ant. | Port | Brand | Model Name | Antenna Type | Connector |
|------|------|-------|--------------------|--------------|----------------|
| 1 | 1 | - | Orion Wifi Antenna | PIFA Antenna | Fixed on board |

| 5G | |
|-----------------|------------|
| Frequency (MHz) | Gain (dBi) |
| 5250 | 2.85 |
| 5350 | 2.96 |
| 5470 | 3.08 |
| 5600 | 3.26 |
| 5725 | 2.96 |

For 5 GHz function:

For IEEE 802.11a/n mode (1TX/1RX)

Only Ant. 1 (port 1) can be used as transmitting/receiving antenna.

1.1.3 DFS Band Carrier Frequencies

There are three bandwidth systems.

For 20MHz bandwidth systems, use Channel 52, 56, 60, 64, 100, 104, 108, 112, 116, 120, 124, 128, 132, 136, 140.

For 40MHz bandwidth systems, use Channel 54, 62, 102, 110, 118, 126, 134.

| Frequency Band | Channel No. | Frequency | Channel No. | Frequency |
|---------------------------|-------------|-----------|-------------|-----------|
| 5250~5350 MHz U-NII-2A | 52 | 5260 MHz | 60 | 5300 MHz |
| | 54 | 5270 MHz | 62 | 5310 MHz |
| | 56 | 5280 MHz | 64 | 5320 MHz |
| 5470~5725 MHz U-NII-2C | 100 | 5500 MHz | 120 | 5600 MHz |
| | 102 | 5510 MHz | 124 | 5620 MHz |
| | 104 | 5520 MHz | 126 | 5630 MHz |
| | 108 | 5540 MHz | 128 | 5640 MHz |
| | 110 | 5550 MHz | 132 | 5660 MHz |
| | 112 | 5560 MHz | 134 | 5670 MHz |
| | 116 | 5580 MHz | 136 | 5680 MHz |
| | 118 | 5590 MHz | 140 | 5700 MHz |

1.2 Testing Applied Standards

According to the specifications of the manufacturer, the EUT must comply with the requirements of the following standards:

- ◆ KDB 905462 D02 UNII DFS Compliance Procedures New Rules v02

The following reference test guidance is not within the scope of accreditation of TAF:

- ◆ KDB 905462 D03 Client Without DFS New Rules v01r02

1.3 Testing Location Information

| Test Lab. : Sporton International Inc. Hsinhua Laboratory | | | | |
|--|------------------------|--|--------------------------|-------------|
| <input checked="" type="checkbox"/> | Hsinhua (TAF: 3785) | ADD: No.52, Huaya 1st Rd., Guishan Dist., Taoyuan City 333411, Taiwan (R.O.C.) | | |
| | | TEL: 886-3-327-3456 | FAX: 886-3-327-0973 | |
| Test site Designation No. TW3785 with FCC. | | | | |
| Test Condition | Test Site No. | Test Engineer | Test Environment | Test Date |
| DFS | DFS01-HY | Peng Huang | 25.2~25.4°C / 61.2~61.5% | 29/Oct/2019 |

Laboratory number TAF 3785 is a spin-off from the original Laboratory number TAF 1190.

2 Test Configuration of EUT

2.1 Test Channel Frequencies Configuration

| Test Channel Frequencies Configuration | |
|--|--------------------------|
| IEEE Std. | Test Channel Freq. (MHz) |
| 802.11n (HT40) | 5510 MHz |

2.2 The Worst Case Measurement Configuration

| The Worst Case Mode for Following Conformance Tests | |
|---|--|
| Tests Item | Dynamic Frequency Selection (DFS) |
| Test Condition | Conducted measurement at transmit chains The EUT shall be configured to operate at the highest transmitter output power setting. If more than one antenna assembly is intended for this power setting, the gain of the antenna assembly with the lowest gain shall be used. |
| Modulation Mode | 802.11n (HT40) |

2.3 Accessories

| Accessories | | | | |
|--------------------|---------------|---|------------|-------------------------|
| Indoor Adapter | Brand Name | DEE VAN ENTERPRISE | Model Name | DSA-15CAB-05 050250 |
| | Power Rating | I/P: <u>100</u> - <u>240</u> Vac, <u>0.5</u> A, O/P: <u>5</u> Vdc, <u>2.5</u> A | | |
| Outdoor Adapter | Brand Name | ring | Model Name | DSA-15PFL-05 FUS 050250 |
| | Power Rating | I/P: 100-240V ~ 0.5A MAX 50-60Hz; O/P: 5V 2.5A | | |
| | DC Power Cord | 2.45 meter, non-shielded cable, w/o ferrite core | | |
| | AC Power Cord | 4.53 meter, non-shielded cable, w/o ferrite core | | |
| PoE Adapter 1 | Brand Name | Phihong | Model Name | POE15M |
| | Power Rating | I/P: 100 - 240Vac, 0.8 A, O/P: 56 Vdc, 0.275 A | | |
| PoE Adapter 2 | Brand Name | ONV | Model Name | PSE3010DCG |
| | Power Rating | I/P: 100 - 240Vac, 0.8 A, O/P: 5 Vdc, 2.5A | | |
| Adapter 2 | Brand Name | ZTE | Model Name | RJ-AS120150U104-B |
| | Power Rating | I/P: 100 - 240Vac, 1 A, O/P: 12Vdc, 1.5A | | |
| USB Cable | Power Rating | 2.45 meter, non-shielded cable, w/o ferrite core | | |
| 6ft Ethernet Cable | Power Rating | 1.8 meter, non-shielded cable, w/o ferrite core | | |

Reminder: Regarding to more detail and other information, please refer to user manual.



2.4 Support Equipment

| Support Equipment | | | |
|-------------------|----------------|------------|----------------|
| No. | Equipment | Brand Name | Model Name |
| 1 | AP (Master) | EDIMAX | EW-7979WAC |
| 2 | NoteBook | DELL | Latitude E5550 |
| 3 | Adapter for NB | DELL | FA90PSO-00 |
| 4 | NoteBook | DELL | Latitude E5540 |
| 5 | Adapter for NB | DELL | FA90PSO-00 |

3 Dynamic Frequency Selection (DFS) Test Result

3.1 General DFS Information

3.1.1 DFS Parameters

| Table D.1: DFS requirement values | |
|-----------------------------------|---|
| Parameter | Value |
| Non-occupancy period | Minimum 30 minutes |
| Channel Availability Check Time | 60 seconds |
| Channel Move Time | 10 seconds (Note 1). |
| Channel Closing Transmission Time | 200 milliseconds + an aggregate of 60 milliseconds over remaining 10 second periods. (Notes 1 and 2). |
| U-NII Detection Bandwidth | Minimum 100% of the 99% power bandwidth (Note 3). |

Note 1: Channel Move Time and the Channel Closing Transmission Time should be performed with Radar Type 0. The measurement timing begins at the end of the Radar Type 0 burst.

Note 2: The Channel Closing Transmission Time is comprised of 200 milliseconds starting at the beginning of the Channel Move Time plus any additional intermittent control signals required to facilitate Channel changes (an aggregate of 60 milliseconds) during the remainder of the 10 second period. The aggregate duration of control signals will not count quiet periods in between transmissions.

Note 3: During the U-NII Detection Bandwidth detection test, radar type 0 is used and for each frequency step the minimum percentage of detection is 90%. Measurements are performed with no data traffic.

| Table D.2: Interference threshold values | |
|--|------------------|
| Maximum Transmit Power | Value (see note) |
| EIRP \geq 200 mW | -64 dBm |
| EIRP < 200 mW and PSD < 10dBm/MHz | -62 dBm |
| EIRP < 200 mW and PSD \geq 10dBm/MHz | -64 dBm |

Note 1: This is the level at the input of the receiver assuming a 0 dBi receive antenna.

Note 2: Throughout these test procedures an additional 1 dB has been added to the amplitude of the test transmission waveforms to account for variations in measurement equipment. This will ensure that the test signal is at or above the detection threshold level to trigger a DFS response.

Note3: EIRP is based on the highest antenna gain. For MIMO devices refer to KDB Publication 662911.



3.1.2 Applicability of DFS Requirements Prior to Use of a Channel

| Requirement | DFS Operational mode | | |
|--|----------------------|--------------------------------|-----------------------------|
| | Master | Client without radar detection | Client with radar detection |
| <i>Non-Occupancy Period</i> | Yes | Not required (See the note) | Yes |
| <i>DFS Detection Threshold</i> | Yes | Not required | Yes |
| <i>Channel Availability Check Time</i> | Yes | Not required | Not required |
| <i>U-NII Detection Bandwidth</i> | Yes | Not required | Yes |

Note :

According to KDB 905462 D03 Client Without DFS New Rules v01r02 (b) 6."An analyzer plot that contains a single 30-minute sweep on the original channel "

3.1.3 Applicability of DFS Requirements during Normal Operation

| Requirement | DFS Operational mode | | |
|--|----------------------|--------------------------------|-----------------------------|
| | Master | Client without radar detection | Client with radar detection |
| <i>DFS Detection Threshold</i> | Yes | Not required | Yes |
| <i>Channel Closing Transmission Time</i> | Yes | Yes | Yes |
| <i>Channel Move Time</i> | Yes | Yes | Yes |
| <i>U-NII Detection Bandwidth</i> | Yes | Not required | Yes |

| Additional requirements for devices with multiple bandwidth modes | Master Device or Client with Radar Detection | Client Without Radar Detection |
|---|--|--|
| U-NII Detection Bandwidth and Statistical Performance Check | All BW modes must be tested | Not required |
| Channel Move Time and Channel Closing Transmission Time | Test using widest BW mode available | Test using the widest BW mode available for the link |
| All other tests | Any single BW mode | Not required |

Note: Frequencies selected for statistical performance check (Section 7.8.4) should include several frequencies within the radar detection bandwidth and frequencies near the edge of the radar detection bandwidth. For 802.11 devices it is suggested to select frequencies in each of the bonded 20 MHz channels and the channel center frequency.



3.1.4 Channel Loading/Data Streaming

| | |
|-------------------------------------|--|
| <input type="checkbox"/> | The data file (MPEG-4) has been transmitting in a streaming mode. |
| <input checked="" type="checkbox"/> | Software to ping the client is permitted to simulate data transfer with random ping intervals. |
| <input checked="" type="checkbox"/> | Minimum channel loading of approximately 17%. |
| <input type="checkbox"/> | Unicast protocol has been used. |



3.2 Radar Test Waveform Calibration

3.2.1 Short Pulse Radar Test Waveforms

| Radar Type | Pulse Width (µsec) | PRI (µsec) | Number of Pulses | Minimum Percentage of Successful Detection | Minimum Trials |
|---|--------------------|---|---|--|----------------|
| 0 | 1 | 1428 | 18 | See Note 1 | See Note 1 |
| 1A | 1 | 15 unique PRI in KDB 905462 D02 Table 5a | $\text{Roundup} \left\{ \left(\frac{1}{360} \right) \times \left(\frac{19 \times 10^6}{PRI} \right) \right\}$ | 60% | 15 |
| 1B | 1 | 15 unique PRI within 518-3066, Excluding 1A PRI | | 60% | 15 |
| 2 | 1-5 | 150-230 | 23-29 | 60% | 30 |
| 3 | 6-10 | 200-500 | 16-18 | 60% | 30 |
| 4 | 11-20 | 200-500 | 12-16 | 60% | 30 |
| Aggregate (Radar Types 1-4) | | | | 80% | 120 |
| Note 1: Short Pulse Radar Type 0 should be used for the detection bandwidth test, channel move time, and channel closing time tests. | | | | | |

A minimum of 30 unique waveforms are required for each of the short pulse radar types 1 through 4. If more than 30 waveforms are used for short pulse radar types 1 through 4, then each additional waveform must also be unique and not repeated from the previous waveforms. The aggregate is the average of the percentage of successful detections of short pulse radar types 1-4.

3.2.2 Long Pulse Radar Test Waveform

| Radar Type | Pulse Width (µsec) | Chirp Width (MHz) | PRI (µsec) | Number of Pulses per Burst | Number of Bursts | Minimum Percentage of Successful Detection | Minimum Trials |
|------------|--------------------|-------------------|------------|----------------------------|------------------|--|----------------|
| 5 | 50-100 | 5-20 | 1000-2000 | 1-3 | 8-20 | 80% | 30 |

Each waveform is defined as follows:

- The transmission period for the Long Pulse Radar test signal is 12 seconds.
- There are a total of 8 to 20 Bursts in the 12 second period, with the number of Bursts being randomly chosen. This number is Burst Count.
- Each Burst consists of 1 to 3 pulses, with the number of pulses being randomly chosen. Each Burst within the 12 second sequence may have a different number of pulses.
- The pulse width is between 50 and 100 microseconds, with the pulse width being randomly chosen. Each pulse within a Burst will have the same pulse width. Pulses in different Bursts may have different pulse widths.
- Each pulse has a linear FM chirp between 5 and 20 MHz, with the chirp width being randomly chosen. Each pulse within a transmission period will have the same chirp width. The chirp is centered on the pulse. For example, with a radar frequency of 5300 MHz and a 20 MHz chirped signal, the chirp starts at 5290 MHz and ends at 5310 MHz.

- If more than one pulse is present in a Burst, the time between the pulses will be between 1000 and 2000 microseconds, with the time being randomly chosen. If three pulses are present in a Burst, the time between the first and second pulses is chosen independently of the time between the second and third pulses.
- The 12 second transmission period is divided into even intervals. The number of intervals is equal to Burst Count. Each interval is of length (12,000,000 / Burst Count) microseconds. Each interval contains one Burst. The start time for the Burst, relative to the beginning of the interval, is between 1 and [(12,000,000 / Burst Count) - (Total Burst Length) + (One Random PRI Interval)] microseconds, with the start time being randomly chosen. The step interval for the start time is 1 microsecond. The start time for each Burst is chosen independently.

3.2.3 Frequency Hopping Radar Test Waveform

| Radar Type | Pulse Width (µsec) | PRI (µsec) | Pulses per Hop | Hopping Rate (kHz) | Hopping Sequence Length (ms) | Minimum Percentage of Successful Detection | Minimum Trials |
|------------|--------------------|------------|----------------|--------------------|------------------------------|--|----------------|
| 6 | 1 | 333 | 9 | 0.333 | 300 | 70% | 30 |

The FCC Type 6 waveform uses a static waveform with 100 bursts in the instruments ARB. In addition, the RF list mode is operated with a list containing 100 frequencies from a randomly generated list and it had be ensured that at least one of the random frequencies falls into the UNII Detection Bandwidth of the DUT. Each burst from the waveform file initiates a trigger pulse at the beginning that switches the RF list from one item to the next one.

3.2.4 DFS Threshold Level

| DFS Threshold Level | |
|---|--|
| DFS Threshold level: -63 dBm | <input checked="" type="checkbox"/> at the antenna connector |
| | <input type="checkbox"/> in front of the antenna |
| The Interference Radar Detection Threshold Level is $-64 \text{ dBm} + 0 [\text{dBi}] + 1 \text{ dB} = -63 \text{ dBm}$. That had been taken into account the output power range and antenna gain. | |

3.2.5 Calibration Setup

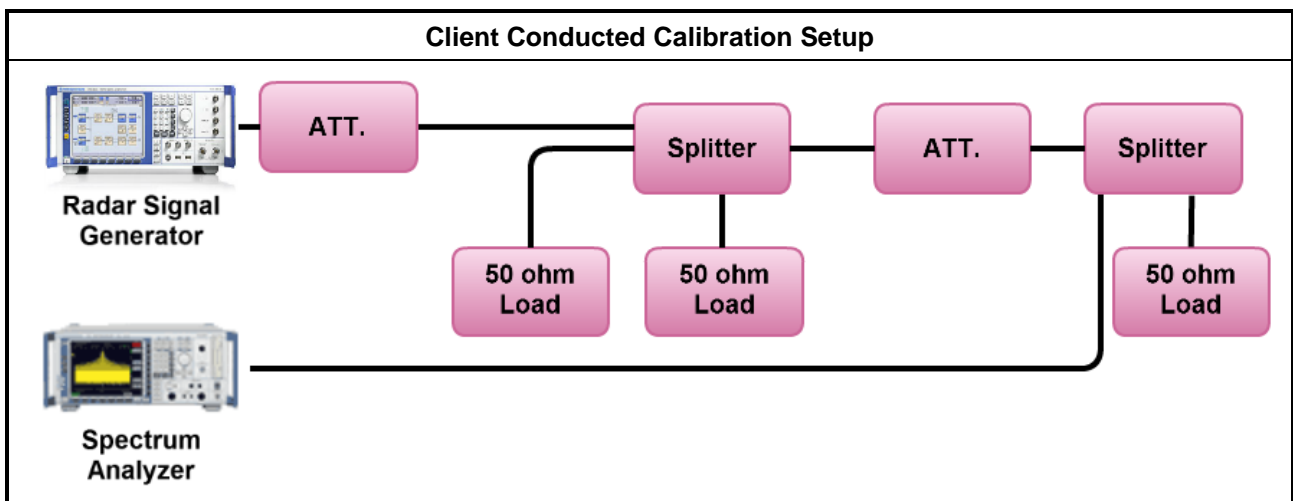



3.2.6 Radar Waveform calibration Plot

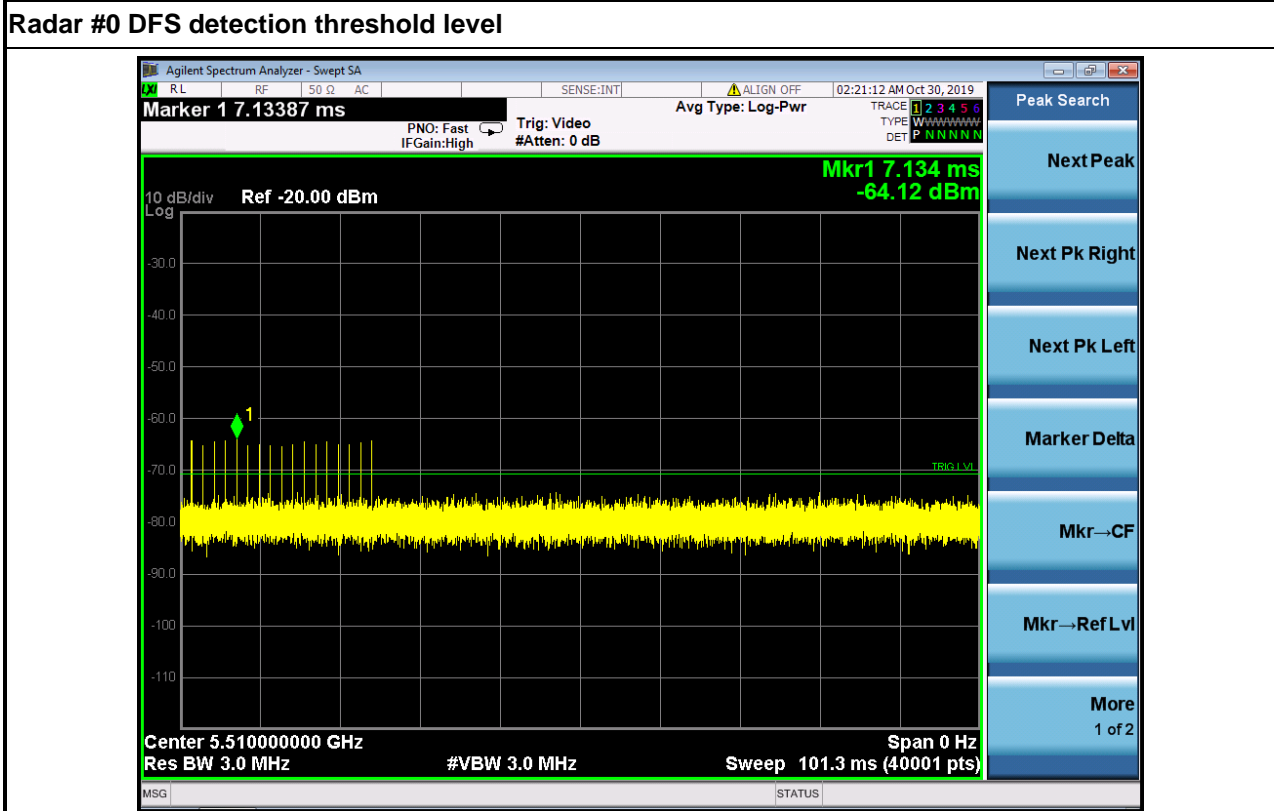

3.2.7 Test Setup

A spectrum analyzer is used as a monitor to verify that the EUT has vacated the Channel within the (Channel Closing Transmission Time and Channel Move Time, and does not transmit on a Channel during the Non-Occupancy Period after the detection and Channel move.

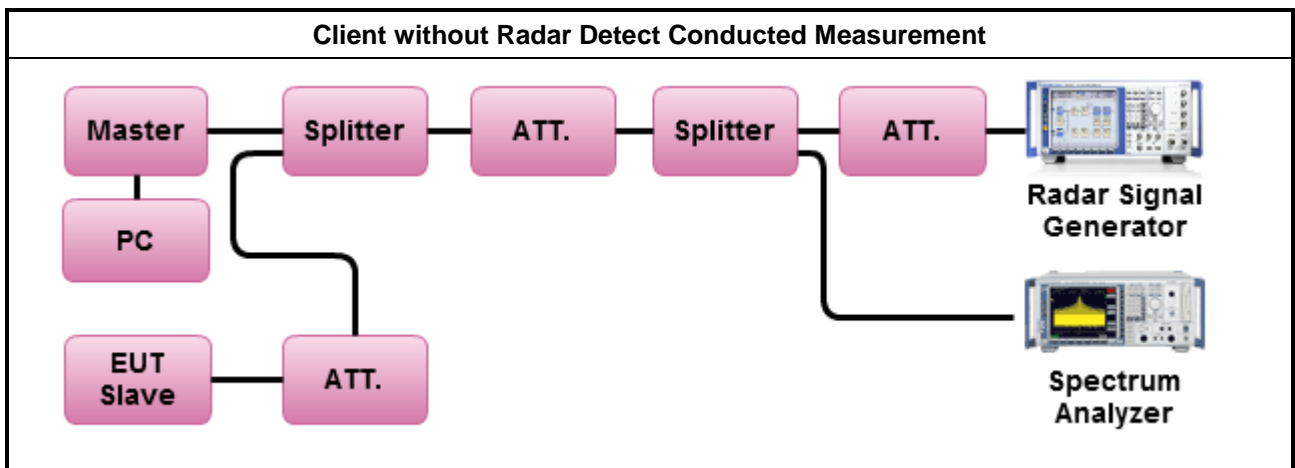
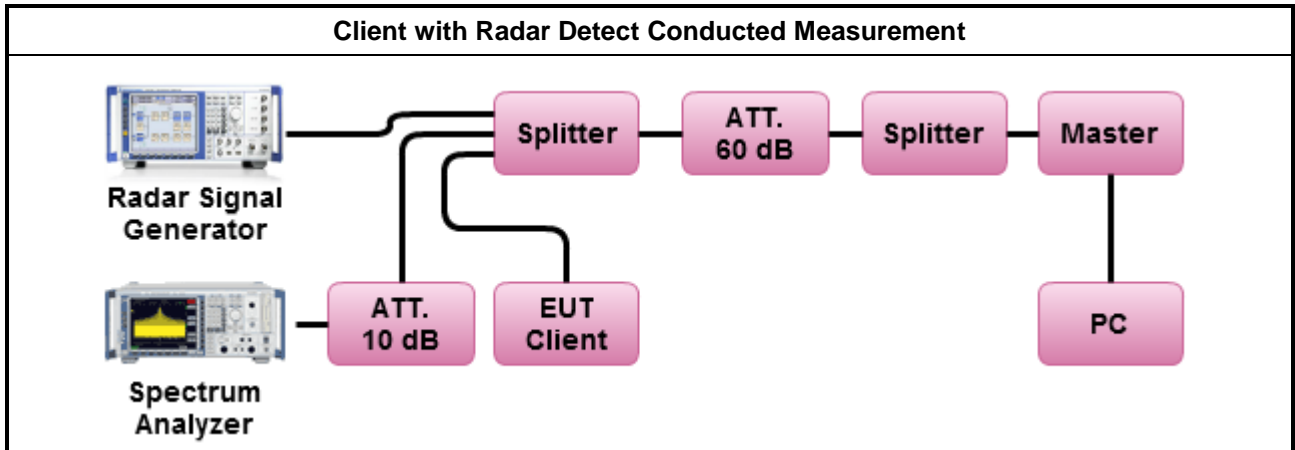



3.2.8 Data traffic Plot

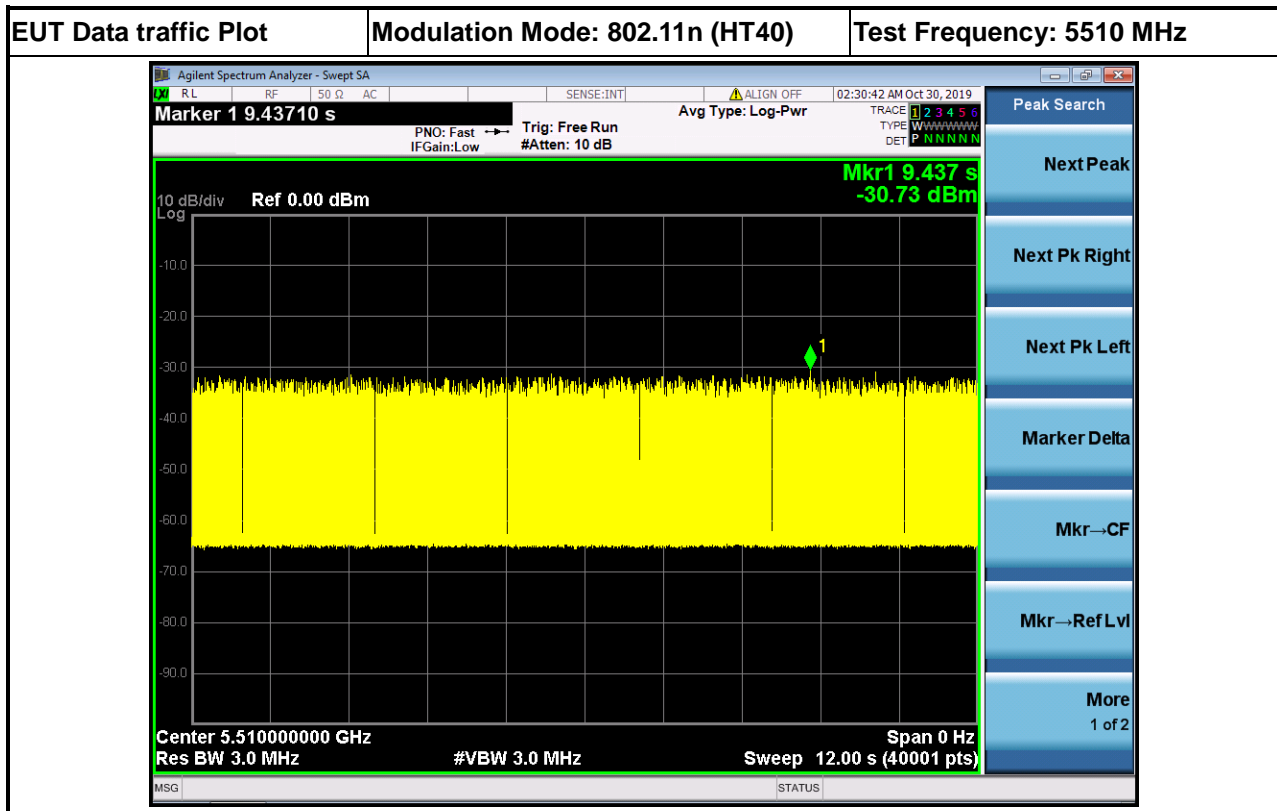

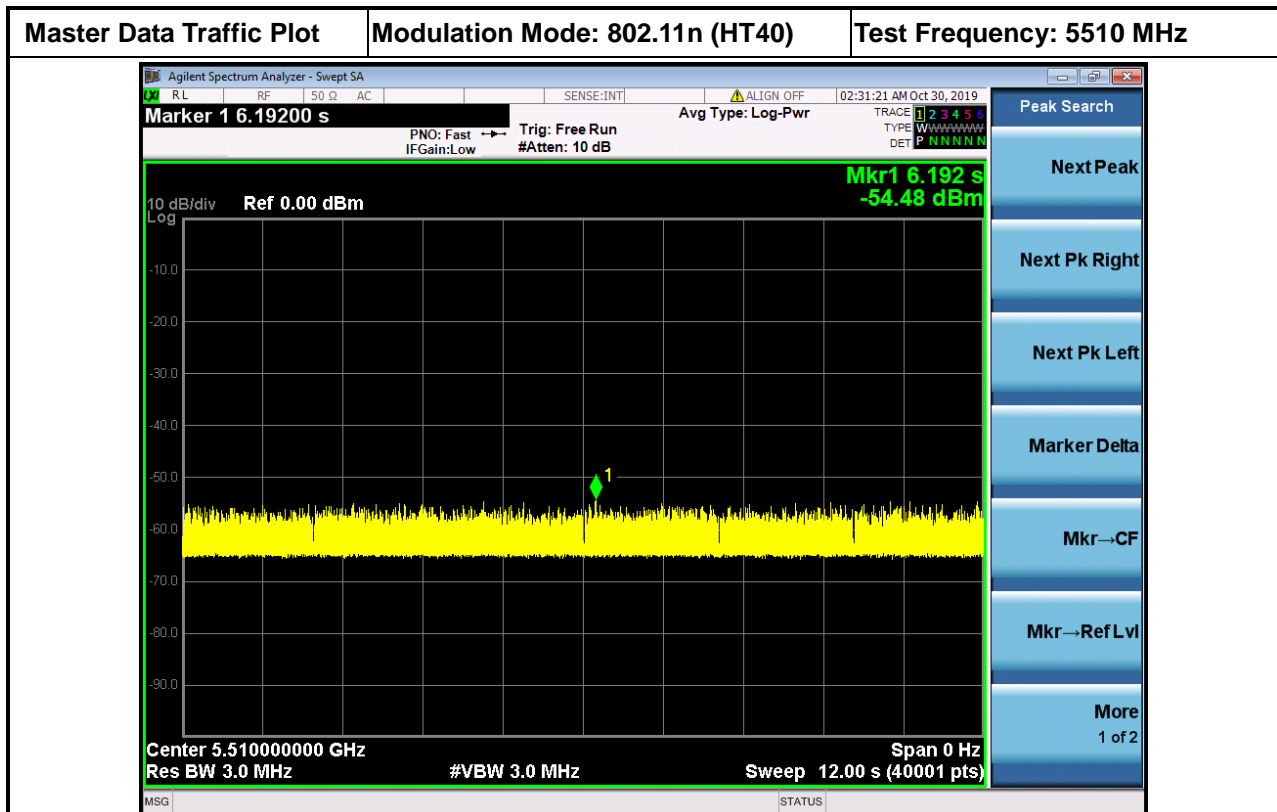

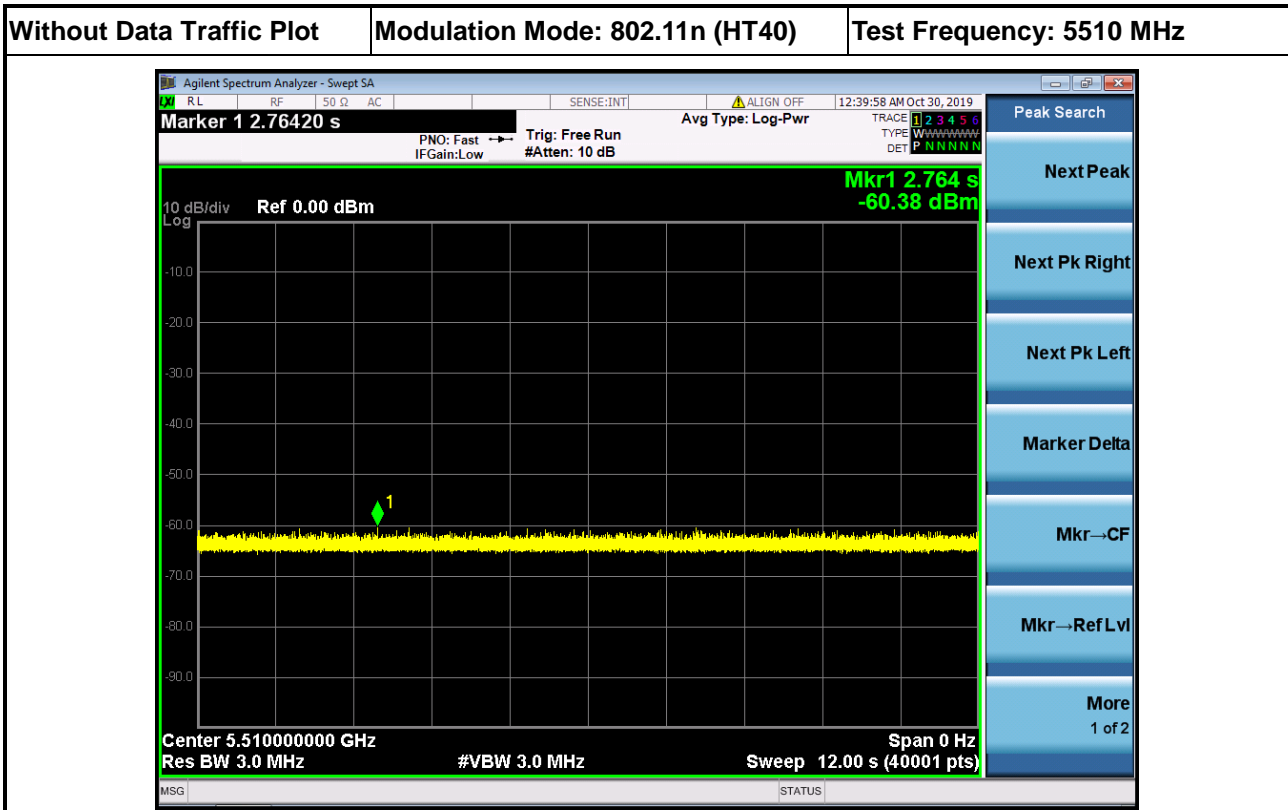



3.3 In-service Monitoring

3.3.1 In-service Monitoring Limit

| In-service Monitoring Limit | |
|-----------------------------------|---|
| Channel Move Time | 10 sec |
| Channel Closing Transmission Time | 200 ms + an aggregate of 60 ms over remaining 10 sec periods. |
| Non-occupancy period | Minimum 30 minutes |

3.3.2 Measuring Instruments

Refer a test equipment and calibration data table in this test report.

3.3.3 Test Procedures

| Test Method | |
|-------------------------------------|--|
| <input checked="" type="checkbox"/> | Verified during In-Service Monitoring; Channel Closing Transmission Time, Channel Move Time. Client Device will associate with the EUT. Observe the transmissions of the EUT at the end of the radar Burst on the Operating Channel for duration greater than 10 seconds. Measure and record the transmissions from the EUT during the observation time (Channel Move Time). Compare the Channel Move Time and Channel Closing Transmission Time limits. |
| <input checked="" type="checkbox"/> | Verified during In-Service Monitoring; Channel Closing Transmission Time, Channel Move Time. One 12 sec plot needs to be reported for the Short Pulse Radar Types 0. And zoom-in a 60 ms plot verified channel closing time for the aggregate transmission time starting from 200ms after the end of the radar signal to the completion of the channel move. |
| <input checked="" type="checkbox"/> | Verified during In-Service Monitoring; Non-Occupancy Period. Client Device will associate with the EUT. Observe the transmissions of the EUT at the end of the radar Burst on the Operating Channel for duration greater than 10 seconds. Measure and record the transmissions from the EUT during the observation time (Non-Occupancy Period). Compare the Non-Occupancy Period limits. |



3.3.4 Test Result of In-service Monitoring

Modulation Mode: 802.11n (HT40)

| Parameter | Test Result | Limit |
|---|-------------|---------------|
| | Type 0 | |
| Test Channel (MHz) | 5510 MHz | - |
| Channel Move Time (sec.) | 0.4616 | < 10s |
| Channel Closing Transmission Time (ms) (Note) | 2.400 | < 60ms |
| Non-Occupancy Period (min.) | ≥ 30 | ≥ 30 min |

Note: The Channel Closing Transmission Time is comprised of 200 milliseconds starting at the beginning of the Channel Move Time plus any additional intermittent control signals required to facilitate a Channel move (an aggregate of 60 milliseconds) during the remainder of the 10 seconds period. The aggregate duration of control signals will not count quiet periods in between transmissions.

3.3.5 Test Plot of In-Service Monitoring for Channel Move Time

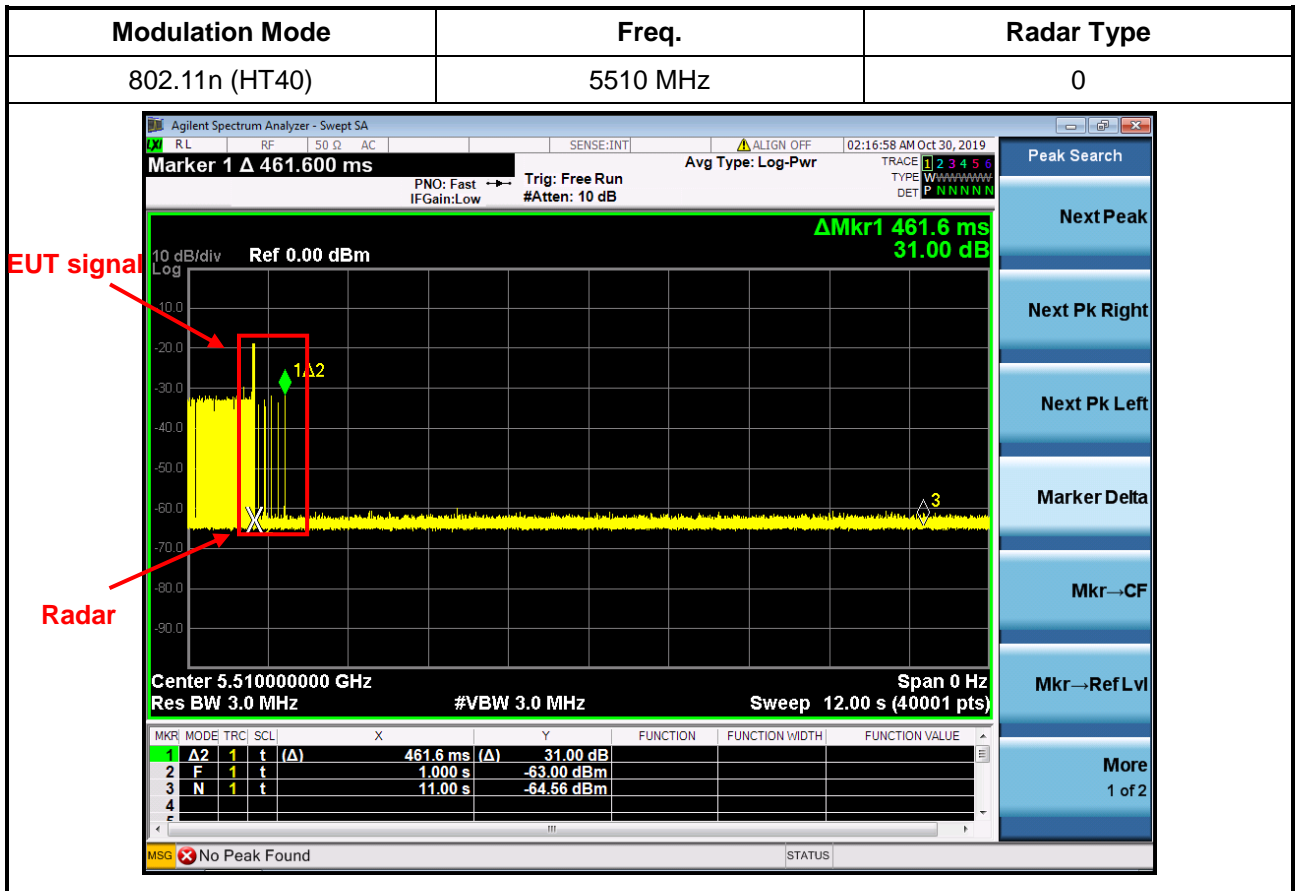



3.3.6 Test Plot of In-Service Monitoring for Channel Closing Transmission Time

| Modulation Mode | Freq. | Radar Type |
|-----------------|----------|------------|
| 802.11n (HT40) | 5510 MHz | 0 |

Channel Closing Transmission Time is comprised of 200 ms starting at the beginning of the Channel Move Time plus 60ms additional intermittent control signals

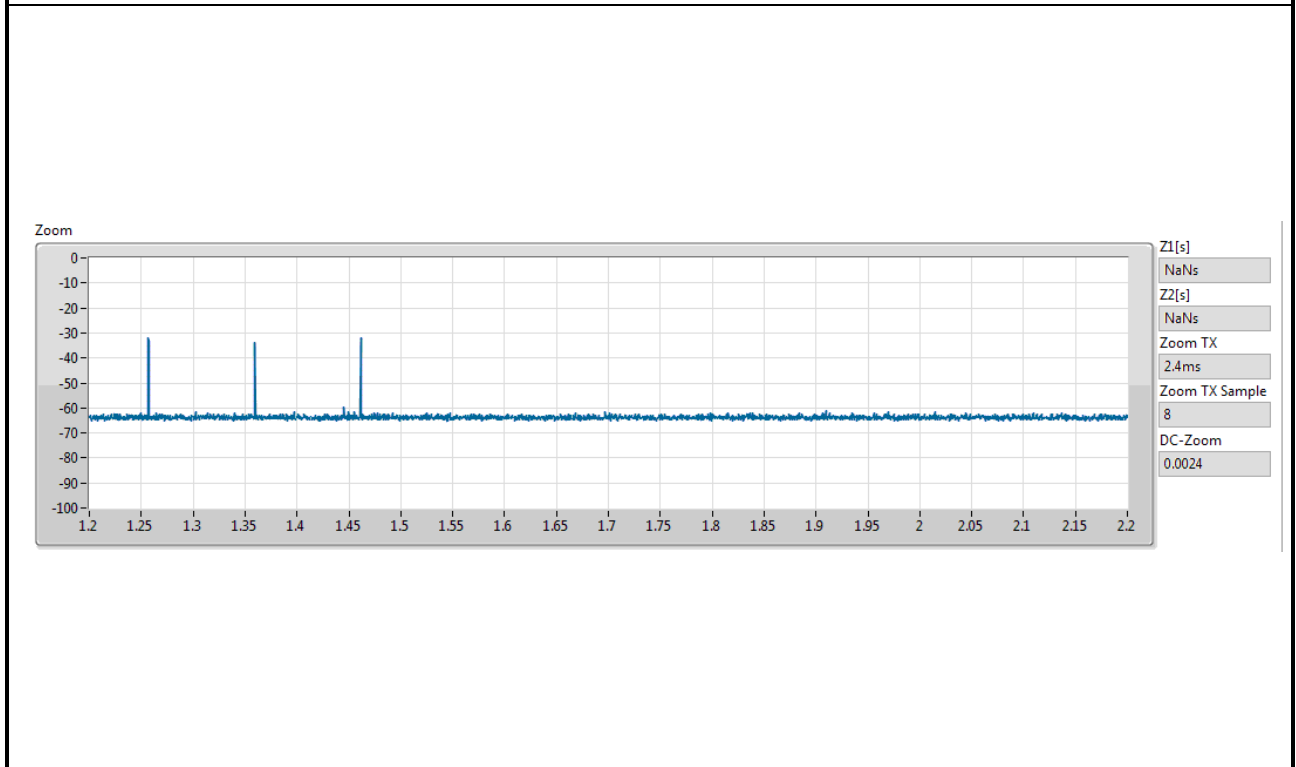

3.3.7 Test Plot of In-Service Monitoring for Non-Occupancy Period

| | |
|------------------------|--------------|
| Modulation Mode | Freq. |
| 802.11n (HT40) | 5510 MHz |

Non-associated test

Master was off.

During the 30 minutes observation time, The UUT did not make any transmissions in the DFS band after UUT power up.

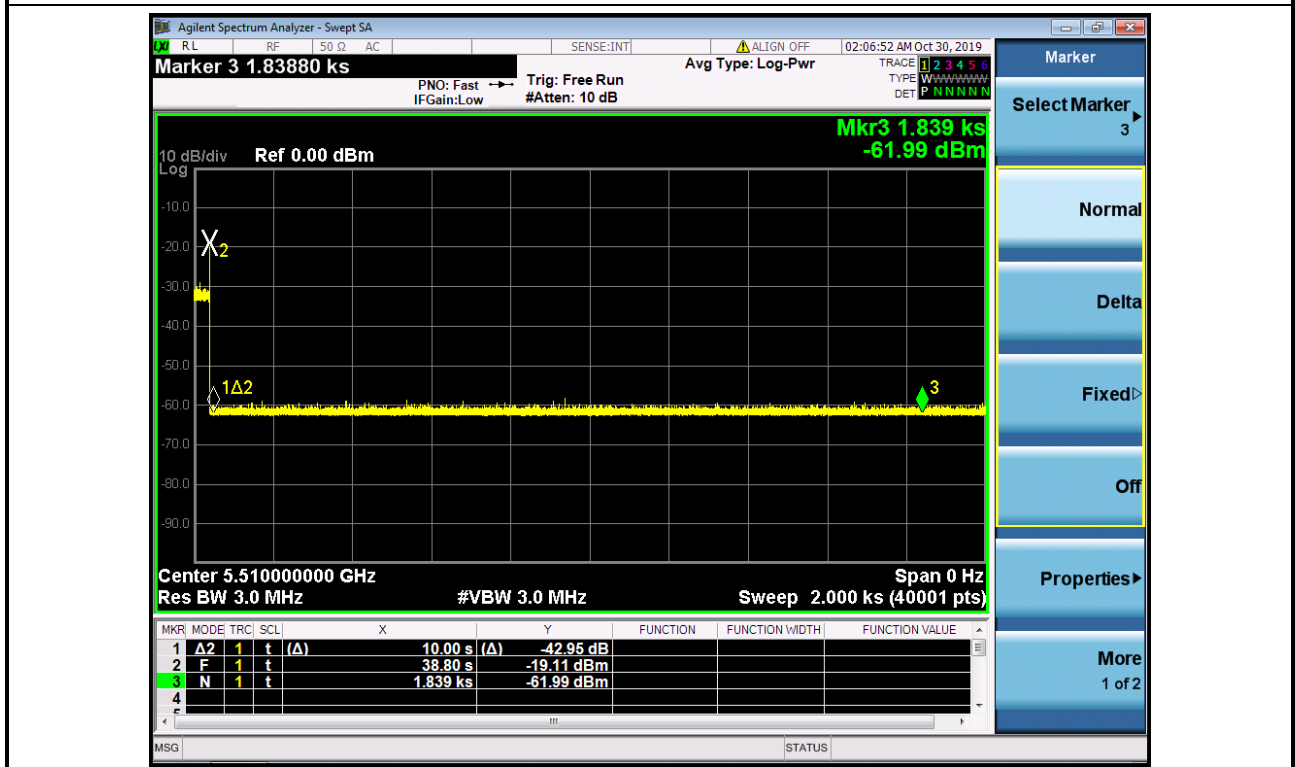



4 Test Equipment and Calibration Data

| Instrument | Manufacturer/ Brand Name | Model No. | Serial No. | Spec. | Calibration Date | Calibration Due Date |
|-------------------------|-----------------------------|------------------|------------|----------------|------------------|----------------------|
| Spectrum Analyzer | Keysight | N9010A | MY55150165 | 9kHz~7GHz | 15/Nov/2018 | 14/Nov/2019 |
| Vector Signal Generator | Keysight | N5182B | MY53051912 | 9kHz ~ 6GHz | 04/Dec/2017 | 03/Dec/2018 |
| RF cable 0.5m | MTJ Cooperation | 000000-MT26A-50 | D5105 | 1 GHz ~ 40 GHz | 01/Nov/2018 | 31/Oct/2019 |
| RF cable 0.5m | MTJ Cooperation | 000000-MT26A-50 | D5106 | 1 GHz ~ 40 GHz | 01/Nov/2018 | 31/Oct/2019 |
| RF cable 0.2m | MTJ Cooperation | 000000-MT26A-20 | D5102 | 1 GHz ~ 40 GHz | 01/Nov/2018 | 31/Oct/2019 |
| RF cable 0.2m | MTJ Cooperation | 000000-MT26A-20 | D5101 | 1 GHz ~ 40 GHz | 01/Nov/2018 | 31/Oct/2019 |
| RF cable 2m | MTJ Cooperation | 000000-MT18A-200 | D5100 | 1 GHz ~ 40 GHz | 01/Nov/2018 | 31/Oct/2019 |

NCR: No Calibration Required.



5 Measurement Uncertainty

| Test Items | Uncertainty | Remark |
|--------------------|-------------|--------------------------|
| Conducted Emission | 1.3 dB | Confidence levels of 95% |
| Temperature | 0.7 °C | Confidence levels of 95% |
| Humidity | 4 % | Confidence levels of 95% |