



# FCC Test Report

**FCC ID** : 2AEUPBHASC052  
**Equipment** : Stick Up Cam Elite  
**Brand Name** : Ring LLC  
**Model Name** : Stick Up Cam Wired  
**Applicant** : Ring LLC  
: 1523 26th St, Santa Monica, CA 90404, USA  
**Manufacturer** : Chicony Electronics Co.,Ltd.  
: No.69, Sec. 2, Guangfu Rd., Sanchong Dist. New Taipei  
City 241 Taiwan  
**Standard** : 47 CFR FCC Part 15.247

The product was received on Jun. 01, 2018, and testing was started from Jun. 17, 2018 and completed on Sep. 24, 2019. We, SPORTON INTERNATIONAL INC. EMC & Wireless Communications Laboratory, would like to declare that the tested sample has been evaluated in accordance with the procedures given in ANSI C63.10-2013 and shown compliance with the applicable technical standards.

The report must not be used by the client to claim product certification, approval, or endorsement by TAF or any agency of government.

The test results in this report apply exclusively to the tested model / sample. Without written approval of SPORTON INTERNATIONAL INC. EMC & Wireless Communications Laboratory, the test report shall not be reproduced except in full.

Approved by: Allen Lin

**SPORTON INTERNATIONAL INC. EMC & Wireless Communications Laboratory**

No. 52, Huaya 1st Rd., Guishan Dist., Taoyuan City, Taiwan (R.O.C.)



# Table of Contents

**HISTORY OF THIS TEST REPORT .....3**

**SUMMARY OF TEST RESULT .....4**

**1 GENERAL DESCRIPTION .....5**

1.1 Information.....5

1.2 Testing Applied Standards .....7

1.3 Testing Location Information .....7

1.4 Measurement Uncertainty .....7

**2 TEST CONFIGURATION OF EUT.....8**

2.1 Test Condition .....8

2.2 Test Channel Mode .....8

2.3 The Worst Case Measurement Configuration.....9

2.4 Accessories .....10

2.5 Support Equipment.....11

2.6 Test Setup Diagram .....12

**3 TRANSMITTER TEST RESULT .....16**

3.1 AC Power-line Conducted Emissions .....16

3.2 DTS Bandwidth.....17

3.3 Maximum Conducted Output Power .....18

3.4 Power Spectral Density .....20

3.5 Emissions in Non-restricted Frequency Bands .....21

3.6 Emissions in Restricted Frequency Bands.....22

**4 TEST EQUIPMENT AND CALIBRATION DATA .....26**

**APPENDIX A. TEST RESULTS OF AC POWER-LINE CONDUCTED EMISSIONS**

**APPENDIX B. TEST RESULTS OF DTS BANDWIDTH**

**APPENDIX C. TEST RESULTS OF MAXIMUM CONDUCTED OUTPUT POWER**

**APPENDIX D. TEST RESULTS OF POWER SPECTRAL DENSITY**

**APPENDIX E. TEST RESULTS OF EMISSIONS IN NON-RESTRICTED FREQUENCY BANDS**

**APPENDIX F. TEST RESULTS OF EMISSIONS IN RESTRICTED FREQUENCY BANDS**

**APPENDIX G. TEST PHOTOS**

**PHOTOGRAPHS OF EUT V01**



### History of this test report

Report No.	Version	Description	Issued Date
FR852814-03AC	01	Initial issue of report	Oct. 04, 2019
FR852814-03AC	02	The Manufacturer information was update This report is the latest version replacing for the report issued on Oct. 04, 2019	Oct. 16, 2019



### Summary of Test Result

Report Clause	Ref. Std. Clause	Test Items	Result (PASS/FAIL)	Remark
1.1.2	15.203	Antenna Requirement	PASS	FCC 15.203
3.1	15.207	AC Power-line Conducted Emissions	PASS	FCC 15.207
3.2	15.247(a)	DTS Bandwidth	PASS	≥500kHz
3.3	15.247(b)	Maximum Conducted Output Power	PASS	Power [dBm]: 30
3.4	15.247(e)	Power Spectral Density	PASS	PSD [dBm/3kHz]: 8
3.5	15.247(d)	Emissions in Non-restricted Frequency Bands	PASS	Non-Restricted Bands: > 30 dBc
3.6	15.247(d)	Emissions in Restricted Frequency Bands	PASS	Restricted Bands: FCC 15.209

Reviewed by: Sam Tsai

Report Producer: Debby Hung



# 1 General Description

## 1.1 Information

### 1.1.1 RF General Information

Frequency Range (MHz)	IEEE Std. 802.11	Ch. Frequency (MHz)	Channel Number
2400-2483.5	b, g, n (HT20)	2412-2462	1-11 [11]

Band	Mode	BWch (MHz)	Nant
2.4-2.4835GHz	802.11b	20	1TX
2.4-2.4835GHz	802.11g	20	1TX
2.4-2.4835GHz	802.11n HT20	20	1TX

Note:

- ◆ 11b mode uses a combination of DSSS-DBPSK, DQPSK, CCK modulation.
- ◆ 11g, HT20 use a combination of OFDM-BPSK, QPSK, 16QAM, 64QAM modulation.
- ◆ BWch is the nominal channel bandwidth.

### 1.1.2 Antenna Information

Ant.	Port	Brand	Model Name	Antenna Type	Connector
1	1	-	Orion Wifi Antenna	PIFA Antenna	Fixed on board

2.4G		5G		BT	
Frequency (MHz)	Gain (dBi)	Frequency (MHz)	Gain (dBi)	Frequency (MHz)	Gain (dBi)
2412	0.94	5180	2.68	2402	0.94
2417	0.94	5200	2.68	2440	0.69
2422	0.94	5240	2.77	2480	0.10
2427	0.69	5190	2.68	-	-
2432	0.69	5230	2.77	-	-
2437	0.69	5745	3.12	-	-
2442	0.69	5785	2.65	-	-
2447	0.69	5825	1.67	-	-
2452	0.69	5755	3.12	-	-
2457	0.69	5795	2.65	-	-
2462	0.69	-	-	-	-

**For 2.4 GHz function:**

For IEEE 802.11b/g/n mode (1TX/1RX)

Only Ant. 1 (port 1) can be used as transmitting/receiving antenna.

**For 5 GHz function:**

For IEEE 802.11a/n mode (1TX/1RX)

Only Ant. 1 (port 1) can be used as transmitting/receiving antenna.

**For Bluetooth function:**

For Bluetooth mode (1TX/1RX)

Only Ant. 1 (port 1) can be used as transmitting/receiving antenna.



1.1.3 EUT Information

Operational Condition				
EUT Power Type	From AC Adapter			
EUT Function	<input checked="" type="checkbox"/>	Point-to-multipoint	<input type="checkbox"/>	Point-to-point
Beamforming Function	<input type="checkbox"/>	With beamforming	<input checked="" type="checkbox"/>	Without beamforming
Type of EUT				
<input checked="" type="checkbox"/>	Stand-alone			
<input type="checkbox"/>	Combined (EUT where the radio part is fully integrated within another device)			
	Combined Equipment - Brand Name / Model No.: ...			
<input type="checkbox"/>	Plug-in radio (EUT intended for a variety of host systems)			
	Host System - Brand Name / Model No.: ...			
<input type="checkbox"/>	Other:			

1.1.4 Mode Test Duty Cycle

Mode	DC	DCF(dB)	T(s)	VBW(Hz) ≥ 1/T
802.11b	0.99	0.044	n/a (DC>=0.98)	n/a (DC>=0.98)
802.11g	0.937	0.283	1.43m	1k
802.11n HT20	0.932	0.306	1.338m	1k

1.1.5 Table for Existing Change

This product is an extension of original one reported under Sporton project number: FR852814-02AC

Below is the table for the change of the product with respect to the original one.

Modifications	Performance Checking
Two PoE Adapter and Ethernet Cable was added.	AC Conduction data and Radiated Emission data 30M to 1G was evaluated



## 1.2 Testing Applied Standards

According to the specifications of the manufacturer, the EUT must comply with the requirements of the following standards:

- ◆ 47 CFR FCC Part 15
- ◆ ANSI C63.10-2013
- ◆ KDB 558074 D01 v05r02
- ◆ KDB 414788 D01 v01r01

## 1.3 Testing Location Information

Testing Location		
<input checked="" type="checkbox"/>	HWA YA	ADD : No. 52, Huaya 1 <sup>st</sup> Rd., Guishan Dist., Taoyuan City, Taiwan (R.O.C.) TEL : 886-3-327-3456 FAX : 886-3-327-0973
Test site Designation No. TW1190 with FCC.		
<input checked="" type="checkbox"/>	LIN KOU	ADD : No. 30-2, Dingfu Vil., Linkou Dist., New Taipei City, Taiwan (R.O.C.) TEL : 886-2-2601-1640 FAX : 886-2-2601-1695
Test site Designation No. TW1095 with FCC.		

Test Condition	Test Site No.	Test Engineer	Test Environment	Test Date
RF Conducted	TH01-HY	Andy	23.5°C / 65%	21/Jun/2018
Radiated<9k~30M>	03CH02-HY	Jeff	23.5°C / 60%	15/Aug/2018
Radiated<30M~1G>	03CH02-HY	Terry	22.6°C / 61%	17/Jun/2018
AC Conduction	CO04-HY	Andy	23.5°C / 53.8%	25/Jul/2018
AC Conduction <PoE Adapter>	CO04-HY	David	22~22.5°C / 62.1~62.6%	23/Sep/2019
Radiated < 30M~1GHz > <PoE Adapter>	OS03-LK	Chu	26.1~26.3°C / 65.2~65.4%	24/Sep/2019

## 1.4 Measurement Uncertainty

ISO/IEC 17025 requires that an estimate of the measurement uncertainties associated with the emissions test results be included in the report. The measurement uncertainties given below are based on a 95% confidence level (based on a coverage factor (k=2))

Test Items	Uncertainty	Remark
Conducted Emission (150kHz ~ 30MHz)	3.6 dB	Confidence levels of 95%
Radiated Emission (9kHz ~ 30MHz)	3.0 dB	Confidence levels of 95%
Radiated Emission (30MHz ~ 1,000MHz)	4.3 dB	Confidence levels of 95%
Radiated Emission (1GHz ~ 18GHz)	3.9 dB	Confidence levels of 95%
Radiated Emission (18GHz ~ 40GHz)	3.5 dB	Confidence levels of 95%
Conducted Emission	1.3 dB	Confidence levels of 95%
Temperature	0.7 °C	Confidence levels of 95%
Humidity	4 %	Confidence levels of 95%



## 2 Test Configuration of EUT

### 2.1 Test Condition

RF Conducted	Abbreviation	Remark
TnomVnom	Tnom	20°C
-	Vnom	120V

### 2.2 Test Channel Mode

Test Software	DoS
---------------	-----



Mode	PowerSetting
802.11b_Nss1,(1Mbps)_1TX	-
2412MHz	20
2437MHz	20
2462MHz	20
802.11g_Nss1,(6Mbps)_1TX	-
2412MHz	16.5
2417MHz	20
2437MHz	20
2457MHz	20
2462MHz	16
802.11n HT20_Nss1,(MCS0)_1TX	-
2412MHz	16
2417MHz	19
2422MHz	20
2437MHz	20
2457MHz	20
2462MHz	16



### 2.3 The Worst Case Measurement Configuration

The Worst Case Mode for Following Conformance Tests	
Tests Item	AC power-line conducted emissions
Condition	AC power-line conducted measurement for line and neutral
Operating Mode	CTX
1	Adapter mode
2	PoE Adapter mode

The Worst Case Mode for Following Conformance Tests	
Tests Item	DTS Bandwidth Maximum Conducted Output Power Power Spectral Density Emissions in Non-restricted Frequency Bands
Test Condition	Conducted measurement at transmit chains

The Worst Case Mode for Following Conformance Tests			
Tests Item	Emissions in Restricted Frequency Bands		
Test Condition	Radiated measurement If EUT consist of multiple antenna assembly (multiple antenna are used in EUT regardless of spatial multiplexing MIMO configuration), the radiated test should be performed with highest antenna gain of each antenna type.		
Operating Mode < 1GHz	CTX		
1	Adapter mode		
2	PoE Adapter mode		
Operating Mode > 1GHz	CTX		
Orthogonal Planes of EUT	X Plane	Y Plane	Z Plane
			
Worst Planes of EUT	V		



## 2.4 Accessories

Accessories				
Indoor Adapter	Brand Name	DEE VAN ENTERPRISE	Model Name	DSA-15CAB-05 050250
	Power Rating	I/P: <u>100</u> - <u>240</u> Vac, <u>0.5</u> A, O/P: <u>5</u> Vdc, <u>2.5</u> A		
Outdoor Adapter	Brand Name	ring	Model Name	DSA-15PFL-05 FUS 050250
	Power Rating	I/P: 100-240V ~ 0.5A MAX 50-60Hz; O/P: 5V 2.5A		
	DC Power Cord	2.45 meter, non-shielded cable, w/o ferrite core		
	AC Power Cord	4.53 meter, non-shielded cable, w/o ferrite core		
PoE Adapter 1	Brand Name	Phihong	Model Name	POE15M
	Power Rating	I/P: 100 - 240Vac, 0.8 A, O/P: 56 Vdc, 0.275 A		
PoE Adapter 2	Brand Name	ONV	Model Name	PSE3010DCG
	Power Rating	I/P: 100 - 240Vac, 0.8 A, O/P: 5 Vdc, 2.5A		
Adapter 2	Brand Name	ZTE	Model Name	RJ-AS120150U104-B
	Power Rating	I/P: 100 - 240Vac, 1 A, O/P: 12Vdc, 1.5A		
USB Cable	Power Rating	2.45 meter, non-shielded cable, w/o ferrite core		
6ft Ethernet Cable	Power Rating	1.8 meter, non-shielded cable, w/o ferrite core		

Reminder: Regarding to more detail and other information, please refer to user manual.



## 2.5 Support Equipment

Support Equipment - RF Conducted				
No.	Equipment	Brand Name	Model Name	FCC ID
1	Notebook	DELL	E5410	DoC
2	Adapter for NB	DELL	HA65NM130	DoC
3	AC Power Source	G.W	APS-9102	-

Support Equipment - AC Conduction				
No.	Equipment	Brand Name	Model Name	FCC ID
1	PoE Adapter	Phihong	POE15M	-
Z1	802.11ac Dual-Band Wireless-AC1750 Gigabit Router	ASUS	RT-AC66U	MSQ-RTAC66U
Z2	iPhone 8	Apple	MRRM2TA/A	-
Z3	Notebook	DELL	D5500	DoC

Support Equipment - Radiated Emission				
No.	Equipment	Brand Name	Model Name	FCC ID
Z1	AP Router	Netgear	R6300v2	DoC
Z2	iPad	APPLE	A1538	-
Z3	PoE Adapter	Phihong	POE15M	-

## 2.6 Test Setup Diagram

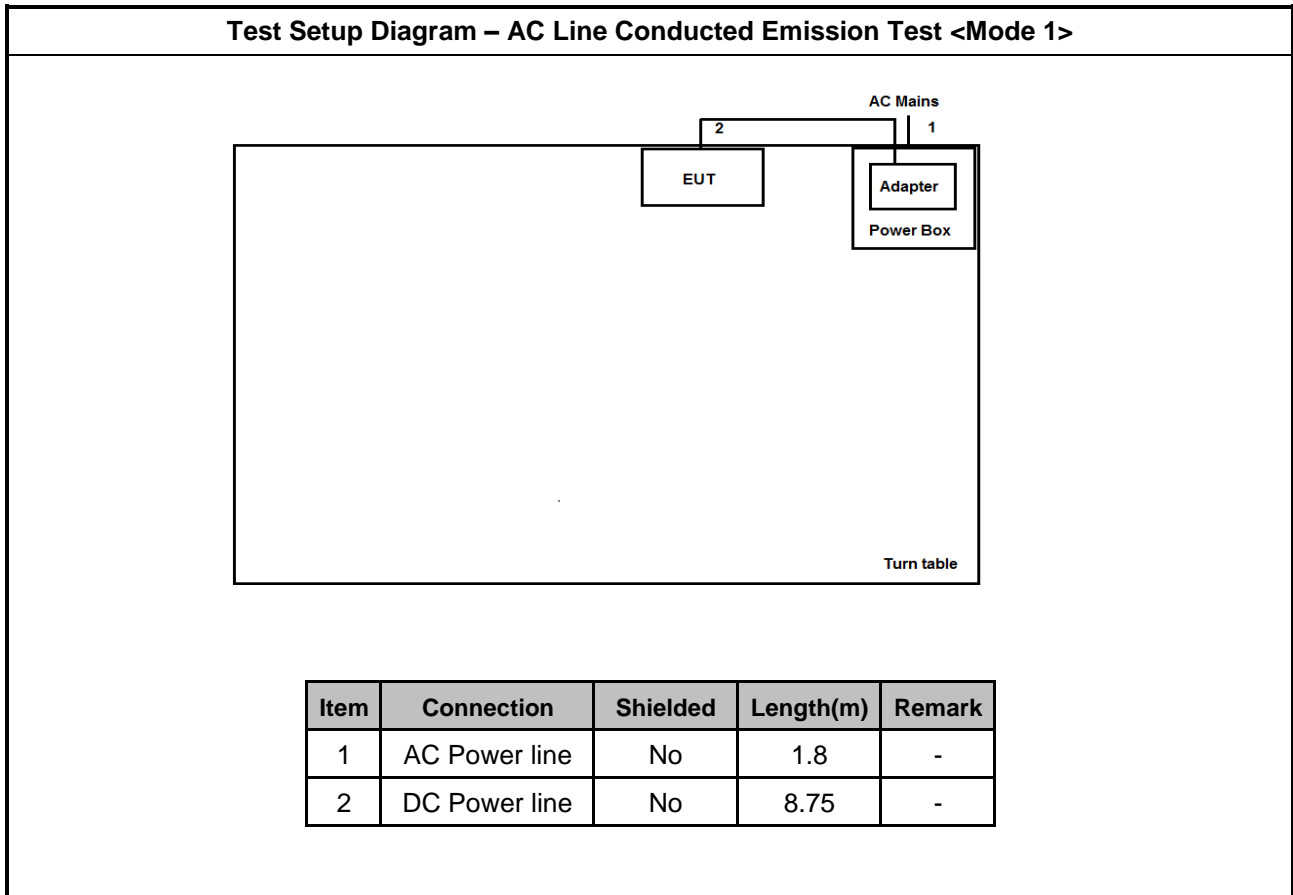

Test Setup Diagram – AC Line Conducted Emission Test <Mode 2>

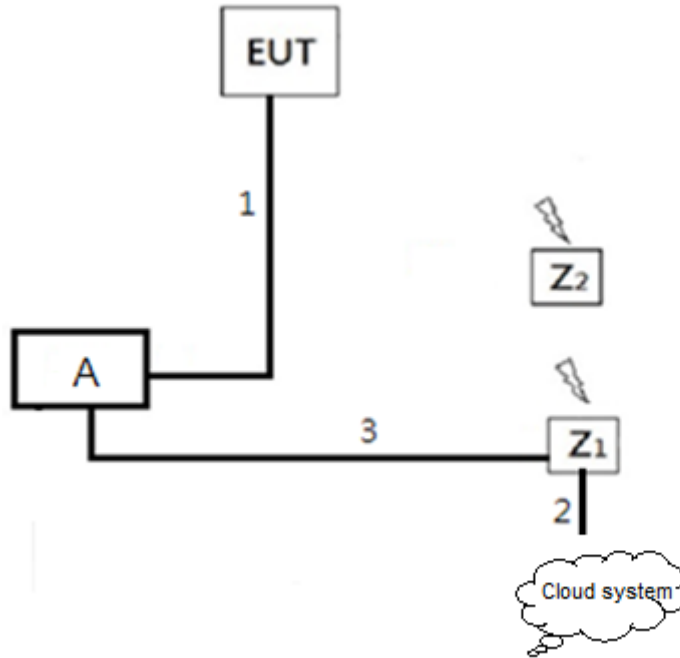

No.	Types of Cables	Shielding on Cable	Length (m)	Remarks
1	RJ45 Cable	Non-Shielded	1	-
2	RJ45 Cable	Non-Shielded	1	-
3	RJ45 Cable	Non-Shielded	1.8+10	-

**Test Setup Diagram - Radiated Test <Mode 1>**

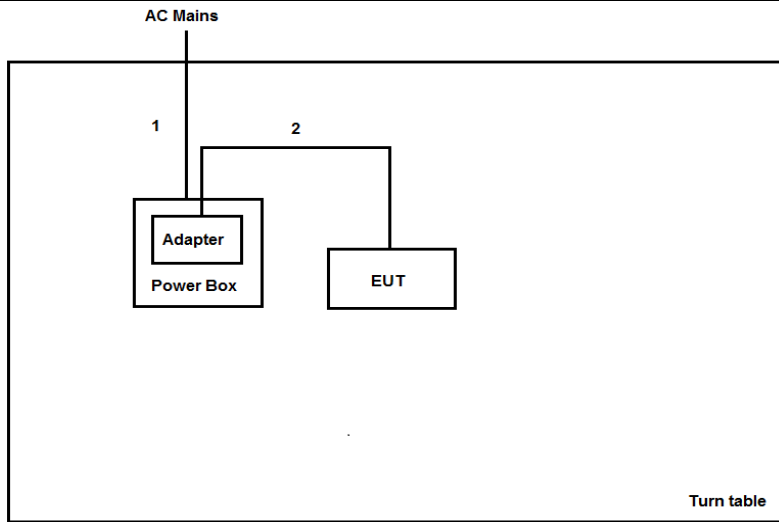

Item	Connection	Shielded	Length(m)	Remark
1	AC Power line	No	2.45	-
2	DC Power line	No	8.75	-

Test Setup Diagram - Radiated Test <Mode 2>

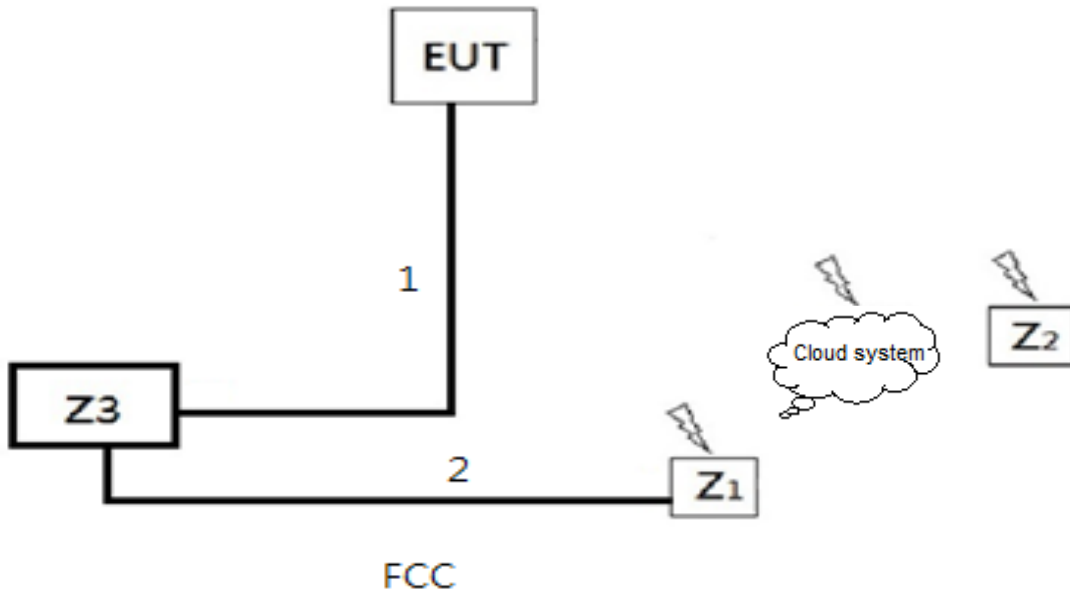

No.	Types of Cables	Shielding on Cable	Length (m)	Remarks
1	RJ45 Cable	Non-Shielded	10	-
2	RJ45 cable	Non-Shielded	1.8	-

### 3 Transmitter Test Result

#### 3.1 AC Power-line Conducted Emissions

##### 3.1.1 AC Power-line Conducted Emissions Limit

AC Power-line Conducted Emissions Limit		
Frequency Emission (MHz)	Quasi-Peak	Average
0.15-0.5	66 - 56 *	56 - 46 *
0.5-5	56	46
5-30	60	50

Note 1: \* Decreases with the logarithm of the frequency.

##### 3.1.2 Measuring Instruments

Refer a test equipment and calibration data table in this test report.

##### 3.1.3 Test Procedures

Test Method
<input checked="" type="checkbox"/> Refer as ANSI C63.10-2013, clause 6.2 for AC power-line conducted emissions.

##### 3.1.4 Test Setup

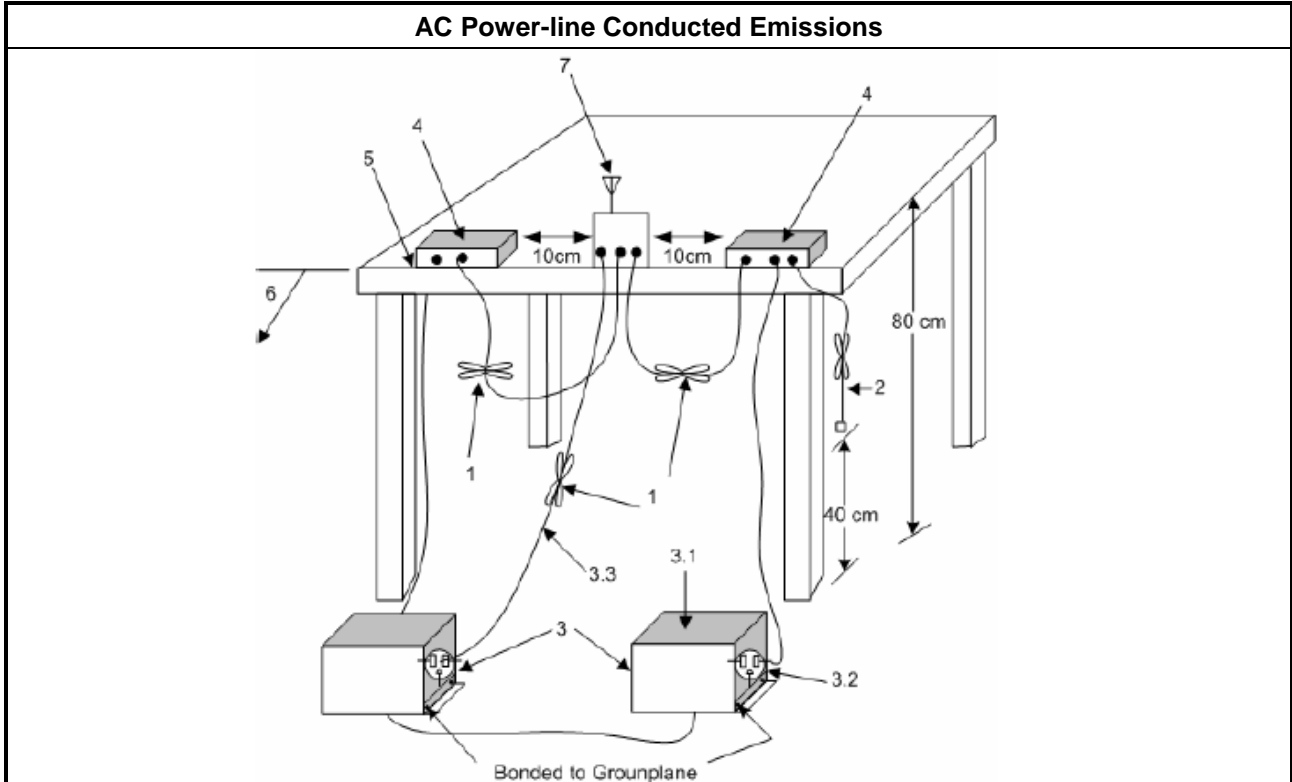

##### 3.1.5 Test Result of AC Power-line Conducted Emissions

Refer as Appendix A



### 3.2 DTS Bandwidth

#### 3.2.1 6dB Bandwidth Limit

6dB Bandwidth Limit
<b>Systems using digital modulation techniques:</b>
<ul style="list-style-type: none"> <li>▪ 6 dB bandwidth <math>\geq</math> 500 kHz.</li> </ul>

#### 3.2.2 Measuring Instruments

Refer a test equipment and calibration data table in this test report.

#### 3.2.3 Test Procedures

Test Method
<ul style="list-style-type: none"> <li>▪ For the emission bandwidth shall be measured using one of the options below:</li> </ul>
<input checked="" type="checkbox"/> Refer as KDB 558074. clause 8.2 (11.8 of ANSI C63.10) DTS bandwidth measurement.
<input type="checkbox"/> Refer as RSS-Gen, clause 6.7 for for occupied bandwidth testing.
<input type="checkbox"/> Refer as ANSI C63.10, clause 6.9.3 for occupied bandwidth testing.

#### 3.2.4 Test Setup

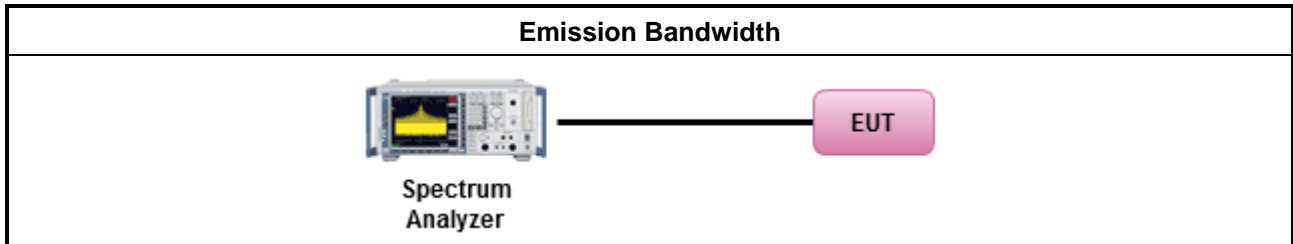

#### 3.2.5 Test Result of Emission Bandwidth

Refer as Appendix B

### 3.3 Maximum Conducted Output Power

#### 3.3.1 Maximum Conducted Output Power Limit

Maximum Conducted Output Power Limit	
	<ul style="list-style-type: none"> <li>▪ If <math>G_{TX} \leq 6</math> dBi, then <math>P_{Out} \leq 30</math> dBm (1 W)</li> </ul>
	<ul style="list-style-type: none"> <li>▪ Point-to-multipoint systems (P2M): If <math>G_{TX} &gt; 6</math> dBi, then <math>P_{Out} = 30 - (G_{TX} - 6)</math> dBm</li> </ul>
	<ul style="list-style-type: none"> <li>▪ Point-to-point systems (P2P): If <math>G_{TX} &gt; 6</math> dBi, then <math>P_{Out} = 30 - (G_{TX} - 6)/3</math> dBm</li> </ul>
	<ul style="list-style-type: none"> <li>▪ Smart antenna system (SAS):</li> </ul>
	<ul style="list-style-type: none"> <li>- Single beam: If <math>G_{TX} &gt; 6</math> dBi, then <math>P_{Out} = 30 - (G_{TX} - 6)/3</math> dBm</li> </ul>
	<ul style="list-style-type: none"> <li>- Overlap beam: If <math>G_{TX} &gt; 6</math> dBi, then <math>P_{Out} = 30 - (G_{TX} - 6)/3</math> dBm</li> </ul>
	<ul style="list-style-type: none"> <li>- Aggregate power on all beams: If <math>G_{TX} &gt; 6</math> dBi, then <math>P_{Out} = 30 - (G_{TX} - 6)/3 + 8</math> dB dBm</li> </ul>
e.i.r.p. Power Limit:	
	<ul style="list-style-type: none"> <li>▪ 2400-2483.5 MHz Band</li> </ul>
	<ul style="list-style-type: none"> <li>▪ Point-to-multipoint systems (P2M): <math>P_{eirp} \leq 36</math> dBm (4 W)</li> </ul>
	<ul style="list-style-type: none"> <li>▪ Point-to-point systems (P2P): <math>P_{eirp} \leq \text{MAX}(36, [P_{Out} + G_{TX}])</math> dBm</li> </ul>
	<ul style="list-style-type: none"> <li>▪ Smart antenna system (SAS)</li> </ul>
	<ul style="list-style-type: none"> <li>- Single beam: <math>P_{eirp} \leq \text{MAX}(36, P_{Out} + G_{TX})</math> dBm</li> </ul>
	<ul style="list-style-type: none"> <li>- Overlap beam: <math>P_{eirp} \leq \text{MAX}(36, P_{Out} + G_{TX})</math> dBm</li> </ul>
	<ul style="list-style-type: none"> <li>- Aggregate power on all beams: <math>P_{eirp} \leq \text{MAX}(36, [P_{Out} + G_{TX} + 8])</math> dBm</li> </ul>
<p><math>P_{Out}</math> = maximum peak conducted output power or maximum conducted output power in dBm,  <math>G_{TX}</math> = the maximum transmitting antenna directional gain in dBi.</p>	

#### 3.3.2 Measuring Instruments

Refer a test equipment and calibration data table in this test report.

### 3.3.3 Test Procedures

Test Method	
<ul style="list-style-type: none"> <li>▪ Maximum Peak Conducted Output Power</li> </ul>	
<input type="checkbox"/>	Refer as KDB 558074, clause 8.3.1.1 (11.9.1.1 of ANSI C63.10) RBW ≥ EBW method.
<input type="checkbox"/>	Refer as KDB 558074, clause 8.3.1.2 (11.9.1.2 of ANSI C63.10) integrated band power method.
<input type="checkbox"/>	Refer as KDB 558074, clause 8.3.1.3 (11.9.1.3 of ANSI C63.10) peak power meter.
<ul style="list-style-type: none"> <li>▪ Maximum Average Conducted Output Power</li> </ul>	
<input type="checkbox"/>	Refer as KDB 558074, clause 8.3.2.2 (11.9.2.2 of ANSI C63.10) using a spectrum analyzer.
<input checked="" type="checkbox"/>	Refer as KDB 558074, clause 8.3.2.3 (11.9.2.3 of ANSI C63.10) using a power meter.
<ul style="list-style-type: none"> <li>▪ For conducted measurement.</li> </ul>	
<ul style="list-style-type: none"> <li>▪ If the EUT supports multiple transmit chains using options given below: Refer as KDB 662911, In-band power measurements. Using the measure-and-sum approach, measured all transmit ports individually. Sum the power (in linear power units e.g., mW) of all ports for each individual sample and save them.</li> </ul>	
<ul style="list-style-type: none"> <li>▪ If multiple transmit chains, EIRP calculation could be following as methods:  <math display="block">P_{total} = P_1 + P_2 + \dots + P_n</math>                     (calculated in linear unit [mW] and transfer to log unit [dBm])  <math display="block">EIRP_{total} = P_{total} + DG</math> </li> </ul>	

### 3.3.4 Test Setup

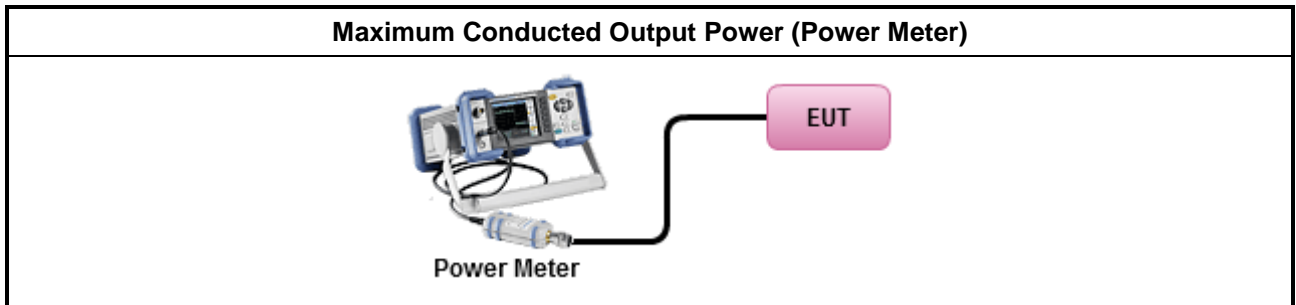

### 3.3.5 Test Result of Maximum Conducted Output Power

Refer as Appendix C

### 3.4 Power Spectral Density

#### 3.4.1 Power Spectral Density Limit

Power Spectral Density Limit
<ul style="list-style-type: none"> <li>Power Spectral Density (PSD) <math>\leq</math> 8 dBm/3kHz</li> </ul>

#### 3.4.2 Measuring Instruments

Refer a test equipment and calibration data table in this test report.

#### 3.4.3 Test Procedures

Test Method
<ul style="list-style-type: none"> <li>Peak power spectral density procedures that the same method as used to determine the conducted output power. If maximum peak conducted output power was measured to demonstrate compliance to the output power limit, then the peak PSD procedure below (Method PKPSD) shall be used. If maximum conducted output power was measured to demonstrate compliance to the output power limit, then one of the average PSD procedures shall be used, as applicable based on the following criteria (the peak PSD procedure is also an acceptable option).</li> </ul>
<input checked="" type="checkbox"/> Refer as KDB 558074, clause 8.4 (11.10 of ANSI C63.10) Method PKPSD.
<ul style="list-style-type: none"> <li>For conducted measurement.</li> </ul>
<ul style="list-style-type: none"> <li>If The EUT supports multiple transmit chains using options given below:             <ul style="list-style-type: none"> <li>Measure and sum the spectra across the outputs. Refer as KDB 662911, In-band power spectral density (PSD). Sample all transmit ports simultaneously using a spectrum analyzer for each transmit port. Where the trace bin-by-bin of each transmit port summing can be performed. (i.e., in the first spectral bin of output 1 is summed with that in the first spectral bin of output 2 and that from the first spectral bin of output 3, and so on up to the NTX output to obtain the value for the first frequency bin of the summed spectrum.). Add up the amplitude (power) values for the different transmit chains and use this as the new data trace.</li> </ul> </li> </ul>

#### 3.4.4 Test Setup

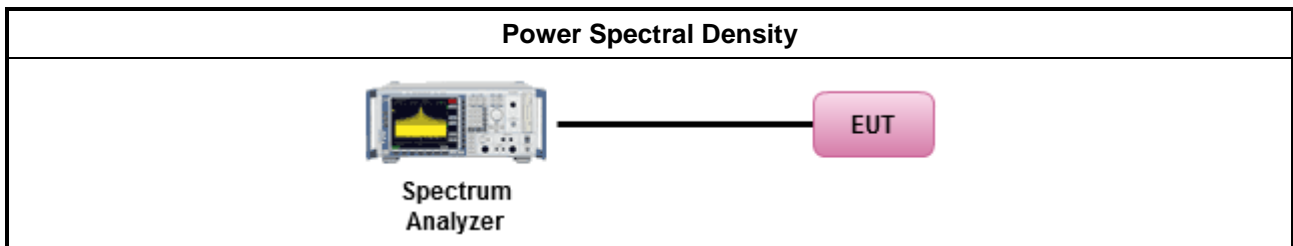

#### 3.4.5 Test Result of Power Spectral Density

Refer as Appendix D

### 3.5 Emissions in Non-restricted Frequency Bands

#### 3.5.1 Emissions in Non-restricted Frequency Bands Limit

Un-restricted Band Emissions Limit	
RF output power procedure	Limit (dB)
Peak output power procedure	20
Average output power procedure	30

Note 1: If the peak output power procedure is used to measure the fundamental emission power to demonstrate compliance to requirements, then the peak conducted output power measured within any 100 kHz outside the authorized frequency band shall be attenuated by at least 20 dB relative to the maximum measured in-band peak PSD level.

Note 2: If the average output power procedure is used to measure the fundamental emission power to demonstrate compliance to requirements, then the power in any 100 kHz outside of the authorized frequency band shall be attenuated by at least 30 dB relative to the maximum measured in-band average PSD level.

#### 3.5.2 Measuring Instruments

Refer a test equipment and calibration data table in this test report.

#### 3.5.3 Test Procedures

Test Method
<ul style="list-style-type: none"> <li>Refer as KDB 558074, clause 8.5 (11.11 of ANSI C63.10) for non-restricted frequency bands.</li> </ul>

#### 3.5.4 Test Setup

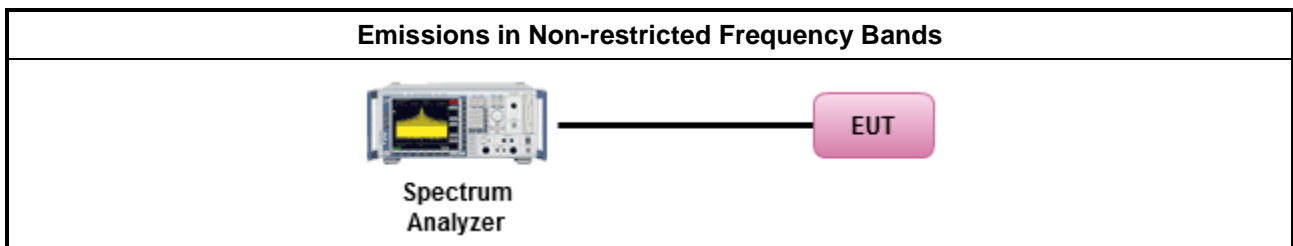

#### 3.5.5 Test Result of Emissions in Non-restricted Frequency Bands

Refer as Appendix E



### 3.6 Emissions in Restricted Frequency Bands

#### 3.6.1 Emissions in Restricted Frequency Bands Limit

Restricted Band Emissions Limit			
Frequency Range (MHz)	Field Strength (uV/m)	Field Strength (dBuV/m)	Measure Distance (m)
0.009~0.490	2400/F(kHz)	48.5 - 13.8	300
0.490~1.705	24000/F(kHz)	33.8 - 23	30
1.705~30.0	30	29	30
30~88	100	40	3
88~216	150	43.5	3
216~960	200	46	3
Above 960	500	54	3

Note 1: Test distance for frequencies at or above 30 MHz, measurements may be performed at a distance other than the limit distance provided they are not performed in the near field and the emissions to be measured can be detected by the measurement equipment. When performing measurements at a distance other than that specified, the results shall be extrapolated to the specified distance using an extrapolation factor of 20 dB/decade (inverse of linear distance for field-strength measurements, inverse of linear distance-squared for power-density measurements).

Note 2: Test distance for frequencies at below 30 MHz, measurements may be performed at a distance closer than the EUT limit distance; however, an attempt should be made to avoid making measurements in the near field. When performing measurements below 30 MHz at a closer distance than the limit distance, the results shall be extrapolated to the specified distance by either making measurements at a minimum of two or more distances on at least one radial to determine the proper extrapolation factor or by using the square of an inverse linear distance extrapolation factor (40 dB/decade). The test report shall specify the extrapolation method used to determine compliance of the EUT.

Note 3: Using the distance of 1m during the test for above 18 GHz, and the test value to correct for the distance factor at 3m.

#### 3.6.2 Measuring Instruments

Refer a test equipment and calibration data table in this test report.



3.6.3 Test Procedures

Test Method	
	<ul style="list-style-type: none"> <li>▪ The average emission levels shall be measured in [duty cycle ≥ 98 or duty factor].</li> </ul>
	<ul style="list-style-type: none"> <li>▪ Refer as ANSI C63.10, clause 6.10.3 band-edge testing shall be performed at the lowest frequency channel and highest frequency channel within the allowed operating band.</li> </ul>
	<ul style="list-style-type: none"> <li>▪ For the transmitter unwanted emissions shall be measured using following options below:</li> </ul>
	<ul style="list-style-type: none"> <li>▪ Refer as KDB 558074, clause 8.6 (11.12 of ANSI C63.10) for restricted frequency bands.</li> </ul>
	<ul style="list-style-type: none"> <li>▪ For the transmitter band-edge emissions shall be measured using following options below:</li> </ul>
	<ul style="list-style-type: none"> <li>▪ Refer as KDB 558074 clause 8.7.1, When the performing peak or average radiated measurements, emissions within 2 MHz of the authorized band edge may be measured using the marker-delta method described below.</li> </ul>
	<ul style="list-style-type: none"> <li>▪ Refer as KDB 558074, clause 8.7.2 (6.10.6 of ANSI C63.10) for marker-delta method for band-edge measurements.</li> </ul>
	<ul style="list-style-type: none"> <li>▪ Refer as KDB 558074, clause 8.7.3 for narrower resolution bandwidth (100kHz) using the band power and summing the spectral levels.</li> </ul>
	<ul style="list-style-type: none"> <li>▪ Use the following spectrum analyzer settings:</li> </ul>
	<ul style="list-style-type: none"> <li>▪ Set RBW=100 kHz for f &lt; 1 GHz; VBW=3 * RBW; Sweep = auto; Detector function = peak; Trace = max hold.</li> </ul>
	<ul style="list-style-type: none"> <li>▪ Set RBW = 1 MHz, VBW= 3MHz for f ≥ 1 GHz for peak measurement. For average measurement, refer as 1.1.4.</li> </ul>
	<ul style="list-style-type: none"> <li>▪ KDB 414788 Open-Field Test Sites and Chamber Correlation Justification.</li> </ul>
	<ul style="list-style-type: none"> <li>▪ Based on FCC 15.31 (f) (2): measurements may be performed at a distance closer than that specified in regulations; however, an attempt should be made to avoid making measurements in the near field.</li> </ul>
	<ul style="list-style-type: none"> <li>▪ Open-field site and chamber correlation testing had been performed and chamber measured test result is the worst case test result.</li> </ul>

### 3.6.4 Test Setup

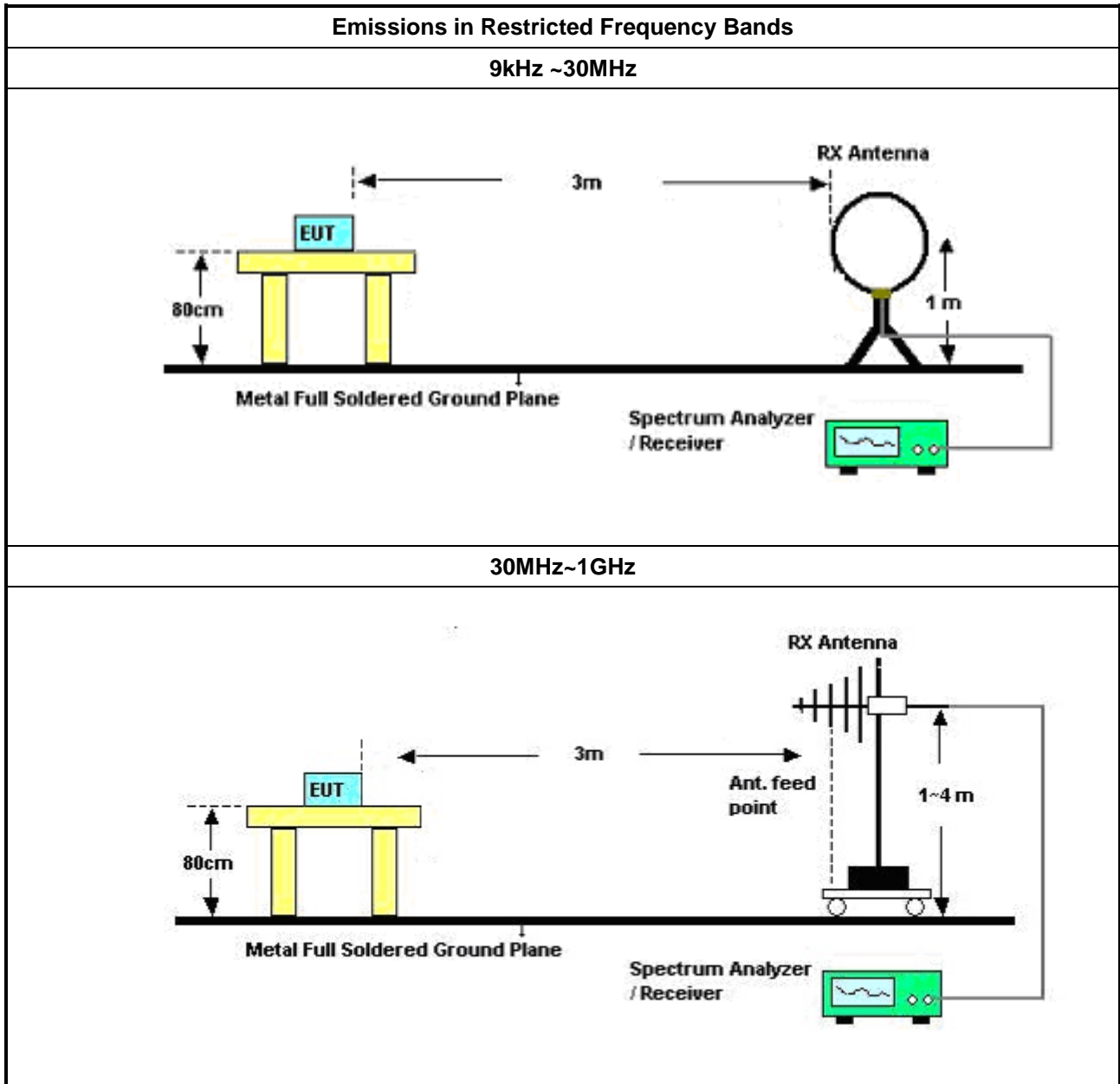



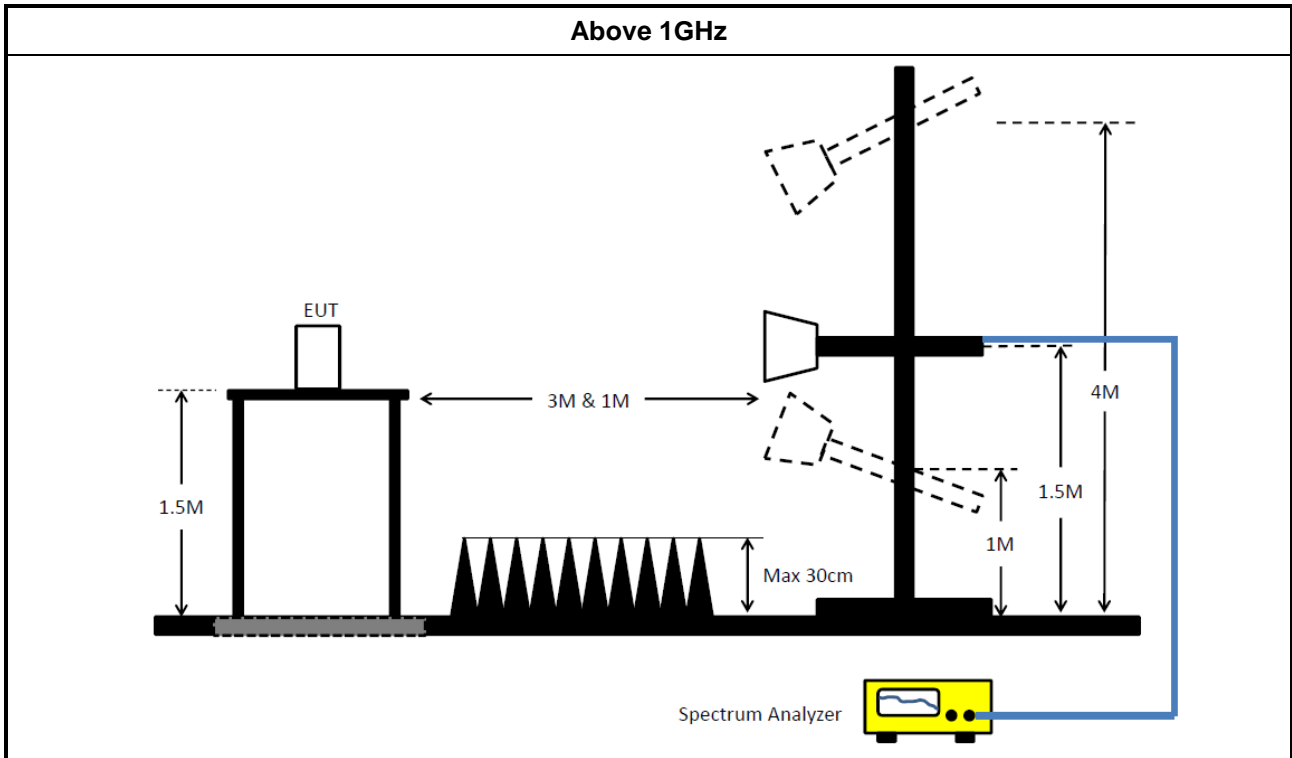

### 3.6.5 Test Result of Emissions in Restricted Frequency Bands

Refer as Appendix F



## 4 Test Equipment and Calibration Data

### Instrument for AC Conduction <Mode 1>

Instrument	Manufacturer	Model No.	Serial No.	Spec.	Calibration Date	Calibration Due Date
EMC Receiver	R&S	ESR	102051	9KHz ~ 3.6GHz	03/May/2018	02/May/2019
LISN	R&S	ENV216	101295	9kHz ~ 30MHz	17/Nov/2017	16/Nov/2018
RF Cable-CON	HUBER+SUHNER	RG213/U	0761183202000 1	9kHz ~ 30MHz	06/Oct/2017	05/Oct/2018
AC POWER	APC	AFC-11005G	F310050055	47Hz~63Hz 5~300V	NCR	NCR
Impuls Begrenzer Puls e Limiter	SCHWARZBEC K	VTSD 9561-F	9561-F041	9 kHz ~ 30 MHz	12/Oct/2017	11/Oct/2018

NCR : Non-Calibration Require

### Instrument for AC Conduction <Mode 2>

Instrument	Manufacturer	Model No.	Serial No.	Spec.	Calibration Date	Calibration Due Date
EMI Test Receiver	R&S	ESR3	102051	9KHz ~ 3.6GHz	28/May/2019	27/May/2020
LISN	R&S	ENV216	101295	9kHz ~ 30MHz	08/Nov/2018	07/Nov/2019
RF Cable-CON	MTJ	RG142	CB002-CO	9kHz ~ 200MHz	12/Sep/2019	11/Sep/2020
Impuls Begrenzer Puls e Limiter	SCHWARZBEC K	VTSD 9561-F	9561-F041	9 kHz ~ 30 MHz	11/Oct/2018	10/Oct/2019
Software	Sporton	SENSE-EMI	V5.10.5	-	NCR	NCR

NCR : Non-Calibration Require

**Instrument for Radiated Test <Mode 1>**

Instrument	Manufacturer	Model No.	Serial No.	Spec.	Calibration Date	Calibration Due Date
3m Semi Anechoic Chamber	SIDT FRANKONIA	SAC-3M	03CH02-HY	30MHz ~ 1GHz 3m	20/Oct/2017	19/Oct/2018
3m Semi Anechoic Chamber	SIDT FRANKONIA	SAC-3M	03CH02-HY	1GHz ~ 18GHz 3m	27/Oct/2017	26/Oct/2018
Amplifier	Agilent	8447D	2944A11149	100kHz ~ 1.3GHz	29Jun/2017	28/Jun/2018
Microwave Preamplifier	Agilent	8449B	3008A02373	1GHz ~ 26.5GHz	28/Sep/2017	27/Sep/2018
Spectrum Analyzer	Rohde & Schwarz	FSP40	100593	9kHz - 40GHz	12/Dec/2017	11/Dec/2018
EMI Test Receiver	Rohde & Schwarz	ESCS 30	100354	9kHz ~ 2.75GHz	08/Dec/2017	07/Dec/2018
RF Cable-R03m	Jye Bao	RG142	CB017	9kHz ~ 1GHz	19/Jan/2018	18/Jan/2019
RF Cable-high	SUHNER	SUCOFLEX104	MY34918/4	1GHz ~ 40GHz	19/Jan/2018	18/Jan/2019
Bilog Antenna	SCHAFFNER	CBL 6112B	2723	30MHz ~ 1GHz	09/Sep/2017	08/Sep/2018
Broadband Horn Antenna	SCHWARZBEC K	BBHA 9170	BBHA 9170154	18GHz ~ 40GHz	06/Feb/2018	05/Feb/2019
Double Ridged Guide Horn Antenna	SCHWARZBEC K	BBHA 9120D	BBHA 9120 D 1543	1GHz ~ 18GHz	11/May/ 2018	10/May/2019
Preamplifier	MITEQ	TTA1840-35-HG	1864481	18GHz ~ 40GHz	31/Aug/2017	30/Aug/2018
Loop Antenna	TESEQ	HLA 6120	31244	9k-30MHz	29/Mar/2018	28/Mar/2019



**Instrument for Radiated Test <Mode 2>**

Instrument	Manufacturer	Model No.	Serial No.	Spec.	Calibration Date	Calibration Due Date
Open Area Test Site	SPORTON	OATS-10	OS03-LK	30 MHz ~ 1 GHz 10m, 3m	15/Apr/2019	14/Apr/2020
Amplifier	HP	8447D	2944A09068	0.1MHz ~ 1.3GHz	20/Dec/2018	19/Dec/2019
Spectrum Analyzer	R&S	FSP	100641	9 kHz ~ 30 GHz	23/Jul/2019	22/Jul/2020
Test Receiver	R&S	ESCS 30	100168	9 kHz ~ 2.75 GHz	12/Dec/2018	11/Dec/2019
Bilog Antenna with 5dB Attenuator	TESEQ & WOKEN	CBL6112D & 00800N1D01N-05	25236 & 007	30 MHz ~ 1 GHz	06/Jul/2019	05/Jul/2020
Turn Table	EMCO	2080	9711-2021	0 ~ 360 degree	NCR	NCR
Antenna Mast	EMCO	2075	9711-2115	1 m ~ 4 m	NCR	NCR
RF Cable-R10m	Woken	CFD400E-LW	OS03-2500	30 MHz ~ 1 GHz	15/May/2019	14/May/2020
Software	Audix	E3	Version:4	-	NCR	NCR

NCR : Non-Calibration Require

**Instrument for Conducted Test**

Instrument	Manufacturer	Model No.	Serial No.	Spec.	Calibration Date	Calibration Due Date
Spectrum Analyzer	R&S	FSV 40	101515	9kHz~40GHz	08/Dec/2017	07/Dec/2018
Power Sensor	Anritsu	MA2411B	1339407	300MHz ~ 40GHz	06/Nov/2017	05/Nov/2018
Power Meter	Anritsu	ML2495A	1517010	300MHz ~ 40GHz	06/Nov/2017	05/Nov/2018
RF Cable-0.2m	HUBER+SUHNER	SUCOFLEX_104	MY10710/4	30MHz ~ 26.5GHz	25/Aug/2017	24/Aug/2018
RF Cable-0.2m	HUBER+SUHNER	SUCOFLEX_104	MY10709/4	30MHz ~ 26.5GHz	25/Aug/2017	24/Aug/2018
RF Cable-1m	HUBER+SUHNER	SUCOFLEX_104	MY37333/4	30MHz ~ 26.5GHz	26/Jan/2018	25/Jan/2019
Signal Generator	R&S	SMR40	100116	10MHz ~ 40GHz	27/Jul/2017	26/Jul/2018



AC Power-line Conducted Emissions Result																																																																																																																																	
Operating Mode	1	Power Phase	Neutral																																																																																																																														
Operating Function	Adapter mode - TX																																																																																																																																
<div style="display: flex; justify-content: space-between;"> <div> </div> <div style="text-align: right;">Date: 2018-07-25</div> </div>																																																																																																																																	
<table border="1" style="width: 100%; border-collapse: collapse;"> <thead> <tr> <th></th> <th>Freq</th> <th>Level</th> <th>Over Limit</th> <th>Limit Line</th> <th>Read Level</th> <th>LISN Factor</th> <th>Cable Loss</th> <th>Remark</th> </tr> <tr> <th></th> <th>MHz</th> <th>dBuV</th> <th>dB</th> <th>dBuV</th> <th>dBuV</th> <th>dB</th> <th>dB</th> <th></th> </tr> </thead> <tbody> <tr> <td>1</td> <td>0.31</td> <td>27.10</td> <td>-22.78</td> <td>49.88</td> <td>17.43</td> <td>9.61</td> <td>0.06</td> <td>Average</td> </tr> <tr> <td>2</td> <td>0.31</td> <td>37.04</td> <td>-22.84</td> <td>59.88</td> <td>27.37</td> <td>9.61</td> <td>0.06</td> <td>QP</td> </tr> <tr style="background-color: #e0e0e0;"> <td>3</td> <td>0.48</td> <td>34.57</td> <td>-11.70</td> <td>46.27</td> <td>24.88</td> <td>9.61</td> <td>0.08</td> <td>Average</td> </tr> <tr> <td>4</td> <td>0.48</td> <td>43.22</td> <td>-13.05</td> <td>56.27</td> <td>33.53</td> <td>9.61</td> <td>0.08</td> <td>QP</td> </tr> <tr> <td>5</td> <td>1.27</td> <td>26.30</td> <td>-19.70</td> <td>46.00</td> <td>16.68</td> <td>9.62</td> <td>0.00</td> <td>Average</td> </tr> <tr> <td>6</td> <td>1.27</td> <td>36.02</td> <td>-19.98</td> <td>56.00</td> <td>26.40</td> <td>9.62</td> <td>0.00</td> <td>QP</td> </tr> <tr> <td>7</td> <td>2.03</td> <td>24.36</td> <td>-21.64</td> <td>46.00</td> <td>14.73</td> <td>9.63</td> <td>0.00</td> <td>Average</td> </tr> <tr> <td>8</td> <td>2.03</td> <td>36.22</td> <td>-19.78</td> <td>56.00</td> <td>26.59</td> <td>9.63</td> <td>0.00</td> <td>QP</td> </tr> <tr> <td>9</td> <td>3.60</td> <td>23.83</td> <td>-22.17</td> <td>46.00</td> <td>14.12</td> <td>9.64</td> <td>0.07</td> <td>Average</td> </tr> <tr> <td>10</td> <td>3.60</td> <td>34.95</td> <td>-21.05</td> <td>56.00</td> <td>25.24</td> <td>9.64</td> <td>0.07</td> <td>QP</td> </tr> <tr> <td>11</td> <td>5.28</td> <td>22.08</td> <td>-27.92</td> <td>50.00</td> <td>12.30</td> <td>9.66</td> <td>0.12</td> <td>Average</td> </tr> <tr> <td>12</td> <td>5.28</td> <td>32.61</td> <td>-27.39</td> <td>60.00</td> <td>22.83</td> <td>9.66</td> <td>0.12</td> <td>QP</td> </tr> </tbody> </table>					Freq	Level	Over Limit	Limit Line	Read Level	LISN Factor	Cable Loss	Remark		MHz	dBuV	dB	dBuV	dBuV	dB	dB		1	0.31	27.10	-22.78	49.88	17.43	9.61	0.06	Average	2	0.31	37.04	-22.84	59.88	27.37	9.61	0.06	QP	3	0.48	34.57	-11.70	46.27	24.88	9.61	0.08	Average	4	0.48	43.22	-13.05	56.27	33.53	9.61	0.08	QP	5	1.27	26.30	-19.70	46.00	16.68	9.62	0.00	Average	6	1.27	36.02	-19.98	56.00	26.40	9.62	0.00	QP	7	2.03	24.36	-21.64	46.00	14.73	9.63	0.00	Average	8	2.03	36.22	-19.78	56.00	26.59	9.63	0.00	QP	9	3.60	23.83	-22.17	46.00	14.12	9.64	0.07	Average	10	3.60	34.95	-21.05	56.00	25.24	9.64	0.07	QP	11	5.28	22.08	-27.92	50.00	12.30	9.66	0.12	Average	12	5.28	32.61	-27.39	60.00	22.83	9.66	0.12	QP
	Freq	Level	Over Limit	Limit Line	Read Level	LISN Factor	Cable Loss	Remark																																																																																																																									
	MHz	dBuV	dB	dBuV	dBuV	dB	dB																																																																																																																										
1	0.31	27.10	-22.78	49.88	17.43	9.61	0.06	Average																																																																																																																									
2	0.31	37.04	-22.84	59.88	27.37	9.61	0.06	QP																																																																																																																									
3	0.48	34.57	-11.70	46.27	24.88	9.61	0.08	Average																																																																																																																									
4	0.48	43.22	-13.05	56.27	33.53	9.61	0.08	QP																																																																																																																									
5	1.27	26.30	-19.70	46.00	16.68	9.62	0.00	Average																																																																																																																									
6	1.27	36.02	-19.98	56.00	26.40	9.62	0.00	QP																																																																																																																									
7	2.03	24.36	-21.64	46.00	14.73	9.63	0.00	Average																																																																																																																									
8	2.03	36.22	-19.78	56.00	26.59	9.63	0.00	QP																																																																																																																									
9	3.60	23.83	-22.17	46.00	14.12	9.64	0.07	Average																																																																																																																									
10	3.60	34.95	-21.05	56.00	25.24	9.64	0.07	QP																																																																																																																									
11	5.28	22.08	-27.92	50.00	12.30	9.66	0.12	Average																																																																																																																									
12	5.28	32.61	-27.39	60.00	22.83	9.66	0.12	QP																																																																																																																									
<p>Note 1: "&gt;20dB" means emission levels that exceed the level of 20 dB below the applicable limit.            Note 2: "N/F" means Nothing Found emissions (No emissions were detected.)</p>																																																																																																																																	



AC Power-line Conducted Emissions Result																																																																																																																																	
Operating Mode	1	Power Phase	Line																																																																																																																														
Operating Function	Adapter mode - TX																																																																																																																																
<div style="display: flex; justify-content: space-between;"> <div> </div> <div style="text-align: right;">Date: 2018-07-25</div> </div>																																																																																																																																	
<table border="1" style="width: 100%; border-collapse: collapse; margin-top: 10px;"> <thead> <tr> <th></th> <th>Freq</th> <th>Level</th> <th>Over Limit</th> <th>Limit Line</th> <th>Read Level</th> <th>LISN Factor</th> <th>Cable Loss</th> <th>Remark</th> </tr> <tr> <th></th> <th>MHz</th> <th>dBuV</th> <th>dB</th> <th>dBuV</th> <th>dBuV</th> <th>dB</th> <th>dB</th> <th></th> </tr> </thead> <tbody> <tr> <td>1</td> <td>0.19</td> <td>19.96</td> <td>-33.88</td> <td>53.84</td> <td>10.34</td> <td>9.62</td> <td>0.00</td> <td>Average</td> </tr> <tr> <td>2</td> <td>0.19</td> <td>32.26</td> <td>-31.58</td> <td>63.84</td> <td>22.64</td> <td>9.62</td> <td>0.00</td> <td>QP</td> </tr> <tr> <td>3 MAX</td> <td>0.48</td> <td>26.49</td> <td>-19.78</td> <td>46.27</td> <td>16.80</td> <td>9.61</td> <td>0.08</td> <td>Average</td> </tr> <tr> <td>4</td> <td>0.48</td> <td>36.36</td> <td>-19.91</td> <td>56.27</td> <td>26.67</td> <td>9.61</td> <td>0.08</td> <td>QP</td> </tr> <tr> <td>5</td> <td>0.95</td> <td>18.28</td> <td>-27.72</td> <td>46.00</td> <td>8.66</td> <td>9.61</td> <td>0.01</td> <td>Average</td> </tr> <tr> <td>6</td> <td>0.95</td> <td>28.72</td> <td>-27.28</td> <td>56.00</td> <td>19.10</td> <td>9.61</td> <td>0.01</td> <td>QP</td> </tr> <tr> <td>7</td> <td>2.62</td> <td>16.88</td> <td>-29.12</td> <td>46.00</td> <td>7.23</td> <td>9.62</td> <td>0.03</td> <td>Average</td> </tr> <tr> <td>8</td> <td>2.62</td> <td>26.46</td> <td>-29.54</td> <td>56.00</td> <td>16.81</td> <td>9.62</td> <td>0.03</td> <td>QP</td> </tr> <tr> <td>9</td> <td>4.41</td> <td>17.77</td> <td>-28.23</td> <td>46.00</td> <td>8.04</td> <td>9.63</td> <td>0.10</td> <td>Average</td> </tr> <tr> <td>10</td> <td>4.41</td> <td>26.00</td> <td>-30.00</td> <td>56.00</td> <td>16.27</td> <td>9.63</td> <td>0.10</td> <td>QP</td> </tr> <tr> <td>11</td> <td>10.90</td> <td>17.39</td> <td>-32.61</td> <td>50.00</td> <td>7.58</td> <td>9.66</td> <td>0.15</td> <td>Average</td> </tr> <tr> <td>12</td> <td>10.90</td> <td>26.53</td> <td>-33.47</td> <td>60.00</td> <td>16.72</td> <td>9.66</td> <td>0.15</td> <td>QP</td> </tr> </tbody> </table>					Freq	Level	Over Limit	Limit Line	Read Level	LISN Factor	Cable Loss	Remark		MHz	dBuV	dB	dBuV	dBuV	dB	dB		1	0.19	19.96	-33.88	53.84	10.34	9.62	0.00	Average	2	0.19	32.26	-31.58	63.84	22.64	9.62	0.00	QP	3 MAX	0.48	26.49	-19.78	46.27	16.80	9.61	0.08	Average	4	0.48	36.36	-19.91	56.27	26.67	9.61	0.08	QP	5	0.95	18.28	-27.72	46.00	8.66	9.61	0.01	Average	6	0.95	28.72	-27.28	56.00	19.10	9.61	0.01	QP	7	2.62	16.88	-29.12	46.00	7.23	9.62	0.03	Average	8	2.62	26.46	-29.54	56.00	16.81	9.62	0.03	QP	9	4.41	17.77	-28.23	46.00	8.04	9.63	0.10	Average	10	4.41	26.00	-30.00	56.00	16.27	9.63	0.10	QP	11	10.90	17.39	-32.61	50.00	7.58	9.66	0.15	Average	12	10.90	26.53	-33.47	60.00	16.72	9.66	0.15	QP
	Freq	Level	Over Limit	Limit Line	Read Level	LISN Factor	Cable Loss	Remark																																																																																																																									
	MHz	dBuV	dB	dBuV	dBuV	dB	dB																																																																																																																										
1	0.19	19.96	-33.88	53.84	10.34	9.62	0.00	Average																																																																																																																									
2	0.19	32.26	-31.58	63.84	22.64	9.62	0.00	QP																																																																																																																									
3 MAX	0.48	26.49	-19.78	46.27	16.80	9.61	0.08	Average																																																																																																																									
4	0.48	36.36	-19.91	56.27	26.67	9.61	0.08	QP																																																																																																																									
5	0.95	18.28	-27.72	46.00	8.66	9.61	0.01	Average																																																																																																																									
6	0.95	28.72	-27.28	56.00	19.10	9.61	0.01	QP																																																																																																																									
7	2.62	16.88	-29.12	46.00	7.23	9.62	0.03	Average																																																																																																																									
8	2.62	26.46	-29.54	56.00	16.81	9.62	0.03	QP																																																																																																																									
9	4.41	17.77	-28.23	46.00	8.04	9.63	0.10	Average																																																																																																																									
10	4.41	26.00	-30.00	56.00	16.27	9.63	0.10	QP																																																																																																																									
11	10.90	17.39	-32.61	50.00	7.58	9.66	0.15	Average																																																																																																																									
12	10.90	26.53	-33.47	60.00	16.72	9.66	0.15	QP																																																																																																																									
<p>Note 1: "&gt;20dB" means emission levels that exceed the level of 20 dB below the applicable limit.            Note 2: "N/F" means Nothing Found emissions (No emissions were detected.)</p>																																																																																																																																	



AC Power-line Conducted Emissions Result

Operating Mode	2	Power Phase	Neutral
Operating Function	PoE Adapter mode - TX		

23/09/2019

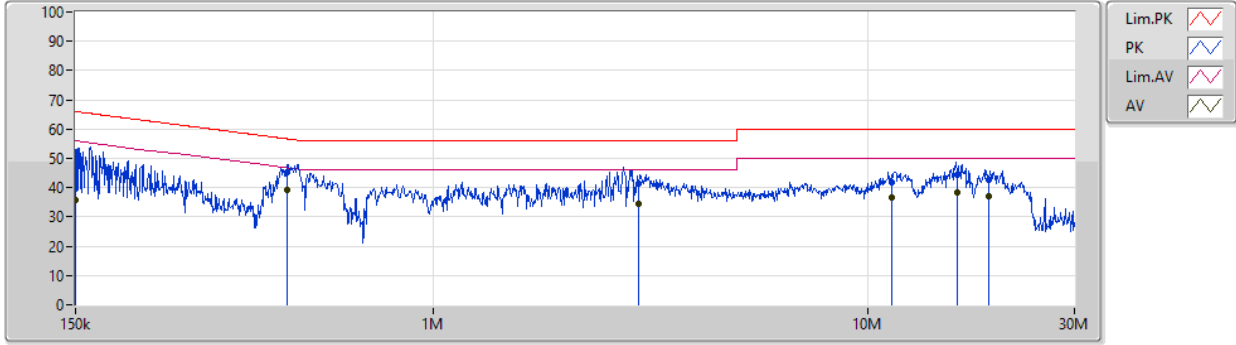

Type	Freq (Hz)	Level (dBuV)	Limit (dBuV)	Margin (dB)	Factor (dB)	Condition	Comment	Raw (dBuV)	LISN (dB)	CL (dB)	AT (dB)
QP	150.05k	51.94	66.00	-14.06	19.48	Neutral	-	32.46	9.60	0.01	9.87
AV	150.05k	35.67	56.00	-20.33	19.48	Neutral	-	16.19	9.60	0.01	9.87
QP	462.337k	45.33	56.65	-11.32	19.48	Neutral	-	25.85	9.59	0.01	9.88
AV	462.337k	40.18	46.65	-6.47	19.48	Neutral	"Worst"	20.70	9.59	0.01	9.88
QP	2.964M	41.25	56.00	-14.75	19.54	Neutral	-	21.71	9.61	0.04	9.89
AV	2.964M	34.31	46.00	-11.69	19.54	Neutral	-	14.77	9.61	0.04	9.89
QP	11.361M	41.62	60.00	-18.38	19.64	Neutral	-	21.98	9.67	0.08	9.89
AV	11.361M	36.48	50.00	-13.52	19.64	Neutral	-	16.84	9.67	0.08	9.89
QP	16.166M	44.54	60.00	-15.46	19.68	Neutral	-	24.86	9.68	0.10	9.90
AV	16.166M	38.15	50.00	-11.85	19.68	Neutral	-	18.47	9.68	0.10	9.90
QP	19.003M	42.56	60.00	-17.44	19.69	Neutral	-	22.87	9.68	0.11	9.90
AV	19.003M	37.01	50.00	-12.99	19.69	Neutral	-	17.32	9.68	0.11	9.90



AC Power-line Conducted Emissions Result

Operating Mode	2	Power Phase	Line
Operating Function	PoE Adapter mode - TX		

23/09/2019

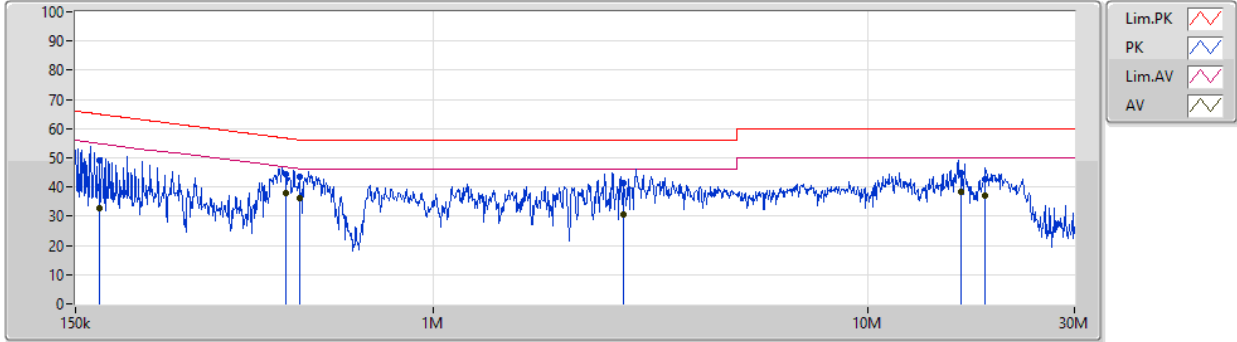

Type	Freq (Hz)	Level (dBuV)	Limit (dBuV)	Margin (dB)	Factor (dB)	Condition	Comment	Raw (dBuV)	LISN (dB)	CL (dB)	AT (dB)
QP	170.81k	49.01	64.91	-15.90	19.48	Line	-	29.53	9.60	0.01	9.87
AV	170.81k	32.94	54.91	-21.97	19.48	Line	-	13.46	9.60	0.01	9.87
QP	458.311k	44.35	56.73	-12.38	19.48	Line	-	24.87	9.59	0.01	9.88
AV	458.311k	37.73	46.73	-9.00	19.48	Line	"Worst"	18.25	9.59	0.01	9.88
QP	493.042k	43.55	56.11	-12.56	19.48	Line	-	24.07	9.59	0.01	9.88
AV	493.042k	36.13	46.11	-9.98	19.48	Line	-	16.65	9.59	0.01	9.88
QP	2.748M	41.26	56.00	-14.74	19.55	Line	-	21.71	9.62	0.04	9.89
AV	2.748M	30.65	46.00	-15.35	19.55	Line	-	11.10	9.62	0.04	9.89
QP	16.421M	44.64	60.00	-15.36	19.64	Line	-	25.00	9.64	0.10	9.90
AV	16.421M	38.21	50.00	-11.79	19.64	Line	-	18.57	9.64	0.10	9.90
QP	18.629M	42.50	60.00	-17.50	19.64	Line	-	22.86	9.63	0.11	9.90
AV	18.629M	37.00	50.00	-13.00	19.64	Line	-	17.36	9.63	0.11	9.90





**Summary**

Mode	Max-N dB (Hz)	Max-OBW (Hz)	ITU-Code	Min-N dB (Hz)	Min-OBW (Hz)
2.4-2.4835GHz	-	-	-	-	-
802.11b_Nss1,(1Mbps)_1TX	9M	14.718M	14M7G1D	7.55M	12.919M
802.11g_Nss1,(6Mbps)_1TX	15.675M	17.166M	17M2D1D	14.65M	16.342M
802.11n HT20_Nss1,(MCS0)_1TX	15.075M	18.041M	18M0D1D	14.05M	17.516M

**Max-N dB** = Maximum 6dB down bandwidth; **Max-OBW** = Maximum 99% occupied bandwidth;  
**Min-N dB** = Minimum 6dB down bandwidth; **Min-OBW** = Minimum 99% occupied bandwidth;

**Result**

Mode	Result	Limit (Hz)	Port 1-N dB (Hz)	Port 1-OBW (Hz)
802.11b_Nss1,(1Mbps)_1TX	-	-	-	-
2412MHz_TnomVnom	Pass	500k	9M	14.718M
2437MHz_TnomVnom	Pass	500k	8.025M	13.168M
2462MHz_TnomVnom	Pass	500k	7.55M	12.919M
802.11g_Nss1,(6Mbps)_1TX	-	-	-	-
2412MHz_TnomVnom	Pass	500k	15.1M	16.367M
2437MHz_TnomVnom	Pass	500k	15.675M	17.166M
2462MHz_TnomVnom	Pass	500k	14.65M	16.342M
802.11n HT20_Nss1,(MCS0)_1TX	-	-	-	-
2412MHz_TnomVnom	Pass	500k	14.175M	17.516M
2437MHz_TnomVnom	Pass	500k	14.05M	18.041M
2462MHz_TnomVnom	Pass	500k	15.075M	17.516M

**Port X-N dB** = Port X 6dB down bandwidth; **Port X-OBW** = Port X 99% occupied bandwidth;

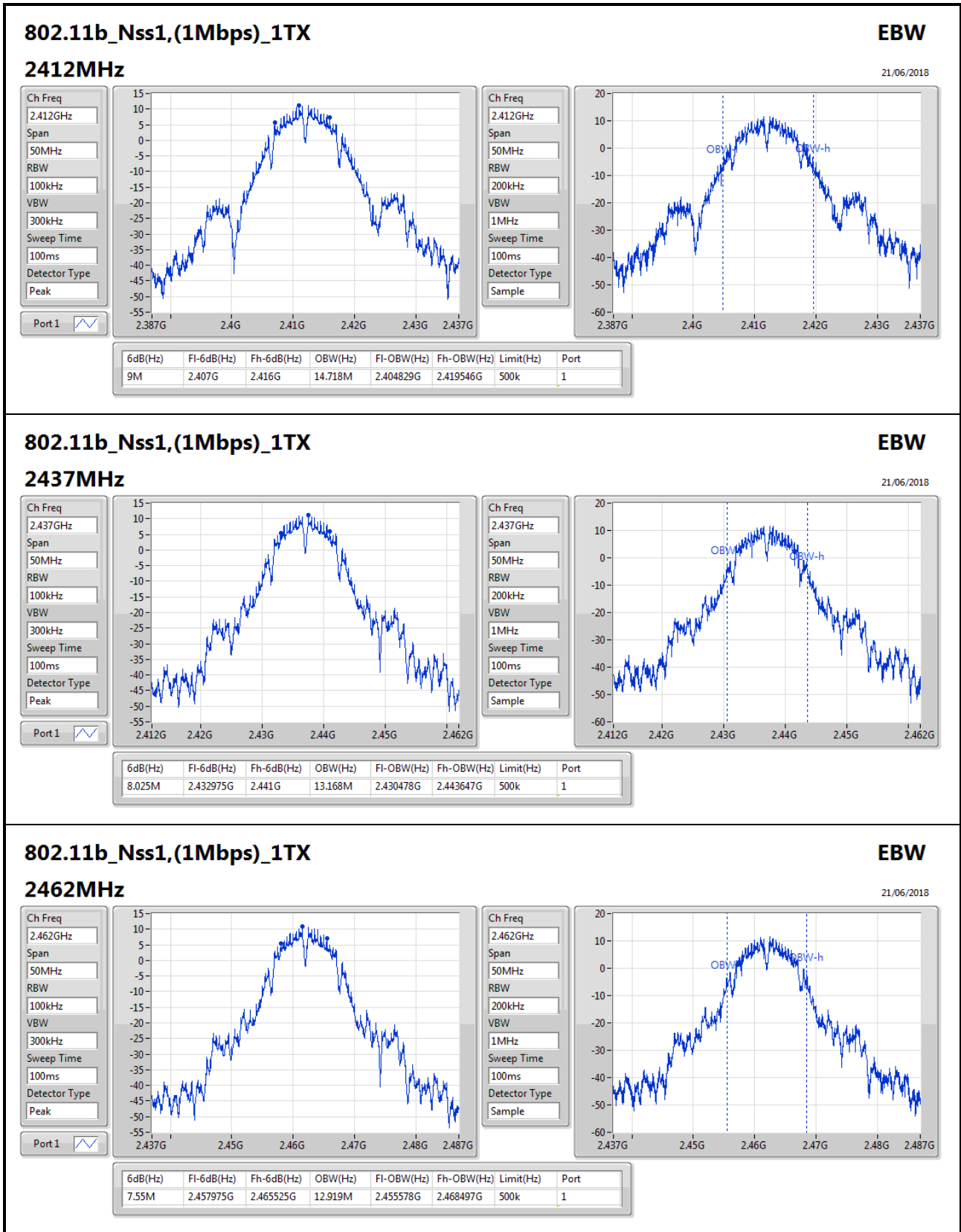

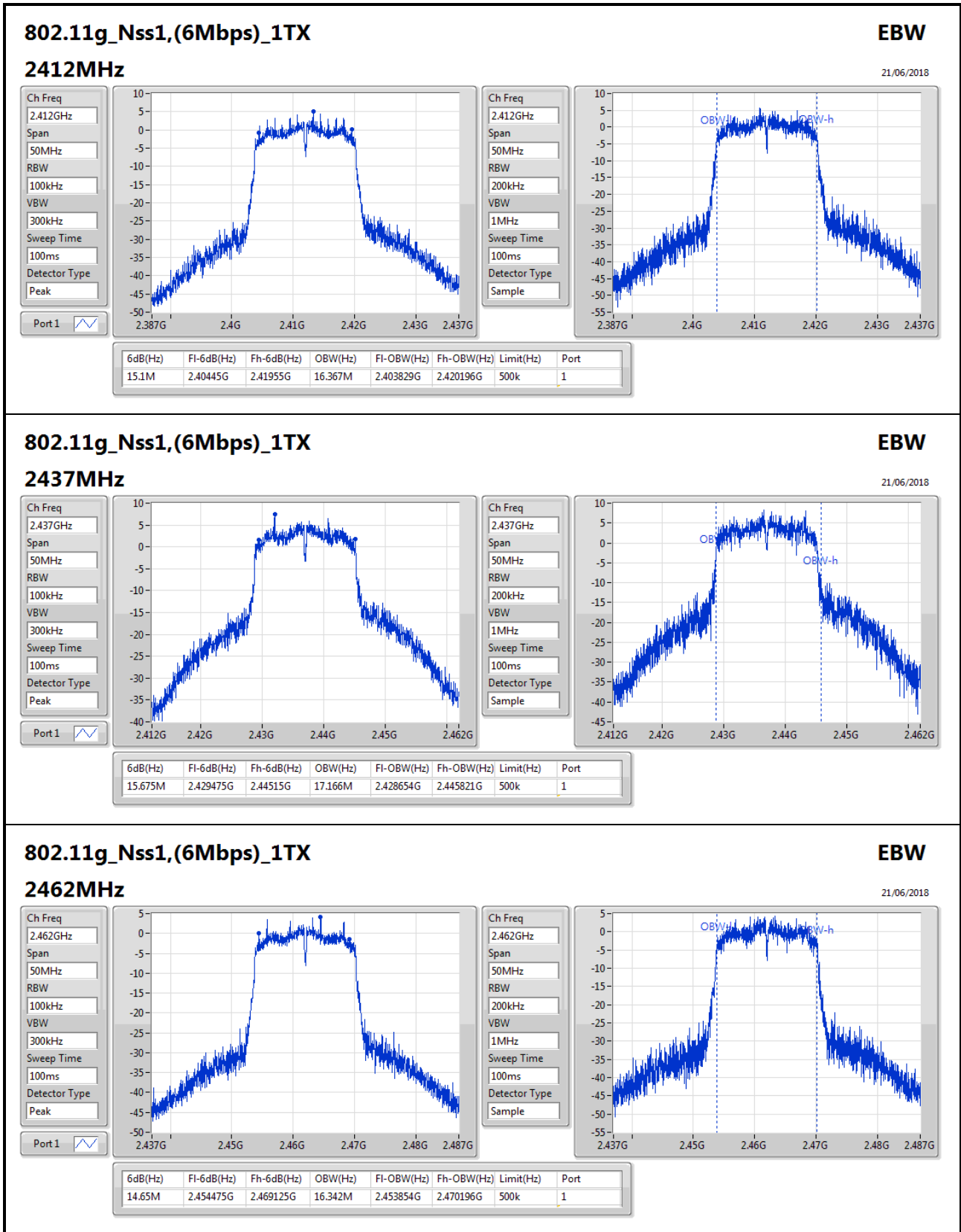

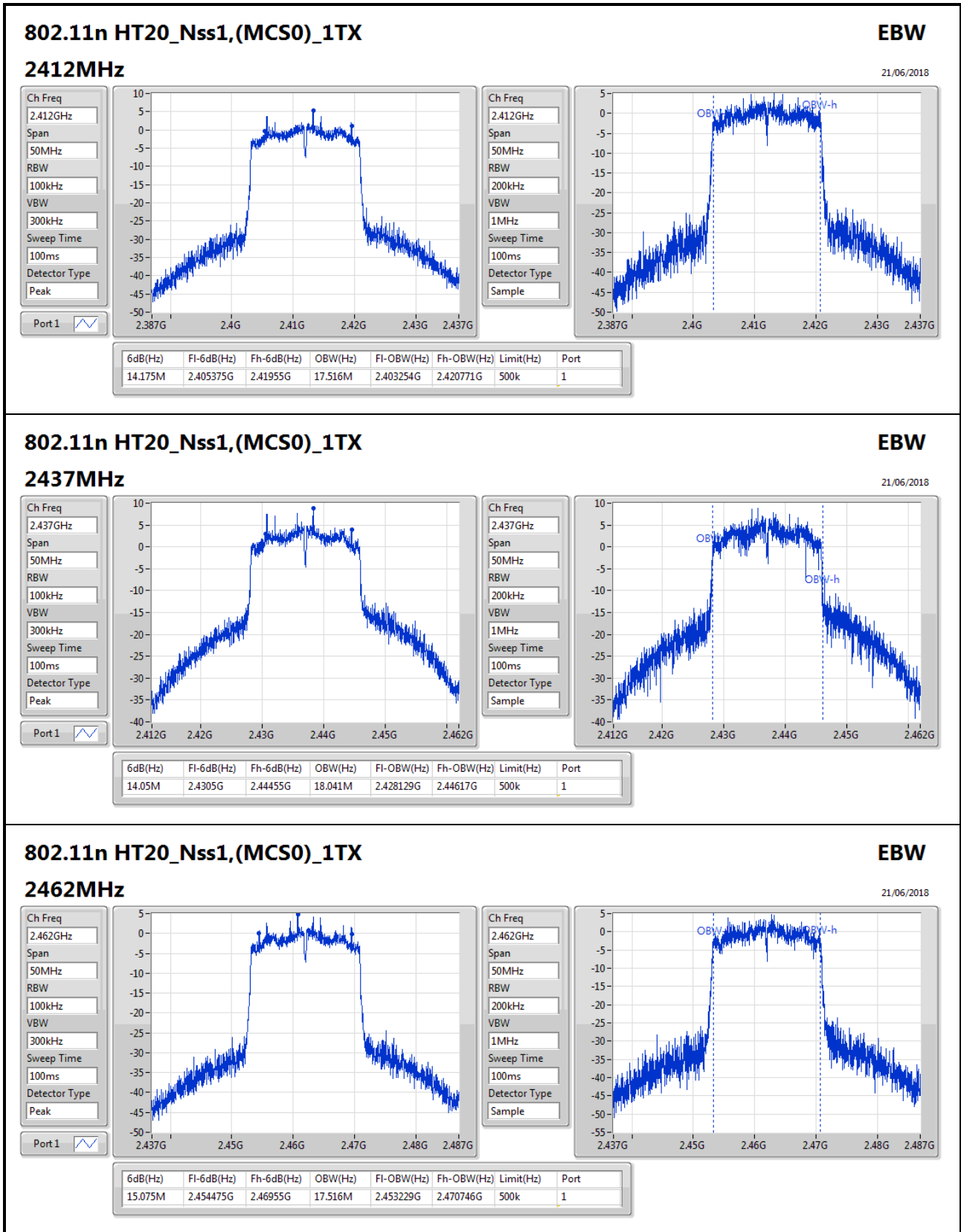



**Summary**

Mode	Total Power (dBm)	Total Power (W)
2.4-2.4835GHz	-	-
802.11b_Nss1,(1Mbps)_1TX	19.75	0.09441
802.11g_Nss1,(6Mbps)_1TX	18.63	0.07295
802.11n HT20_Nss1,(MCS0)_1TX	18.55	0.07161

**Result**

Mode	Result	DG (dBi)	Port 1 (dBm)	Total Power (dBm)	Power Limit (dBm)
802.11b_Nss1,(1Mbps)_1TX	-	-	-	-	-
2412MHz_TnomVnom	Pass	0.94	19.75	19.75	30.00
2437MHz_TnomVnom	Pass	0.69	19.50	19.50	30.00
2462MHz_TnomVnom	Pass	0.69	19.00	19.00	30.00
802.11g_Nss1,(6Mbps)_1TX	-	-	-	-	-
2412MHz_TnomVnom	Pass	0.94	15.20	15.20	30.00
2417MHz_TnomVnom	Pass	0.94	18.63	18.63	30.00
2437MHz_TnomVnom	Pass	0.69	18.41	18.41	30.00
2457MHz_TnomVnom	Pass	0.69	18.14	18.14	30.00
2462MHz_TnomVnom	Pass	0.69	15.01	15.01	30.00
802.11n HT20_Nss1,(MCS0)_1TX	-	-	-	-	-
2412MHz_TnomVnom	Pass	0.94	15.12	15.12	30.00
2417MHz_TnomVnom	Pass	0.94	17.64	17.64	30.00
2422MHz_TnomVnom	Pass	0.94	18.55	18.55	30.00
2437MHz_TnomVnom	Pass	0.69	18.42	18.42	30.00
2457MHz_TnomVnom	Pass	0.69	18.04	18.04	30.00
2462MHz_TnomVnom	Pass	0.69	14.90	14.90	30.00

DG = Directional Gain; Port X = Port X output power

Note : Conducted average output power is for reference only



**Summary**

Mode	PD (dBm/RBW)
2.4-2.4835GHz	-
802.11b_Nss1,(1Mbps)_1TX	-2.51
802.11g_Nss1,(6Mbps)_1TX	-7.39
802.11n HT20_Nss1,(MCS0)_1TX	-6.72

RBW=3kHz.

**Result**

Mode	Result	DG (dBi)	Port 1 (dBm/RBW)	PD (dBm/RBW)	PD Limit (dBm/RBW)
802.11b_Nss1,(1Mbps)_1TX	-	-	-	-	-
2412MHz_TnomVnom	Pass	0.94	-2.51	-2.51	8.00
2437MHz_TnomVnom	Pass	0.69	-3.27	-3.27	8.00
2462MHz_TnomVnom	Pass	0.69	-4.43	-4.43	8.00
802.11g_Nss1,(6Mbps)_1TX	-	-	-	-	-
2412MHz_TnomVnom	Pass	0.94	-9.44	-9.44	8.00
2437MHz_TnomVnom	Pass	0.69	-7.39	-7.39	8.00
2462MHz_TnomVnom	Pass	0.69	-9.81	-9.81	8.00
802.11n HT20_Nss1,(MCS0)_1TX	-	-	-	-	-
2412MHz_TnomVnom	Pass	0.94	-9.73	-9.73	8.00
2437MHz_TnomVnom	Pass	0.69	-6.72	-6.72	8.00
2462MHz_TnomVnom	Pass	0.69	-9.77	-9.77	8.00

DG = Directional Gain; RBW=3kHz;

PD = trace bin-by-bin of each transmits port summing can be performed maximum power density; **Port X** = Port Xpower density;

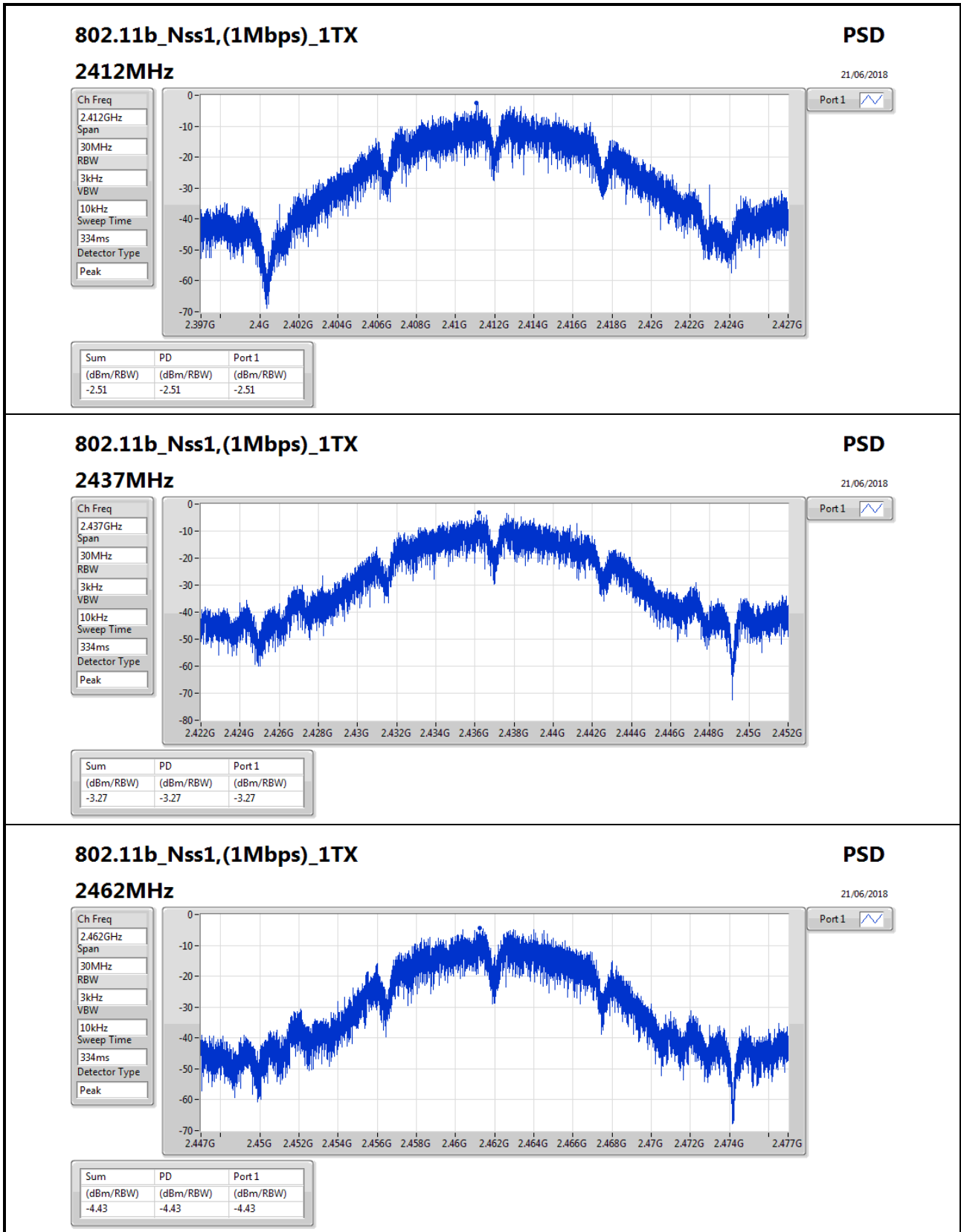

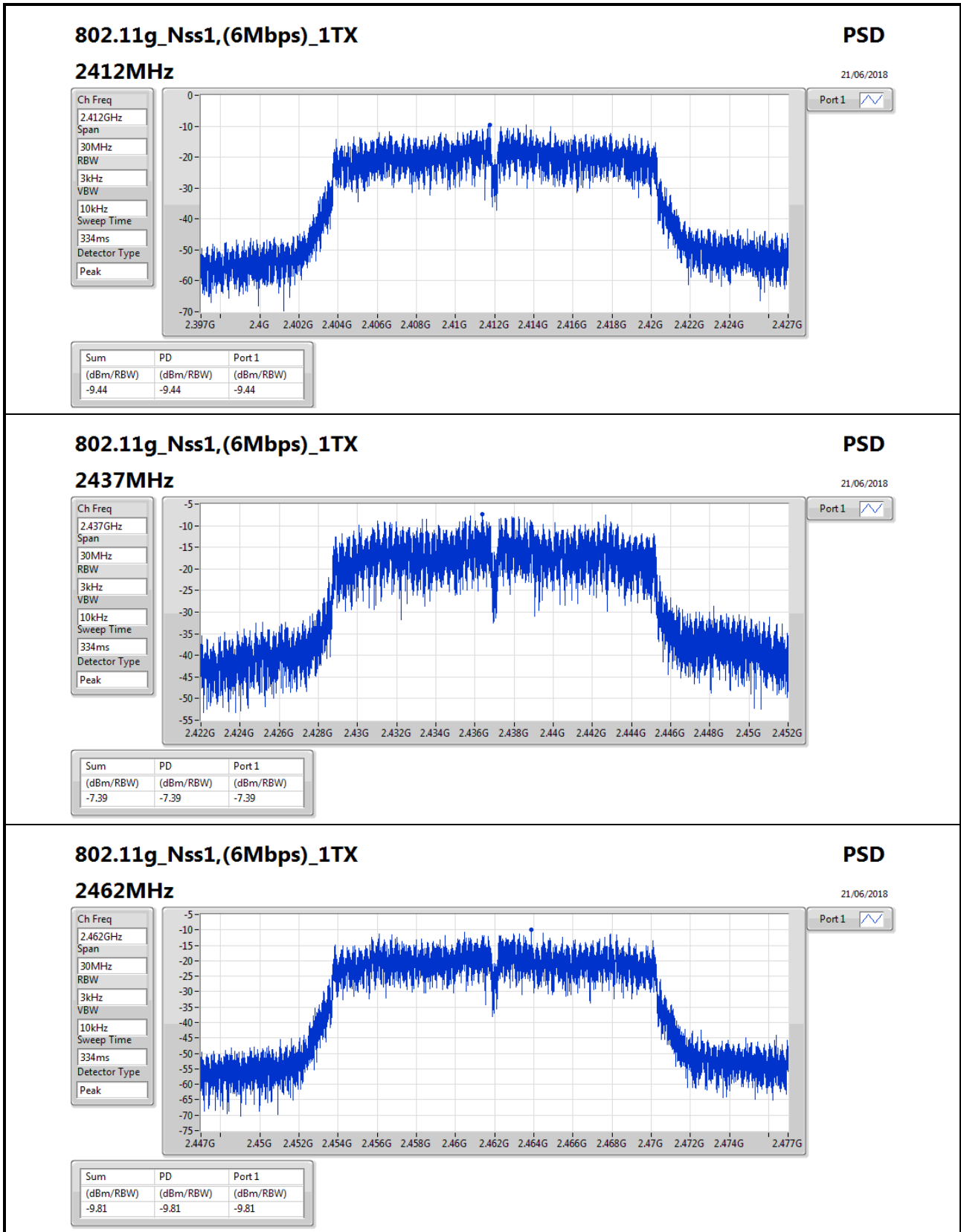



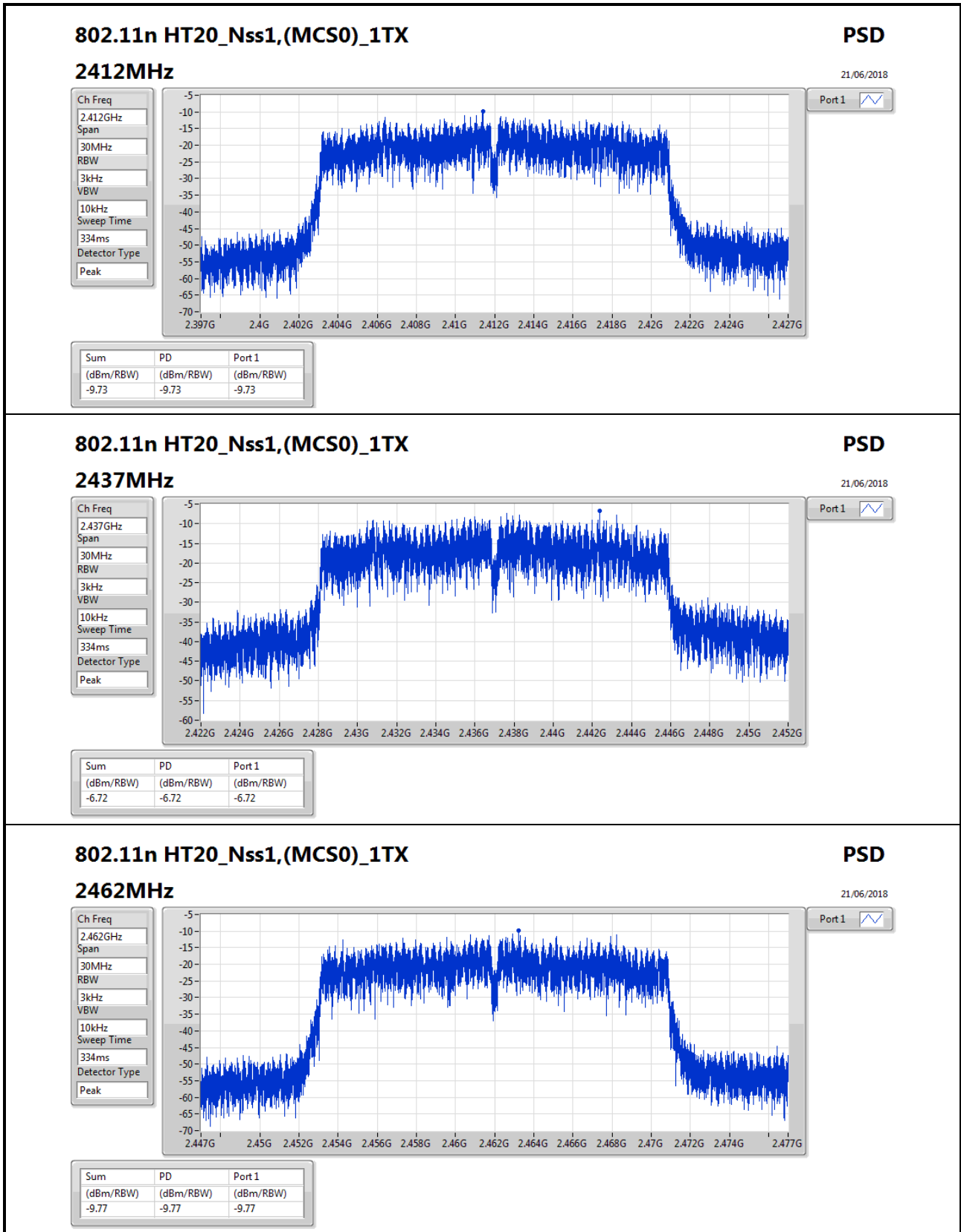

### 802.11n HT20\_Nss1,(MCS0)\_1TX

#### 2462MHz

PSD

21/06/2018

Ch Freq

2.462GHz

Span

30MHz

RBW

3kHz

VBW

10kHz

Sweep Time

334ms

Detector Type

Peak



Port 1

Sum	PD	Port 1
(dBm/RBW)	(dBm/RBW)	(dBm/RBW)
-9.77	-9.77	-9.77



Summary

Mode	Result	Ref (Hz)	Ref (dBm)	Limit (dBm)	Freq (Hz)	Level (dBm)	Freq (Hz)	Level (dBm)	Freq (Hz)	Level (dBm)	Freq (Hz)	Level (dBm)	Port
2.4-2.4835GHz	-	-	-	-	-	-	-	-	-	-	-	-	-
802.11b_Nss1,(1Mbps)_1TX	Pass	2.410855G	10.95	-19.05	147.665M	-37.53	2.39752G	-20.51	2.49222G	-54.22	7.235136G	-51.97	1
802.11g_Nss1,(6Mbps)_1TX	Pass	2.438243G	8.93	-21.07	147.665M	-37.61	2.3992G	-25.19	2.48646G	-54.58	24.730282G	-52.25	1
802.11n HT20_Nss1,(MCS0)_1TX	Pass	2.439579G	6.80	-23.20	147.665M	-37.66	2.39952G	-27.10	2.49102G	-54.77	16.694933G	-53.03	1

Result

Mode	Result	Ref (Hz)	Ref (dBm)	Limit (dBm)	Freq (Hz)	Level (dBm)	Freq (Hz)	Level (dBm)	Freq (Hz)	Level (dBm)	Freq (Hz)	Level (dBm)	Port
802.11b_Nss1,(1Mbps)_1TX	-	-	-	-	-	-	-	-	-	-	-	-	-
2412MHz_TnomVnom	Pass	2.410855G	10.95	-19.05	147.665M	-37.53	2.39752G	-20.51	2.49222G	-54.22	7.235136G	-51.97	1
2437MHz_TnomVnom	Pass	2.410855G	10.95	-19.05	147.665M	-37.48	2.39904G	-44.77	2.48494G	-45.75	16.737077G	-52.87	1
2462MHz_TnomVnom	Pass	2.410855G	10.95	-19.05	147.665M	-37.43	2.39416G	-58.53	2.48446G	-39.71	2.531929G	-53.05	1
802.11g_Nss1,(6Mbps)_1TX	-	-	-	-	-	-	-	-	-	-	-	-	-
2412MHz_TnomVnom	Pass	2.438243G	8.93	-21.07	147.665M	-37.61	2.3992G	-25.19	2.48646G	-54.58	24.730282G	-52.25	1
2437MHz_TnomVnom	Pass	2.438243G	8.93	-21.07	147.665M	-37.75	2.39984G	-39.94	2.48414G	-41.57	24.522374G	-52.87	1
2462MHz_TnomVnom	Pass	2.438243G	8.93	-21.07	147.665M	-37.68	2.39768G	-55.26	2.48382G	-35.83	15.321057G	-52.50	1
802.11n HT20_Nss1,(MCS0)_1TX	-	-	-	-	-	-	-	-	-	-	-	-	-
2412MHz_TnomVnom	Pass	2.439579G	6.80	-23.20	147.665M	-37.66	2.39952G	-27.10	2.49102G	-54.77	16.694933G	-53.03	1
2437MHz_TnomVnom	Pass	2.439579G	6.80	-23.20	147.665M	-37.67	2.39888G	-40.01	2.48638G	-41.95	15.11034G	-52.40	1
2462MHz_TnomVnom	Pass	2.439579G	6.80	-23.20	147.665M	-37.59	2.39992G	-55.64	2.48494G	-34.91	24.09813G	-53.43	1

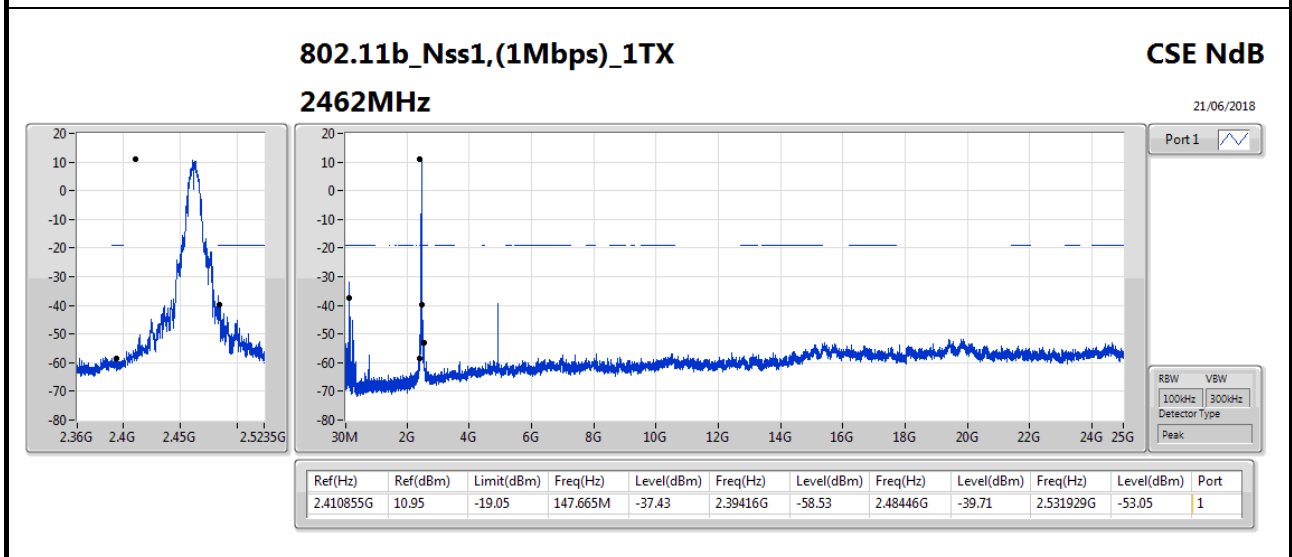
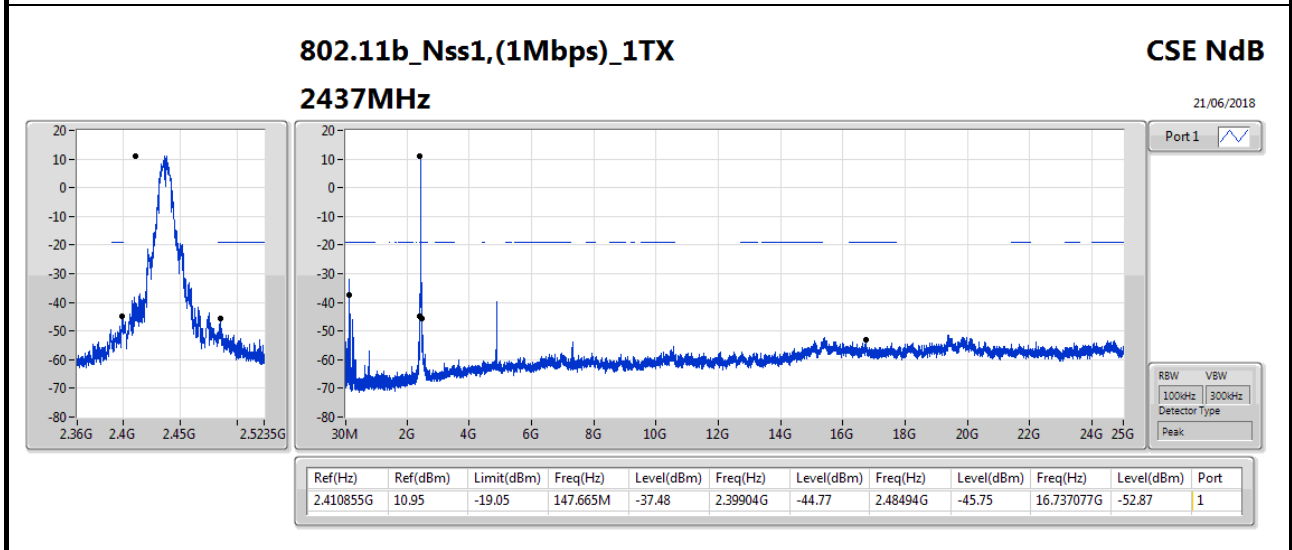
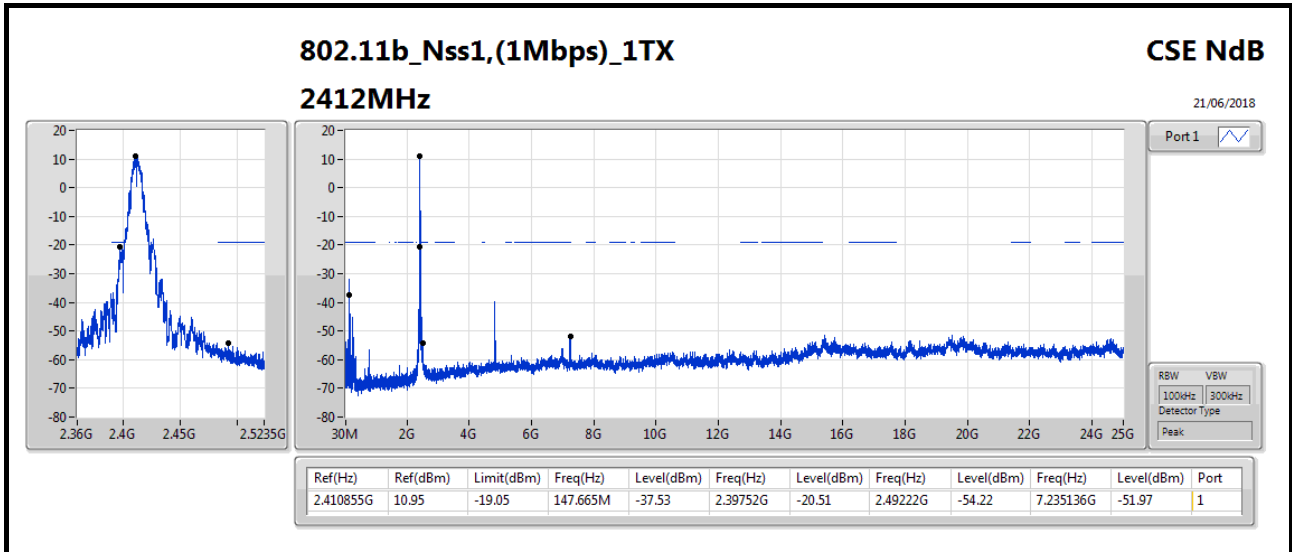

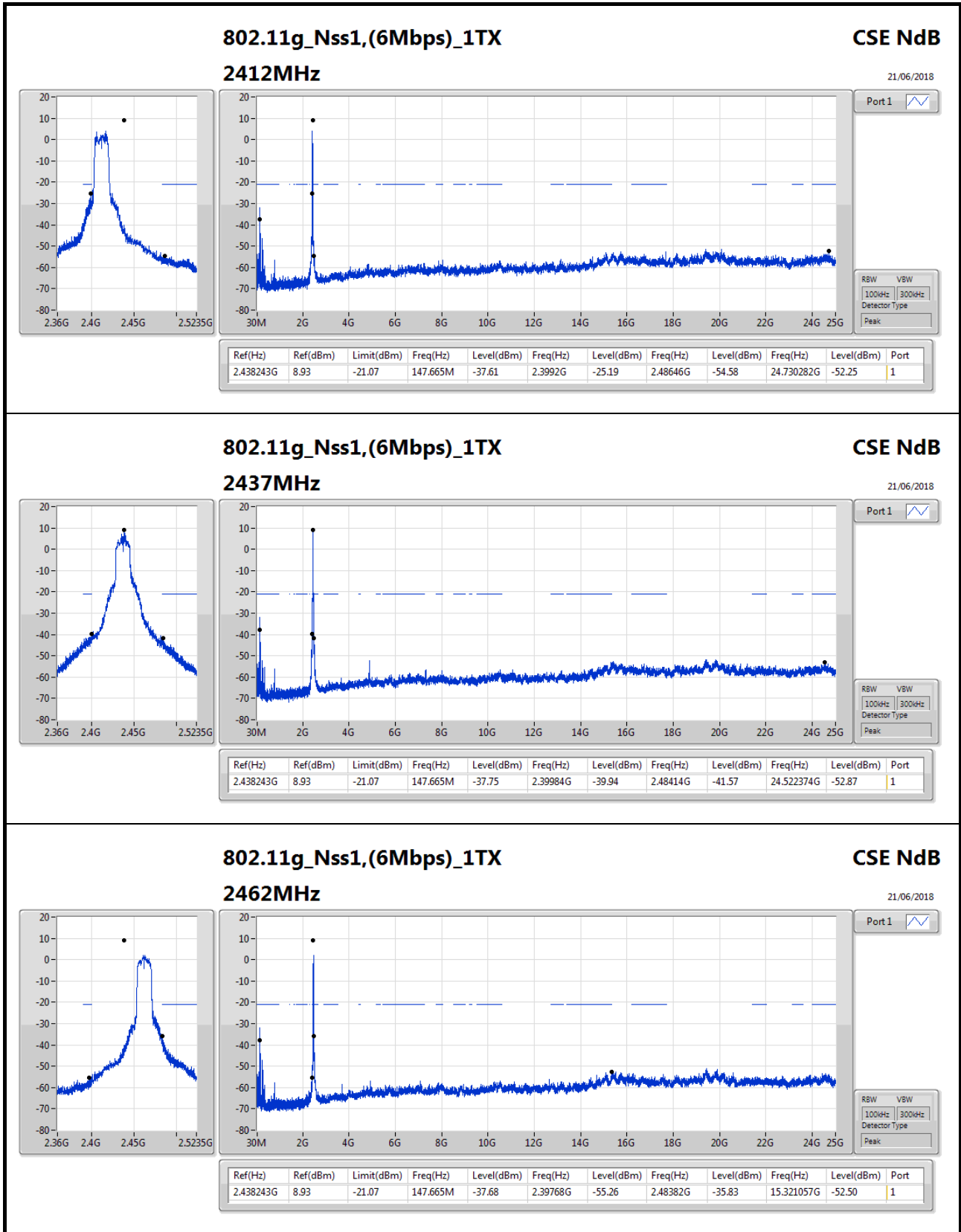

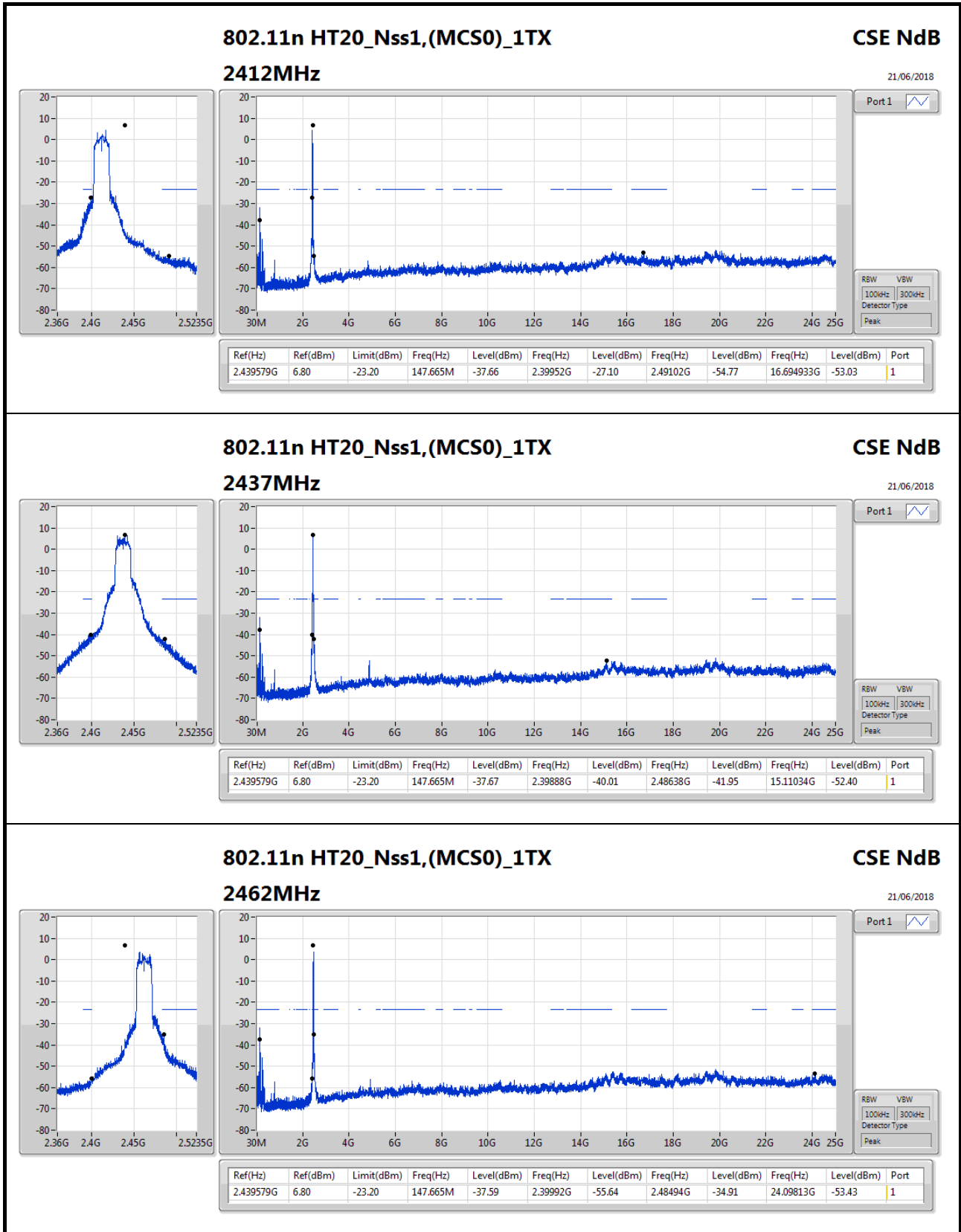



Summary

Mode	Result	Type	Freq (Hz)	Level (dBuV/m)	Limit (dBuV/m)	Margin (dB)	Factor (dB)	Dist (m)	Condition	Azimuth (°)	Height (m)	Comments
2.4-2.4835GHz	-	-	-	-	-	-	-	-	-	-	-	-
802.11g_Nss1,(6Mbps)_1TX	Pass	PK	891.36M	39.91	46.00	-6.09	1.53	3	Horizontal	0	1.00	-



Result

Mode	Result	Type	Freq (Hz)	Level (dBuV/m)	Limit (dBuV/m)	Margin (dB)	Factor (dB)	Dist (m)	Condition	Azimuth (°)	Height (m)	Comments
802.11g_Nss1,(6Mbps)_1TX	-	-	-	-	-	-	-	-	-	-	-	-
2437MHz	Pass	PK	39.174k	49.72	115.73	-66.01	21.65	3	Horizontal	0	1.00	-
2437MHz	Pass	PK	55.812k	49.44	112.65	-63.21	21.12	3	Horizontal	0	1.00	-
2437MHz	Pass	PK	111.366k	45.15	106.65	-61.50	20.77	3	Horizontal	0	1.00	-
2437MHz	Pass	PK	2.0007M	40.73	69.50	-28.77	20.91	3	Horizontal	360	1.00	-
2437MHz	Pass	PK	3.3141M	40.29	69.50	-29.21	20.83	3	Horizontal	360	1.00	-
2437MHz	Pass	PK	4.9857M	39.78	69.50	-29.72	21.14	3	Horizontal	360	1.00	-
2437MHz	Pass	PK	66.86M	29.06	40.00	-10.94	-13.89	3	Vertical	360	1.00	-
2437MHz	Pass	PK	99.84M	32.70	43.50	-10.80	-9.45	3	Vertical	360	1.00	-
2437MHz	Pass	PK	270.56M	39.28	46.00	-6.72	-6.56	3	Vertical	360	1.00	-
2437MHz	Pass	PK	650.8M	32.87	46.00	-13.13	-1.12	3	Vertical	360	1.00	-
2437MHz	Pass	PK	749.74M	34.89	46.00	-11.11	0.06	3	Vertical	360	1.00	-
2437MHz	Pass	PK	850.62M	33.45	46.00	-12.55	1.11	3	Vertical	360	1.00	-
2437MHz	Pass	PK	31.94M	26.61	40.00	-13.39	-3.42	3	Horizontal	0	1.00	-
2437MHz	Pass	PK	119.24M	28.27	43.50	-15.23	-8.04	3	Horizontal	0	1.00	-
2437MHz	Pass	PK	749.74M	39.68	46.00	-6.32	0.06	3	Horizontal	0	1.00	-
2437MHz	Pass	PK	850.62M	39.25	46.00	-6.75	1.11	3	Horizontal	0	1.00	-
2437MHz	Pass	PK	891.36M	39.91	46.00	-6.09	1.53	3	Horizontal	0	1.00	-
2437MHz	Pass	QP	280.26M	36.29	46.00	-9.71	-6.54	3	Horizontal	185	1.00	-

### 802.11g\_Nss1,(6Mbps)\_1TX

### 2437MHz\_Adapter

15/08/2018

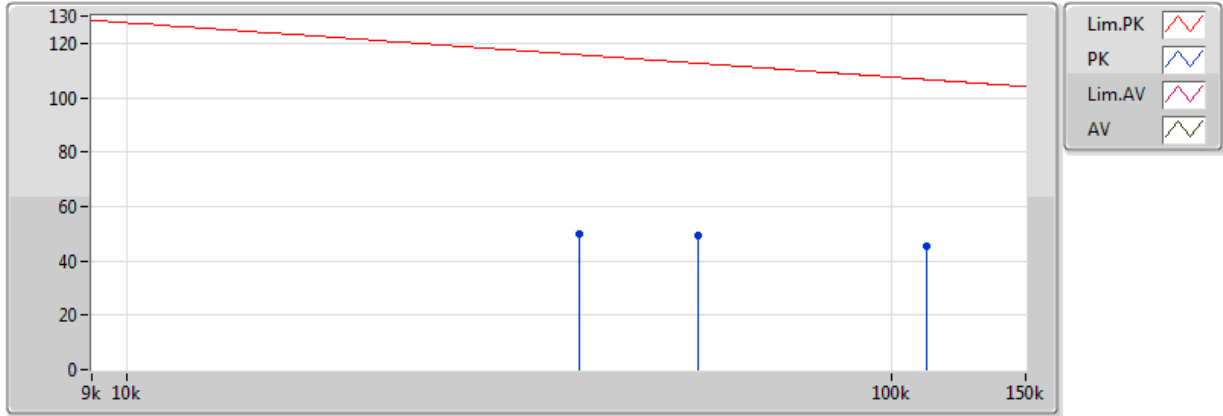

Type	Freq (Hz)	Level (dBuV/m)	Limit (dBuV/m)	Margin (dB)	Factor (dB)	Dist (m)	Condition	Azimuth (°)	Height (m)	Comments
PK	39.174k	49.72	115.73	-66.01	21.65	3	Horizontal	0	1.00	-
PK	55.812k	49.44	112.65	-63.21	21.12	3	Horizontal	0	1.00	-
PK	111.366k	45.15	106.65	-61.50	20.77	3	Horizontal	0	1.00	-



### 802.11g\_Nss1,(6Mbps)\_1TX

### 2437MHz\_Adapter

15/08/2018

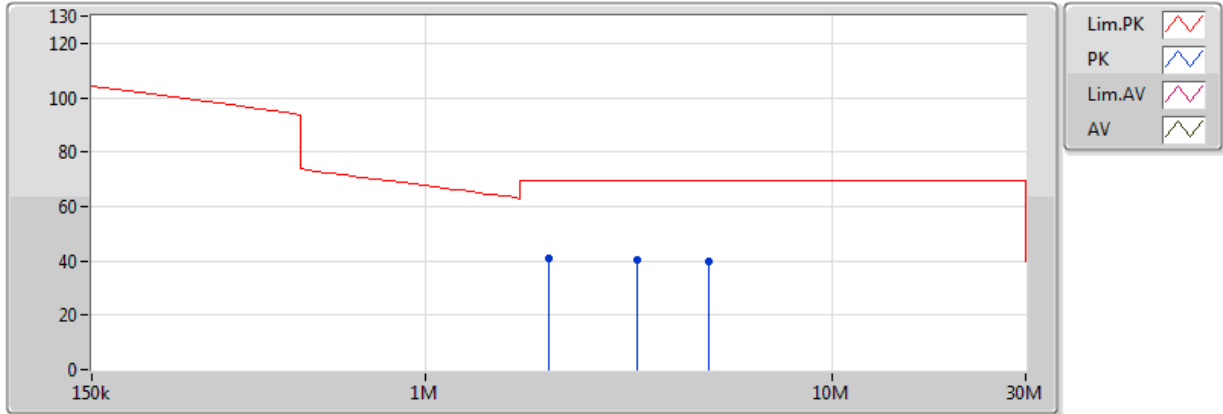

Type	Freq (Hz)	Level (dBuV/m)	Limit (dBuV/m)	Margin (dB)	Factor (dB)	Dist (m)	Condition	Azimuth (°)	Height (m)	Comments
PK	2.0007M	40.73	69.50	-28.77	20.91	3	Horizontal	360	1.00	-
PK	3.3141M	40.29	69.50	-29.21	20.83	3	Horizontal	360	1.00	-
PK	4.9857M	39.78	69.50	-29.72	21.14	3	Horizontal	360	1.00	-

### 802.11g\_Nss1,(6Mbps)\_1TX

### 2437MHz\_Adapter

15/08/2018

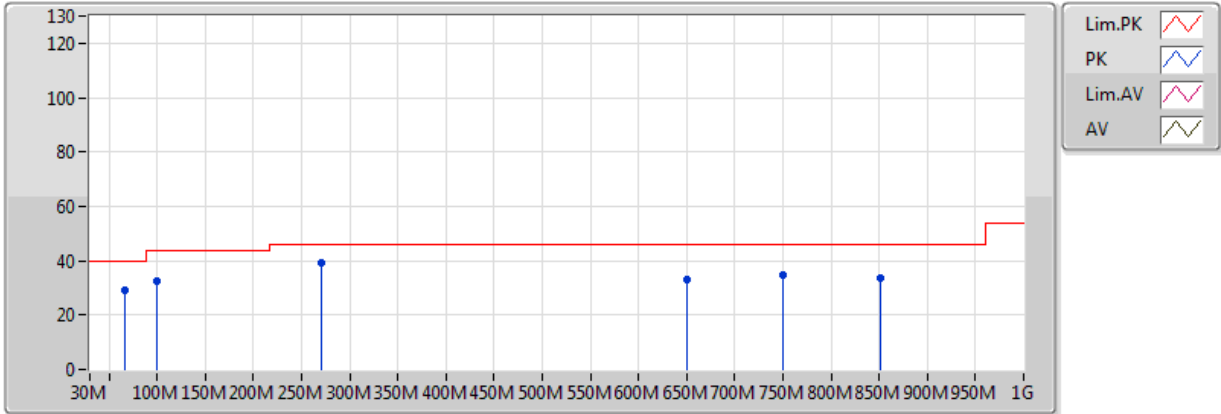

Type	Freq (Hz)	Level (dBuV/m)	Limit (dBuV/m)	Margin (dB)	Factor (dB)	Dist (m)	Condition	Azimuth (°)	Height (m)	Comments
PK	66.86M	29.06	40.00	-10.94	-13.89	3	Vertical	360	1.00	-
PK	99.84M	32.70	43.50	-10.80	-9.45	3	Vertical	360	1.00	-
PK	270.56M	39.28	46.00	-6.72	-6.56	3	Vertical	360	1.00	-
PK	650.8M	32.87	46.00	-13.13	-1.12	3	Vertical	360	1.00	-
PK	749.74M	34.89	46.00	-11.11	0.06	3	Vertical	360	1.00	-
PK	850.62M	33.45	46.00	-12.55	1.11	3	Vertical	360	1.00	-

### 802.11g\_Nss1,(6Mbps)\_1TX

### 2437MHz\_Adapter

15/08/2018

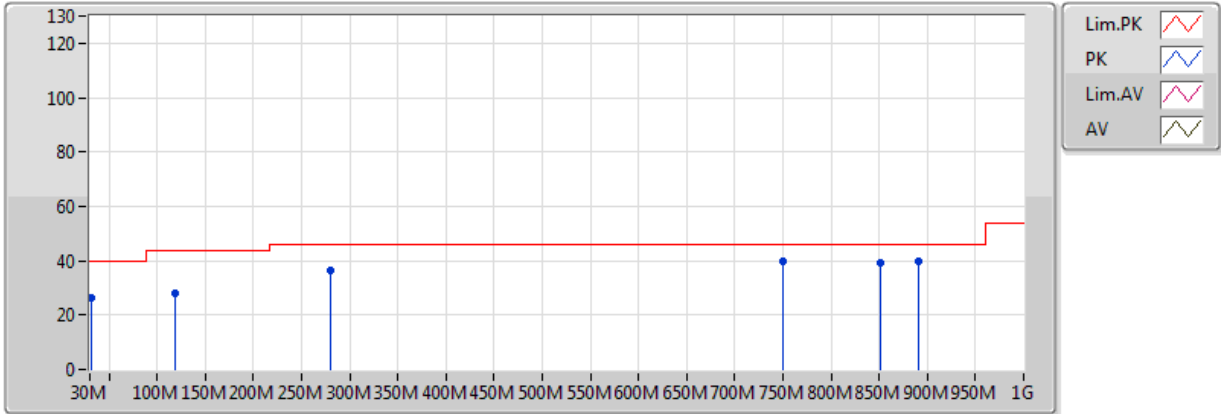

Type	Freq (Hz)	Level (dBuV/m)	Limit (dBuV/m)	Margin (dB)	Factor (dB)	Dist (m)	Condition	Azimuth (°)	Height (m)	Comments
PK	31.94M	26.61	40.00	-13.39	-3.42	3	Horizontal	0	1.00	-
PK	119.24M	28.27	43.50	-15.23	-8.04	3	Horizontal	0	1.00	-
PK	749.74M	39.68	46.00	-6.32	0.06	3	Horizontal	0	1.00	-
PK	850.62M	39.25	46.00	-6.75	1.11	3	Horizontal	0	1.00	-
PK	891.36M	39.91	46.00	-6.09	1.53	3	Horizontal	0	1.00	-
QP	280.26M	36.29	46.00	-9.71	-6.54	3	Horizontal	185	1.00	-



Summary

Mode	Result	Type	Freq (Hz)	Level (dBuV/m)	Limit (dBuV/m)	Margin (dB)	Factor (dB)	Dist (m)	Condition	Azimuth (°)	Height (m)	Comments
2.4-2.4835GHz	-	-	-	-	-	-	-	-	-	-	-	-
802.11g_Nss1,(6Mbps)_1TX	Pass	PK	891.36M	39.91	46.00	-6.09	1.53	3	Horizontal	0	1.00	-



**Result**

Mode	Result	Type	Freq (Hz)	Level (dBuV/m)	Limit (dBuV/m)	Margin (dB)	Factor (dB)	Dist (m)	Condition	Azimuth (°)	Height (m)	Comments
802.11g_Nss1,(6Mbps)_1TX	-	-	-	-	-	-	-	-	-	-	-	-
2437MHz	Pass	PK	66.86M	29.06	40.00	-10.94	-13.89	3	Vertical	360	1.00	-
2437MHz	Pass	PK	99.84M	32.70	43.50	-10.80	-9.45	3	Vertical	360	1.00	-
2437MHz	Pass	PK	270.56M	39.28	46.00	-6.72	-6.56	3	Vertical	360	1.00	-
2437MHz	Pass	PK	650.8M	32.87	46.00	-13.13	-1.12	3	Vertical	360	1.00	-
2437MHz	Pass	PK	749.74M	34.89	46.00	-11.11	0.06	3	Vertical	360	1.00	-
2437MHz	Pass	PK	850.62M	33.45	46.00	-12.55	1.11	3	Vertical	360	1.00	-
2437MHz	Pass	PK	31.94M	26.61	40.00	-13.39	-3.42	3	Horizontal	0	1.00	-
2437MHz	Pass	PK	119.24M	28.27	43.50	-15.23	-8.04	3	Horizontal	0	1.00	-
2437MHz	Pass	PK	749.74M	39.68	46.00	-6.32	0.06	3	Horizontal	0	1.00	-
2437MHz	Pass	PK	850.62M	39.25	46.00	-6.75	1.11	3	Horizontal	0	1.00	-
2437MHz	Pass	PK	891.36M	39.91	46.00	-6.09	1.53	3	Horizontal	0	1.00	-
2437MHz	Pass	QP	280.26M	36.29	46.00	-9.71	-6.54	3	Horizontal	185	1.00	-

### 802.11g\_Nss1,(6Mbps)\_1TX

### 2437MHz\_Adapter

19/07/2018

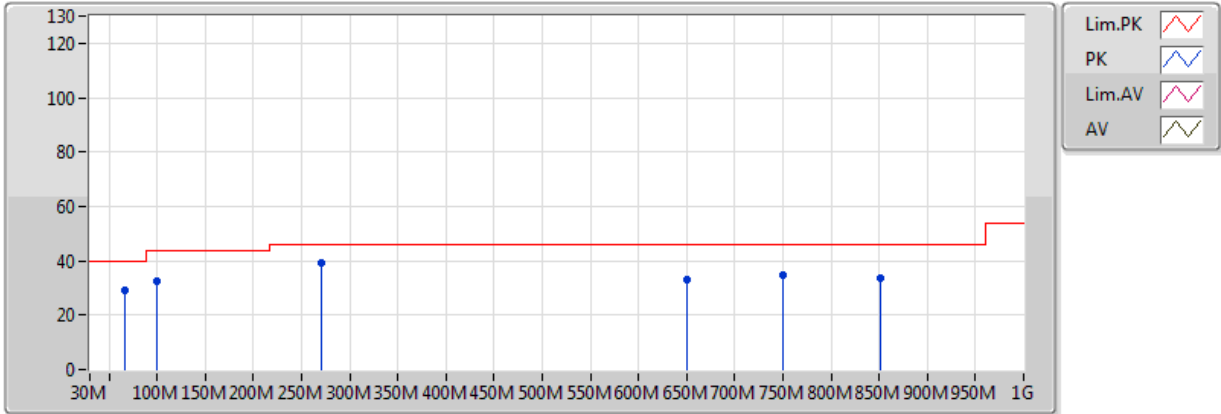

Type	Freq (Hz)	Level (dBuV/m)	Limit (dBuV/m)	Margin (dB)	Factor (dB)	Dist (m)	Condition	Azimuth (°)	Height (m)	Comments
PK	66.86M	29.06	40.00	-10.94	-13.89	3	Vertical	360	1.00	-
PK	99.84M	32.70	43.50	-10.80	-9.45	3	Vertical	360	1.00	-
PK	270.56M	39.28	46.00	-6.72	-6.56	3	Vertical	360	1.00	-
PK	650.8M	32.87	46.00	-13.13	-1.12	3	Vertical	360	1.00	-
PK	749.74M	34.89	46.00	-11.11	0.06	3	Vertical	360	1.00	-
PK	850.62M	33.45	46.00	-12.55	1.11	3	Vertical	360	1.00	-

### 802.11g\_Nss1,(6Mbps)\_1TX

### 2437MHz\_Adapter

19/07/2018

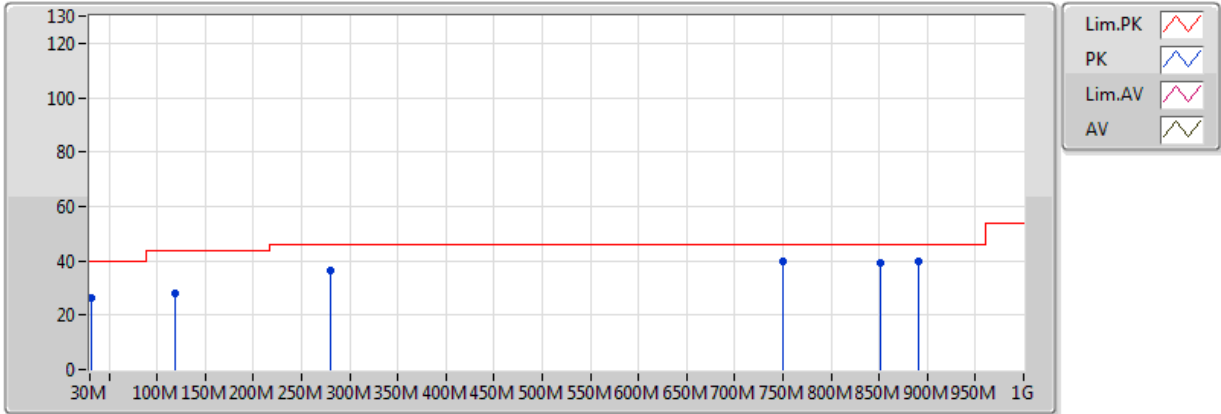

Type	Freq (Hz)	Level (dBuV/m)	Limit (dBuV/m)	Margin (dB)	Factor (dB)	Dist (m)	Condition	Azimuth (°)	Height (m)	Comments
PK	31.94M	26.61	40.00	-13.39	-3.42	3	Horizontal	0	1.00	-
PK	119.24M	28.27	43.50	-15.23	-8.04	3	Horizontal	0	1.00	-
PK	749.74M	39.68	46.00	-6.32	0.06	3	Horizontal	0	1.00	-
PK	850.62M	39.25	46.00	-6.75	1.11	3	Horizontal	0	1.00	-
PK	891.36M	39.91	46.00	-6.09	1.53	3	Horizontal	0	1.00	-
QP	280.26M	36.29	46.00	-9.71	-6.54	3	Horizontal	185	1.00	-



Summary

Mode	Type	Freq (Hz)	Level (dBuV/m)	Limit (dBuV/m)	Margin (dB)	Factor (dB)	Condition	Azimuth (°)	Height (m)
Mode 2	QK	575M	33.83	37.00	-3.17	-27.65	Horizontal	189	252



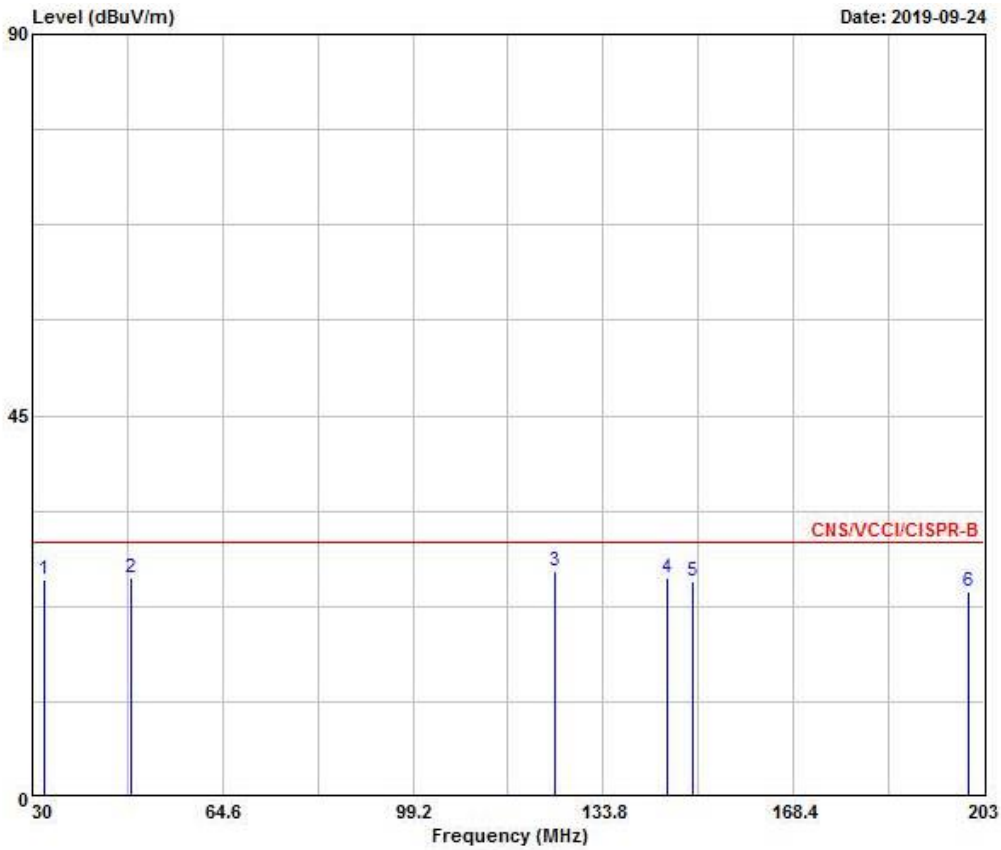

	Freq	Level	Over Limit	Limit Line	Read Level	Cable Loss	Preamp Factor	Antenna Factor	Ant Pos	Table Pos	Remark
	MHz	dBuV/m	dB	dBuV/m	dBuV	dB	dB	dB/m	cm	deg	
1 @	32.200	25.64	-4.36	30.00	29.76	0.70	27.00	22.18	---	---	Peak
2 @	47.800	25.81	-4.19	30.00	37.77	0.87	26.98	14.15	---	---	QP
3 @	125.000	26.65	-3.35	30.00	34.66	1.34	26.71	17.36	100	61	QP
4 @	145.380	25.91	-4.09	30.00	35.06	1.47	26.62	16.00	---	---	Peak
5 @	150.060	25.53	-4.47	30.00	35.01	1.52	26.61	15.61	---	---	Peak
6 @	200.060	24.21	-5.79	30.00	34.49	1.71	26.39	14.40	---	---	Peak

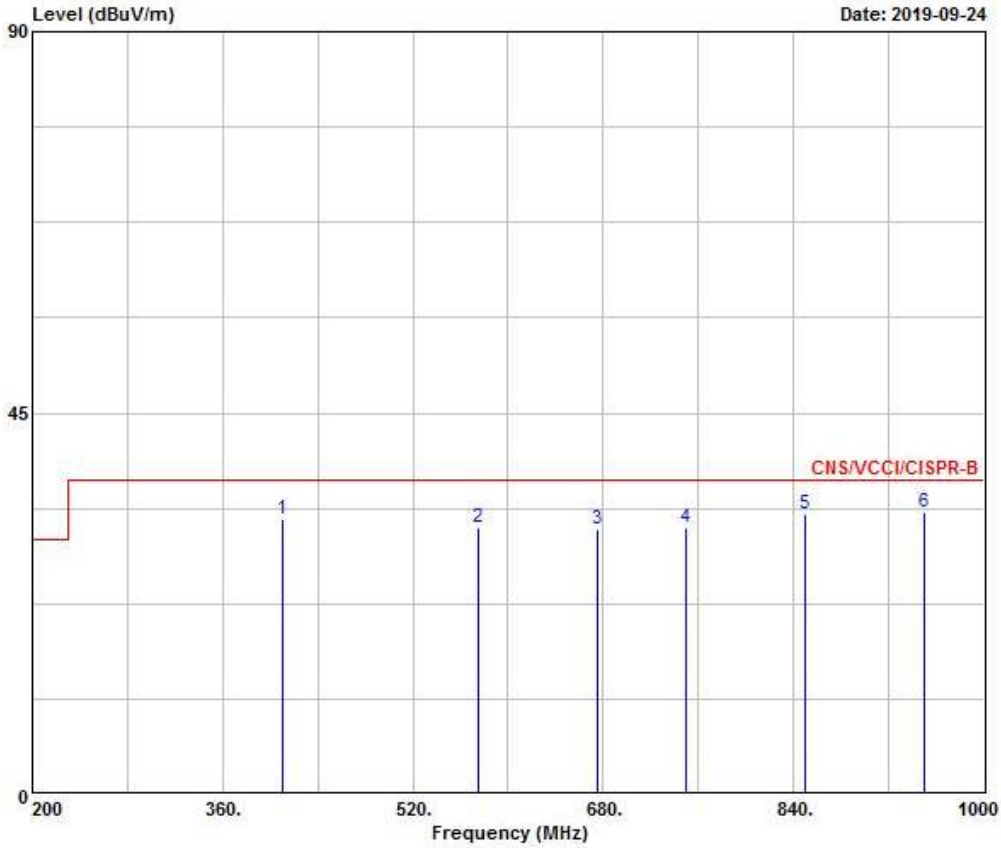

	Freq	Level	Over Limit	Limit Line	Read Level	Cable Loss	Preamp Factor	Antenna Factor	Ant Pos	Table Pos	Remark
	MHz	dBuV/m	dB	dBuV/m	dBuV	dB	dB	dB/m	cm	deg	
1 @	410.400	32.51	-4.49	37.00	35.46	2.70	27.08	21.43	---	---	Peak
2 @	575.000	31.38	-5.62	37.00	32.10	3.26	27.65	23.67	---	---	Peak
3 @	675.000	31.19	-5.81	37.00	31.40	3.45	27.66	24.00	---	---	Peak
4 @	750.000	31.40	-5.60	37.00	30.80	3.39	27.58	24.79	---	---	QP
5 @	850.000	33.04	-3.96	37.00	30.90	4.07	27.41	25.48	---	---	QP
6 @	950.000	33.23	-3.77	37.00	30.17	4.14	27.20	26.12	---	---	QP

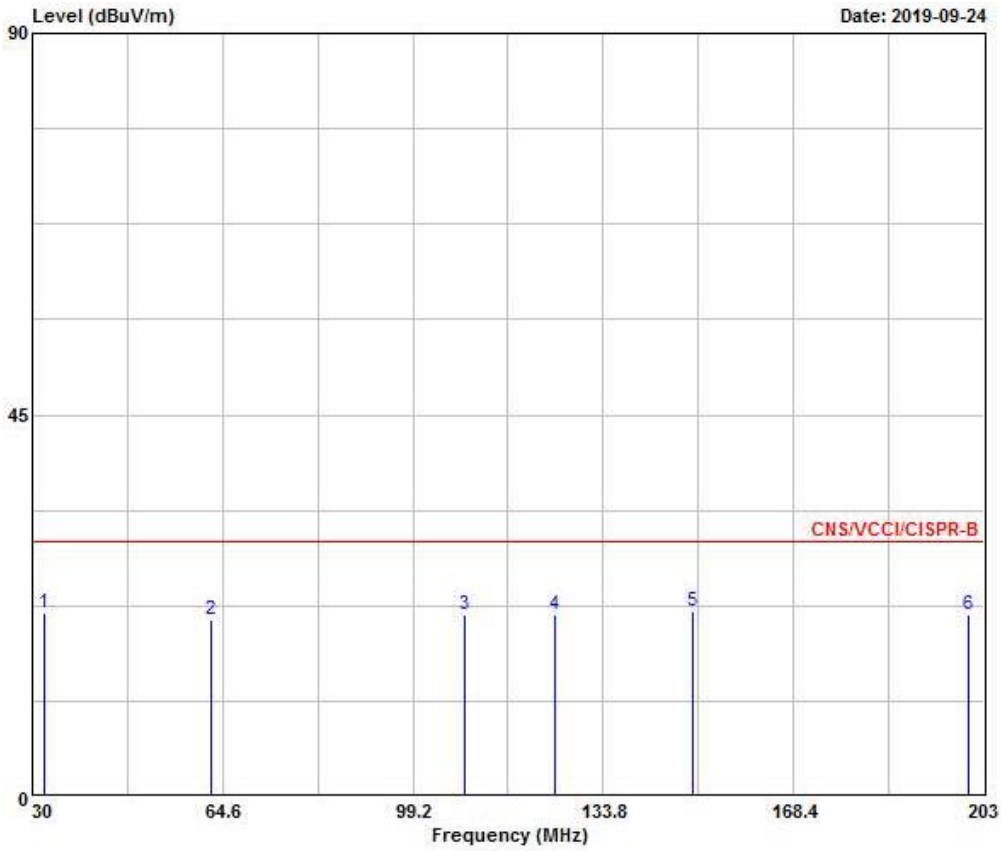

Peak	Freq	Level	Over Limit	Limit Line	Read Level	Cable Loss	Preamp Factor	Antenna Factor	Ant Pos	Table Pos	Remark
	MHz	dBuV/m	dB	dBuV/m	dBuV	dB	dB	dB/m	cm	deg	
1	32.030	21.63	-8.37	30.00	25.75	0.70	27.00	22.18	---	---	Peak
2	62.570	20.92	-9.08	30.00	35.42	0.98	26.94	11.46	---	---	Peak
3	108.720	21.51	-8.49	30.00	30.10	1.23	26.78	16.96	---	---	Peak
4	125.000	21.40	-8.60	30.00	29.41	1.34	26.71	17.36	---	---	Peak
5	150.060	21.91	-8.09	30.00	31.39	1.52	26.61	15.61	---	---	Peak
6	200.060	21.44	-8.56	30.00	31.72	1.71	26.39	14.40	---	---	Peak

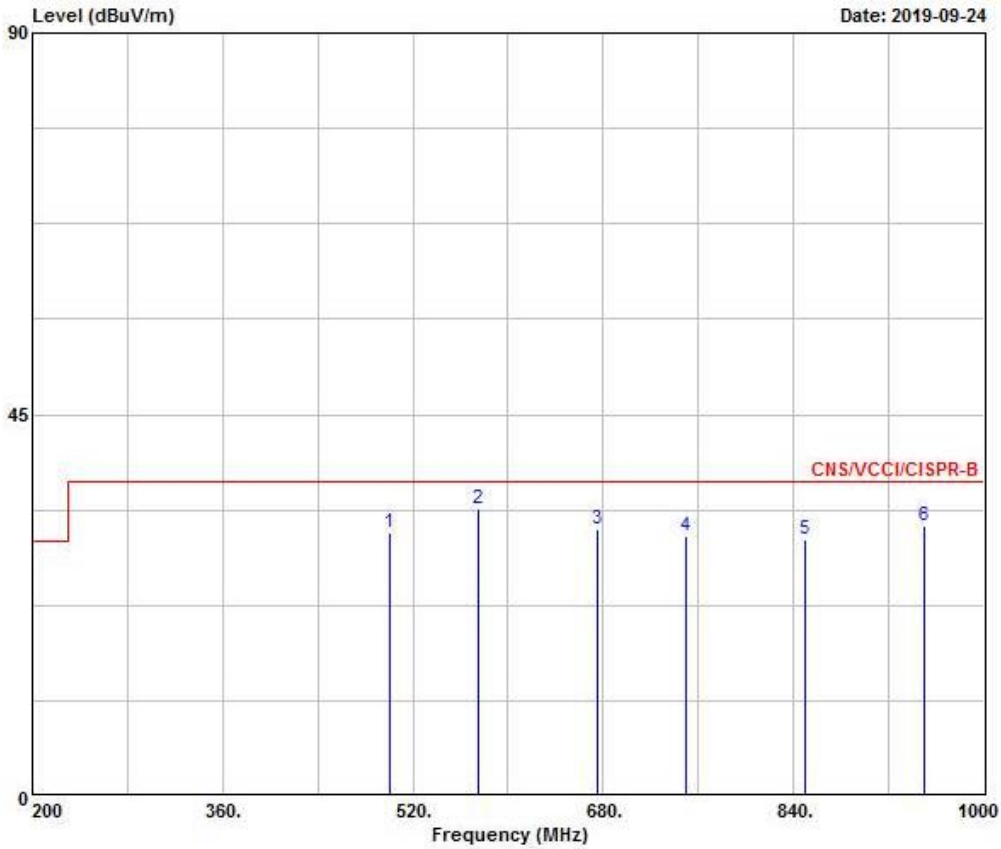

	Freq	Level	Over Limit	Limit Line	Read Level	Cable Loss	Preamp Factor	Antenna Factor	Ant Pos	Table Pos	Remark
	MHz	dBuV/m	dB	dBuV/m	dBuV	dB	dB	dB/m	cm	deg	
1 @	500.000	31.15	-5.85	37.00	33.10	3.02	27.56	22.59	---	---	Peak
2 @	575.000	33.83	-3.17	37.00	34.55	3.26	27.65	23.67	189	252	QP
3 @	675.000	31.43	-5.57	37.00	31.64	3.45	27.66	24.00	---	---	Peak
4 @	750.000	30.61	-6.39	37.00	30.01	3.39	27.58	24.79	---	---	Peak
5 @	850.000	30.22	-6.78	37.00	28.08	4.07	27.41	25.48	---	---	Peak
6 @	950.000	31.91	-5.09	37.00	28.85	4.14	27.20	26.12	---	---	Peak



Summary

Mode	Result	Type	Freq (Hz)	Level (dBuV/m)	Limit (dBuV/m)	Margin (dB)	Factor (dB)	Dist (m)	Condition	Azimuth (°)	Height (m)	Comments
2.4-2.4835GHz	-	-	-	-	-	-	-	-	-	-	-	-
802.11b_Nss1,(1Mbps)_1TX	Pass	AV	2.3864G	52.97	54.00	-1.03	32.26	3	Horizontal	325	3.14	-
802.11g_Nss1,(6Mbps)_1TX	Pass	AV	2.3898G	53.81	54.00	-0.19	32.28	3	Horizontal	324	3.15	-
802.11n HT20_Nss1,(MCS0)_1TX	Pass	AV	2.483502G	53.85	54.00	-0.15	32.61	3	Horizontal	325	3.01	-



Result

Mode	Result	Type	Freq (Hz)	Level (dBuV/m)	Limit (dBuV/m)	Margin (dB)	Factor (dB)	Dist (m)	Condition	Azimuth (°)	Height (m)	Comments
802.11b_Nss1,(1Mbps)_1TX	-	-	-	-	-	-	-	-	-	-	-	-
2412MHz	Pass	AV	2.3862G	52.46	54.00	-1.54	32.26	3	Vertical	53	3.19	-
2412MHz	Pass	AV	2.4112G	103.36	Inf	-Inf	32.35	3	Vertical	53	3.19	-
2412MHz	Pass	PK	2.385G	61.96	74.00	-12.04	32.25	3	Vertical	53	3.19	-
2412MHz	Pass	PK	2.4112G	105.32	Inf	-Inf	32.35	3	Vertical	53	3.19	-
2412MHz	Pass	AV	2.3864G	52.97	54.00	-1.03	32.26	3	Horizontal	325	3.14	-
2412MHz	Pass	AV	2.4112G	103.71	Inf	-Inf	32.35	3	Horizontal	325	3.14	-
2412MHz	Pass	PK	2.3886G	61.68	74.00	-12.32	32.27	3	Horizontal	325	3.14	-
2412MHz	Pass	PK	2.4112G	105.70	Inf	-Inf	32.35	3	Horizontal	325	3.14	-
2412MHz	Pass	AV	4.824G	40.90	54.00	-13.10	3.03	3	Vertical	230	1.48	-
2412MHz	Pass	PK	4.82428G	48.23	74.00	-25.77	3.03	3	Vertical	230	1.48	-
2412MHz	Pass	AV	4.82404G	44.61	54.00	-9.39	3.03	3	Horizontal	0	1.06	-
2412MHz	Pass	PK	4.82404G	50.09	74.00	-23.91	3.03	3	Horizontal	0	1.06	-
2437MHz	Pass	AV	2.3898G	48.64	54.00	-5.36	32.28	3	Vertical	105	1.06	-
2437MHz	Pass	AV	2.4362G	101.20	Inf	-Inf	32.44	3	Vertical	105	1.06	-
2437MHz	Pass	AV	2.4962G	49.11	54.00	-4.89	32.66	3	Vertical	105	1.06	-
2437MHz	Pass	PK	2.3522G	60.11	74.00	-13.89	32.14	3	Vertical	105	1.06	-
2437MHz	Pass	PK	2.4362G	103.17	Inf	-Inf	32.44	3	Vertical	105	1.06	-
2437MHz	Pass	PK	2.4906G	60.64	74.00	-13.36	32.64	3	Vertical	105	1.06	-
2437MHz	Pass	AV	2.3894G	48.63	54.00	-5.37	32.27	3	Horizontal	316	2.72	-
2437MHz	Pass	AV	2.4362G	102.05	Inf	-Inf	32.44	3	Horizontal	316	2.72	-
2437MHz	Pass	AV	2.4846G	49.63	54.00	-4.37	32.61	3	Horizontal	316	2.72	-
2437MHz	Pass	PK	2.339G	59.62	74.00	-14.38	32.09	3	Horizontal	316	2.72	-
2437MHz	Pass	PK	2.4362G	103.99	Inf	-Inf	32.44	3	Horizontal	316	2.72	-
2437MHz	Pass	PK	2.4994G	60.81	74.00	-13.19	32.67	3	Horizontal	316	2.72	-
2437MHz	Pass	AV	4.87406G	40.57	54.00	-13.43	3.14	3	Vertical	111	2.17	-
2437MHz	Pass	PK	4.87396G	47.62	74.00	-26.38	3.14	3	Vertical	111	2.17	-
2437MHz	Pass	AV	4.87396G	44.56	54.00	-9.44	3.14	3	Horizontal	360	1.11	-
2437MHz	Pass	PK	4.87424G	49.75	74.00	-24.25	3.14	3	Horizontal	360	1.11	-
802.11g_Nss1,(6Mbps)_1TX	-	-	-	-	-	-	-	-	-	-	-	-
2412MHz	Pass	AV	2.389998G	53.66	54.00	-0.34	32.28	3	Vertical	51	3.19	-
2412MHz	Pass	AV	2.4112G	97.10	Inf	-Inf	32.35	3	Vertical	51	3.19	-
2412MHz	Pass	PK	2.3898G	70.93	74.00	-3.07	32.28	3	Vertical	51	3.19	-
2412MHz	Pass	PK	2.4112G	105.38	Inf	-Inf	32.35	3	Vertical	51	3.19	-
2412MHz	Pass	AV	2.3898G	53.81	54.00	-0.19	32.28	3	Horizontal	324	3.15	-
2412MHz	Pass	AV	2.4112G	96.46	Inf	-Inf	32.35	3	Horizontal	324	3.15	-
2412MHz	Pass	PK	2.3898G	70.03	74.00	-3.97	32.28	3	Horizontal	324	3.15	-
2412MHz	Pass	PK	2.4116G	106.05	Inf	-Inf	32.35	3	Horizontal	324	3.15	-
2412MHz	Pass	AV	4.82394G	34.43	54.00	-19.57	3.03	3	Vertical	307	1.67	-
2412MHz	Pass	PK	4.81542G	46.44	74.00	-27.56	3.01	3	Vertical	307	1.67	-
2412MHz	Pass	AV	4.82394G	36.73	54.00	-17.27	3.03	3	Horizontal	66	1.09	-
2412MHz	Pass	PK	4.83216G	46.80	74.00	-27.20	3.05	3	Horizontal	66	1.09	-
2437MHz	Pass	AV	2.3894G	49.89	54.00	-4.11	32.27	3	Vertical	104	1.05	-
2437MHz	Pass	AV	2.4362G	96.97	Inf	-Inf	32.44	3	Vertical	104	1.05	-
2437MHz	Pass	AV	2.4994G	49.68	54.00	-4.32	32.67	3	Vertical	104	1.05	-
2437MHz	Pass	PK	2.3878G	60.82	74.00	-13.18	32.27	3	Vertical	104	1.05	-
2437MHz	Pass	PK	2.4366G	105.66	Inf	-Inf	32.44	3	Vertical	104	1.05	-
2437MHz	Pass	PK	2.4846G	60.83	74.00	-13.17	32.61	3	Vertical	104	1.05	-



Mode	Result	Type	Freq (Hz)	Level (dBuV/m)	Limit (dBuV/m)	Margin (dB)	Factor (dB)	Dist (m)	Condition	Azimuth (°)	Height (m)	Comments
2437MHz	Pass	AV	2.3898G	49.67	54.00	-4.33	32.28	3	Horizontal	317	2.73	-
2437MHz	Pass	AV	2.4362G	98.05	Inf	-Inf	32.44	3	Horizontal	317	2.73	-
2437MHz	Pass	AV	2.483502G	50.41	54.00	-3.59	32.61	3	Horizontal	317	2.73	-
2437MHz	Pass	PK	2.3894G	60.45	74.00	-13.55	32.27	3	Horizontal	317	2.73	-
2437MHz	Pass	PK	2.437G	106.47	Inf	-Inf	32.44	3	Horizontal	317	2.73	-
2437MHz	Pass	PK	2.485G	61.65	74.00	-12.35	32.61	3	Horizontal	317	2.73	-
2437MHz	Pass	AV	4.87408G	34.68	54.00	-19.32	3.14	3	Vertical	353	1.50	-
2437MHz	Pass	PK	4.87384G	46.15	74.00	-27.85	3.14	3	Vertical	353	1.50	-
2437MHz	Pass	AV	4.87408G	36.95	54.00	-17.05	3.14	3	Horizontal	62	1.03	-
2437MHz	Pass	PK	4.88056G	47.17	74.00	-26.83	3.16	3	Horizontal	62	1.03	-
2462MHz	Pass	AV	2.4612G	93.62	Inf	-Inf	32.53	3	Vertical	69	1.01	-
2462MHz	Pass	AV	2.483502G	51.35	54.00	-2.65	32.61	3	Vertical	69	1.01	-
2462MHz	Pass	PK	2.462G	103.77	Inf	-Inf	32.53	3	Vertical	69	1.01	-
2462MHz	Pass	PK	2.483502G	65.42	74.00	-8.58	32.61	3	Vertical	69	1.01	-
2462MHz	Pass	AV	2.4612G	95.70	Inf	-Inf	32.53	3	Horizontal	327	3.03	-
2462MHz	Pass	AV	2.483502G	53.51	54.00	-0.49	32.61	3	Horizontal	327	3.03	-
2462MHz	Pass	PK	2.4606G	104.06	Inf	-Inf	32.53	3	Horizontal	327	3.03	-
2462MHz	Pass	PK	2.4836G	69.76	74.00	-4.24	32.61	3	Horizontal	327	3.03	-
2462MHz	Pass	AV	4.93588G	34.64	54.00	-19.36	3.28	3	Vertical	181	1.37	-
2462MHz	Pass	PK	4.92688G	45.90	74.00	-28.10	3.26	3	Vertical	181	1.37	-
2462MHz	Pass	AV	4.92406G	37.58	54.00	-16.42	3.25	3	Horizontal	59	1.07	-
2462MHz	Pass	PK	4.93696G	46.93	74.00	-27.07	3.28	3	Horizontal	59	1.07	-
2417MHz	Pass	AV	2.3898G	52.35	54.00	-1.65	32.28	3	Vertical	49	3.19	-
2417MHz	Pass	AV	2.4162G	97.86	Inf	-Inf	32.37	3	Vertical	49	3.19	-
2417MHz	Pass	PK	2.3892G	70.12	74.00	-3.88	32.27	3	Vertical	49	3.19	-
2417MHz	Pass	PK	2.4168G	106.71	Inf	-Inf	32.37	3	Vertical	49	3.19	-
2417MHz	Pass	AV	2.3896G	51.41	54.00	-2.59	32.28	3	Horizontal	320	1.19	-
2417MHz	Pass	AV	2.418G	97.49	Inf	-Inf	32.37	3	Horizontal	320	1.19	-
2417MHz	Pass	PK	2.389998G	68.60	74.00	-5.40	32.28	3	Horizontal	320	1.19	-
2417MHz	Pass	PK	2.417G	106.76	Inf	-Inf	32.37	3	Horizontal	320	1.19	-
2457MHz	Pass	AV	2.458G	96.32	Inf	-Inf	32.52	3	Vertical	73	1.01	-
2457MHz	Pass	AV	2.483502G	51.57	54.00	-2.43	32.61	3	Vertical	73	1.01	-
2457MHz	Pass	PK	2.4572G	104.32	Inf	-Inf	32.52	3	Vertical	73	1.01	-
2457MHz	Pass	PK	2.4856G	65.60	74.00	-8.40	32.62	3	Vertical	73	1.01	-
2457MHz	Pass	AV	2.4562G	97.19	Inf	-Inf	32.51	3	Horizontal	325	1.50	-
2457MHz	Pass	AV	2.483502G	53.33	54.00	-0.67	32.61	3	Horizontal	325	1.50	-
2457MHz	Pass	PK	2.457G	106.64	Inf	-Inf	32.52	3	Horizontal	325	1.50	-
2457MHz	Pass	PK	2.485G	70.42	74.00	-3.58	32.61	3	Horizontal	325	1.50	-
802.11n HT20_Nss1,(MCS0)_1TX	-	-	-	-	-	-	-	-	-	-	-	-
2412MHz	Pass	AV	2.3898G	53.35	54.00	-0.65	32.28	3	Vertical	52	3.19	-
2412MHz	Pass	AV	2.4112G	95.80	Inf	-Inf	32.35	3	Vertical	52	3.19	-
2412MHz	Pass	PK	2.3892G	70.17	74.00	-3.83	32.27	3	Vertical	52	3.19	-
2412MHz	Pass	PK	2.4108G	104.07	Inf	-Inf	32.35	3	Vertical	52	3.19	-
2412MHz	Pass	AV	2.3898G	53.51	54.00	-0.49	32.28	3	Horizontal	179	3.17	-
2412MHz	Pass	AV	2.4112G	94.30	Inf	-Inf	32.35	3	Horizontal	179	3.17	-
2412MHz	Pass	PK	2.389998G	70.31	74.00	-3.69	32.28	3	Horizontal	179	3.17	-
2412MHz	Pass	PK	2.4126G	102.85	Inf	-Inf	32.36	3	Horizontal	179	3.17	-
2412MHz	Pass	AV	4.82388G	34.43	54.00	-19.57	3.03	3	Vertical	224	1.78	-
2412MHz	Pass	PK	4.82394G	46.21	74.00	-27.79	3.03	3	Vertical	224	1.78	-



RSE TX above 1GHz Result

Appendix F.4

Mode	Result	Type	Freq (Hz)	Level (dBuV/m)	Limit (dBuV/m)	Margin (dB)	Factor (dB)	Dist (m)	Condition	Azimuth (°)	Height (m)	Comments
2412MHz	Pass	AV	4.824G	36.51	54.00	-17.49	3.03	3	Horizontal	65	1.04	-
2412MHz	Pass	PK	4.82994G	46.70	74.00	-27.30	3.05	3	Horizontal	65	1.04	-
2437MHz	Pass	AV	2.3898G	49.43	54.00	-4.57	32.28	3	Vertical	104	1.07	-
2437MHz	Pass	AV	2.4362G	96.56	Inf	-Inf	32.44	3	Vertical	104	1.07	-
2437MHz	Pass	AV	2.483502G	49.90	54.00	-4.10	32.61	3	Vertical	104	1.07	-
2437MHz	Pass	PK	2.3874G	60.62	74.00	-13.38	32.26	3	Vertical	104	1.07	-
2437MHz	Pass	PK	2.437G	105.11	Inf	-Inf	32.44	3	Vertical	104	1.07	-
2437MHz	Pass	PK	2.4906G	60.71	74.00	-13.29	32.64	3	Vertical	104	1.07	-
2437MHz	Pass	AV	2.3894G	49.66	54.00	-4.34	32.27	3	Horizontal	317	2.74	-
2437MHz	Pass	AV	2.4378G	97.58	Inf	-Inf	32.45	3	Horizontal	317	2.74	-
2437MHz	Pass	AV	2.483502G	50.16	54.00	-3.84	32.61	3	Horizontal	317	2.74	-
2437MHz	Pass	PK	2.3854G	60.65	74.00	-13.35	32.25	3	Horizontal	317	2.74	-
2437MHz	Pass	PK	2.4374G	105.84	Inf	-Inf	32.44	3	Horizontal	317	2.74	-
2437MHz	Pass	PK	2.4886G	60.92	74.00	-13.08	32.63	3	Horizontal	317	2.74	-
2437MHz	Pass	AV	4.86664G	33.92	54.00	-20.08	3.13	3	Vertical	254	1.56	-
2437MHz	Pass	PK	4.87836G	45.67	74.00	-28.33	3.15	3	Vertical	254	1.56	-
2437MHz	Pass	AV	4.87396G	36.75	54.00	-17.25	3.14	3	Horizontal	62	1.01	-
2437MHz	Pass	PK	4.87392G	46.88	74.00	-27.12	3.14	3	Horizontal	62	1.01	-
2462MHz	Pass	AV	2.4628G	93.45	Inf	-Inf	32.54	3	Vertical	54	3.06	-
2462MHz	Pass	AV	2.483502G	53.15	54.00	-0.85	32.61	3	Vertical	54	3.06	-
2462MHz	Pass	PK	2.4622G	101.77	Inf	-Inf	32.53	3	Vertical	54	3.06	-
2462MHz	Pass	PK	2.483502G	72.49	74.00	-1.51	32.61	3	Vertical	54	3.06	-
2462MHz	Pass	AV	2.4612G	95.24	Inf	-Inf	32.53	3	Horizontal	325	3.01	-
2462MHz	Pass	AV	2.483502G	53.85	54.00	-0.15	32.61	3	Horizontal	325	3.01	-
2462MHz	Pass	PK	2.462G	103.93	Inf	-Inf	32.53	3	Horizontal	325	3.01	-
2462MHz	Pass	PK	2.4842G	69.81	74.00	-4.19	32.61	3	Horizontal	325	3.01	-
2462MHz	Pass	AV	4.93186G	34.65	54.00	-19.35	3.27	3	Vertical	135	1.33	-
2462MHz	Pass	PK	4.92286G	45.86	74.00	-28.14	3.25	3	Vertical	135	1.33	-
2462MHz	Pass	AV	4.924G	36.80	54.00	-17.20	3.25	3	Horizontal	58	1.06	-
2462MHz	Pass	PK	4.93114G	46.77	74.00	-27.23	3.27	3	Horizontal	58	1.06	-
2417MHz	Pass	AV	2.389998G	53.33	54.00	-0.67	32.27	3	Vertical	62	1.03	-
2417MHz	Pass	AV	2.4162G	97.89	Inf	-Inf	32.37	3	Vertical	51	3.19	-
2417MHz	Pass	PK	2.3884G	68.72	74.00	-5.28	32.27	3	Vertical	51	3.19	-
2417MHz	Pass	PK	2.4156G	106.59	Inf	-Inf	32.37	3	Vertical	51	3.19	-
2417MHz	Pass	AV	2.389998G	52.17	54.00	-1.83	32.28	3	Horizontal	326	2.77	-
2417MHz	Pass	AV	2.4162G	97.51	Inf	-Inf	32.37	3	Horizontal	326	2.77	-
2417MHz	Pass	PK	2.389998G	68.36	74.00	-5.64	32.28	3	Horizontal	326	2.77	-
2417MHz	Pass	PK	2.4148G	106.75	Inf	-Inf	32.36	3	Horizontal	326	2.77	-
2422MHz	Pass	AV	2.3898G	51.41	54.00	-2.59	32.28	3	Vertical	66	1.19	-
2422MHz	Pass	AV	2.4228G	97.75	Inf	-Inf	32.39	3	Vertical	66	1.19	-
2422MHz	Pass	PK	2.3878G	64.37	74.00	-9.63	32.27	3	Vertical	66	1.19	-
2422MHz	Pass	PK	2.422G	106.39	Inf	-Inf	32.39	3	Vertical	66	1.19	-
2422MHz	Pass	AV	2.3894G	51.40	54.00	-2.60	32.27	3	Horizontal	336	3.16	-
2422MHz	Pass	AV	2.4214G	98.04	Inf	-Inf	32.39	3	Horizontal	336	3.16	-
2422MHz	Pass	PK	2.3888G	65.22	74.00	-8.78	32.27	3	Horizontal	336	3.16	-
2422MHz	Pass	PK	2.4216G	106.57	Inf	-Inf	32.39	3	Horizontal	336	3.16	-
2457MHz	Pass	AV	2.4578G	95.38	Inf	-Inf	32.52	3	Vertical	65	1.00	-
2457MHz	Pass	AV	2.483502G	51.99	54.00	-2.01	32.61	3	Vertical	65	1.00	-
2457MHz	Pass	PK	2.457G	104.32	Inf	-Inf	32.52	3	Vertical	65	1.00	-





**RSE TX above 1GHz Result**

**Appendix F.4**

Mode	Result	Type	Freq (Hz)	Level (dBuV/m)	Limit (dBuV/m)	Margin (dB)	Factor (dB)	Dist (m)	Condition	Azimuth (°)	Height (m)	Comments
2457MHz	Pass	PK	2.4842G	66.78	74.00	-7.22	32.61	3	Vertical	65	1.00	-
2457MHz	Pass	AV	2.456G	96.96	Inf	-Inf	32.51	3	Horizontal	326	1.50	-
2457MHz	Pass	AV	2.483502G	53.68	54.00	-0.32	32.61	3	Horizontal	326	1.50	-
2457MHz	Pass	PK	2.456G	105.19	Inf	-Inf	32.51	3	Horizontal	326	1.50	-
2457MHz	Pass	PK	2.4836G	71.19	74.00	-2.81	32.61	3	Horizontal	326	1.50	-

### 802.11b\_Nss1,(1Mbps)\_1TX

### 2412MHz\_TX

17/06/2018

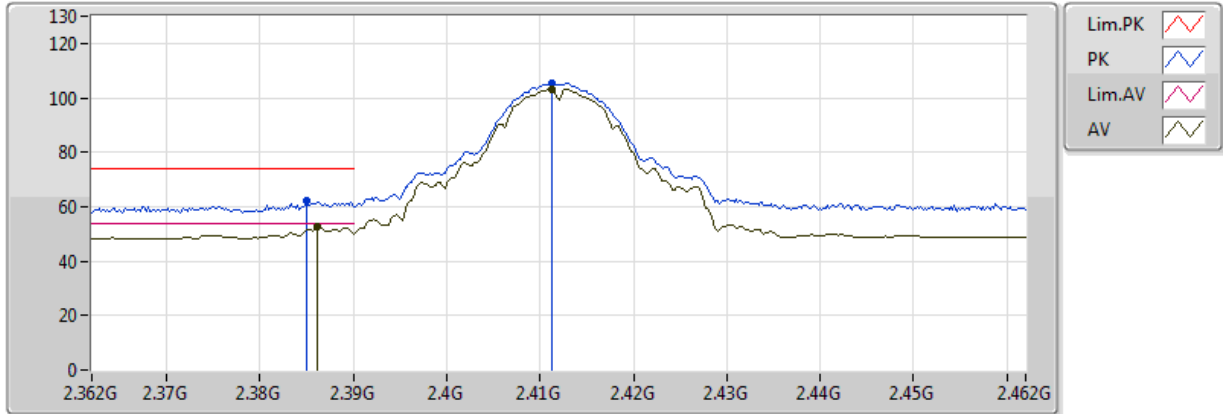

Type	Freq (Hz)	Level (dBuV/m)	Limit (dBuV/m)	Margin (dB)	Factor (dB)	Dist (m)	Condition	Azimuth (°)	Height (m)	Comments
AV	2.3862G	52.46	54.00	-1.54	32.26	3	Vertical	53	3.19	-
AV	2.4112G	103.36	Inf	-Inf	32.35	3	Vertical	53	3.19	-
PK	2.385G	61.96	74.00	-12.04	32.25	3	Vertical	53	3.19	-
PK	2.4112G	105.32	Inf	-Inf	32.35	3	Vertical	53	3.19	-

### 802.11b\_Nss1,(1Mbps)\_1TX

### 2412MHz\_TX

17/06/2018

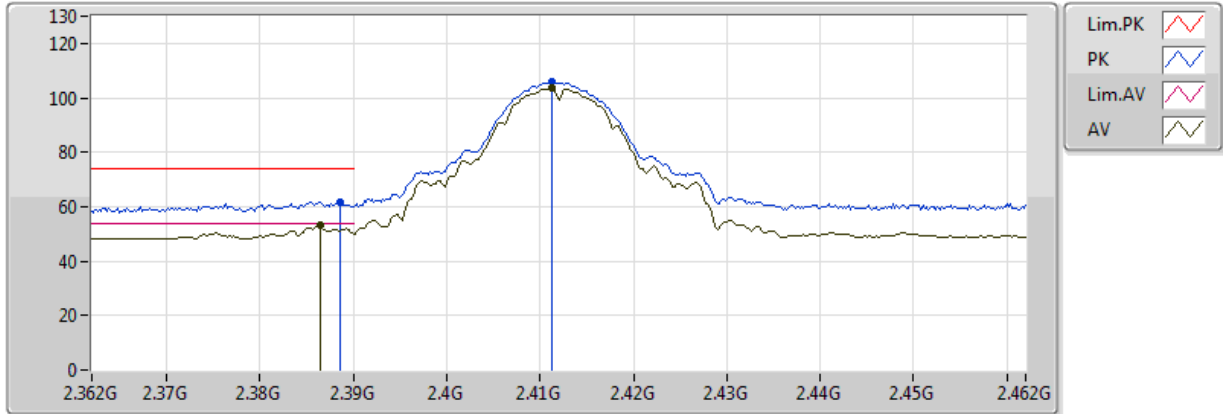





Type	Freq (Hz)	Level (dBuV/m)	Limit (dBuV/m)	Margin (dB)	Factor (dB)	Dist (m)	Condition	Azimuth (°)	Height (m)	Comments
AV	2.3864G	52.97	54.00	-1.03	32.26	3	Horizontal	325	3.14	-
AV	2.4112G	103.71	Inf	-Inf	32.35	3	Horizontal	325	3.14	-
PK	2.3886G	61.68	74.00	-12.32	32.27	3	Horizontal	325	3.14	-
PK	2.4112G	105.70	Inf	-Inf	32.35	3	Horizontal	325	3.14	-

### 802.11b\_Nss1,(1Mbps)\_1TX

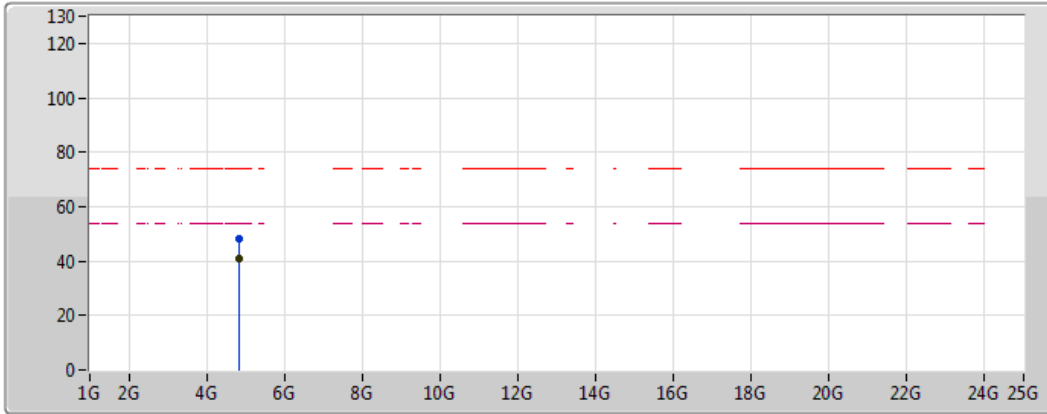
### 2412MHz\_TX

17/06/2018



Lim.PK	
PK	
Lim.AV	
AV	





Type	Freq (Hz)	Level (dBuV/m)	Limit (dBuV/m)	Margin (dB)	Factor (dB)	Dist (m)	Condition	Azimuth (°)	Height (m)	Comments
AV	4.824G	40.90	54.00	-13.10	3.03	3	Vertical	230	1.48	-
PK	4.82428G	48.23	74.00	-25.77	3.03	3	Vertical	230	1.48	-

### 802.11b\_Nss1,(1Mbps)\_1TX

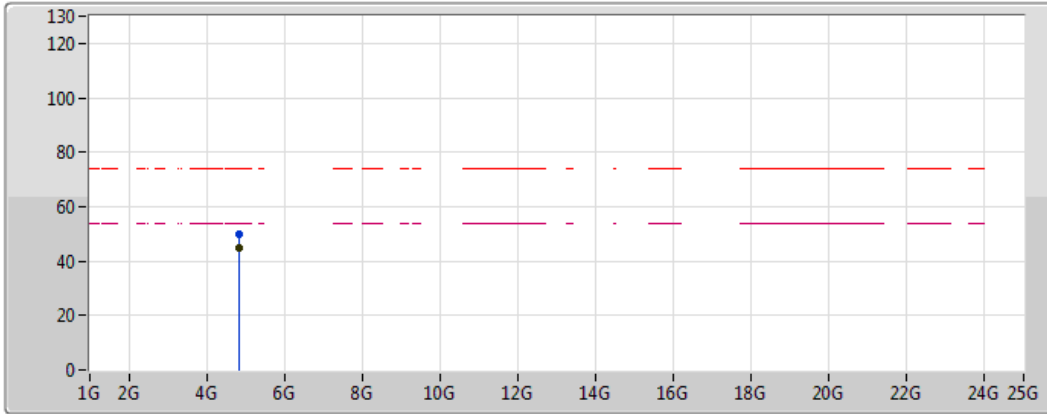
### 2412MHz\_TX

17/06/2018



Lim.PK	
PK	
Lim.AV	
AV	

Type	Freq (Hz)	Level (dBuV/m)	Limit (dBuV/m)	Margin (dB)	Factor (dB)	Dist (m)	Condition	Azimuth (°)	Height (m)	Comments
AV	4.82404G	44.61	54.00	-9.39	3.03	3	Horizontal	0	1.06	-
PK	4.82404G	50.09	74.00	-23.91	3.03	3	Horizontal	0	1.06	-

### 802.11b\_Nss1,(1Mbps)\_1TX

### 2437MHz\_TX

17/06/2018

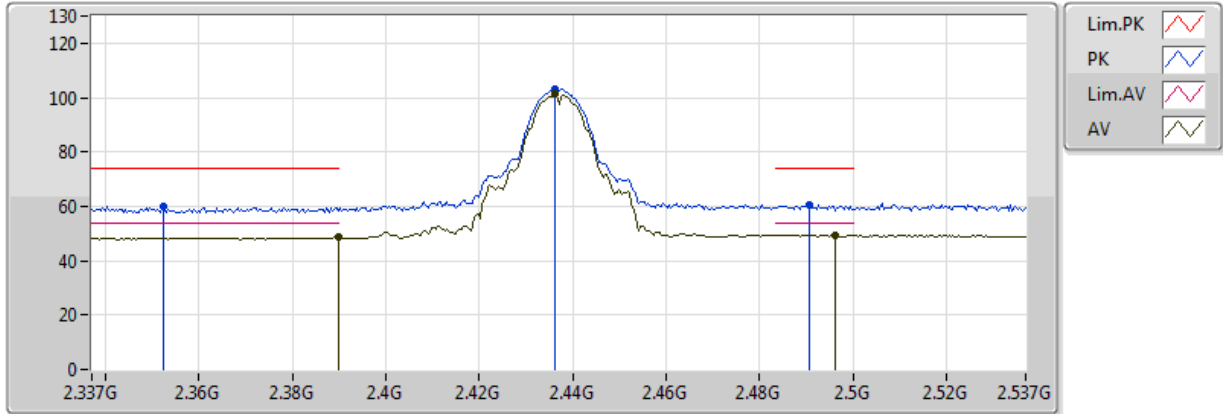

Type	Freq (Hz)	Level (dBuV/m)	Limit (dBuV/m)	Margin (dB)	Factor (dB)	Dist (m)	Condition	Azimuth (°)	Height (m)	Comments
AV	2.3898G	48.64	54.00	-5.36	32.28	3	Vertical	105	1.06	-
AV	2.4362G	101.20	Inf	-Inf	32.44	3	Vertical	105	1.06	-
AV	2.4962G	49.11	54.00	-4.89	32.66	3	Vertical	105	1.06	-
PK	2.3522G	60.11	74.00	-13.89	32.14	3	Vertical	105	1.06	-
PK	2.4362G	103.17	Inf	-Inf	32.44	3	Vertical	105	1.06	-
PK	2.4906G	60.64	74.00	-13.36	32.64	3	Vertical	105	1.06	-

### 802.11b\_Nss1,(1Mbps)\_1TX

### 2437MHz\_TX

17/06/2018

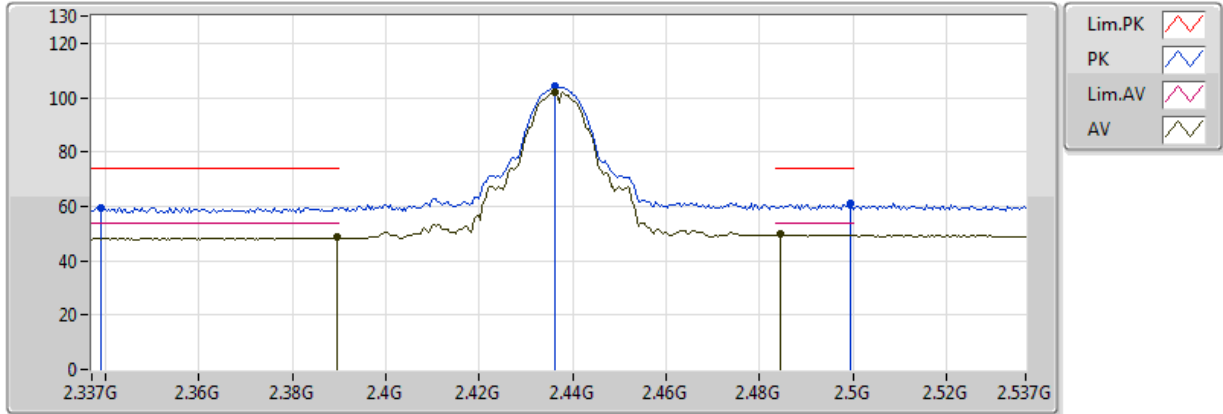





Type	Freq (Hz)	Level (dBuV/m)	Limit (dBuV/m)	Margin (dB)	Factor (dB)	Dist (m)	Condition	Azimuth (°)	Height (m)	Comments
AV	2.3894G	48.63	54.00	-5.37	32.27	3	Horizontal	316	2.72	-
AV	2.4362G	102.05	Inf	-Inf	32.44	3	Horizontal	316	2.72	-
AV	2.4846G	49.63	54.00	-4.37	32.61	3	Horizontal	316	2.72	-
PK	2.339G	59.62	74.00	-14.38	32.09	3	Horizontal	316	2.72	-
PK	2.4362G	103.99	Inf	-Inf	32.44	3	Horizontal	316	2.72	-
PK	2.4994G	60.81	74.00	-13.19	32.67	3	Horizontal	316	2.72	-

### 802.11b\_Nss1,(1Mbps)\_1TX

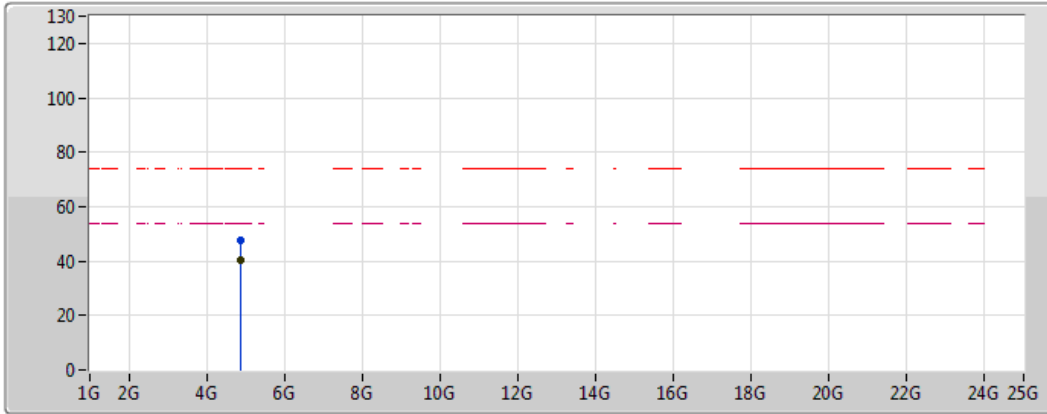
### 2437MHz\_TX

17/06/2018



Lim.PK	
PK	
Lim.AV	
AV	

Type	Freq (Hz)	Level (dBuV/m)	Limit (dBuV/m)	Margin (dB)	Factor (dB)	Dist (m)	Condition	Azimuth (°)	Height (m)	Comments
AV	4.87406G	40.57	54.00	-13.43	3.14	3	Vertical	111	2.17	-
PK	4.87396G	47.62	74.00	-26.38	3.14	3	Vertical	111	2.17	-



### 802.11b\_Nss1,(1Mbps)\_1TX

### 2437MHz\_TX

17/06/2018

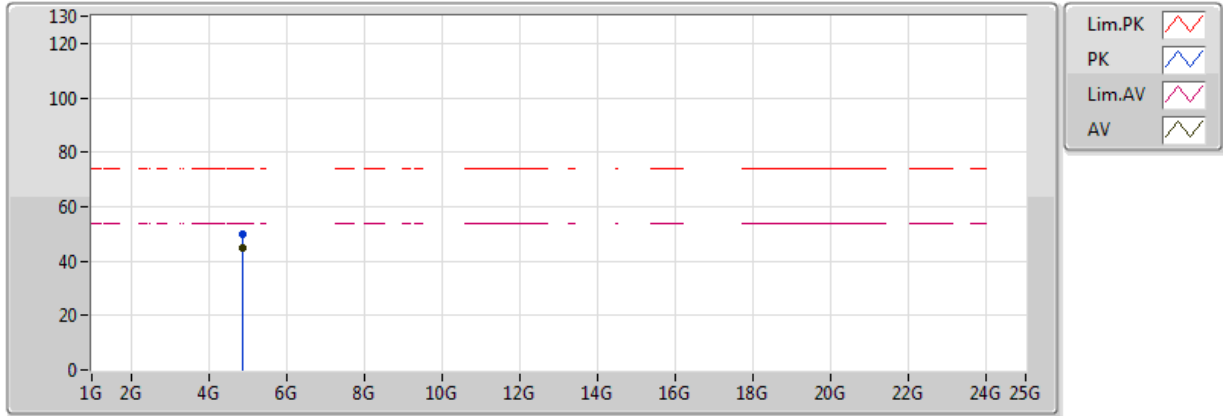

Type	Freq (Hz)	Level (dBuV/m)	Limit (dBuV/m)	Margin (dB)	Factor (dB)	Dist (m)	Condition	Azimuth (°)	Height (m)	Comments
AV	4.87396G	44.56	54.00	-9.44	3.14	3	Horizontal	360	1.11	-
PK	4.87424G	49.75	74.00	-24.25	3.14	3	Horizontal	360	1.11	-

### 802.11g\_Nss1,(6Mbps)\_1TX

### 2412MHz\_TX

22/06/2018

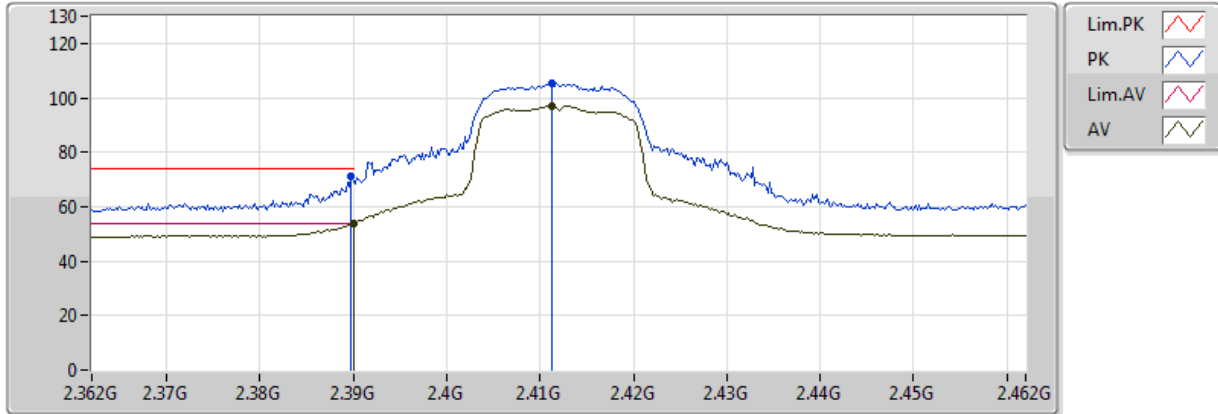

Type	Freq (Hz)	Level (dBuV/m)	Limit (dBuV/m)	Margin (dB)	Factor (dB)	Dist (m)	Condition	Azimuth (°)	Height (m)	Comments
AV	2.389998G	53.66	54.00	-0.34	32.28	3	Vertical	51	3.19	-
AV	2.4112G	97.10	Inf	-Inf	32.35	3	Vertical	51	3.19	-
PK	2.3898G	70.93	74.00	-3.07	32.28	3	Vertical	51	3.19	-
PK	2.4112G	105.38	Inf	-Inf	32.35	3	Vertical	51	3.19	-

### 802.11g\_Nss1,(6Mbps)\_1TX

### 2412MHz\_TX

22/06/2018

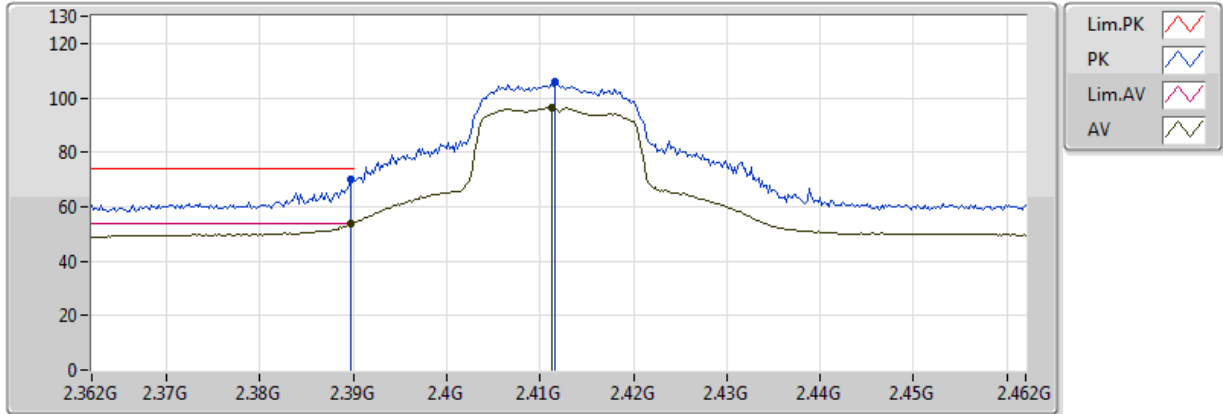

Type	Freq (Hz)	Level (dBuV/m)	Limit (dBuV/m)	Margin (dB)	Factor (dB)	Dist (m)	Condition	Azimuth (°)	Height (m)	Comments
AV	2.3898G	53.81	54.00	-0.19	32.28	3	Horizontal	324	3.15	-
AV	2.4112G	96.46	Inf	-Inf	32.35	3	Horizontal	324	3.15	-
PK	2.3898G	70.03	74.00	-3.97	32.28	3	Horizontal	324	3.15	-
PK	2.4116G	106.05	Inf	-Inf	32.35	3	Horizontal	324	3.15	-

### 802.11g\_Nss1,(6Mbps)\_1TX

### 2412MHz\_TX

22/06/2018

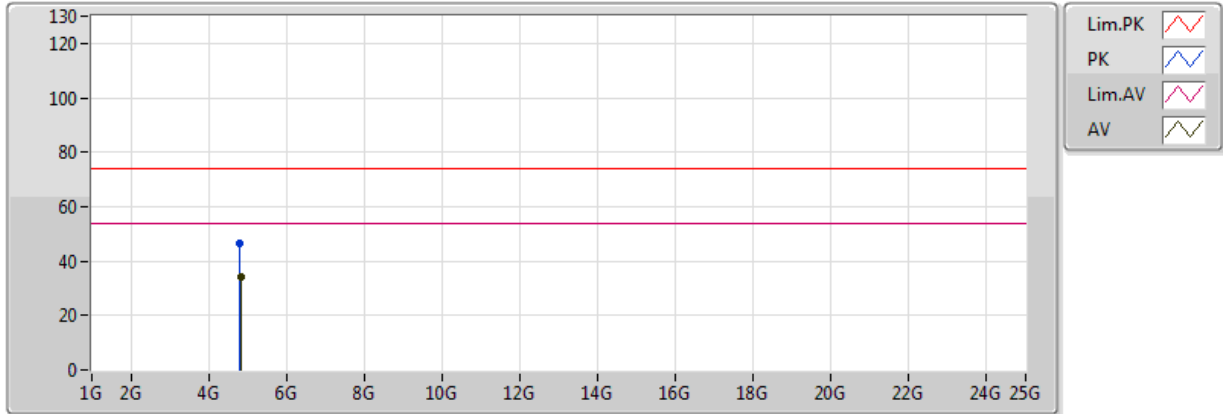

Type	Freq (Hz)	Level (dBuV/m)	Limit (dBuV/m)	Margin (dB)	Factor (dB)	Dist (m)	Condition	Azimuth (°)	Height (m)	Comments
AV	4.82394G	34.43	54.00	-19.57	3.03	3	Vertical	307	1.67	-
PK	4.81542G	46.44	74.00	-27.56	3.01	3	Vertical	307	1.67	-

### 802.11g\_Nss1,(6Mbps)\_1TX

### 2412MHz\_TX

22/06/2018

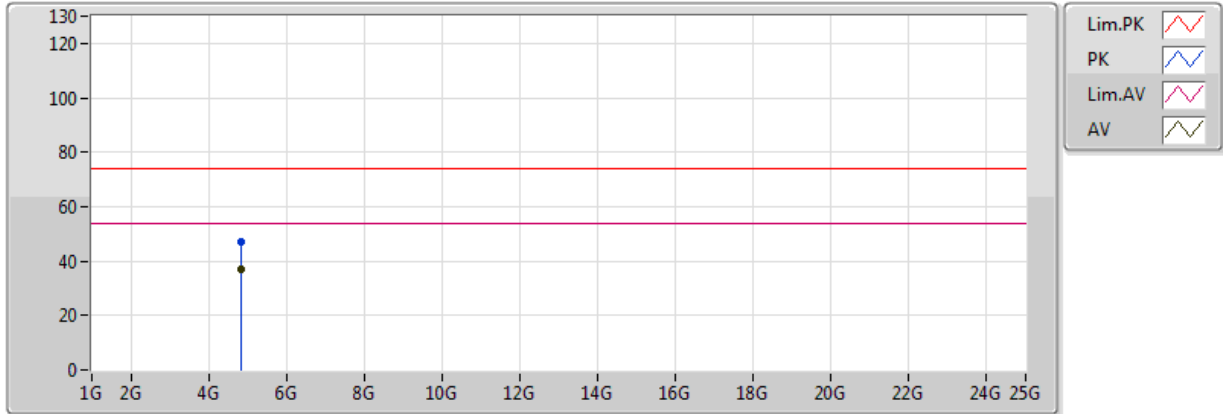

Type	Freq (Hz)	Level (dBuV/m)	Limit (dBuV/m)	Margin (dB)	Factor (dB)	Dist (m)	Condition	Azimuth (°)	Height (m)	Comments
AV	4.82394G	36.73	54.00	-17.27	3.03	3	Horizontal	66	1.09	-
PK	4.83216G	46.80	74.00	-27.20	3.05	3	Horizontal	66	1.09	-

### 802.11g\_Nss1,(6Mbps)\_1TX

### 2437MHz\_TX

17/06/2018

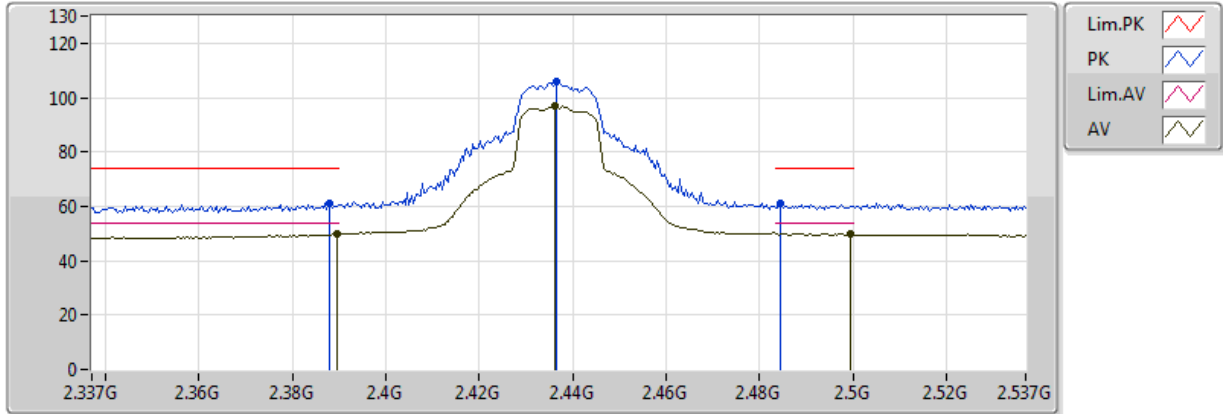

Type	Freq (Hz)	Level (dBuV/m)	Limit (dBuV/m)	Margin (dB)	Factor (dB)	Dist (m)	Condition	Azimuth (°)	Height (m)	Comments
AV	2.3894G	49.89	54.00	-4.11	32.27	3	Vertical	104	1.05	-
AV	2.4362G	96.97	Inf	-Inf	32.44	3	Vertical	104	1.05	-
AV	2.4994G	49.68	54.00	-4.32	32.67	3	Vertical	104	1.05	-
PK	2.3878G	60.82	74.00	-13.18	32.27	3	Vertical	104	1.05	-
PK	2.4366G	105.66	Inf	-Inf	32.44	3	Vertical	104	1.05	-
PK	2.4846G	60.83	74.00	-13.17	32.61	3	Vertical	104	1.05	-

### 802.11g\_Nss1,(6Mbps)\_1TX

### 2437MHz\_TX

17/06/2018

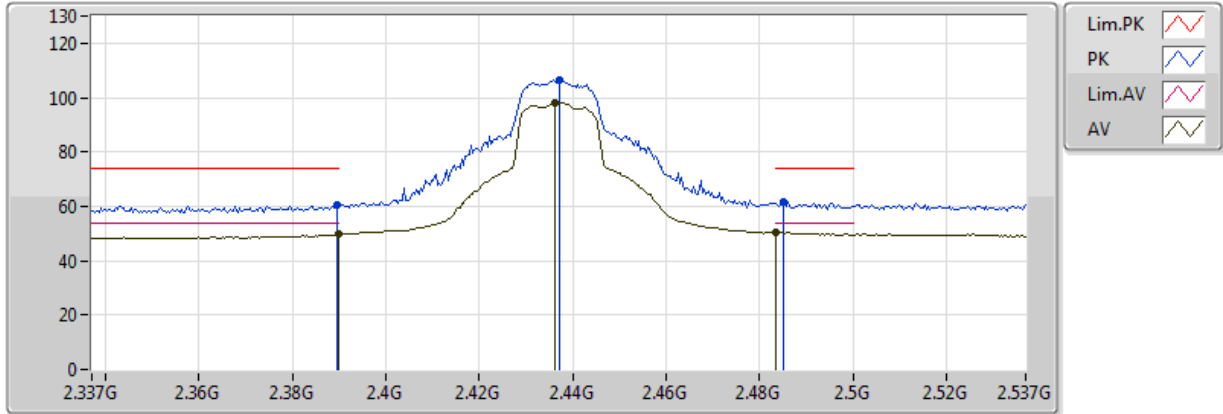

Type	Freq (Hz)	Level (dBuV/m)	Limit (dBuV/m)	Margin (dB)	Factor (dB)	Dist (m)	Condition	Azimuth (°)	Height (m)	Comments
AV	2.3898G	49.67	54.00	-4.33	32.28	3	Horizontal	317	2.73	-
AV	2.4362G	98.05	Inf	-Inf	32.44	3	Horizontal	317	2.73	-
AV	2.483502G	50.41	54.00	-3.59	32.61	3	Horizontal	317	2.73	-
PK	2.3894G	60.45	74.00	-13.55	32.27	3	Horizontal	317	2.73	-
PK	2.437G	106.47	Inf	-Inf	32.44	3	Horizontal	317	2.73	-
PK	2.485G	61.65	74.00	-12.35	32.61	3	Horizontal	317	2.73	-

### 802.11g\_Nss1,(6Mbps)\_1TX

### 2437MHz\_TX

17/06/2018

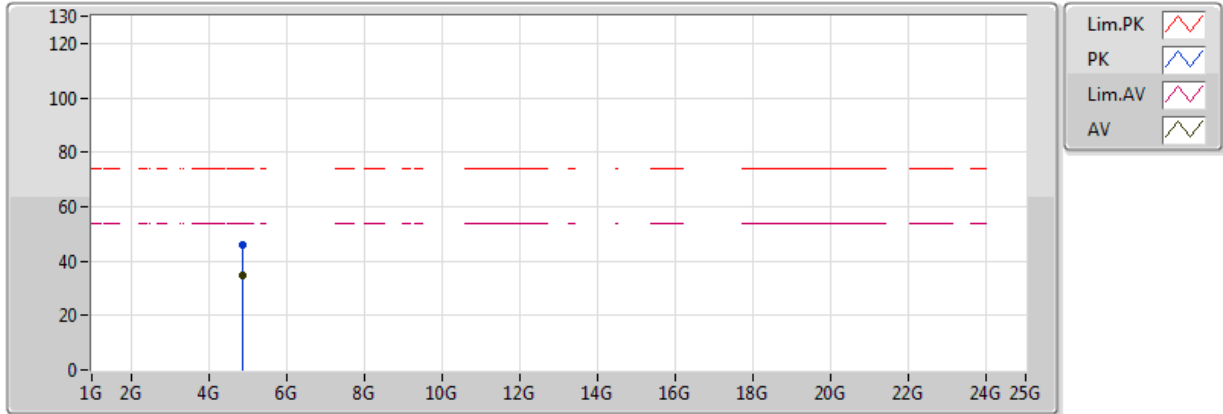

Type	Freq (Hz)	Level (dBuV/m)	Limit (dBuV/m)	Margin (dB)	Factor (dB)	Dist (m)	Condition	Azimuth (°)	Height (m)	Comments
AV	4.87408G	34.68	54.00	-19.32	3.14	3	Vertical	353	1.50	-
PK	4.87384G	46.15	74.00	-27.85	3.14	3	Vertical	353	1.50	-



### 802.11g\_Nss1,(6Mbps)\_1TX

### 2437MHz\_TX

17/06/2018

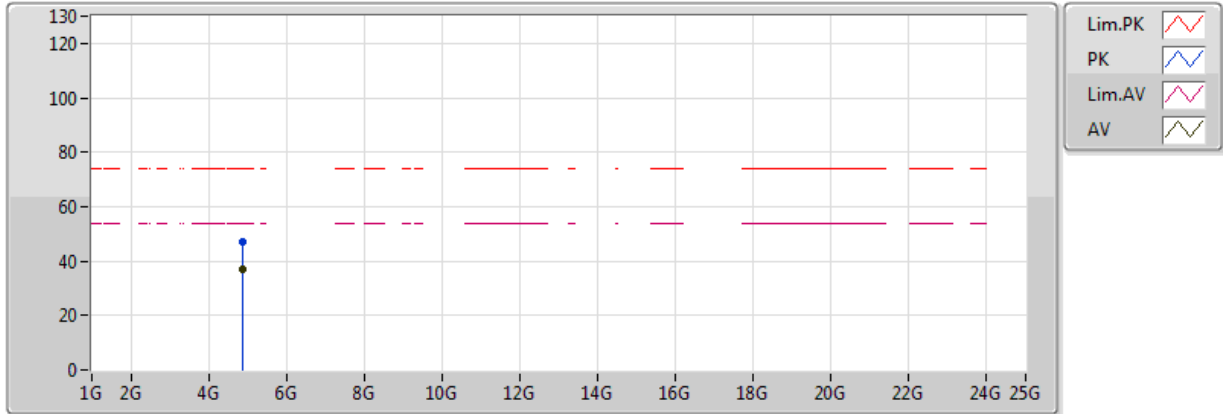

Type	Freq (Hz)	Level (dBuV/m)	Limit (dBuV/m)	Margin (dB)	Factor (dB)	Dist (m)	Condition	Azimuth (°)	Height (m)	Comments
AV	4.87408G	36.95	54.00	-17.05	3.14	3	Horizontal	62	1.03	-
PK	4.88056G	47.17	74.00	-26.83	3.16	3	Horizontal	62	1.03	-

### 802.11g\_Nss1,(6Mbps)\_1TX

### 2462MHz\_TX

22/06/2018

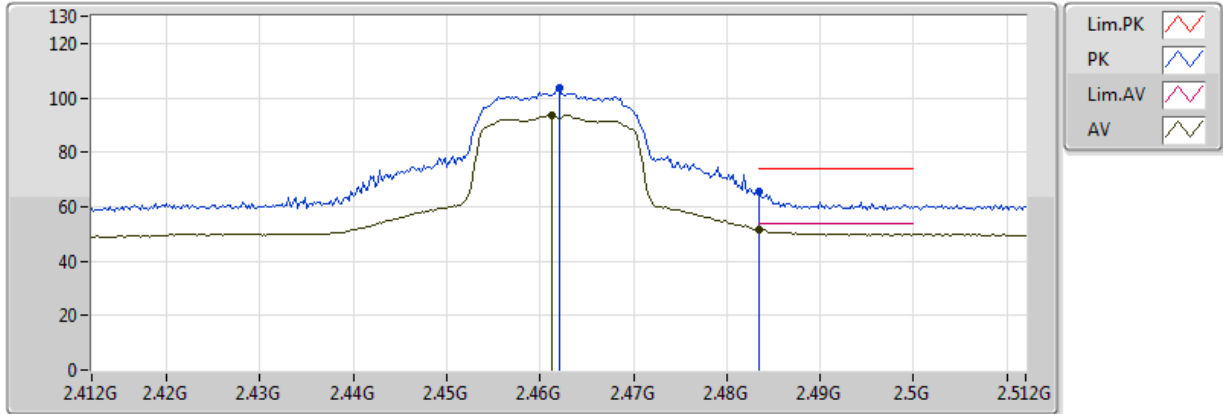

Type	Freq (Hz)	Level (dBuV/m)	Limit (dBuV/m)	Margin (dB)	Factor (dB)	Dist (m)	Condition	Azimuth (°)	Height (m)	Comments
AV	2.4612G	93.62	Inf	-Inf	32.53	3	Vertical	69	1.01	-
AV	2.483502G	51.35	54.00	-2.65	32.61	3	Vertical	69	1.01	-
PK	2.462G	103.77	Inf	-Inf	32.53	3	Vertical	69	1.01	-
PK	2.483502G	65.42	74.00	-8.58	32.61	3	Vertical	69	1.01	-

### 802.11g\_Nss1,(6Mbps)\_1TX

### 2462MHz\_TX

22/06/2018

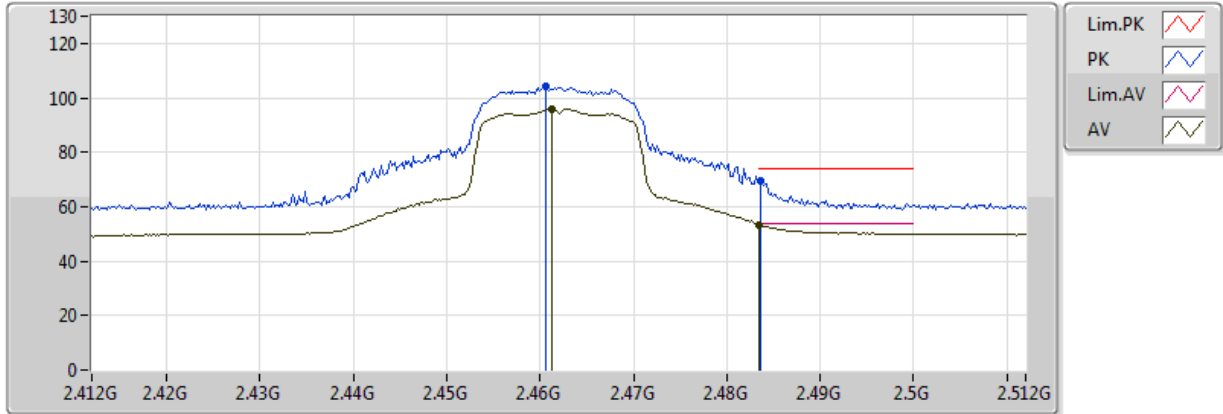

Type	Freq (Hz)	Level (dBuV/m)	Limit (dBuV/m)	Margin (dB)	Factor (dB)	Dist (m)	Condition	Azimuth (°)	Height (m)	Comments
AV	2.4612G	95.70	Inf	-Inf	32.53	3	Horizontal	327	3.03	-
AV	2.483502G	53.51	54.00	-0.49	32.61	3	Horizontal	327	3.03	-
PK	2.4606G	104.06	Inf	-Inf	32.53	3	Horizontal	327	3.03	-
PK	2.4836G	69.76	74.00	-4.24	32.61	3	Horizontal	327	3.03	-

### 802.11g\_Nss1,(6Mbps)\_1TX

### 2462MHz\_TX

22/06/2018

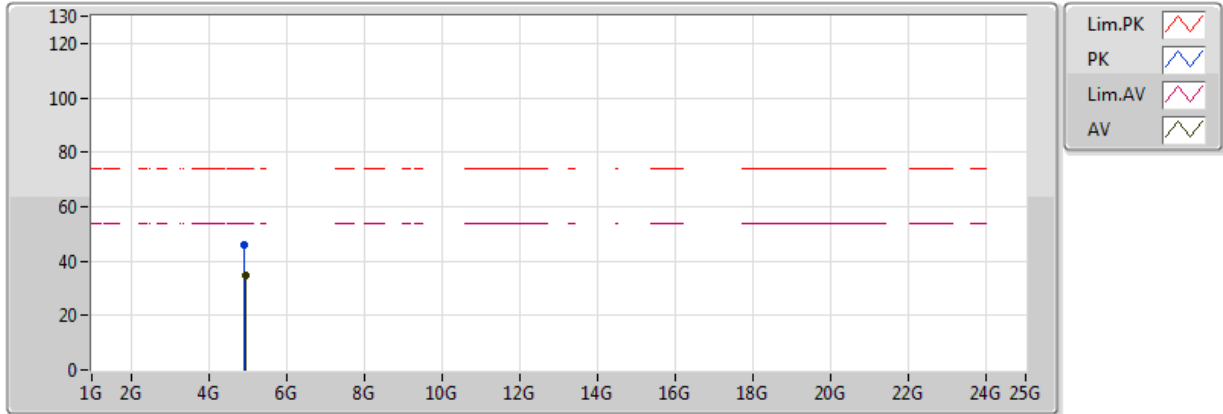

Type	Freq (Hz)	Level (dBuV/m)	Limit (dBuV/m)	Margin (dB)	Factor (dB)	Dist (m)	Condition	Azimuth (°)	Height (m)	Comments
AV	4.93588G	34.64	54.00	-19.36	3.28	3	Vertical	181	1.37	-
PK	4.92688G	45.90	74.00	-28.10	3.26	3	Vertical	181	1.37	-

### 802.11g\_Nss1,(6Mbps)\_1TX

### 2462MHz\_TX

22/06/2018

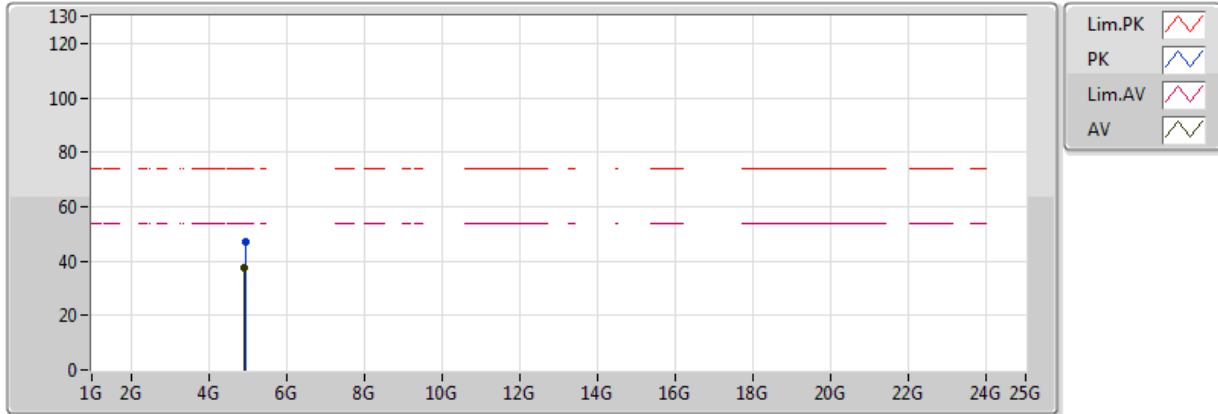

Type	Freq (Hz)	Level (dBuV/m)	Limit (dBuV/m)	Margin (dB)	Factor (dB)	Dist (m)	Condition	Azimuth (°)	Height (m)	Comments
AV	4.92406G	37.58	54.00	-16.42	3.25	3	Horizontal	59	1.07	-
PK	4.93696G	46.93	74.00	-27.07	3.28	3	Horizontal	59	1.07	-

### 802.11g\_Nss1,(6Mbps)\_1TX

### 2417MHz\_TX

17/06/2018

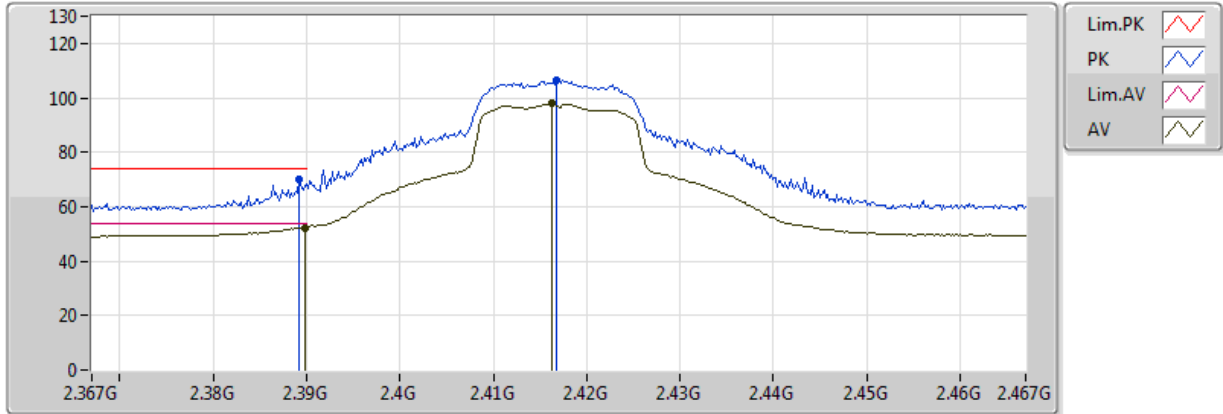

Type	Freq (Hz)	Level (dBuV/m)	Limit (dBuV/m)	Margin (dB)	Factor (dB)	Dist (m)	Condition	Azimuth (°)	Height (m)	Comments
AV	2.3898G	52.35	54.00	-1.65	32.28	3	Vertical	49	3.19	-
AV	2.4162G	97.86	Inf	-Inf	32.37	3	Vertical	49	3.19	-
PK	2.3892G	70.12	74.00	-3.88	32.27	3	Vertical	49	3.19	-
PK	2.4168G	106.71	Inf	-Inf	32.37	3	Vertical	49	3.19	-

### 802.11g\_Nss1,(6Mbps)\_1TX

### 2417MHz\_TX

17/06/2018

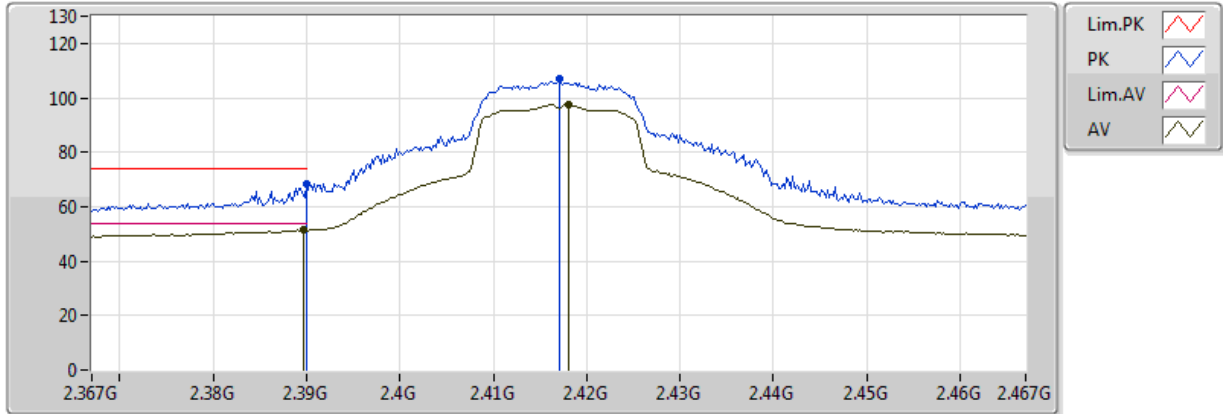





Type	Freq (Hz)	Level (dBuV/m)	Limit (dBuV/m)	Margin (dB)	Factor (dB)	Dist (m)	Condition	Azimuth (°)	Height (m)	Comments
AV	2.3896G	51.41	54.00	-2.59	32.28	3	Horizontal	320	1.19	-
AV	2.418G	97.49	Inf	-Inf	32.37	3	Horizontal	320	1.19	-
PK	2.389998G	68.60	74.00	-5.40	32.28	3	Horizontal	320	1.19	-
PK	2.417G	106.76	Inf	-Inf	32.37	3	Horizontal	320	1.19	-

### 802.11g\_Nss1,(6Mbps)\_1TX

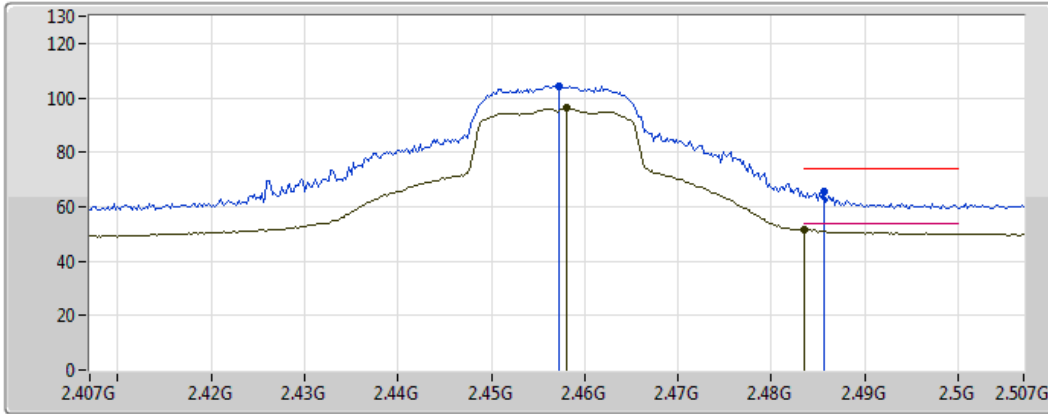
### 2457MHz\_TX

17/06/2018



Lim.PK	
PK	
Lim.AV	
AV	

Type	Freq (Hz)	Level (dBuV/m)	Limit (dBuV/m)	Margin (dB)	Factor (dB)	Dist (m)	Condition	Azimuth (°)	Height (m)	Comments
AV	2.458G	96.32	Inf	-Inf	32.52	3	Vertical	73	1.01	-
AV	2.483502G	51.57	54.00	-2.43	32.61	3	Vertical	73	1.01	-
PK	2.4572G	104.32	Inf	-Inf	32.52	3	Vertical	73	1.01	-
PK	2.4856G	65.60	74.00	-8.40	32.62	3	Vertical	73	1.01	-



### 802.11g\_Nss1,(6Mbps)\_1TX

### 2457MHz\_TX

17/06/2018

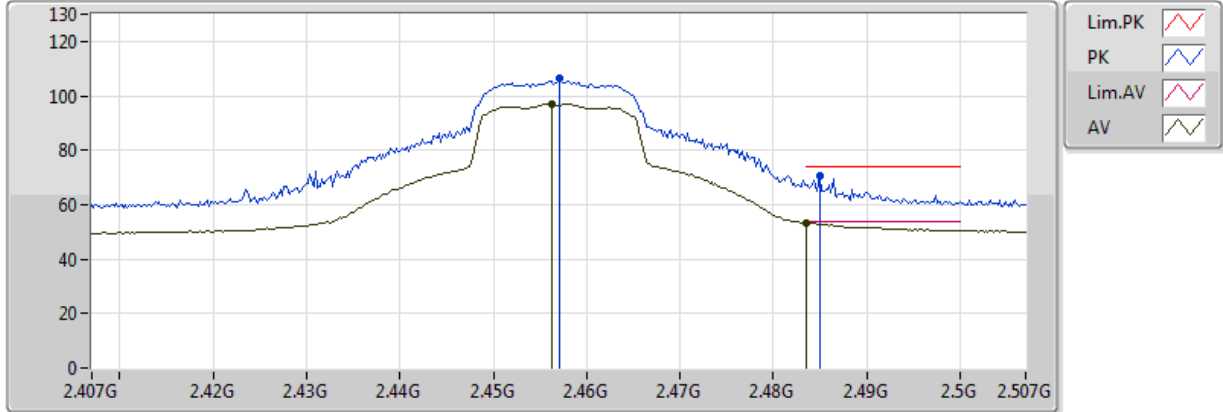

Type	Freq (Hz)	Level (dBuV/m)	Limit (dBuV/m)	Margin (dB)	Factor (dB)	Dist (m)	Condition	Azimuth (°)	Height (m)	Comments
AV	2.4562G	97.19	Inf	-Inf	32.51	3	Horizontal	325	1.50	-
AV	2.483502G	53.33	54.00	-0.67	32.61	3	Horizontal	325	1.50	-
PK	2.457G	106.64	Inf	-Inf	32.52	3	Horizontal	325	1.50	-
PK	2.485G	70.42	74.00	-3.58	32.61	3	Horizontal	325	1.50	-

### 802.11n HT20\_Nss1,(MCS0)\_1TX

### 2412MHz\_TX

22/06/2018

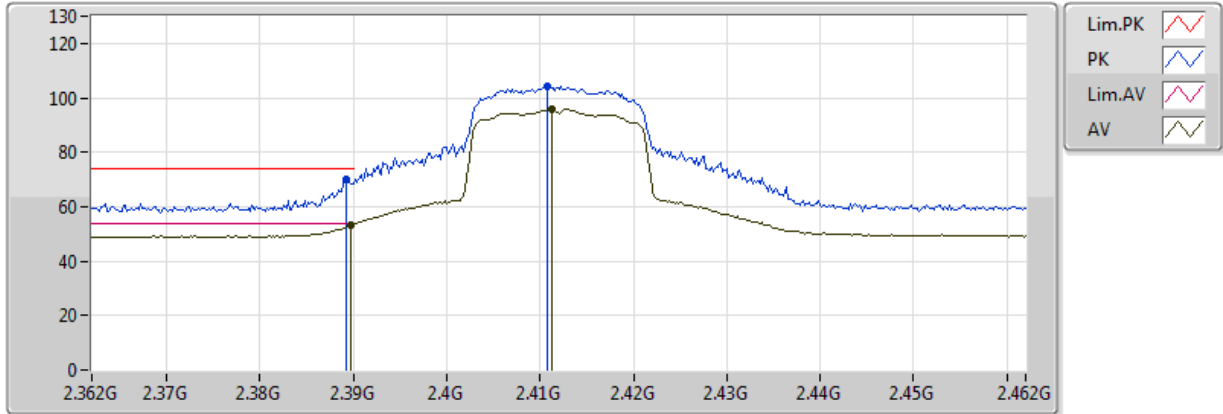

Type	Freq (Hz)	Level (dBuV/m)	Limit (dBuV/m)	Margin (dB)	Factor (dB)	Dist (m)	Condition	Azimuth (°)	Height (m)	Comments
AV	2.3898G	53.35	54.00	-0.65	32.28	3	Vertical	52	3.19	-
AV	2.4112G	95.80	Inf	-Inf	32.35	3	Vertical	52	3.19	-
PK	2.3892G	70.17	74.00	-3.83	32.27	3	Vertical	52	3.19	-
PK	2.4108G	104.07	Inf	-Inf	32.35	3	Vertical	52	3.19	-

### 802.11n HT20\_Nss1,(MCS0)\_1TX

### 2412MHz\_TX

22/06/2018

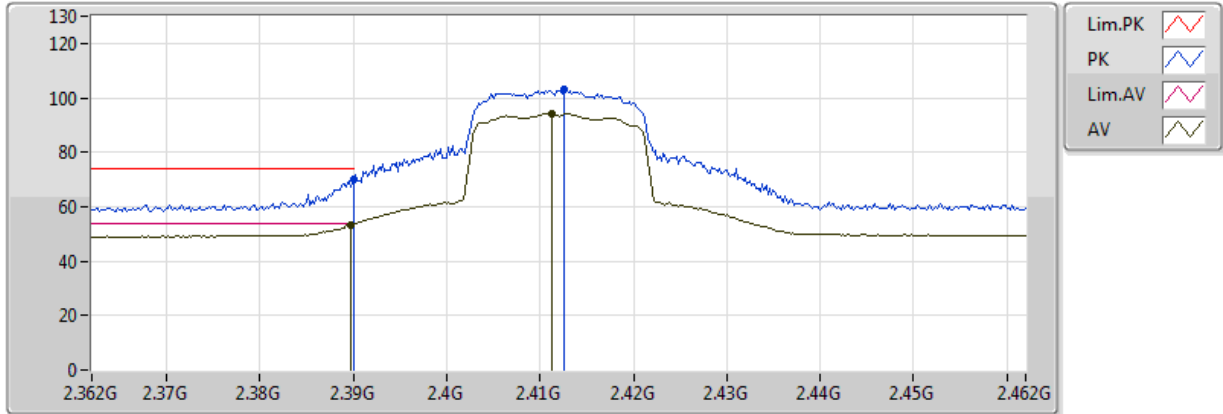

Type	Freq (Hz)	Level (dBuV/m)	Limit (dBuV/m)	Margin (dB)	Factor (dB)	Dist (m)	Condition	Azimuth (°)	Height (m)	Comments
AV	2.3898G	53.51	54.00	-0.49	32.28	3	Horizontal	179	3.17	-
AV	2.4112G	94.30	Inf	-Inf	32.35	3	Horizontal	179	3.17	-
PK	2.389998G	70.31	74.00	-3.69	32.28	3	Horizontal	179	3.17	-
PK	2.4126G	102.85	Inf	-Inf	32.36	3	Horizontal	179	3.17	-

### 802.11n HT20\_Nss1,(MCS0)\_1TX

### 2412MHz\_TX

22/06/2018

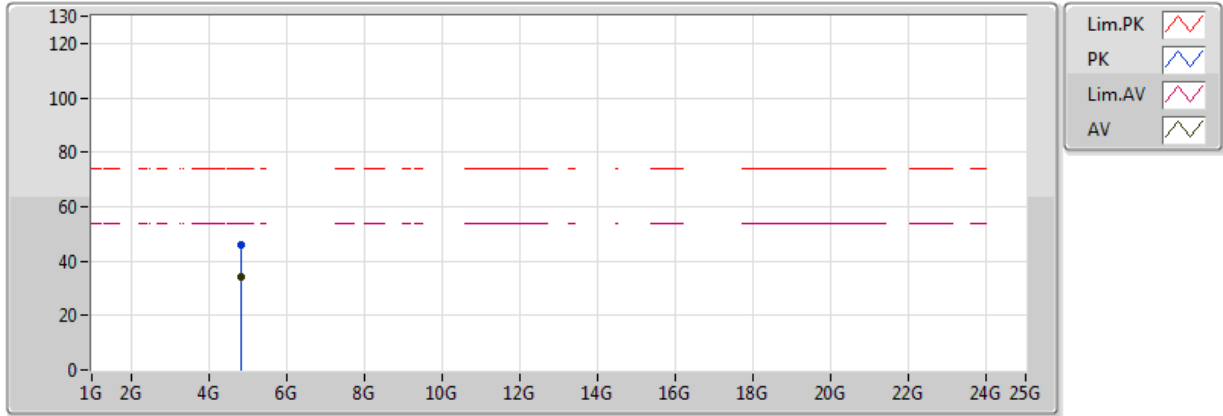

Type	Freq (Hz)	Level (dBuV/m)	Limit (dBuV/m)	Margin (dB)	Factor (dB)	Dist (m)	Condition	Azimuth (°)	Height (m)	Comments
AV	4.82388G	34.43	54.00	-19.57	3.03	3	Vertical	224	1.78	-
PK	4.82394G	46.21	74.00	-27.79	3.03	3	Vertical	224	1.78	-

### 802.11n HT20\_Nss1,(MCS0)\_1TX

### 2412MHz\_TX

22/06/2018

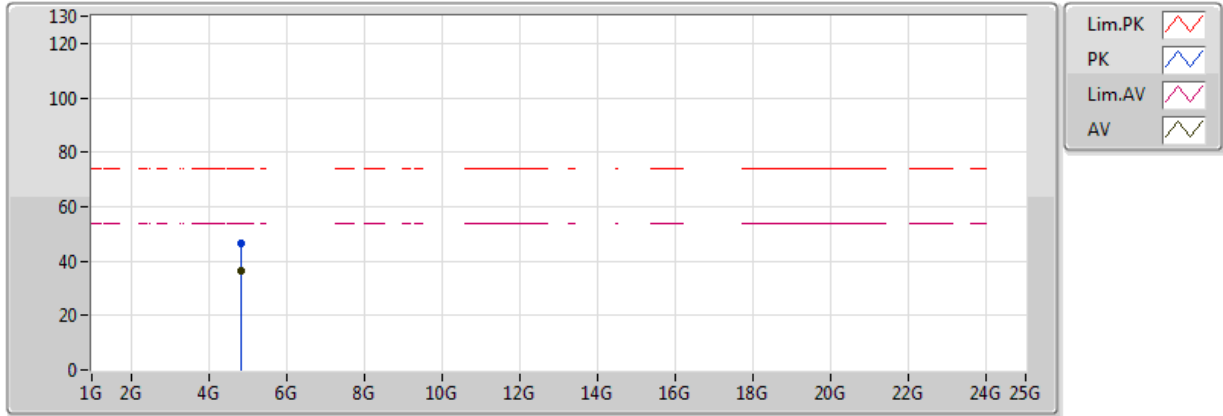

Type	Freq (Hz)	Level (dBuV/m)	Limit (dBuV/m)	Margin (dB)	Factor (dB)	Dist (m)	Condition	Azimuth (°)	Height (m)	Comments
AV	4.824G	36.51	54.00	-17.49	3.03	3	Horizontal	65	1.04	-
PK	4.82994G	46.70	74.00	-27.30	3.05	3	Horizontal	65	1.04	-

### 802.11n HT20\_Nss1,(MCS0)\_1TX

### 2437MHz\_TX

17/06/2018

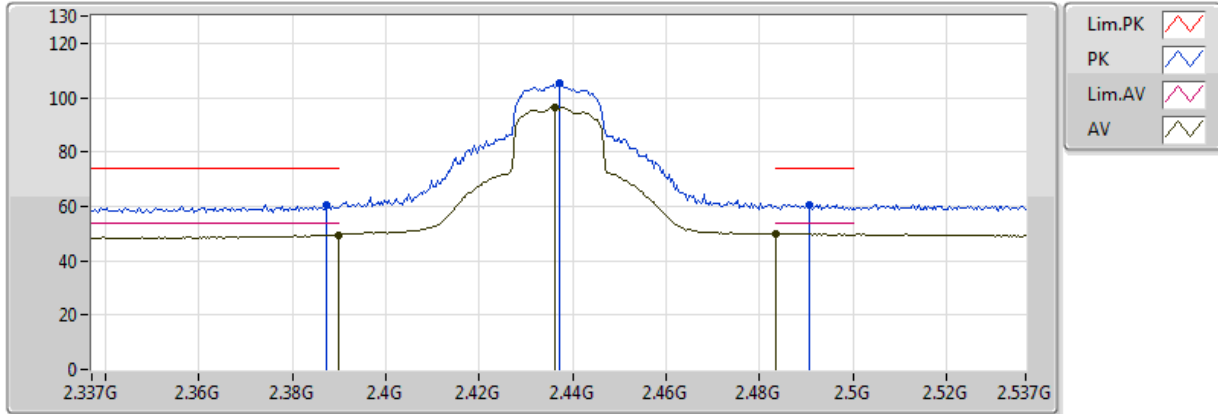

Type	Freq (Hz)	Level (dBuV/m)	Limit (dBuV/m)	Margin (dB)	Factor (dB)	Dist (m)	Condition	Azimuth (°)	Height (m)	Comments
AV	2.3898G	49.43	54.00	-4.57	32.28	3	Vertical	104	1.07	-
AV	2.4362G	96.56	Inf	-Inf	32.44	3	Vertical	104	1.07	-
AV	2.483502G	49.90	54.00	-4.10	32.61	3	Vertical	104	1.07	-
PK	2.3874G	60.62	74.00	-13.38	32.26	3	Vertical	104	1.07	-
PK	2.437G	105.11	Inf	-Inf	32.44	3	Vertical	104	1.07	-
PK	2.4906G	60.71	74.00	-13.29	32.64	3	Vertical	104	1.07	-

### 802.11n HT20\_Nss1,(MCS0)\_1TX

### 2437MHz\_TX

17/06/2018

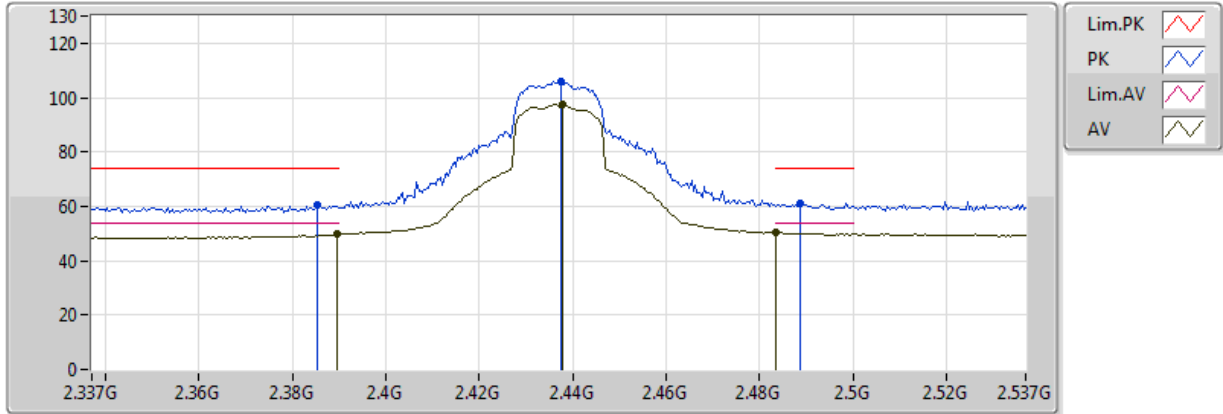

Type	Freq (Hz)	Level (dBuV/m)	Limit (dBuV/m)	Margin (dB)	Factor (dB)	Dist (m)	Condition	Azimuth (°)	Height (m)	Comments
AV	2.3894G	49.66	54.00	-4.34	32.27	3	Horizontal	317	2.74	-
AV	2.4378G	97.58	Inf	-Inf	32.45	3	Horizontal	317	2.74	-
AV	2.483502G	50.16	54.00	-3.84	32.61	3	Horizontal	317	2.74	-
PK	2.3854G	60.65	74.00	-13.35	32.25	3	Horizontal	317	2.74	-
PK	2.4374G	105.84	Inf	-Inf	32.44	3	Horizontal	317	2.74	-
PK	2.4886G	60.92	74.00	-13.08	32.63	3	Horizontal	317	2.74	-

### 802.11n HT20\_Nss1,(MCS0)\_1TX

### 2437MHz\_TX

17/06/2018

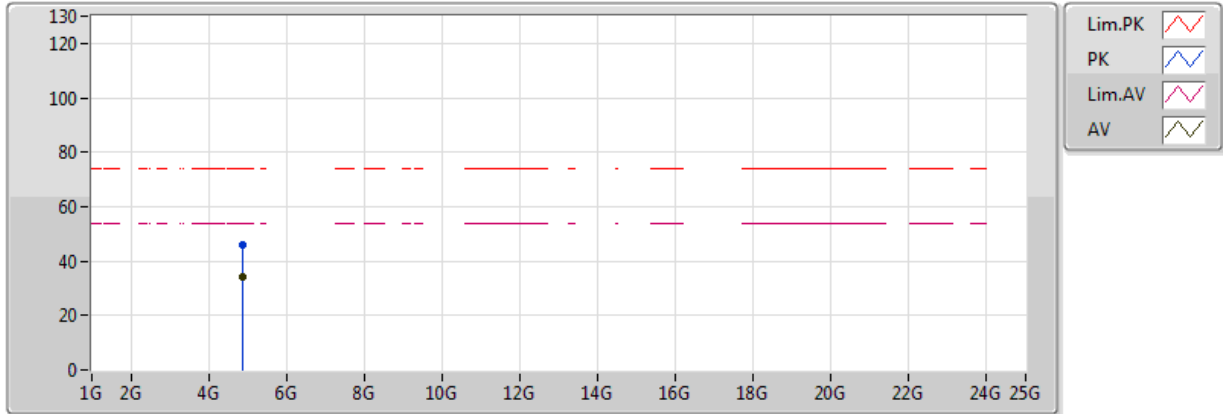

Type	Freq (Hz)	Level (dBuV/m)	Limit (dBuV/m)	Margin (dB)	Factor (dB)	Dist (m)	Condition	Azimuth (°)	Height (m)	Comments
AV	4.86664G	33.92	54.00	-20.08	3.13	3	Vertical	254	1.56	-
PK	4.87836G	45.67	74.00	-28.33	3.15	3	Vertical	254	1.56	-



### 802.11n HT20\_Nss1,(MCS0)\_1TX

### 2437MHz\_TX

17/06/2018

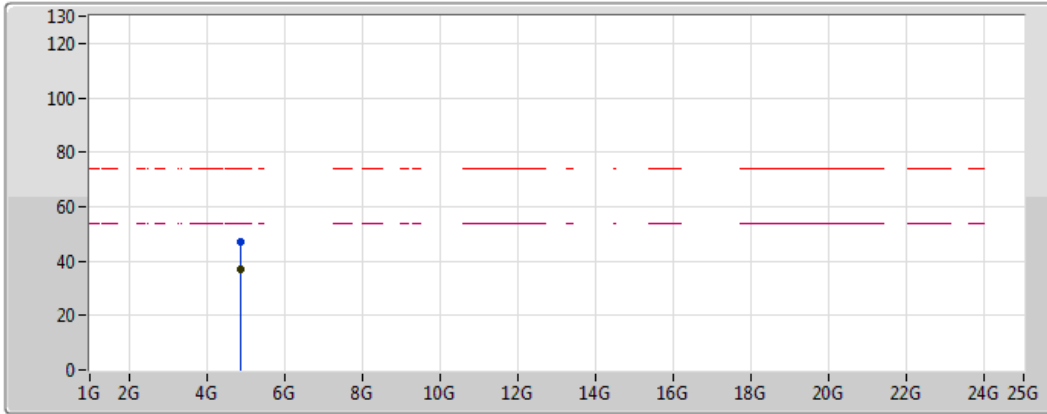

Type	Freq (Hz)	Level (dBuV/m)	Limit (dBuV/m)	Margin (dB)	Factor (dB)	Dist (m)	Condition	Azimuth (°)	Height (m)	Comments
AV	4.87396G	36.75	54.00	-17.25	3.14	3	Horizontal	62	1.01	-
PK	4.87392G	46.88	74.00	-27.12	3.14	3	Horizontal	62	1.01	-

### 802.11n HT20\_Nss1,(MCS0)\_1TX

### 2462MHz\_TX

22/06/2018

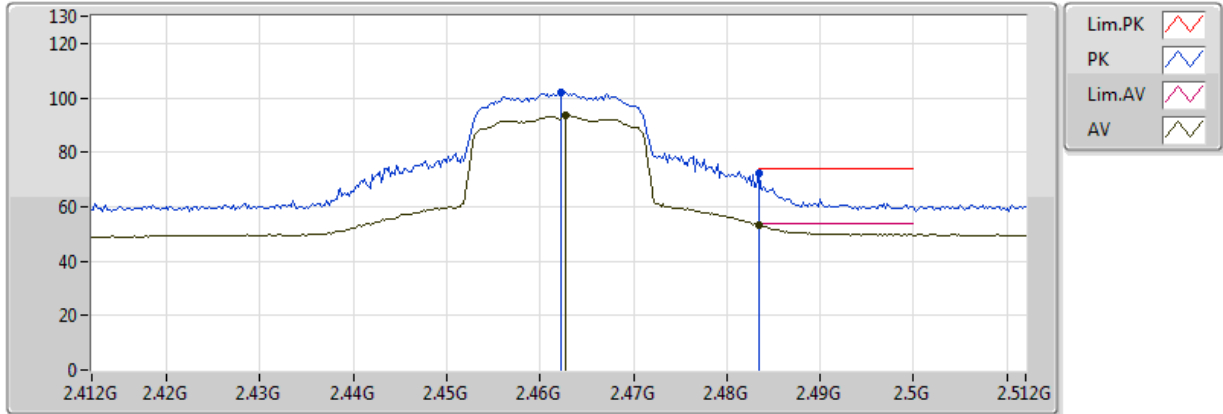

Type	Freq (Hz)	Level (dBuV/m)	Limit (dBuV/m)	Margin (dB)	Factor (dB)	Dist (m)	Condition	Azimuth (°)	Height (m)	Comments
AV	2.4628G	93.45	Inf	-Inf	32.54	3	Vertical	54	3.06	-
AV	2.483502G	53.15	54.00	-0.85	32.61	3	Vertical	54	3.06	-
PK	2.4622G	101.77	Inf	-Inf	32.53	3	Vertical	54	3.06	-
PK	2.483502G	72.49	74.00	-1.51	32.61	3	Vertical	54	3.06	-

### 802.11n HT20\_Nss1,(MCS0)\_1TX

### 2462MHz\_TX

22/06/2018

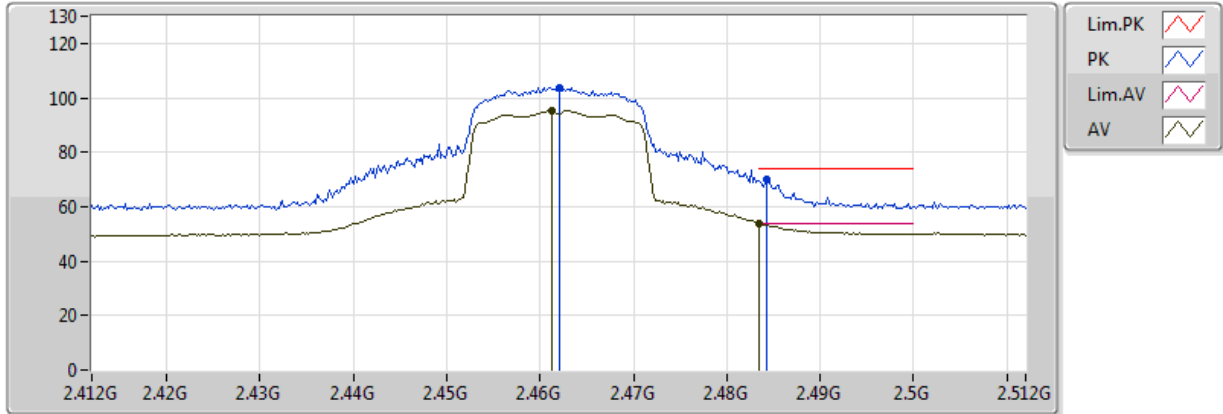

Type	Freq (Hz)	Level (dBuV/m)	Limit (dBuV/m)	Margin (dB)	Factor (dB)	Dist (m)	Condition	Azimuth (°)	Height (m)	Comments
AV	2.4612G	95.24	Inf	-Inf	32.53	3	Horizontal	325	3.01	-
AV	2.483502G	53.85	54.00	-0.15	32.61	3	Horizontal	325	3.01	-
PK	2.462G	103.93	Inf	-Inf	32.53	3	Horizontal	325	3.01	-
PK	2.4842G	69.81	74.00	-4.19	32.61	3	Horizontal	325	3.01	-

### 802.11n HT20\_Nss1,(MCS0)\_1TX

### 2462MHz\_TX

22/06/2018

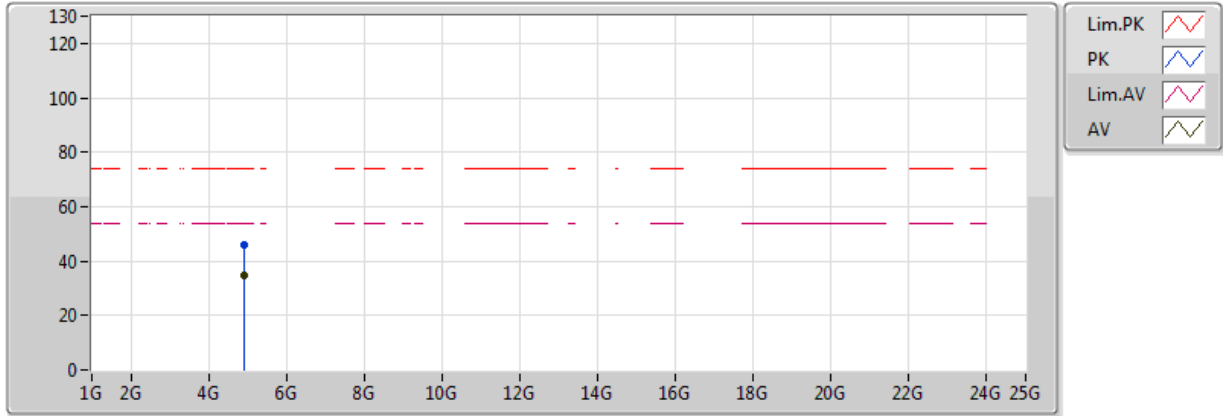

Type	Freq (Hz)	Level (dBuV/m)	Limit (dBuV/m)	Margin (dB)	Factor (dB)	Dist (m)	Condition	Azimuth (°)	Height (m)	Comments
AV	4.93186G	34.65	54.00	-19.35	3.27	3	Vertical	135	1.33	-
PK	4.92286G	45.86	74.00	-28.14	3.25	3	Vertical	135	1.33	-

### 802.11n HT20\_Nss1,(MCS0)\_1TX

### 2462MHz\_TX

22/06/2018

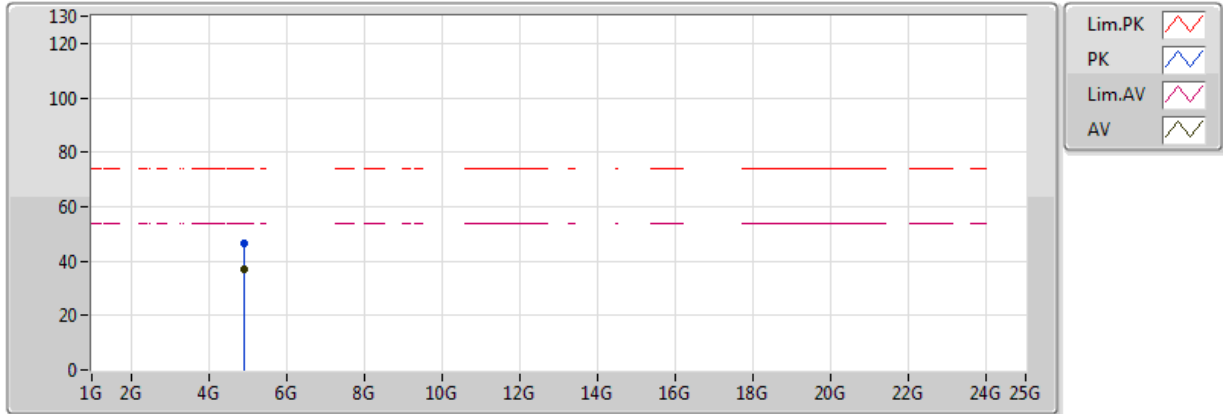

Type	Freq (Hz)	Level (dBuV/m)	Limit (dBuV/m)	Margin (dB)	Factor (dB)	Dist (m)	Condition	Azimuth (°)	Height (m)	Comments
AV	4.924G	36.80	54.00	-17.20	3.25	3	Horizontal	58	1.06	-
PK	4.93114G	46.77	74.00	-27.23	3.27	3	Horizontal	58	1.06	-

### 802.11n HT20\_Nss1,(MCS0)\_1TX

### 2417MHz\_TX

17/06/2018

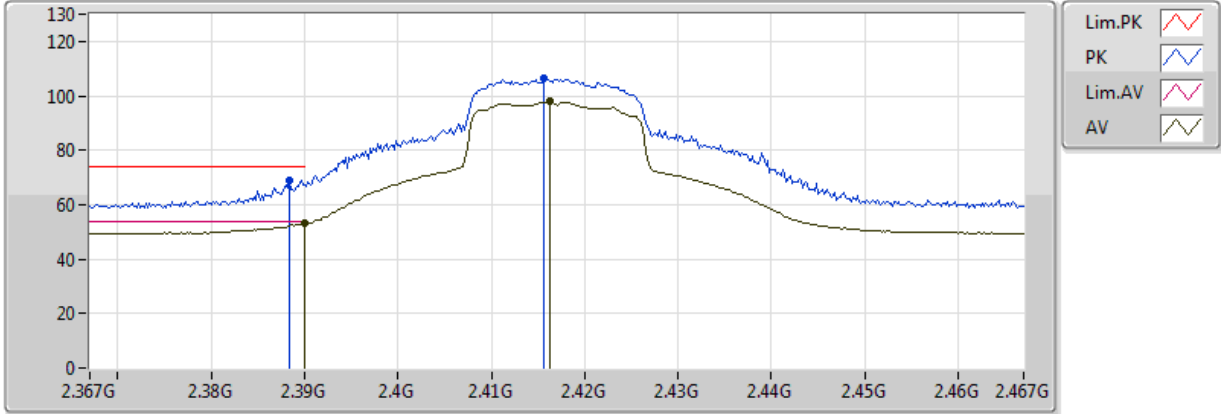

Type	Freq (Hz)	Level (dBuV/m)	Limit (dBuV/m)	Margin (dB)	Factor (dB)	Dist (m)	Condition	Azimuth (°)	Height (m)	Comments
AV	2.389998G	53.33	54.00	-0.67	32.27	3	Vertical	62	1.03	-
AV	2.4162G	97.89	Inf	-Inf	32.37	3	Vertical	51	3.19	-
PK	2.3884G	68.72	74.00	-5.28	32.27	3	Vertical	51	3.19	-
PK	2.4156G	106.59	Inf	-Inf	32.37	3	Vertical	51	3.19	-

### 802.11n HT20\_Nss1,(MCS0)\_1TX

### 2417MHz\_TX

17/06/2018

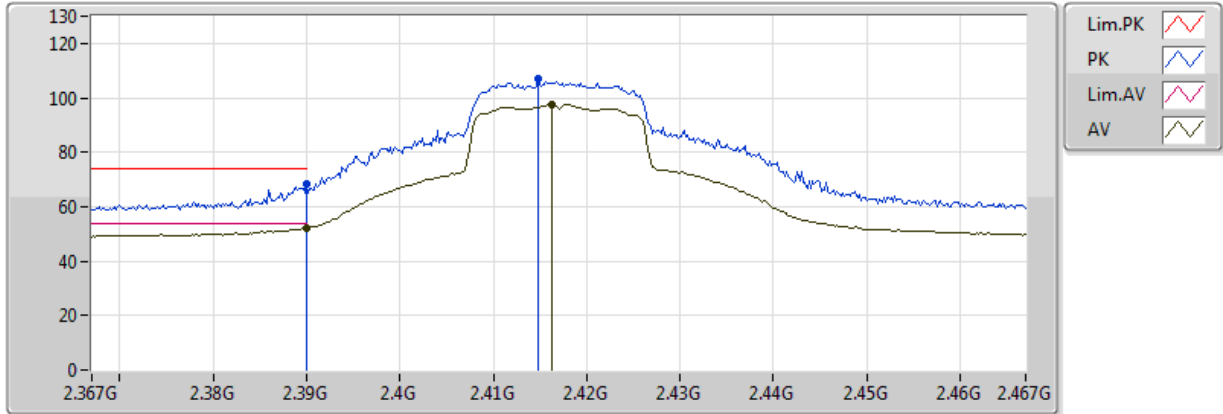

Type	Freq (Hz)	Level (dBuV/m)	Limit (dBuV/m)	Margin (dB)	Factor (dB)	Dist (m)	Condition	Azimuth (°)	Height (m)	Comments
AV	2.389998G	52.17	54.00	-1.83	32.28	3	Horizontal	326	2.77	-
AV	2.4162G	97.51	Inf	-Inf	32.37	3	Horizontal	326	2.77	-
PK	2.389998G	68.36	74.00	-5.64	32.28	3	Horizontal	326	2.77	-
PK	2.4148G	106.75	Inf	-Inf	32.36	3	Horizontal	326	2.77	-

### 802.11n HT20\_Nss1,(MCS0)\_1TX

### 2422MHz\_TX

17/06/2018

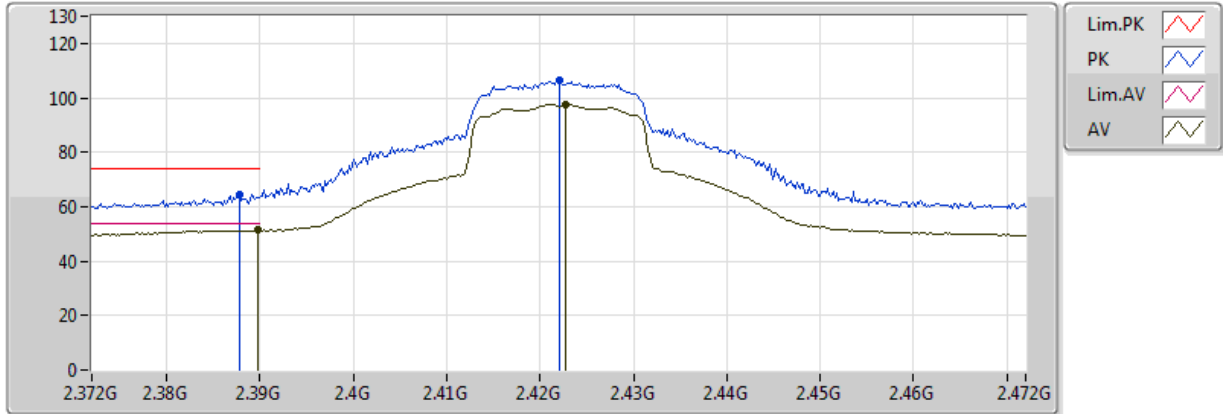

Type	Freq (Hz)	Level (dBuV/m)	Limit (dBuV/m)	Margin (dB)	Factor (dB)	Dist (m)	Condition	Azimuth (°)	Height (m)	Comments
AV	2.3898G	51.41	54.00	-2.59	32.28	3	Vertical	66	1.19	-
AV	2.4228G	97.75	Inf	-Inf	32.39	3	Vertical	66	1.19	-
PK	2.3878G	64.37	74.00	-9.63	32.27	3	Vertical	66	1.19	-
PK	2.422G	106.39	Inf	-Inf	32.39	3	Vertical	66	1.19	-



### 802.11n HT20\_Nss1,(MCS0)\_1TX

### 2422MHz\_TX

17/06/2018

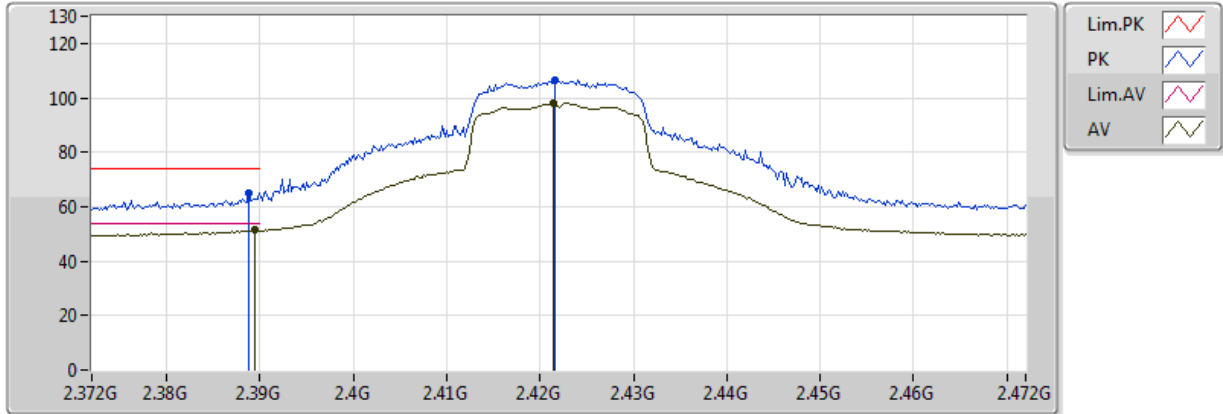

Type	Freq (Hz)	Level (dBuV/m)	Limit (dBuV/m)	Margin (dB)	Factor (dB)	Dist (m)	Condition	Azimuth (°)	Height (m)	Comments
AV	2.3894G	51.40	54.00	-2.60	32.27	3	Horizontal	336	3.16	-
AV	2.4214G	98.04	Inf	-Inf	32.39	3	Horizontal	336	3.16	-
PK	2.3888G	65.22	74.00	-8.78	32.27	3	Horizontal	336	3.16	-
PK	2.4216G	106.57	Inf	-Inf	32.39	3	Horizontal	336	3.16	-

### 802.11n HT20\_Nss1,(MCS0)\_1TX

### 2457MHz\_TX

17/06/2018

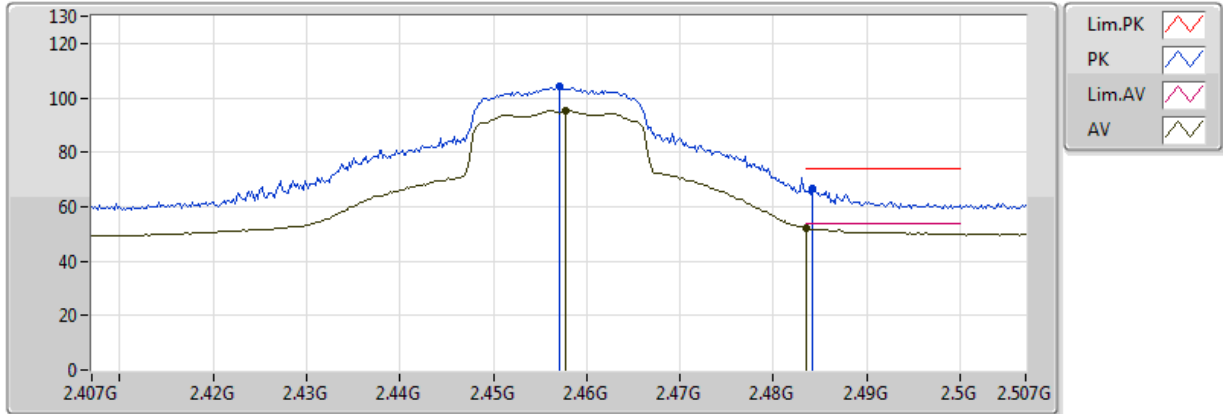

Type	Freq (Hz)	Level (dBuV/m)	Limit (dBuV/m)	Margin (dB)	Factor (dB)	Dist (m)	Condition	Azimuth (°)	Height (m)	Comments
AV	2.4578G	95.38	Inf	-Inf	32.52	3	Vertical	65	1.00	-
AV	2.483502G	51.99	54.00	-2.01	32.61	3	Vertical	65	1.00	-
PK	2.457G	104.32	Inf	-Inf	32.52	3	Vertical	65	1.00	-
PK	2.4842G	66.78	74.00	-7.22	32.61	3	Vertical	65	1.00	-

### 802.11n HT20\_Nss1,(MCS0)\_1TX

### 2457MHz\_TX

17/06/2018

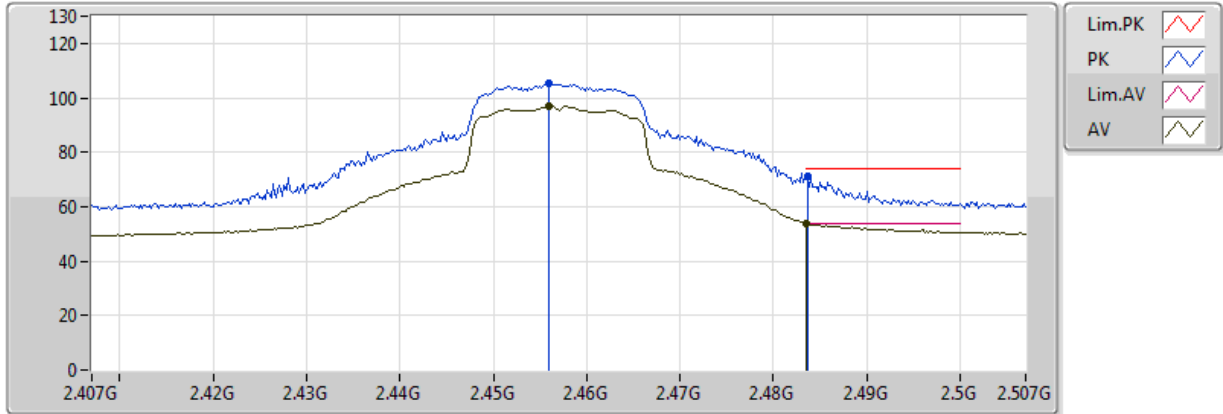

Type	Freq (Hz)	Level (dBuV/m)	Limit (dBuV/m)	Margin (dB)	Factor (dB)	Dist (m)	Condition	Azimuth (°)	Height (m)	Comments
AV	2.456G	96.96	Inf	-Inf	32.51	3	Horizontal	326	1.50	-
AV	2.483502G	53.68	54.00	-0.32	32.61	3	Horizontal	326	1.50	-
PK	2.456G	105.19	Inf	-Inf	32.51	3	Horizontal	326	1.50	-
PK	2.4836G	71.19	74.00	-2.81	32.61	3	Horizontal	326	1.50	-