

FCC Test Report

FCC ID : 2AEUPBHASC052
Equipment : Stick Up Cam Elite
Brand Name : Ring LLC
Model Name : Stick Up Cam Wired
Applicant : Ring LLC
1523 26th St, Santa Monica, CA 90404, USA
Manufacturer : Chicony Electronics Co.,Ltd.
No.69, Sec. 2, Guangfu Rd., Sanchong Dist. New
Taipei City 241 Taiwan
Standard : 47 CFR FCC Part 15.247

The product was received on Jun. 01, 2018, and testing was started from Jun. 18, 2018 and completed on Sep. 24, 2019. We, SPORTON INTERNATIONAL INC. EMC & Wireless Communications Laboratory, would like to declare that the tested sample has been evaluated in accordance with the procedures given in ANSI C63.10-2013 and shown compliance with the applicable technical standards.

The report must not be used by the client to claim product certification, approval, or endorsement by TAF or any agency of government.

The test results in this report apply exclusively to the tested model / sample. Without written approval of SPORTON INTERNATIONAL INC. EMC & Wireless Communications Laboratory, the test report shall not be reproduced except in full.



Approved by: Allen Lin

SPORTON INTERNATIONAL INC. EMC & Wireless Communications Laboratory

No. 52, Huaya 1st Rd., Guishan Dist., Taoyuan City, Taiwan (R.O.C.)



Table of Contents

HISTORY OF THIS TEST REPORT3

SUMMARY OF TEST RESULT4

1 GENERAL DESCRIPTION5

1.1 Information.....5

1.2 Testing Applied Standards7

1.3 Testing Location Information7

1.4 Measurement Uncertainty8

2 TEST CONFIGURATION OF EUT.....9

2.1 Test Condition9

2.2 Test Channel Mode9

2.3 The Worst Case Measurement Configuration.....10

2.4 Accessories and Support Equipment11

2.5 Test Setup Diagram13

3 TRANSMITTER TEST RESULT17

3.1 AC Power-line Conducted Emissions17

3.2 DTS Bandwidth.....19

3.3 Maximum Conducted Output Power20

3.4 Power Spectral Density22

3.5 Emissions in Non-restricted Frequency Bands23

3.6 Emissions in Restricted Frequency Bands.....24

4 TEST EQUIPMENT AND CALIBRATION DATA.....28

APPENDIX A. TEST RESULTS OF AC POWER-LINE CONDUCTED EMISSIONS

APPENDIX B. TEST RESULTS OF DTS BANDWIDTH

APPENDIX C. TEST RESULTS OF MAXIMUM CONDUCTED OUTPUT POWER

APPENDIX D. TEST RESULTS OF POWER SPECTRAL DENSITY

APPENDIX E. TEST RESULTS OF EMISSIONS IN NON-RESTRICTED FREQUENCY BANDS

APPENDIX F. TEST RESULTS OF EMISSIONS IN RESTRICTED FREQUENCY BANDS

APPENDIX G. TEST PHOTOS

PHOTOGRAPHS OF EUT V01



Summary of Test Result

Report Clause	Ref. Std. Clause	Test Items	Result (PASS/FAIL)	Remark
1.1.2	15.203	Antenna Requirement	PASS	FCC 15.203
3.1	15.207	AC Power-line Conducted Emissions	PASS	FCC 15.207
3.2	15.247(a)	DTS Bandwidth	PASS	≥500kHz
3.3	15.247(b)	Maximum Conducted Output Power	PASS	Power [dBm]:30
3.4	15.247(e)	Power Spectral Density	PASS	PSD [dBm/3kHz]:8
3.5	15.247(d)	Emissions in Non-restricted Frequency Bands	PASS	Non-Restricted Bands: >30 dBc
3.6	15.247(d)	Emissions in Restricted Frequency Bands	PASS	Restricted Bands: FCC 15.209

Reviewed by: Sam Tsai

Report Producer: Debby Hung

1 General Description

1.1 Information

1.1.1 RF General Information

Frequency Range (MHz)	Bluetooth Mode	Ch. Frequency (MHz)	Channel Number
2400-2483.5	LE	2402-2480	0-39 [40]

Band	Mode	BWch (MHz)	Nant
2.4-2.4835GHz	BT-LE(1Mbps)	1.0	1TX

Note:

- ♦ Bluetooth LE uses a GFSK (1Mbps) modulation for DSSS.
- ♦ BWch is the nominal channel bandwidth.

1.1.2 Antenna Information

Ant.	Port	Brand	Model Name	Antenna Type	Connector
1	1	-	Orion Wifi Antenna	PIFA Antenna	Fixed on board

2.4G		5G		BT	
Frequency (MHz)	Gain (dBi)	Frequency (MHz)	Gain (dBi)	Frequency (MHz)	Gain (dBi)
2412	0.94	5180	2.68	2402	0.94
2417	0.94	5200	2.68	2440	0.69
2422	0.94	5240	2.77	2480	0.10
2427	0.69	5190	2.68	-	-
2432	0.69	5230	2.77	-	-
2437	0.69	5745	3.12	-	-
2442	0.69	5785	2.65	-	-
2447	0.69	5825	1.67	-	-
2452	0.69	5755	3.12	-	-
2457	0.69	5795	2.65	-	-
2462	0.69	-	-	-	-

For 2.4 GHz function:

For IEEE 802.11b/g/n mode (1TX/1RX)

Only Ant. 1 (port 1) can be used as transmitting/receiving antenna.

For 5 GHz function:

For IEEE 802.11a/n mode (1TX/1RX)

Only Ant. 1 (port 1) can be used as transmitting/receiving antenna.

For Bluetooth function:

For Bluetooth mode (1TX/1RX)

Only Ant. 1 (port 1) can be used as transmitting/receiving antenna.

1.1.3 EUT Information

Operational Condition	
EUT Power Type	From AC Adapter
EUT Function	<input checked="" type="checkbox"/> Point-to-multipoint <input type="checkbox"/> Point-to-point
Type of EUT	
<input checked="" type="checkbox"/>	Stand-alone
<input type="checkbox"/>	Combined (EUT where the radio part is fully integrated within another device)
	Combined Equipment - Brand Name / Model No.: ...
<input type="checkbox"/>	Plug-in radio (EUT intended for a variety of host systems)
	Host System - Brand Name / Model No.: ...
<input type="checkbox"/>	Other:

1.1.4 Mode Test Duty Cycle

Mode	DC	DCF(dB)	T(s)	VBW(Hz) $\geq 1/T$
BT-LE(1Mbps)	0.626	2.034	391.25u	3k

1.1.5 Table for Existing Change

This product is an extension of original one reported under Sporton project number: FR852814-02AL

Below is the table for the change of the product with respect to the original one.

Modifications	Performance Checking
Two PoE Adapter and Ethernet Cable was added.	AC Conduction data and Radiated Emission data 30M to 1G was evaluated

1.2 Testing Applied Standards

According to the specifications of the manufacturer, the EUT must comply with the requirements of the following standards:

- ◆ 47 CFR FCC Part 15
- ◆ ANSI C63.10-2013
- ◆ KDB 558074 D01 v05r02
- ◆ KDB 414788 D01 v01r01

1.3 Testing Location Information

Testing Location		
<input checked="" type="checkbox"/>	HWA YA	ADD : No. 52, Huaya 1 st Rd., Guishan Dist., Taoyuan City, Taiwan (R.O.C.) TEL : 886-3-327-3456 FAX : 886-3-327-0973
Test site Designation No. TW1190 with FCC.		
<input checked="" type="checkbox"/>	LIN KOU	ADD : No. 30-2, Dingfu Vil., Linkou Dist., New Taipei City, Taiwan (R.O.C.) TEL : 886-2-2601-1640 FAX : 886-2-2601-1695
Test site Designation No. TW1095 with FCC.		

Test Condition	Test Site No.	Test Engineer	Test Environment	Test Date
RF Conducted	TH01-HY	Andy	23.5°C / 65%	21/Jun/2018
Radiated <9k~30M>	03CH02-HY	Jeff	23.5°C / 60%	15/Aug/2018
Radiated <30M~1G>	03CH02-HY	Terry	23.1°C / 59%	18/Jun/2018
AC Conduction	CO04-HY	Andy	23.5°C / 53.8%	25/Jul/2018
AC Conduction <PoE Adapter>	CO04-HY	David	22~22.5°C / 62.1~62.6%	23/Sep/2019
Radiated<30M~1G> <PoE Adapter>	OS03-LK	Chu	26.1~26.3°C / 65.2~65.4%	24/Sep/2019



1.4 Measurement Uncertainty

ISO/IEC 17025 requires that an estimate of the measurement uncertainties associated with the emissions test results be included in the report. The measurement uncertainties given below are based on a 95% confidence level (based on a coverage factor (k=2))

Test Items	Uncertainty	Remark
Conducted Emission (150kHz ~ 30MHz)	3.6 dB	Confidence levels of 95%
Radiated Emission (9kHz ~ 30MHz)	3.0 dB	Confidence levels of 95%
Radiated Emission (30MHz ~ 1,000MHz)	4.3 dB	Confidence levels of 95%
Radiated Emission (1GHz ~ 18GHz)	3.9 dB	Confidence levels of 95%
Radiated Emission (18GHz ~ 40GHz)	3.5 dB	Confidence levels of 95%
Conducted Emission	1.3 dB	Confidence levels of 95%
Temperature	0.7 °C	Confidence levels of 95%
Humidity	4 %	Confidence levels of 95%



2 Test Configuration of EUT

2.1 Test Condition

RF Conducted	Abbreviation	Remark
TnomVnom	Tnom	20°C
-	Vnom	120V

2.2 Test Channel Mode



Test Software	DoS
---------------	-----

Mode	Power Setting
BT-LE(1Mbps)	-
2402MHz	Default
2440MHz	Default
2480MHz	Default

2.3 The Worst Case Measurement Configuration

The Worst Case Mode for Following Conformance Tests	
Tests Item	AC power-line conducted emissions
Condition	AC power-line conducted measurement for line and neutral
Operating Mode	CTX
1	Adapter mode
2	PoE Adapter mode

The Worst Case Mode for Following Conformance Tests	
Tests Item	DTS Bandwidth Maximum Conducted Output Power Power Spectral Density Emissions in Non-restricted Frequency Bands
Test Condition	Conducted measurement at transmit chains

The Worst Case Mode for Following Conformance Tests			
Tests Item	Emissions in Restricted Frequency Bands		
Test Condition	Radiated measurement If EUT consist of multiple antenna assembly (multiple antenna are used in EUT regardless of spatial multiplexing MIMO configuration), the radiated test should be performed with highest antenna gain of each antenna type.		
Operating Mode < 1GHz	CTX		
1	Adapter mode		
2	PoE Adapter mode		
Operating Mode > 1GHz	CTX		
Orthogonal Planes of EUT	X Plane	Y Plane	Z Plane
			
Worst Planes of EUT			V

2.4 Accessories and Support Equipment

Accessories				
Indoor Adapter	Brand Name	DEE VAN ENTERPRISE	Model Name	DSA-15CAB-05 050250
	Power Rating	I/P: 100 - 240Vac, 0.5 A, O/P: 5 Vdc, 2.5 A		
Outdoor Adapter	Brand Name	ring	Model Name	DSA-15PFL-05 FUS 050250
	Power Rating	I/P: 100-240V ~ 0.5A MAX 50-60Hz; O/P: 5V 2.5A		
	DC Power Cord	2.45 meter, non-shielded cable, w/o ferrite core		
	AC Power Cord	4.53 meter, non-shielded cable, w/o ferrite core		
PoE Adapter 1	Brand Name	Phihong	Model Name	POE15M
	Power Rating	I/P: 100 - 240Vac, 0.8 A, O/P: 56 Vdc, 0.275 A		
PoE Adapter 2	Brand Name	ONV	Model Name	PSE3010DCG
	Power Rating	I/P: 100 - 240Vac, 0.8 A, O/P: 5 Vdc, 2.5A		
Adapter 2	Brand Name	ZTE	Model Name	RJ-AS120150U104-B
	Power Rating	I/P: 100 - 240Vac, 1 A, O/P: 12Vdc, 1.5A		
USB Cable	Power Rating	2.45 meter, non-shielded cable, w/o ferrite core		
6ft Ethernet Cable	Power Rating	1.8 meter, non-shielded cable, w/o ferrite core		

Reminder: Regarding to more detail and other information, please refer to user manual.



Support Equipment - RF Conducted				
No.	Equipment	Brand Name	Model Name	FCC ID
1	Notebook	DELL	E5410	DoC
2	Adapter for NB	DELL	HA65NM130	DoC
3	AC Power Source	G.W	APS-9102	-

Support Equipment - AC Conduction				
No.	Equipment	Brand Name	Model Name	FCC ID
1	PoE Adapter	Phihong	POE15M	-
Z1	802.11ac Dual-Band Wireless-AC1750 Gigabit Router	ASUS	RT-AC66U	MSQ-RTAC66U
Z2	iPhone 8	Apple	MRRM2TA/A	-
Z3	Notebook	DELL	D5500	DoC

Support Equipment - Radiated Emission				
No.	Equipment	Brand Name	Model Name	FCC ID
Z1	AP Router	Netgear	R6300v2	DoC
Z2	iPad	APPLE	A1538	-
Z3	PoE Adapter	Phihong	POE15M	-

2.5 Test Setup Diagram

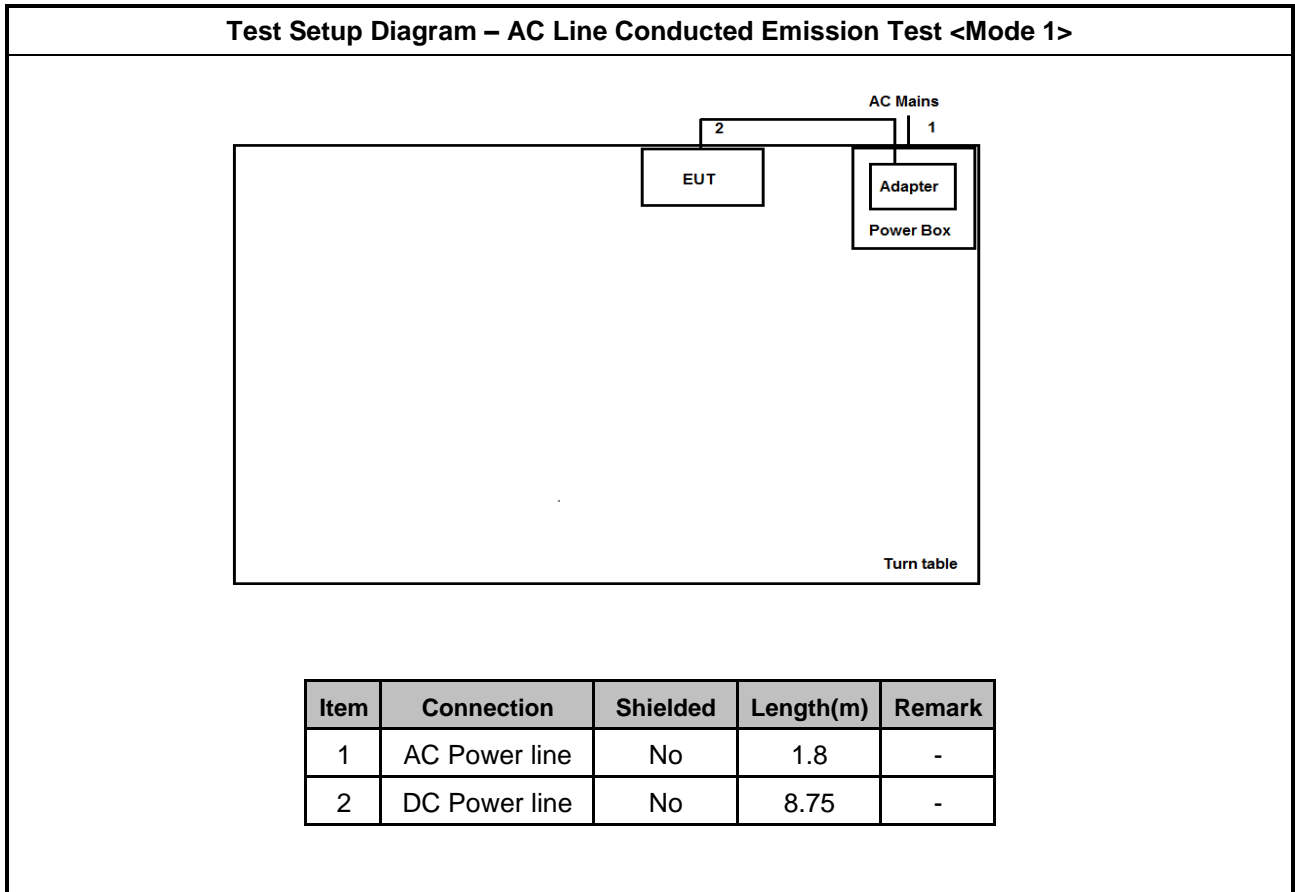

Test Setup Diagram – AC Line Conducted Emission Test <Mode 2>

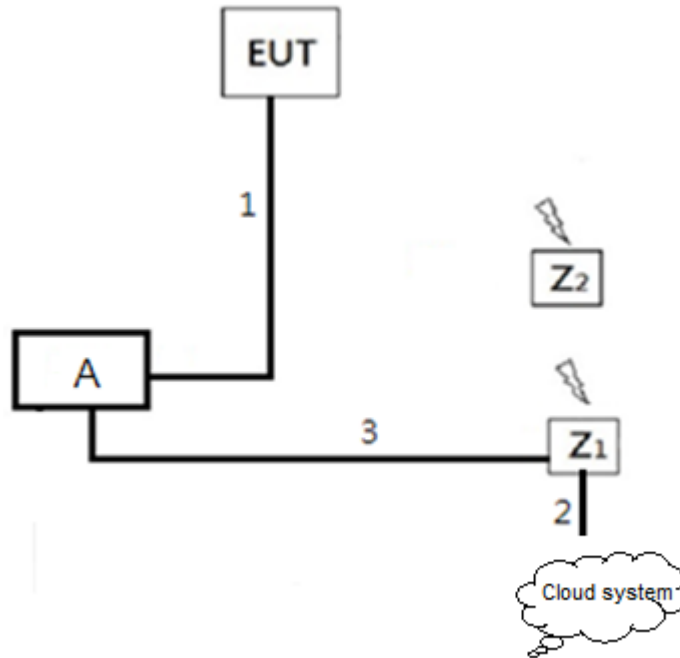

No.	Types of Cables	Shielding on Cable	Length (m)	Remarks
1	RJ45 Cable	Non-Shielded	1	-
2	RJ45 Cable	Non-Shielded	1	-
3	RJ45 Cable	Non-Shielded	1.8+10	-

Test Setup Diagram - Radiated Test <Mode 1>

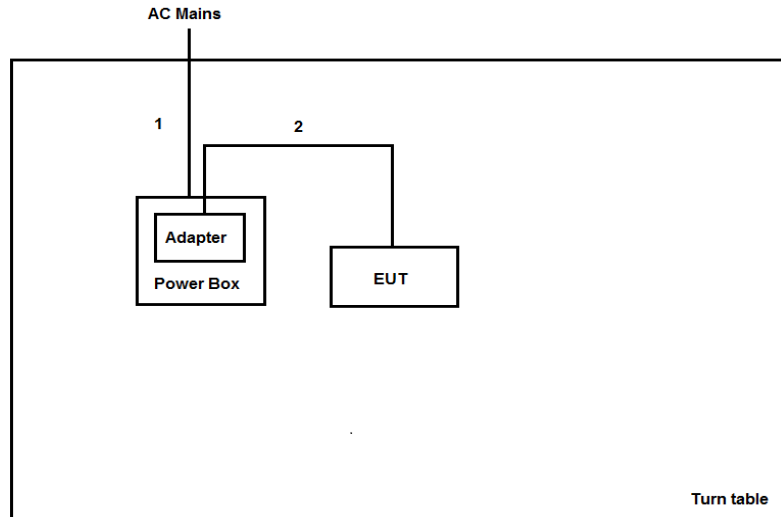

Item	Connection	Shielded	Length(m)	Remark
1	AC Power line	No	2.45	-
2	DC Power line	No	8.75	-

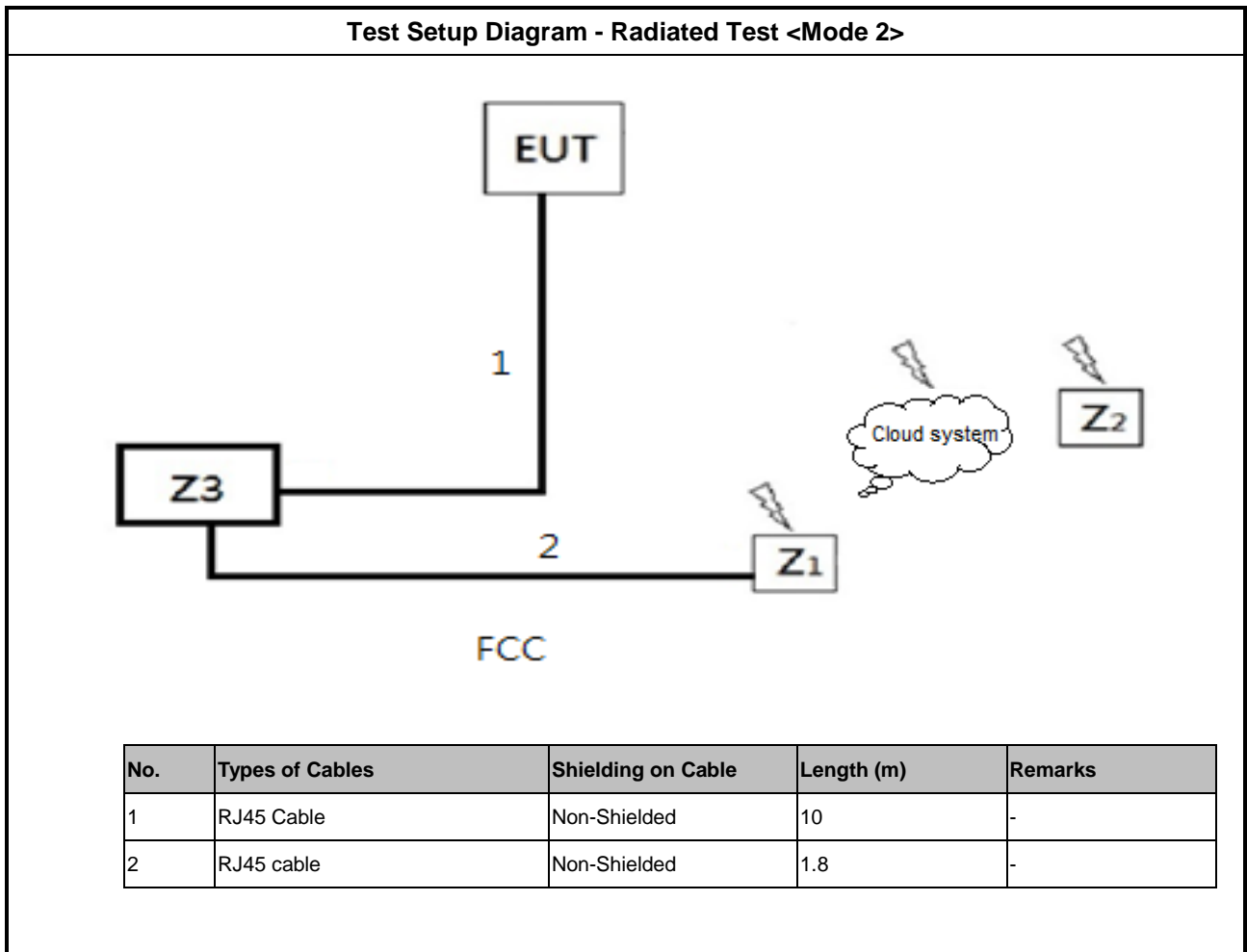

3 Transmitter Test Result

3.1 AC Power-line Conducted Emissions

3.1.1 AC Power-line Conducted Emissions Limit

AC Power-line Conducted Emissions Limit		
Frequency Emission (MHz)	Quasi-Peak	Average
0.15-0.5	66 - 56 *	56 - 46 *
0.5-5	56	46
5-30	60	50

Note 1: * Decreases with the logarithm of the frequency.

3.1.2 Measuring Instruments

Refer a test equipment and calibration data table in this test report.

3.1.3 Test Procedures

Test Method
<ul style="list-style-type: none"> Refer as ANSI C63.10-2013, clause 6.2 foray power-line conducted emissions.

3.1.4 Test Setup

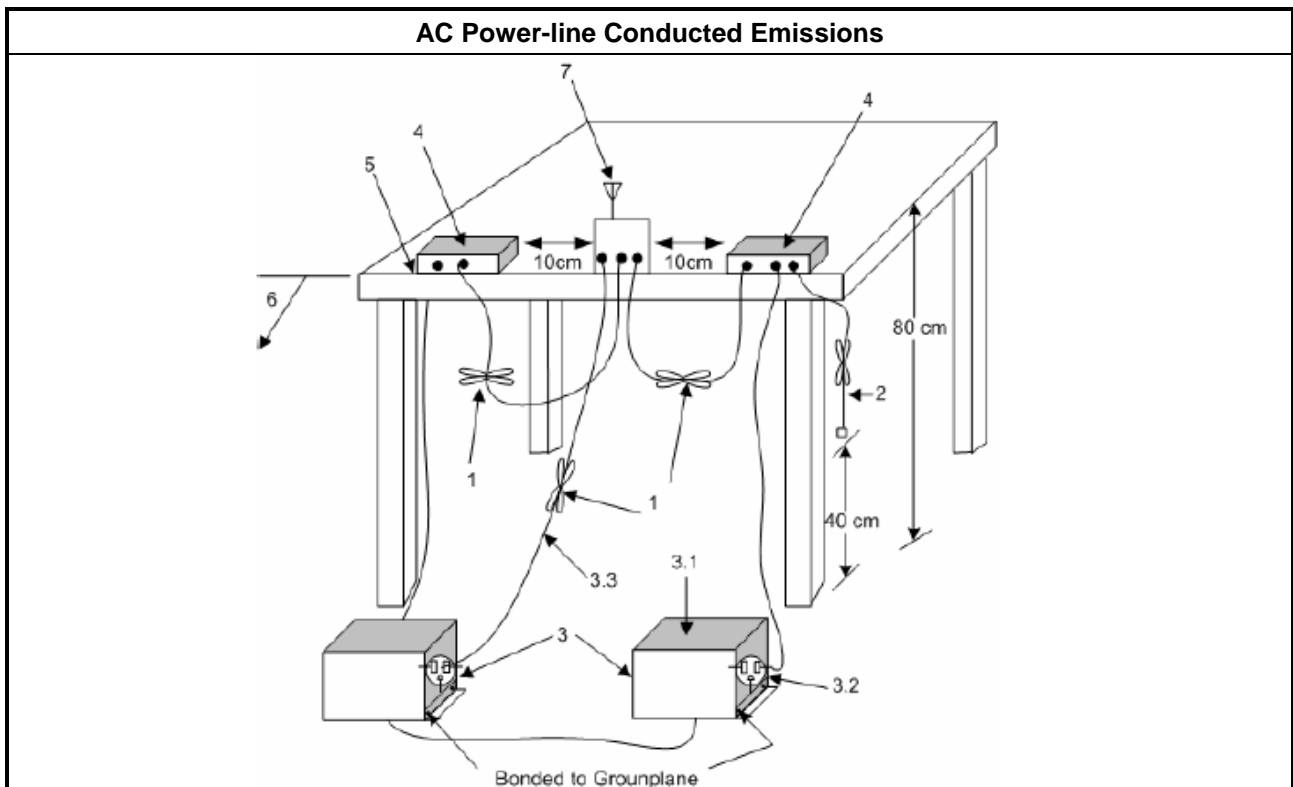



3.1.5 Test Result of AC Power-line Conducted Emissions

Refer as Appendix A

3.2 DTS Bandwidth

3.2.1 6dB Bandwidth Limit

6dB Bandwidth Limit
Systems using digital modulation techniques:
<ul style="list-style-type: none"> ▪ 6 dB bandwidth \geq 500 kHz.

3.2.2 Measuring Instruments

Refer a test equipment and calibration data table in this test report.

3.2.3 Test Procedures

Test Method
<ul style="list-style-type: none"> ▪ For the emission bandwidth shall be measured using one of the options below:
<input checked="" type="checkbox"/> Refer as KDB 558074, clause 8.2 (11.8 of ANSI C63.10) DTS bandwidth measurement.
<input type="checkbox"/> Refer as RSS-Gen, clause 6.7 for for occupied bandwidth testing.
<input type="checkbox"/> Refer as ANSI C63.10, clause 6.9.3 for occupied bandwidth testing.

3.2.4 Test Setup

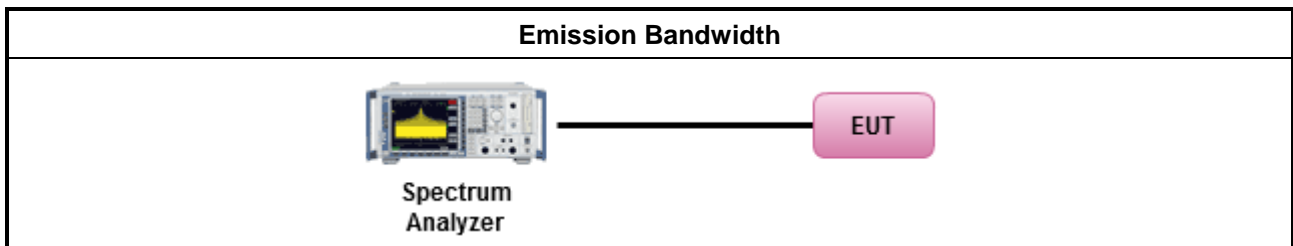

3.2.5 Test Result of Emission Bandwidth

Refer as Appendix B

3.3 Maximum Conducted Output Power

3.3.1 Maximum Conducted Output Power Limit

Maximum Conducted Output Power Limit	
	<ul style="list-style-type: none"> ▪ If $G_{TX} \leq 6$ dBi, then $P_{Out} \leq 30$ dBm (1 W)
	<ul style="list-style-type: none"> ▪ Point-to-multipoint systems (P2M): If $G_{TX} > 6$ dBi, then $P_{Out} = 30 - (G_{TX} - 6)$ dBm
	<ul style="list-style-type: none"> ▪ Point-to-point systems (P2P): If $G_{TX} > 6$ dBi, then $P_{Out} = 30 - (G_{TX} - 6)/3$ dBm
	<ul style="list-style-type: none"> ▪ Smart antenna system (SAS):
	<ul style="list-style-type: none"> - Single beam: If $G_{TX} > 6$ dBi, then $P_{Out} = 30 - (G_{TX} - 6)/3$ dBm
	<ul style="list-style-type: none"> - Overlap beam: If $G_{TX} > 6$ dBi, then $P_{Out} = 30 - (G_{TX} - 6)/3$ dBm
	<ul style="list-style-type: none"> - Aggregate power on all beams: If $G_{TX} > 6$ dBi, then $P_{Out} = 30 - (G_{TX} - 6)/3 + 8$ dB dBm
e.i.r.p. Power Limit:	
	<ul style="list-style-type: none"> ▪ 2400-2483.5 MHz Band
	<ul style="list-style-type: none"> ▪ Point-to-multipoint systems (P2M): $P_{eirp} \leq 36$ dBm (4 W)
	<ul style="list-style-type: none"> ▪ Point-to-point systems (P2P): $P_{eirp} \leq \text{MAX}(36, [P_{Out} + G_{TX}])$ dBm
	<ul style="list-style-type: none"> ▪ Smart antenna system (SAS)
	<ul style="list-style-type: none"> - Single beam: $P_{eirp} \leq \text{MAX}(36, P_{Out} + G_{TX})$ dBm
	<ul style="list-style-type: none"> - Overlap beam: $P_{eirp} \leq \text{MAX}(36, P_{Out} + G_{TX})$ dBm
	<ul style="list-style-type: none"> - Aggregate power on all beams: $P_{eirp} \leq \text{MAX}(36, [P_{Out} + G_{TX} + 8])$ dBm
P_{Out} = maximum peak conducted output power or maximum conducted output power in dBm, G_{TX} = the maximum transmitting antenna directional gain in dBi.	

3.3.2 Measuring Instruments

Refer a test equipment and calibration data table in this test report.

3.3.3 Test Procedures

Test Method	
<ul style="list-style-type: none"> ▪ Maximum Peak Conducted Output Power 	
<input type="checkbox"/>	Refer as KDB 558074, clause 8.3.1.1 (11.9.1.1 of ANSI C63.10) RBW ≥ EBW method.
<input type="checkbox"/>	Refer as KDB 558074, clause 8.3.1.2 (11.9.1.2 of ANSI C63.10) integrated band power method.
<input type="checkbox"/>	Refer as KDB 558074, clause 8.3.1.3 (11.9.1.3 of ANSI C63.10) peak power meter.
<ul style="list-style-type: none"> ▪ Maximum Average Conducted Output Power 	
<input type="checkbox"/>	Refer as KDB 558074, clause 8.3.2.2 (11.9.2.2 of ANSI C63.10) using a spectrum analyzer.
<input checked="" type="checkbox"/>	Refer as KDB 558074, clause 8.3.2.3 (11.9.2.3 of ANSI C63.10) using a power meter.
<ul style="list-style-type: none"> ▪ For conducted measurement. 	
<ul style="list-style-type: none"> ▪ If the EUT supports multiple transmit chains using options given below: Refer as KDB 662911, In-band power measurements. Using the measure-and-sum approach, measured all transmit ports individually. Sum the power (in linear power units e.g., mW) of all ports for each individual sample and save them. 	
<ul style="list-style-type: none"> ▪ If multiple transmit chains, EIRP calculation could be following as methods: $P_{total} = P_1 + P_2 + \dots + P_n$ (calculated in linear unit [mW] and transfer to log unit [dBm]) $EIRP_{total} = P_{total} + DG$ 	

3.3.4 Test Setup

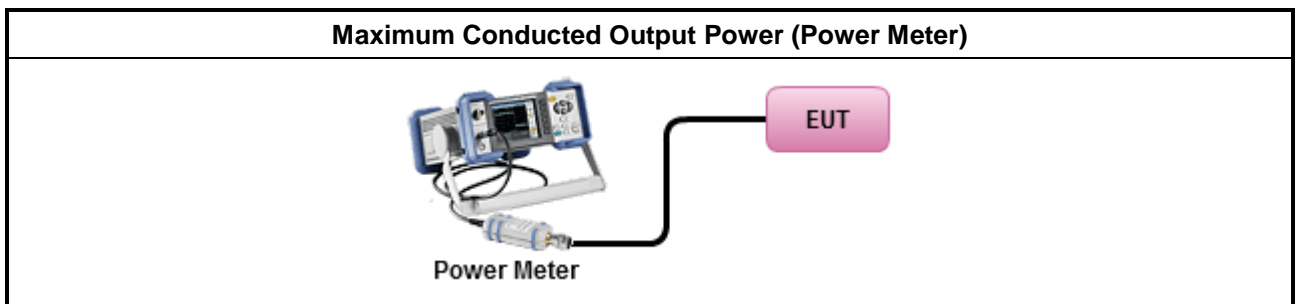

3.3.5 Test Result of Maximum Conducted Output Power

Refer as Appendix C

3.4 Power Spectral Density

3.4.1 Power Spectral Density Limit

Power Spectral Density Limit
<ul style="list-style-type: none"> ▪ Power Spectral Density (PSD) ≤ 8 dBm/3kHz

3.4.2 Measuring Instruments

Refer a test equipment and calibration data table in this test report.

3.4.3 Test Procedures

Test Method	
	<ul style="list-style-type: none"> ▪ Peak power spectral density procedures that the same method as used to determine the conducted output power. If maximum peak conducted output power was measured to demonstrate compliance to the output power limit, then the peak PSD procedure below (Method PKPSD) shall be used. If maximum conducted output power was measured to demonstrate compliance to the output power limit, then one of the average PSD procedures shall be used, as applicable based on the following criteria (the peak PSD procedure is also an acceptable option).
<input checked="" type="checkbox"/>	Refer as KDB 558074, clause 8.4 (11.10 of ANSI C63.10) Method PKPSD.
	<ul style="list-style-type: none"> ▪ For conducted measurement.
	<ul style="list-style-type: none"> ▪ If The EUT supports multiple transmit chains using options given below:
	<ul style="list-style-type: none"> ▪ Measure and sum the spectra across the outputs. Refer as KDB 662911, In-band power spectral density (PSD). Sample all transmit ports simultaneously using a spectrum analyzer for each transmit port. Where the trace bin-by-bin of each transmit port summing can be performed. (i.e., in the first spectral bin of output 1 is summed with that in the first spectral bin of output 2 and that from the first spectral bin of output 3, and so on up to the NTX output to obtain the value for the first frequency bin of the summed spectrum.). Add up the amplitude (power) values for the different transmit chains and use this as the new data trace.

3.4.4 Test Setup

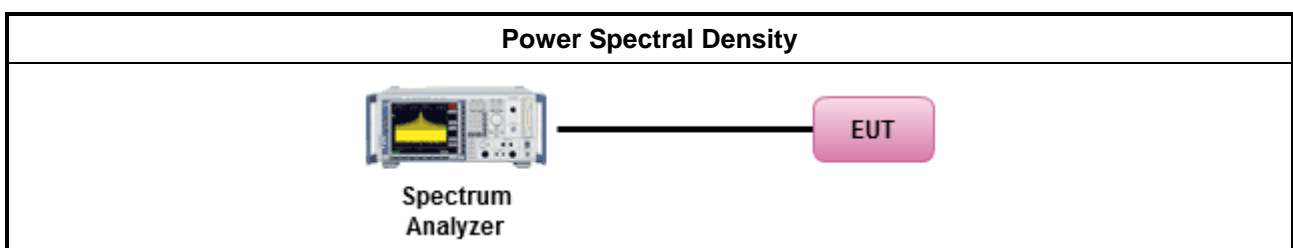

3.4.5 Test Result of Power Spectral Density

Refer as Appendix D

3.5 Emissions in Non-restricted Frequency Bands

3.5.1 Emissions in Non-restricted Frequency Bands Limit

Un-restricted Band Emissions Limit	
RF output power procedure	Limit (dB)
Peak output power procedure	20
Average output power procedure	30

Note 1: If the peak output power procedure is used to measure the fundamental emission power to demonstrate compliance to requirements, then the peak conducted output power measured within any 100 kHz outside the authorized frequency band shall be attenuated by at least 20 dB relative to the maximum measured in-band peak PSD level.

Note 2: If the average output power procedure is used to measure the fundamental emission power to demonstrate compliance to requirements, then the power in any 100 kHz outside of the authorized frequency band shall be attenuated by at least 30 dB relative to the maximum measured in-band average PSD level.

3.5.2 Measuring Instruments

Refer a test equipment and calibration data table in this test report.

3.5.3 Test Procedures

Test Method
<ul style="list-style-type: none"> Refer as KDB 558074, clause 8.5 (11.11 of ANSI C63.10) for non-restricted frequency bands.

3.5.4 Test Setup

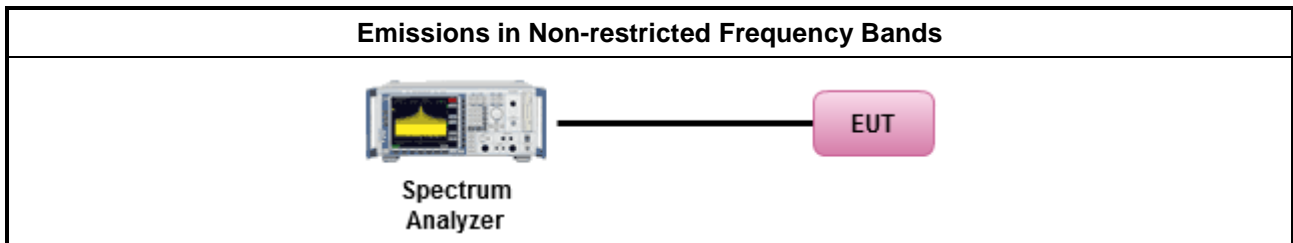

3.5.5 Test Result of Emissions in Non-restricted Frequency Bands

Refer as Appendix E

3.6 Emissions in Restricted Frequency Bands

3.6.1 Emissions in Restricted Frequency Bands Limit

Restricted Band Emissions Limit			
Frequency Range (MHz)	Field Strength (uV/m)	Field Strength (dBuV/m)	Measure Distance (m)
0.009~0.490	2400/F(kHz)	48.5 - 13.8	300
0.490~1.705	24000/F(kHz)	33.8 - 23	30
1.705~30.0	30	29	30
30~88	100	40	3
88~216	150	43.5	3
216~960	200	46	3
Above 960	500	54	3

Note 1: Test distance for frequencies at or above 30 MHz, measurements may be performed at a distance other than the limit distance provided they are not performed in the near field and the emissions to be measured can be detected by the measurement equipment. When performing measurements at a distance other than that specified, the results shall be extrapolated to the specified distance using an extrapolation factor of 20 dB/decade (inverse of linear distance for field-strength measurements, inverse of linear distance-squared for power-density measurements).

Note 2: Test distance for frequencies at below 30 MHz, measurements may be performed at a distance closer than the EUT limit distance; however, an attempt should be made to avoid making measurements in the near field. When performing measurements below 30 MHz at a closer distance than the limit distance, the results shall be extrapolated to the specified distance by either making measurements at a minimum of two or more distances on at least one radial to determine the proper extrapolation factor or by using the square of an inverse linear distance extrapolation factor (40 dB / decade). The test report shall specify the extrapolation method used to determine compliance of the EUT.

Note 3: Using the distance of 1m during the test for above 18 GHz, and the test value to correct for the distance factor at 3m.

3.6.2 Measuring Instruments

Refer a test equipment and calibration data table in this test report.

3.6.3 Test Procedures

Test Method	
	<ul style="list-style-type: none"> ▪ The average emission levels shall be measured in [duty cycle \geq 98 or duty factor].
	<ul style="list-style-type: none"> ▪ Refer as ANSI C63.10, clause 6.10.3 band-edge testing shall be performed at the lowest frequency channel and highest frequency channel within the allowed operating band.
	<ul style="list-style-type: none"> ▪ For the transmitter unwanted emissions shall be measured using following options below:
	<ul style="list-style-type: none"> ▪ Refer as KDB 558074, clause 8.6 (11.12 of ANSI C63.10) for restricted frequency bands.
	<ul style="list-style-type: none"> ▪ For the transmitter band-edge emissions shall be measured using following options below:
	<ul style="list-style-type: none"> ▪ Refer as KDB 558074 clause 8.7.1, When the performing peak or average radiated measurements, emissions within 2 MHz of the authorized band edge may be measured using the marker-delta method described below.
	<ul style="list-style-type: none"> ▪ Refer as KDB 558074, clause 8.7.2 (6.10.6 of ANSI C63.10) for marker-delta method for band-edge measurements.
	<ul style="list-style-type: none"> ▪ Refer as KDB 558074, clause 8.7.3 for narrower resolution bandwidth (100kHz) using the band power and summing the spectral levels.
	<ul style="list-style-type: none"> ▪ Use the following spectrum analyzer settings:
	<ul style="list-style-type: none"> ▪ Set RBW=100 kHz for $f < 1$ GHz; VBW=3 * RBW; Sweep = auto; Detector function = peak; Trace = max hold.
	<ul style="list-style-type: none"> ▪ Set RBW = 1 MHz, VBW= 3MHz for $f \geq 1$ GHz for peak measurement. For average measurement, refer as 1.1.4.
	<ul style="list-style-type: none"> ▪ KDB 414788 Open-Field Test Sites and Chamber Correlation Justification.
	<ul style="list-style-type: none"> ▪ Based on FCC 15.31 (f) (2): measurements may be performed at a distance closer than that specified in regulations; however, an attempt should be made to avoid making measurements in the near field.
	<ul style="list-style-type: none"> ▪ Open-field site and chamber correlation testing had been performed and chamber measured test result is the worst case test result.

3.6.4 Test Setup

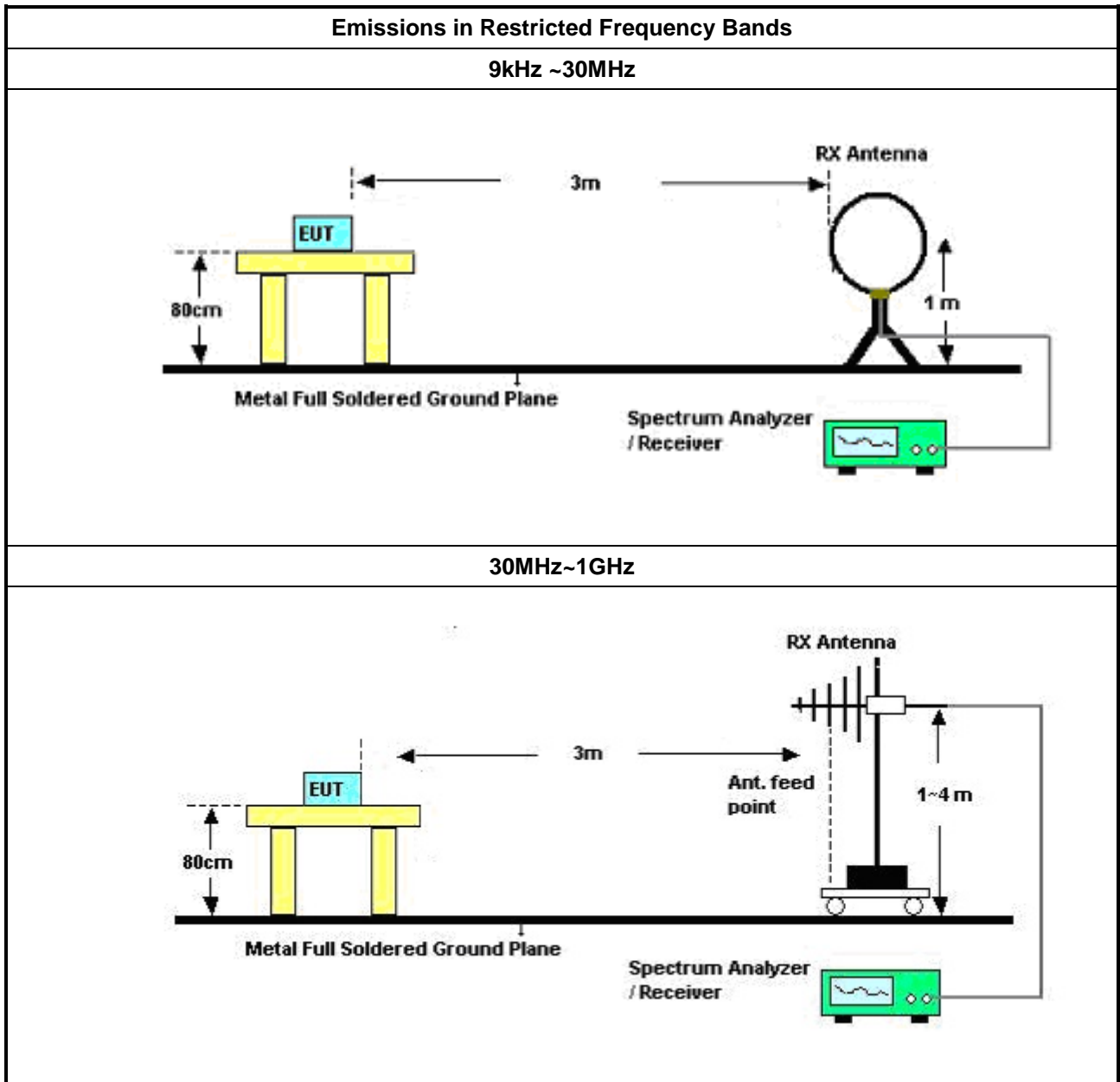

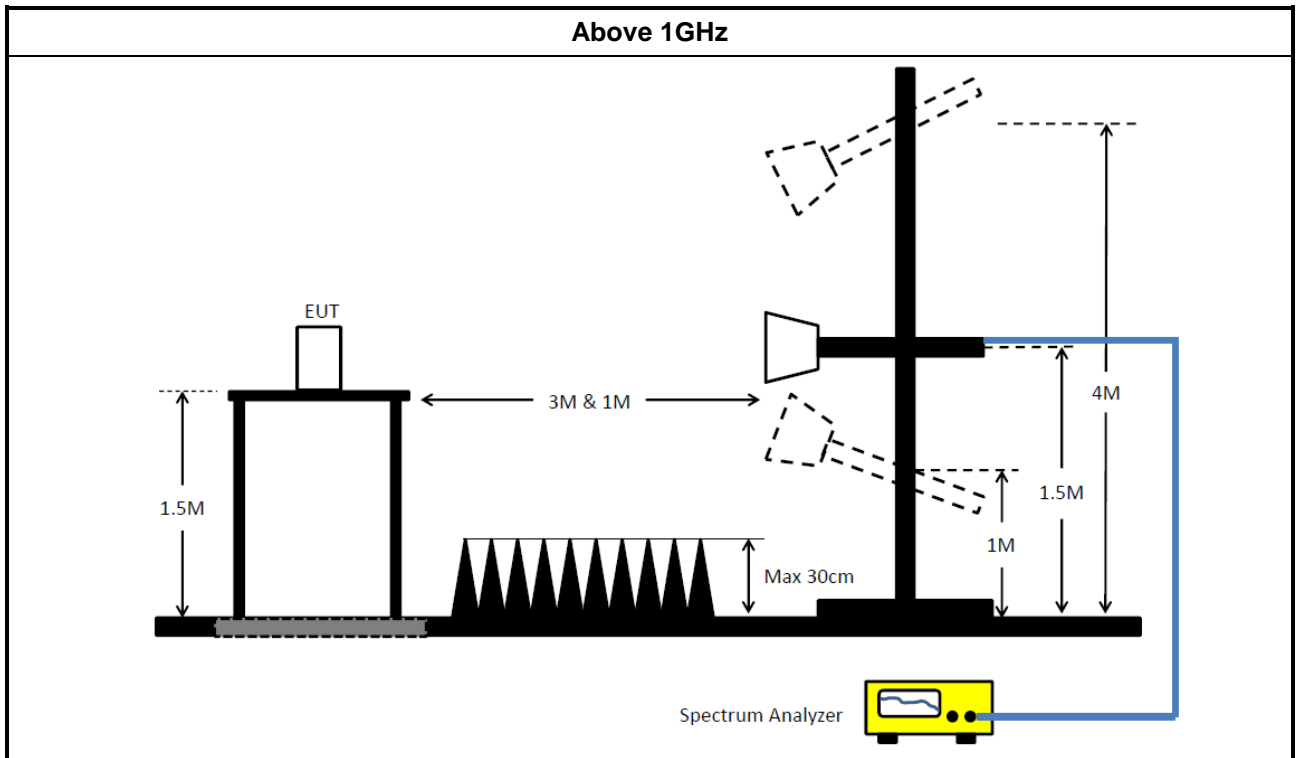

3.6.5 Test Result of Emissions in Restricted Frequency Bands (Below 30MHz)

The amplitude of spurious emissions which are attenuated by more than 20dB below the permissible value has no need to be reported.

3.6.6 Test Result of Emissions in Restricted Frequency Bands

Refer as Appendix F



4 Test Equipment and Calibration Data

Instrument for AC Conduction<Mode 1>

Instrument	Manufacturer	Model No.	Serial No.	Spec.	Calibration Date	Calibration Due Date
EMC Receiver	R&S	ESR	102051	9KHz ~ 3.6GHz	03/May/2018	02/May/2019
LISN	R&S	ENV216	101295	9kHz ~ 30MHz	17/Nov/2017	16/Nov/2018
RF Cable-CON	HUBER+SUHNER	RG213/U	0761183202000 1	9kHz ~ 30MHz	06/Oct/2017	05/Oct/2018
AC POWER	APC	AFC-11005G	F310050055	47Hz~63Hz 5~300V	NCR	NCR
Impuls Begrenzer Puls e Limiter	SCHWARZBEC K	VTSD 9561-F	9561-F041	9 kHz ~ 30 MHz	12/Oct/2017	11/Oct/2018

NCR : Non-Calibration Require

Instrument for AC Conduction <Mode 2>

Instrument	Manufacturer	Model No.	Serial No.	Spec.	Calibration Date	Calibration Due Date
EMI Test Receiver	R&S	ESR3	102051	9KHz ~ 3.6GHz	28/May/2019	27/May/2020
LISN	R&S	ENV216	101295	9kHz ~ 30MHz	08/Nov/2018	07/Nov/2019
RF Cable-CON	MTJ	RG142	CB002-CO	9kHz ~ 200MHz	12/Sep/2019	11/Sep/2020
Impuls Begrenzer Puls e Limiter	SCHWARZBEC K	VTSD 9561-F	9561-F041	9 kHz ~ 30 MHz	11/Oct/2018	10/Oct/2019
Software	Sporton	SENSE-EMI	V5.10.5	-	NCR	NCR

NCR : Non-Calibration Require



Instrument for Radiated Test<Mode 1>

Instrument	Manufacturer	Model No.	Serial No.	Spec.	Calibration Date	Calibration Due Date
3m Semi Anechoic Chamber	SIDT FRANKONIA	SAC-3M	03CH02-HY	30MHz ~ 1GHz 3m	20/Oct/2017	19/Oct/2018
3m Semi Anechoic Chamber	SIDT FRANKONIA	SAC-3M	03CH02-HY	1GHz ~ 18GHz 3m	27/Oct/2017	26/Oct/2018
Amplifier	Agilent	8447D	2944A11149	100kHz ~ 1.3GHz	29Jun/2017	28/Jun/2018
Microwave Preamplifier	Agilent	8449B	3008A02373	1GHz ~ 26.5GHz	28/Sep/2017	27/Sep/2018
Spectrum Analyzer	Rohde & Schwarz	FSP40	100593	9kHz - 40GHz	12/Dec/2017	11/Dec/2018
EMI Test Receiver	Rohde & Schwarz	ESCS 30	100354	9kHz ~ 2.75GHz	08/Dec/2017	07/Dec/2018
RF Cable-R03m	Jye Bao	RG142	CB017	9kHz ~ 1GHz	19/Jan/2018	18/Jan/2019
RF Cable-high	SUHNER	SUCOFLEX104	MY34918/4	1GHz ~ 40GHz	19/Jan/2018	18/Jan/2019
Bilog Antenna	SCHAFFNER	CBL 6112B	2723	30MHz ~ 1GHz	09/Sep/2017	08/Sep/2018
Broadband Horn Antenna	SCHWARZBEC K	BBHA 9170	BBHA 9170154	18GHz ~ 40GHz	06/Feb/2018	05/Feb/2019
Double Ridged Guide Horn Antenna	SCHWARZBEC K	BBHA 9120D	BBHA 9120 D 1543	1GHz ~ 18GHz	11/May/ 2018	10/May/2019
Preamplifier	MITEQ	TTA1840-35-HG	1864481	18GHz ~ 40GHz	31/Aug/2017	30/Aug/2018
Loop Antenna	TESEQ	HLA 6120	31244	9k-30MHz	29/Mar/2018	28/Mar/2019



Instrument for Radiated Test <Mode 2>

Instrument	Manufacturer	Model No.	Serial No.	Spec.	Calibration Date	Calibration Due Date
Open Area Test Site	SPORTON	OATS-10	OS03-LK	30 MHz ~ 1 GHz 10m, 3m	15/Apr/2019	14/Apr/2020
Amplifier	HP	8447D	2944A09068	0.1MHz ~ 1.3GHz	20/Dec/2018	19/Dec/2019
Spectrum Analyzer	R&S	FSP	100641	9 kHz ~ 30 GHz	23/Jul/2019	22/Jul/2020
Test Receiver	R&S	ESCS 30	100168	9 kHz ~ 2.75 GHz	12/Dec/2018	11/Dec/2019
Bilog Antenna with 5dB Attenuator	TESEQ & WOKEN	CBL6112D & 00800N1D01N-05	25236 & 007	30 MHz ~ 1 GHz	06/Jul/2019	05/Jul/2020
Turn Table	EMCO	2080	9711-2021	0 ~ 360 degree	NCR	NCR
Antenna Mast	EMCO	2075	9711-2115	1 m ~ 4 m	NCR	NCR
RF Cable-R10m	Woken	CFD400E-LW	OS03-2500	30 MHz ~ 1 GHz	15/May/2019	14/May/2020
Software	Audix	E3	Version:4	-	NCR	NCR

NCR : Non-Calibration Require

Instrument for Conducted Test

Instrument	Manufacturer	Model No.	Serial No.	Spec.	Calibration Date	Calibration Due Date
Spectrum Analyzer	R&S	FSV 40	101515	9kHz~40GHz	08/Dec/2017	07/Dec/2018
Power Sensor	Anritsu	MA2411B	1339407	300MHz ~ 40GHz	06/Nov/2017	05/Nov/2018
Power Meter	Anritsu	ML2495A	1517010	300MHz ~ 40GHz	06/Nov/2017	05/Nov/2018
RF Cable-0.2m	HUBER+SUHNER	SUCOFLEX_104	MY10710/4	30MHz ~ 26.5GHz	25/Aug/2017	24/Aug/2018
RF Cable-0.2m	HUBER+SUHNER	SUCOFLEX_104	MY10709/4	30MHz ~ 26.5GHz	25/Aug/2017	24/Aug/2018
RF Cable-1m	HUBER+SUHNER	SUCOFLEX_104	MY37333/4	30MHz ~ 26.5GHz	26/Jan/2018	25/Jan/2019
Signal Generator	R&S	SMR40	100116	10MHz ~ 40GHz	27/Jul/2017	26/Jul/2018



AC Power-line Conducted Emissions Result																																																																																																																																	
Operating Mode	1	Power Phase	Neutral																																																																																																																														
Operating Function	Adapter mode - TX																																																																																																																																
<div style="display: flex; justify-content: space-between;"> <div> </div> <div style="text-align: right;">Date: 2018-07-25</div> </div>																																																																																																																																	
<table border="1" style="width: 100%; border-collapse: collapse; margin-top: 20px;"> <thead> <tr> <th></th> <th>Freq</th> <th>Level</th> <th>Over Limit</th> <th>Limit Line</th> <th>Read Level</th> <th>LISN Factor</th> <th>Cable Loss</th> <th>Remark</th> </tr> <tr> <th></th> <th>MHz</th> <th>dBuV</th> <th>dB</th> <th>dBuV</th> <th>dBuV</th> <th>dB</th> <th>dB</th> <th></th> </tr> </thead> <tbody> <tr> <td>1</td> <td>0.42</td> <td>26.96</td> <td>-20.55</td> <td>47.51</td> <td>17.25</td> <td>9.61</td> <td>0.10</td> <td>Average</td> </tr> <tr> <td>2</td> <td>0.42</td> <td>38.54</td> <td>-18.97</td> <td>57.51</td> <td>28.83</td> <td>9.61</td> <td>0.10</td> <td>QP</td> </tr> <tr style="background-color: #e0e0e0;"> <td>3 MAX</td> <td>0.48</td> <td>34.39</td> <td>-11.93</td> <td>46.32</td> <td>24.70</td> <td>9.61</td> <td>0.08</td> <td>Average</td> </tr> <tr> <td>4</td> <td>0.48</td> <td>43.38</td> <td>-12.94</td> <td>56.32</td> <td>33.69</td> <td>9.61</td> <td>0.08</td> <td>QP</td> </tr> <tr> <td>5</td> <td>1.37</td> <td>26.68</td> <td>-19.32</td> <td>46.00</td> <td>17.06</td> <td>9.62</td> <td>0.00</td> <td>Average</td> </tr> <tr> <td>6</td> <td>1.37</td> <td>36.60</td> <td>-19.40</td> <td>56.00</td> <td>26.98</td> <td>9.62</td> <td>0.00</td> <td>QP</td> </tr> <tr> <td>7</td> <td>1.97</td> <td>26.19</td> <td>-19.81</td> <td>46.00</td> <td>16.56</td> <td>9.63</td> <td>0.00</td> <td>Average</td> </tr> <tr> <td>8</td> <td>1.97</td> <td>37.45</td> <td>-18.55</td> <td>56.00</td> <td>27.82</td> <td>9.63</td> <td>0.00</td> <td>QP</td> </tr> <tr> <td>9</td> <td>2.68</td> <td>24.09</td> <td>-21.91</td> <td>46.00</td> <td>14.42</td> <td>9.63</td> <td>0.04</td> <td>Average</td> </tr> <tr> <td>10</td> <td>2.68</td> <td>36.15</td> <td>-19.85</td> <td>56.00</td> <td>26.48</td> <td>9.63</td> <td>0.04</td> <td>QP</td> </tr> <tr> <td>11</td> <td>4.31</td> <td>23.97</td> <td>-22.03</td> <td>46.00</td> <td>14.23</td> <td>9.64</td> <td>0.10</td> <td>Average</td> </tr> <tr> <td>12</td> <td>4.31</td> <td>35.02</td> <td>-20.98</td> <td>56.00</td> <td>25.28</td> <td>9.64</td> <td>0.10</td> <td>QP</td> </tr> </tbody> </table>					Freq	Level	Over Limit	Limit Line	Read Level	LISN Factor	Cable Loss	Remark		MHz	dBuV	dB	dBuV	dBuV	dB	dB		1	0.42	26.96	-20.55	47.51	17.25	9.61	0.10	Average	2	0.42	38.54	-18.97	57.51	28.83	9.61	0.10	QP	3 MAX	0.48	34.39	-11.93	46.32	24.70	9.61	0.08	Average	4	0.48	43.38	-12.94	56.32	33.69	9.61	0.08	QP	5	1.37	26.68	-19.32	46.00	17.06	9.62	0.00	Average	6	1.37	36.60	-19.40	56.00	26.98	9.62	0.00	QP	7	1.97	26.19	-19.81	46.00	16.56	9.63	0.00	Average	8	1.97	37.45	-18.55	56.00	27.82	9.63	0.00	QP	9	2.68	24.09	-21.91	46.00	14.42	9.63	0.04	Average	10	2.68	36.15	-19.85	56.00	26.48	9.63	0.04	QP	11	4.31	23.97	-22.03	46.00	14.23	9.64	0.10	Average	12	4.31	35.02	-20.98	56.00	25.28	9.64	0.10	QP
	Freq	Level	Over Limit	Limit Line	Read Level	LISN Factor	Cable Loss	Remark																																																																																																																									
	MHz	dBuV	dB	dBuV	dBuV	dB	dB																																																																																																																										
1	0.42	26.96	-20.55	47.51	17.25	9.61	0.10	Average																																																																																																																									
2	0.42	38.54	-18.97	57.51	28.83	9.61	0.10	QP																																																																																																																									
3 MAX	0.48	34.39	-11.93	46.32	24.70	9.61	0.08	Average																																																																																																																									
4	0.48	43.38	-12.94	56.32	33.69	9.61	0.08	QP																																																																																																																									
5	1.37	26.68	-19.32	46.00	17.06	9.62	0.00	Average																																																																																																																									
6	1.37	36.60	-19.40	56.00	26.98	9.62	0.00	QP																																																																																																																									
7	1.97	26.19	-19.81	46.00	16.56	9.63	0.00	Average																																																																																																																									
8	1.97	37.45	-18.55	56.00	27.82	9.63	0.00	QP																																																																																																																									
9	2.68	24.09	-21.91	46.00	14.42	9.63	0.04	Average																																																																																																																									
10	2.68	36.15	-19.85	56.00	26.48	9.63	0.04	QP																																																																																																																									
11	4.31	23.97	-22.03	46.00	14.23	9.64	0.10	Average																																																																																																																									
12	4.31	35.02	-20.98	56.00	25.28	9.64	0.10	QP																																																																																																																									
<p>Note 1: ">20dB" means emission levels that exceed the level of 20 dB below the applicable limit. Note 2: "N/F" means Nothing Found emissions (No emissions were detected.)</p>																																																																																																																																	

AC Power-line Conducted Emissions Result

Operating Mode	1	Power Phase	Line
Operating Function	Adapter mode - TX		

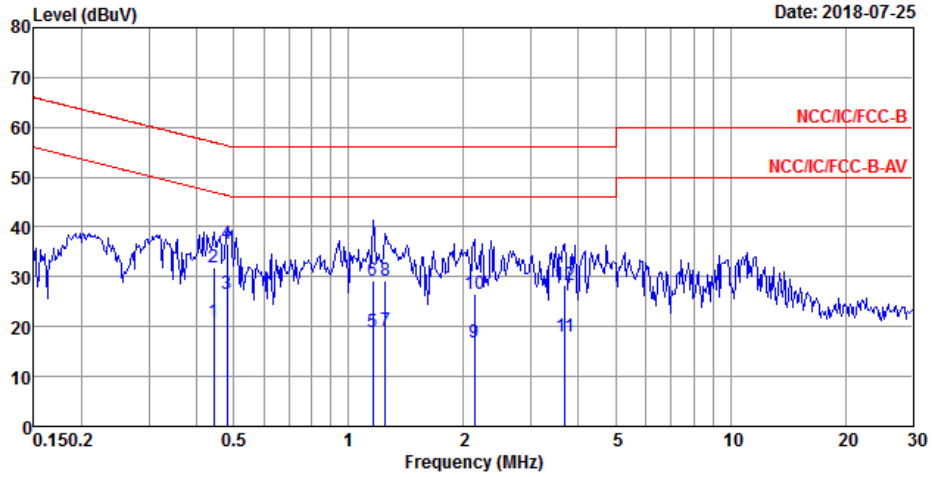

	Freq	Level	Over Limit	Limit Line	Read Level	LISN Factor	Cable Loss	Remark
	MHz	dBuV	dB	dBuV	dBuV	dB	dB	
1	0.44	21.08	-25.90	46.98	11.38	9.61	0.09	Average
2	0.44	31.75	-25.23	56.98	22.05	9.61	0.09	QP
3	0.48	26.54	-19.78	46.32	16.85	9.61	0.08	Average
4 MAX	0.48	36.54	-19.78	56.32	26.85	9.61	0.08	QP
5	1.16	18.92	-27.08	46.00	9.31	9.61	0.00	Average
6	1.16	29.37	-26.63	56.00	19.76	9.61	0.00	QP
7	1.25	19.33	-26.67	46.00	9.72	9.61	0.00	Average
8	1.25	29.29	-26.71	56.00	19.68	9.61	0.00	QP
9	2.13	16.82	-29.18	46.00	7.19	9.62	0.01	Average
10	2.13	26.62	-29.38	56.00	16.99	9.62	0.01	QP
11	3.68	17.91	-28.09	46.00	8.20	9.63	0.08	Average
12	3.68	28.30	-27.70	56.00	18.59	9.63	0.08	QP

Note 1: ">20dB" means emission levels that exceed the level of 20 dB below the applicable limit.
 Note 2: "N/F" means Nothing Found emissions (No emissions were detected.)



AC Power-line Conducted Emissions Result

Operating Mode	2	Power Phase	Neutral
Operating Function	PoE Adapter mode - TX		

23/09/2019



Type	Freq (Hz)	Level (dBuV)	Limit (dBuV)	Margin (dB)	Factor (dB)	Condition	Comment	Raw (dBuV)	LISN (dB)	CL (dB)	AT (dB)
QP	150.05k	51.94	66.00	-14.06	19.48	Neutral	-	32.46	9.60	0.01	9.87
AV	150.05k	35.67	56.00	-20.33	19.48	Neutral	-	16.19	9.60	0.01	9.87
QP	462.337k	45.33	56.65	-11.32	19.48	Neutral	-	25.85	9.59	0.01	9.88
AV	462.337k	40.18	46.65	-6.47	19.48	Neutral	"Worst"	20.70	9.59	0.01	9.88
QP	2.964M	41.25	56.00	-14.75	19.54	Neutral	-	21.71	9.61	0.04	9.89
AV	2.964M	34.31	46.00	-11.69	19.54	Neutral	-	14.77	9.61	0.04	9.89
QP	11.361M	41.62	60.00	-18.38	19.64	Neutral	-	21.98	9.67	0.08	9.89
AV	11.361M	36.48	50.00	-13.52	19.64	Neutral	-	16.84	9.67	0.08	9.89
QP	16.166M	44.54	60.00	-15.46	19.68	Neutral	-	24.86	9.68	0.10	9.90
AV	16.166M	38.15	50.00	-11.85	19.68	Neutral	-	18.47	9.68	0.10	9.90
QP	19.003M	42.56	60.00	-17.44	19.69	Neutral	-	22.87	9.68	0.11	9.90
AV	19.003M	37.01	50.00	-12.99	19.69	Neutral	-	17.32	9.68	0.11	9.90



AC Power-line Conducted Emissions Result

Operating Mode	2	Power Phase	Line
Operating Function	PoE Adapter mode - TX		

23/09/2019

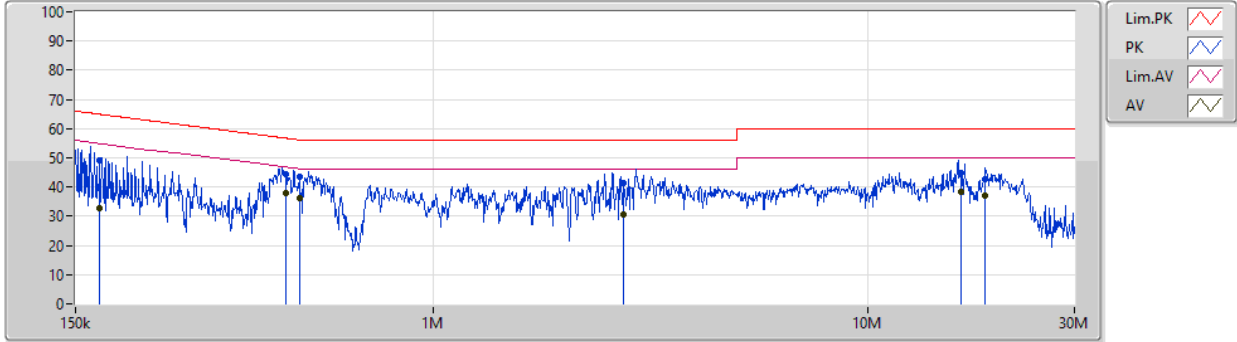

Type	Freq (Hz)	Level (dBuV)	Limit (dBuV)	Margin (dB)	Factor (dB)	Condition	Comment	Raw (dBuV)	LISN (dB)	CL (dB)	AT (dB)
QP	170.81k	49.01	64.91	-15.90	19.48	Line	-	29.53	9.60	0.01	9.87
AV	170.81k	32.94	54.91	-21.97	19.48	Line	-	13.46	9.60	0.01	9.87
QP	458.311k	44.35	56.73	-12.38	19.48	Line	-	24.87	9.59	0.01	9.88
AV	458.311k	37.73	46.73	-9.00	19.48	Line	"Worst"	18.25	9.59	0.01	9.88
QP	493.042k	43.55	56.11	-12.56	19.48	Line	-	24.07	9.59	0.01	9.88
AV	493.042k	36.13	46.11	-9.98	19.48	Line	-	16.65	9.59	0.01	9.88
QP	2.748M	41.26	56.00	-14.74	19.55	Line	-	21.71	9.62	0.04	9.89
AV	2.748M	30.65	46.00	-15.35	19.55	Line	-	11.10	9.62	0.04	9.89
QP	16.421M	44.64	60.00	-15.36	19.64	Line	-	25.00	9.64	0.10	9.90
AV	16.421M	38.21	50.00	-11.79	19.64	Line	-	18.57	9.64	0.10	9.90
QP	18.629M	42.50	60.00	-17.50	19.64	Line	-	22.86	9.63	0.11	9.90
AV	18.629M	37.00	50.00	-13.00	19.64	Line	-	17.36	9.63	0.11	9.90



Summary

Mode	Max-N dB (Hz)	Max-OBW (Hz)	ITU-Code	Min-N dB (Hz)	Min-OBW (Hz)
2.4-2.4835GHz	-	-	-	-	-
BT-LE(1Mbps)	713.75k	1.053M	1M05F1D	710k	1.053M

Max-N dB = Maximum 6dB down bandwidth; **Max-OBW** = Maximum 99% occupied bandwidth;
Min-N dB = Minimum 6dB down bandwidth; **Min-OBW** = Minimum 99% occupied bandwidth;

Result

Mode	Result	Limit (Hz)	Port 1-N dB (Hz)	Port 1-OBW (Hz)
BT-LE(1Mbps)	-	-	-	-
2402MHz_TnomVnom	Pass	500k	710k	1.053M
2440MHz_TnomVnom	Pass	500k	713.75k	1.053M
2480MHz_TnomVnom	Pass	500k	712.5k	1.053M

Port X-N dB = Port X 6dB down bandwidth; **Port X-OBW** = Port X 99% occupied bandwidth;

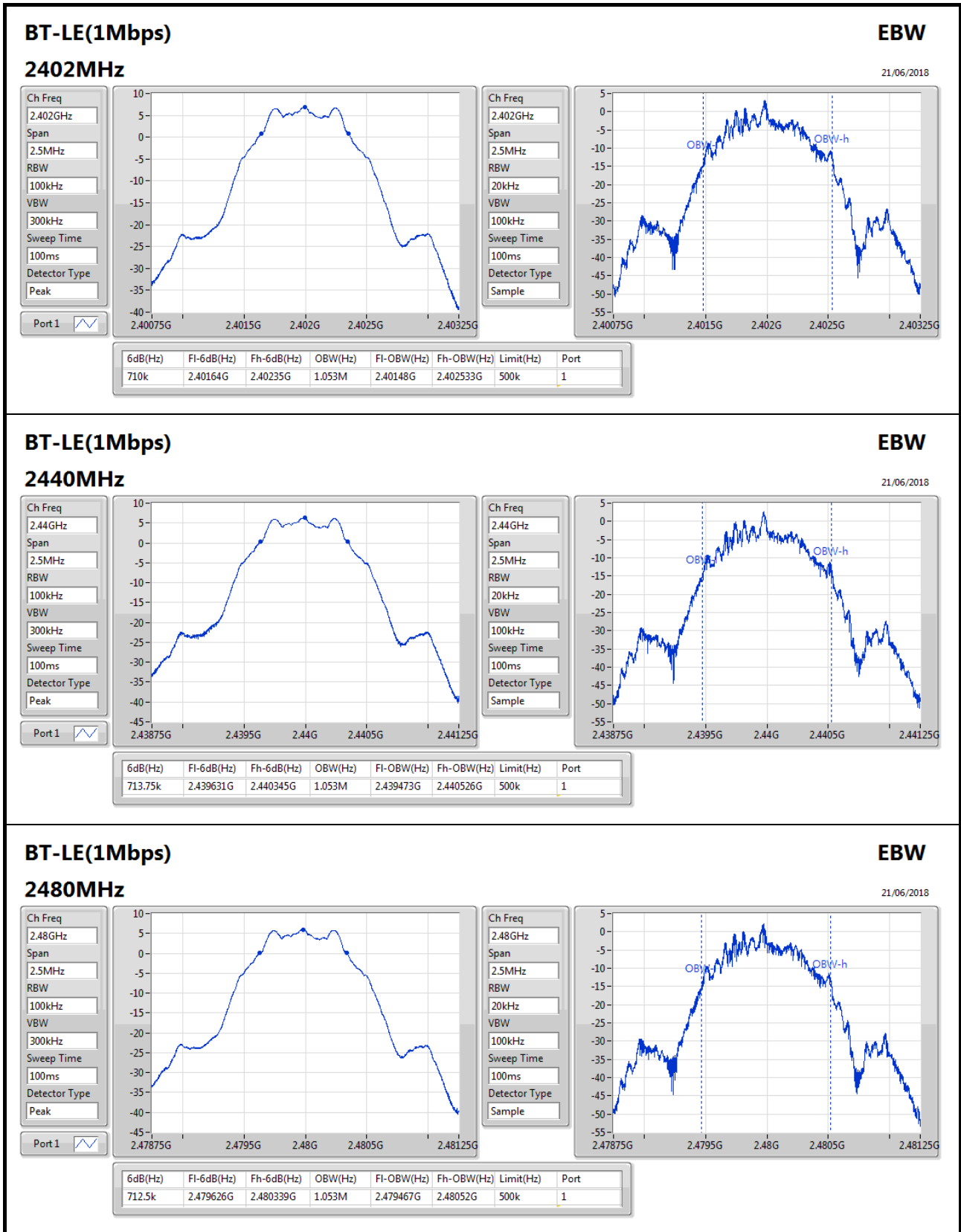



Summary

Mode	Power (dBm)	Power (W)
2.4-2.4835GHz	-	-
BT-LE(1Mbps)	6.84	0.00483

Result

Mode	Result	Gain (dBi)	Power (dBm)	Power Limit (dBm)
BT-LE(1Mbps)	-	-	-	-
2402MHz_TnomVnom	Pass	0.94	6.84	30.00
2440MHz_TnomVnom	Pass	0.69	6.51	30.00
2480MHz_TnomVnom	Pass	0.10	6.13	30.00



Summary

Mode	PD (dBm/RBW)
2.4-2.4835GHz	-
BT-LE(1Mbps)	-8.65

RBW=3kHz.

Result

Mode	Result	Gain (dBi)	PD (dBm/RBW)	PD Limit (dBm/RBW)
BT-LE(1Mbps)	-	-	-	-
2402MHz_TnomVnom	Pass	0.94	-8.65	8.00
2440MHz_TnomVnom	Pass	0.69	-9.87	8.00
2480MHz_TnomVnom	Pass	0.10	-9.52	8.00

RBW=3kHz.

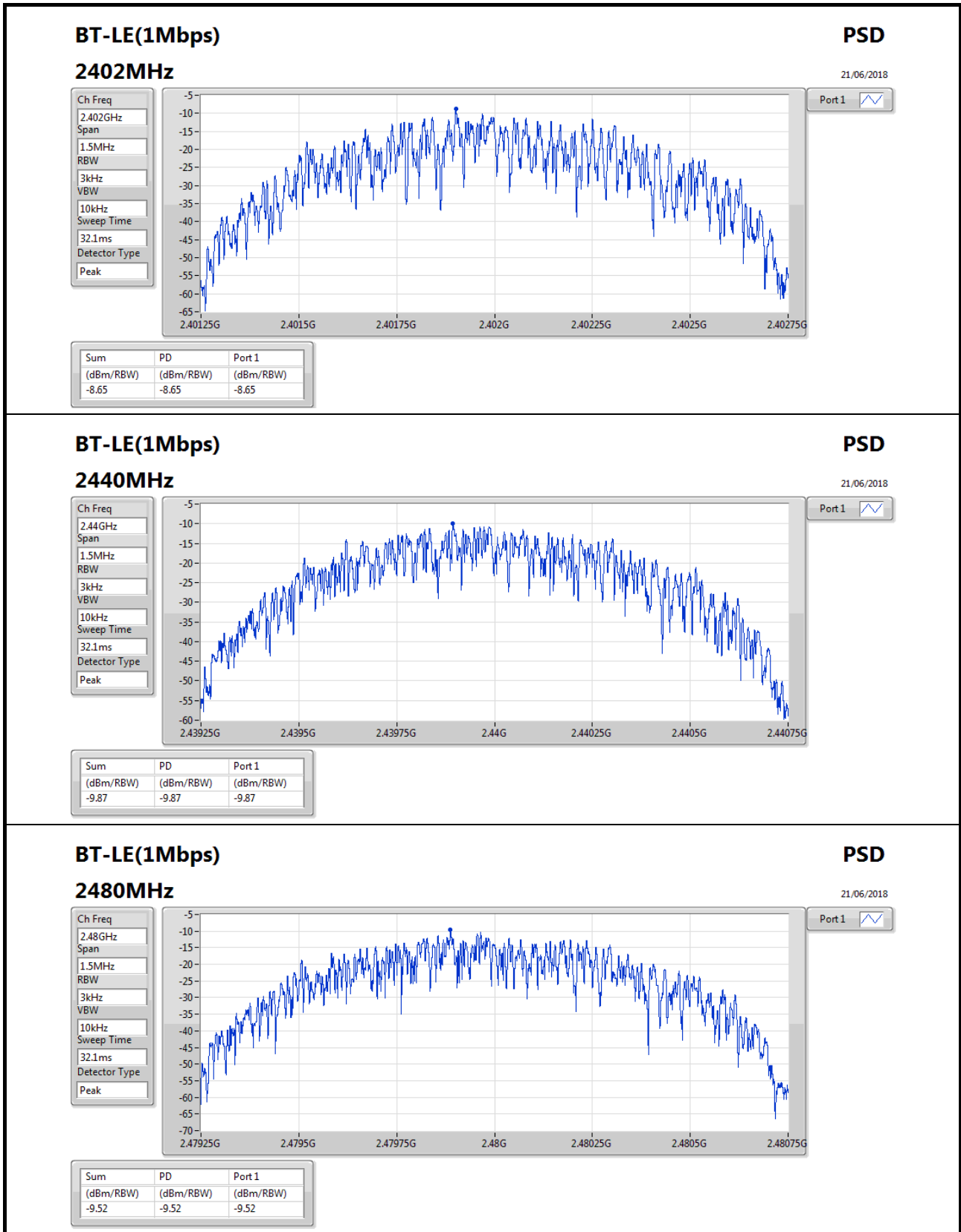



Summary

Mode	Result	Ref (Hz)	Ref (dBm)	Limit (dBm)	Freq (Hz)	Level (dBm)	Freq (Hz)	Level (dBm)	Freq (Hz)	Level (dBm)	Freq (Hz)	Level (dBm)	Port
2.4-2.4835GHz	-	-	-	-	-	-	-	-	-	-	-	-	-
BT-LE(1Mbps)	Pass	2.402004G	6.65	-23.35	147.216M	-37.67	2.399996G	-62.23	2.483672G	-59.41	24.51031G	-53.35	1

Result

Mode	Result	Ref (Hz)	Ref (dBm)	Limit (dBm)	Freq (Hz)	Level (dBm)	Freq (Hz)	Level (dBm)	Freq (Hz)	Level (dBm)	Freq (Hz)	Level (dBm)	Port
BT-LE(1Mbps)	-	-	-	-	-	-	-	-	-	-	-	-	-
2402MHz_TnomVnom	Pass	2.402004G	6.65	-23.35	147.216M	-37.99	2.399992G	-52.57	2.483956G	-62.87	15.321579G	-51.56	1
2440MHz_TnomVnom	Pass	2.402004G	6.65	-23.35	147.216M	-37.76	2.398436G	-61.47	2.484244G	-61.91	15.082363G	-52.97	1
2480MHz_TnomVnom	Pass	2.402004G	6.65	-23.35	147.216M	-37.67	2.399996G	-62.23	2.483672G	-59.41	24.51031G	-53.35	1

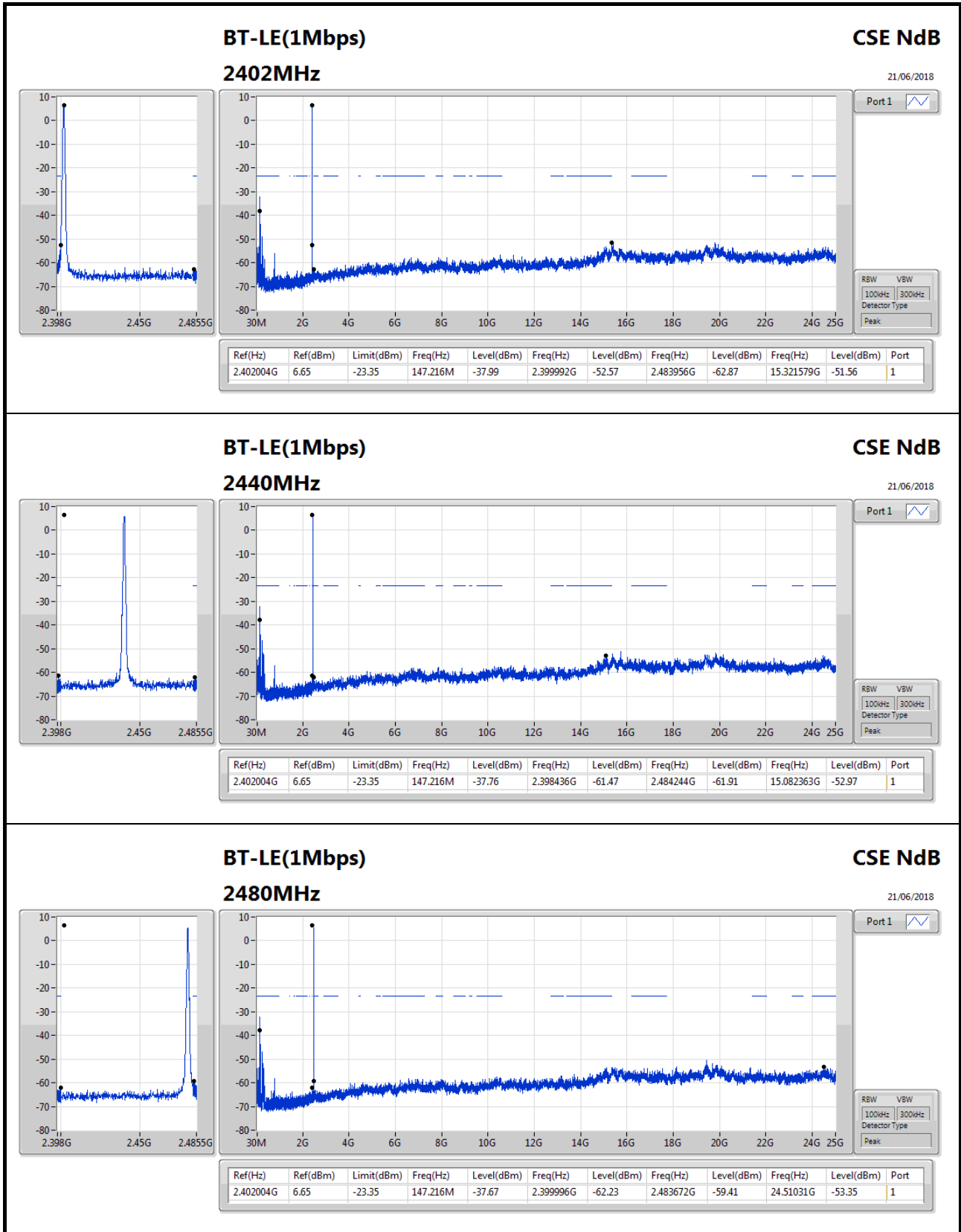

BT-LE(1Mbps)

2480MHz

CSE NdB

21/06/2018

Port1

RBW 100kHz | VBW 300kHz

Detector Type Peak



Summary

Mode	Result	Type	Freq (Hz)	Level (dBuV/m)	Limit (dBuV/m)	Margin (dB)	Factor (dB)	Dist (m)	Condition	Azimuth (°)	Height (m)	Comments
2.4-2.4835GHz	-	-	-	-	-	-	-	-	-	-	-	-
BT-LE(1Mbps)	Pass	PK	749.74M	41.49	46.00	-4.51	0.95	3	Horizontal	360	1.00	-



Result

Mode	Result	Type	Freq (Hz)	Level (dBuV/m)	Limit (dBuV/m)	Margin (dB)	Factor (dB)	Dist (m)	Condition	Azimuth (°)	Height (m)	Comments
BT-LE(1Mbps)	-	-	-	-	-	-	-	-	-	-	-	-
2440MHz	Pass	PK	47.07k	55.37	114.13	-58.76	21.29	3	Horizontal	0	1.00	-
2440MHz	Pass	PK	93.882k	46.50	108.13	-61.63	20.83	3	Horizontal	0	1.00	-
2440MHz	Pass	PK	112.212k	45.36	106.59	-61.23	20.77	3	Horizontal	0	1.00	-
2440MHz	Pass	PK	19.9107M	39.52	69.50	-29.98	23.21	3	Horizontal	360	1.00	-
2440MHz	Pass	PK	9.5826M	38.85	69.50	-30.65	22.01	3	Horizontal	360	1.00	-
2440MHz	Pass	PK	3.3141M	40.59	69.50	-28.91	20.83	3	Horizontal	360	1.00	-
2440MHz	Pass	PK	70.74M	27.76	40.00	-12.24	-15.07	3	Vertical	360	1.00	-
2440MHz	Pass	PK	90.14M	31.36	43.50	-12.14	-12.35	3	Vertical	360	1.00	-
2440MHz	Pass	PK	270.56M	41.00	46.00	-5.00	-6.37	3	Vertical	360	1.00	-
2440MHz	Pass	PK	530.52M	34.07	46.00	-11.93	-2.02	3	Vertical	360	1.00	-
2440MHz	Pass	PK	650.8M	32.49	46.00	-13.51	-0.42	3	Vertical	360	1.00	-
2440MHz	Pass	PK	749.74M	34.53	46.00	-11.47	0.95	3	Vertical	360	1.00	-
2440MHz	Pass	PK	31.94M	24.52	40.00	-15.48	-5.36	3	Horizontal	360	1.00	-
2440MHz	Pass	PK	115.36M	26.63	43.50	-16.87	-8.93	3	Horizontal	360	1.00	-
2440MHz	Pass	PK	650.8M	36.01	46.00	-9.99	-0.42	3	Horizontal	360	1.00	-
2440MHz	Pass	PK	749.74M	41.49	46.00	-4.51	0.95	3	Horizontal	360	1.00	-
2440MHz	Pass	PK	850.62M	39.70	46.00	-6.30	1.99	3	Horizontal	360	1.00	-
2440MHz	Pass	QP	276.38M	36.66	46.00	-9.34	-6.32	3	Horizontal	146	1.00	-

BT-LE(1Mbps)
2440MHz_Adapter

15/08/2018

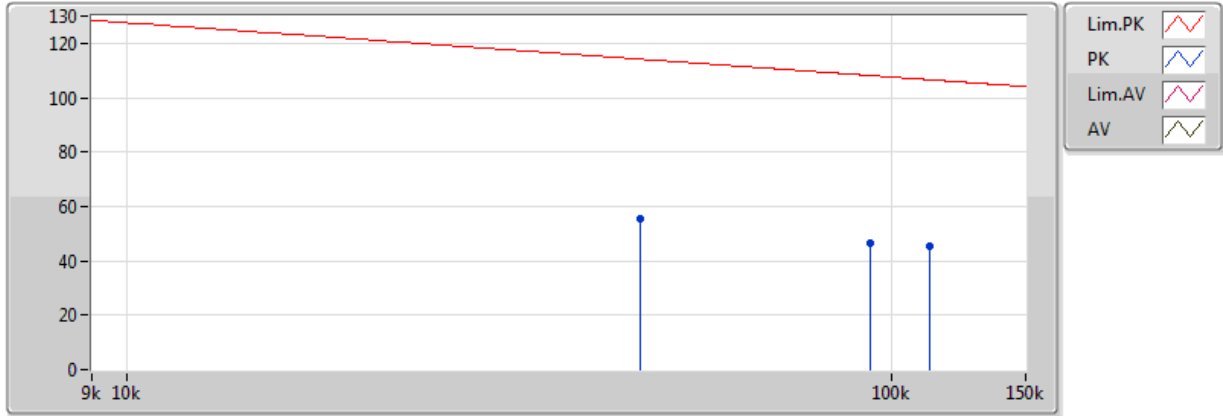

Type	Freq (Hz)	Level (dBuV/m)	Limit (dBuV/m)	Margin (dB)	Factor (dB)	Dist (m)	Condition	Azimuth (°)	Height (m)	Comments
PK	47.07k	55.37	114.13	-58.76	21.29	3	Horizontal	0	1.00	-
PK	93.882k	46.50	108.13	-61.63	20.83	3	Horizontal	0	1.00	-
PK	112.212k	45.36	106.59	-61.23	20.77	3	Horizontal	0	1.00	-

BT-LE(1Mbps)
2440MHz_Adapter

15/08/2018

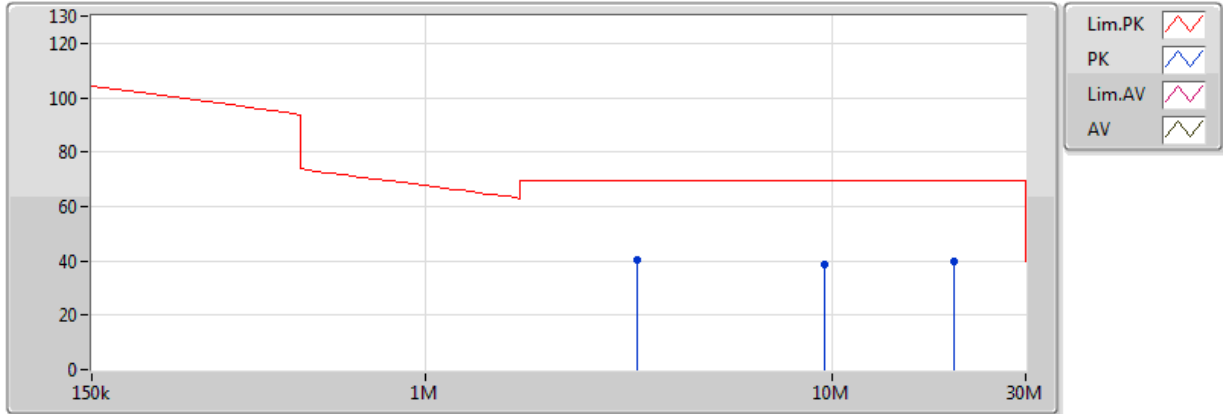

Type	Freq (Hz)	Level (dBuV/m)	Limit (dBuV/m)	Margin (dB)	Factor (dB)	Dist (m)	Condition	Azimuth (°)	Height (m)	Comments
PK	19.9107M	39.52	69.50	-29.98	23.21	3	Horizontal	360	1.00	-
PK	9.5826M	38.85	69.50	-30.65	22.01	3	Horizontal	360	1.00	-
PK	3.3141M	40.59	69.50	-28.91	20.83	3	Horizontal	360	1.00	-

BT-LE(1Mbps)
2440MHz_Adapter

15/08/2018

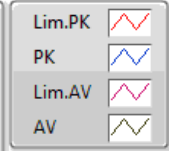
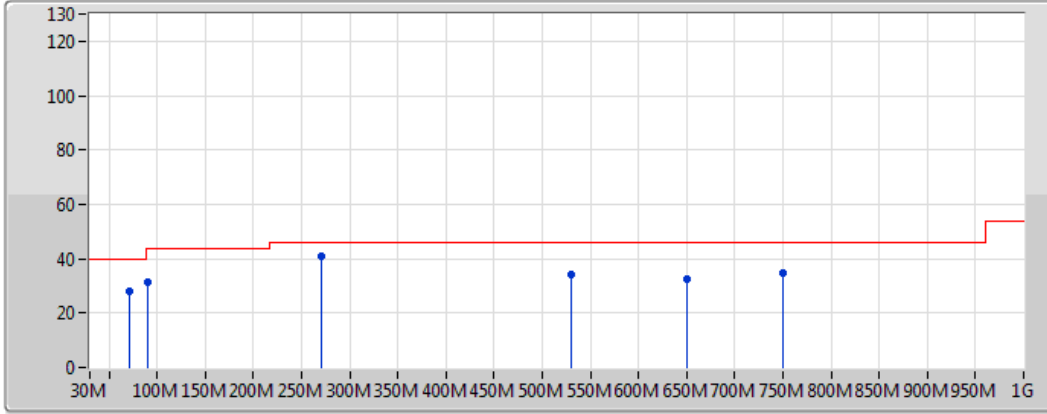

Type	Freq (Hz)	Level (dBuV/m)	Limit (dBuV/m)	Margin (dB)	Factor (dB)	Dist (m)	Condition	Azimuth (°)	Height (m)	Comments
PK	70.74M	27.76	40.00	-12.24	-15.07	3	Vertical	360	1.00	-
PK	90.14M	31.36	43.50	-12.14	-12.35	3	Vertical	360	1.00	-
PK	270.56M	41.00	46.00	-5.00	-6.37	3	Vertical	360	1.00	-
PK	530.52M	34.07	46.00	-11.93	-2.02	3	Vertical	360	1.00	-
PK	650.8M	32.49	46.00	-13.51	-0.42	3	Vertical	360	1.00	-
PK	749.74M	34.53	46.00	-11.47	0.95	3	Vertical	360	1.00	-

BT-LE(1Mbps)
2440MHz_Adapter

15/08/2018

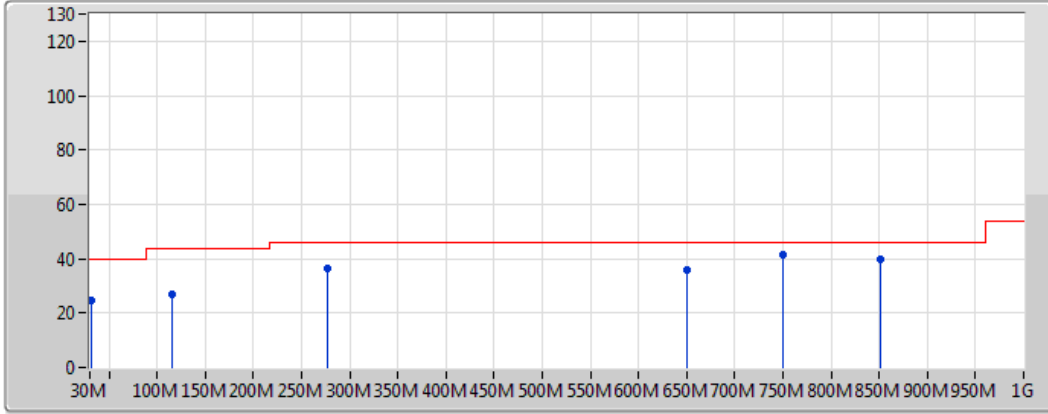

Legend for the spectrum plot:

- Lim.PK (Red line)
- PK (Blue line)
- Lim.AV (Pink line)
- AV (Black line)

Type	Freq (Hz)	Level (dBuV/m)	Limit (dBuV/m)	Margin (dB)	Factor (dB)	Dist (m)	Condition	Azimuth (°)	Height (m)	Comments
PK	31.94M	24.52	40.00	-15.48	-5.36	3	Horizontal	360	1.00	-
PK	115.36M	26.63	43.50	-16.87	-8.93	3	Horizontal	360	1.00	-
PK	650.8M	36.01	46.00	-9.99	-0.42	3	Horizontal	360	1.00	-
PK	749.74M	41.49	46.00	-4.51	0.95	3	Horizontal	360	1.00	-
PK	850.62M	39.70	46.00	-6.30	1.99	3	Horizontal	360	1.00	-
QP	276.38M	36.66	46.00	-9.34	-6.32	3	Horizontal	146	1.00	-



Summary

Mode	Result	Type	Freq (Hz)	Level (dBuV/m)	Limit (dBuV/m)	Margin (dB)	Factor (dB)	Dist (m)	Condition	Azimuth (°)	Height (m)	Comments
2.4-2.4835GHz	-	-	-	-	-	-	-	-	-	-	-	-
BT-LE(1Mbps)	Pass	PK	749.74M	41.49	46.00	-4.51	0.95	3	Horizontal	360	1.00	-



Result

Mode	Result	Type	Freq (Hz)	Level (dBuV/m)	Limit (dBuV/m)	Margin (dB)	Factor (dB)	Dist (m)	Condition	Azimuth (°)	Height (m)	Comments
BT-LE(1Mbps)	-	-	-	-	-	-	-	-	-	-	-	-
2440MHz	Pass	PK	70.74M	27.76	40.00	-12.24	-15.07	3	Vertical	0	1.00	-
2440MHz	Pass	PK	90.14M	31.36	43.50	-12.14	-12.35	3	Vertical	0	1.00	-
2440MHz	Pass	PK	270.56M	41.00	46.00	-5.00	-6.37	3	Vertical	0	1.00	-
2440MHz	Pass	PK	530.52M	34.07	46.00	-11.93	-2.02	3	Vertical	0	1.00	-
2440MHz	Pass	PK	650.8M	32.49	46.00	-13.51	-0.42	3	Vertical	0	1.00	-
2440MHz	Pass	PK	749.74M	34.53	46.00	-11.47	0.95	3	Vertical	0	1.00	-
2440MHz	Pass	PK	31.94M	24.52	40.00	-15.48	-5.36	3	Horizontal	360	1.00	-
2440MHz	Pass	PK	115.36M	26.63	43.50	-16.87	-8.93	3	Horizontal	360	1.00	-
2440MHz	Pass	PK	650.8M	36.01	46.00	-9.99	-0.42	3	Horizontal	360	1.00	-
2440MHz	Pass	PK	749.74M	41.49	46.00	-4.51	0.95	3	Horizontal	360	1.00	-
2440MHz	Pass	PK	850.62M	39.70	46.00	-6.30	1.99	3	Horizontal	360	1.00	-
2440MHz	Pass	QP	276.38M	36.66	46.00	-9.34	-6.32	3	Horizontal	146	1.00	-

BT-LE(1Mbps)
2440MHz_Adapter

19/07/2018

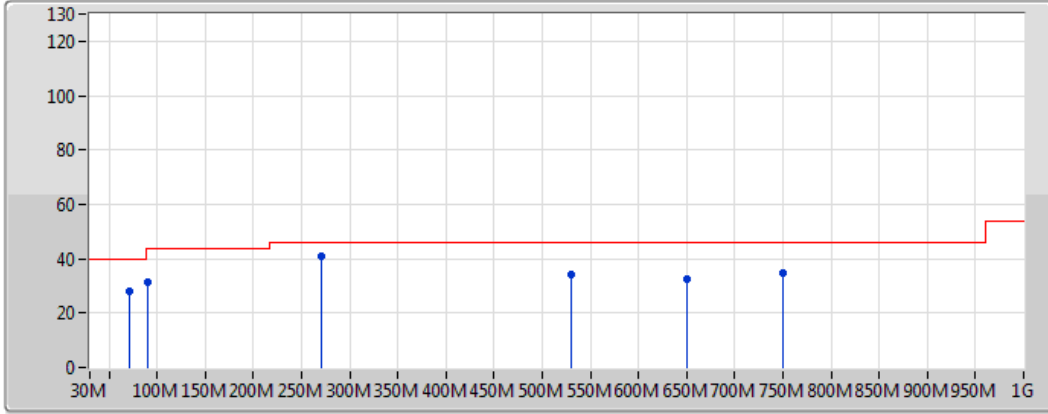

Legend for the spectrum plot:

- Lim.PK: Red line with a peak symbol
- PK: Blue line with a peak symbol
- Lim.AV: Red line with a valley symbol
- AV: Black line with a valley symbol

Type	Freq (Hz)	Level (dBuV/m)	Limit (dBuV/m)	Margin (dB)	Factor (dB)	Dist (m)	Condition	Azimuth (°)	Height (m)	Comments
PK	70.74M	27.76	40.00	-12.24	-15.07	3	Vertical	0	1.00	-
PK	90.14M	31.36	43.50	-12.14	-12.35	3	Vertical	0	1.00	-
PK	270.56M	41.00	46.00	-5.00	-6.37	3	Vertical	0	1.00	-
PK	530.52M	34.07	46.00	-11.93	-2.02	3	Vertical	0	1.00	-
PK	650.8M	32.49	46.00	-13.51	-0.42	3	Vertical	0	1.00	-
PK	749.74M	34.53	46.00	-11.47	0.95	3	Vertical	0	1.00	-

BT-LE(1Mbps)
2440MHz_Adapter

19/07/2018

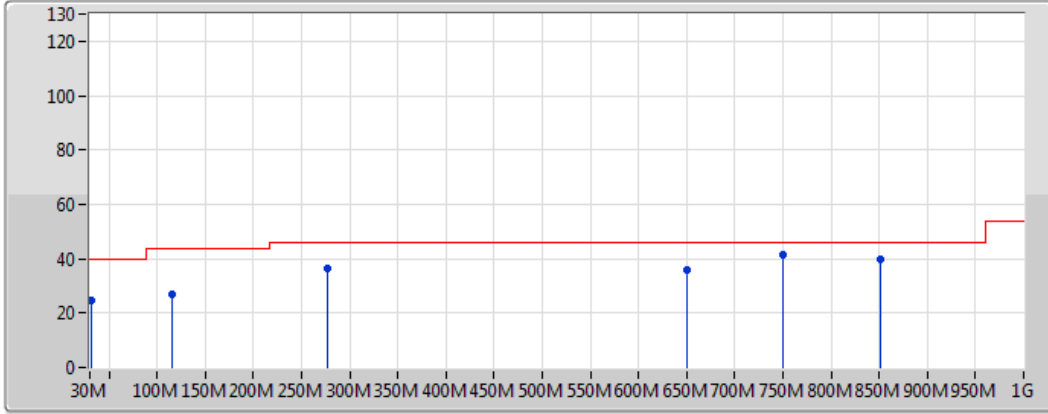

Type	Freq (Hz)	Level (dBuV/m)	Limit (dBuV/m)	Margin (dB)	Factor (dB)	Dist (m)	Condition	Azimuth (°)	Height (m)	Comments
PK	31.94M	24.52	40.00	-15.48	-5.36	3	Horizontal	360	1.00	-
PK	115.36M	26.63	43.50	-16.87	-8.93	3	Horizontal	360	1.00	-
PK	650.8M	36.01	46.00	-9.99	-0.42	3	Horizontal	360	1.00	-
PK	749.74M	41.49	46.00	-4.51	0.95	3	Horizontal	360	1.00	-
PK	850.62M	39.70	46.00	-6.30	1.99	3	Horizontal	360	1.00	-
QP	276.38M	36.66	46.00	-9.34	-6.32	3	Horizontal	146	1.00	-



Summary

Mode	Type	Freq (Hz)	Level (dBuV/m)	Limit (dBuV/m)	Margin (dB)	Factor (dB)	Condition	Azimuth (°)	Height (m)
Mode 2	QK	575M	33.83	37.00	-3.17	-27.65	Horizontal	189	252

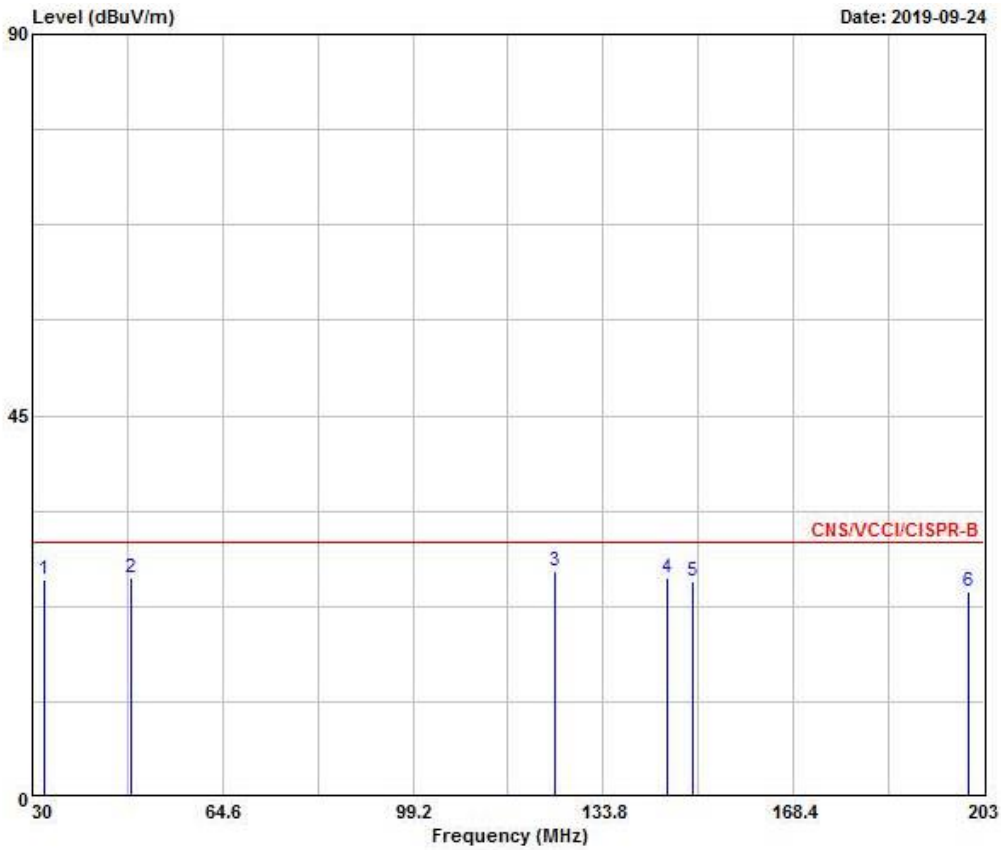

	Freq	Level	Over Limit	Limit Line	Read Level	Cable Loss	Preamp Factor	Antenna Factor	Ant Pos	Table Pos	Remark
	MHz	dBuV/m	dB	dBuV/m	dBuV	dB	dB	dB/m	cm	deg	
1 @	32.200	25.64	-4.36	30.00	29.76	0.70	27.00	22.18	---	---	Peak
2 @	47.800	25.81	-4.19	30.00	37.77	0.87	26.98	14.15	---	---	QP
3 @	125.000	26.65	-3.35	30.00	34.66	1.34	26.71	17.36	100	61	QP
4 @	145.380	25.91	-4.09	30.00	35.06	1.47	26.62	16.00	---	---	Peak
5 @	150.060	25.53	-4.47	30.00	35.01	1.52	26.61	15.61	---	---	Peak
6 @	200.060	24.21	-5.79	30.00	34.49	1.71	26.39	14.40	---	---	Peak

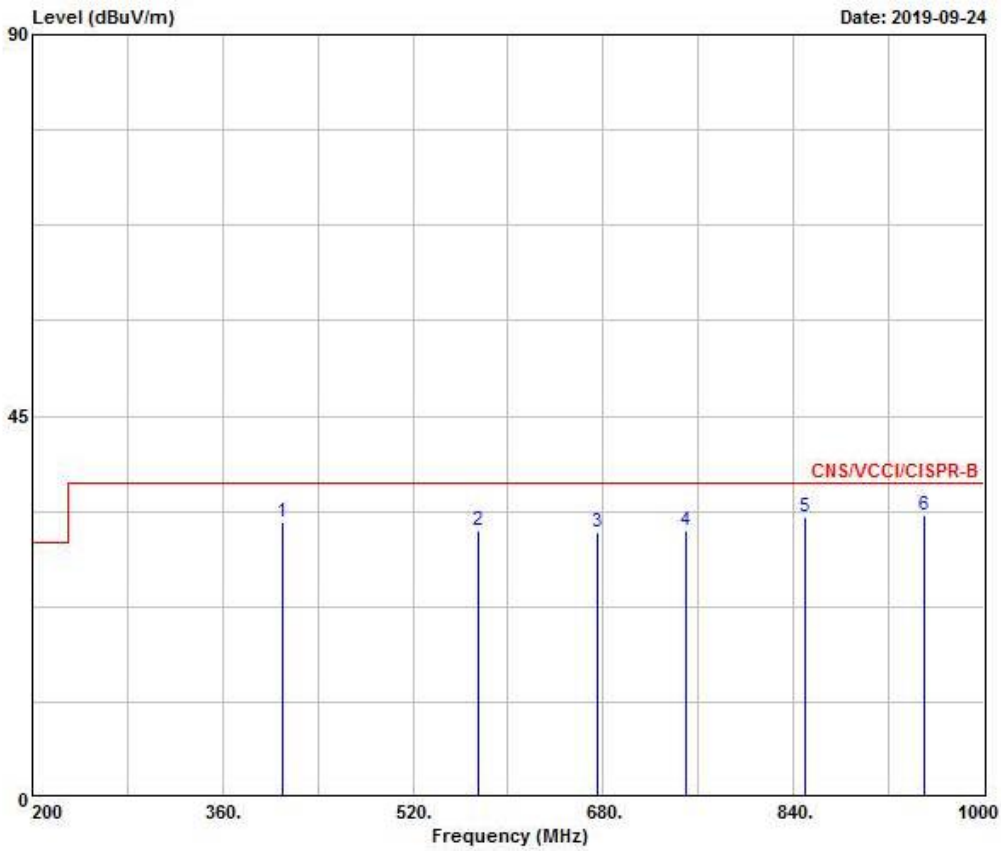

	Freq	Level	Over Limit	Limit Line	Read Level	Cable Loss	Preamp Factor	Antenna Factor	Ant Pos	Table Pos	Remark
	MHz	dBuV/m	dB	dBuV/m	dBuV	dB	dB	dB/m	cm	deg	
1 @	410.400	32.51	-4.49	37.00	35.46	2.70	27.08	21.43	---	---	Peak
2 @	575.000	31.38	-5.62	37.00	32.10	3.26	27.65	23.67	---	---	Peak
3 @	675.000	31.19	-5.81	37.00	31.40	3.45	27.66	24.00	---	---	Peak
4 @	750.000	31.40	-5.60	37.00	30.80	3.39	27.58	24.79	---	---	QP
5 @	850.000	33.04	-3.96	37.00	30.90	4.07	27.41	25.48	---	---	QP
6 @	950.000	33.23	-3.77	37.00	30.17	4.14	27.20	26.12	---	---	QP

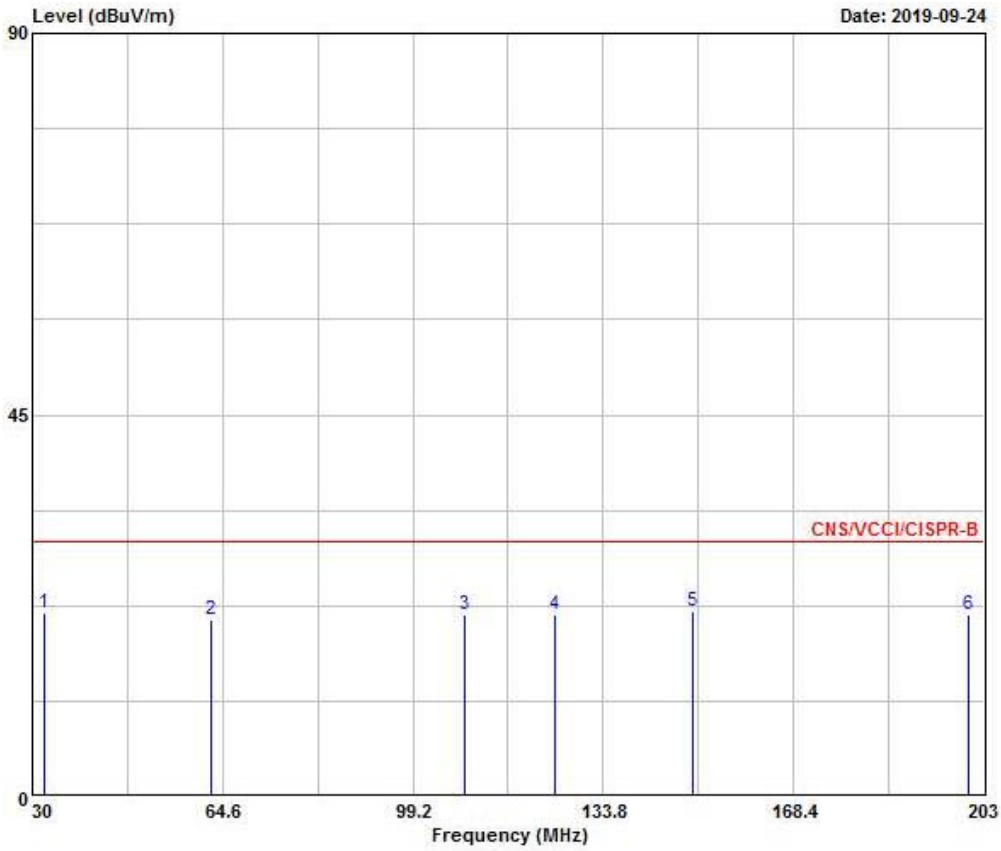

Peak	Freq	Level	Over Limit	Limit Line	Read Level	Cable Loss	Preamp Factor	Antenna Factor	Ant Pos	Table Pos	Remark
	MHz	dBuV/m	dB	dBuV/m	dBuV	dB	dB	dB/m	cm	deg	
1	32.030	21.63	-8.37	30.00	25.75	0.70	27.00	22.18	---	---	Peak
2	62.570	20.92	-9.08	30.00	35.42	0.98	26.94	11.46	---	---	Peak
3	108.720	21.51	-8.49	30.00	30.10	1.23	26.78	16.96	---	---	Peak
4	125.000	21.40	-8.60	30.00	29.41	1.34	26.71	17.36	---	---	Peak
5	150.060	21.91	-8.09	30.00	31.39	1.52	26.61	15.61	---	---	Peak
6	200.060	21.44	-8.56	30.00	31.72	1.71	26.39	14.40	---	---	Peak

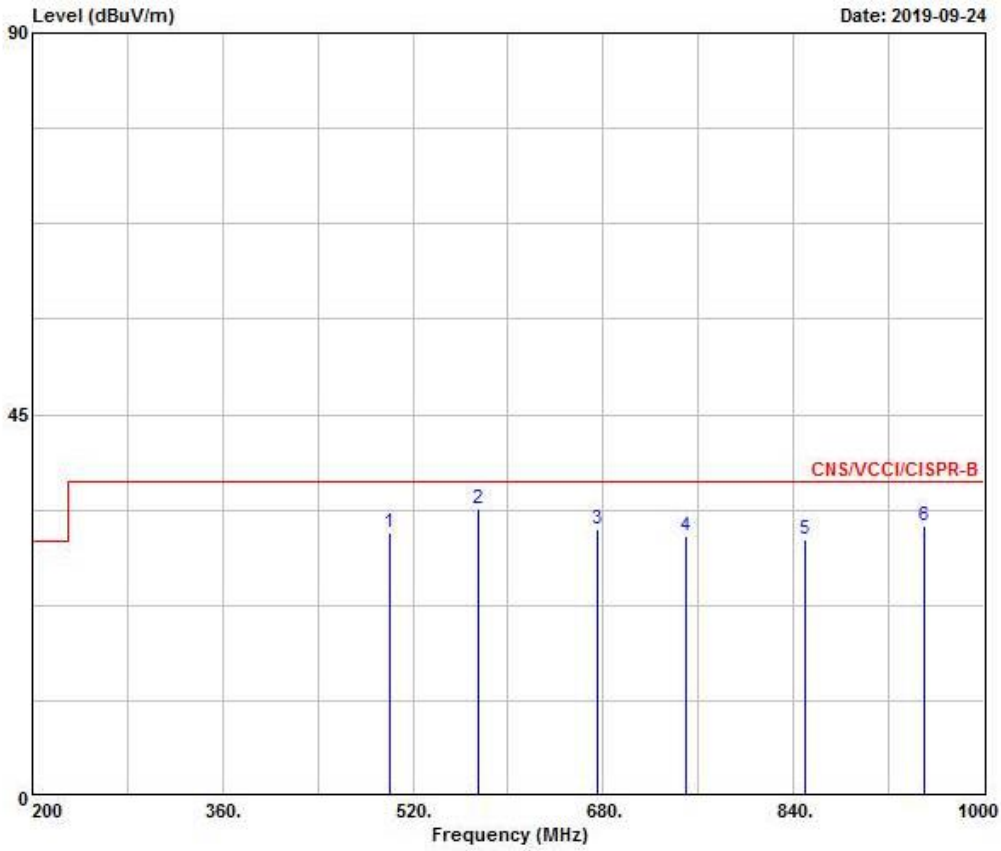

	Freq	Level	Over Limit	Limit Line	Read Level	Cable Loss	Preamp Factor	Antenna Factor	Ant Pos	Table Pos	Remark
	MHz	dBuV/m	dB	dBuV/m	dBuV	dB	dB	dB/m	cm	deg	
1 @	500.000	31.15	-5.85	37.00	33.10	3.02	27.56	22.59	---	---	Peak
2 @	575.000	33.83	-3.17	37.00	34.55	3.26	27.65	23.67	189	252	QP
3 @	675.000	31.43	-5.57	37.00	31.64	3.45	27.66	24.00	---	---	Peak
4 @	750.000	30.61	-6.39	37.00	30.01	3.39	27.58	24.79	---	---	Peak
5 @	850.000	30.22	-6.78	37.00	28.08	4.07	27.41	25.48	---	---	Peak
6 @	950.000	31.91	-5.09	37.00	28.85	4.14	27.20	26.12	---	---	Peak



Summary

Mode	Result	Type	Freq (Hz)	Level (dBuV/m)	Limit (dBuV/m)	Margin (dB)	Factor (dB)	Dist (m)	Condition	Azimuth (°)	Height (m)	Comments
2.4-2.4835GHz	-	-	-	-	-	-	-	-	-	-	-	-
BT-LE(1Mbps)	Pass	AV	2.498G	50.13	54.00	-3.87	32.67	3	Vertical	257	3.19	-



Result

Mode	Result	Type	Freq (Hz)	Level (dBuV/m)	Limit (dBuV/m)	Margin (dB)	Factor (dB)	Dist (m)	Condition	Azimuth (°)	Height (m)	Comments
BT-LE(1Mbps)	-	-	-	-	-	-	-	-	-	-	-	-
2402MHz	Pass	AV	2.3874G	49.31	54.00	-4.69	32.26	3	Vertical	252	1.04	-
2402MHz	Pass	AV	2.402G	97.07	Inf	-Inf	32.31	3	Vertical	252	1.04	-
2402MHz	Pass	PK	2.3836G	60.25	74.00	-13.75	32.25	3	Vertical	252	1.04	-
2402MHz	Pass	PK	2.4018G	97.59	Inf	-Inf	32.31	3	Vertical	252	1.04	-
2402MHz	Pass	AV	2.382G	49.27	54.00	-4.73	32.25	3	Horizontal	182	1.03	-
2402MHz	Pass	AV	2.402G	98.72	Inf	-Inf	32.31	3	Horizontal	182	1.03	-
2402MHz	Pass	PK	2.3774G	60.44	74.00	-13.56	32.23	3	Horizontal	182	1.03	-
2402MHz	Pass	PK	2.4018G	99.26	Inf	-Inf	32.31	3	Horizontal	182	1.03	-
2402MHz	Pass	AV	4.80396G	42.40	54.00	-11.60	2.99	3	Vertical	277	1.02	-
2402MHz	Pass	PK	4.80452G	51.25	74.00	-22.75	2.99	3	Vertical	277	1.02	-
2402MHz	Pass	AV	4.8039G	41.08	54.00	-12.92	2.99	3	Horizontal	178	1.01	-
2402MHz	Pass	PK	4.80436G	50.81	74.00	-23.19	2.99	3	Horizontal	178	1.01	-
2440MHz	Pass	AV	2.389998G	49.10	54.00	-4.90	32.28	3	Vertical	257	3.19	-
2440MHz	Pass	AV	2.44G	97.57	Inf	-Inf	32.46	3	Vertical	257	3.19	-
2440MHz	Pass	AV	2.498G	50.13	54.00	-3.87	32.67	3	Vertical	257	3.19	-
2440MHz	Pass	PK	2.3428G	59.45	74.00	-14.55	32.10	3	Vertical	257	3.19	-
2440MHz	Pass	PK	2.4404G	98.14	Inf	-Inf	32.46	3	Vertical	257	3.19	-
2440MHz	Pass	PK	2.4972G	60.36	74.00	-13.64	32.66	3	Vertical	257	3.19	-
2440MHz	Pass	AV	2.34G	49.34	54.00	-4.66	32.10	3	Horizontal	147	1.15	-
2440MHz	Pass	AV	2.44G	96.01	Inf	-Inf	32.46	3	Horizontal	147	1.15	-
2440MHz	Pass	AV	2.4984G	50.13	54.00	-3.87	32.67	3	Horizontal	147	1.15	-
2440MHz	Pass	PK	2.3432G	59.67	74.00	-14.33	32.10	3	Horizontal	147	1.15	-
2440MHz	Pass	PK	2.4404G	96.55	Inf	-Inf	32.46	3	Horizontal	147	1.15	-
2440MHz	Pass	PK	2.483502G	60.76	74.00	-13.24	32.61	3	Horizontal	147	1.15	-
2440MHz	Pass	AV	4.87994G	40.51	54.00	-13.49	3.16	3	Vertical	170	2.10	-
2440MHz	Pass	PK	4.87946G	50.20	74.00	-23.80	3.16	3	Vertical	170	2.10	-
2440MHz	Pass	AV	4.87972G	38.32	54.00	-15.68	3.16	3	Horizontal	180	1.01	-
2440MHz	Pass	PK	4.87952G	48.49	74.00	-25.51	3.16	3	Horizontal	180	1.01	-
2480MHz	Pass	AV	2.48G	95.75	Inf	-Inf	32.60	3	Vertical	261	2.82	-
2480MHz	Pass	AV	2.4988G	50.13	54.00	-3.87	32.67	3	Vertical	261	2.82	-
2480MHz	Pass	PK	2.4802G	96.32	Inf	-Inf	32.60	3	Vertical	261	2.82	-
2480MHz	Pass	PK	2.4964G	60.80	74.00	-13.20	32.66	3	Vertical	261	2.82	-
2480MHz	Pass	AV	2.48G	95.06	Inf	-Inf	32.60	3	Horizontal	191	2.11	-
2480MHz	Pass	AV	2.4988G	50.13	54.00	-3.87	32.67	3	Horizontal	191	2.11	-
2480MHz	Pass	PK	2.4798G	95.60	Inf	-Inf	32.60	3	Horizontal	191	2.11	-
2480MHz	Pass	PK	2.4904G	61.14	74.00	-12.86	32.64	3	Horizontal	191	2.11	-
2480MHz	Pass	AV	4.9598G	42.74	54.00	-11.26	3.33	3	Vertical	172	2.17	-
2480MHz	Pass	PK	4.95964G	51.84	74.00	-22.16	3.33	3	Vertical	172	2.17	-
2480MHz	Pass	AV	4.95995G	39.73	54.00	-14.27	3.33	3	Horizontal	186	1.06	-
2480MHz	Pass	PK	4.96044G	50.52	74.00	-23.48	3.33	3	Horizontal	186	1.06	-

BT-LE(1Mbps)

2402MHz_TX

18/06/2018

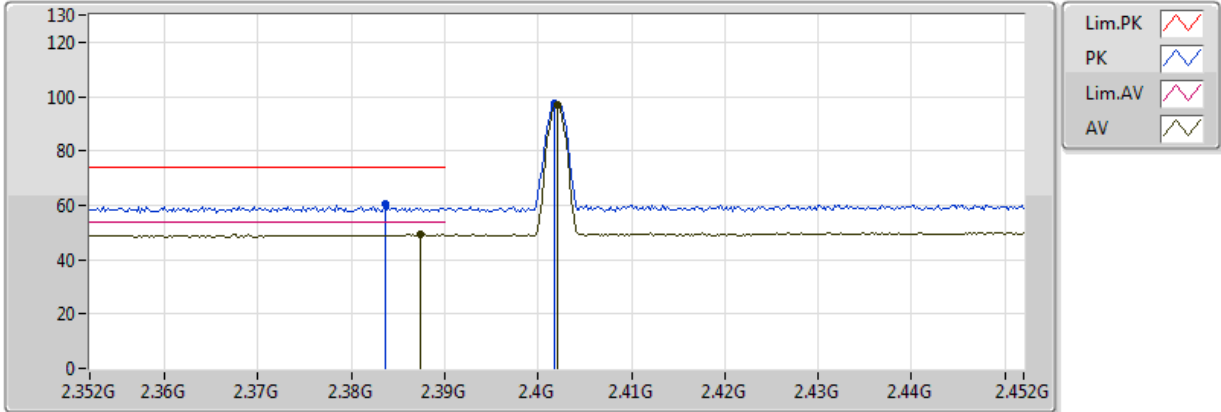

Type	Freq (Hz)	Level (dBuV/m)	Limit (dBuV/m)	Margin (dB)	Factor (dB)	Dist (m)	Condition	Azimuth (°)	Height (m)	Comments
AV	2.3874G	49.31	54.00	-4.69	32.26	3	Vertical	252	1.04	-
AV	2.402G	97.07	Inf	-Inf	32.31	3	Vertical	252	1.04	-
PK	2.3836G	60.25	74.00	-13.75	32.25	3	Vertical	252	1.04	-
PK	2.4018G	97.59	Inf	-Inf	32.31	3	Vertical	252	1.04	-

BT-LE(1Mbps)

2402MHz_TX

18/06/2018

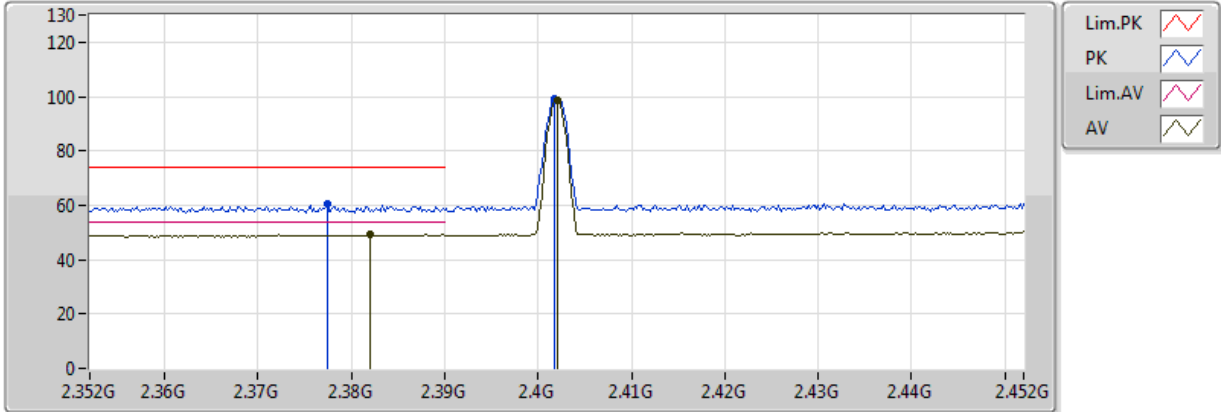





Type	Freq (Hz)	Level (dBuV/m)	Limit (dBuV/m)	Margin (dB)	Factor (dB)	Dist (m)	Condition	Azimuth (°)	Height (m)	Comments
AV	2.382G	49.27	54.00	-4.73	32.25	3	Horizontal	182	1.03	-
AV	2.402G	98.72	Inf	-Inf	32.31	3	Horizontal	182	1.03	-
PK	2.3774G	60.44	74.00	-13.56	32.23	3	Horizontal	182	1.03	-
PK	2.4018G	99.26	Inf	-Inf	32.31	3	Horizontal	182	1.03	-

BT-LE(1Mbps)

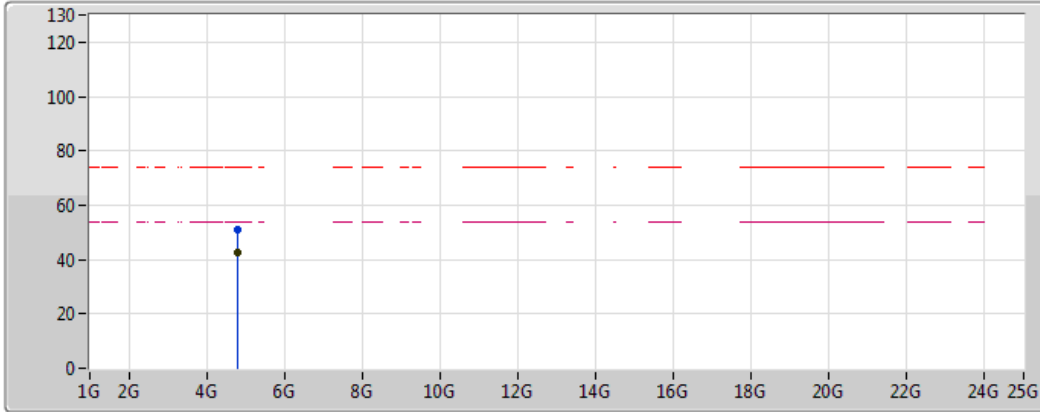
2402MHz_TX

18/06/2018



Lim.PK	
PK	
Lim.AV	
AV	





Type	Freq (Hz)	Level (dBuV/m)	Limit (dBuV/m)	Margin (dB)	Factor (dB)	Dist (m)	Condition	Azimuth (°)	Height (m)	Comments
AV	4.80396G	42.40	54.00	-11.60	2.99	3	Vertical	277	1.02	-
PK	4.80452G	51.25	74.00	-22.75	2.99	3	Vertical	277	1.02	-

BT-LE(1Mbps)

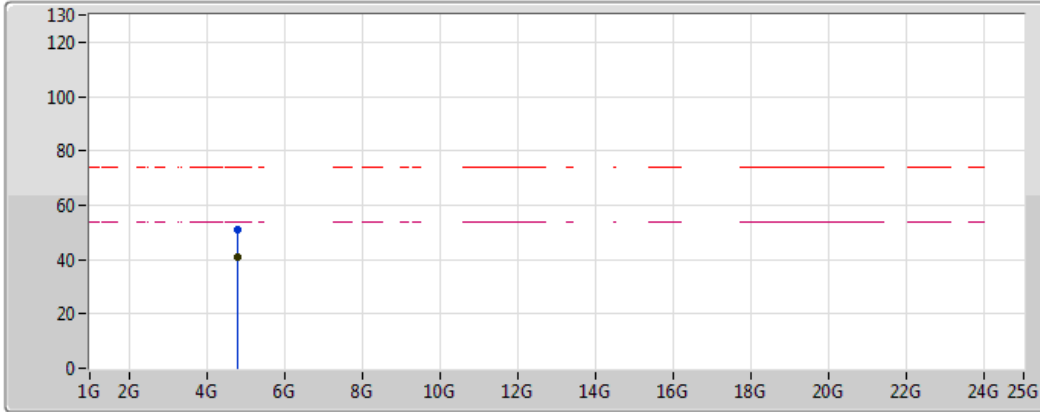
2402MHz_TX

18/06/2018



Lim.PK	
PK	
Lim.AV	
AV	

Type	Freq (Hz)	Level (dBuV/m)	Limit (dBuV/m)	Margin (dB)	Factor (dB)	Dist (m)	Condition	Azimuth (°)	Height (m)	Comments
AV	4.8039G	41.08	54.00	-12.92	2.99	3	Horizontal	178	1.01	-
PK	4.80436G	50.81	74.00	-23.19	2.99	3	Horizontal	178	1.01	-

BT-LE(1Mbps)

2440MHz_TX

18/06/2018

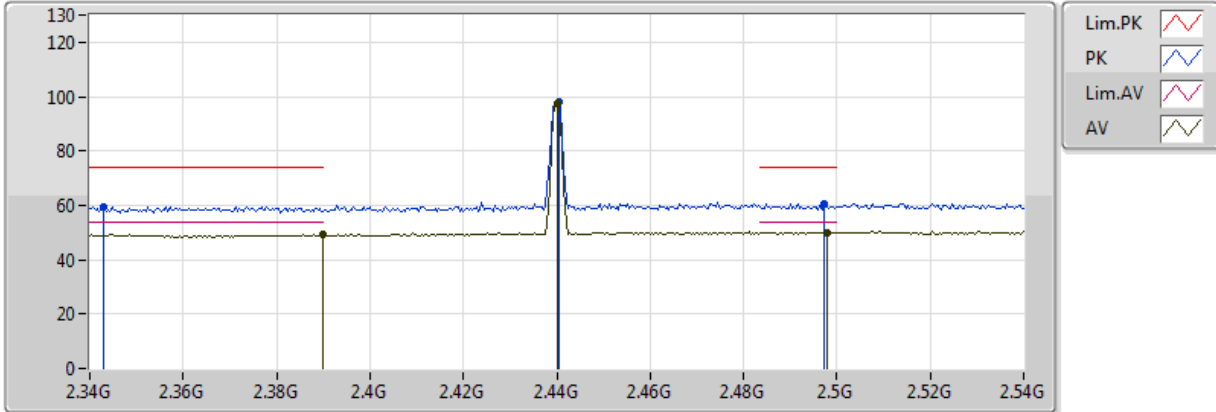

Type	Freq (Hz)	Level (dBuV/m)	Limit (dBuV/m)	Margin (dB)	Factor (dB)	Dist (m)	Condition	Azimuth (°)	Height (m)	Comments
AV	2.389998G	49.10	54.00	-4.90	32.28	3	Vertical	257	3.19	-
AV	2.44G	97.57	Inf	-Inf	32.46	3	Vertical	257	3.19	-
AV	2.498G	50.13	54.00	-3.87	32.67	3	Vertical	257	3.19	-
PK	2.3428G	59.45	74.00	-14.55	32.10	3	Vertical	257	3.19	-
PK	2.4404G	98.14	Inf	-Inf	32.46	3	Vertical	257	3.19	-
PK	2.4972G	60.36	74.00	-13.64	32.66	3	Vertical	257	3.19	-

BT-LE(1Mbps)

2440MHz_TX

18/06/2018

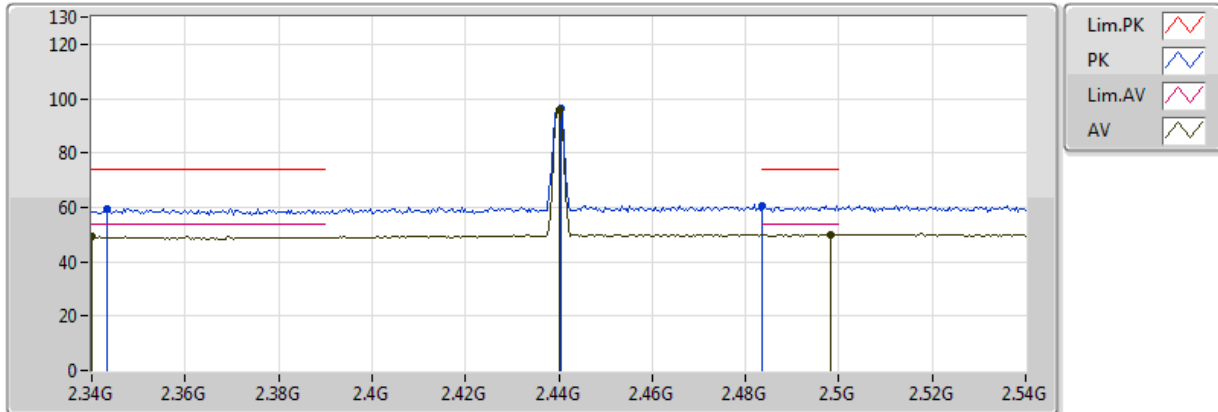





Type	Freq (Hz)	Level (dBuV/m)	Limit (dBuV/m)	Margin (dB)	Factor (dB)	Dist (m)	Condition	Azimuth (°)	Height (m)	Comments
AV	2.34G	49.34	54.00	-4.66	32.10	3	Horizontal	147	1.15	-
AV	2.44G	96.01	Inf	-Inf	32.46	3	Horizontal	147	1.15	-
AV	2.4984G	50.13	54.00	-3.87	32.67	3	Horizontal	147	1.15	-
PK	2.3432G	59.67	74.00	-14.33	32.10	3	Horizontal	147	1.15	-
PK	2.4404G	96.55	Inf	-Inf	32.46	3	Horizontal	147	1.15	-
PK	2.483502G	60.76	74.00	-13.24	32.61	3	Horizontal	147	1.15	-

BT-LE(1Mbps)

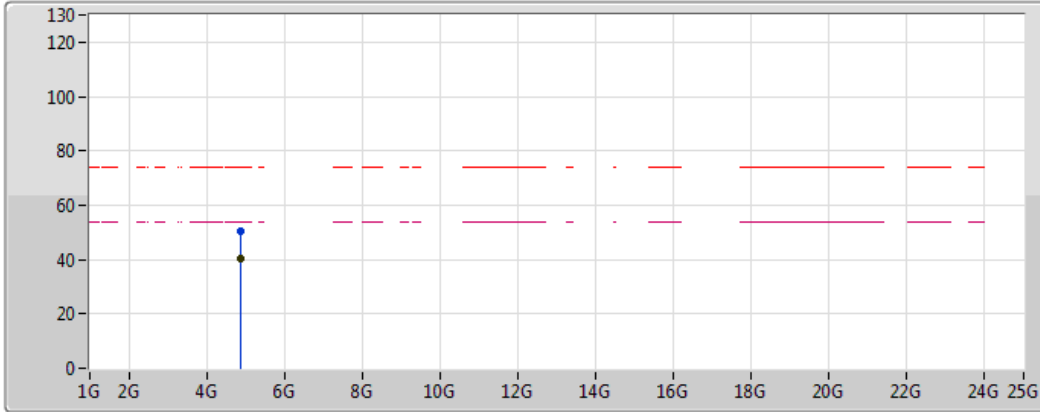
2440MHz_TX

18/06/2018



Lim.PK	
PK	
Lim.AV	
AV	





Type	Freq (Hz)	Level (dBuV/m)	Limit (dBuV/m)	Margin (dB)	Factor (dB)	Dist (m)	Condition	Azimuth (°)	Height (m)	Comments
AV	4.87994G	40.51	54.00	-13.49	3.16	3	Vertical	170	2.10	-
PK	4.87946G	50.20	74.00	-23.80	3.16	3	Vertical	170	2.10	-

BT-LE(1Mbps)

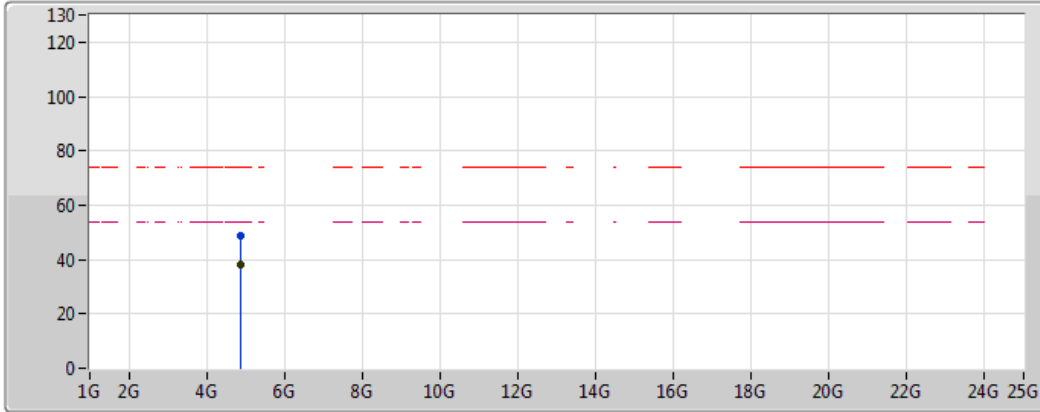
2440MHz_TX

18/06/2018



Lim.PK	
PK	
Lim.AV	
AV	

Type	Freq (Hz)	Level (dBuV/m)	Limit (dBuV/m)	Margin (dB)	Factor (dB)	Dist (m)	Condition	Azimuth (°)	Height (m)	Comments
AV	4.87972G	38.32	54.00	-15.68	3.16	3	Horizontal	180	1.01	-
PK	4.87952G	48.49	74.00	-25.51	3.16	3	Horizontal	180	1.01	-

BT-LE(1Mbps)

2480MHz_TX

18/06/2018

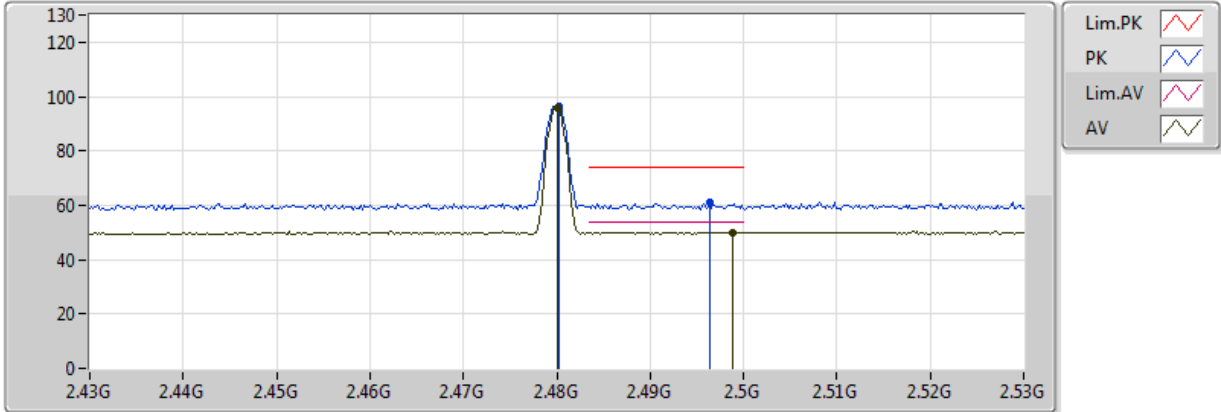

Type	Freq (Hz)	Level (dBuV/m)	Limit (dBuV/m)	Margin (dB)	Factor (dB)	Dist (m)	Condition	Azimuth (°)	Height (m)	Comments
AV	2.48G	95.75	Inf	-Inf	32.60	3	Vertical	261	2.82	-
AV	2.4988G	50.13	54.00	-3.87	32.67	3	Vertical	261	2.82	-
PK	2.4802G	96.32	Inf	-Inf	32.60	3	Vertical	261	2.82	-
PK	2.4964G	60.80	74.00	-13.20	32.66	3	Vertical	261	2.82	-

BT-LE(1Mbps)

2480MHz_TX

18/06/2018

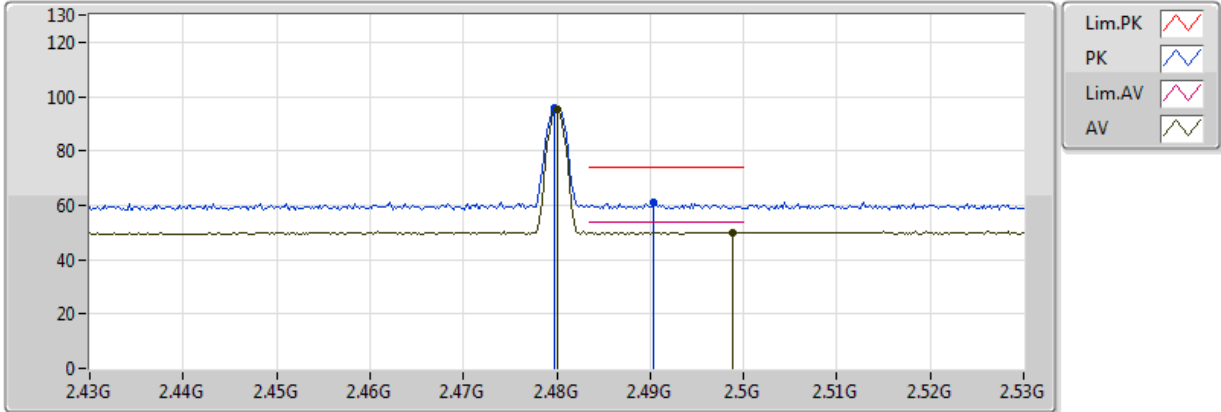

Type	Freq (Hz)	Level (dBuV/m)	Limit (dBuV/m)	Margin (dB)	Factor (dB)	Dist (m)	Condition	Azimuth (°)	Height (m)	Comments
AV	2.48G	95.06	Inf	-Inf	32.60	3	Horizontal	191	2.11	-
AV	2.4988G	50.13	54.00	-3.87	32.67	3	Horizontal	191	2.11	-
PK	2.4798G	95.60	Inf	-Inf	32.60	3	Horizontal	191	2.11	-
PK	2.4904G	61.14	74.00	-12.86	32.64	3	Horizontal	191	2.11	-



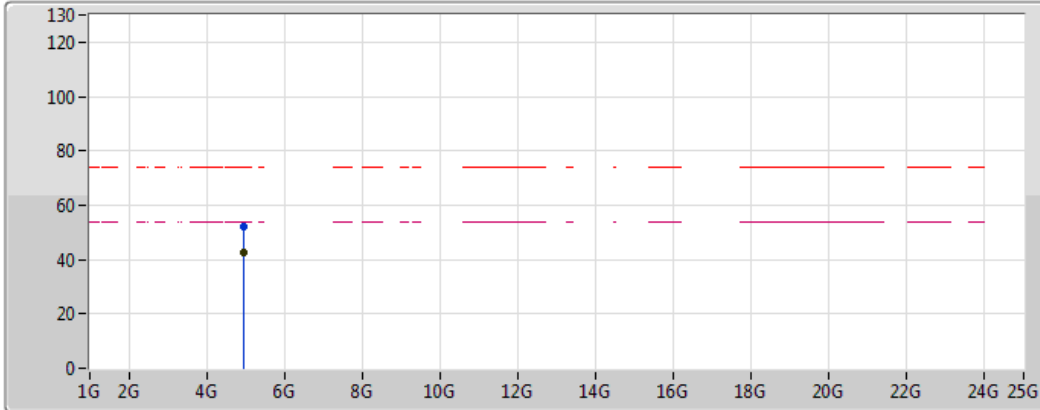

BT-LE(1Mbps)

2480MHz_TX

18/06/2018



Legend:

- Lim.PK 
- PK 
- Lim.AV 
- AV 



Type	Freq (Hz)	Level (dBuV/m)	Limit (dBuV/m)	Margin (dB)	Factor (dB)	Dist (m)	Condition	Azimuth (°)	Height (m)	Comments
AV	4.9598G	42.74	54.00	-11.26	3.33	3	Vertical	172	2.17	-
PK	4.95964G	51.84	74.00	-22.16	3.33	3	Vertical	172	2.17	-

BT-LE(1Mbps)

2480MHz_TX

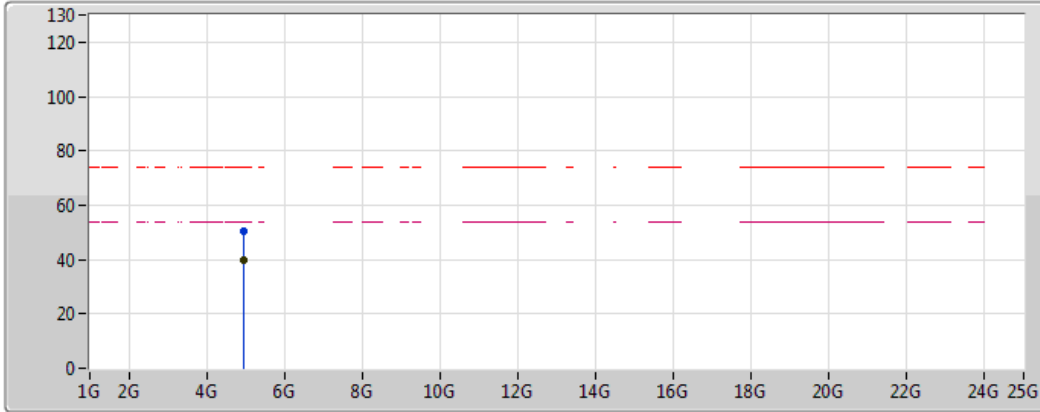
18/06/2018



Lim.PK	
PK	
Lim.AV	
AV	

Type	Freq (Hz)	Level (dBuV/m)	Limit (dBuV/m)	Margin (dB)	Factor (dB)	Dist (m)	Condition	Azimuth (°)	Height (m)	Comments
AV	4.95995G	39.73	54.00	-14.27	3.33	3	Horizontal	186	1.06	-
PK	4.96044G	50.52	74.00	-23.48	3.33	3	Horizontal	186	1.06	-