

FCC Test Report

FCC ID : 2AEUPBHASC052
Equipment : Stick Up Cam Elite
Brand Name : Ring LLC
Model Name : Stick Up Cam Wired
Applicant : Ring LLC
1523 26th St, Santa Monica, CA 90404, USA
Manufacturer 1 : Chicony Electronics Co.,Ltd.
No.69, Sec. 2, Guangfu Rd., Sanchong Dist. New Taipei
City 241 Taiwan
Standard : 47 CFR FCC Part 15.407

The product was received on Jun. 01, 2018, and testing was started from Jun. 18, 2018 and completed on Sep. 24, 2019. We, SPORTON INTERNATIONAL INC. EMC & Wireless Communications Laboratory, would like to declare that the tested sample has been evaluated in accordance with the procedures given in ANSI C63.10-2013 and shown compliance with the applicable technical standards.

The report must not be used by the client to claim product certification, approval, or endorsement by TAF or any agency of government.

The test results in this report apply exclusively to the tested model / sample. Without written approval of SPORTON INTERNATIONAL INC. EMC & Wireless Communications Laboratory, the test report shall not be reproduced except in full.



Approved by: Allen Lin

SPORTON INTERNATIONAL INC. EMC & Wireless Communications Laboratory

No. 52, Huaya 1st Rd., Guishan Dist., Taoyuan City, Taiwan (R.O.C.)



Table of Contents

HISTORY OF THIS TEST REPORT3

SUMMARY OF TEST RESULT4

1 GENERAL DESCRIPTION5

1.1 Information.....5

1.2 Testing Applied Standards7

1.3 Testing Location Information7

1.4 Measurement Uncertainty8

2 TEST CONFIGURATION OF EUT.....9

2.1 Test Condition9

2.2 Test Channel Mode9

2.3 The Worst Case Measurement Configuration.....10

2.4 Accessories and Support Equipment11

2.5 Test Setup Diagram13

3 TRANSMITTER TEST RESULT17

3.1 AC Power-line Conducted Emissions17

3.2 Emission Bandwidth19

3.3 Maximum Conducted Output Power20

3.4 Peak Power Spectral Density.....22

3.5 Unwanted Emissions.....24

4 TEST EQUIPMENT AND CALIBRATION DATA.....28

APPENDIX A. TEST RESULTS OF AC POWER-LINE CONDUCTED EMISSIONS

APPENDIX B. TEST RESULTS OF EMISSION BANDWIDTH

APPENDIX C. TEST RESULTS OF MAXIMUM CONDUCTED OUTPUT POWER

APPENDIX D. TEST RESULTS OF PEAK POWER SPECTRAL DENSITY

APPENDIX E. TEST RESULTS OF UNWANTED EMISSIONS

APPENDIX F. TEST PHOTOS

PHOTOGRAPHS OF EUT V01



History of this test report

Report No.	Version	Description	Issued Date
FR852814-03AN	01	Initial issue of report	Oct. 04, 2019
FR852814-03AN	02	The Manufacturer information was update This report is the latest version replacing for the report issued on Oct. 04, 2019	Oct. 16, 2019



Summary of Test Result

Report Clause	Ref. Std. Clause	Test Items	Result (PASS/FAIL)	Remark
1.1.2	15.203	Antenna Requirement	PASS	-
3.1	15.207	AC Power-line Conducted Emissions	PASS	-
3.2	15.407(a)	Emission Bandwidth	PASS	-
3.3	15.407(a)	Maximum Conducted Output Power	PASS	-
3.4	15.407(a)	Peak Power Spectral Density	PASS	-
3.5	15.407(b)	Unwanted Emissions	PASS	-

Reviewed by: Sam Tsai

Report Producer: Debby Hung

1 General Description

1.1 Information

1.1.1 RF General Information

Frequency Range (MHz)	IEEE Std. 802.11	Ch. Frequency (MHz)	Channel Number
5150-5250	a, n (HT20)	5180-5240	36-48 [4]
5725-5850		5745-5825	149-165 [5]
5150-5250	n (HT40)	5190-5230	38-46 [2]
5725-5850		5755-5795	151-159 [2]

Band	Mode	BWch (MHz)	Nant
5.15-5.25GHz	802.11a	20	1TX
5.725-5.85GHz	802.11a	20	1TX
5.15-5.25GHz	802.11n HT20	20	1TX
5.725-5.85GHz	802.11n HT20	20	1TX
5.15-5.25GHz	802.11n HT40	40	1TX
5.725-5.85GHz	802.11n HT40	40	1TX

Note:

- ♦ 11a, HT20 and HT40 use a combination of OFDM-BPSK, QPSK, 16QAM, 64QAM modulation.
- ♦ BWch is the nominal channel bandwidth.

1.1.2 Antenna Information

Ant.	Port	Brand	Model Name	Antenna Type	Connector
1	1	-	Orion Wifi Antenna	PIFA Antenna	Fixed on board

2.4G		5G		BT	
Frequency (MHz)	Gain (dBi)	Frequency (MHz)	Gain (dBi)	Frequency (MHz)	Gain (dBi)
2412	0.94	5180	2.68	2402	0.94
2417	0.94	5200	2.68	2440	0.69
2422	0.94	5240	2.77	2480	0.10
2427	0.69	5190	2.68	-	-
2432	0.69	5230	2.77	-	-
2437	0.69	5745	3.12	-	-
2442	0.69	5785	2.65	-	-
2447	0.69	5825	1.67	-	-
2452	0.69	5755	3.12	-	-
2457	0.69	5795	2.65	-	-
2462	0.69	-	-	-	-

For 2.4 GHz function:

For IEEE 802.11b/g/n mode (1TX/1RX)

Only Ant. 1 (port 1) can be used as transmitting/receiving antenna.



For 5 GHz function:

For IEEE 802.11a/n mode (1TX/1RX)

Only Ant. 1 (port 1) can be used as transmitting/receiving antenna.

For Bluetooth function:

For Bluetooth mode (1TX/1RX)

Only Ant. 1 (port 1) can be used as transmitting/receiving antenna.

1.1.3 EUT Information

Operational Condition			
EUT Power Type	From AC Adapter		
EUT Function	<input type="checkbox"/> Outdoor	<input checked="" type="checkbox"/> Indoor	
	<input type="checkbox"/> Fixed P2P	<input type="checkbox"/> Client	
Beamforming Function	<input type="checkbox"/> With beamforming	<input checked="" type="checkbox"/> Without beamforming	
Type of EUT			
<input checked="" type="checkbox"/>	Stand-alone		
<input type="checkbox"/>	Combined (EUT where the radio part is fully integrated within another device)		
	Combined Equipment - Brand Name / Model No.: ...		
<input type="checkbox"/>	Plug-in radio (EUT intended for a variety of host systems)		
	Host System - Brand Name / Model No.: ...		
<input type="checkbox"/>	Other:		

1.1.4 Mode Test Duty Cycle

Mode	DC	DCF(dB)	T(s)	VBW(Hz) ≥ 1/T
802.11a	0.897	0.472	1.421m	1k
802.11n HT20	0.932	0.306	1.339m	1k
802.11n HT40	0.876	0.575	666.875u	3k

1.1.5 Table for Existing Change

This product is an extension of original one reported under Sporton project number: FR852814-02AN

Below is the table for the change of the product with respect to the original one.

Modifications	Performance Checking
Two PoE Adapter and Ethernet Cable was added.	AC Conduction data and Radiated Emission data 30M to 1G was evaluated

1.2 Testing Applied Standards

According to the specifications of the manufacturer, the EUT must comply with the requirements of the following standards:

- ◆ 47 CFR FCC Part 15
- ◆ ANSI C63.10-2013
- ◆ KDB 789033 D02 v02r01
- ◆ KDB 414788 D01 v01r01

1.3 Testing Location Information

Testing Location		
<input checked="" type="checkbox"/>	HWA YA	ADD : No. 52, Huaya 1 st Rd., Guishan Dist., Taoyuan City, Taiwan (R.O.C.)
		TEL : 886-3-327-3456 FAX : 886-3-327-0973
Test site Designation No. TW1190 with FCC.		
<input checked="" type="checkbox"/>	LIN KOU	ADD : No. 30-2, Dingfu Vil., Linkou Dist., New Taipei City, Taiwan (R.O.C.)
		TEL : 886-2-2601-1640 FAX : 886-2-2601-1695
Test site Designation No. TW1095 with FCC.		

Test Condition	Test Site No.	Test Engineer	Test Environment	Test Date
RF Conducted	TH01-HY	Andy	23.5°C / 65%	21/Jun/2018
Radiated <9k~30M>	03CH02-HY	Jeff	23.5°C / 60%	15/Aug/2018
Radiated <30M~1G>	03CH02-HY	Terry	22.6°C / 61%	18/Jun/2018
AC Conduction	CO04-HY	Andy	23.5°C / 53.8%	25/Jul/2018
AC Conduction <PoE Adapter>	CO04-HY	David	22~22.5°C / 62.1~62.6%	23/Sep/2019
Radiated <30M~1G > <PoE Adapter>	OS03-LK	Chu	26.1~26.3°C / 65.2~65.4%	24/Sep/2019



1.4 Measurement Uncertainty

ISO/IEC 17025 requires that an estimate of the measurement uncertainties associated with the emissions test results be included in the report. The measurement uncertainties given below are based on a 95% confidence level (based on a coverage factor (k=2))

Test Items	Uncertainty	Remark
Conducted Emission (150kHz ~ 30MHz)	3.6 dB	Confidence levels of 95%
Radiated Emission (9kHz ~ 30MHz)	3.0 dB	Confidence levels of 95%
Radiated Emission (30MHz ~ 1,000MHz)	4.3 dB	Confidence levels of 95%
Radiated Emission (1GHz ~ 18GHz)	3.9 dB	Confidence levels of 95%
Radiated Emission (18GHz ~ 40GHz)	3.5 dB	Confidence levels of 95%
Conducted Emission	1.3 dB	Confidence levels of 95%
Temperature	0.7 °C	Confidence levels of 95%
Humidity	4 %	Confidence levels of 95%



2 Test Configuration of EUT

2.1 Test Condition

Condition Item	Abbreviation/Remark	Remark
RF Conducted	Abbreviation	Remark
TnomVnom	Tnom	20°C
-	Vnom	120V

2.2 Test Channel Mode



Test Software	Dos
---------------	-----

Mode	PowerSetting
802.11a_Nss1,(6Mbps)_1TX	-
5180MHz	15.5
5200MHz	20
5240MHz	20
5745MHz	20
5785MHz	20
5825MHz	20
802.11n HT20_Nss1,(MCS0)_1TX	-
5180MHz	15.5
5200MHz	20
5240MHz	20
5745MHz	20
5785MHz	20
5825MHz	20
802.11n HT40_Nss1,(MCS0)_1TX	-
5190MHz	12
5230MHz	20
5755MHz	20
5795MHz	20

2.3 The Worst Case Measurement Configuration

The Worst Case Mode for Following Conformance Tests	
Tests Item	AC power-line conducted emissions
Condition	AC power-line conducted measurement for line and neutral
Operating Mode	CTX
1	Adapter mode
2	PoE Adapter mode

The Worst Case Mode for Following Conformance Tests	
Tests Item	Emission Bandwidth Maximum Conducted Output Power Peak Power Spectral Density
Test Condition	Conducted measurement at transmit chains

The Worst Case Mode for Following Conformance Tests			
Tests Item	Unwanted Emissions		
Test Condition	Radiated measurement If EUT consist of multiple antenna assembly (multiple antenna are used in EUT regardless of spatial multiplexing MIMO configuration), the radiated test should be performed with highest antenna gain of each antenna type.		
Operating Mode < 1GHz	CTX		
1	Adapter mode		
2	PoE Adapter mode		
Operating Mode > 1GHz	CTX		
Orthogonal Planes of EUT	X Plane	Y Plane	Z Plane
			
Worst Planes of EUT	V		

2.4 Accessories and Support Equipment

Accessories			
Indoor Adapter	Brand Name	DEE VAN ENTERPRISE	Model Name DSA-15CAB-05 050250
	Power Rating	I/P: 100 - 240Vac, 0.5 A, O/P: 5 Vdc, 2.5 A	
Outdoor Adapter	Brand Name	ring	Model Name DSA-15PFL-05 FUS 050250
	Power Rating	I/P: 100-240V ~ 0.5A MAX 50-60Hz; O/P: 5V 2.5A	
	DC Power Cord	2.45 meter, non-shielded cable, w/o ferrite core	
	AC Power Cord	4.53 meter, non-shielded cable, w/o ferrite core	
PoE Adapter 1	Brand Name	Phihong	Model Name POE15M
	Power Rating	I/P: 100 - 240Vac, 0.8 A, O/P: 56 Vdc, 0.275 A	
PoE Adapter 2	Brand Name	ONV	Model Name PSE3010DCG
	Power Rating	I/P: 100 - 240Vac, 0.8 A, O/P: 5 Vdc, 2.5A	
Adapter 2	Brand Name	ZTE	Model Name RJ-AS120150U104-B
	Power Rating	I/P: 100 - 240Vac, 1 A, O/P: 12Vdc, 1.5A	
USB Cable	Power Rating	2.45 meter, non-shielded cable, w/o ferrite core	
6ft Ethernet Cable	Power Rating	1.8 meter, non-shielded cable, w/o ferrite core	

Reminder: Regarding to more detail and other information, please refer to user manual.



Support Equipment - RF Conducted				
No.	Equipment	Brand Name	Model Name	FCC ID
1	Notebook	DELL	E5410	DoC
2	Adapter for NB	DELL	HA65NM130	DoC
3	AC Power Source	G.W	APS-9102	-

Support Equipment - AC Conduction				
No.	Equipment	Brand Name	Model Name	FCC ID
1	PoE Adapter	Phihong	POE15M	-
Z1	802.11ac Dual-Band Wireless-AC1750 Gigabit Router	ASUS	RT-AC66U	MSQ-RTAC66U
Z2	iPhone 8	Apple	MRRM2TA/A	-
Z3	Notebook	DELL	D5500	DoC

Support Equipment - Radiated Emission				
No.	Equipment	Brand Name	Model Name	FCC ID
Z1	AP Router	Netgear	R6300v2	DoC
Z2	iPad	APPLE	A1538	-
Z3	PoE Adapter	Phihong	POE15M	-

2.5 Test Setup Diagram

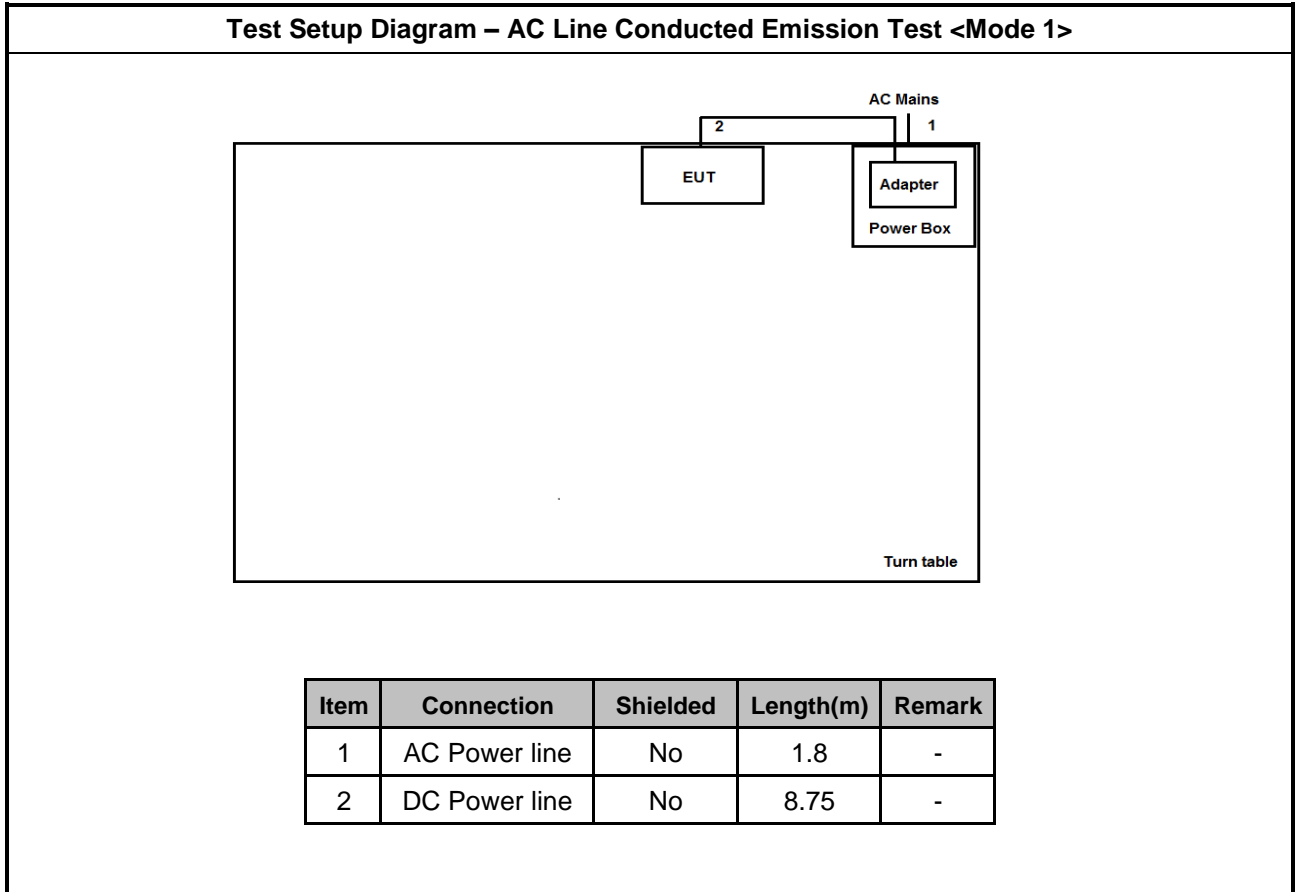

Test Setup Diagram – AC Line Conducted Emission Test <Mode 2>

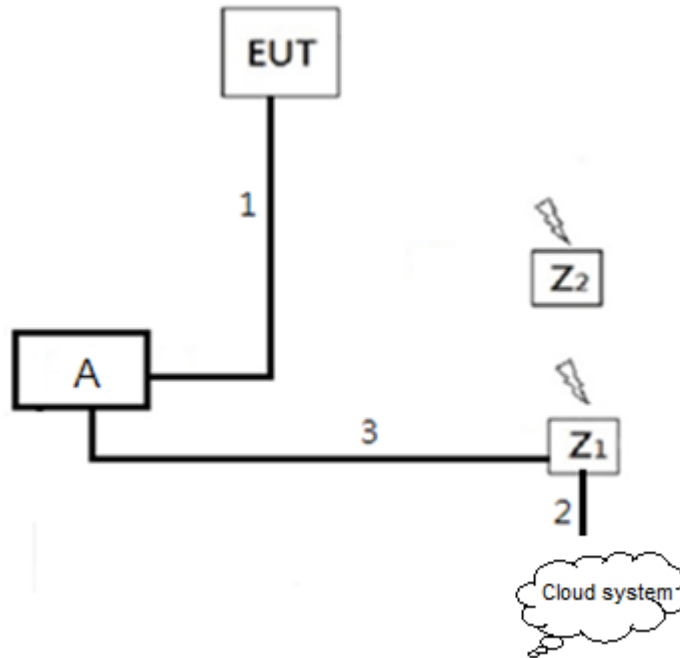

No.	Types of Cables	Shielding on Cable	Length (m)	Remarks
1	RJ45 Cable	Non-Shielded	1	-
2	RJ45 Cable	Non-Shielded	1	-
3	RJ45 Cable	Non-Shielded	1.8+10	-

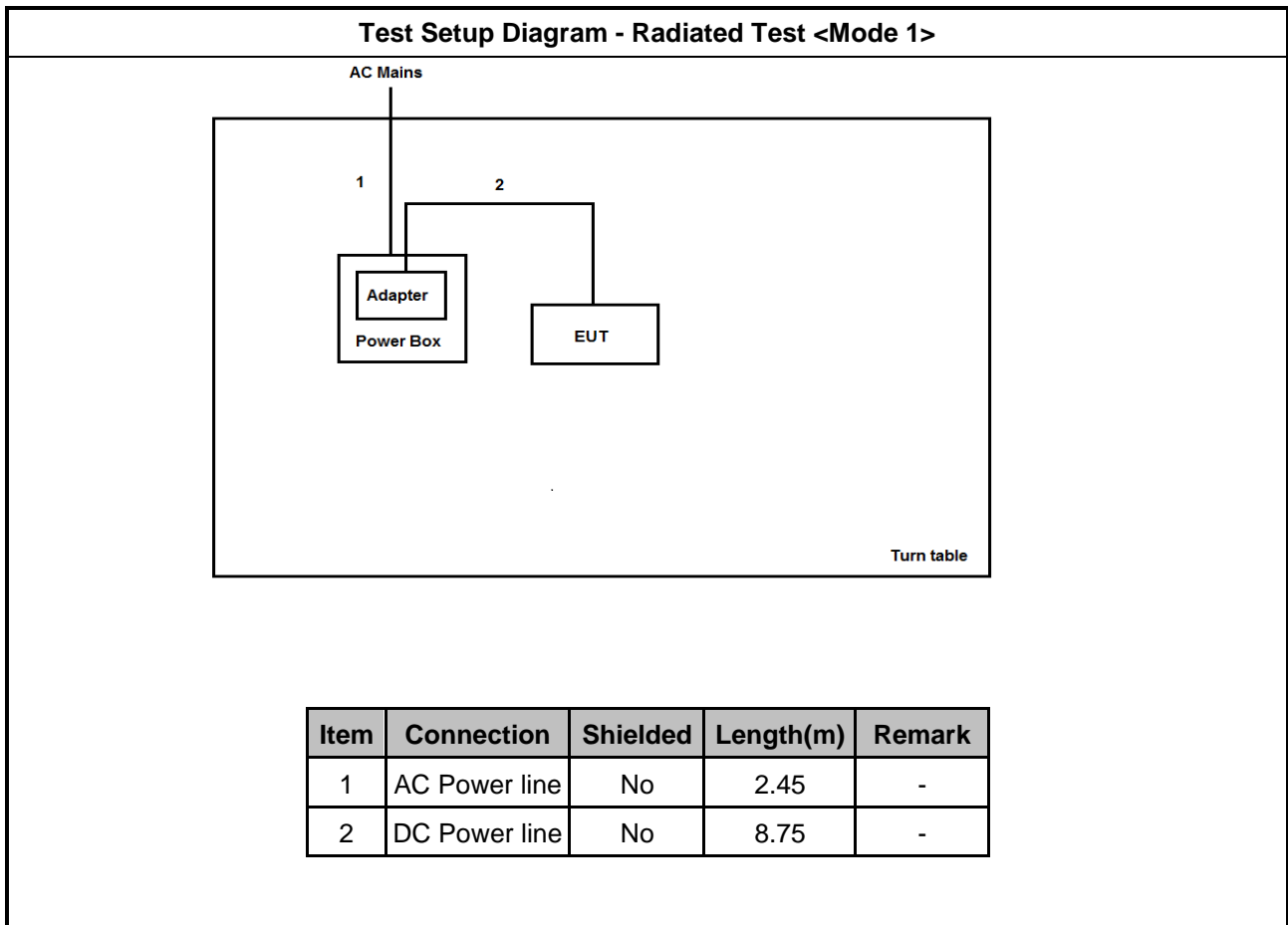

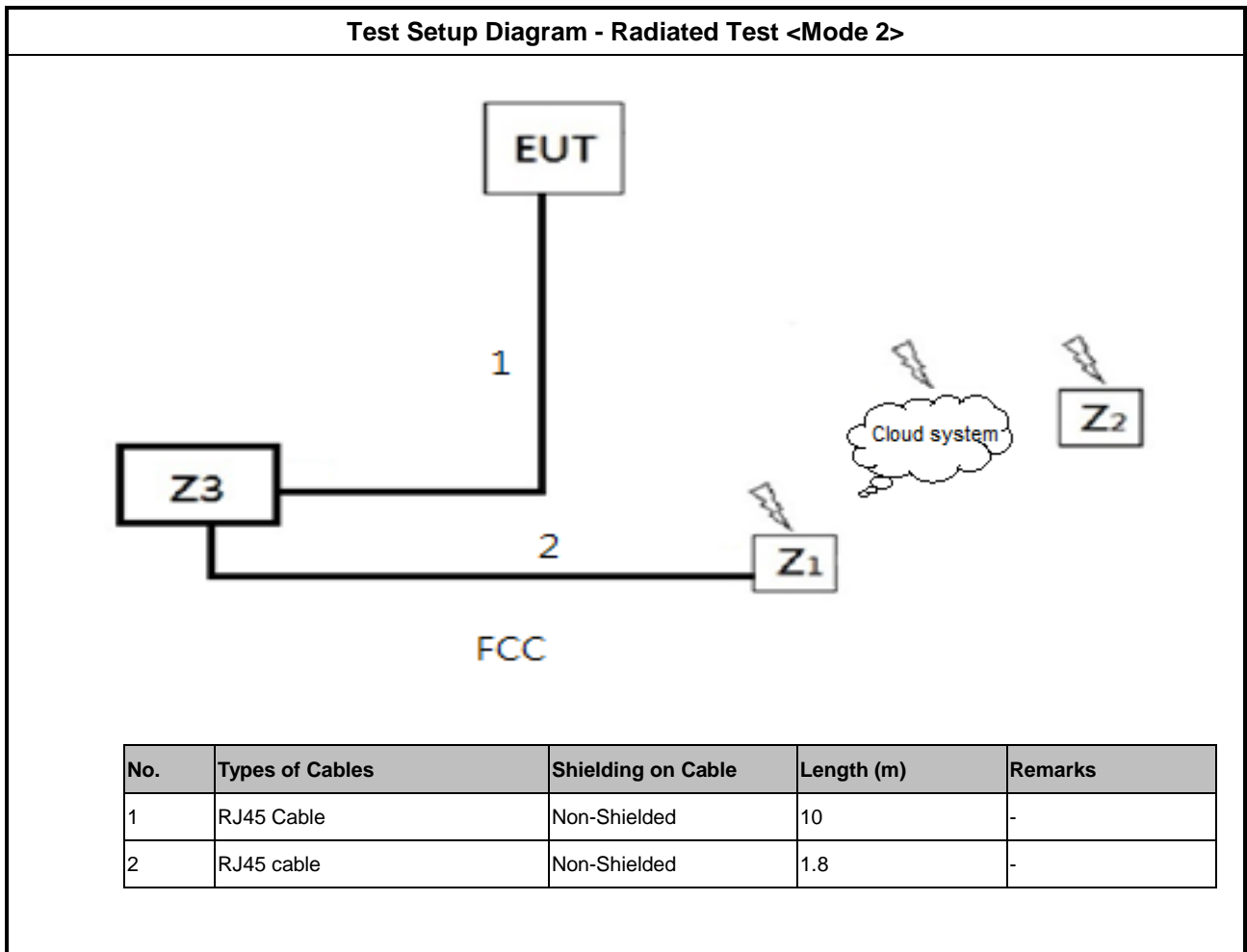



3.1.5 Test Result of AC Power-line Conducted Emissions

Refer as Appendix A

3.2 Emission Bandwidth

3.2.1 Emission Bandwidth Limit

Emission Bandwidth Limit	
UNII Devices	
<input checked="" type="checkbox"/>	For the 5.15-5.25 GHz band, N/A
<input type="checkbox"/>	For the 5.25-5.35 GHz band, the maximum conducted output power shall not exceed the lesser of 250 mW or 11 dBm + 10 log B, where B is the 26 dB emission bandwidth in MHz.
<input type="checkbox"/>	For the 5.47-5.725 GHz band, the maximum conducted output power shall not exceed the lesser of 250 mW or 11 dBm + 10 log B, where B is the 26 dB emission bandwidth in MHz.
<input checked="" type="checkbox"/>	For the 5.725-5.85 GHz band, 6 dB emission bandwidth \geq 500kHz.

3.2.2 Measuring Instruments

Refer a test equipment and calibration data table in this test report.

3.2.3 Test Procedures

Test Method	
<ul style="list-style-type: none"> For the emission bandwidth shall be measured using one of the options below: 	
<input checked="" type="checkbox"/>	Refer as KDB 789033, clause C for EBW and clause D for OBW measurement.
<input type="checkbox"/>	Refer as ANSI C63.10, clause 6.9.3 for occupied bandwidth testing.
<input type="checkbox"/>	Refer as IC RSS-Gen, clause 6.7 for bandwidth testing.

3.2.4 Test Setup

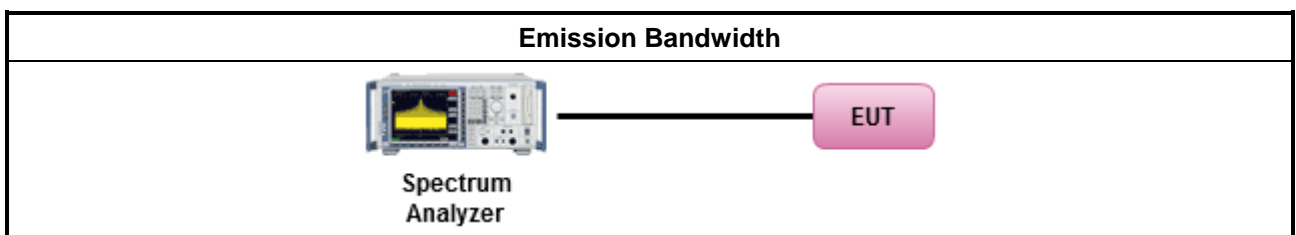

3.2.5 Test Result of Emission Bandwidth

Refer as Appendix B

3.3 Maximum Conducted Output Power

3.3.1 Maximum Conducted Output Power Limit

Maximum Conducted Output Power Limit	
UNII Devices	
<input checked="" type="checkbox"/> For the 5.15-5.25 GHz band:	
	<ul style="list-style-type: none"> ▪ Outdoor AP: the maximum conducted output power (P_{Out}) shall not exceed the lesser of 1 W. If $G_{TX} > 6$ dBi, then $P_{Out} = 30 - (G_{TX} - 6)$. e.i.r.p. at any elevation angle above 30 degrees $\leq 125mW$ [21dBm] ▪ Indoor AP: the maximum conducted output power (P_{Out}) shall not exceed the lesser of 1 W. If $G_{TX} > 6$ dBi, then $P_{Out} = 30 - (G_{TX} - 6)$ ▪ Point-to-point AP: the maximum conducted output power (P_{Out}) shall not exceed the lesser of 1 W. If $G_{TX} > 23$ dBi, then $P_{Out} = 30 - (G_{TX} - 23)$. ▪ Mobile or Portable Client: the maximum conducted output power (P_{Out}) shall not exceed the lesser of 250 mW. If $G_{TX} > 6$ dBi, then $P_{Out} = 24 - (G_{TX} - 6)$.
<input type="checkbox"/> For the 5.25-5.35 GHz band, the maximum conducted output power (P_{Out}) shall not exceed the lesser of 250 mW or 11 dBm + 10 log B, where B is the 26 dB emission bandwidth in MHz. If $G_{TX} > 6$ dBi, then $P_{Out} = 24 - (G_{TX} - 6)$.	
<input type="checkbox"/> For the 5.47-5.725 GHz band, the maximum conducted output power (P_{Out}) shall not exceed the lesser of 250 mW or 11 dBm + 10 log B, where B is the 26 dB emission bandwidth in MHz. If $G_{TX} > 6$ dBi, then $P_{Out} = 24 - (G_{TX} - 6)$.	
<input checked="" type="checkbox"/> For the 5.725-5.85 GHz band:	
	<ul style="list-style-type: none"> ▪ Point-to-multipoint systems (P2M): the maximum conducted output power (P_{Out}) shall not exceed the lesser of 1 W. If $G_{TX} > 6$ dBi, then $P_{Out} = 30 - (G_{TX} - 6)$. ▪ Point-to-point systems (P2P): the maximum conducted output power (P_{Out}) shall not exceed the lesser of 1 W.
P_{Out} = maximum conducted output power in dBm, G_{TX} = the maximum transmitting antenna directional gain in dBi.	

3.3.2 Measuring Instruments

Refer a test equipment and calibration data table in this test report.

3.3.3 Test Procedures

Test Method	
<ul style="list-style-type: none"> Maximum Conducted Output Power 	
	Duty cycle ≥ 98%
<input type="checkbox"/>	Refer as KDB 789033, clause E Method SA-2 (spectral trace averaging).
	Duty cycle < 98%
<input type="checkbox"/>	Refer as KDB 789033, clause E Method SA-2 Alt. (RMS detection with slow sweep speed)
	Wideband RF power meter and average over on/off periods with duty factor
<input checked="" type="checkbox"/>	Refer as KDB 789033, clause E Method PM (using an RF average power meter).
<ul style="list-style-type: none"> For conducted measurement. 	
	<ul style="list-style-type: none"> If the EUT supports multiple transmit chains using options given below: Refer as KDB 662911, In-band power measurements. Using the measure-and-sum approach, measured all transmit ports individually. Sum the power (in linear power units e.g., mW) of all ports for each individual sample and save them.
	<ul style="list-style-type: none"> If multiple transmit chains, EIRP calculation could be following as methods: $P_{total} = P_1 + P_2 + \dots + P_n$ (calculated in linear unit [mW] and transfer to log unit [dBm]) $EIRP_{total} = P_{total} + DG$

3.3.4 Test Setup

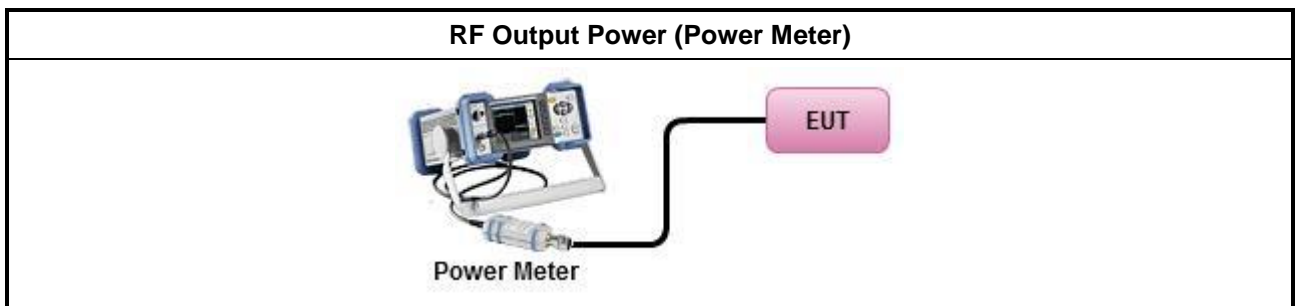

3.3.5 Test Result of Maximum Conducted Output Power

Refer as Appendix C

3.4 Peak Power Spectral Density

3.4.1 Peak Power Spectral Density Limit

Peak Power Spectral Density Limit	
UNII Devices	
<input checked="" type="checkbox"/> For the 5.15-5.25 GHz band:	
<input type="checkbox"/>	<ul style="list-style-type: none"> ▪ Outdoor AP: the peak power spectral density (PPSD) shall not exceed the lesser of 17dBm/MHz. If $G_{TX} > 6$ dBi, then $P_{Out} = 17 - (G_{TX} - 6)$. ▪ Indoor AP: the peak power spectral density (PPSD) shall not exceed the lesser of 17dBm/MHz. If $G_{TX} > 6$ dBi, then $P_{Out} = 17 - (G_{TX} - 6)$. ▪ Point-to-point AP: the peak power spectral density (PPSD) shall not exceed the lesser of 17dBm/MHz. If $G_{TX} > 23$ dBi, then $P_{Out} = 17 - (G_{TX} - 23)$. ▪ Mobile or Portable Client: the peak power spectral density (PPSD) ≤ 11 dBm/MHz. If $G_{TX} > 6$ dBi, then $PPSD = 11 - (G_{TX} - 6)$.
<input type="checkbox"/> For the 5.25-5.35 GHz band, the peak power spectral density (PPSD) ≤ 11 dBm/MHz. If $G_{TX} > 6$ dBi, then $PPSD = 11 - (G_{TX} - 6)$.	
<input type="checkbox"/> For the 5.47-5.725 GHz band, the peak power spectral density (PPSD) ≤ 11 dBm/MHz. If $G_{TX} > 6$ dBi, then $PPSD = 11 - (G_{TX} - 6)$.	
<input checked="" type="checkbox"/> For the 5.725-5.85 GHz band:	
<input type="checkbox"/>	<ul style="list-style-type: none"> ▪ Point-to-multipoint systems (P2M): the peak power spectral density (PPSD) ≤ 30 dBm/500kHz. If $G_{TX} > 6$ dBi, then $PPSD = 30 - (G_{TX} - 6)$. ▪ Point-to-point systems (P2P): the peak power spectral density (PPSD) ≤ 30 dBm/500kHz.
<p>PPSD = peak power spectral density that he same method as used to determine the conducted output power shall be used to determine the power spectral density. And power spectral density in dBm/MHz</p> <p>G_{TX} = the maximum transmitting antenna directional gain in dBi.</p>	

3.4.2 Measuring Instruments

Refer a test equipment and calibration data table in this test report.

3.4.3 Test Procedures

Test Method	
<ul style="list-style-type: none"> ▪ Peak power spectral density procedures that the same method as used to determine the conducted output power shall be used to determine the peak power spectral density and use the peak search function on the spectrum analyzer to find the peak of the spectrum. For the peak power spectral density shall be measured using below options: 	
<input type="checkbox"/>	Refer as KDB 789033, F)5) power spectral density can be measured using resolution bandwidths < 1 MHz provided that the results are integrated over 1 MHz bandwidth
Duty cycle ≥ 98%	
<input type="checkbox"/>	Refer as KDB 789033, clause E Method SA-2 (spectral trace averaging).
Duty cycle < 98%	
<input checked="" type="checkbox"/>	Refer as KDB 789033, clause E Method SA-2 Alt. (RMS detection with slow sweep speed)
<ul style="list-style-type: none"> ▪ For conducted measurement. 	
<ul style="list-style-type: none"> ▪ If the EUT supports multiple transmit chains using options given below: 	
	<ul style="list-style-type: none"> ▪ Measure and sum the spectra across the outputs. Refer as KDB 662911, In-band power spectral density (PSD). Sample all transmit ports simultaneously using a spectrum analyzer for each transmit port. Where the trace bin-by-bin of each transmit port summing can be performed. (i.e., in the first spectral bin of output 1 is summed with that in the first spectral bin of output 2 and that from the first spectral bin of output 3, and so on up to the NTX output to obtain the value for the first frequency bin of the summed spectrum.). Add up the amplitude (power) values for the different transmit chains and use this as the new data trace.
	<ul style="list-style-type: none"> ▪ If multiple transmit chains, EIRP PPSD calculation could be following as methods: $PPSD_{total} = PPSD_1 + PPSD_2 + \dots + PPSD_n$ (calculated in linear unit [mW] and transfer to log unit [dBm]) $EIRP_{total} = PPSD_{total} + DG$

3.4.4 Test Setup

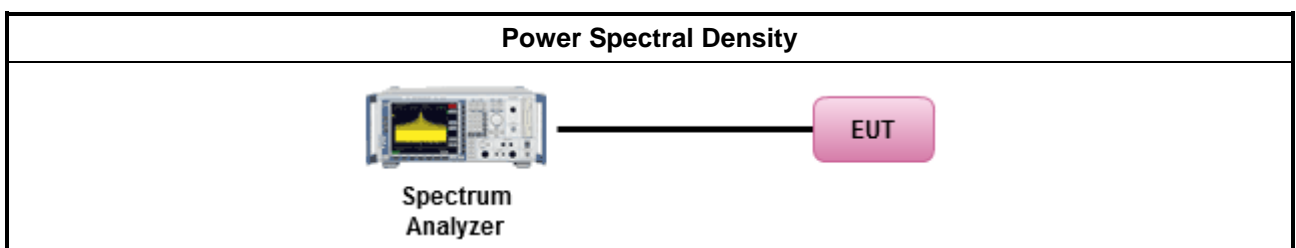

3.4.5 Test Result of Peak Power Spectral Density

Refer as Appendix D

3.5 Unwanted Emissions

3.5.1 Transmitter Radiated Unwanted Emissions Limit

Unwanted emissions below 1 GHz and restricted band emissions above 1GHz limit			
Frequency Range (MHz)	Field Strength (uV/m)	Field Strength (dBuV/m)	Measure Distance (m)
0.009~0.490	2400/F(kHz)	48.5 - 13.8	300
0.490~1.705	24000/F(kHz)	33.8 - 23	30
1.705~30.0	30	29	30
30~88	100	40	3
88~216	150	43.5	3
216~960	200	46	3
Above 960	500	54	3

Note 1: Test distance for frequencies at or above 30 MHz, measurements may be performed at a distance other than the limit distance provided they are not performed in the near field and the emissions to be measured can be detected by the measurement equipment. When performing measurements at a distance other than that specified, the results shall be extrapolated to the specified distance using an extrapolation factor of 20 dB/decade (inverse of linear distance for field-strength measurements, inverse of linear distance-squared for power-density measurements).

Note 2: Test distance for frequencies at below 30 MHz, measurements may be performed at a distance closer than the EUT limit distance; however, an attempt should be made to avoid making measurements in the near field. When performing measurements below 30 MHz at a closer distance than the limit distance, the results shall be extrapolated to the specified distance by either making measurements at a minimum of two or more distances on at least one radial to determine the proper extrapolation factor or by using the square of an inverse linear distance extrapolation factor (40 dB/decade). The test report shall specify the extrapolation method used to determine compliance of the EUT.

Note 3: Using the distance of 1m during the test for above 18 GHz, and the test value to correct for the distance factor at 3m.

Un-restricted band emissions above 1GHz Limit	
Operating Band	Limit
5.15 - 5.25 GHz	e.i.r.p. -27 dBm [68.2 dBuV/m@3m]
5.25 - 5.35 GHz	e.i.r.p. -27 dBm [68.2 dBuV/m@3m]
5.47 - 5.725 GHz	e.i.r.p. -27 dBm [68.2 dBuV/m@3m]
5.725 - 5.85 GHz	5.650-5700 GHz: e.i.r.p. -27 ~ 10 dBm [68.2 ~ 105.2 dBuV/m@3m] 5.700-5720 GHz: e.i.r.p. 10 ~ 15.6 dBm [105.2 ~ 110.8 dBuV/m@3m] 5.720-5725 GHz: e.i.r.p. 15.6 ~ 27 dBm [110.8 ~ 122.2 dBuV/m@3m] 5.850-5.855 GHz: e.i.r.p. 27 ~ 15.6 dBm [122.2 ~ 110.8 dBuV/m@3m] 5.855-5.875 GHz: e.i.r.p. 15.6 ~ 10 dBm [110.8 ~ 105.2 dBuV/m@3m] 5.875-5.925 GHz: e.i.r.p. 10 ~ -27 dBm [105.2 ~ 68.2dBuV/m@3m] Other un-restricted band: e.i.r.p. -27 dBm [68.2 dBuV/m@3m]

Note 1: Measurements may be performed at a distance other than the limit distance provided they are not performed in the near field and the emissions to be measured can be detected by the measurement equipment. When performing measurements at a distance other than that specified, the results shall be extrapolated to the specified distance using an extrapolation factor of 20 dB/decade (inverse of linear distance for field-strength measurements, inverse of linear distance-squared for power-density measurements).

3.5.2 Measuring Instruments

Refer a test equipment and calibration data table in this test report.

3.5.3 Test Procedures

Test Method							
<ul style="list-style-type: none"> ▪ Measurements may be performed at a distance other than the limit distance provided they are not performed in the near field and the emissions to be measured can be detected by the measurement equipment. Measurements shall not be performed at a distance greater than 30 m for frequencies above 30 MHz, unless it can be further demonstrated that measurements at a distance of 30 m or less are impractical. When performing measurements at a distance other than that specified, the results shall be extrapolated to the specified distance using an extrapolation factor of 20 dB/decade (inverse of linear distance for field-strength measurements, inverse of linear distance-squared for power-density measurements). 							
<ul style="list-style-type: none"> ▪ The average emission levels shall be measured in [duty cycle \geq 98 or duty factor]. 							
<ul style="list-style-type: none"> ▪ For the transmitter unwanted emissions shall be measured using following options below: <table border="1" style="width: 100%; border-collapse: collapse;"> <tr> <td style="width: 20px;"></td> <td> <ul style="list-style-type: none"> ▪ Refer as KDB 789033, clause G)2) for unwanted emissions into non-restricted bands. ▪ Refer as KDB 789033, clause G)1) for unwanted emissions into restricted bands. </td> </tr> <tr> <td style="width: 20px;"><input checked="" type="checkbox"/></td> <td>Refer as KDB 789033, G)6) Method VB (ANSI C63.10, clause 4.1.4.2.3), Reduced VBW.</td> </tr> <tr> <td style="width: 20px;"><input checked="" type="checkbox"/></td> <td>Refer as KDB 789033, clause G)5) (ANSI C63.10, clause 4.1.4.2.2), measurement procedure peak limit.</td> </tr> </table> 			<ul style="list-style-type: none"> ▪ Refer as KDB 789033, clause G)2) for unwanted emissions into non-restricted bands. ▪ Refer as KDB 789033, clause G)1) for unwanted emissions into restricted bands. 	<input checked="" type="checkbox"/>	Refer as KDB 789033, G)6) Method VB (ANSI C63.10, clause 4.1.4.2.3), Reduced VBW.	<input checked="" type="checkbox"/>	Refer as KDB 789033, clause G)5) (ANSI C63.10, clause 4.1.4.2.2), measurement procedure peak limit.
	<ul style="list-style-type: none"> ▪ Refer as KDB 789033, clause G)2) for unwanted emissions into non-restricted bands. ▪ Refer as KDB 789033, clause G)1) for unwanted emissions into restricted bands. 						
<input checked="" type="checkbox"/>	Refer as KDB 789033, G)6) Method VB (ANSI C63.10, clause 4.1.4.2.3), Reduced VBW.						
<input checked="" type="checkbox"/>	Refer as KDB 789033, clause G)5) (ANSI C63.10, clause 4.1.4.2.2), measurement procedure peak limit.						
<ul style="list-style-type: none"> ▪ For radiated measurement. <table border="1" style="width: 100%; border-collapse: collapse;"> <tr> <td style="width: 20px;"></td> <td> <ul style="list-style-type: none"> ▪ Refer as ANSI C63.10, clause 6.4 for radiated emissions below 30 MHz and test distance is 3m. ▪ Refer as ANSI C63.10, clause 6.5 for radiated emissions 30 MHz to 1 GHz and test distance is 3m. ▪ Refer as ANSI C63.10, clause 6.6 for radiated emissions above 1GHz. </td> </tr> </table> 			<ul style="list-style-type: none"> ▪ Refer as ANSI C63.10, clause 6.4 for radiated emissions below 30 MHz and test distance is 3m. ▪ Refer as ANSI C63.10, clause 6.5 for radiated emissions 30 MHz to 1 GHz and test distance is 3m. ▪ Refer as ANSI C63.10, clause 6.6 for radiated emissions above 1GHz. 				
	<ul style="list-style-type: none"> ▪ Refer as ANSI C63.10, clause 6.4 for radiated emissions below 30 MHz and test distance is 3m. ▪ Refer as ANSI C63.10, clause 6.5 for radiated emissions 30 MHz to 1 GHz and test distance is 3m. ▪ Refer as ANSI C63.10, clause 6.6 for radiated emissions above 1GHz. 						
<ul style="list-style-type: none"> ▪ The any unwanted emissions level shall not exceed the fundamental emission level. 							
<ul style="list-style-type: none"> ▪ All amplitude of spurious emissions that are attenuated by more than 20 dB below the permissible value has no need to be reported. 							

3.5.4 Test Setup

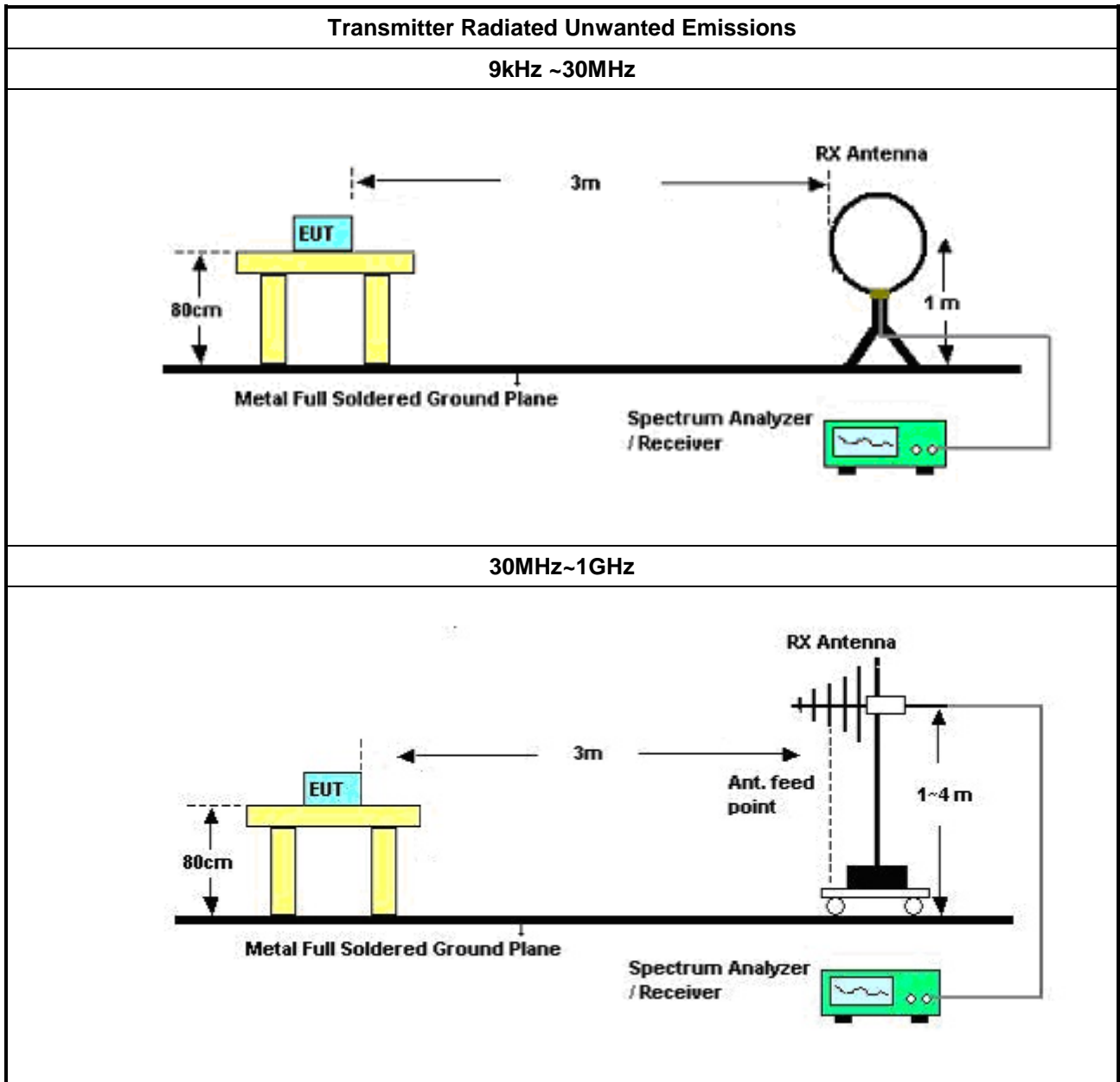

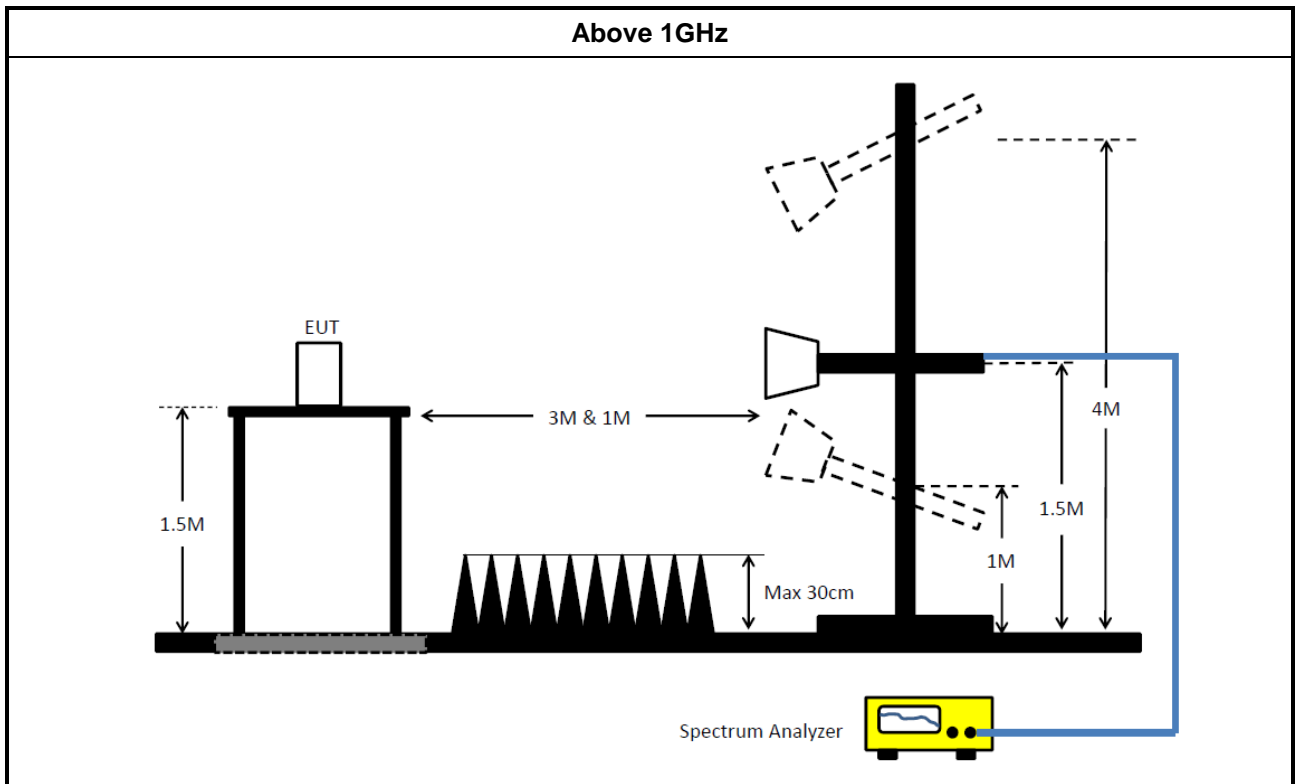

3.5.5 Transmitter Unwanted Emissions

Refer as Appendix E



4 Test Equipment and Calibration Data

Instrument for AC Conduction <Mode 1>

Instrument	Manufacturer	Model No.	Serial No.	Spec.	Calibration Date	Calibration Due Date
EMC Receiver	R&S	ESR	102051	9KHz ~ 3.6GHz	03/May/2018	02/May/2019
LISN	R&S	ENV216	101295	9kHz ~ 30MHz	17/Nov/2017	16/Nov/2018
RF Cable-CON	HUBER+SUHNER	RG213/U	0761183202000 1	9kHz ~ 30MHz	06/Oct/2017	05/Oct/2018
AC POWER	APC	AFC-11005G	F310050055	47Hz~63Hz 5~300V	NCR	NCR
Impuls Begrenzer Puls e Limiter	SCHWARZBEC K	VTSD 9561-F	9561-F041	9 kHz ~ 30 MHz	12/Oct/2017	11/Oct/2018

NCR : Non-Calibration Require

Instrument for AC Conduction <Mode 2>

Instrument	Manufacturer	Model No.	Serial No.	Spec.	Calibration Date	Calibration Due Date
EMI Test Receiver	R&S	ESR3	102051	9KHz ~ 3.6GHz	28/May/2019	27/May/2020
LISN	R&S	ENV216	101295	9kHz ~ 30MHz	08/Nov/2018	07/Nov/2019
RF Cable-CON	MTJ	RG142	CB002-CO	9kHz ~ 200MHz	12/Sep/2019	11/Sep/2020
Impuls Begrenzer Puls e Limiter	SCHWARZBEC K	VTSD 9561-F	9561-F041	9 kHz ~ 30 MHz	11/Oct/2018	10/Oct/2019
Software	Sporton	SENSE-EMI	V5.10.5	-	NCR	NCR

NCR : Non-Calibration Require

**Instrument for Radiated Test <Mode 1>**

Instrument	Manufacturer	Model No.	Serial No.	Spec.	Calibration Date	Calibration Due Date
3m Semi Anechoic Chamber	SIDT FRANKONIA	SAC-3M	03CH02-HY	30MHz ~ 1GHz 3m	20/Oct/2017	19/Oct/2018
3m Semi Anechoic Chamber	SIDT FRANKONIA	SAC-3M	03CH02-HY	1GHz ~ 18GHz 3m	27/Oct/2017	26/Oct/2018
Amplifier	Agilent	8447D	2944A11149	100kHz ~ 1.3GHz	29Jun/2017	28/Jun/2018
Microwave Preamplifier	Agilent	8449B	3008A02373	1GHz ~ 26.5GHz	28/Sep/2017	27/Sep/2018
Spectrum Analyzer	Rohde & Schwarz	FSP40	100593	9kHz - 40GHz	12/Dec/2017	11/Dec/2018
EMI Test Receiver	Rohde & Schwarz	ESCS 30	100354	9kHz ~ 2.75GHz	08/Dec/2017	07/Dec/2018
RF Cable-R03m	Jye Bao	RG142	CB017	9kHz ~ 1GHz	19/Jan/2018	18/Jan/2019
RF Cable-high	SUHNER	SUCOFLEX104	MY34918/4	1GHz ~ 40GHz	19/Jan/2018	18/Jan/2019
Bilog Antenna	SCHAFFNER	CBL 6112B	2723	30MHz ~ 1GHz	09/Sep/2017	08/Sep/2018
Broadband Horn Antenna	SCHWARZBEC K	BBHA 9170	BBHA 9170154	18GHz ~ 40GHz	06/Feb/2018	05/Feb/2019
Double Ridged Guide Horn Antenna	SCHWARZBEC K	BBHA 9120D	BBHA 9120 D 1543	1GHz ~ 18GHz	11/May/ 2018	10/May/2019
Preamplifier	MITEQ	TTA1840-35-HG	1864481	18GHz ~ 40GHz	31/Aug/2017	30/Aug/2018
Loop Antenna	TESEQ	HLA 6120	31244	9k-30MHz	29/Mar/2018	28/Mar/2019

**Instrument for Radiated Test <Mode 2>**

Instrument	Manufacturer	Model No.	Serial No.	Spec.	Calibration Date	Calibration Due Date
Open Area Test Site	SPORTON	OATS-10	OS03-LK	30 MHz ~ 1 GHz 10m, 3m	15/Apr/2019	14/Apr/2020
Amplifier	HP	8447D	2944A09068	0.1MHz ~ 1.3GHz	20/Dec/2018	19/Dec/2019
Spectrum Analyzer	R&S	FSP	100641	9 kHz ~ 30 GHz	23/Jul/2019	22/Jul/2020
Test Receiver	R&S	ESCS 30	100168	9 kHz ~ 2.75 GHz	12/Dec/2018	11/Dec/2019
Bilog Antenna with 5dB Attenuator	TESEQ & WOKEN	CBL6112D & 00800N1D01N-05	25236 & 007	30 MHz ~ 1 GHz	06/Jul/2019	05/Jul/2020
Turn Table	EMCO	2080	9711-2021	0 ~ 360 degree	NCR	NCR
Antenna Mast	EMCO	2075	9711-2115	1 m ~ 4 m	NCR	NCR
RF Cable-R10m	Woken	CFD400E-LW	OS03-2500	30 MHz ~ 1 GHz	15/May/2019	14/May/2020
Software	Audix	E3	Version:4	-	NCR	NCR

NCR : Non-Calibration Require**Instrument for Conducted Test**

Instrument	Manufacturer	Model No.	Serial No.	Spec.	Calibration Date	Calibration Due Date
Spectrum Analyzer	R&S	FSV 40	101515	9kHz~40GHz	08/Dec/2017	07/Dec/2018
Power Sensor	Anritsu	MA2411B	1339407	300MHz ~ 40GHz	06/Nov/2017	05/Nov/2018
Power Meter	Anritsu	ML2495A	1517010	300MHz ~ 40GHz	06/Nov/2017	05/Nov/2018
RF Cable-0.2m	HUBER+SUHNER	SUCOFLEX_104	MY10710/4	30MHz ~ 26.5GHz	25/Aug/2017	24/Aug/2018
RF Cable-0.2m	HUBER+SUHNER	SUCOFLEX_104	MY10709/4	30MHz ~ 26.5GHz	25/Aug/2017	24/Aug/2018
RF Cable-1m	HUBER+SUHNER	SUCOFLEX_104	MY37333/4	30MHz ~ 26.5GHz	26/Jan/2018	25/Jan/2019
Signal Generator	R&S	SMR40	100116	10MHz ~ 40GHz	27/Jul/2017	26/Jul/2018



AC Power-line Conducted Emissions Result																																																																																																																			
Operating Mode	1	Power Phase	Neutral																																																																																																																
Operating Function	Adapter mode - TX																																																																																																																		
<div style="text-align: right;">Date: 2018-07-25</div> <p>The graph displays the AC power-line conducted emissions. The y-axis represents Level in dBuV, ranging from 0 to 80. The x-axis represents Frequency in MHz, ranging from 0.150.2 to 30. Two red lines indicate the limits: NCC/IC/FCC-B (upper) and NCC/IC/FCC-B-AV (lower). A blue line shows the measured emission levels. Several peaks are marked with vertical lines and numbers 1 through 12. The peak at 0.48 MHz is the highest, exceeding the NCC/IC/FCC-B-AV limit.</p> <table border="1"> <thead> <tr> <th>Freq</th> <th>Level</th> <th>Over Limit</th> <th>Limit Line</th> <th>Read Level</th> <th>LISN Factor</th> <th>Cable Loss</th> <th>Remark</th> </tr> <tr> <th>MHz</th> <th>dBuV</th> <th>dB</th> <th>dBuV</th> <th>dBuV</th> <th>dB</th> <th>dB</th> <th></th> </tr> </thead> <tbody> <tr><td>1</td><td>0.43</td><td>28.34</td><td>-18.90</td><td>47.24</td><td>18.64</td><td>9.61</td><td>0.09 Average</td></tr> <tr><td>2</td><td>0.43</td><td>38.24</td><td>-19.00</td><td>57.24</td><td>28.54</td><td>9.61</td><td>0.09 QP</td></tr> <tr><td>3</td><td>0.48</td><td>35.19</td><td>-11.08</td><td>46.27</td><td>25.50</td><td>9.61</td><td>0.08 Average</td></tr> <tr><td>4</td><td>0.48</td><td>43.97</td><td>-12.30</td><td>56.27</td><td>34.28</td><td>9.61</td><td>0.08 QP</td></tr> <tr><td>5</td><td>0.91</td><td>26.55</td><td>-19.45</td><td>46.00</td><td>16.92</td><td>9.62</td><td>0.01 Average</td></tr> <tr><td>6</td><td>0.91</td><td>36.38</td><td>-19.62</td><td>56.00</td><td>26.75</td><td>9.62</td><td>0.01 QP</td></tr> <tr><td>7</td><td>1.95</td><td>26.35</td><td>-19.65</td><td>46.00</td><td>16.72</td><td>9.63</td><td>0.00 Average</td></tr> <tr><td>8</td><td>1.95</td><td>37.02</td><td>-18.98</td><td>56.00</td><td>27.39</td><td>9.63</td><td>0.00 QP</td></tr> <tr><td>9</td><td>2.99</td><td>24.52</td><td>-21.48</td><td>46.00</td><td>14.83</td><td>9.64</td><td>0.05 Average</td></tr> <tr><td>10</td><td>2.99</td><td>35.00</td><td>-21.00</td><td>56.00</td><td>25.31</td><td>9.64</td><td>0.05 QP</td></tr> <tr><td>11</td><td>4.27</td><td>23.88</td><td>-22.12</td><td>46.00</td><td>14.15</td><td>9.64</td><td>0.09 Average</td></tr> <tr><td>12</td><td>4.27</td><td>35.05</td><td>-20.95</td><td>56.00</td><td>25.32</td><td>9.64</td><td>0.09 QP</td></tr> </tbody> </table>				Freq	Level	Over Limit	Limit Line	Read Level	LISN Factor	Cable Loss	Remark	MHz	dBuV	dB	dBuV	dBuV	dB	dB		1	0.43	28.34	-18.90	47.24	18.64	9.61	0.09 Average	2	0.43	38.24	-19.00	57.24	28.54	9.61	0.09 QP	3	0.48	35.19	-11.08	46.27	25.50	9.61	0.08 Average	4	0.48	43.97	-12.30	56.27	34.28	9.61	0.08 QP	5	0.91	26.55	-19.45	46.00	16.92	9.62	0.01 Average	6	0.91	36.38	-19.62	56.00	26.75	9.62	0.01 QP	7	1.95	26.35	-19.65	46.00	16.72	9.63	0.00 Average	8	1.95	37.02	-18.98	56.00	27.39	9.63	0.00 QP	9	2.99	24.52	-21.48	46.00	14.83	9.64	0.05 Average	10	2.99	35.00	-21.00	56.00	25.31	9.64	0.05 QP	11	4.27	23.88	-22.12	46.00	14.15	9.64	0.09 Average	12	4.27	35.05	-20.95	56.00	25.32	9.64	0.09 QP
Freq	Level	Over Limit	Limit Line	Read Level	LISN Factor	Cable Loss	Remark																																																																																																												
MHz	dBuV	dB	dBuV	dBuV	dB	dB																																																																																																													
1	0.43	28.34	-18.90	47.24	18.64	9.61	0.09 Average																																																																																																												
2	0.43	38.24	-19.00	57.24	28.54	9.61	0.09 QP																																																																																																												
3	0.48	35.19	-11.08	46.27	25.50	9.61	0.08 Average																																																																																																												
4	0.48	43.97	-12.30	56.27	34.28	9.61	0.08 QP																																																																																																												
5	0.91	26.55	-19.45	46.00	16.92	9.62	0.01 Average																																																																																																												
6	0.91	36.38	-19.62	56.00	26.75	9.62	0.01 QP																																																																																																												
7	1.95	26.35	-19.65	46.00	16.72	9.63	0.00 Average																																																																																																												
8	1.95	37.02	-18.98	56.00	27.39	9.63	0.00 QP																																																																																																												
9	2.99	24.52	-21.48	46.00	14.83	9.64	0.05 Average																																																																																																												
10	2.99	35.00	-21.00	56.00	25.31	9.64	0.05 QP																																																																																																												
11	4.27	23.88	-22.12	46.00	14.15	9.64	0.09 Average																																																																																																												
12	4.27	35.05	-20.95	56.00	25.32	9.64	0.09 QP																																																																																																												
<p>Note 1: ">20dB" means emission levels that exceed the level of 20 dB below the applicable limit. Note 2: "N/F" means Nothing Found emissions (No emissions were detected.)</p>																																																																																																																			



AC Power-line Conducted Emissions Result																																																																																																																																	
Operating Mode	1	Power Phase	Line																																																																																																																														
Operating Function	Adapter mode - TX																																																																																																																																
<div style="display: flex; justify-content: space-between;"> <div> <p>Level (dBuV)</p> <p style="text-align: right;">Date: 2018-07-25</p> </div> </div>																																																																																																																																	
<table border="1" style="width: 100%; border-collapse: collapse;"> <thead> <tr> <th></th> <th>Freq</th> <th>Level</th> <th>Over Limit</th> <th>Limit Line</th> <th>Read Level</th> <th>LISN Factor</th> <th>Cable Loss</th> <th>Remark</th> </tr> <tr> <th></th> <th>MHz</th> <th>dBuV</th> <th>dB</th> <th>dBuV</th> <th>dBuV</th> <th>dB</th> <th>dB</th> <th></th> </tr> </thead> <tbody> <tr><td>1</td><td>0.33</td><td>21.11</td><td>-28.46</td><td>49.57</td><td>11.43</td><td>9.61</td><td>0.07</td><td>Average</td></tr> <tr><td>2</td><td>0.33</td><td>32.88</td><td>-26.69</td><td>59.57</td><td>23.20</td><td>9.61</td><td>0.07</td><td>QP</td></tr> <tr><td>3</td><td>0.48</td><td>27.21</td><td>-19.06</td><td>46.27</td><td>17.52</td><td>9.61</td><td>0.08</td><td>Average</td></tr> <tr><td>4 MAX</td><td>0.48</td><td>37.29</td><td>-18.98</td><td>56.27</td><td>27.60</td><td>9.61</td><td>0.08</td><td>QP</td></tr> <tr><td>5</td><td>1.24</td><td>19.19</td><td>-26.81</td><td>46.00</td><td>9.58</td><td>9.61</td><td>0.00</td><td>Average</td></tr> <tr><td>6</td><td>1.24</td><td>28.92</td><td>-27.08</td><td>56.00</td><td>19.31</td><td>9.61</td><td>0.00</td><td>QP</td></tr> <tr><td>7</td><td>2.13</td><td>16.97</td><td>-29.03</td><td>46.00</td><td>7.34</td><td>9.62</td><td>0.01</td><td>Average</td></tr> <tr><td>8</td><td>2.13</td><td>27.54</td><td>-28.46</td><td>56.00</td><td>17.91</td><td>9.62</td><td>0.01</td><td>QP</td></tr> <tr><td>9</td><td>4.95</td><td>17.74</td><td>-28.26</td><td>46.00</td><td>7.99</td><td>9.64</td><td>0.11</td><td>Average</td></tr> <tr><td>10</td><td>4.95</td><td>25.71</td><td>-30.29</td><td>56.00</td><td>15.96</td><td>9.64</td><td>0.11</td><td>QP</td></tr> <tr><td>11</td><td>10.68</td><td>17.70</td><td>-32.30</td><td>50.00</td><td>7.87</td><td>9.66</td><td>0.17</td><td>Average</td></tr> <tr><td>12</td><td>10.68</td><td>26.67</td><td>-33.33</td><td>60.00</td><td>16.84</td><td>9.66</td><td>0.17</td><td>QP</td></tr> </tbody> </table>					Freq	Level	Over Limit	Limit Line	Read Level	LISN Factor	Cable Loss	Remark		MHz	dBuV	dB	dBuV	dBuV	dB	dB		1	0.33	21.11	-28.46	49.57	11.43	9.61	0.07	Average	2	0.33	32.88	-26.69	59.57	23.20	9.61	0.07	QP	3	0.48	27.21	-19.06	46.27	17.52	9.61	0.08	Average	4 MAX	0.48	37.29	-18.98	56.27	27.60	9.61	0.08	QP	5	1.24	19.19	-26.81	46.00	9.58	9.61	0.00	Average	6	1.24	28.92	-27.08	56.00	19.31	9.61	0.00	QP	7	2.13	16.97	-29.03	46.00	7.34	9.62	0.01	Average	8	2.13	27.54	-28.46	56.00	17.91	9.62	0.01	QP	9	4.95	17.74	-28.26	46.00	7.99	9.64	0.11	Average	10	4.95	25.71	-30.29	56.00	15.96	9.64	0.11	QP	11	10.68	17.70	-32.30	50.00	7.87	9.66	0.17	Average	12	10.68	26.67	-33.33	60.00	16.84	9.66	0.17	QP
	Freq	Level	Over Limit	Limit Line	Read Level	LISN Factor	Cable Loss	Remark																																																																																																																									
	MHz	dBuV	dB	dBuV	dBuV	dB	dB																																																																																																																										
1	0.33	21.11	-28.46	49.57	11.43	9.61	0.07	Average																																																																																																																									
2	0.33	32.88	-26.69	59.57	23.20	9.61	0.07	QP																																																																																																																									
3	0.48	27.21	-19.06	46.27	17.52	9.61	0.08	Average																																																																																																																									
4 MAX	0.48	37.29	-18.98	56.27	27.60	9.61	0.08	QP																																																																																																																									
5	1.24	19.19	-26.81	46.00	9.58	9.61	0.00	Average																																																																																																																									
6	1.24	28.92	-27.08	56.00	19.31	9.61	0.00	QP																																																																																																																									
7	2.13	16.97	-29.03	46.00	7.34	9.62	0.01	Average																																																																																																																									
8	2.13	27.54	-28.46	56.00	17.91	9.62	0.01	QP																																																																																																																									
9	4.95	17.74	-28.26	46.00	7.99	9.64	0.11	Average																																																																																																																									
10	4.95	25.71	-30.29	56.00	15.96	9.64	0.11	QP																																																																																																																									
11	10.68	17.70	-32.30	50.00	7.87	9.66	0.17	Average																																																																																																																									
12	10.68	26.67	-33.33	60.00	16.84	9.66	0.17	QP																																																																																																																									
<p>Note 1: ">20dB" means emission levels that exceed the level of 20 dB below the applicable limit. Note 2: "N/F" means Nothing Found emissions (No emissions were detected.)</p>																																																																																																																																	



AC Power-line Conducted Emissions Result

Operating Mode	2	Power Phase	Neutral
Operating Function	PoE Adapter mode - TX		

23/09/2019



Type	Freq (Hz)	Level (dBuV)	Limit (dBuV)	Margin (dB)	Factor (dB)	Condition	Comment	Raw (dBuV)	LISN (dB)	CL (dB)	AT (dB)
QP	150.05k	51.94	66.00	-14.06	19.48	Neutral	-	32.46	9.60	0.01	9.87
AV	150.05k	35.67	56.00	-20.33	19.48	Neutral	-	16.19	9.60	0.01	9.87
QP	462.337k	45.33	56.65	-11.32	19.48	Neutral	-	25.85	9.59	0.01	9.88
AV	462.337k	40.18	46.65	-6.47	19.48	Neutral	"Worst"	20.70	9.59	0.01	9.88
QP	2.964M	41.25	56.00	-14.75	19.54	Neutral	-	21.71	9.61	0.04	9.89
AV	2.964M	34.31	46.00	-11.69	19.54	Neutral	-	14.77	9.61	0.04	9.89
QP	11.361M	41.62	60.00	-18.38	19.64	Neutral	-	21.98	9.67	0.08	9.89
AV	11.361M	36.48	50.00	-13.52	19.64	Neutral	-	16.84	9.67	0.08	9.89
QP	16.166M	44.54	60.00	-15.46	19.68	Neutral	-	24.86	9.68	0.10	9.90
AV	16.166M	38.15	50.00	-11.85	19.68	Neutral	-	18.47	9.68	0.10	9.90
QP	19.003M	42.56	60.00	-17.44	19.69	Neutral	-	22.87	9.68	0.11	9.90
AV	19.003M	37.01	50.00	-12.99	19.69	Neutral	-	17.32	9.68	0.11	9.90



AC Power-line Conducted Emissions Result

Operating Mode	2	Power Phase	Line
Operating Function	PoE Adapter mode - TX		

23/09/2019

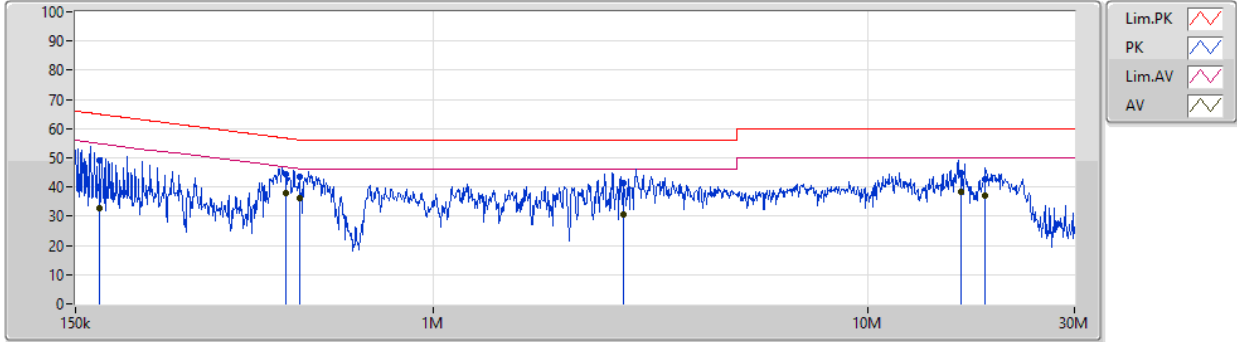

Type	Freq (Hz)	Level (dBuV)	Limit (dBuV)	Margin (dB)	Factor (dB)	Condition	Comment	Raw (dBuV)	LISN (dB)	CL (dB)	AT (dB)
QP	170.81k	49.01	64.91	-15.90	19.48	Line	-	29.53	9.60	0.01	9.87
AV	170.81k	32.94	54.91	-21.97	19.48	Line	-	13.46	9.60	0.01	9.87
QP	458.311k	44.35	56.73	-12.38	19.48	Line	-	24.87	9.59	0.01	9.88
AV	458.311k	37.73	46.73	-9.00	19.48	Line	"Worst"	18.25	9.59	0.01	9.88
QP	493.042k	43.55	56.11	-12.56	19.48	Line	-	24.07	9.59	0.01	9.88
AV	493.042k	36.13	46.11	-9.98	19.48	Line	-	16.65	9.59	0.01	9.88
QP	2.748M	41.26	56.00	-14.74	19.55	Line	-	21.71	9.62	0.04	9.89
AV	2.748M	30.65	46.00	-15.35	19.55	Line	-	11.10	9.62	0.04	9.89
QP	16.421M	44.64	60.00	-15.36	19.64	Line	-	25.00	9.64	0.10	9.90
AV	16.421M	38.21	50.00	-11.79	19.64	Line	-	18.57	9.64	0.10	9.90
QP	18.629M	42.50	60.00	-17.50	19.64	Line	-	22.86	9.63	0.11	9.90
AV	18.629M	37.00	50.00	-13.00	19.64	Line	-	17.36	9.63	0.11	9.90



Summary

Mode	Max-N dB (Hz)	Max-OBW (Hz)	ITU-Code	Min-N dB (Hz)	Min-OBW (Hz)
5.15-5.25GHz	-	-	-	-	-
802.11a_Nss1,(6Mbps)_1TX	39.525M	18.316M	18M3D1D	29.975M	16.542M
802.11n HT20_Nss1,(MCS0)_1TX	41.9M	18.541M	18M5D1D	32.625M	17.616M
802.11n HT40_Nss1,(MCS0)_1TX	81.4M	36.532M	36M5D1D	44.5M	35.982M
5.725-5.85GHz	-	-	-	-	-
802.11a_Nss1,(6Mbps)_1TX	15.05M	20.415M	20M4D1D	15M	18.416M
802.11n HT20_Nss1,(MCS0)_1TX	15.1M	20.79M	20M8D1D	14.15M	18.941M
802.11n HT40_Nss1,(MCS0)_1TX	35.05M	36.682M	36M7D1D	33.75M	36.432M

Max-N dB = Maximum 6dB down bandwidth for 5.725-5.85GHz band / Maximum 26dB down bandwidth for other band;

Max-OBW = Maximum 99% occupied bandwidth;

Min-N dB = Minimum 6dB down bandwidth for 5.725-5.85GHz band / Maximum 26dB down bandwidth for other band;

Min-OBW = Minimum 99% occupied bandwidth;



Result

Mode	Result	Limit (Hz)	Port 1-N dB (Hz)	Port 1-OBW (Hz)
802.11a_Nss1,(6Mbps)_1TX	-	-	-	-
5180MHz_TnomVnom	Pass	Inf	29.975M	16.542M
5200MHz_TnomVnom	Pass	Inf	38.3M	17.866M
5240MHz_TnomVnom	Pass	Inf	39.525M	18.316M
5745MHz_TnomVnom	Pass	500k	15.025M	20.415M
5785MHz_TnomVnom	Pass	500k	15M	20.115M
5825MHz_TnomVnom	Pass	500k	15.05M	18.416M
802.11n HT20_Nss1,(MCS0)_1TX	-	-	-	-
5180MHz_TnomVnom	Pass	Inf	32.625M	17.616M
5200MHz_TnomVnom	Pass	Inf	41.9M	18.316M
5240MHz_TnomVnom	Pass	Inf	39.35M	18.541M
5745MHz_TnomVnom	Pass	500k	14.15M	20.44M
5785MHz_TnomVnom	Pass	500k	15.05M	20.79M
5825MHz_TnomVnom	Pass	500k	15.1M	18.941M
802.11n HT40_Nss1,(MCS0)_1TX	-	-	-	-
5190MHz_TnomVnom	Pass	Inf	44.5M	35.982M
5230MHz_TnomVnom	Pass	Inf	81.4M	36.532M
5755MHz_TnomVnom	Pass	500k	33.75M	36.682M
5795MHz_TnomVnom	Pass	500k	35.05M	36.432M

Port X-N dB = Port X 6dB down bandwidth for 5.725-5.85GHz band / 26dB down bandwidth for other band

Port X-OBW = Port X 99% occupied bandwidth;

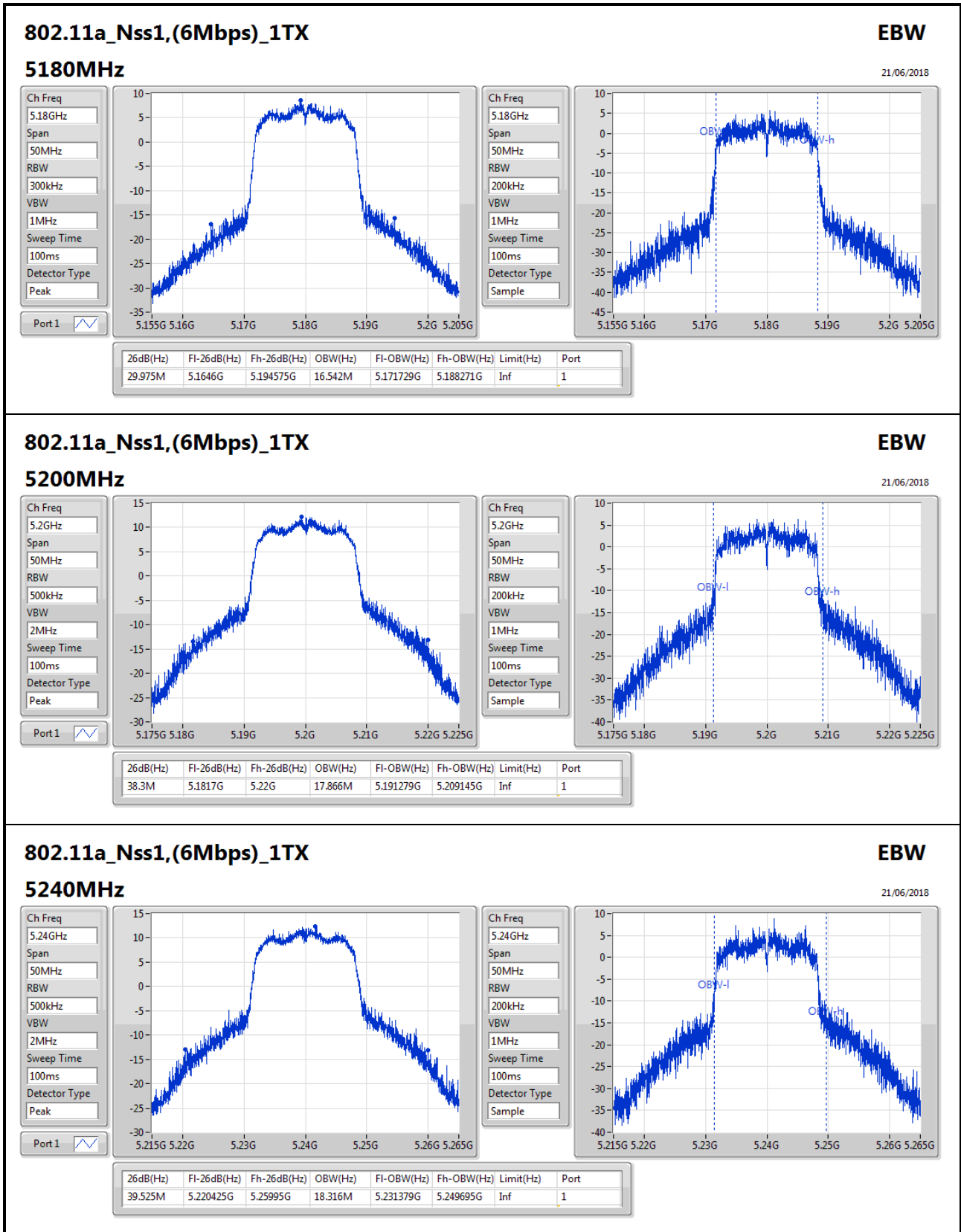

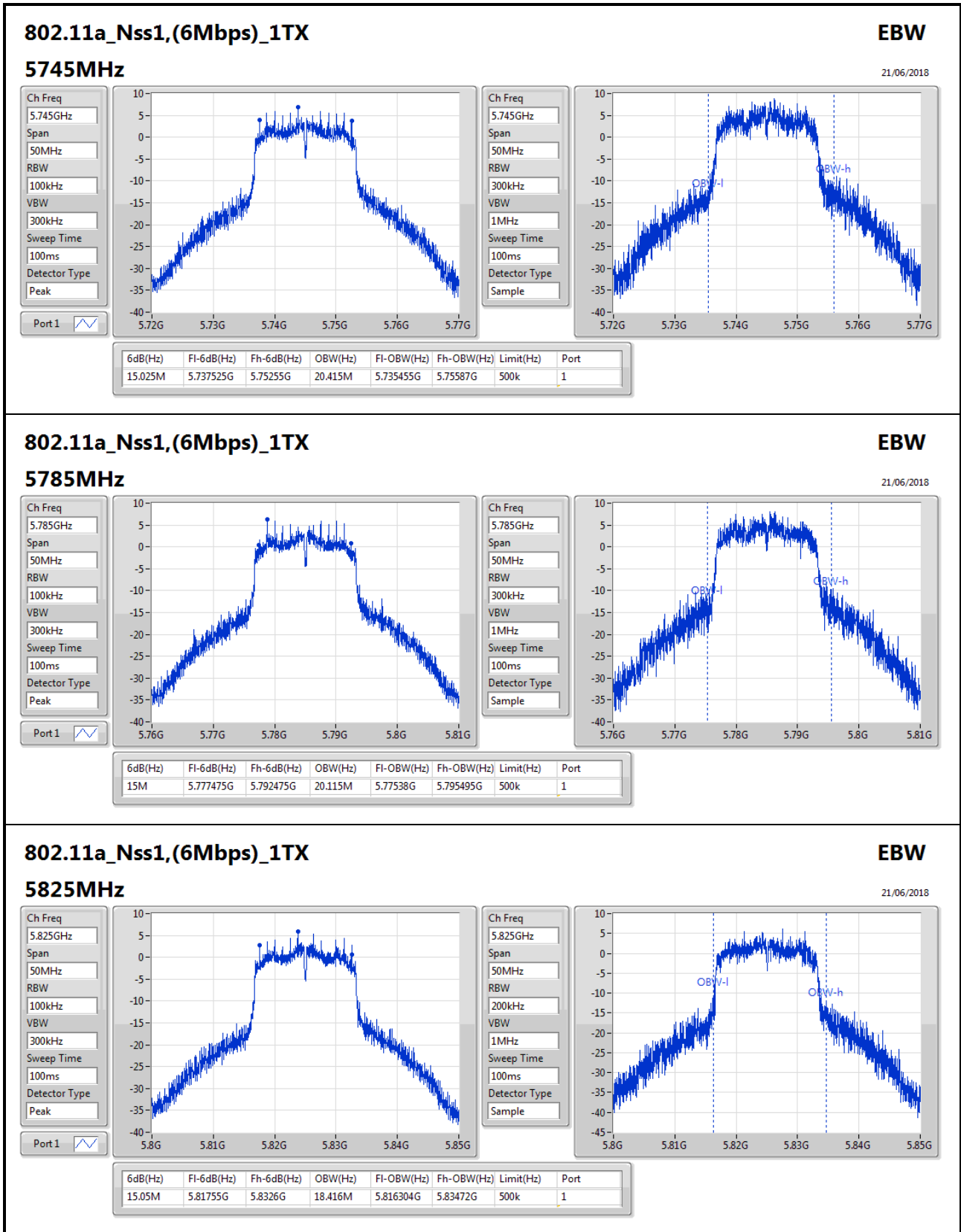

802.11a_Nss1,(6Mbps)_1TX
EBW

21/06/2018

5825MHz

Ch Freq: 5.825GHz
Span: 50MHz
RBW: 100kHz
VBW: 300kHz
Sweep Time: 100ms
Detector Type: Peak

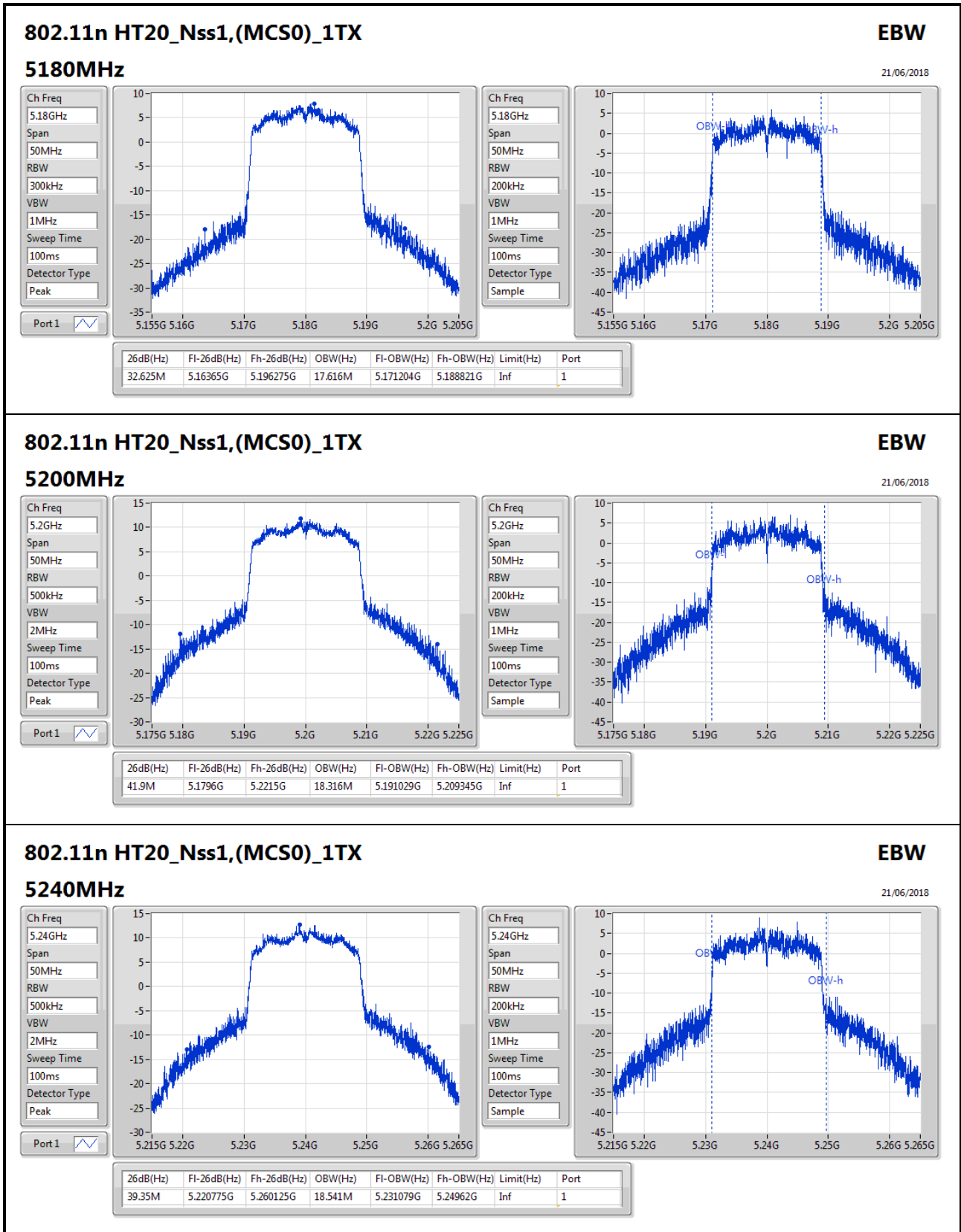
Ch Freq: 5.825GHz
Span: 50MHz
RBW: 200kHz
VBW: 1MHz
Sweep Time: 100ms
Detector Type: Sample



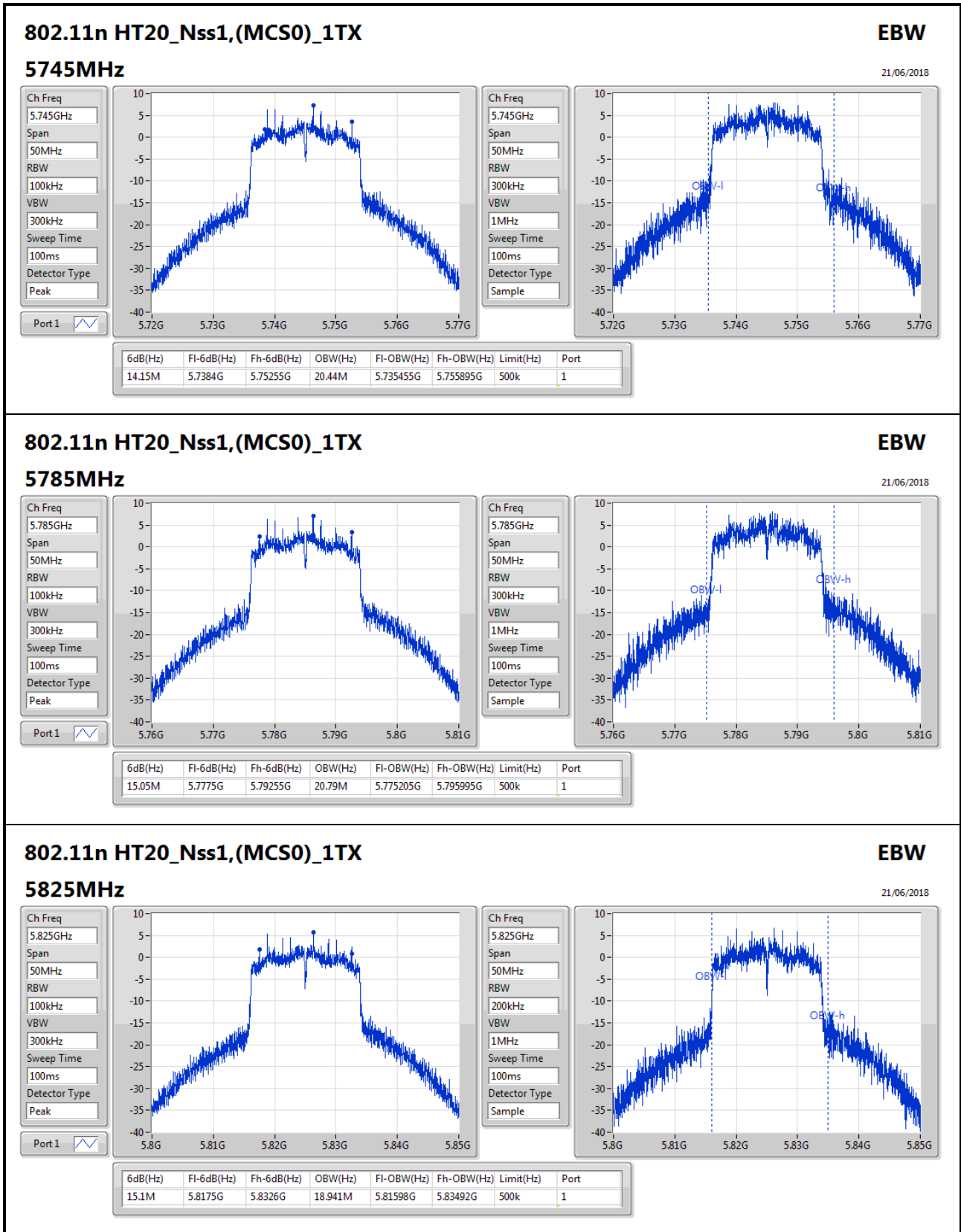

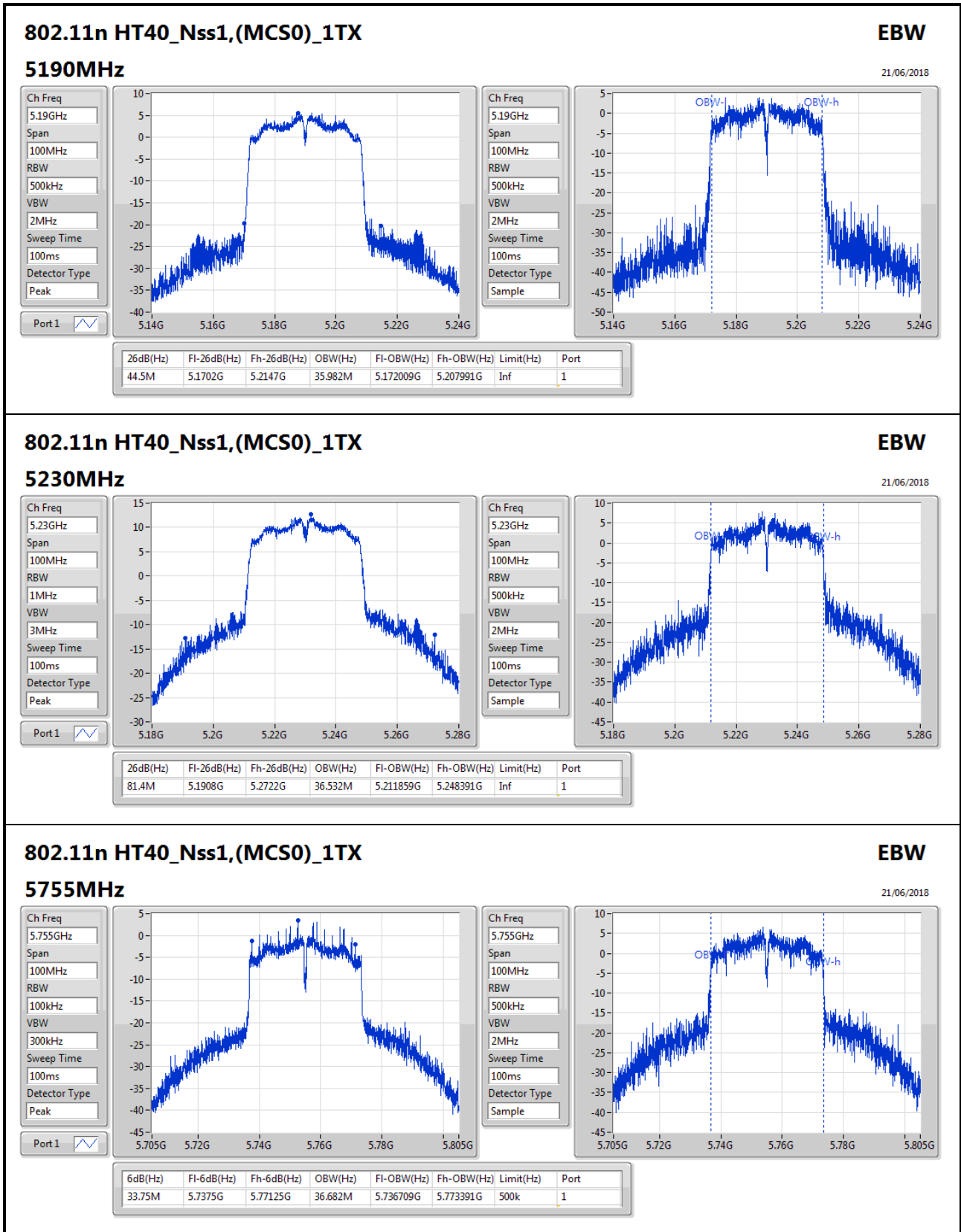

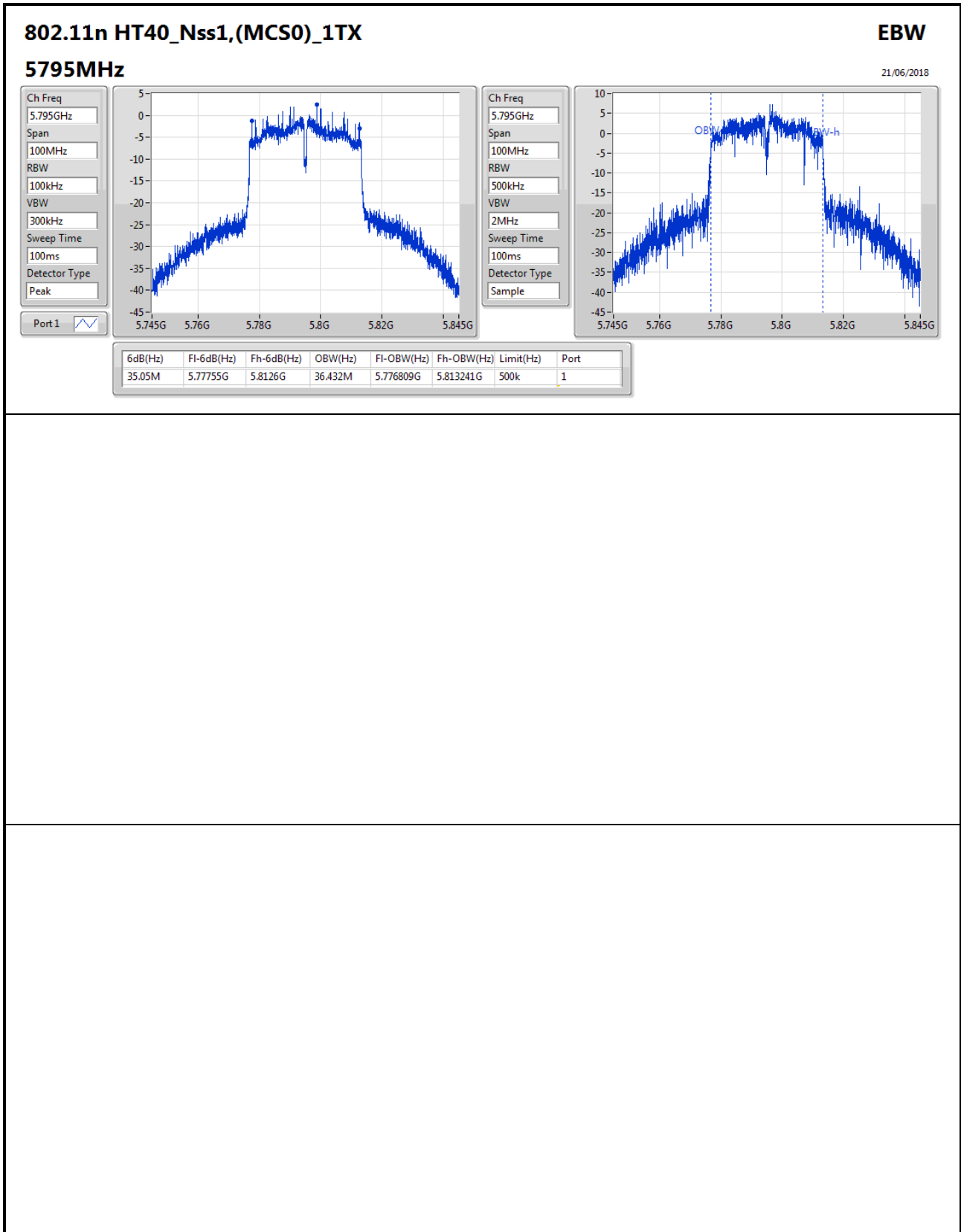



Summary

Mode	Total Power (dBm)	Total Power (W)	EIRP (dBm)	EIRP (W)
5.15-5.25GHz	-	-	-	-
802.11a_Nss1,(6Mbps)_1TX	17.44	0.05546	20.21	0.10495
802.11n HT20_Nss1,(MCS0)_1TX	17.32	0.05395	20.09	0.10209
802.11n HT40_Nss1,(MCS0)_1TX	16.36	0.04325	19.13	0.08185
5.725-5.85GHz	-	-	-	-
802.11a_Nss1,(6Mbps)_1TX	16.86	0.04853	19.98	0.09954
802.11n HT20_Nss1,(MCS0)_1TX	16.55	0.04519	19.67	0.09268
802.11n HT40_Nss1,(MCS0)_1TX	15.72	0.03733	18.84	0.07656



Result

Mode	Result	DG (dBi)	Port 1 (dBm)	Total Power (dBm)	Power Limit (dBm)	EIRP (dBm)	EIRP Limit (dBm)
802.11a_Nss1,(6Mbps)_1TX	-	-	-	-	-	-	-
5180MHz_TnomVnom	Pass	2.68	15.66	15.66	24.00	18.34	30.00
5200MHz_TnomVnom	Pass	2.68	17.05	17.05	24.00	19.73	30.00
5240MHz_TnomVnom	Pass	2.77	17.44	17.44	24.00	20.21	30.00
5745MHz_TnomVnom	Pass	3.12	16.86	16.86	30.00	19.98	36.00
5785MHz_TnomVnom	Pass	2.65	16.48	16.48	30.00	19.13	36.00
5825MHz_TnomVnom	Pass	1.67	16.09	16.09	30.00	17.76	36.00
802.11n HT20_Nss1,(MCS0)_1TX	-	-	-	-	-	-	-
5180MHz_TnomVnom	Pass	2.68	15.53	15.53	24.00	18.21	30.00
5200MHz_TnomVnom	Pass	2.68	16.91	16.91	24.00	19.59	30.00
5240MHz_TnomVnom	Pass	2.77	17.32	17.32	24.00	20.09	30.00
5745MHz_TnomVnom	Pass	3.12	16.55	16.55	30.00	19.67	36.00
5785MHz_TnomVnom	Pass	2.65	16.44	16.44	30.00	19.09	36.00
5825MHz_TnomVnom	Pass	1.67	15.93	15.93	30.00	17.60	36.00
802.11n HT40_Nss1,(MCS0)_1TX	-	-	-	-	-	-	-
5190MHz_TnomVnom	Pass	2.68	13.37	13.37	24.00	16.05	30.00
5230MHz_TnomVnom	Pass	2.77	16.36	16.36	24.00	19.13	30.00
5755MHz_TnomVnom	Pass	3.12	15.72	15.72	30.00	18.84	36.00
5795MHz_TnomVnom	Pass	2.65	15.25	15.25	30.00	17.90	36.00

DG = Directional Gain; **Port X** = Port X output power



Summary

Mode	PD (dBm/RBW)	EIRP PD (dBm/RBW)
5.15-5.25GHz	-	-
802.11a_Nss1,(6Mbps)_1TX	6.07	8.84
802.11n HT20_Nss1,(MCS0)_1TX	5.85	8.62
802.11n HT40_Nss1,(MCS0)_1TX	2.28	5.05
5.725-5.85GHz	-	-
802.11a_Nss1,(6Mbps)_1TX	4.25	7.37
802.11n HT20_Nss1,(MCS0)_1TX	3.61	6.73
802.11n HT40_Nss1,(MCS0)_1TX	0.14	3.26

RBW = 500kHz for 5.725-5.85GHz band / 1MHz for other band;



Result

Mode	Result	DG (dBi)	Port 1 (dBm/RBW)	PD (dBm/RBW)	PD Limit (dBm/RBW)	EIRP PD (dBm/RBW)	EIRP PD Limit (dBm/RBW)
802.11a_Nss1,(6Mbps)_1TX	-	-	-	-	-	-	-
5180MHz_TnomVnom	Pass	2.68	4.50	4.50	11.00	7.18	17.00
5200MHz_TnomVnom	Pass	2.68	5.90	5.90	11.00	8.58	17.00
5240MHz_TnomVnom	Pass	2.77	6.07	6.07	11.00	8.84	17.00
5745MHz_TnomVnom	Pass	3.12	4.25	4.25	30.00	7.37	36.00
5785MHz_TnomVnom	Pass	2.65	3.84	3.84	30.00	6.49	36.00
5825MHz_TnomVnom	Pass	1.67	3.23	3.23	30.00	4.90	36.00
802.11n HT20_Nss1,(MCS0)_1TX	-	-	-	-	-	-	-
5180MHz_TnomVnom	Pass	2.68	4.01	4.01	11.00	6.69	17.00
5200MHz_TnomVnom	Pass	2.68	5.36	5.36	11.00	8.04	17.00
5240MHz_TnomVnom	Pass	2.77	5.85	5.85	11.00	8.62	17.00
5745MHz_TnomVnom	Pass	3.12	3.61	3.61	30.00	6.73	36.00
5785MHz_TnomVnom	Pass	2.65	3.46	3.46	30.00	6.11	36.00
5825MHz_TnomVnom	Pass	1.67	2.74	2.74	30.00	4.41	36.00
802.11n HT40_Nss1,(MCS0)_1TX	-	-	-	-	-	-	-
5190MHz_TnomVnom	Pass	2.68	-0.77	-0.77	11.00	1.91	17.00
5230MHz_TnomVnom	Pass	2.77	2.28	2.28	11.00	5.05	17.00
5755MHz_TnomVnom	Pass	3.12	0.14	0.14	30.00	3.26	36.00
5795MHz_TnomVnom	Pass	2.65	-0.45	-0.45	30.00	2.20	36.00

DG = Directional Gain; RBW = 500kHz for 5.725-5.85GHz band / 1MHz for other band;

PD = trace bin-by-bin of each transmits port summing can be performed maximum power density; Port X = Port Xpower density;

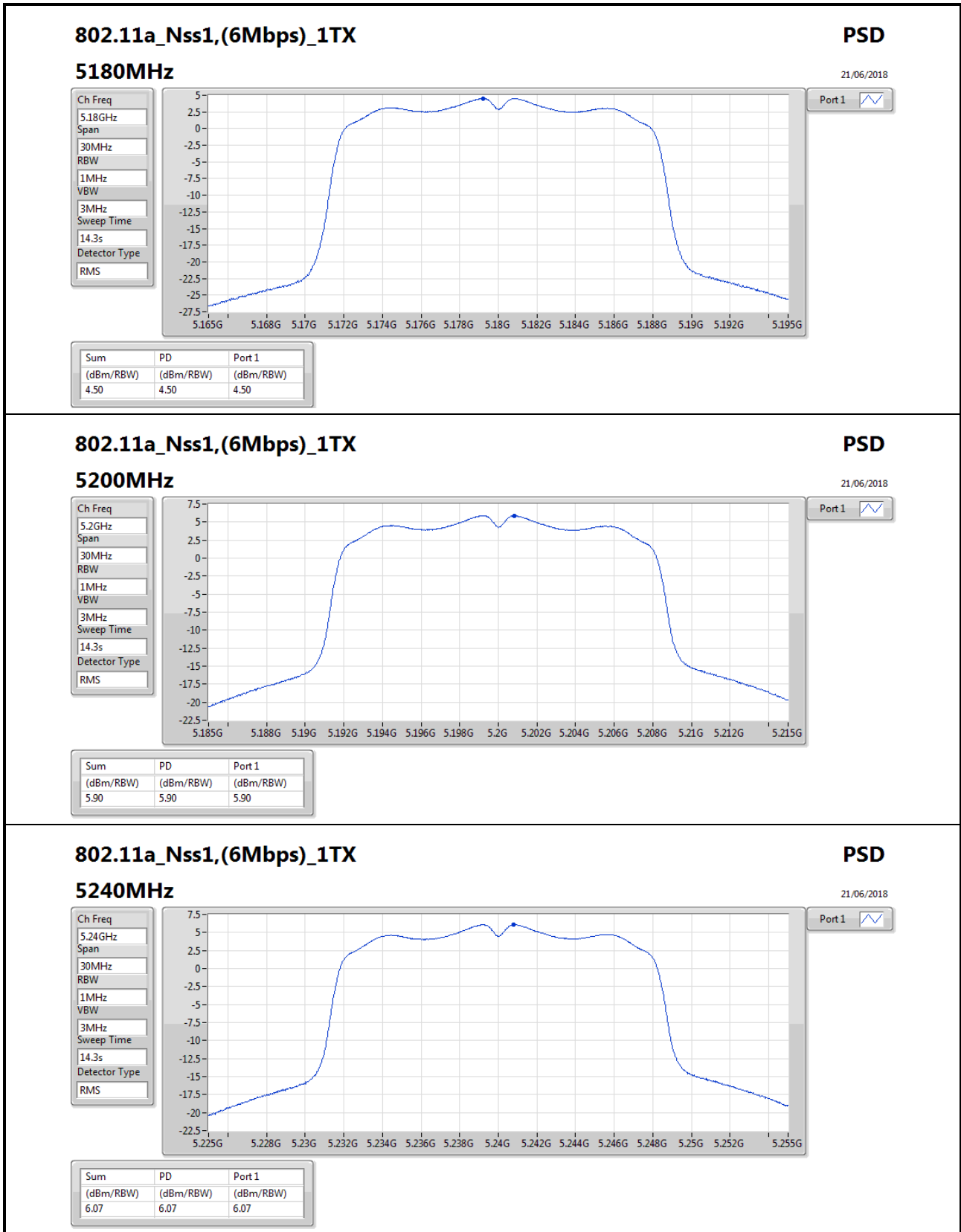

802.11a_Nss1,(6Mbps)_1TX

5240MHz

PSD

21/06/2018

Ch Freq
5.24GHz

Span
30MHz

RBW
1MHz

VBW
3MHz

Sweep Time
14.3s

Detector Type
RMS



Port 1

Sum	PD	Port 1
(dBm/RBW)	(dBm/RBW)	(dBm/RBW)
6.07	6.07	6.07

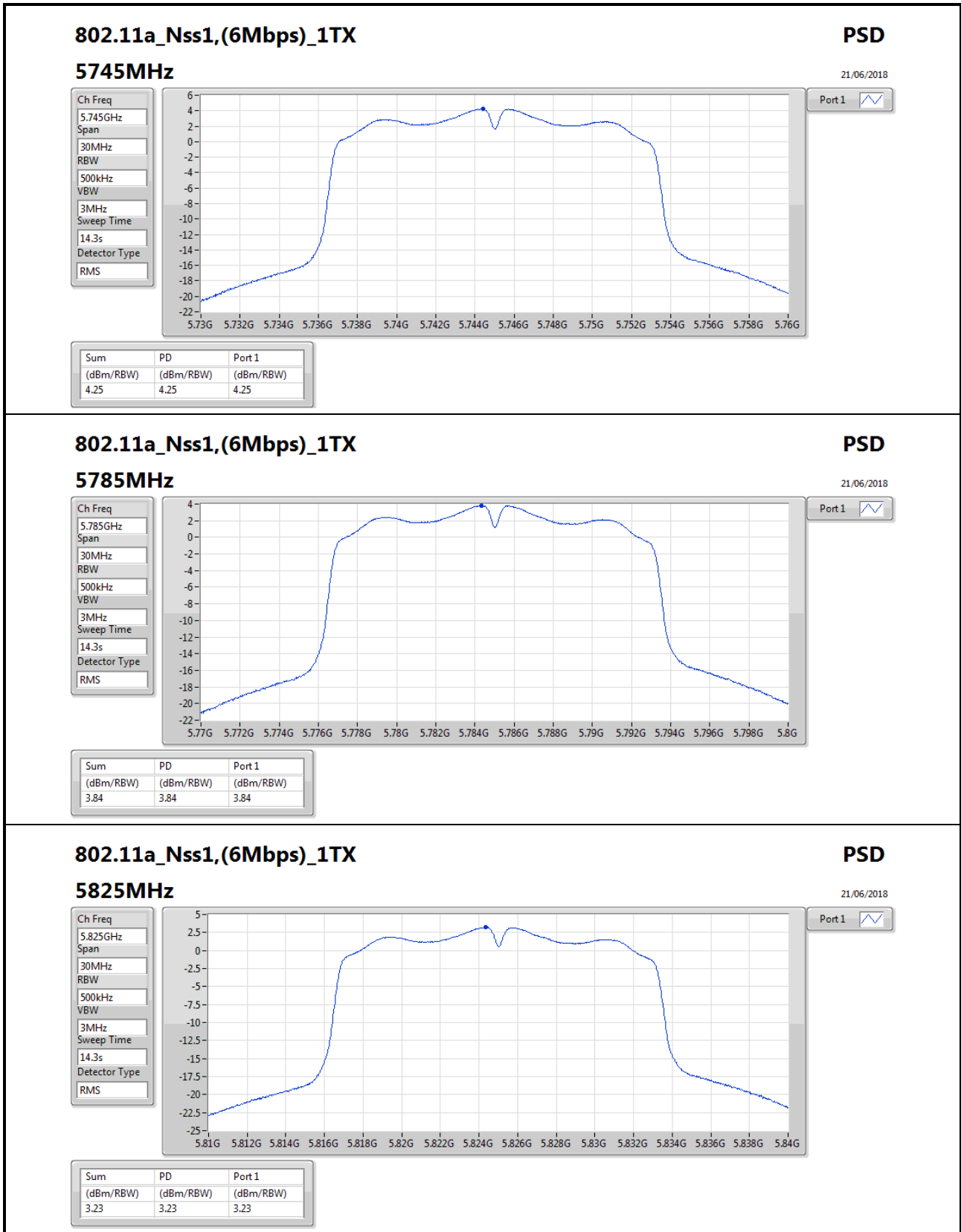

802.11a_Nss1,(6Mbps)_1TX

5825MHz

PSD

21/06/2018

Ch Freq
5.825GHz

Span
30MHz

RBW
500kHz

VBW
3MHz

Sweep Time
14.3s

Detector Type
RMS



Port 1 

Sum	PD	Port 1
(dBm/RBW)	(dBm/RBW)	(dBm/RBW)
3.23	3.23	3.23

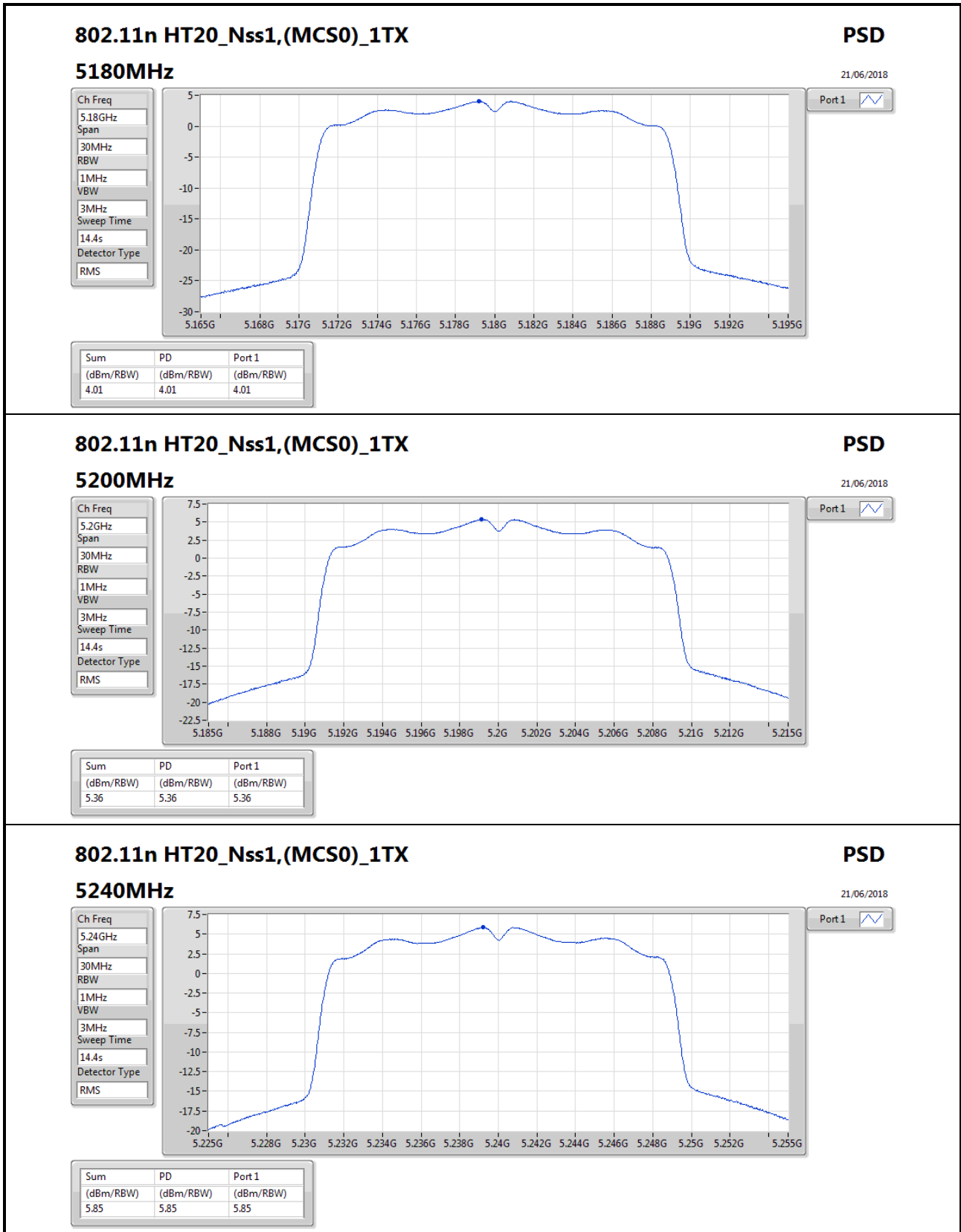

802.11n HT20_Nss1,(MCS0)_1TX

5240MHz

PSD

21/06/2018

Ch Freq

5.24GHz

Span

30MHz

RBW

1MHz

VBW

3MHz

Sweep Time

14.4s

Detector Type

RMS



Port 1

Sum	PD	Port 1
(dBm/RBW)	(dBm/RBW)	(dBm/RBW)
5.85	5.85	5.85

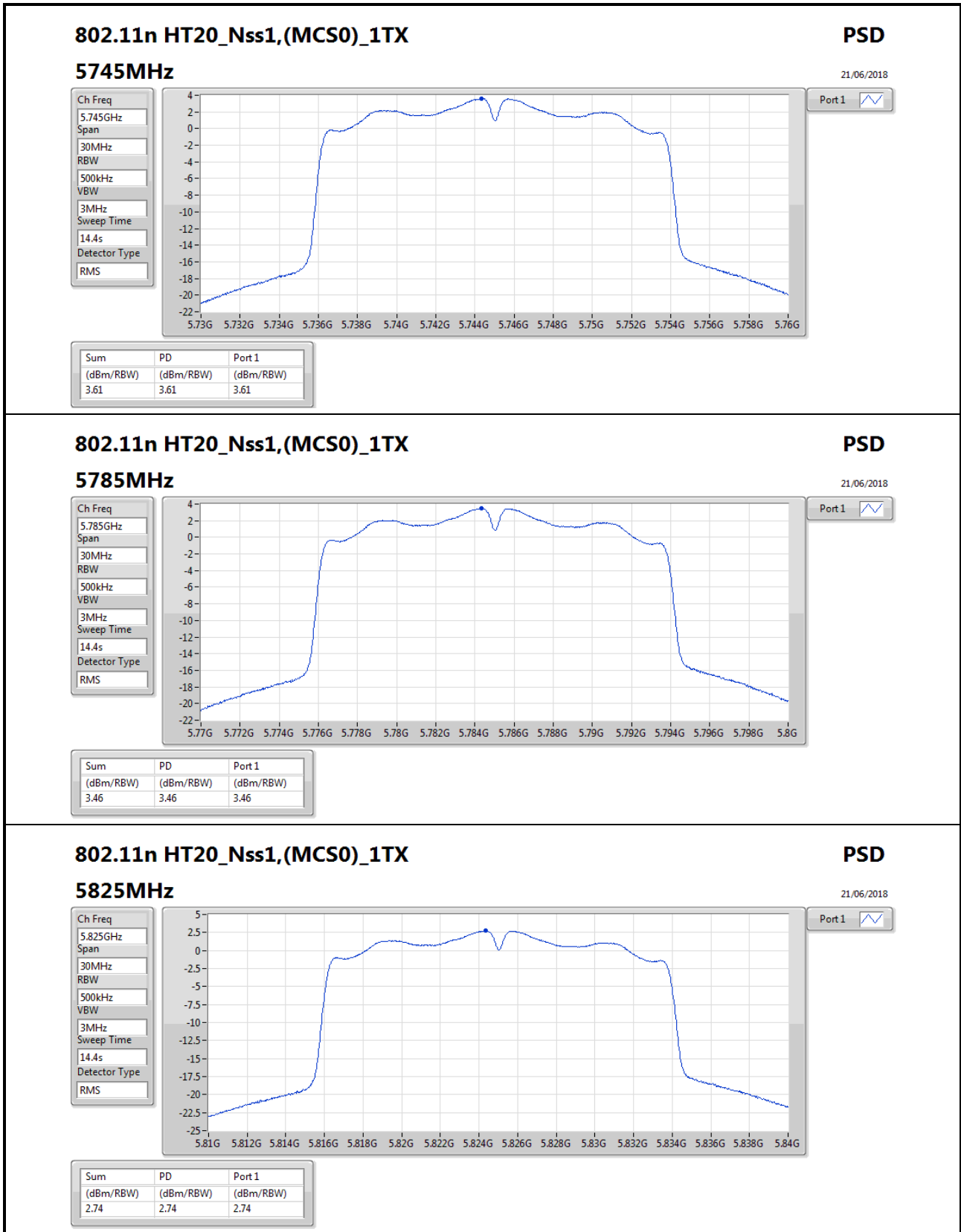

802.11n HT20_Nss1,(MCS0)_1TX

5825MHz

PSD

21/06/2018

Ch Freq
5.825GHz

Span
30MHz

RBW
500kHz

VBW
3MHz

Sweep Time
14.4s

Detector Type
RMS

Port 1

Sum	PD	Port 1
(dBm/RBW)	(dBm/RBW)	(dBm/RBW)
2.74	2.74	2.74

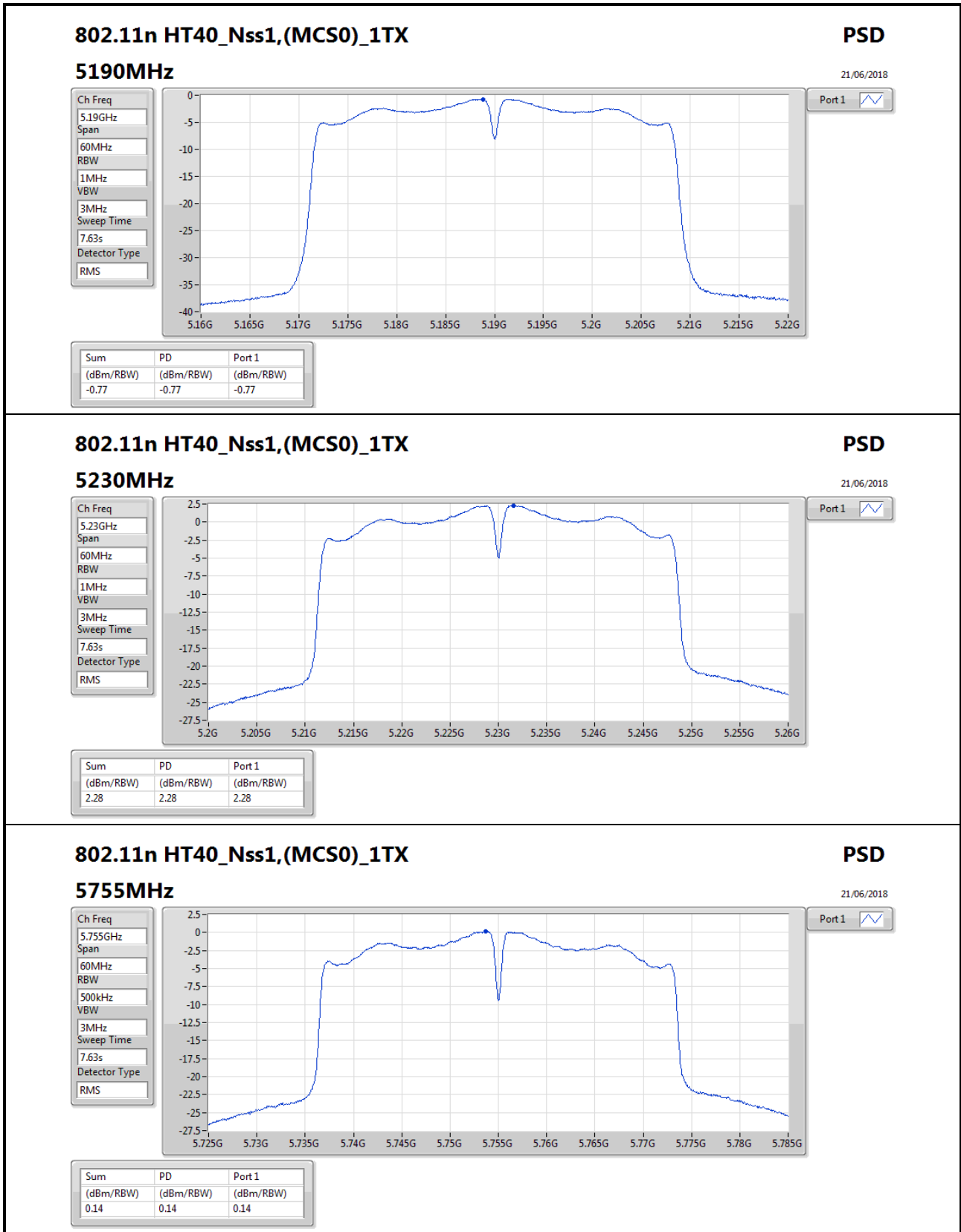

802.11n HT40_Nss1,(MCS0)_1TX

5755MHz

PSD

21/06/2018

Ch Freq
5.755GHz

Span
60MHz

RBW
500kHz

VBW
3MHz

Sweep Time
7.63s

Detector Type
RMS

Port 1

Sum	PD	Port 1
(dBm/RBW)	(dBm/RBW)	(dBm/RBW)
0.14	0.14	0.14

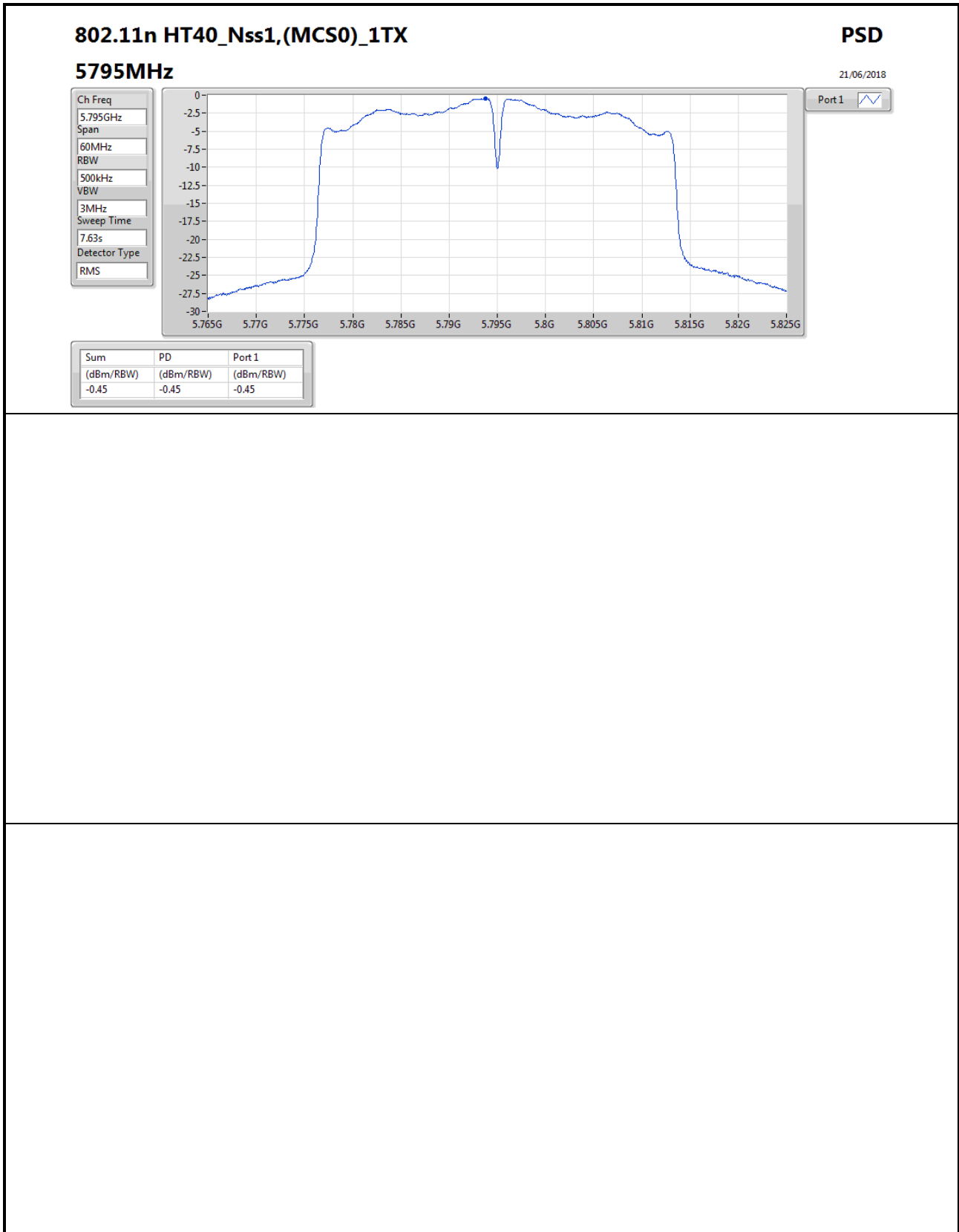



Summary

Mode	Result	Type	Freq (Hz)	Level (dBuV/m)	Limit (dBuV/m)	Margin (dB)	Factor (dB)	Dist (m)	Condition	Azimuth (°)	Height (m)	Comments
5.725-5.85GHz	-	-	-	-	-	-	-	-	-	-	-	-
802.11n HT40_Nss1,(MCS0)_1TX	Pass	PK	749.74M	41.17	43.50	-4.83	0.95	3	Horizontal	0	1.00	-



Result

Mode	Result	Type	Freq (Hz)	Level (dBuV/m)	Limit (dBuV/m)	Margin (dB)	Factor (dB)	Dist (m)	Condition	Azimuth (°)	Height (m)	Comments
802.11n HT40_Nss1,(MCS0)_1TX	-	-	-	-	-	-	-	-	-	-	-	-
5755MHz	Pass	PK	24.228k	48.80	119.90	-71.10	22.01	3	Horizontal	0	1.00	-
5755MHz	Pass	PK	39.456k	49.93	115.67	-65.74	21.64	3	Horizontal	0	1.00	-
5755MHz	Pass	PK	47.07k	55.76	114.13	-58.37	21.29	3	Horizontal	0	1.00	-
5755MHz	Pass	PK	2.2992M	42.94	69.50	-26.56	20.88	3	Horizontal	360	1.00	-
5755MHz	Pass	PK	3.2544M	40.81	69.50	-28.69	20.83	3	Horizontal	360	1.00	-
5755MHz	Pass	PK	18.7167M	38.22	69.50	-31.28	23.08	3	Horizontal	360	1.00	-
5755MHz	Pass	PK	90.14M	31.75	43.50	-11.75	-12.35	3	Vertical	0	1.00	-
5755MHz	Pass	PK	119.24M	29.49	43.50	-14.01	-8.80	3	Vertical	0	1.00	-
5755MHz	Pass	PK	270.56M	39.79	46.00	-6.21	-6.37	3	Vertical	0	1.00	-
5755MHz	Pass	PK	522.76M	35.56	46.00	-10.44	-2.27	3	Vertical	0	1.00	-
5755MHz	Pass	PK	749.74M	34.60	46.00	-11.40	0.95	3	Vertical	0	1.00	-
5755MHz	Pass	PK	850.62M	34.63	46.00	-11.37	2.00	3	Vertical	0	1.00	-
5755MHz	Pass	PK	31.94M	24.51	40.00	-15.49	-5.36	3	Horizontal	0	1.00	-
5755MHz	Pass	PK	121.18M	27.54	43.50	-15.96	-8.80	3	Horizontal	0	1.00	-
5755MHz	Pass	PK	650.8M	35.51	46.00	-10.49	-0.42	3	Horizontal	0	1.00	-
5755MHz	Pass	PK	749.74M	41.17	43.50	-4.83	0.95	3	Horizontal	0	1.00	-
5755MHz	Pass	PK	850.62M	39.66	46.00	-6.34	2.00	3	Horizontal	0	1.00	-
5755MHz	Pass	QP	274.44M	36.28	46.00	-9.72	-6.33	3	Horizontal	138	1.00	-

802.11n HT40_Nss1,(MCS0)_1TX

5755MHz_Adapter

15/08/2018

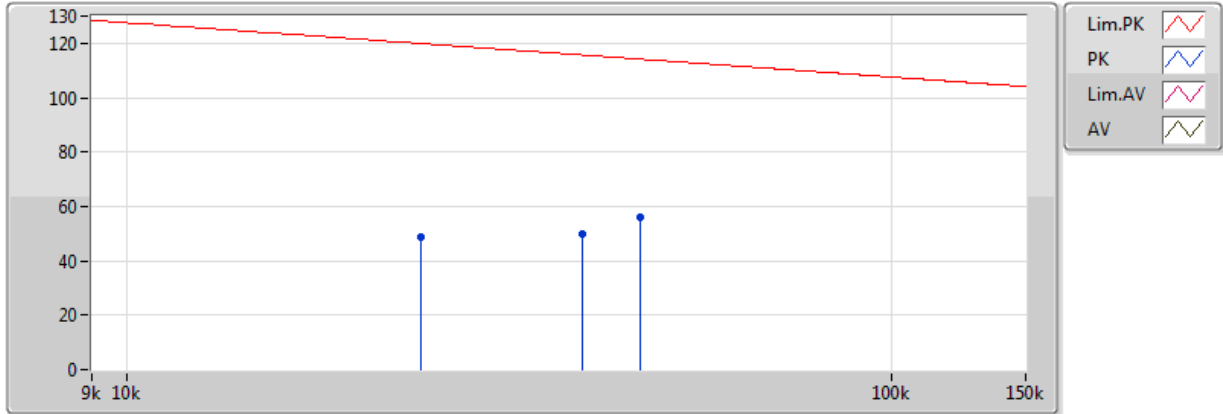

Type	Freq (Hz)	Level (dBuV/m)	Limit (dBuV/m)	Margin (dB)	Factor (dB)	Dist (m)	Condition	Azimuth (°)	Height (m)	Comments
PK	24.228k	48.80	119.90	-71.10	22.01	3	Horizontal	0	1.00	-
PK	39.456k	49.93	115.67	-65.74	21.64	3	Horizontal	0	1.00	-
PK	47.07k	55.76	114.13	-58.37	21.29	3	Horizontal	0	1.00	-

802.11n HT40_Nss1,(MCS0)_1TX

5755MHz_Adapter

15/08/2018

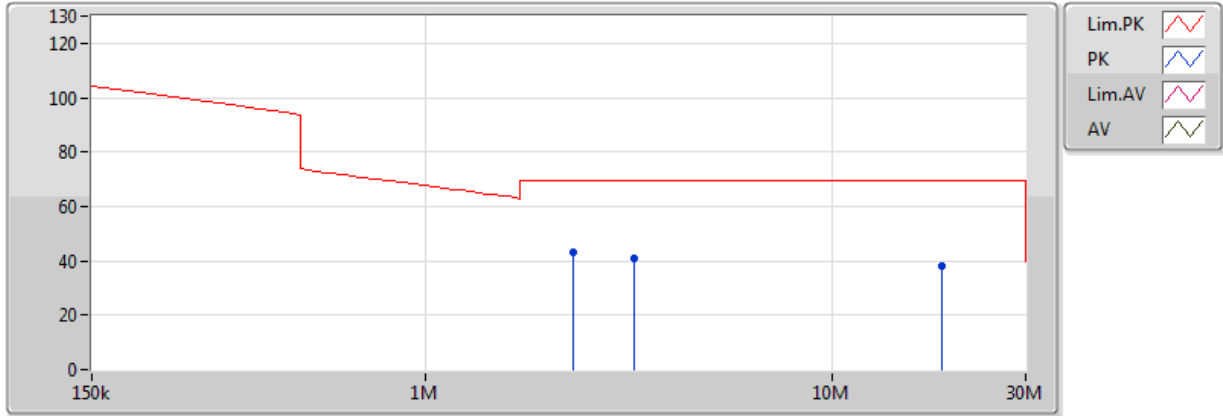

Type	Freq (Hz)	Level (dBuV/m)	Limit (dBuV/m)	Margin (dB)	Factor (dB)	Dist (m)	Condition	Azimuth (°)	Height (m)	Comments
PK	2.2992M	42.94	69.50	-26.56	20.88	3	Horizontal	360	1.00	-
PK	3.2544M	40.81	69.50	-28.69	20.83	3	Horizontal	360	1.00	-
PK	18.7167M	38.22	69.50	-31.28	23.08	3	Horizontal	360	1.00	-

802.11n HT40_Nss1,(MCS0)_1TX

5755MHz_Adapter

15/08/2018

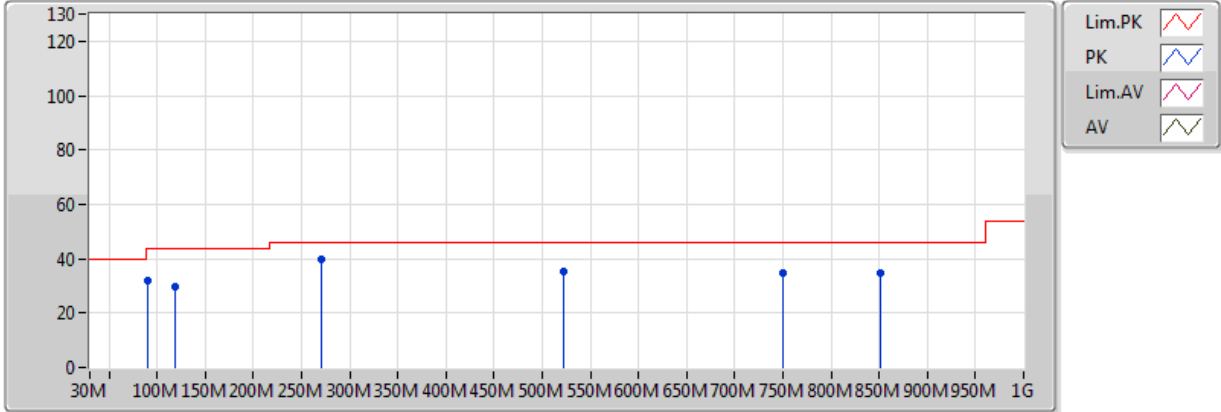

Type	Freq (Hz)	Level (dBuV/m)	Limit (dBuV/m)	Margin (dB)	Factor (dB)	Dist (m)	Condition	Azimuth (°)	Height (m)	Comments
PK	90.14M	31.75	43.50	-11.75	-12.35	3	Vertical	0	1.00	-
PK	119.24M	29.49	43.50	-14.01	-8.80	3	Vertical	0	1.00	-
PK	270.56M	39.79	46.00	-6.21	-6.37	3	Vertical	0	1.00	-
PK	522.76M	35.56	46.00	-10.44	-2.27	3	Vertical	0	1.00	-
PK	749.74M	34.60	46.00	-11.40	0.95	3	Vertical	0	1.00	-
PK	850.62M	34.63	46.00	-11.37	2.00	3	Vertical	0	1.00	-

802.11n HT40_Nss1,(MCS0)_1TX

5755MHz_Adapter

15/08/2018

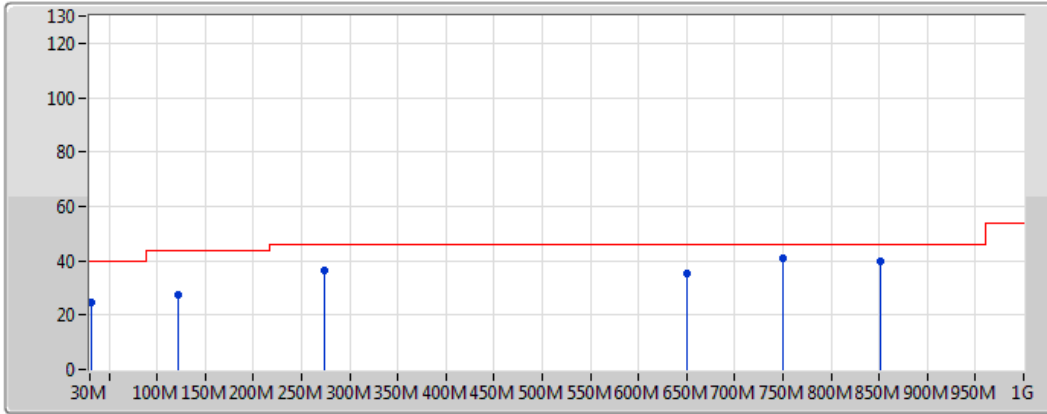

Type	Freq (Hz)	Level (dBuV/m)	Limit (dBuV/m)	Margin (dB)	Factor (dB)	Dist (m)	Condition	Azimuth (°)	Height (m)	Comments
PK	31.94M	24.51	40.00	-15.49	-5.36	3	Horizontal	0	1.00	-
PK	121.18M	27.54	43.50	-15.96	-8.80	3	Horizontal	0	1.00	-
PK	650.8M	35.51	46.00	-10.49	-0.42	3	Horizontal	0	1.00	-
PK	749.74M	41.17	43.50	-4.83	0.95	3	Horizontal	0	1.00	-
PK	850.62M	39.66	46.00	-6.34	2.00	3	Horizontal	0	1.00	-
QP	274.44M	36.28	46.00	-9.72	-6.33	3	Horizontal	138	1.00	-



Summary

Mode	Result	Type	Freq (Hz)	Level (dBuV/m)	Limit (dBuV/m)	Margin (dB)	Factor (dB)	Dist (m)	Condition	Azimuth (°)	Height (m)	Comments
5.725-5.85GHz	-	-	-	-	-	-	-	-	-	-	-	-
802.11n HT40_Nss1,(MCS0)_1TX	Pass	PK	749.74M	41.17	43.50	-4.83	0.95	3	Horizontal	0	1.00	-



Result

Mode	Result	Type	Freq (Hz)	Level (dBuV/m)	Limit (dBuV/m)	Margin (dB)	Factor (dB)	Dist (m)	Condition	Azimuth (°)	Height (m)	Comments
802.11n HT40_Nss1,(MCS0)_1TX	-	-	-	-	-	-	-	-	-	-	-	-
5755MHz	Pass	PK	90.14M	31.75	43.50	-11.75	-12.35	3	Vertical	0	1.00	-
5755MHz	Pass	PK	119.24M	29.49	43.50	-14.01	-8.80	3	Vertical	0	1.00	-
5755MHz	Pass	PK	270.56M	39.79	46.00	-6.21	-6.37	3	Vertical	0	1.00	-
5755MHz	Pass	PK	522.76M	35.56	46.00	-10.44	-2.27	3	Vertical	0	1.00	-
5755MHz	Pass	PK	749.74M	34.60	46.00	-11.40	0.95	3	Vertical	0	1.00	-
5755MHz	Pass	PK	850.62M	34.63	46.00	-11.37	2.00	3	Vertical	0	1.00	-
5755MHz	Pass	PK	31.94M	24.51	40.00	-15.49	-5.36	3	Horizontal	0	1.00	-
5755MHz	Pass	PK	121.18M	27.54	43.50	-15.96	-8.80	3	Horizontal	0	1.00	-
5755MHz	Pass	PK	650.8M	35.51	46.00	-10.49	-0.42	3	Horizontal	0	1.00	-
5755MHz	Pass	PK	749.74M	41.17	43.50	-4.83	0.95	3	Horizontal	0	1.00	-
5755MHz	Pass	PK	850.62M	39.66	46.00	-6.34	2.00	3	Horizontal	0	1.00	-
5755MHz	Pass	QP	274.44M	36.28	46.00	-9.72	-6.33	3	Horizontal	138	1.00	-

802.11n HT40_Nss1,(MCS0)_1TX

5755MHz_Adapter

19/07/2018

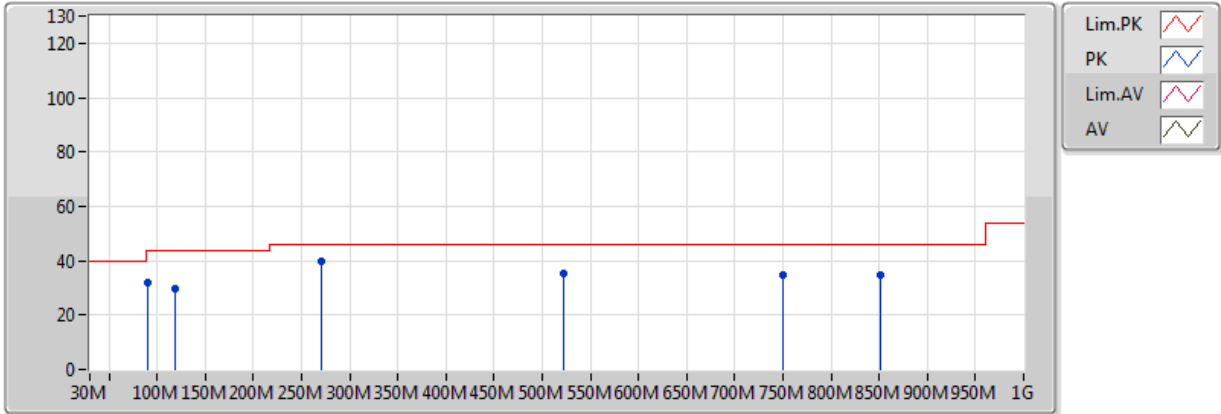

Type	Freq (Hz)	Level (dBuV/m)	Limit (dBuV/m)	Margin (dB)	Factor (dB)	Dist (m)	Condition	Azimuth (°)	Height (m)	Comments
PK	90.14M	31.75	43.50	-11.75	-12.35	3	Vertical	0	1.00	-
PK	119.24M	29.49	43.50	-14.01	-8.80	3	Vertical	0	1.00	-
PK	270.56M	39.79	46.00	-6.21	-6.37	3	Vertical	0	1.00	-
PK	522.76M	35.56	46.00	-10.44	-2.27	3	Vertical	0	1.00	-
PK	749.74M	34.60	46.00	-11.40	0.95	3	Vertical	0	1.00	-
PK	850.62M	34.63	46.00	-11.37	2.00	3	Vertical	0	1.00	-

802.11n HT40_Nss1,(MCS0)_1TX

5755MHz_Adapter

19/07/2018

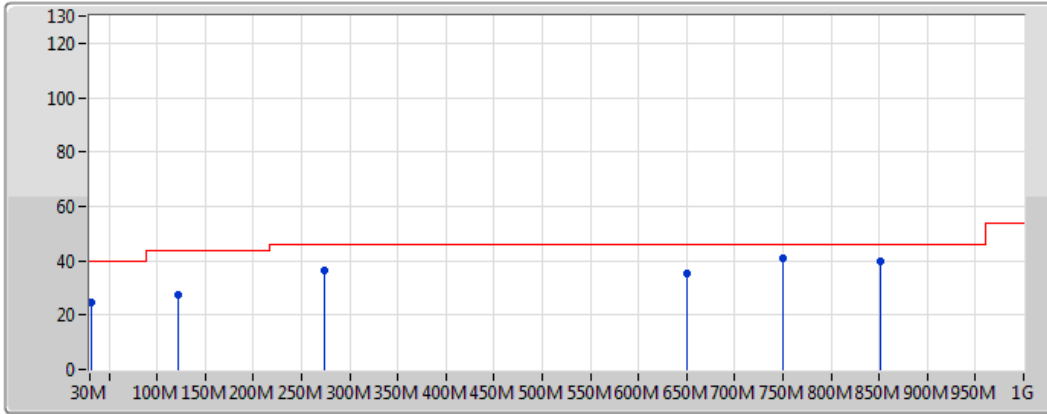

Legend for the spectrum plot:

- Lim.PK: Red stepped line
- PK: Blue vertical bar
- Lim.AV: Pink stepped line
- AV: Black stepped line

Type	Freq (Hz)	Level (dBuV/m)	Limit (dBuV/m)	Margin (dB)	Factor (dB)	Dist (m)	Condition	Azimuth (°)	Height (m)	Comments
PK	31.94M	24.51	40.00	-15.49	-5.36	3	Horizontal	0	1.00	-
PK	121.18M	27.54	43.50	-15.96	-8.80	3	Horizontal	0	1.00	-
PK	650.8M	35.51	46.00	-10.49	-0.42	3	Horizontal	0	1.00	-
PK	749.74M	41.17	43.50	-4.83	0.95	3	Horizontal	0	1.00	-
PK	850.62M	39.66	46.00	-6.34	2.00	3	Horizontal	0	1.00	-
QP	274.44M	36.28	46.00	-9.72	-6.33	3	Horizontal	138	1.00	-



Summary

Mode	Type	Freq (Hz)	Level (dBuV/m)	Limit (dBuV/m)	Margin (dB)	Factor (dB)	Condition	Azimuth (°)	Height (m)
Mode 2	QK	575M	33.83	37.00	-3.17	-27.65	Horizontal	189	252

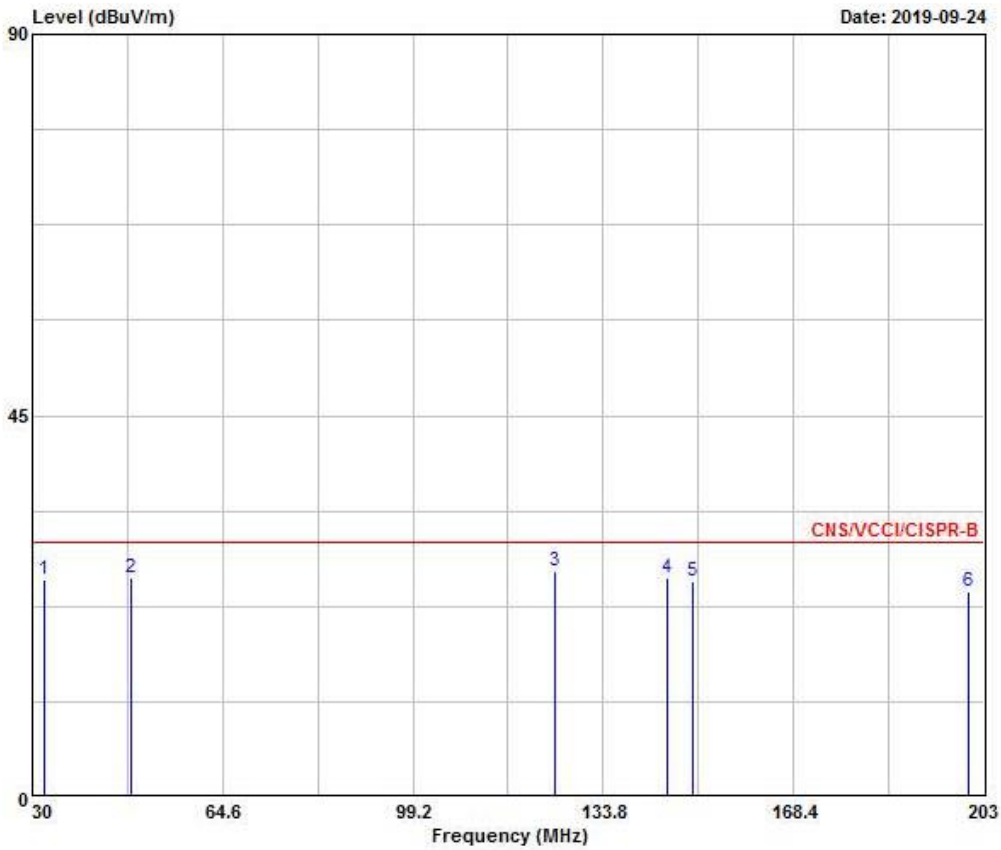

	Freq	Level	Over Limit	Limit Line	Read Level	Cable Loss	Preamp Factor	Antenna Factor	Ant Pos	Table Pos	Remark
	MHz	dBuV/m	dB	dBuV/m	dBuV	dB	dB	dB/m	cm	deg	
1 @	32.200	25.64	-4.36	30.00	29.76	0.70	27.00	22.18	---	---	Peak
2 @	47.800	25.81	-4.19	30.00	37.77	0.87	26.98	14.15	---	---	QP
3 @	125.000	26.65	-3.35	30.00	34.66	1.34	26.71	17.36	100	61	QP
4 @	145.380	25.91	-4.09	30.00	35.06	1.47	26.62	16.00	---	---	Peak
5 @	150.060	25.53	-4.47	30.00	35.01	1.52	26.61	15.61	---	---	Peak
6 @	200.060	24.21	-5.79	30.00	34.49	1.71	26.39	14.40	---	---	Peak

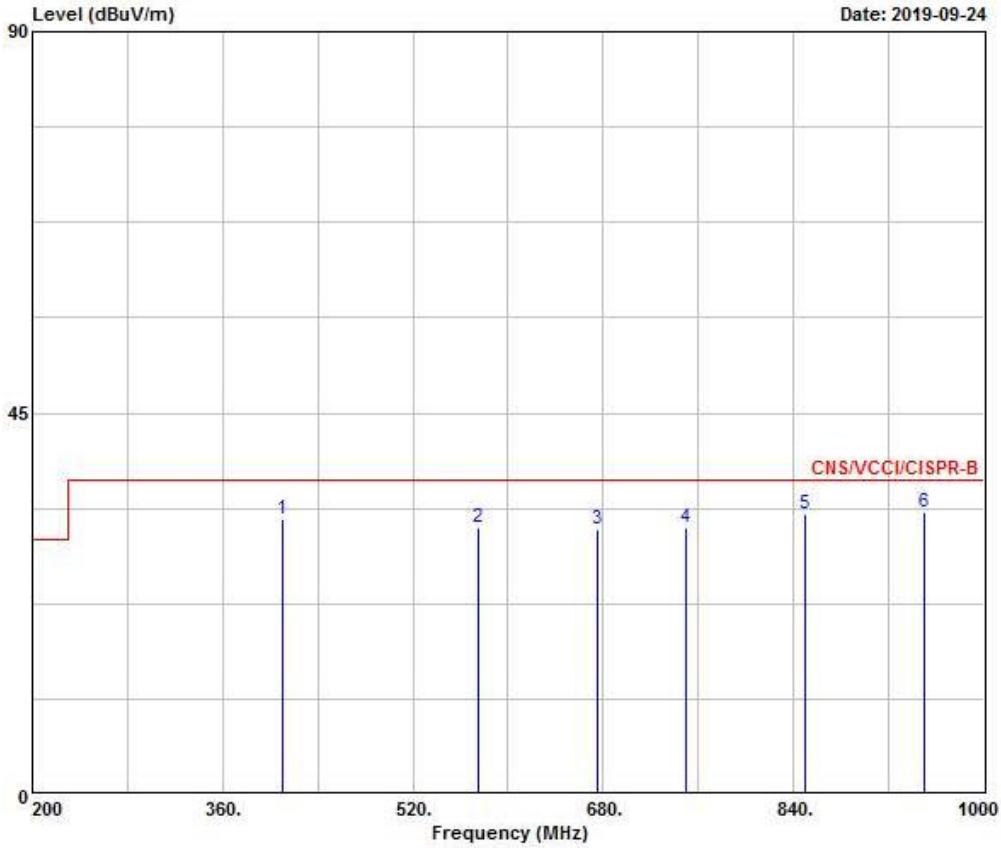

	Freq	Level	Over Limit	Limit Line	Read Level	Cable Loss	Preamp Factor	Antenna Factor	Ant Pos	Table Pos	Remark
	MHz	dBuV/m	dB	dBuV/m	dBuV	dB	dB	dB/m	cm	deg	
1 @	410.400	32.51	-4.49	37.00	35.46	2.70	27.08	21.43	---	---	Peak
2 @	575.000	31.38	-5.62	37.00	32.10	3.26	27.65	23.67	---	---	Peak
3 @	675.000	31.19	-5.81	37.00	31.40	3.45	27.66	24.00	---	---	Peak
4 @	750.000	31.40	-5.60	37.00	30.80	3.39	27.58	24.79	---	---	QP
5 @	850.000	33.04	-3.96	37.00	30.90	4.07	27.41	25.48	---	---	QP
6 @	950.000	33.23	-3.77	37.00	30.17	4.14	27.20	26.12	---	---	QP

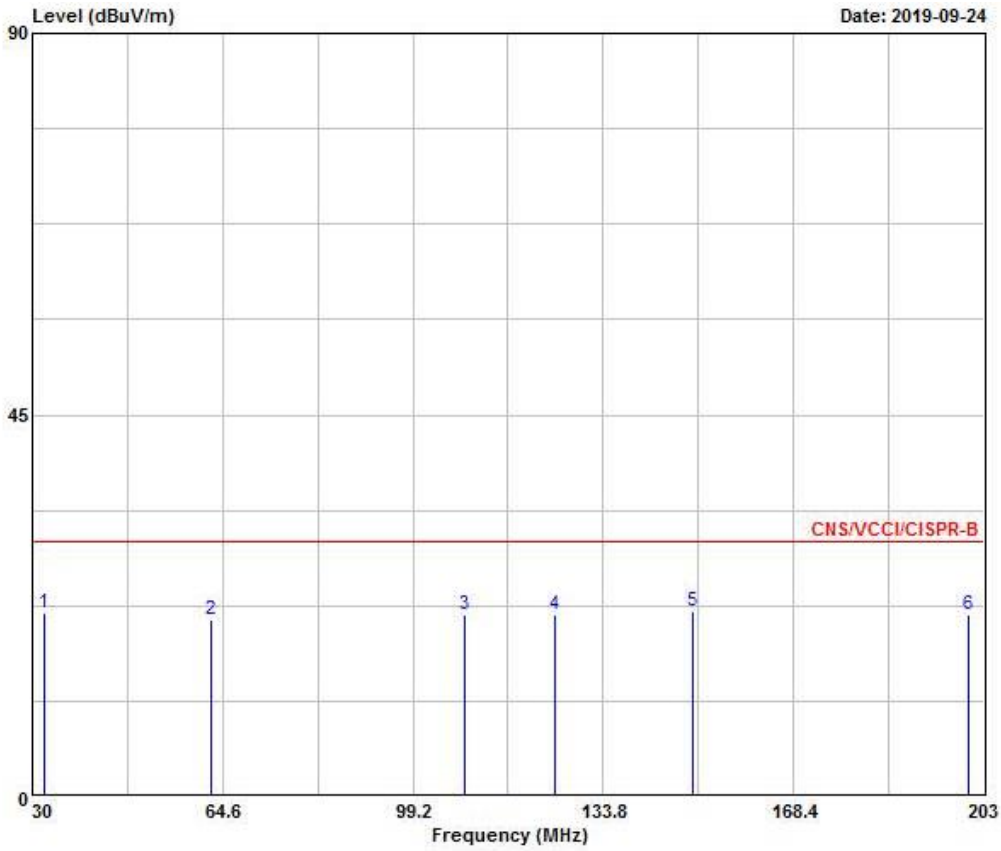

Peak	Freq	Level	Over Limit	Limit Line	Read Level	Cable Loss	Preamp Factor	Antenna Factor	Ant Pos	Table Pos	Remark
	MHz	dBuV/m	dB	dBuV/m	dBuV	dB	dB	dB/m	cm	deg	
1	32.030	21.63	-8.37	30.00	25.75	0.70	27.00	22.18	---	---	Peak
2	62.570	20.92	-9.08	30.00	35.42	0.98	26.94	11.46	---	---	Peak
3	108.720	21.51	-8.49	30.00	30.10	1.23	26.78	16.96	---	---	Peak
4	125.000	21.40	-8.60	30.00	29.41	1.34	26.71	17.36	---	---	Peak
5	150.060	21.91	-8.09	30.00	31.39	1.52	26.61	15.61	---	---	Peak
6	200.060	21.44	-8.56	30.00	31.72	1.71	26.39	14.40	---	---	Peak

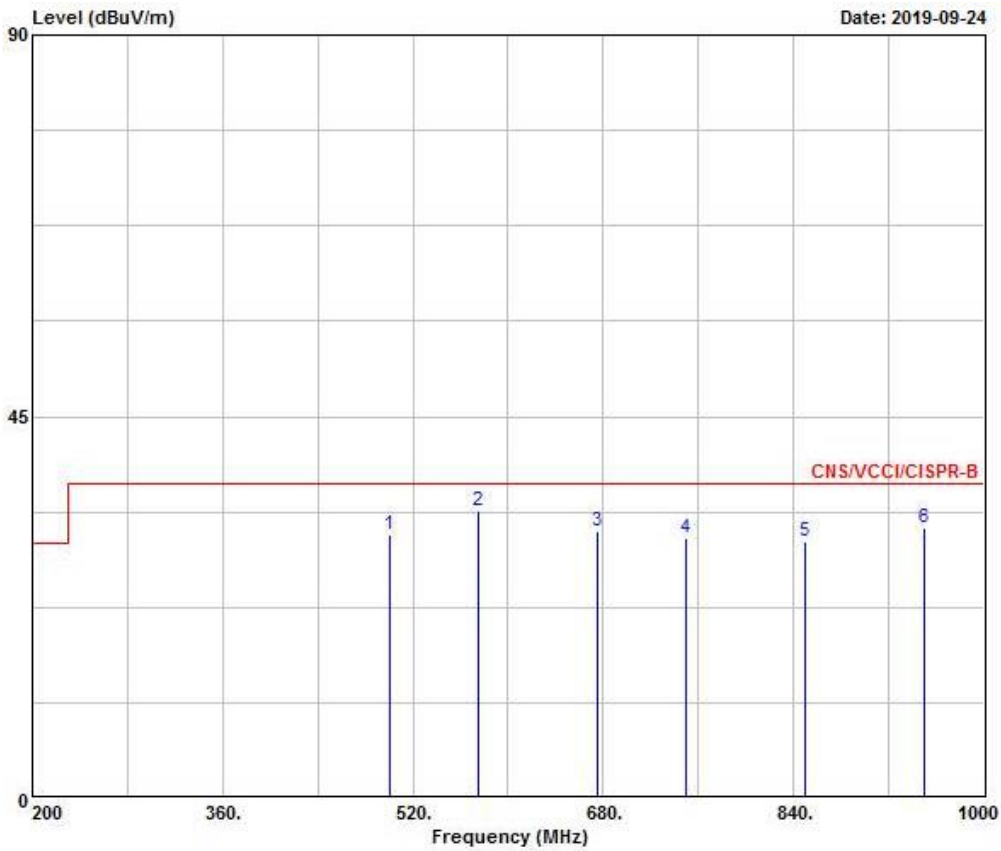

	Freq	Level	Over Limit	Limit Line	Read Level	Cable Loss	Preamp Factor	Antenna Factor	Ant Pos	Table Pos	Remark
	MHz	dBuV/m	dB	dBuV/m	dBuV	dB	dB	dB/m	cm	deg	
1 @	500.000	31.15	-5.85	37.00	33.10	3.02	27.56	22.59	---	---	Peak
2 @	575.000	33.83	-3.17	37.00	34.55	3.26	27.65	23.67	189	252	QP
3 @	675.000	31.43	-5.57	37.00	31.64	3.45	27.66	24.00	---	---	Peak
4 @	750.000	30.61	-6.39	37.00	30.01	3.39	27.58	24.79	---	---	Peak
5 @	850.000	30.22	-6.78	37.00	28.08	4.07	27.41	25.48	---	---	Peak
6 @	950.000	31.91	-5.09	37.00	28.85	4.14	27.20	26.12	---	---	Peak



Summary

Mode	Result	Type	Freq (Hz)	Level (dBuV/m)	Limit (dBuV/m)	Margin (dB)	Factor (dB)	Dist (m)	Condition	Azimuth (°)	Height (m)	Comments
5.15-5.25GHz	-	-	-	-	-	-	-	-	-	-	-	-
802.11a_Nss1,(6Mbps)_1TX	Pass	AV	5.149995G	53.69	54.00	-0.31	3.68	3	Horizontal	146	1.06	-
802.11n HT20_Nss1,(MCS0)_1TX	Pass	AV	5.1496G	53.86	54.00	-0.14	3.68	3	Horizontal	141	1.06	-
802.11n HT40_Nss1,(MCS0)_1TX	Pass	AV	5.149995G	53.29	54.00	-0.71	3.68	3	Horizontal	133	1.03	-
5.725-5.85GHz	-	-	-	-	-	-	-	-	-	-	-	-
802.11a_Nss1,(6Mbps)_1TX	Pass	AV	11.64826G	45.62	54.00	-8.38	14.87	3	Vertical	2	3.17	-
802.11n HT20_Nss1,(MCS0)_1TX	Pass	AV	11.49276G	45.81	54.00	-8.19	15.05	3	Vertical	356	3.14	-
802.11n HT40_Nss1,(MCS0)_1TX	Pass	PK	5.9306G	59.67	68.20	-8.53	4.99	3	Horizontal	356	2.13	-



Result

Mode	Result	Type	Freq (Hz)	Level (dBuV/m)	Limit (dBuV/m)	Margin (dB)	Factor (dB)	Dist (m)	Condition	Azimuth (°)	Height (m)	Comments
802.11a_Nss1,(6Mbps)_1TX	-	-	-	-	-	-	-	-	-	-	-	-
5180MHz	Pass	AV	5.149995G	51.51	54.00	-2.49	3.68	3	Vertical	65	3.17	-
5180MHz	Pass	AV	5.1808G	96.09	Inf	-Inf	3.74	3	Vertical	65	3.17	-
5180MHz	Pass	PK	5.1488G	65.24	74.00	-8.76	3.68	3	Vertical	65	3.17	-
5180MHz	Pass	PK	5.1812G	104.86	Inf	-Inf	3.74	3	Vertical	65	3.17	-
5180MHz	Pass	AV	5.149995G	53.69	54.00	-0.31	3.68	3	Horizontal	146	1.06	-
5180MHz	Pass	AV	5.179G	98.39	Inf	-Inf	3.73	3	Horizontal	146	1.06	-
5180MHz	Pass	PK	5.1448G	68.46	74.00	-5.54	3.67	3	Horizontal	146	1.06	-
5180MHz	Pass	PK	5.1776G	107.00	Inf	-Inf	3.73	3	Horizontal	146	1.06	-
5180MHz	Pass	AV	10.37128G	46.06	54.00	-7.94	14.34	3	Vertical	343	1.03	-
5180MHz	Pass	PK	10.36312G	58.29	74.00	-15.71	14.32	3	Vertical	343	1.03	-
5180MHz	Pass	AV	10.3642G	46.02	54.00	-7.98	14.32	3	Horizontal	154	1.90	-
5180MHz	Pass	PK	10.35766G	58.58	74.00	-15.42	14.31	3	Horizontal	154	1.90	-
5200MHz	Pass	AV	5.1492G	47.98	54.00	-6.02	3.68	3	Vertical	44	2.84	-
5200MHz	Pass	AV	5.1988G	95.37	Inf	-Inf	3.77	3	Vertical	44	2.84	-
5200MHz	Pass	PK	5.1488G	60.31	74.00	-13.69	3.68	3	Vertical	44	2.84	-
5200MHz	Pass	PK	5.2004G	103.98	Inf	-Inf	3.77	3	Vertical	44	2.84	-
5200MHz	Pass	AV	5.148G	50.52	54.00	-3.48	3.68	3	Horizontal	128	1.01	-
5200MHz	Pass	AV	5.1992G	99.53	Inf	-Inf	3.77	3	Horizontal	128	1.01	-
5200MHz	Pass	PK	5.1496G	64.22	74.00	-9.78	3.68	3	Horizontal	128	1.01	-
5200MHz	Pass	PK	5.2004G	107.98	Inf	-Inf	3.77	3	Horizontal	128	1.01	-
5200MHz	Pass	AV	10.39898G	46.75	54.00	-7.25	14.39	3	Vertical	109	2.47	-
5200MHz	Pass	PK	10.39682G	58.70	74.00	-15.30	14.39	3	Vertical	109	2.47	-
5200MHz	Pass	AV	10.39406G	46.26	54.00	-7.74	14.38	3	Horizontal	15	2.23	-
5200MHz	Pass	PK	10.3865G	58.51	74.00	-15.49	14.37	3	Horizontal	15	2.23	-
5240MHz	Pass	AV	5.1482G	46.08	54.00	-7.92	3.68	3	Vertical	32	1.01	-
5240MHz	Pass	AV	5.2394G	93.61	Inf	-Inf	3.84	3	Vertical	32	1.01	-
5240MHz	Pass	AV	5.3852G	47.14	54.00	-6.86	4.11	3	Vertical	32	1.01	-
5240MHz	Pass	PK	5.102G	57.58	74.00	-16.42	3.59	3	Vertical	32	1.01	-
5240MHz	Pass	PK	5.2412G	102.06	Inf	-Inf	3.85	3	Vertical	32	1.01	-
5240MHz	Pass	PK	5.384G	58.17	74.00	-15.83	4.11	3	Vertical	32	1.01	-
5240MHz	Pass	AV	5.149995G	46.28	54.00	-7.72	3.68	3	Horizontal	148	1.11	-
5240MHz	Pass	AV	5.2412G	100.08	Inf	-Inf	3.85	3	Horizontal	148	1.11	-
5240MHz	Pass	AV	5.3534G	47.32	54.00	-6.68	4.05	3	Horizontal	148	1.11	-
5240MHz	Pass	PK	5.1068G	58.24	74.00	-15.76	3.60	3	Horizontal	148	1.11	-
5240MHz	Pass	PK	5.24G	108.75	Inf	-Inf	3.85	3	Horizontal	148	1.11	-
5240MHz	Pass	PK	5.3534G	58.03	74.00	-15.97	4.05	3	Horizontal	148	1.11	-
5240MHz	Pass	AV	10.47394G	45.41	54.00	-8.59	14.55	3	Vertical	221	1.05	-
5240MHz	Pass	PK	10.48078G	57.51	74.00	-16.49	14.56	3	Vertical	221	1.05	-
5240MHz	Pass	PK	10.46992G	58.61	74.00	-15.39	14.54	3	Horizontal	6	1.45	-
5240MHz	Pass	AV	10.47478G	45.25	54.00	-8.75	14.55	3	Horizontal	6	1.45	-
5745MHz	Pass	AV	5.7438G	99.17	Inf	-Inf	4.70	3	Vertical	31	2.53	-
5745MHz	Pass	PK	5.5386G	58.72	68.20	-9.48	4.38	3	Vertical	31	2.53	-
5745MHz	Pass	PK	5.7462G	106.97	Inf	-Inf	4.70	3	Vertical	31	2.53	-
5745MHz	Pass	PK	5.9898G	58.53	68.20	-9.67	5.09	3	Vertical	31	2.53	-
5745MHz	Pass	AV	5.7462G	100.45	Inf	-Inf	4.70	3	Horizontal	10	2.26	-
5745MHz	Pass	PK	5.649G	59.52	68.20	-8.68	4.55	3	Horizontal	10	2.26	-
5745MHz	Pass	PK	5.745G	108.34	Inf	-Inf	4.70	3	Horizontal	10	2.26	-



RSE TX above 1GHz Result

Appendix E.4

Mode	Result	Type	Freq (Hz)	Level (dBuV/m)	Limit (dBuV/m)	Margin (dB)	Factor (dB)	Dist (m)	Condition	Azimuth (°)	Height (m)	Comments
5745MHz	Pass	PK	5.9274G	58.76	68.20	-9.44	4.99	3	Horizontal	10	2.26	-
5745MHz	Pass	AV	11.49018G	45.52	54.00	-8.48	15.05	3	Vertical	218	1.96	-
5745MHz	Pass	PK	11.49156G	57.04	74.00	-16.96	15.05	3	Vertical	218	1.96	-
5745MHz	Pass	AV	11.49144G	45.33	54.00	-8.67	15.05	3	Horizontal	149	1.50	-
5745MHz	Pass	PK	11.47722G	57.56	74.00	-16.44	15.07	3	Horizontal	149	1.50	-
5785MHz	Pass	AV	5.7838G	98.74	Inf	-Inf	4.76	3	Vertical	30	2.49	-
5785MHz	Pass	PK	5.5114G	58.80	68.20	-9.40	4.34	3	Vertical	30	2.49	-
5785MHz	Pass	PK	5.7862G	106.90	Inf	-Inf	4.77	3	Vertical	30	2.49	-
5785MHz	Pass	PK	5.965G	58.50	68.20	-9.70	5.05	3	Vertical	30	2.49	-
5785MHz	Pass	AV	5.7838G	99.32	Inf	-Inf	4.76	3	Horizontal	9	1.49	-
5785MHz	Pass	PK	5.6134G	59.00	68.20	-9.20	4.50	3	Horizontal	9	1.49	-
5785MHz	Pass	PK	5.7838G	107.23	Inf	-Inf	4.76	3	Horizontal	9	1.49	-
5785MHz	Pass	PK	5.947G	59.03	68.20	-9.17	5.03	3	Horizontal	9	1.49	-
5785MHz	Pass	AV	11.58476G	44.86	54.00	-9.14	14.94	3	Vertical	57	1.78	-
5785MHz	Pass	PK	11.55776G	56.33	74.00	-17.67	14.97	3	Vertical	57	1.78	-
5785MHz	Pass	AV	11.582G	45.10	54.00	-8.90	14.94	3	Horizontal	151	1.32	-
5785MHz	Pass	PK	11.57384G	57.71	74.00	-16.29	14.95	3	Horizontal	151	1.32	-
5825MHz	Pass	AV	5.8238G	97.66	Inf	-Inf	4.83	3	Vertical	27	2.47	-
5825MHz	Pass	PK	5.6174G	58.93	68.20	-9.27	4.49	3	Vertical	27	2.47	-
5825MHz	Pass	PK	5.8238G	106.04	Inf	-Inf	4.83	3	Vertical	27	2.47	-
5825MHz	Pass	PK	5.969G	58.75	68.20	-9.45	5.06	3	Vertical	27	2.47	-
5825MHz	Pass	AV	5.8238G	99.39	Inf	-Inf	4.83	3	Horizontal	141	1.01	-
5825MHz	Pass	PK	5.6474G	59.29	68.20	-8.91	4.55	3	Horizontal	141	1.01	-
5825MHz	Pass	PK	5.8238G	107.33	Inf	-Inf	4.83	3	Horizontal	141	1.01	-
5825MHz	Pass	PK	5.9438G	58.79	68.20	-9.41	5.02	3	Horizontal	141	1.01	-
5825MHz	Pass	AV	11.64826G	45.62	54.00	-8.38	14.87	3	Vertical	2	3.17	-
5825MHz	Pass	PK	11.64634G	57.32	74.00	-16.68	14.87	3	Vertical	2	3.17	-
5825MHz	Pass	AV	11.64598G	45.42	54.00	-8.58	14.87	3	Horizontal	172	1.50	-
5825MHz	Pass	PK	11.65006G	57.24	74.00	-16.76	14.87	3	Horizontal	172	1.50	-
802.11n HT20_Nss1,(MCS0)_1TX	-	-	-	-	-	-	-	-	-	-	-	-
5180MHz	Pass	AV	5.149995G	51.64	54.00	-2.36	3.68	3	Vertical	69	2.23	-
5180MHz	Pass	AV	5.179G	94.78	Inf	-Inf	3.73	3	Vertical	69	2.23	-
5180MHz	Pass	PK	5.149995G	67.34	74.00	-6.66	3.68	3	Vertical	69	2.23	-
5180MHz	Pass	PK	5.18G	103.80	Inf	-Inf	3.73	3	Vertical	69	2.23	-
5180MHz	Pass	AV	5.1496G	53.86	54.00	-0.14	3.68	3	Horizontal	141	1.06	-
5180MHz	Pass	AV	5.1794G	97.78	Inf	-Inf	3.73	3	Horizontal	141	1.06	-
5180MHz	Pass	PK	5.1494G	68.29	74.00	-5.71	3.68	3	Horizontal	141	1.06	-
5180MHz	Pass	PK	5.1814G	106.28	Inf	-Inf	3.74	3	Horizontal	141	1.06	-
5180MHz	Pass	AV	10.37164G	45.85	54.00	-8.15	14.34	3	Vertical	355	2.19	-
5180MHz	Pass	PK	10.35148G	58.76	74.00	-15.24	14.30	3	Vertical	355	2.19	-
5180MHz	Pass	AV	10.37458G	45.89	54.00	-8.11	14.34	3	Horizontal	271	1.43	-
5180MHz	Pass	PK	10.3507G	57.98	74.00	-16.02	14.30	3	Horizontal	271	1.43	-
5200MHz	Pass	AV	5.1496G	47.76	54.00	-6.24	3.68	3	Vertical	54	2.68	-
5200MHz	Pass	AV	5.2008G	95.10	Inf	-Inf	3.77	3	Vertical	54	2.68	-
5200MHz	Pass	PK	5.1424G	60.34	74.00	-13.66	3.67	3	Vertical	54	2.68	-
5200MHz	Pass	PK	5.2012G	103.25	Inf	-Inf	3.77	3	Vertical	54	2.68	-
5200MHz	Pass	AV	5.1496G	51.84	54.00	-2.16	3.68	3	Horizontal	124	1.01	-
5200MHz	Pass	AV	5.1992G	100.10	Inf	-Inf	3.77	3	Horizontal	124	1.01	-
5200MHz	Pass	PK	5.149995G	65.26	74.00	-8.74	3.68	3	Horizontal	124	1.01	-



RSE TX above 1GHz Result

Appendix E.4

Mode	Result	Type	Freq (Hz)	Level (dBuV/m)	Limit (dBuV/m)	Margin (dB)	Factor (dB)	Dist (m)	Condition	Azimuth (°)	Height (m)	Comments
5200MHz	Pass	PK	5.1984G	108.29	Inf	-Inf	3.77	3	Horizontal	124	1.01	-
5200MHz	Pass	AV	10.39856G	46.89	54.00	-7.11	14.39	3	Vertical	360	2.13	-
5200MHz	Pass	PK	10.39634G	58.63	74.00	-15.37	14.39	3	Vertical	360	2.13	-
5200MHz	Pass	AV	10.39928G	47.03	54.00	-6.97	14.39	3	Horizontal	23	1.50	-
5200MHz	Pass	PK	10.39904G	58.46	74.00	-15.54	14.39	3	Horizontal	23	1.50	-
5240MHz	Pass	AV	5.1344G	46.11	54.00	-7.89	3.65	3	Vertical	22	1.03	-
5240MHz	Pass	AV	5.2406G	94.33	Inf	-Inf	3.85	3	Vertical	22	1.03	-
5240MHz	Pass	AV	5.3864G	47.07	54.00	-6.93	4.11	3	Vertical	22	1.03	-
5240MHz	Pass	PK	5.1434G	58.07	74.00	-15.93	3.67	3	Vertical	22	1.03	-
5240MHz	Pass	PK	5.2412G	102.24	Inf	-Inf	3.85	3	Vertical	22	1.03	-
5240MHz	Pass	PK	5.3888G	58.51	74.00	-15.49	4.12	3	Vertical	22	1.03	-
5240MHz	Pass	AV	5.149995G	46.76	54.00	-7.24	3.68	3	Horizontal	125	1.02	-
5240MHz	Pass	AV	5.2388G	100.42	Inf	-Inf	3.84	3	Horizontal	125	1.02	-
5240MHz	Pass	AV	5.3612G	47.32	54.00	-6.68	4.07	3	Horizontal	125	1.02	-
5240MHz	Pass	PK	5.1494G	57.83	74.00	-16.17	3.68	3	Horizontal	125	1.02	-
5240MHz	Pass	PK	5.24G	109.15	Inf	-Inf	3.85	3	Horizontal	125	1.02	-
5240MHz	Pass	PK	5.3894G	58.41	74.00	-15.59	4.12	3	Horizontal	125	1.02	-
5240MHz	Pass	AV	10.465G	45.55	54.00	-8.45	14.53	3	Vertical	305	2.16	-
5240MHz	Pass	PK	10.48216G	57.18	74.00	-16.82	14.56	3	Vertical	305	2.16	-
5240MHz	Pass	AV	10.4656G	45.55	54.00	-8.45	14.53	3	Horizontal	20	1.51	-
5240MHz	Pass	PK	10.47202G	57.33	74.00	-16.67	14.54	3	Horizontal	20	1.51	-
5745MHz	Pass	AV	5.7462G	97.84	Inf	-Inf	4.70	3	Vertical	21	2.16	-
5745MHz	Pass	PK	5.625G	58.51	68.20	-9.69	4.51	3	Vertical	21	2.16	-
5745MHz	Pass	PK	5.7474G	106.26	Inf	-Inf	4.71	3	Vertical	21	2.16	-
5745MHz	Pass	PK	5.9274G	58.74	68.20	-9.46	4.99	3	Vertical	21	2.16	-
5745MHz	Pass	AV	5.7462G	101.20	Inf	-Inf	4.70	3	Horizontal	353	2.35	-
5745MHz	Pass	PK	5.643G	58.73	68.20	-9.47	4.54	3	Horizontal	353	2.35	-
5745MHz	Pass	PK	5.745G	109.35	Inf	-Inf	4.70	3	Horizontal	353	2.35	-
5745MHz	Pass	PK	5.955G	59.08	68.20	-9.12	5.03	3	Horizontal	353	2.35	-
5745MHz	Pass	AV	11.49276G	45.81	54.00	-8.19	15.05	3	Vertical	356	3.14	-
5745MHz	Pass	PK	11.48322G	57.46	74.00	-16.54	15.06	3	Vertical	356	3.14	-
5745MHz	Pass	AV	11.48742G	45.23	54.00	-8.77	15.05	3	Horizontal	148	2.07	-
5745MHz	Pass	PK	11.50254G	56.60	74.00	-17.40	15.04	3	Horizontal	148	2.07	-
5785MHz	Pass	AV	5.7862G	97.79	Inf	-Inf	4.77	3	Vertical	30	2.36	-
5785MHz	Pass	PK	5.5618G	59.31	68.20	-8.89	4.41	3	Vertical	30	2.36	-
5785MHz	Pass	PK	5.7862G	105.83	Inf	-Inf	4.77	3	Vertical	30	2.36	-
5785MHz	Pass	PK	5.953G	59.33	68.20	-8.87	5.02	3	Vertical	30	2.36	-
5785MHz	Pass	AV	5.7862G	100.71	Inf	-Inf	4.77	3	Horizontal	354	2.18	-
5785MHz	Pass	PK	5.6482G	58.94	68.20	-9.26	4.55	3	Horizontal	354	2.18	-
5785MHz	Pass	PK	5.7862G	108.81	Inf	-Inf	4.77	3	Horizontal	354	2.18	-
5785MHz	Pass	PK	5.9482G	58.55	68.20	-9.65	5.03	3	Horizontal	354	2.18	-
5785MHz	Pass	AV	11.57858G	45.08	54.00	-8.92	14.95	3	Vertical	14	3.03	-
5785MHz	Pass	PK	11.57324G	56.75	74.00	-17.25	14.96	3	Vertical	14	3.03	-
5785MHz	Pass	AV	11.57606G	45.07	54.00	-8.93	14.95	3	Horizontal	150	2.10	-
5785MHz	Pass	PK	11.58014G	57.01	74.00	-16.99	14.95	3	Horizontal	150	2.10	-
5825MHz	Pass	AV	5.8238G	97.47	Inf	-Inf	4.83	3	Vertical	29	2.08	-
5825MHz	Pass	PK	5.5442G	58.59	68.20	-9.61	4.39	3	Vertical	29	2.08	-
5825MHz	Pass	PK	5.8238G	105.41	Inf	-Inf	4.83	3	Vertical	29	2.08	-
5825MHz	Pass	PK	5.9354G	58.40	68.20	-9.80	5.00	3	Vertical	29	2.08	-



RSE TX above 1GHz Result

Appendix E.4

Mode	Result	Type	Freq (Hz)	Level (dBuV/m)	Limit (dBuV/m)	Margin (dB)	Factor (dB)	Dist (m)	Condition	Azimuth (°)	Height (m)	Comments
5825MHz	Pass	AV	5.8238G	97.96	Inf	-Inf	4.83	3	Horizontal	1	1.50	-
5825MHz	Pass	PK	5.585G	59.37	68.20	-8.83	4.44	3	Horizontal	1	1.50	-
5825MHz	Pass	PK	5.825G	105.64	Inf	-Inf	4.83	3	Horizontal	1	1.50	-
5825MHz	Pass	PK	5.9438G	59.77	68.20	-8.43	5.02	3	Horizontal	1	1.50	-
5825MHz	Pass	AV	11.66488G	45.18	54.00	-8.82	14.85	3	Vertical	38	2.23	-
5825MHz	Pass	PK	11.66494G	57.34	74.00	-16.66	14.85	3	Vertical	38	2.23	-
5825MHz	Pass	AV	11.66044G	45.03	54.00	-8.97	14.85	3	Horizontal	278	1.50	-
5825MHz	Pass	PK	11.65594G	56.97	74.00	-17.03	14.86	3	Horizontal	278	1.50	-
802.11n HT40_Nss1,(MCS0)_1TX	-	-	-	-	-	-	-	-	-	-	-	-
5190MHz	Pass	AV	5.149995G	50.10	54.00	-3.90	3.68	3	Vertical	81	3.17	-
5190MHz	Pass	AV	5.1884G	91.18	Inf	-Inf	3.75	3	Vertical	81	3.17	-
5190MHz	Pass	PK	5.1496G	62.66	74.00	-11.34	3.68	3	Vertical	81	3.17	-
5190MHz	Pass	PK	5.1884G	99.13	Inf	-Inf	3.75	3	Vertical	81	3.17	-
5190MHz	Pass	AV	5.149995G	53.29	54.00	-0.71	3.68	3	Horizontal	133	1.03	-
5190MHz	Pass	AV	5.1912G	93.25	Inf	-Inf	3.75	3	Horizontal	133	1.03	-
5190MHz	Pass	PK	5.148G	69.02	74.00	-4.98	3.68	3	Horizontal	133	1.03	-
5190MHz	Pass	PK	5.1924G	101.22	Inf	-Inf	3.76	3	Horizontal	133	1.03	-
5190MHz	Pass	AV	10.36968G	47.34	54.00	-6.66	14.33	3	Vertical	5	1.50	-
5190MHz	Pass	PK	10.39188G	58.74	74.00	-15.26	14.38	3	Vertical	5	1.50	-
5190MHz	Pass	AV	10.36584G	47.34	54.00	-6.66	14.33	3	Horizontal	171	1.05	-
5190MHz	Pass	PK	10.36584G	58.04	74.00	-15.96	14.33	3	Horizontal	171	1.05	-
5230MHz	Pass	AV	5.149995G	47.60	54.00	-6.40	3.68	3	Vertical	50	2.80	-
5230MHz	Pass	AV	5.2288G	92.40	Inf	-Inf	3.82	3	Vertical	50	2.80	-
5230MHz	Pass	PK	5.1472G	58.67	74.00	-15.33	3.68	3	Vertical	50	2.80	-
5230MHz	Pass	PK	5.228G	100.09	Inf	-Inf	3.82	3	Vertical	50	2.80	-
5230MHz	Pass	AV	5.149995G	48.66	54.00	-5.34	3.68	3	Horizontal	141	1.15	-
5230MHz	Pass	AV	5.2312G	95.81	Inf	-Inf	3.83	3	Horizontal	141	1.15	-
5230MHz	Pass	PK	5.1472G	60.09	74.00	-13.91	3.68	3	Horizontal	141	1.15	-
5230MHz	Pass	PK	5.2272G	103.59	Inf	-Inf	3.82	3	Horizontal	141	1.15	-
5230MHz	Pass	AV	10.44638G	45.29	54.00	-8.71	14.49	3	Vertical	5	1.50	-
5230MHz	Pass	PK	10.4624G	58.18	74.00	-15.82	14.52	3	Vertical	5	1.50	-
5230MHz	Pass	AV	10.44596G	45.38	54.00	-8.62	14.49	3	Horizontal	104	2.76	-
5230MHz	Pass	PK	10.44746G	57.80	74.00	-16.20	14.49	3	Horizontal	104	2.76	-
5755MHz	Pass	AV	5.7562G	95.04	Inf	-Inf	4.72	3	Vertical	32	2.38	-
5755MHz	Pass	PK	5.6314G	58.88	68.20	-9.32	4.52	3	Vertical	32	2.38	-
5755MHz	Pass	PK	5.7562G	103.41	Inf	-Inf	4.72	3	Vertical	32	2.38	-
5755MHz	Pass	PK	5.9866G	58.48	68.20	-9.72	5.07	3	Vertical	32	2.38	-
5755MHz	Pass	AV	5.7538G	96.83	Inf	-Inf	4.72	3	Horizontal	4	1.82	-
5755MHz	Pass	PK	5.6386G	58.90	68.20	-9.30	4.53	3	Horizontal	4	1.82	-
5755MHz	Pass	PK	5.7538G	104.28	Inf	-Inf	4.72	3	Horizontal	4	1.82	-
5755MHz	Pass	PK	5.9446G	58.67	68.20	-9.53	5.02	3	Horizontal	4	1.82	-
5755MHz	Pass	AV	11.49872G	44.53	54.00	-9.47	15.04	3	Vertical	133	1.52	-
5755MHz	Pass	PK	11.49518G	56.83	74.00	-17.17	15.05	3	Vertical	133	1.52	-
5755MHz	Pass	AV	11.50154G	44.48	54.00	-9.52	15.04	3	Horizontal	302	2.07	-
5755MHz	Pass	PK	11.50238G	56.38	74.00	-17.62	15.04	3	Horizontal	302	2.07	-
5795MHz	Pass	AV	5.7938G	94.22	Inf	-Inf	4.78	3	Vertical	29	2.49	-
5795MHz	Pass	PK	5.5526G	58.21	68.20	-9.99	4.39	3	Vertical	29	2.49	-
5795MHz	Pass	PK	5.7902G	101.60	Inf	-Inf	4.77	3	Vertical	29	2.49	-
5795MHz	Pass	PK	5.963G	58.24	68.20	-9.96	5.05	3	Vertical	29	2.49	-



RSE TX above 1GHz Result

Appendix E.4

Mode	Result	Type	Freq (Hz)	Level (dBuV/m)	Limit (dBuV/m)	Margin (dB)	Factor (dB)	Dist (m)	Condition	Azimuth (°)	Height (m)	Comments
5795MHz	Pass	AV	5.7938G	97.13	Inf	-Inf	4.78	3	Horizontal	356	2.13	-
5795MHz	Pass	PK	5.633G	58.98	68.20	-9.22	4.53	3	Horizontal	356	2.13	-
5795MHz	Pass	PK	5.7974G	105.18	Inf	-Inf	4.79	3	Horizontal	356	2.13	-
5795MHz	Pass	PK	5.9306G	59.67	68.20	-8.53	4.99	3	Horizontal	356	2.13	-
5795MHz	Pass	AV	11.60008G	44.64	54.00	-9.36	14.92	3	Vertical	130	1.49	-
5795MHz	Pass	PK	11.59732G	56.72	74.00	-17.28	14.93	3	Vertical	130	1.49	-
5795MHz	Pass	AV	11.59804G	44.71	54.00	-9.29	14.93	3	Horizontal	300	2.08	-
5795MHz	Pass	PK	11.60092G	56.94	74.00	-17.06	14.92	3	Horizontal	300	2.08	-

802.11a_Nss1,(6Mbps)_1TX

5180MHz_TX

17/06/2018

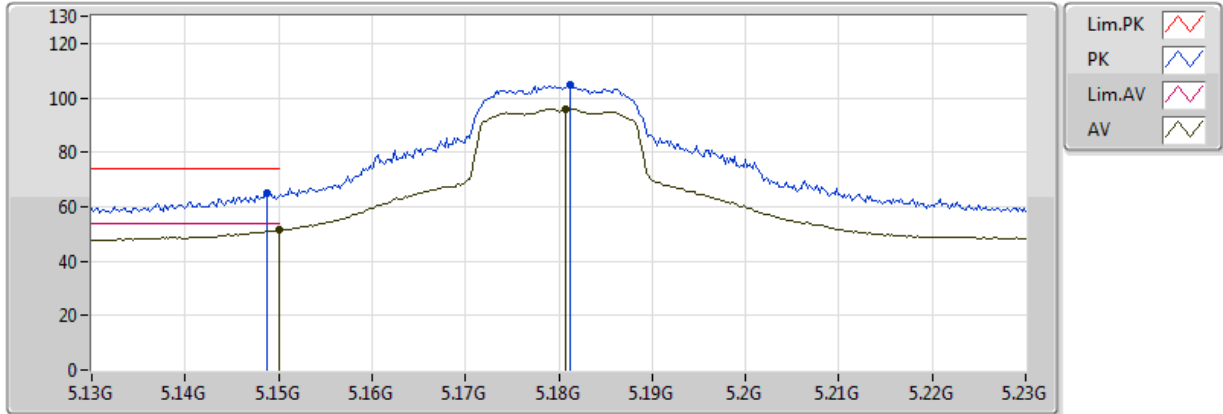

Type	Freq (Hz)	Level (dBuV/m)	Limit (dBuV/m)	Margin (dB)	Factor (dB)	Dist (m)	Condition	Azimuth (°)	Height (m)	Comments
AV	5.149995G	51.51	54.00	-2.49	3.68	3	Vertical	65	3.17	-
AV	5.1808G	96.09	Inf	-Inf	3.74	3	Vertical	65	3.17	-
PK	5.1488G	65.24	74.00	-8.76	3.68	3	Vertical	65	3.17	-
PK	5.1812G	104.86	Inf	-Inf	3.74	3	Vertical	65	3.17	-

802.11a_Nss1,(6Mbps)_1TX

5180MHz_TX

17/06/2018

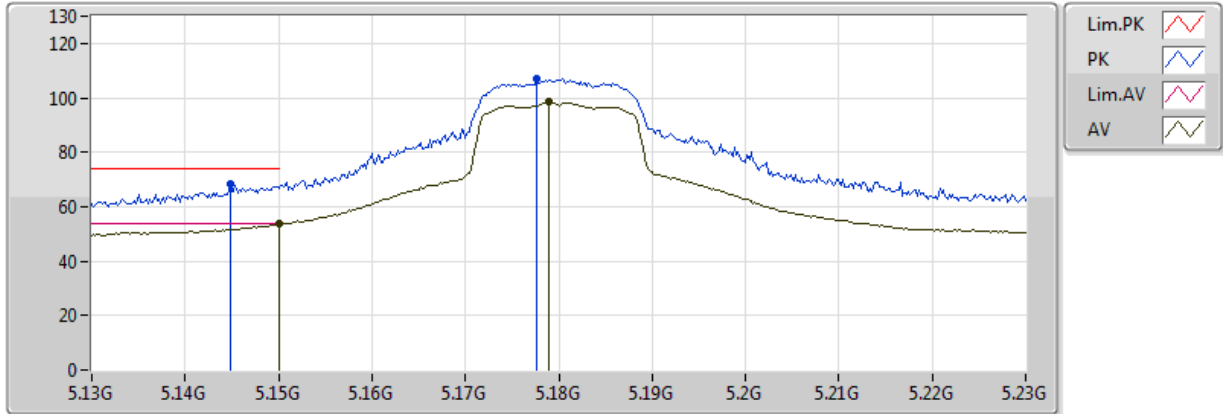





Type	Freq (Hz)	Level (dBuV/m)	Limit (dBuV/m)	Margin (dB)	Factor (dB)	Dist (m)	Condition	Azimuth (°)	Height (m)	Comments
AV	5.149995G	53.69	54.00	-0.31	3.68	3	Horizontal	146	1.06	-
AV	5.179G	98.39	Inf	-Inf	3.73	3	Horizontal	146	1.06	-
PK	5.1448G	68.46	74.00	-5.54	3.67	3	Horizontal	146	1.06	-
PK	5.1776G	107.00	Inf	-Inf	3.73	3	Horizontal	146	1.06	-

802.11a_Nss1,(6Mbps)_1TX

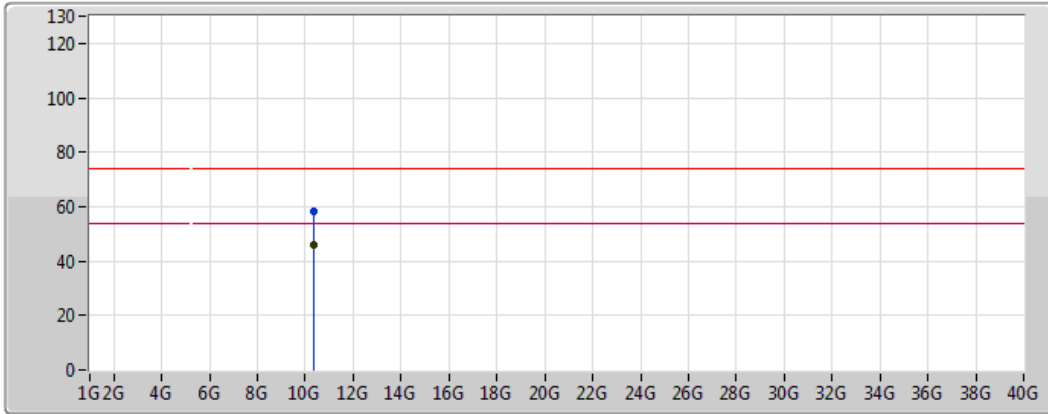
5180MHz_TX

17/06/2018



Lim.PK	
PK	
Lim.AV	
AV	

Type	Freq (Hz)	Level (dBuV/m)	Limit (dBuV/m)	Margin (dB)	Factor (dB)	Dist (m)	Condition	Azimuth (°)	Height (m)	Comments
AV	10.37128G	46.06	54.00	-7.94	14.34	3	Vertical	343	1.03	-
PK	10.36312G	58.29	74.00	-15.71	14.32	3	Vertical	343	1.03	-

802.11a_Nss1,(6Mbps)_1TX

5180MHz_TX

17/06/2018

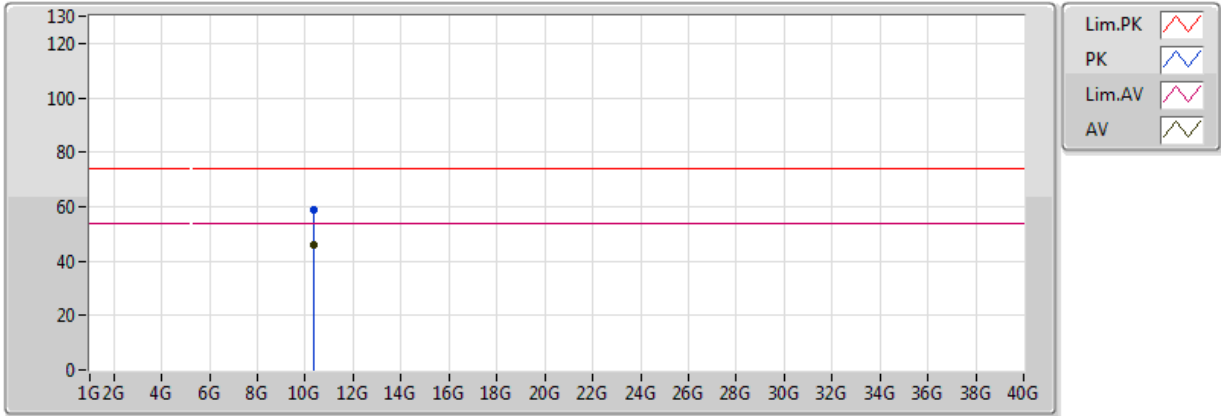

Type	Freq (Hz)	Level (dBuV/m)	Limit (dBuV/m)	Margin (dB)	Factor (dB)	Dist (m)	Condition	Azimuth (°)	Height (m)	Comments
AV	10.3642G	46.02	54.00	-7.98	14.32	3	Horizontal	154	1.90	-
PK	10.35766G	58.58	74.00	-15.42	14.31	3	Horizontal	154	1.90	-

802.11a_Nss1,(6Mbps)_1TX

5200MHz_TX

17/06/2018

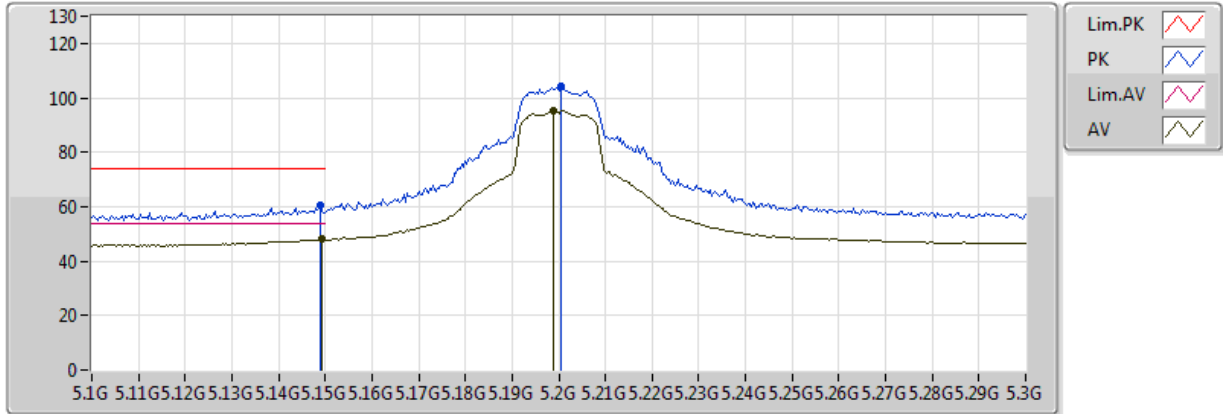

Type	Freq (Hz)	Level (dBuV/m)	Limit (dBuV/m)	Margin (dB)	Factor (dB)	Dist (m)	Condition	Azimuth (°)	Height (m)	Comments
AV	5.1492G	47.98	54.00	-6.02	3.68	3	Vertical	44	2.84	-
AV	5.1988G	95.37	Inf	-Inf	3.77	3	Vertical	44	2.84	-
PK	5.1488G	60.31	74.00	-13.69	3.68	3	Vertical	44	2.84	-
PK	5.2004G	103.98	Inf	-Inf	3.77	3	Vertical	44	2.84	-

802.11a_Nss1,(6Mbps)_1TX

5200MHz_TX

17/06/2018

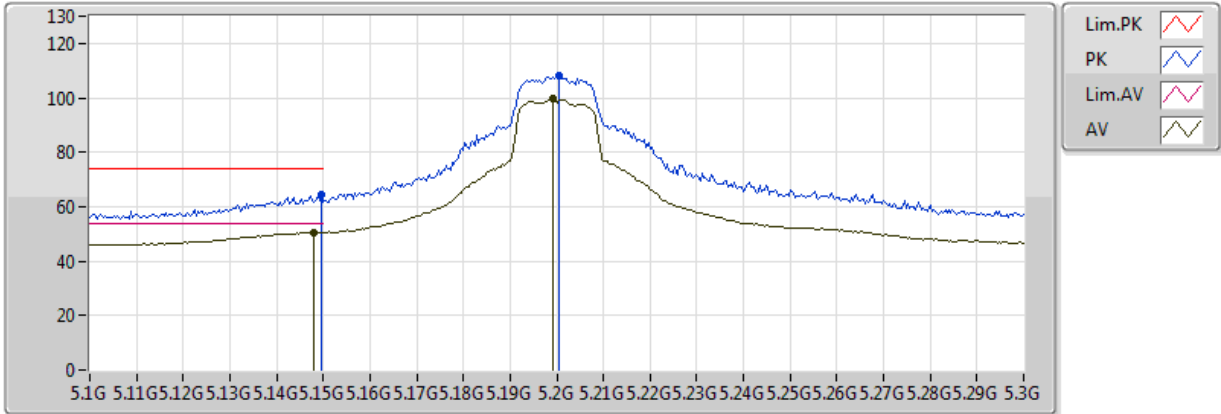

Type	Freq (Hz)	Level (dBuV/m)	Limit (dBuV/m)	Margin (dB)	Factor (dB)	Dist (m)	Condition	Azimuth (°)	Height (m)	Comments
AV	5.148G	50.52	54.00	-3.48	3.68	3	Horizontal	128	1.01	-
AV	5.1992G	99.53	Inf	-Inf	3.77	3	Horizontal	128	1.01	-
PK	5.1496G	64.22	74.00	-9.78	3.68	3	Horizontal	128	1.01	-
PK	5.2004G	107.98	Inf	-Inf	3.77	3	Horizontal	128	1.01	-

802.11a_Nss1,(6Mbps)_1TX

5200MHz_TX

17/06/2018

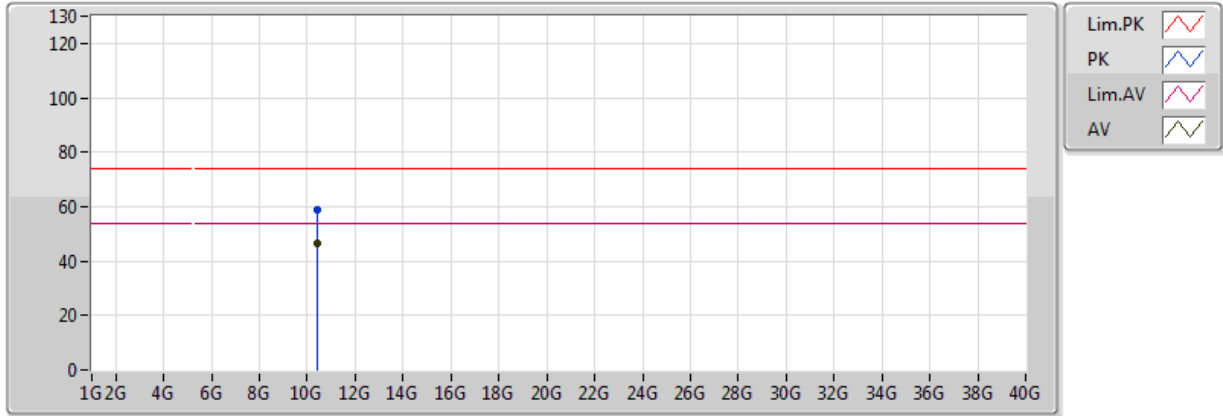





Type	Freq (Hz)	Level (dBuV/m)	Limit (dBuV/m)	Margin (dB)	Factor (dB)	Dist (m)	Condition	Azimuth (°)	Height (m)	Comments
AV	10.39898G	46.75	54.00	-7.25	14.39	3	Vertical	109	2.47	-
PK	10.39682G	58.70	74.00	-15.30	14.39	3	Vertical	109	2.47	-

802.11a_Nss1,(6Mbps)_1TX

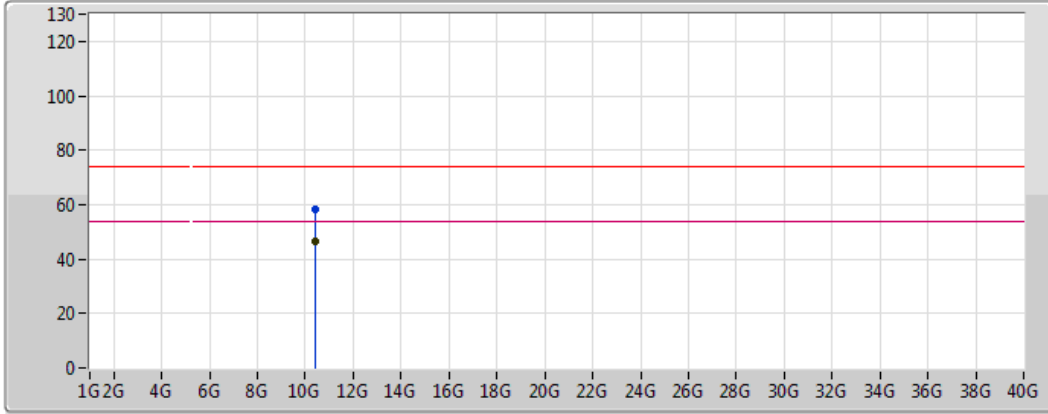
5200MHz_TX

17/06/2018



Lim.PK	
PK	
Lim.AV	
AV	

Type	Freq (Hz)	Level (dBuV/m)	Limit (dBuV/m)	Margin (dB)	Factor (dB)	Dist (m)	Condition	Azimuth (°)	Height (m)	Comments
AV	10.39406G	46.26	54.00	-7.74	14.38	3	Horizontal	15	2.23	-
PK	10.3865G	58.51	74.00	-15.49	14.37	3	Horizontal	15	2.23	-

802.11a_Nss1,(6Mbps)_1TX

5240MHz_TX

17/06/2018

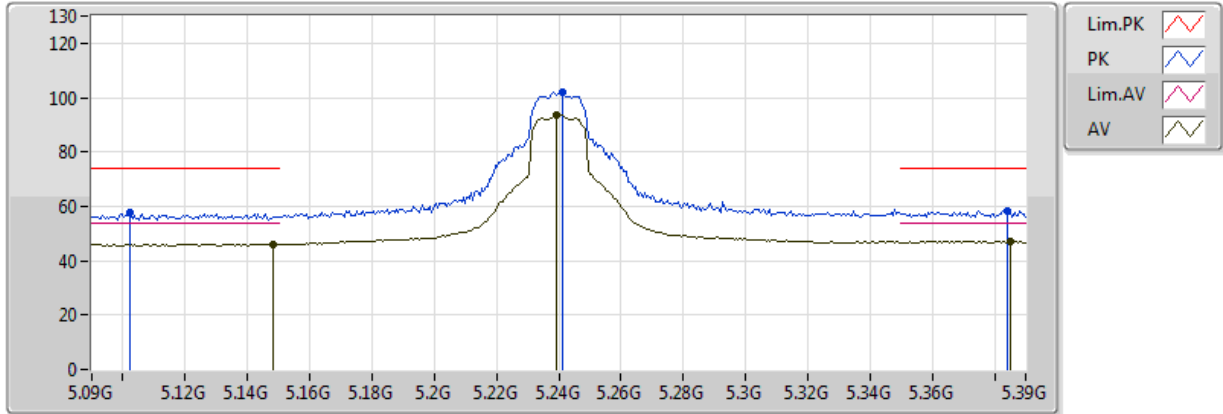

Type	Freq (Hz)	Level (dBuV/m)	Limit (dBuV/m)	Margin (dB)	Factor (dB)	Dist (m)	Condition	Azimuth (°)	Height (m)	Comments
AV	5.1482G	46.08	54.00	-7.92	3.68	3	Vertical	32	1.01	-
AV	5.2394G	93.61	Inf	-Inf	3.84	3	Vertical	32	1.01	-
AV	5.3852G	47.14	54.00	-6.86	4.11	3	Vertical	32	1.01	-
PK	5.102G	57.58	74.00	-16.42	3.59	3	Vertical	32	1.01	-
PK	5.2412G	102.06	Inf	-Inf	3.85	3	Vertical	32	1.01	-
PK	5.384G	58.17	74.00	-15.83	4.11	3	Vertical	32	1.01	-

802.11a_Nss1,(6Mbps)_1TX

5240MHz_TX

17/06/2018

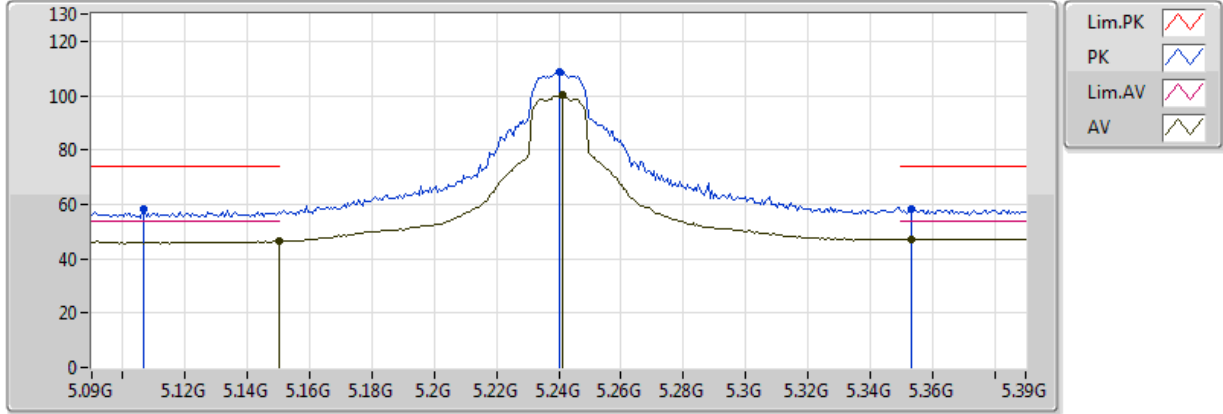





Type	Freq (Hz)	Level (dBuV/m)	Limit (dBuV/m)	Margin (dB)	Factor (dB)	Dist (m)	Condition	Azimuth (°)	Height (m)	Comments
AV	5.149995G	46.28	54.00	-7.72	3.68	3	Horizontal	148	1.11	-
AV	5.2412G	100.08	Inf	-Inf	3.85	3	Horizontal	148	1.11	-
AV	5.3534G	47.32	54.00	-6.68	4.05	3	Horizontal	148	1.11	-
PK	5.1068G	58.24	74.00	-15.76	3.60	3	Horizontal	148	1.11	-
PK	5.24G	108.75	Inf	-Inf	3.85	3	Horizontal	148	1.11	-
PK	5.3534G	58.03	74.00	-15.97	4.05	3	Horizontal	148	1.11	-

802.11a_Nss1,(6Mbps)_1TX

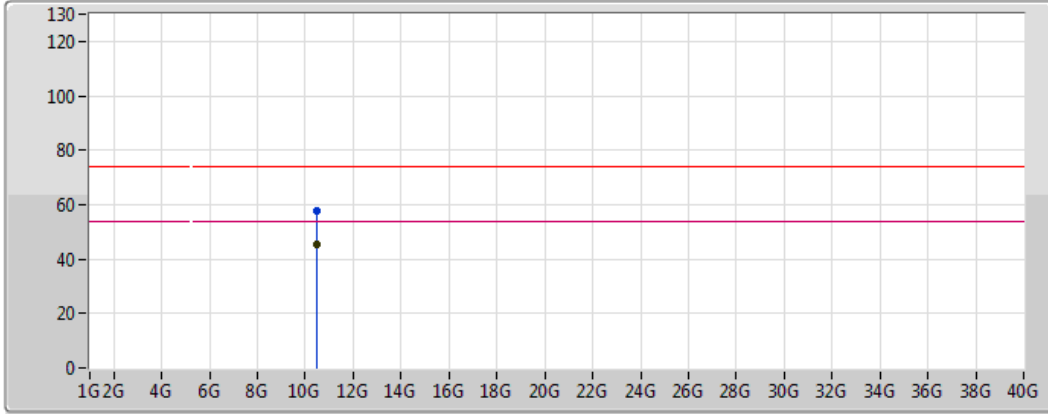
5240MHz_TX

17/06/2018



Lim.PK	
PK	
Lim.AV	
AV	

Type	Freq (Hz)	Level (dBuV/m)	Limit (dBuV/m)	Margin (dB)	Factor (dB)	Dist (m)	Condition	Azimuth (°)	Height (m)	Comments
AV	10.47394G	45.41	54.00	-8.59	14.55	3	Vertical	221	1.05	-
PK	10.48078G	57.51	74.00	-16.49	14.56	3	Vertical	221	1.05	-

802.11a_Nss1,(6Mbps)_1TX

5240MHz_TX

17/06/2018

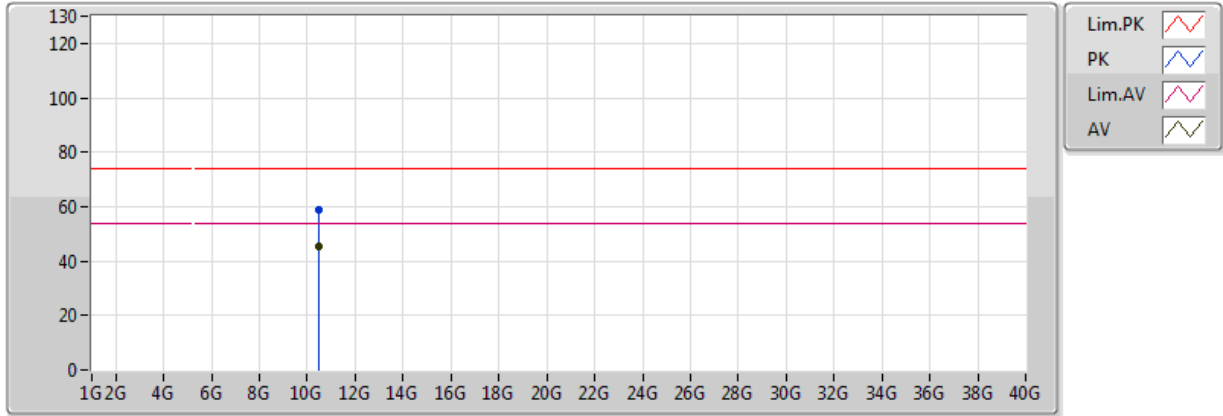

Type	Freq (Hz)	Level (dBuV/m)	Limit (dBuV/m)	Margin (dB)	Factor (dB)	Dist (m)	Condition	Azimuth (°)	Height (m)	Comments
AV	10.47478G	45.25	54.00	-8.75	14.55	3	Horizontal	6	1.45	-
PK	10.46992G	58.61	74.00	-15.39	14.54	3	Horizontal	6	1.45	-

802.11a_Nss1,(6Mbps)_1TX

5745MHz_TX

17/06/2018

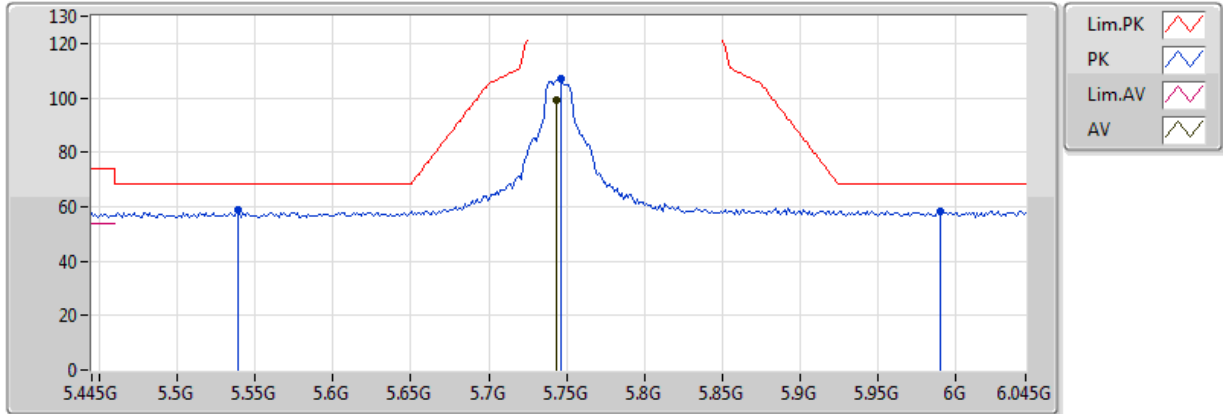

Type	Freq (Hz)	Level (dBuV/m)	Limit (dBuV/m)	Margin (dB)	Factor (dB)	Dist (m)	Condition	Azimuth (°)	Height (m)	Comments
AV	5.7438G	99.17	Inf	-Inf	4.70	3	Vertical	31	2.53	-
PK	5.5386G	58.72	68.20	-9.48	4.38	3	Vertical	31	2.53	-
PK	5.7462G	106.97	Inf	-Inf	4.70	3	Vertical	31	2.53	-
PK	5.9898G	58.53	68.20	-9.67	5.09	3	Vertical	31	2.53	-

802.11a_Nss1,(6Mbps)_1TX

5745MHz_TX

17/06/2018

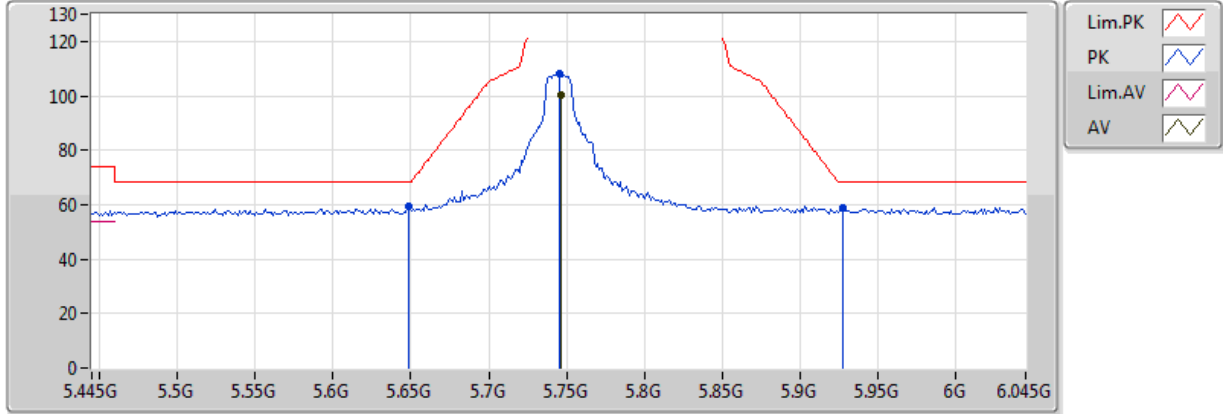





Type	Freq (Hz)	Level (dBuV/m)	Limit (dBuV/m)	Margin (dB)	Factor (dB)	Dist (m)	Condition	Azimuth (°)	Height (m)	Comments
AV	5.7462G	100.45	Inf	-Inf	4.70	3	Horizontal	10	2.26	-
PK	5.649G	59.52	68.20	-8.68	4.55	3	Horizontal	10	2.26	-
PK	5.745G	108.34	Inf	-Inf	4.70	3	Horizontal	10	2.26	-
PK	5.9274G	58.76	68.20	-9.44	4.99	3	Horizontal	10	2.26	-

802.11a_Nss1,(6Mbps)_1TX

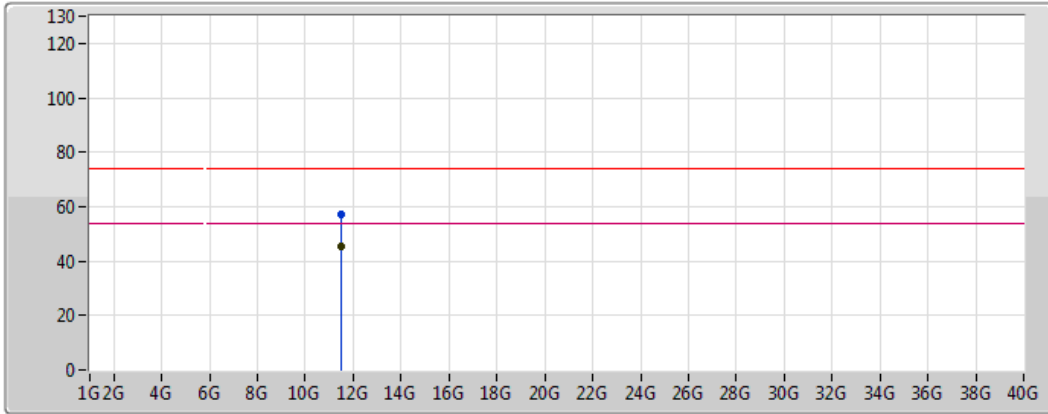
5745MHz_TX

17/06/2018



Lim.PK	
PK	
Lim.AV	
AV	





Type	Freq (Hz)	Level (dBuV/m)	Limit (dBuV/m)	Margin (dB)	Factor (dB)	Dist (m)	Condition	Azimuth (°)	Height (m)	Comments
AV	11.49018G	45.52	54.00	-8.48	15.05	3	Vertical	218	1.96	-
PK	11.49156G	57.04	74.00	-16.96	15.05	3	Vertical	218	1.96	-

802.11a_Nss1,(6Mbps)_1TX

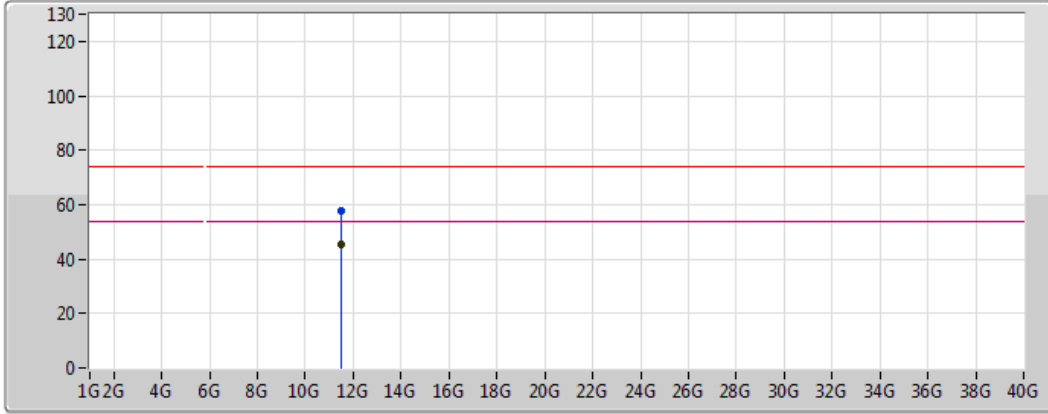
5745MHz_TX

17/06/2018



Lim.PK	
PK	
Lim.AV	
AV	

Type	Freq (Hz)	Level (dBuV/m)	Limit (dBuV/m)	Margin (dB)	Factor (dB)	Dist (m)	Condition	Azimuth (°)	Height (m)	Comments
AV	11.49144G	45.33	54.00	-8.67	15.05	3	Horizontal	149	1.50	-
PK	11.47722G	57.56	74.00	-16.44	15.07	3	Horizontal	149	1.50	-

802.11a_Nss1,(6Mbps)_1TX

5785MHz_TX

17/06/2018

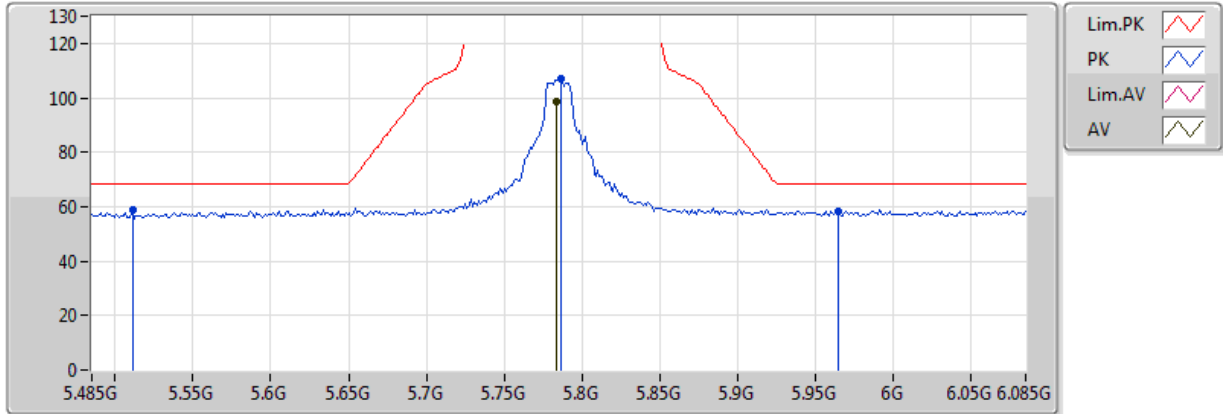

Type	Freq (Hz)	Level (dBuV/m)	Limit (dBuV/m)	Margin (dB)	Factor (dB)	Dist (m)	Condition	Azimuth (°)	Height (m)	Comments
AV	5.7838G	98.74	Inf	-Inf	4.76	3	Vertical	30	2.49	-
PK	5.5114G	58.80	68.20	-9.40	4.34	3	Vertical	30	2.49	-
PK	5.7862G	106.90	Inf	-Inf	4.77	3	Vertical	30	2.49	-
PK	5.965G	58.50	68.20	-9.70	5.05	3	Vertical	30	2.49	-

802.11a_Nss1,(6Mbps)_1TX

5785MHz_TX

17/06/2018

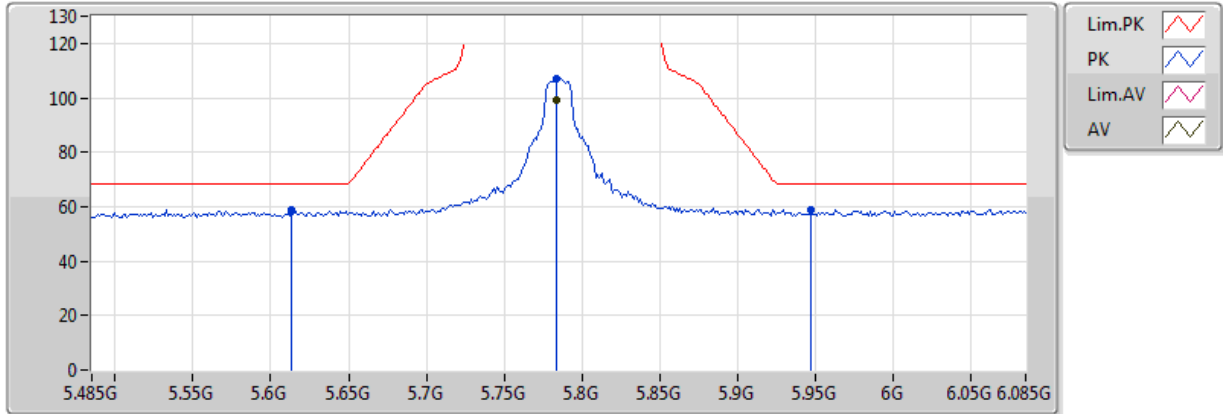





Type	Freq (Hz)	Level (dBuV/m)	Limit (dBuV/m)	Margin (dB)	Factor (dB)	Dist (m)	Condition	Azimuth (°)	Height (m)	Comments
AV	5.7838G	99.32	Inf	-Inf	4.76	3	Horizontal	9	1.49	-
PK	5.6134G	59.00	68.20	-9.20	4.50	3	Horizontal	9	1.49	-
PK	5.7838G	107.23	Inf	-Inf	4.76	3	Horizontal	9	1.49	-
PK	5.947G	59.03	68.20	-9.17	5.03	3	Horizontal	9	1.49	-

802.11a_Nss1,(6Mbps)_1TX

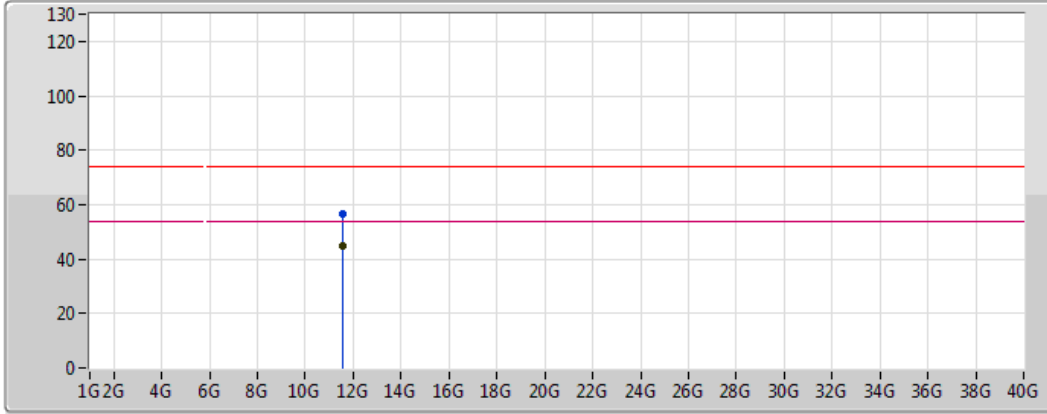
5785MHz_TX

17/06/2018



Lim.PK	
PK	
Lim.AV	
AV	

Type	Freq (Hz)	Level (dBuV/m)	Limit (dBuV/m)	Margin (dB)	Factor (dB)	Dist (m)	Condition	Azimuth (°)	Height (m)	Comments
AV	11.58476G	44.86	54.00	-9.14	14.94	3	Vertical	57	1.78	-
PK	11.55776G	56.33	74.00	-17.67	14.97	3	Vertical	57	1.78	-

802.11a_Nss1,(6Mbps)_1TX

5785MHz_TX

17/06/2018

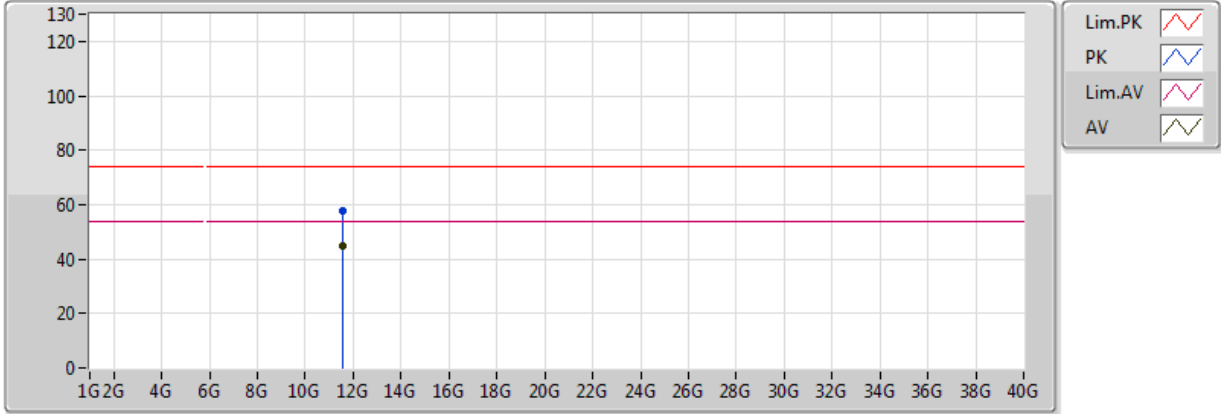

Type	Freq (Hz)	Level (dBuV/m)	Limit (dBuV/m)	Margin (dB)	Factor (dB)	Dist (m)	Condition	Azimuth (°)	Height (m)	Comments
AV	11.582G	45.10	54.00	-8.90	14.94	3	Horizontal	151	1.32	-
PK	11.57384G	57.71	74.00	-16.29	14.95	3	Horizontal	151	1.32	-

802.11a_Nss1,(6Mbps)_1TX

5825MHz_TX

17/06/2018

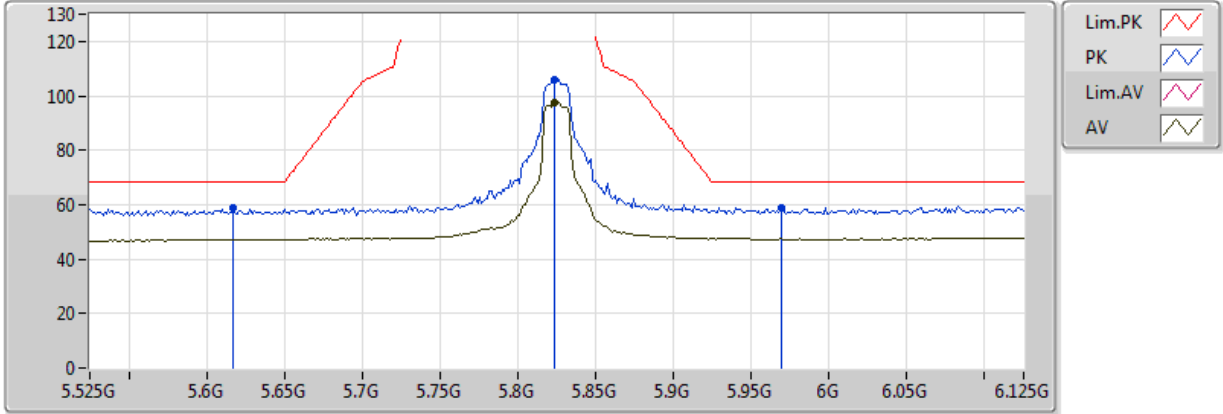

Type	Freq (Hz)	Level (dBuV/m)	Limit (dBuV/m)	Margin (dB)	Factor (dB)	Dist (m)	Condition	Azimuth (°)	Height (m)	Comments
AV	5.8238G	97.66	Inf	-Inf	4.83	3	Vertical	27	2.47	-
PK	5.6174G	58.93	68.20	-9.27	4.49	3	Vertical	27	2.47	-
PK	5.8238G	106.04	Inf	-Inf	4.83	3	Vertical	27	2.47	-
PK	5.9699G	58.75	68.20	-9.45	5.06	3	Vertical	27	2.47	-

802.11a_Nss1,(6Mbps)_1TX

5825MHz_TX

17/06/2018

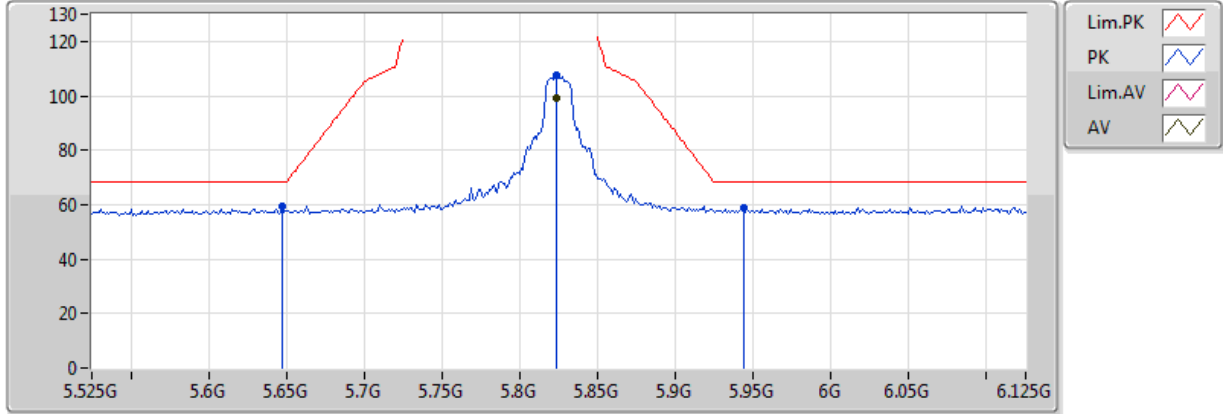





Type	Freq (Hz)	Level (dBuV/m)	Limit (dBuV/m)	Margin (dB)	Factor (dB)	Dist (m)	Condition	Azimuth (°)	Height (m)	Comments
AV	5.8238G	99.39	Inf	-Inf	4.83	3	Horizontal	141	1.01	-
PK	5.6474G	59.29	68.20	-8.91	4.55	3	Horizontal	141	1.01	-
PK	5.8238G	107.33	Inf	-Inf	4.83	3	Horizontal	141	1.01	-
PK	5.9438G	58.79	68.20	-9.41	5.02	3	Horizontal	141	1.01	-

802.11a_Nss1,(6Mbps)_1TX

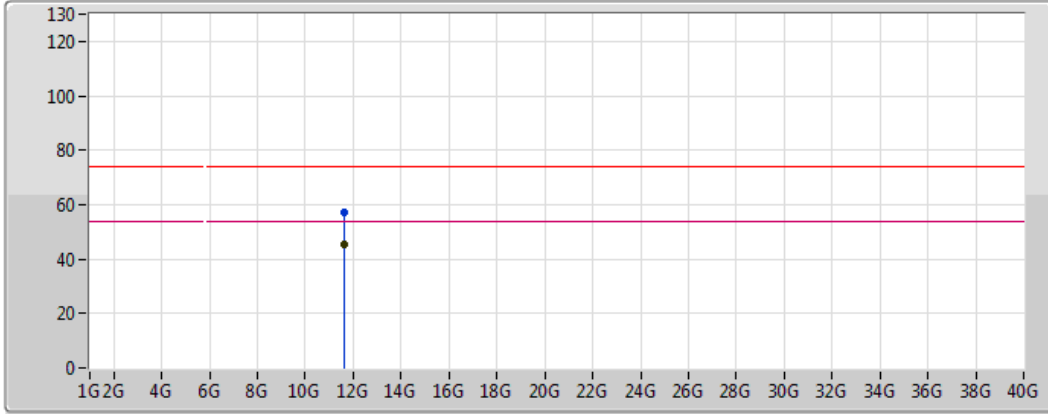
5825MHz_TX

17/06/2018



Lim.PK	
PK	
Lim.AV	
AV	





Type	Freq (Hz)	Level (dBuV/m)	Limit (dBuV/m)	Margin (dB)	Factor (dB)	Dist (m)	Condition	Azimuth (°)	Height (m)	Comments
AV	11.64826G	45.62	54.00	-8.38	14.87	3	Vertical	2	3.17	-
PK	11.64634G	57.32	74.00	-16.68	14.87	3	Vertical	2	3.17	-

802.11a_Nss1,(6Mbps)_1TX

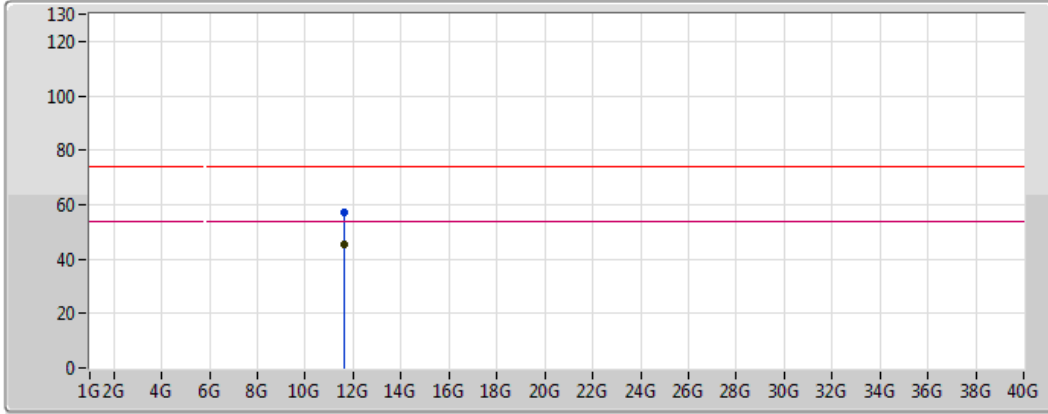
5825MHz_TX

17/06/2018



Lim.PK	
PK	
Lim.AV	
AV	

Type	Freq (Hz)	Level (dBuV/m)	Limit (dBuV/m)	Margin (dB)	Factor (dB)	Dist (m)	Condition	Azimuth (°)	Height (m)	Comments
AV	11.64598G	45.42	54.00	-8.58	14.87	3	Horizontal	172	1.50	-
PK	11.65006G	57.24	74.00	-16.76	14.87	3	Horizontal	172	1.50	-

802.11n HT20_Nss1,(MCS0)_1TX

5180MHz_TX

18/06/2018

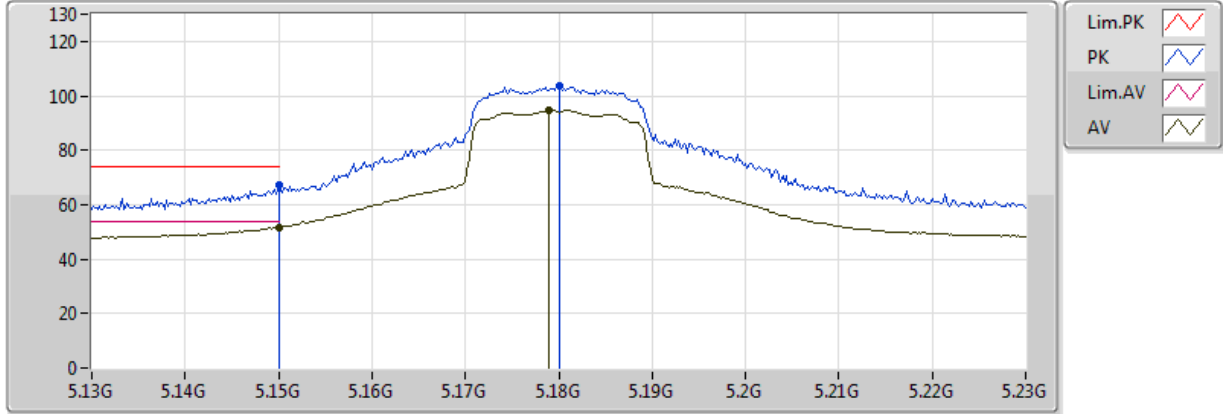

Type	Freq (Hz)	Level (dBuV/m)	Limit (dBuV/m)	Margin (dB)	Factor (dB)	Dist (m)	Condition	Azimuth (°)	Height (m)	Comments
AV	5.149995G	51.64	54.00	-2.36	3.68	3	Vertical	69	2.23	-
AV	5.179G	94.78	Inf	-Inf	3.73	3	Vertical	69	2.23	-
PK	5.149995G	67.34	74.00	-6.66	3.68	3	Vertical	69	2.23	-
PK	5.18G	103.80	Inf	-Inf	3.73	3	Vertical	69	2.23	-

802.11n HT20_Nss1,(MCS0)_1TX

5180MHz_TX

18/06/2018

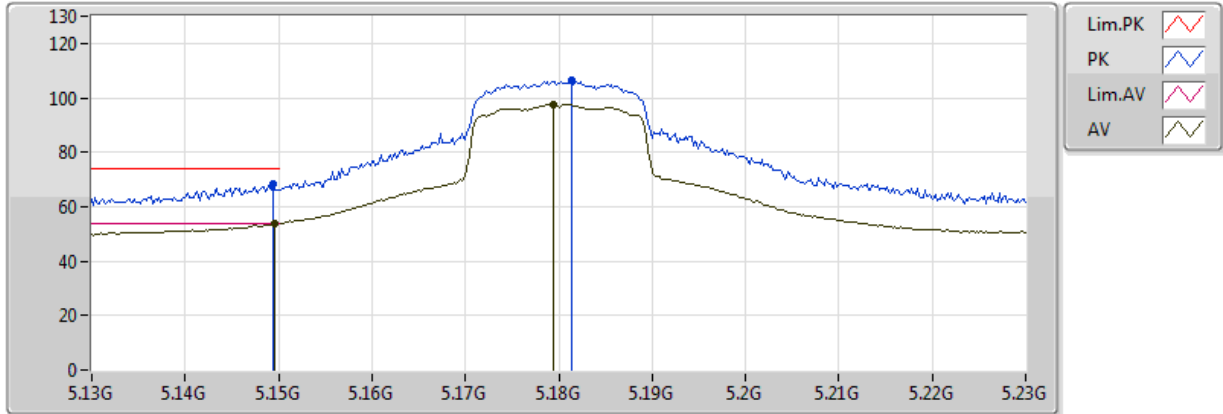





Type	Freq (Hz)	Level (dBuV/m)	Limit (dBuV/m)	Margin (dB)	Factor (dB)	Dist (m)	Condition	Azimuth (°)	Height (m)	Comments
AV	5.1496G	53.86	54.00	-0.14	3.68	3	Horizontal	141	1.06	-
AV	5.1794G	97.78	Inf	-Inf	3.73	3	Horizontal	141	1.06	-
PK	5.1494G	68.29	74.00	-5.71	3.68	3	Horizontal	141	1.06	-
PK	5.1814G	106.28	Inf	-Inf	3.74	3	Horizontal	141	1.06	-

802.11n HT20_Nss1,(MCS0)_1TX

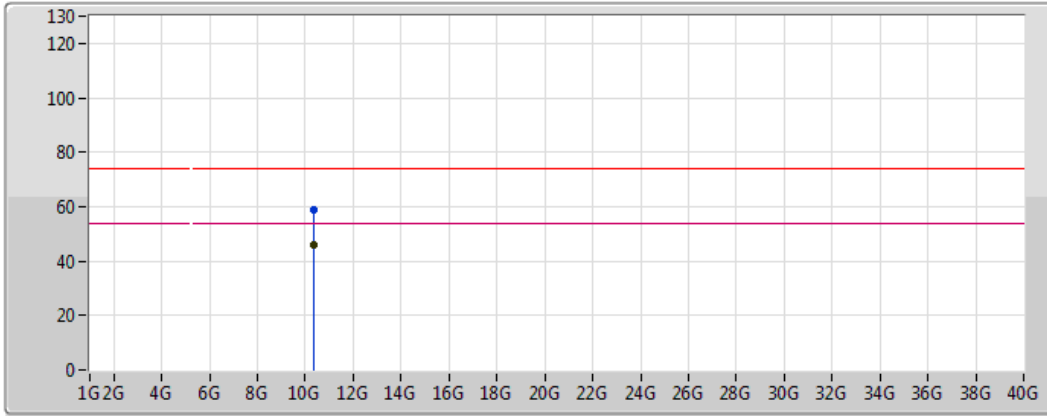
5180MHz_TX

18/06/2018



Lim.PK	
PK	
Lim.AV	
AV	

Type	Freq (Hz)	Level (dBuV/m)	Limit (dBuV/m)	Margin (dB)	Factor (dB)	Dist (m)	Condition	Azimuth (°)	Height (m)	Comments
AV	10.37164G	45.85	54.00	-8.15	14.34	3	Vertical	355	2.19	-
PK	10.35148G	58.76	74.00	-15.24	14.30	3	Vertical	355	2.19	-

802.11n HT20_Nss1,(MCS0)_1TX

5180MHz_TX

18/06/2018

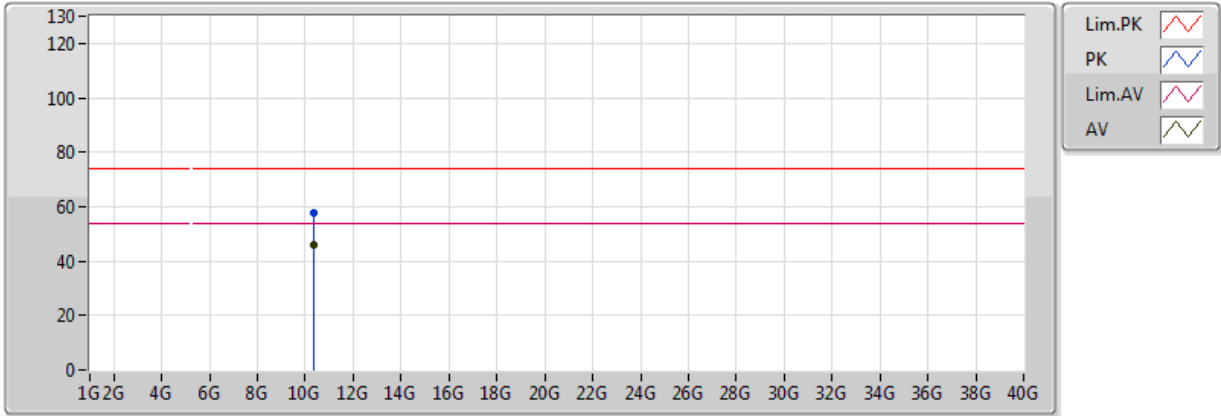

Type	Freq (Hz)	Level (dBuV/m)	Limit (dBuV/m)	Margin (dB)	Factor (dB)	Dist (m)	Condition	Azimuth (°)	Height (m)	Comments
AV	10.37458G	45.89	54.00	-8.11	14.34	3	Horizontal	271	1.43	-
PK	10.3507G	57.98	74.00	-16.02	14.30	3	Horizontal	271	1.43	-

802.11n HT20_Nss1,(MCS0)_1TX

5200MHz_TX

18/06/2018

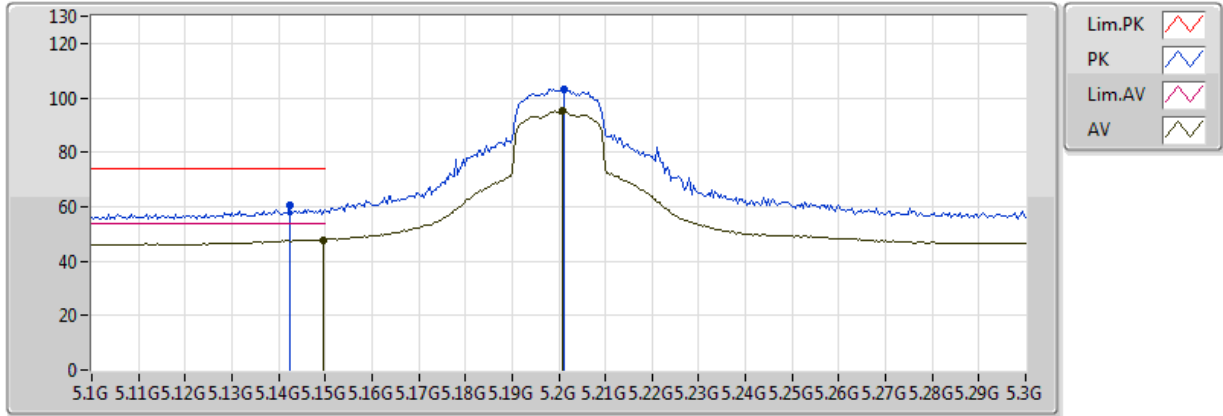

Type	Freq (Hz)	Level (dBuV/m)	Limit (dBuV/m)	Margin (dB)	Factor (dB)	Dist (m)	Condition	Azimuth (°)	Height (m)	Comments
AV	5.1496G	47.76	54.00	-6.24	3.68	3	Vertical	54	2.68	-
AV	5.2008G	95.10	Inf	-Inf	3.77	3	Vertical	54	2.68	-
PK	5.1424G	60.34	74.00	-13.66	3.67	3	Vertical	54	2.68	-
PK	5.2012G	103.25	Inf	-Inf	3.77	3	Vertical	54	2.68	-

802.11n HT20_Nss1,(MCS0)_1TX

5200MHz_TX

18/06/2018

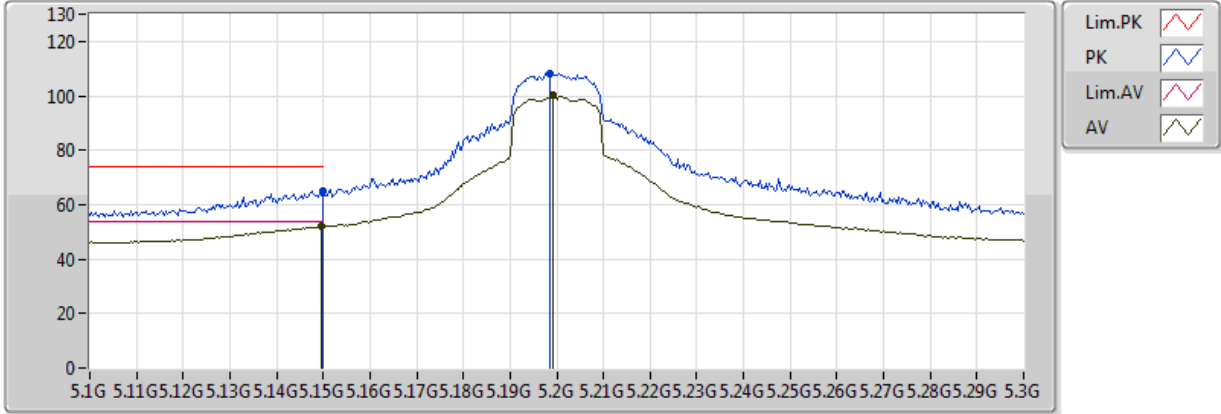





Type	Freq (Hz)	Level (dBuV/m)	Limit (dBuV/m)	Margin (dB)	Factor (dB)	Dist (m)	Condition	Azimuth (°)	Height (m)	Comments
AV	5.1496G	51.84	54.00	-2.16	3.68	3	Horizontal	124	1.01	-
AV	5.1992G	100.10	Inf	-Inf	3.77	3	Horizontal	124	1.01	-
PK	5.149995G	65.26	74.00	-8.74	3.68	3	Horizontal	124	1.01	-
PK	5.1984G	108.29	Inf	-Inf	3.77	3	Horizontal	124	1.01	-

802.11n HT20_Nss1,(MCS0)_1TX

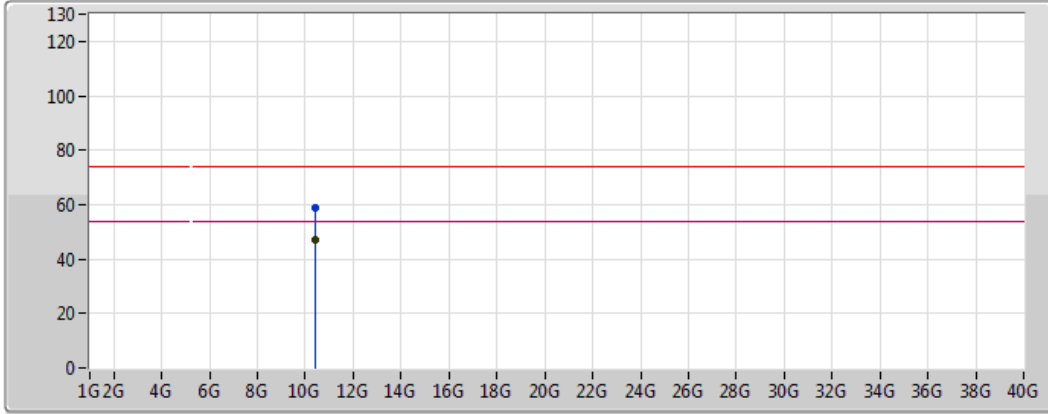
5200MHz_TX

18/06/2018



Lim.PK	
PK	
Lim.AV	
AV	





Type	Freq (Hz)	Level (dBuV/m)	Limit (dBuV/m)	Margin (dB)	Factor (dB)	Dist (m)	Condition	Azimuth (°)	Height (m)	Comments
AV	10.39856G	46.89	54.00	-7.11	14.39	3	Vertical	360	2.13	-
PK	10.39634G	58.63	74.00	-15.37	14.39	3	Vertical	360	2.13	-

802.11n HT20_Nss1,(MCS0)_1TX

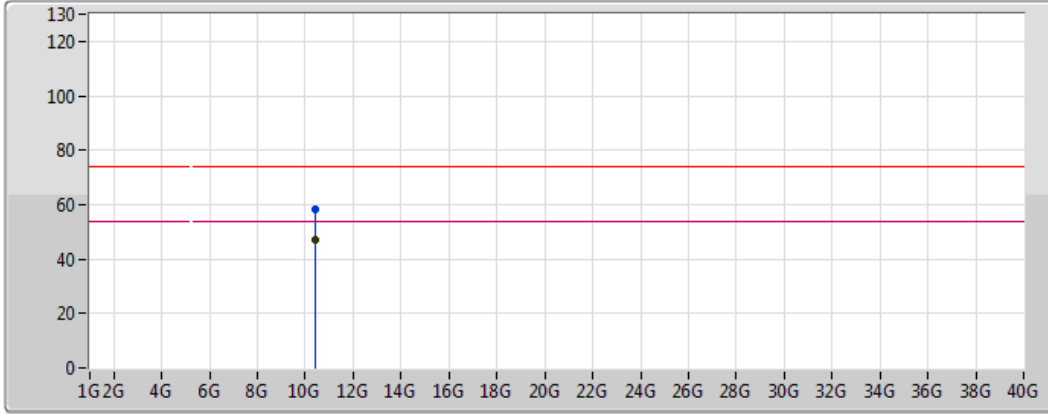
5200MHz_TX

18/06/2018



Lim.PK	
PK	
Lim.AV	
AV	

Type	Freq (Hz)	Level (dBuV/m)	Limit (dBuV/m)	Margin (dB)	Factor (dB)	Dist (m)	Condition	Azimuth (°)	Height (m)	Comments
AV	10.39928G	47.03	54.00	-6.97	14.39	3	Horizontal	23	1.50	-
PK	10.39904G	58.46	74.00	-15.54	14.39	3	Horizontal	23	1.50	-

802.11n HT20_Nss1,(MCS0)_1TX

5240MHz_TX

18/06/2018

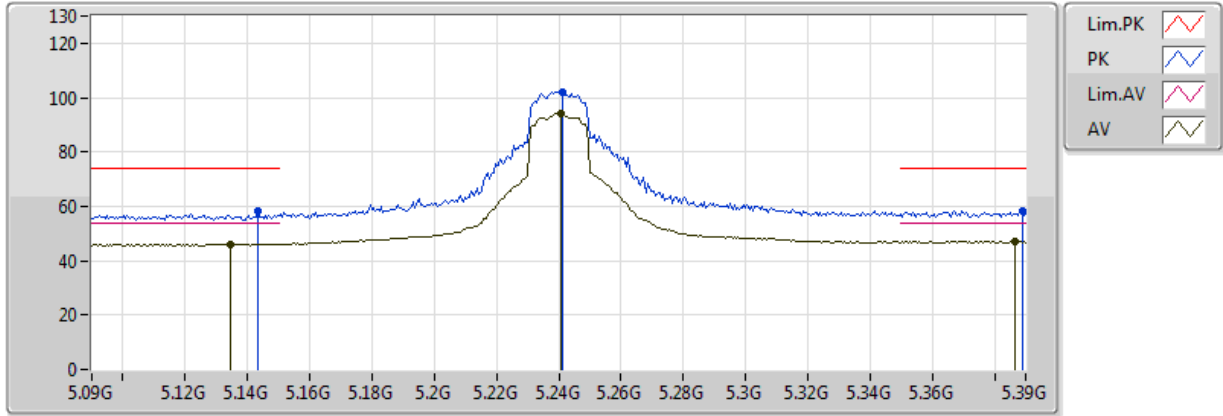

Type	Freq (Hz)	Level (dBuV/m)	Limit (dBuV/m)	Margin (dB)	Factor (dB)	Dist (m)	Condition	Azimuth (°)	Height (m)	Comments
AV	5.1344G	46.11	54.00	-7.89	3.65	3	Vertical	22	1.03	-
AV	5.2406G	94.33	Inf	-Inf	3.85	3	Vertical	22	1.03	-
AV	5.3864G	47.07	54.00	-6.93	4.11	3	Vertical	22	1.03	-
PK	5.1434G	58.07	74.00	-15.93	3.67	3	Vertical	22	1.03	-
PK	5.2412G	102.24	Inf	-Inf	3.85	3	Vertical	22	1.03	-
PK	5.3888G	58.51	74.00	-15.49	4.12	3	Vertical	22	1.03	-

802.11n HT20_Nss1,(MCS0)_1TX

5240MHz_TX

18/06/2018

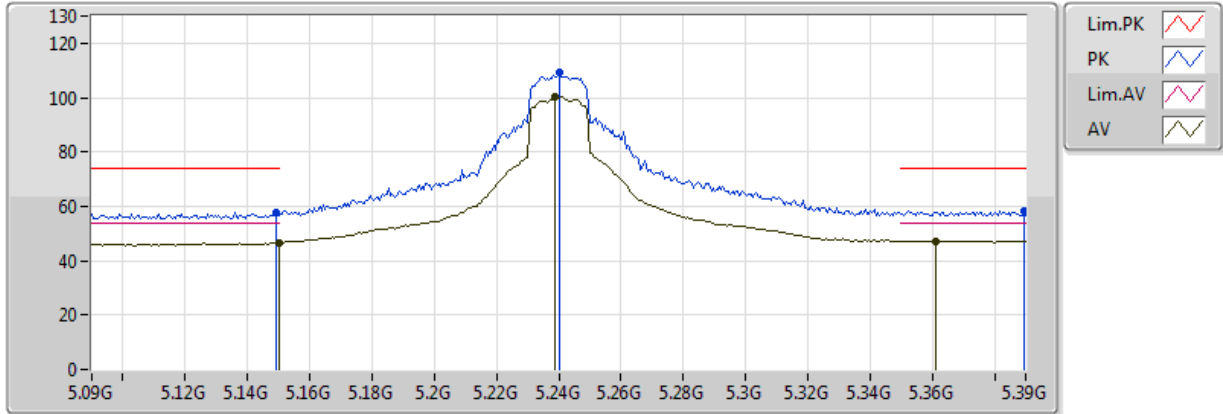

Type	Freq (Hz)	Level (dBuV/m)	Limit (dBuV/m)	Margin (dB)	Factor (dB)	Dist (m)	Condition	Azimuth (°)	Height (m)	Comments
AV	5.149995G	46.76	54.00	-7.24	3.68	3	Horizontal	125	1.02	-
AV	5.2388G	100.42	Inf	-Inf	3.84	3	Horizontal	125	1.02	-
AV	5.3612G	47.32	54.00	-6.68	4.07	3	Horizontal	125	1.02	-
PK	5.1494G	57.83	74.00	-16.17	3.68	3	Horizontal	125	1.02	-
PK	5.24G	109.15	Inf	-Inf	3.85	3	Horizontal	125	1.02	-
PK	5.3894G	58.41	74.00	-15.59	4.12	3	Horizontal	125	1.02	-

802.11n HT20_Nss1,(MCS0)_1TX

5240MHz_TX

18/06/2018

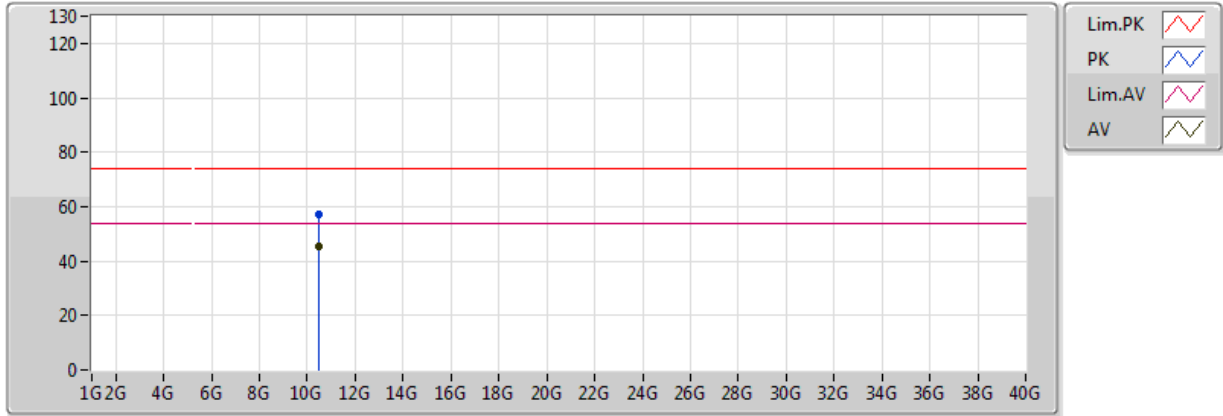

Type	Freq (Hz)	Level (dBuV/m)	Limit (dBuV/m)	Margin (dB)	Factor (dB)	Dist (m)	Condition	Azimuth (°)	Height (m)	Comments
AV	10.465G	45.55	54.00	-8.45	14.53	3	Vertical	305	2.16	-
PK	10.48216G	57.18	74.00	-16.82	14.56	3	Vertical	305	2.16	-

802.11n HT20_Nss1,(MCS0)_1TX

5240MHz_TX

18/06/2018

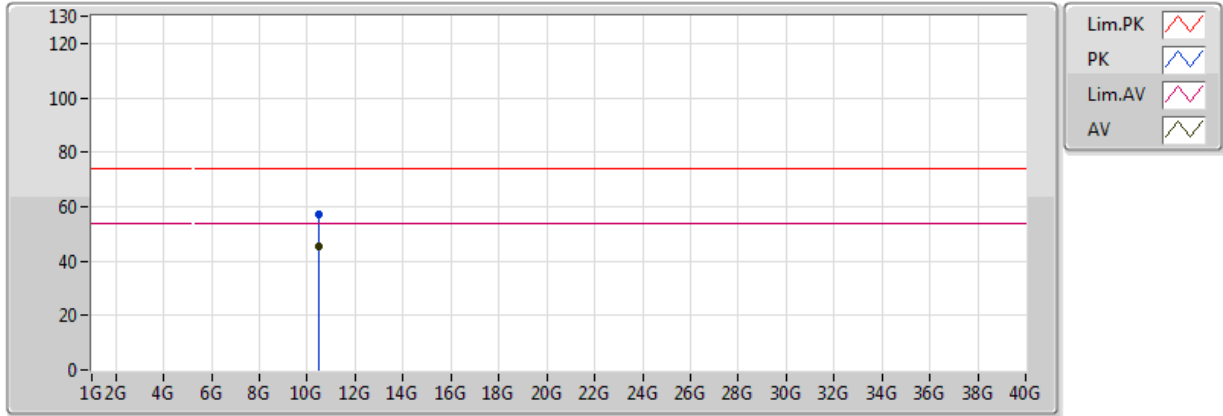

Type	Freq (Hz)	Level (dBuV/m)	Limit (dBuV/m)	Margin (dB)	Factor (dB)	Dist (m)	Condition	Azimuth (°)	Height (m)	Comments
AV	10.4656G	45.55	54.00	-8.45	14.53	3	Horizontal	20	1.51	-
PK	10.47202G	57.33	74.00	-16.67	14.54	3	Horizontal	20	1.51	-

802.11n HT20_Nss1,(MCS0)_1TX

5745MHz_TX

18/06/2018

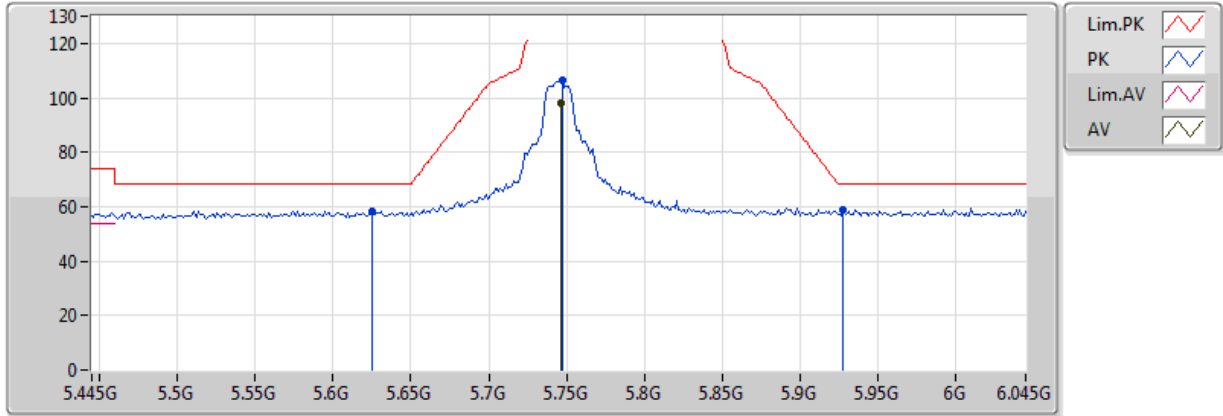

Type	Freq (Hz)	Level (dBuV/m)	Limit (dBuV/m)	Margin (dB)	Factor (dB)	Dist (m)	Condition	Azimuth (°)	Height (m)	Comments
AV	5.7462G	97.84	Inf	-Inf	4.70	3	Vertical	21	2.16	-
PK	5.625G	58.51	68.20	-9.69	4.51	3	Vertical	21	2.16	-
PK	5.7474G	106.26	Inf	-Inf	4.71	3	Vertical	21	2.16	-
PK	5.9274G	58.74	68.20	-9.46	4.99	3	Vertical	21	2.16	-

802.11n HT20_Nss1,(MCS0)_1TX

5745MHz_TX

18/06/2018

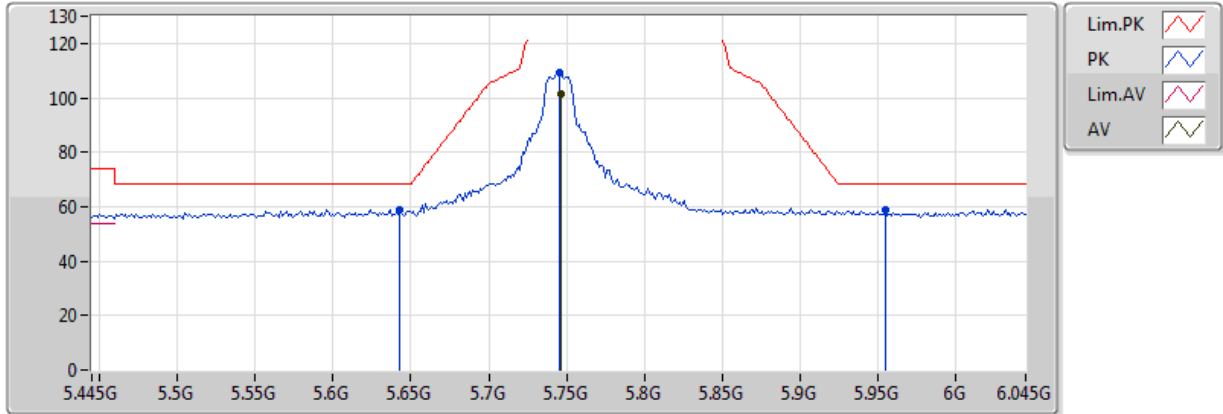





Type	Freq (Hz)	Level (dBuV/m)	Limit (dBuV/m)	Margin (dB)	Factor (dB)	Dist (m)	Condition	Azimuth (°)	Height (m)	Comments
AV	5.7462G	101.20	Inf	-Inf	4.70	3	Horizontal	353	2.35	-
PK	5.643G	58.73	68.20	-9.47	4.54	3	Horizontal	353	2.35	-
PK	5.745G	109.35	Inf	-Inf	4.70	3	Horizontal	353	2.35	-
PK	5.955G	59.08	68.20	-9.12	5.03	3	Horizontal	353	2.35	-

802.11n HT20_Nss1,(MCS0)_1TX

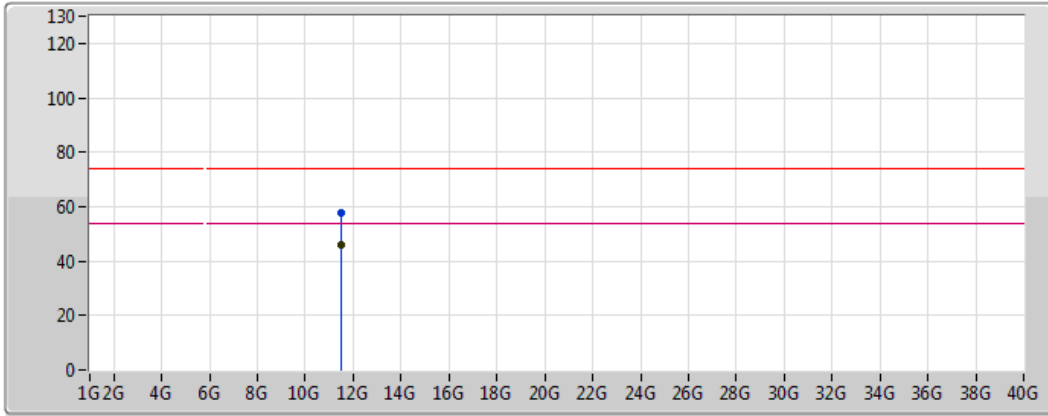
5745MHz_TX

18/06/2018



Lim.PK	
PK	
Lim.AV	
AV	





Type	Freq (Hz)	Level (dBuV/m)	Limit (dBuV/m)	Margin (dB)	Factor (dB)	Dist (m)	Condition	Azimuth (°)	Height (m)	Comments
AV	11.49276G	45.81	54.00	-8.19	15.05	3	Vertical	356	3.14	-
PK	11.48322G	57.46	74.00	-16.54	15.06	3	Vertical	356	3.14	-

802.11n HT20_Nss1,(MCS0)_1TX

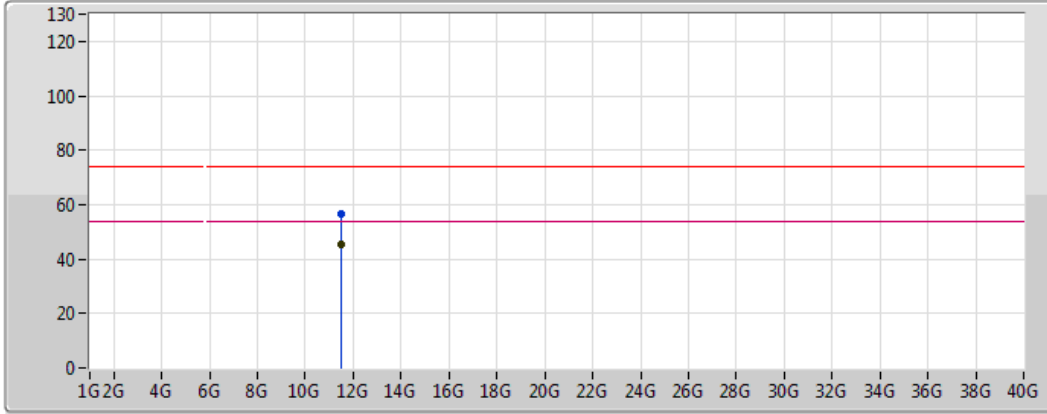
5745MHz_TX

18/06/2018



Lim.PK	
PK	
Lim.AV	
AV	

Type	Freq (Hz)	Level (dBuV/m)	Limit (dBuV/m)	Margin (dB)	Factor (dB)	Dist (m)	Condition	Azimuth (°)	Height (m)	Comments
AV	11.48742G	45.23	54.00	-8.77	15.05	3	Horizontal	148	2.07	-
PK	11.50254G	56.60	74.00	-17.40	15.04	3	Horizontal	148	2.07	-

802.11n HT20_Nss1,(MCS0)_1TX

5785MHz_TX

18/06/2018

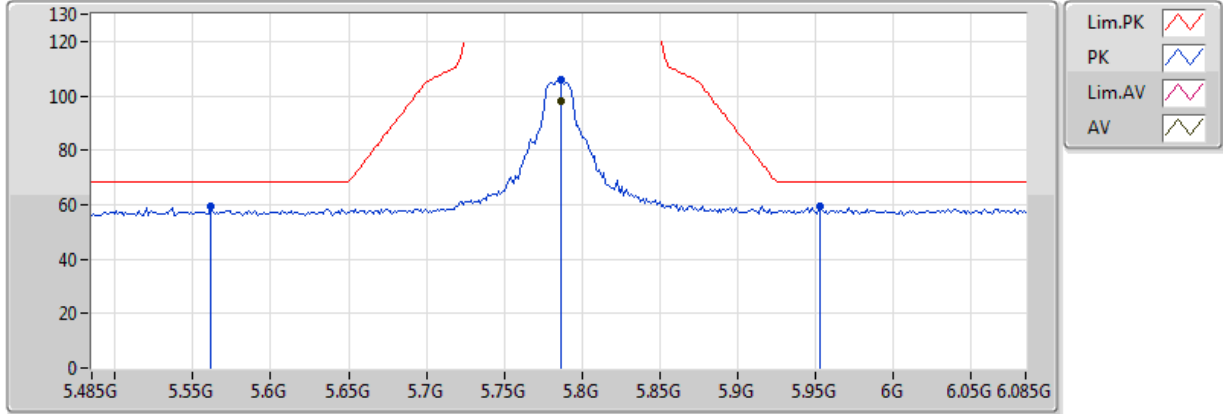

Type	Freq (Hz)	Level (dBuV/m)	Limit (dBuV/m)	Margin (dB)	Factor (dB)	Dist (m)	Condition	Azimuth (°)	Height (m)	Comments
AV	5.7862G	97.79	Inf	-Inf	4.77	3	Vertical	30	2.36	-
PK	5.5618G	59.31	68.20	-8.89	4.41	3	Vertical	30	2.36	-
PK	5.7862G	105.83	Inf	-Inf	4.77	3	Vertical	30	2.36	-
PK	5.953G	59.33	68.20	-8.87	5.02	3	Vertical	30	2.36	-

802.11n HT20_Nss1,(MCS0)_1TX

5785MHz_TX

18/06/2018

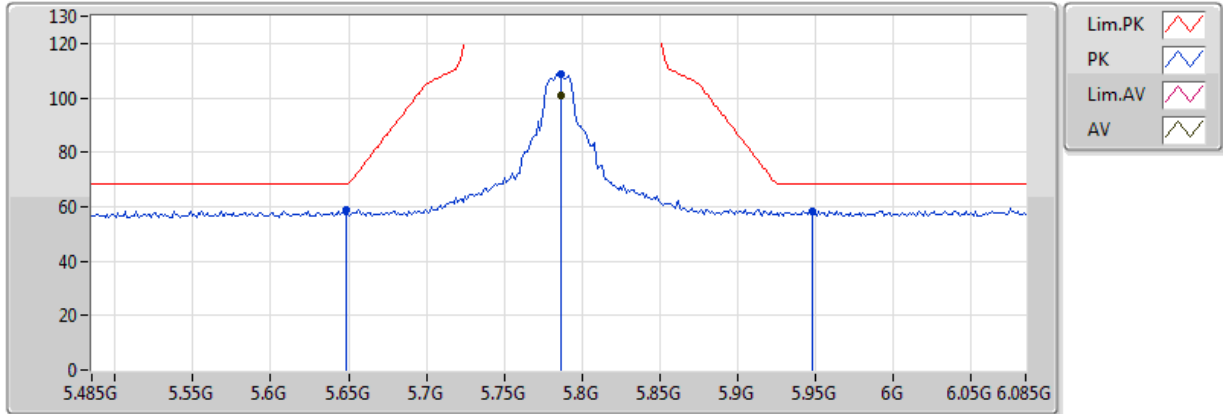

Type	Freq (Hz)	Level (dBuV/m)	Limit (dBuV/m)	Margin (dB)	Factor (dB)	Dist (m)	Condition	Azimuth (°)	Height (m)	Comments
AV	5.7862G	100.71	Inf	-Inf	4.77	3	Horizontal	354	2.18	-
PK	5.6482G	58.94	68.20	-9.26	4.55	3	Horizontal	354	2.18	-
PK	5.7862G	108.81	Inf	-Inf	4.77	3	Horizontal	354	2.18	-
PK	5.9482G	58.55	68.20	-9.65	5.03	3	Horizontal	354	2.18	-

802.11n HT20_Nss1,(MCS0)_1TX

5785MHz_TX

18/06/2018

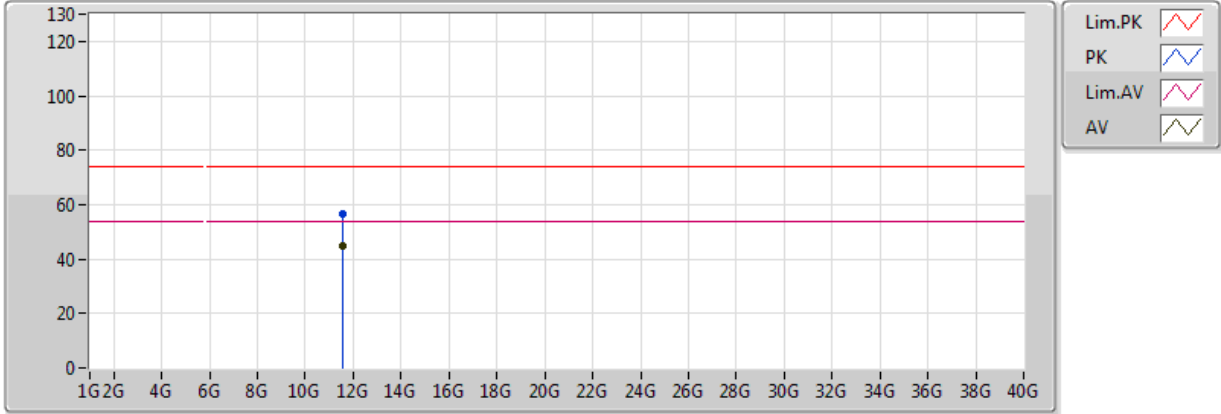





Type	Freq (Hz)	Level (dBuV/m)	Limit (dBuV/m)	Margin (dB)	Factor (dB)	Dist (m)	Condition	Azimuth (°)	Height (m)	Comments
AV	11.57858G	45.08	54.00	-8.92	14.95	3	Vertical	14	3.03	-
PK	11.57324G	56.75	74.00	-17.25	14.96	3	Vertical	14	3.03	-

802.11n HT20_Nss1,(MCS0)_1TX

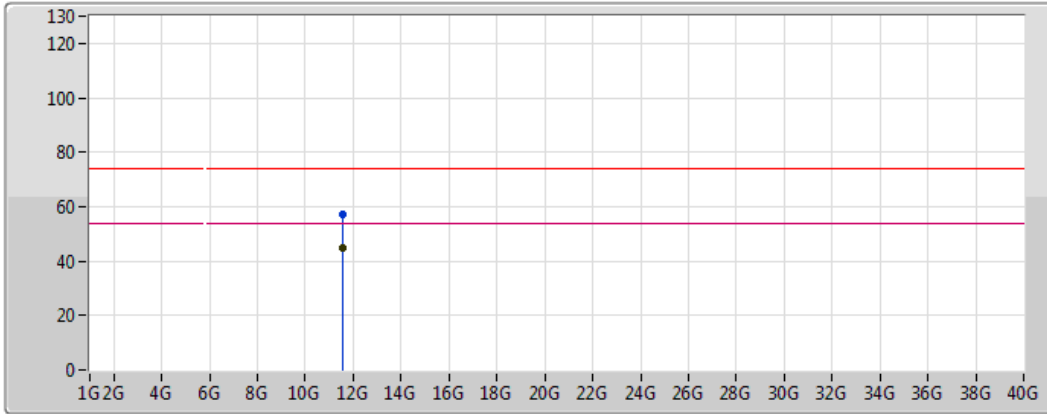
5785MHz_TX

18/06/2018



Lim.PK	
PK	
Lim.AV	
AV	

Type	Freq (Hz)	Level (dBuV/m)	Limit (dBuV/m)	Margin (dB)	Factor (dB)	Dist (m)	Condition	Azimuth (°)	Height (m)	Comments
AV	11.57606G	45.07	54.00	-8.93	14.95	3	Horizontal	150	2.10	-
PK	11.58014G	57.01	74.00	-16.99	14.95	3	Horizontal	150	2.10	-

802.11n HT20_Nss1,(MCS0)_1TX

5825MHz_TX

18/06/2018

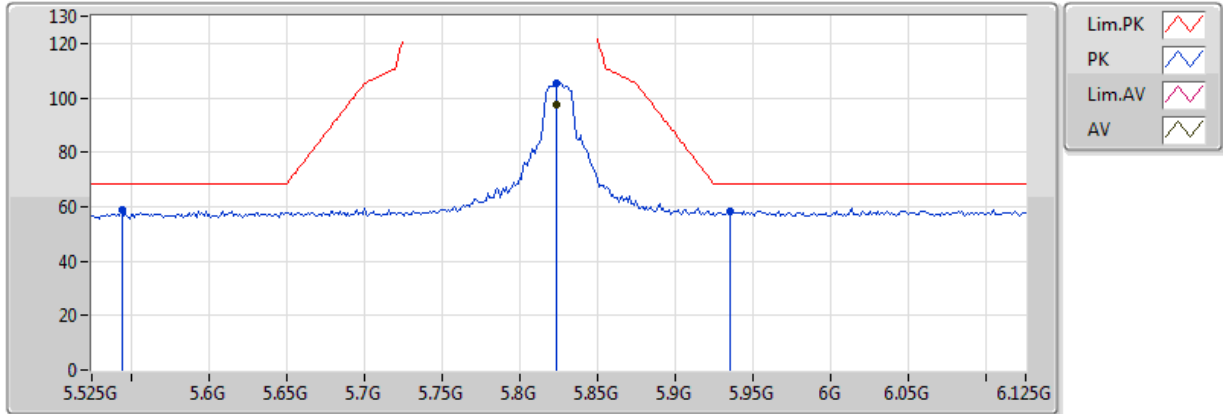

Type	Freq (Hz)	Level (dBuV/m)	Limit (dBuV/m)	Margin (dB)	Factor (dB)	Dist (m)	Condition	Azimuth (°)	Height (m)	Comments
AV	5.8238G	97.47	Inf	-Inf	4.83	3	Vertical	29	2.08	-
PK	5.5442G	58.59	68.20	-9.61	4.39	3	Vertical	29	2.08	-
PK	5.8238G	105.41	Inf	-Inf	4.83	3	Vertical	29	2.08	-
PK	5.9354G	58.40	68.20	-9.80	5.00	3	Vertical	29	2.08	-

802.11n HT20_Nss1,(MCS0)_1TX

5825MHz_TX

18/06/2018

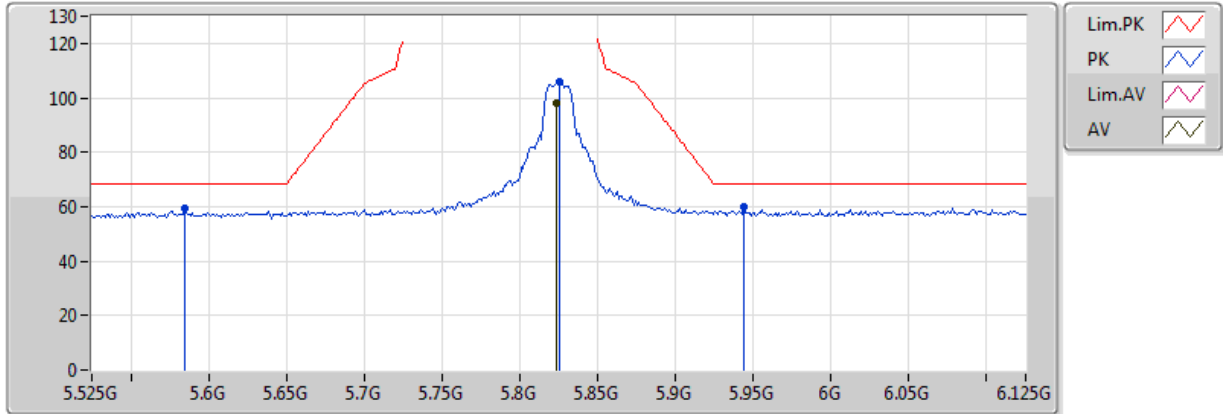

Type	Freq (Hz)	Level (dBuV/m)	Limit (dBuV/m)	Margin (dB)	Factor (dB)	Dist (m)	Condition	Azimuth (°)	Height (m)	Comments
AV	5.8238G	97.96	Inf	-Inf	4.83	3	Horizontal	1	1.50	-
PK	5.585G	59.37	68.20	-8.83	4.44	3	Horizontal	1	1.50	-
PK	5.825G	105.64	Inf	-Inf	4.83	3	Horizontal	1	1.50	-
PK	5.9438G	59.77	68.20	-8.43	5.02	3	Horizontal	1	1.50	-

802.11n HT20_Nss1,(MCS0)_1TX

5825MHz_TX

18/06/2018

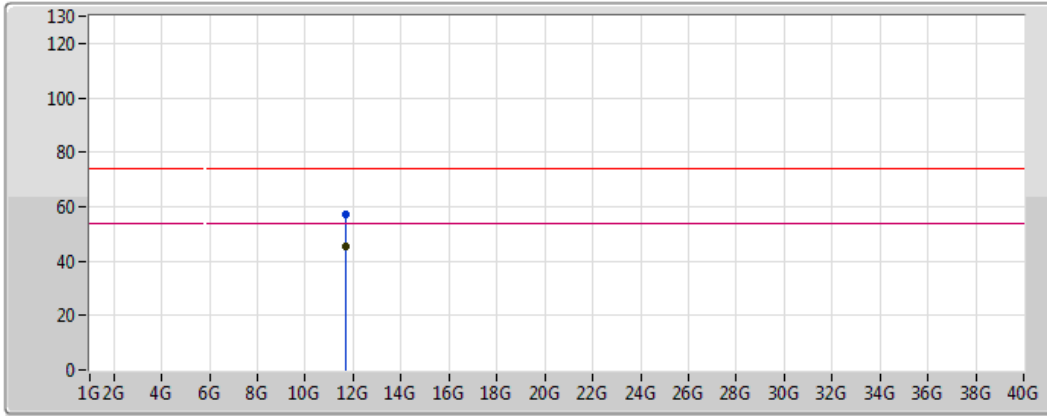





Type	Freq (Hz)	Level (dBuV/m)	Limit (dBuV/m)	Margin (dB)	Factor (dB)	Dist (m)	Condition	Azimuth (°)	Height (m)	Comments
AV	11.66488G	45.18	54.00	-8.82	14.85	3	Vertical	38	2.23	-
PK	11.66494G	57.34	74.00	-16.66	14.85	3	Vertical	38	2.23	-

802.11n HT20_Nss1,(MCS0)_1TX

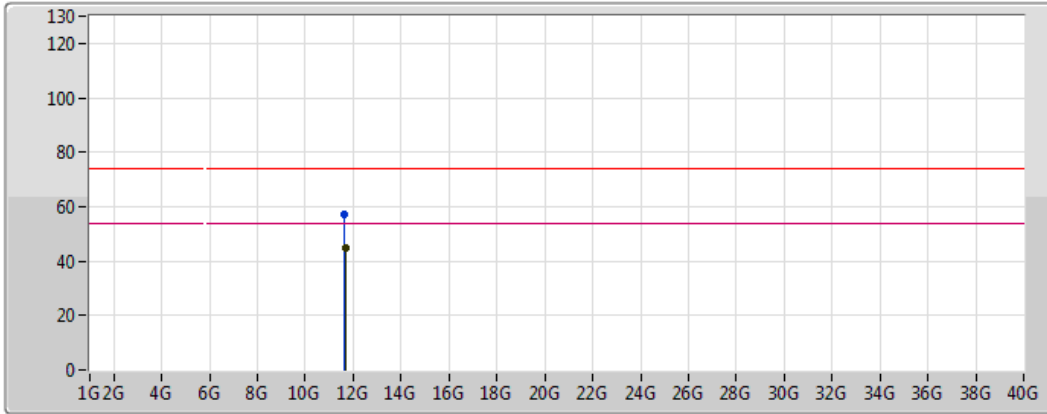
5825MHz_TX

18/06/2018



Lim.PK	
PK	
Lim.AV	
AV	

Type	Freq (Hz)	Level (dBuV/m)	Limit (dBuV/m)	Margin (dB)	Factor (dB)	Dist (m)	Condition	Azimuth (°)	Height (m)	Comments
AV	11.66044G	45.03	54.00	-8.97	14.85	3	Horizontal	278	1.50	-
PK	11.65594G	56.97	74.00	-17.03	14.86	3	Horizontal	278	1.50	-

802.11n HT40_Nss1,(MCS0)_1TX

5190MHz_TX

18/06/2018

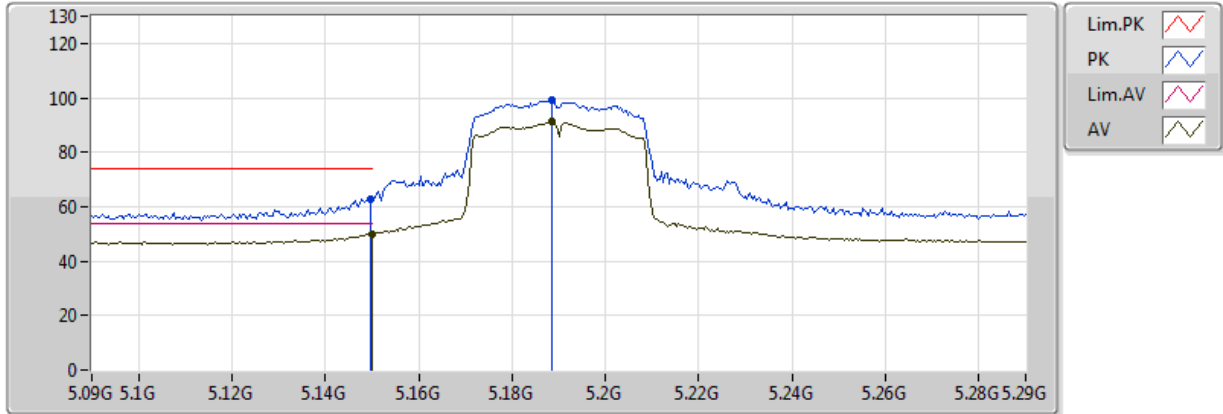

Type	Freq (Hz)	Level (dBuV/m)	Limit (dBuV/m)	Margin (dB)	Factor (dB)	Dist (m)	Condition	Azimuth (°)	Height (m)	Comments
AV	5.149995G	50.10	54.00	-3.90	3.68	3	Vertical	81	3.17	-
AV	5.1884G	91.18	Inf	-Inf	3.75	3	Vertical	81	3.17	-
PK	5.1496G	62.66	74.00	-11.34	3.68	3	Vertical	81	3.17	-
PK	5.1884G	99.13	Inf	-Inf	3.75	3	Vertical	81	3.17	-

802.11n HT40_Nss1,(MCS0)_1TX

5190MHz_TX

18/06/2018

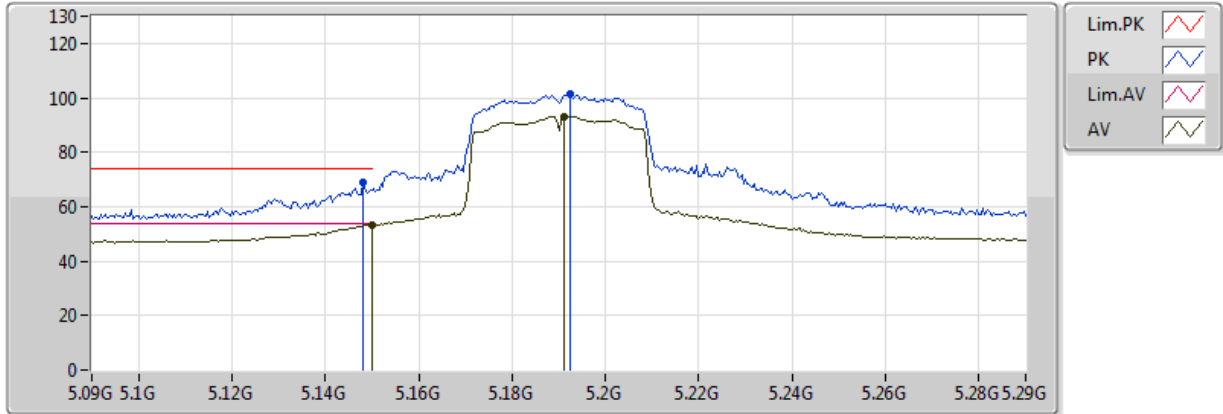





Type	Freq (Hz)	Level (dBuV/m)	Limit (dBuV/m)	Margin (dB)	Factor (dB)	Dist (m)	Condition	Azimuth (°)	Height (m)	Comments
AV	5.149995G	53.29	54.00	-0.71	3.68	3	Horizontal	133	1.03	-
AV	5.1912G	93.25	Inf	-Inf	3.75	3	Horizontal	133	1.03	-
PK	5.148G	69.02	74.00	-4.98	3.68	3	Horizontal	133	1.03	-
PK	5.1924G	101.22	Inf	-Inf	3.76	3	Horizontal	133	1.03	-

802.11n HT40_Nss1,(MCS0)_1TX

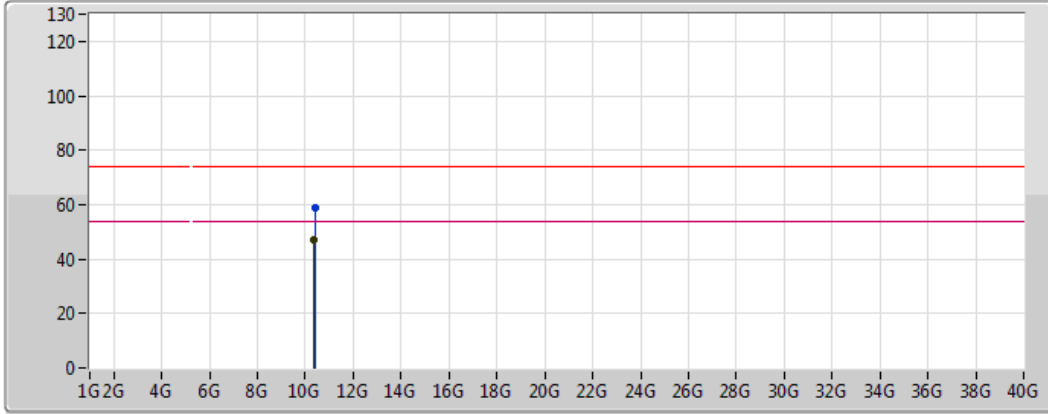
5190MHz_TX

18/06/2018



Lim.PK	
PK	
Lim.AV	
AV	

Type	Freq (Hz)	Level (dBuV/m)	Limit (dBuV/m)	Margin (dB)	Factor (dB)	Dist (m)	Condition	Azimuth (°)	Height (m)	Comments
AV	10.36968G	47.34	54.00	-6.66	14.33	3	Vertical	5	1.50	-
PK	10.39188G	58.74	74.00	-15.26	14.38	3	Vertical	5	1.50	-

802.11n HT40_Nss1,(MCS0)_1TX

5190MHz_TX

18/06/2018

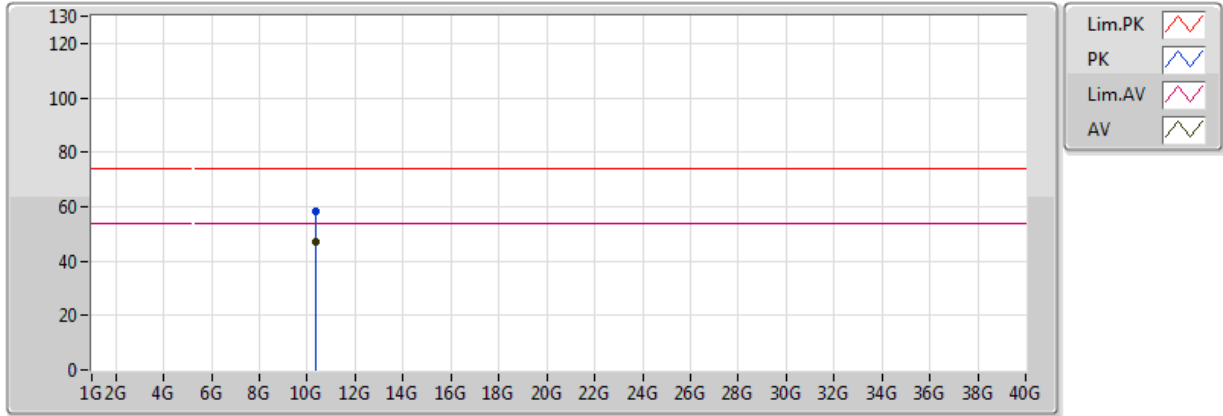

Type	Freq (Hz)	Level (dBuV/m)	Limit (dBuV/m)	Margin (dB)	Factor (dB)	Dist (m)	Condition	Azimuth (°)	Height (m)	Comments
AV	10.36584G	47.34	54.00	-6.66	14.33	3	Horizontal	171	1.05	-
PK	10.36584G	58.04	74.00	-15.96	14.33	3	Horizontal	171	1.05	-

802.11n HT40_Nss1,(MCS0)_1TX

5230MHz_TX

18/06/2018

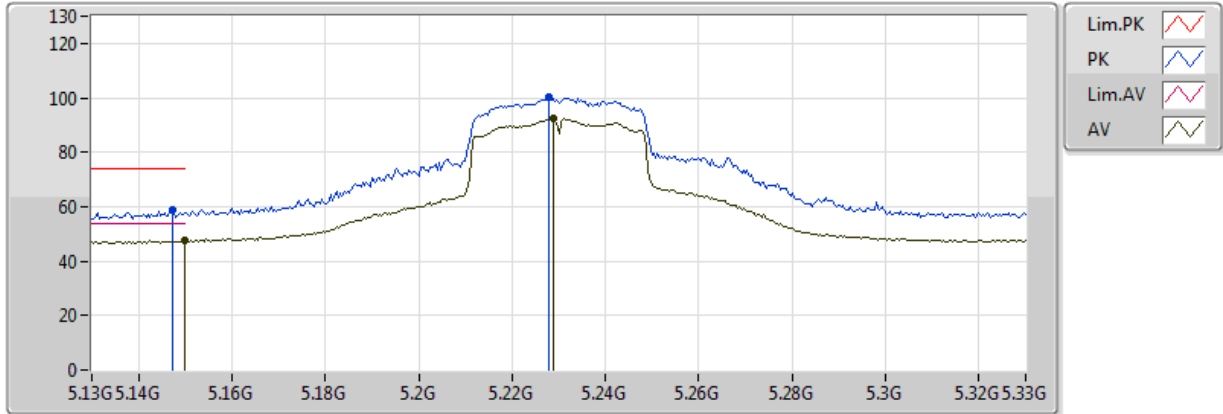

Type	Freq (Hz)	Level (dBuV/m)	Limit (dBuV/m)	Margin (dB)	Factor (dB)	Dist (m)	Condition	Azimuth (°)	Height (m)	Comments
AV	5.149995G	47.60	54.00	-6.40	3.68	3	Vertical	50	2.80	-
AV	5.2288G	92.40	Inf	-Inf	3.82	3	Vertical	50	2.80	-
PK	5.1472G	58.67	74.00	-15.33	3.68	3	Vertical	50	2.80	-
PK	5.228G	100.09	Inf	-Inf	3.82	3	Vertical	50	2.80	-

802.11n HT40_Nss1,(MCS0)_1TX

5230MHz_TX

18/06/2018

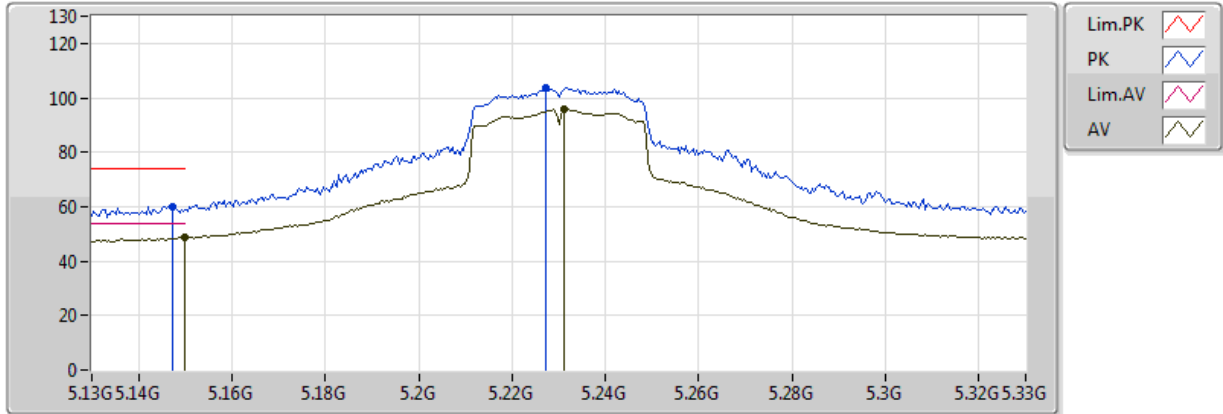

Type	Freq (Hz)	Level (dBuV/m)	Limit (dBuV/m)	Margin (dB)	Factor (dB)	Dist (m)	Condition	Azimuth (°)	Height (m)	Comments
AV	5.149995G	48.66	54.00	-5.34	3.68	3	Horizontal	141	1.15	-
AV	5.2312G	95.81	Inf	-Inf	3.83	3	Horizontal	141	1.15	-
PK	5.1472G	60.09	74.00	-13.91	3.68	3	Horizontal	141	1.15	-
PK	5.2272G	103.59	Inf	-Inf	3.82	3	Horizontal	141	1.15	-

802.11n HT40_Nss1,(MCS0)_1TX

5230MHz_TX

18/06/2018

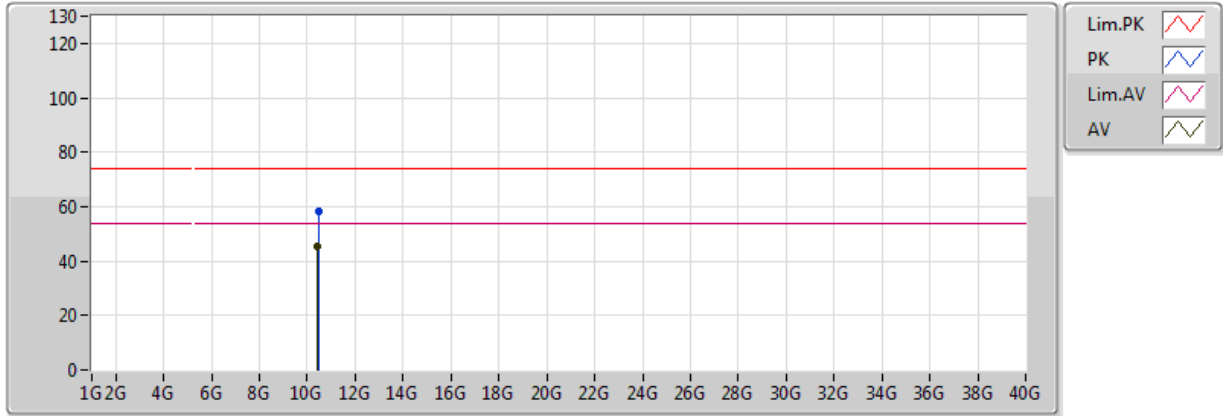





Type	Freq (Hz)	Level (dBuV/m)	Limit (dBuV/m)	Margin (dB)	Factor (dB)	Dist (m)	Condition	Azimuth (°)	Height (m)	Comments
AV	10.44638G	45.29	54.00	-8.71	14.49	3	Vertical	5	1.50	-
PK	10.4624G	58.18	74.00	-15.82	14.52	3	Vertical	5	1.50	-

802.11n HT40_Nss1,(MCS0)_1TX

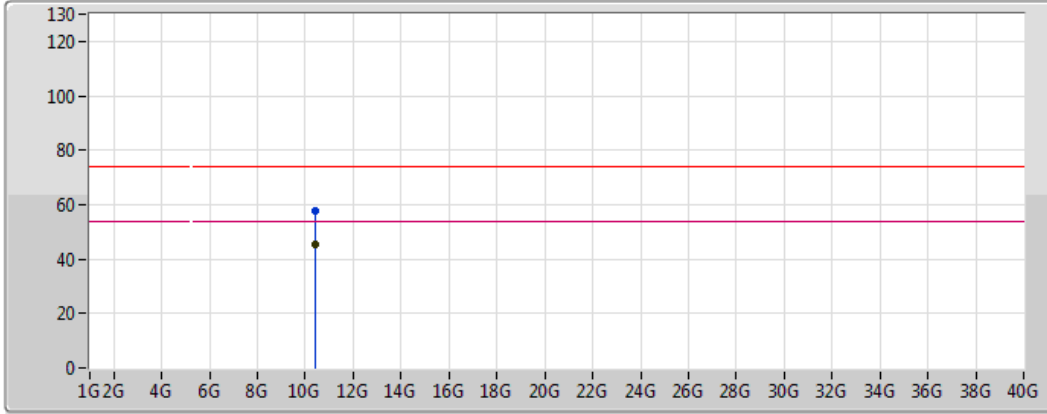
5230MHz_TX

18/06/2018



Lim.PK	
PK	
Lim.AV	
AV	

Type	Freq (Hz)	Level (dBuV/m)	Limit (dBuV/m)	Margin (dB)	Factor (dB)	Dist (m)	Condition	Azimuth (°)	Height (m)	Comments
AV	10.44596G	45.38	54.00	-8.62	14.49	3	Horizontal	104	2.76	-
PK	10.44746G	57.80	74.00	-16.20	14.49	3	Horizontal	104	2.76	-

802.11n HT40_Nss1,(MCS0)_1TX

5755MHz_TX

18/06/2018

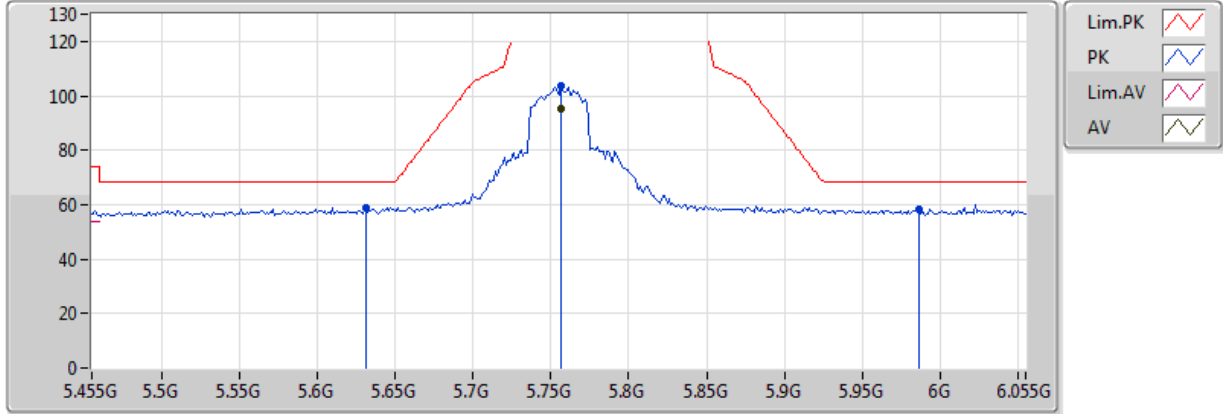

Type	Freq (Hz)	Level (dBuV/m)	Limit (dBuV/m)	Margin (dB)	Factor (dB)	Dist (m)	Condition	Azimuth (°)	Height (m)	Comments
AV	5.7562G	95.04	Inf	-Inf	4.72	3	Vertical	32	2.38	-
PK	5.6314G	58.88	68.20	-9.32	4.52	3	Vertical	32	2.38	-
PK	5.7562G	103.41	Inf	-Inf	4.72	3	Vertical	32	2.38	-
PK	5.9866G	58.48	68.20	-9.72	5.07	3	Vertical	32	2.38	-

802.11n HT40_Nss1,(MCS0)_1TX

5755MHz_TX

18/06/2018

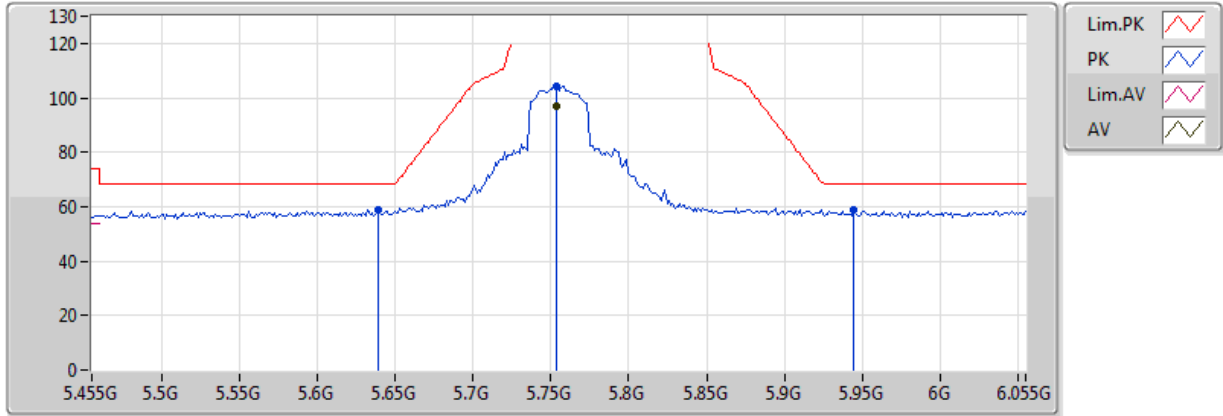





Type	Freq (Hz)	Level (dBuV/m)	Limit (dBuV/m)	Margin (dB)	Factor (dB)	Dist (m)	Condition	Azimuth (°)	Height (m)	Comments
AV	5.7538G	96.83	Inf	-Inf	4.72	3	Horizontal	4	1.82	-
PK	5.6386G	58.90	68.20	-9.30	4.53	3	Horizontal	4	1.82	-
PK	5.7538G	104.28	Inf	-Inf	4.72	3	Horizontal	4	1.82	-
PK	5.9446G	58.67	68.20	-9.53	5.02	3	Horizontal	4	1.82	-

802.11n HT40_Nss1,(MCS0)_1TX

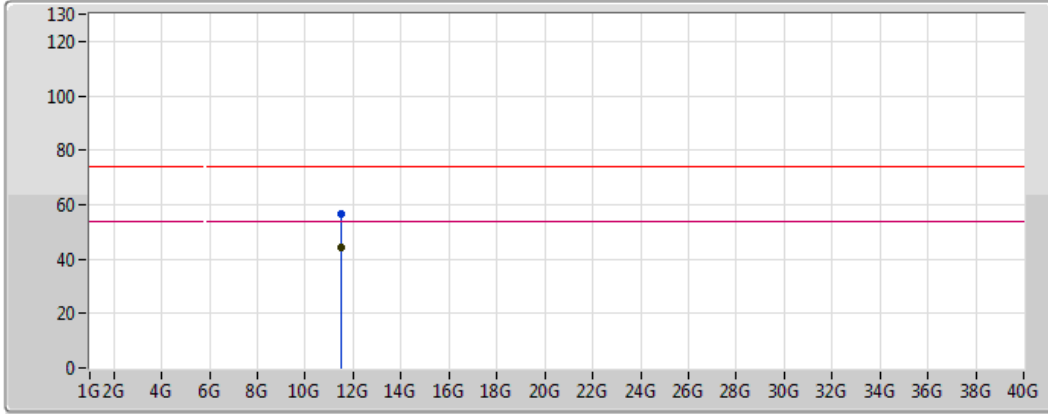
5755MHz_TX

18/06/2018



Lim.PK	
PK	
Lim.AV	
AV	





Type	Freq (Hz)	Level (dBuV/m)	Limit (dBuV/m)	Margin (dB)	Factor (dB)	Dist (m)	Condition	Azimuth (°)	Height (m)	Comments
AV	11.49872G	44.53	54.00	-9.47	15.04	3	Vertical	133	1.52	-
PK	11.49518G	56.83	74.00	-17.17	15.05	3	Vertical	133	1.52	-

802.11n HT40_Nss1,(MCS0)_1TX

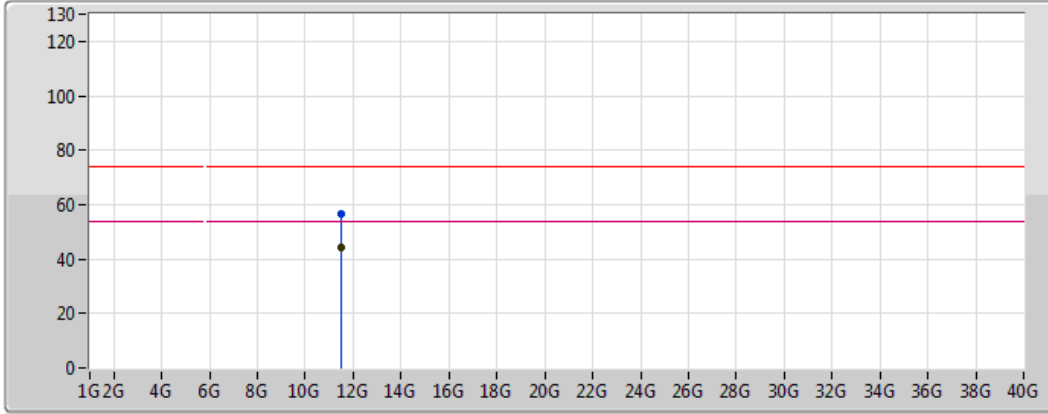
5755MHz_TX

18/06/2018



Lim.PK	
PK	
Lim.AV	
AV	

Type	Freq (Hz)	Level (dBuV/m)	Limit (dBuV/m)	Margin (dB)	Factor (dB)	Dist (m)	Condition	Azimuth (°)	Height (m)	Comments
AV	11.50154G	44.48	54.00	-9.52	15.04	3	Horizontal	302	2.07	-
PK	11.50238G	56.38	74.00	-17.62	15.04	3	Horizontal	302	2.07	-

802.11n HT40_Nss1,(MCS0)_1TX

5795MHz_TX

18/06/2018

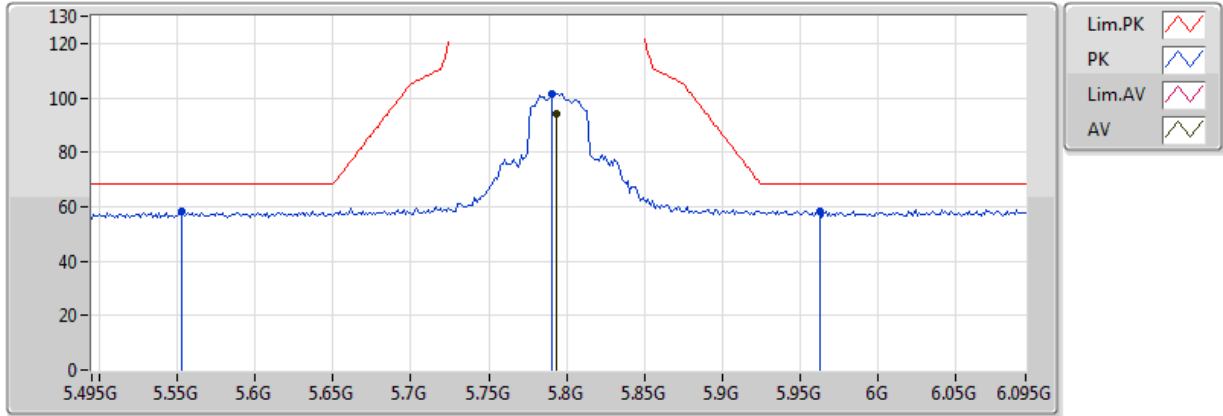

Type	Freq (Hz)	Level (dBuV/m)	Limit (dBuV/m)	Margin (dB)	Factor (dB)	Dist (m)	Condition	Azimuth (°)	Height (m)	Comments
AV	5.7938G	94.22	Inf	-Inf	4.78	3	Vertical	29	2.49	-
PK	5.5526G	58.21	68.20	-9.99	4.39	3	Vertical	29	2.49	-
PK	5.7902G	101.60	Inf	-Inf	4.77	3	Vertical	29	2.49	-
PK	5.963G	58.24	68.20	-9.96	5.05	3	Vertical	29	2.49	-

802.11n HT40_Nss1,(MCS0)_1TX

5795MHz_TX

18/06/2018

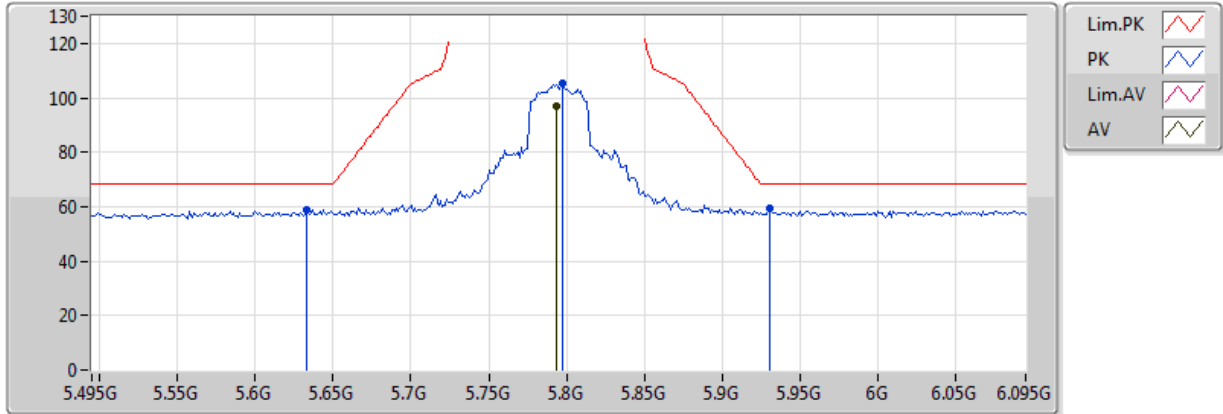





Type	Freq (Hz)	Level (dBuV/m)	Limit (dBuV/m)	Margin (dB)	Factor (dB)	Dist (m)	Condition	Azimuth (°)	Height (m)	Comments
AV	5.7938G	97.13	Inf	-Inf	4.78	3	Horizontal	356	2.13	-
PK	5.633G	58.98	68.20	-9.22	4.53	3	Horizontal	356	2.13	-
PK	5.7974G	105.18	Inf	-Inf	4.79	3	Horizontal	356	2.13	-
PK	5.9306G	59.67	68.20	-8.53	4.99	3	Horizontal	356	2.13	-

802.11n HT40_Nss1,(MCS0)_1TX

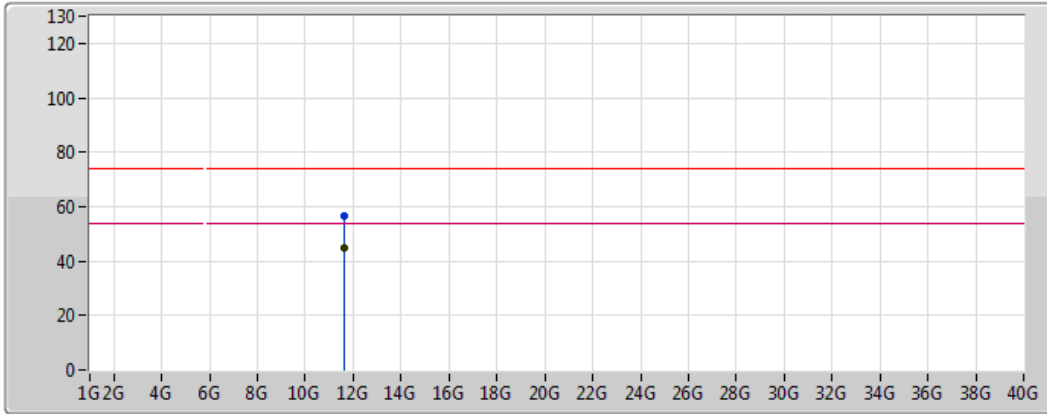
5795MHz_TX

18/06/2018



Lim.PK	
PK	
Lim.AV	
AV	





Type	Freq (Hz)	Level (dBuV/m)	Limit (dBuV/m)	Margin (dB)	Factor (dB)	Dist (m)	Condition	Azimuth (°)	Height (m)	Comments
AV	11.60008G	44.64	54.00	-9.36	14.92	3	Vertical	130	1.49	-
PK	11.59732G	56.72	74.00	-17.28	14.93	3	Vertical	130	1.49	-

802.11n HT40_Nss1,(MCS0)_1TX

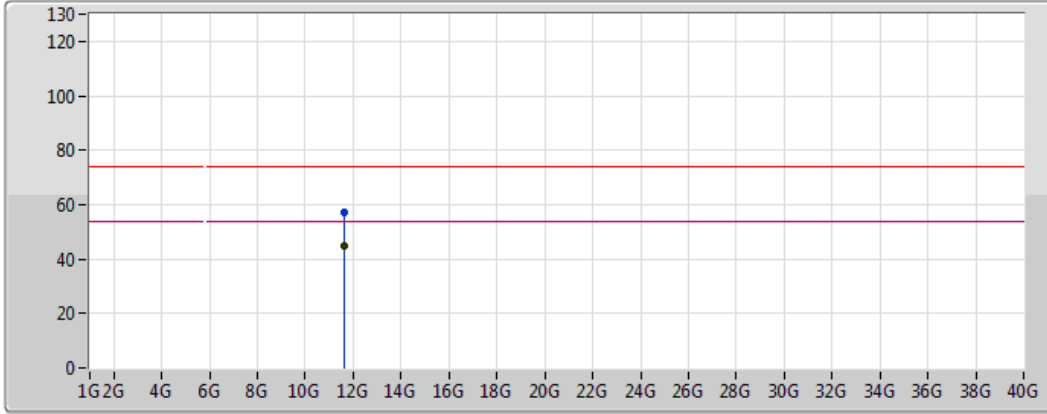
5795MHz_TX

18/06/2018



Lim.PK	
PK	
Lim.AV	
AV	

Type	Freq (Hz)	Level (dBuV/m)	Limit (dBuV/m)	Margin (dB)	Factor (dB)	Dist (m)	Condition	Azimuth (°)	Height (m)	Comments
AV	11.59804G	44.71	54.00	-9.29	14.93	3	Horizontal	300	2.08	-
PK	11.60092G	56.94	74.00	-17.06	14.92	3	Horizontal	300	2.08	-