

RF Test Report

Applicant : Ring LLC
Product Type : Ring Doorbell V2
Trade Name : Ring
Model Number : Ring Video Doorbell 2
Applicable Standard : FCC 47 CFR PART 15 SUBPART C
ANSI C63.10:2013
Receive Date : Dec. 28, 2018
Test Period : Jan. 02 ~ Jan. 15, 2019
Issue Date : Jan. 23, 2019

Issue by

A Test Lab Techno Corp.
No. 140-1, Changan Street, Bade District,
Taoyuan City 33465, Taiwan (R.O.C)
Tel : +886-3-2710188 / Fax : +886-3-2710190



Taiwan Accreditation Foundation accreditation number: 1330

Test Firm MRA designation number: TW0010

Note: This report shall not be reproduced except in full, without the written approval of A Test Lab Techno Corp. This document may be altered or revised by A Test Lab Techno Corp. personnel only, and shall be noted in the revision section of the document. The client should not use it to claim product endorsement by TAF, or any government agencies. The test results in the report only apply to the tested sample.



Revision History

Rev.	Issue Date	Revisions	Revised By
00	Jan. 23, 2019	Initial Issue	Nina Lin



Verification of Compliance

Issued Date: Jan. 23, 2019

Applicant : Ring LLC

Product Type : Ring Doorbell V2

Trade Name : Ring

Model Number : Ring Video Doorbell 2

FCC ID : 2AEUPBHARG043

EUT Rated Voltage : 8 - 24 VAC, 50/60 Hz, 200 mA

Test Voltage : 24 Vac / 60 Hz, DC 3.65 V

Applicable Standard : FCC 47 CFR PART 15 SUBPART C
ANSI C63.10:2013

Test Result : Complied

Performing Lab. : A Test Lab Techno Corp.

No. 140-1, Changan Street, Bade District,
Taoyuan City 33465, Taiwan (R.O.C)
Tel : +886-3-2710188 / Fax : +886-3-2710190



Taiwan Accreditation Foundation accreditation number: 1330
<http://www.atl-lab.com.tw/e-index.htm>

A Test Lab Techno Corp. tested the above equipment in accordance with the requirements set forth in the above standards. All indications of Pass/Fail in this report are opinions expressed by A Test Lab Techno Corp. based on interpretations and/or observations of test results. The test results show that the equipment tested is capable of demonstrating compliance with the requirements as documented in this report.

Approved By : Fly Lu Reviewed By : Eric Ou Yang
(Manager) (Fly Lu) (Testing Engineer) (Eric Ou Yang)



TABLE OF CONTENTS

1	General Information	5
2	EUT Description.....	7
3	Test Methodology.....	8
	3.1. Mode of Operation.....	8
	3.2. EUT Test Step.....	11
	3.3. Configuration of Test System Details.....	12
	3.4. Test Instruments	14
	3.5. Test Site Environment.....	15
4	Measurement Procedure.....	16
	4.1. AC Power Line Conducted Emission Measurement.....	16
	4.2. Radiated Emission Measurement.....	18
	4.3. Maximum Conducted Output Power Measurement.....	22
	4.4. 6 dB RF Bandwidth Measurement.....	23
	4.5. Maximum Power Spectral Density Measurement	24
	4.6. Out of Band Conducted Emissions Measurement.....	25
	4.7. Antenna Measurement	26
5	Test Results	27
	Annex A. Conducted Emission	27
	Annex B. Conducted Test Results	29
	Annex C. Radiated Emission Measurement.....	48



1 General Information

1.1 Summary of Test Result

Standard	Item	Result	Remark
FCC			
15.207	AC Power Conducted Emission	PASS	----
15.247(d)	Transmitter Radiated Emissions	PASS	----
15.247(b)(3)	Max. Output Power	PASS	----
15.247(a)(2)	6 dB RF Bandwidth	PASS	----
15.247(e)	Maximum Power Spectral Density	PASS	----
15.247(d)	Out of Band Conducted Spurious Emission	PASS	----
15.203	Antenna Requirement	PASS	----

The test results of this report relate only to the tested sample(s) identified in this report.

Standard	Description
CFR47, Part 15, Subpart C	Intentional Radiators
ANSI C63. 10: 2013	American National Standard of Procedures for Compliance Testing of Unlicensed Wireless Devices
KDB 558074 D01 v05	GUIDANCE FOR COMPLIANCE MEASUREMENTS ON DIGITAL TRANSMISSION SYSTEM, FREQUENCY HOPPING SPREAD SPECTRUM SYSTEM, AND HYBRID SYSTEM DEVICES OPERATING UNDER SECTION 15.247 OF THE FCC RULES



1.2 Measurement Uncertainty

Test Item	Frequency Range	Uncertainty (dB)
Conducted Emission	9 kHz ~ 150 kHz	2.7
	150 kHz ~ 30 MHz	2.7
Radiated Emission	9 kHz ~ 30 MHz	1.7
	30 MHz ~ 1000 MHz	5.7
	1000 MHz ~ 18000 MHz	5.5
	18000 MHz ~ 26500 MHz	4.8
	26500 MHz ~ 40000 MHz	4.8
Conducted Output Power	+0.27 dB / -0.28 dB	
RF Bandwidth	4.96 %	
Power Spectral Density	+0.71 dB / -0.77 dB	



2 EUT Description

Applicant	Ring LLC 1523 26th Street, Santa Monica CA 90404, United States			
Manufacturer	Ring Inc. 1523 26th Street, Santa Monica CA 90404, United States			
Product Type	Ring Doorbell V2			
Trade Name	Ring			
Model Number	Ring Video Doorbell 2			
FCC ID	2AEUPBHARG043			
Operate Freq. Band	Frequency Range (MHz)	Modulation	Channel Bandwidth	Data Rate 400 / 800 GI (ns)
IEEE 802.11b	2412 ~ 2462	DSSS	20 MHz	Up to 11 Mbps
IEEE 802.11g	2412 ~ 2462	OFDM	20 MHz	Up to 54 Mbps
IEEE 802.11n 2.4 GHz 20 MHz	2412 ~ 2462	OFDM	20 MHz	Up to 72.2 Mbps
Antenna information	Type			Max. Gain(dBi)
	Dipole Antenna			1.96
Antenna Delivery	See section 3.1			
Operate Temp. Range	-20 ~ +50 °C			

Frequency Band	Max. RF Output Power (W)
IEEE 802.11b	0.068
IEEE 802.11g	0.079
IEEE 802.11n 2.4 GHz 20 MHz	0.079

3 Test Methodology

3.1. Mode of Operation

Decision of Test ATL has verified the construction and function in typical operation. All the test modes were carried out with the EUT in normal operation, which was shown in this test report and defined as:

Test Mode
Mode 1: Transmit mode
Mode 2: IEEE 802.11b Continuous TX mode
Mode 3: IEEE 802.11g Continuous TX mode
Mode 4: IEEE 802.11n 2.4 GHz 20 MHz Continuous TX mode

Software used to control the EUT for staying in continuous transmitting mode was programmed.

After verification, all tests were carried out with the worst case test modes.

By preliminary testing and verifying three axis (X, Y and Z) position of EUT transmitted status, it was found that "X axis" position was the worst, then the final test was executed the worst condition and test data were recorded in this report.

Test Mode	Antenna Delivery	Data Rate	Test Channel
Mode 2	1TX	1 M	1, 6, 11
Mode 3	1TX	6 M	1, 6, 11
Mode 4	1TX	6.5 M	1, 6, 11

Duty cycle

Test Mode	Frequency (MHz)	on time (ms)	on+off time (ms)	Duty cycle	Duty Factor (dB)	1/T Minimum VBW (kHz)
Mode 2	2412	1.010	1.440	0.701	1.540	0.990
Mode 3	2412	0.370	1.060	0.349	4.571	2.703
Mode 4	2412	0.370	1.060	0.349	4.571	2.703



Duty Cycle Graphs

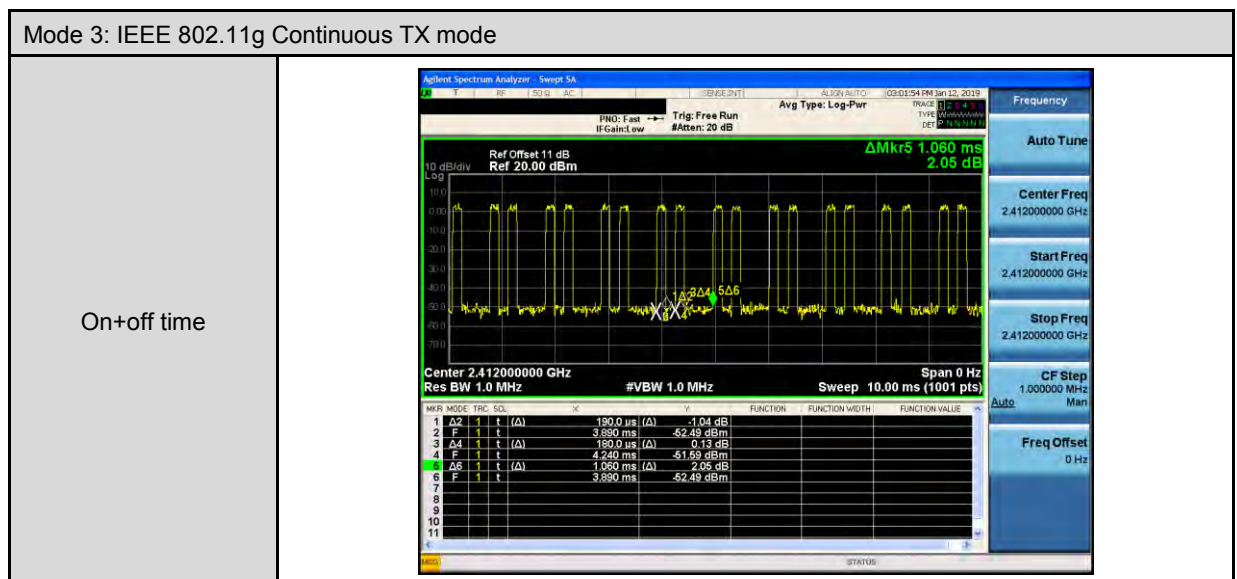
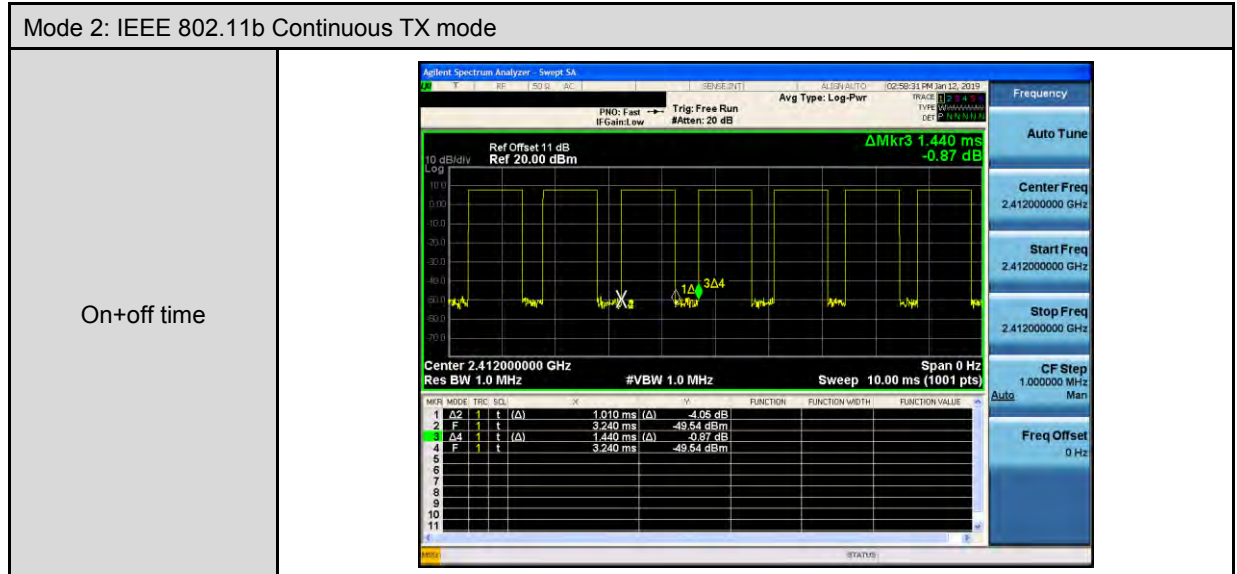

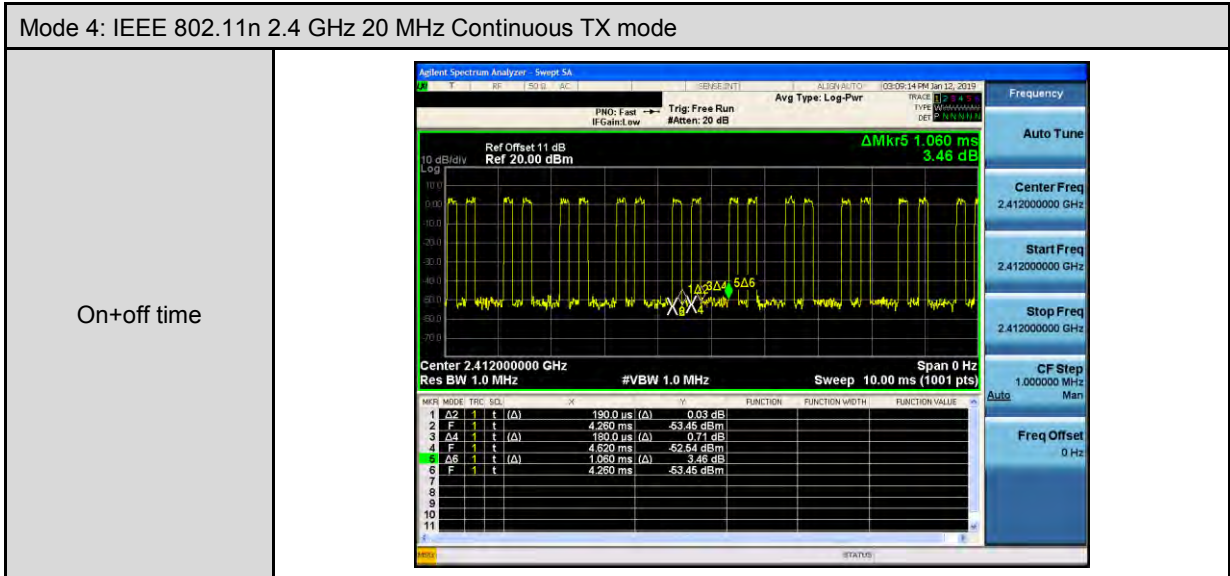



3.2. EUT Test Step

1.	Setup the EUT shown on "Configuration of Test System Details".
2.	Turn on the power of all equipment.
3.	Turn Wi-Fi function link to AP
4.	EUT run test program.

Measurement Software			
No.	Description	Software	Version
1	Conducted Emission	EZ EMC	1.1.4.3
2	Radiated Emission	EZ EMC	1.1.4.4

3.3. Configuration of Test System Details

Conducted Emissions

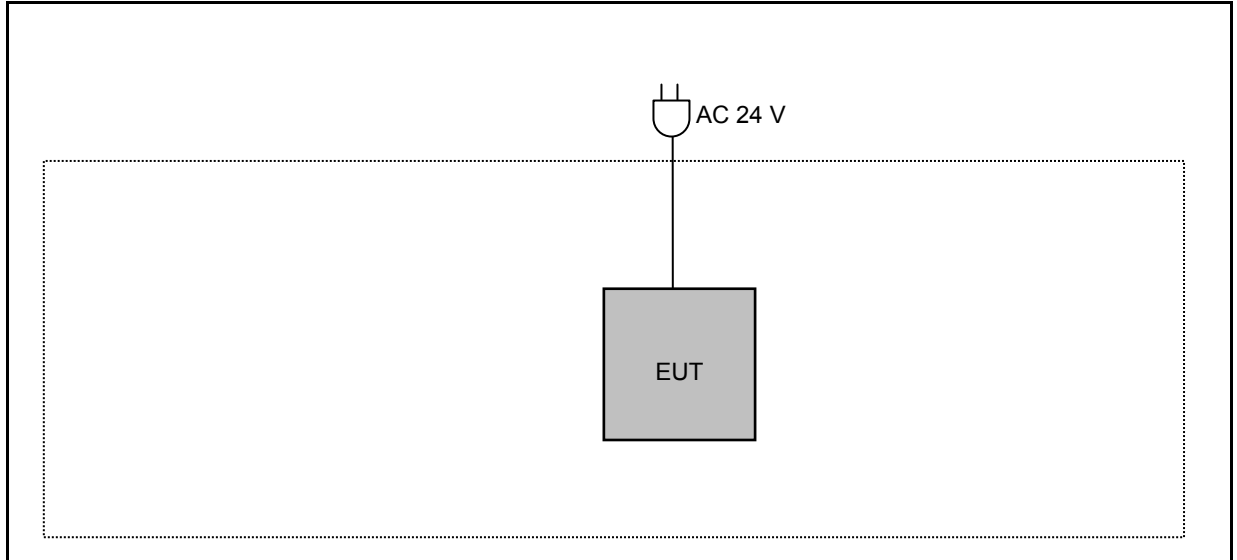

Radiated Emission_Below 1 GHz

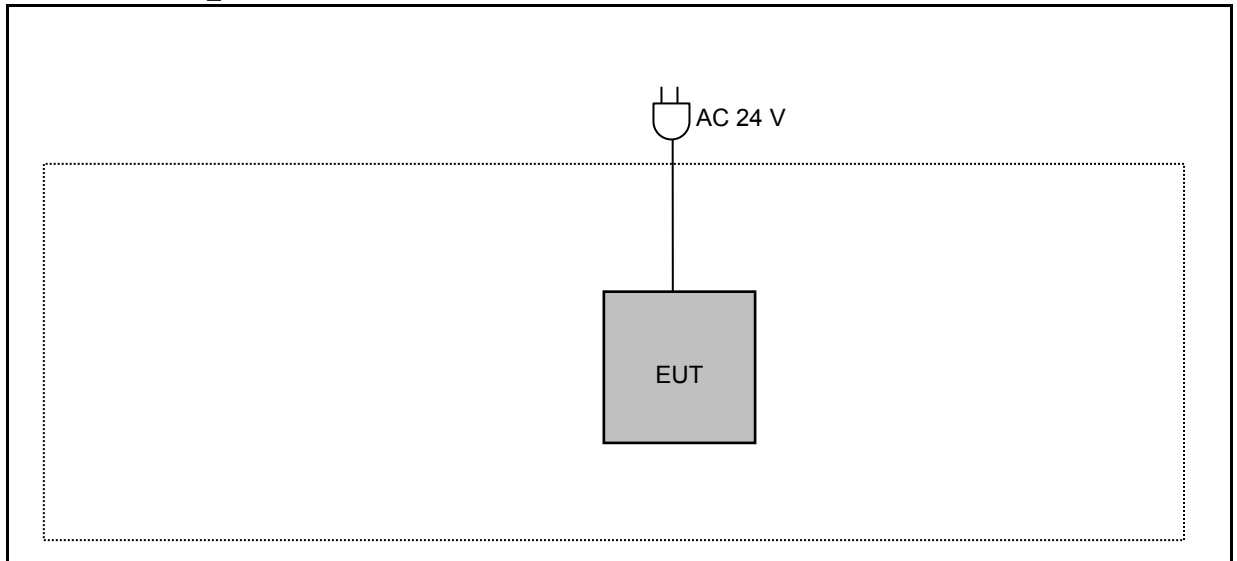

Radiated Emission_ Above 1 GHz

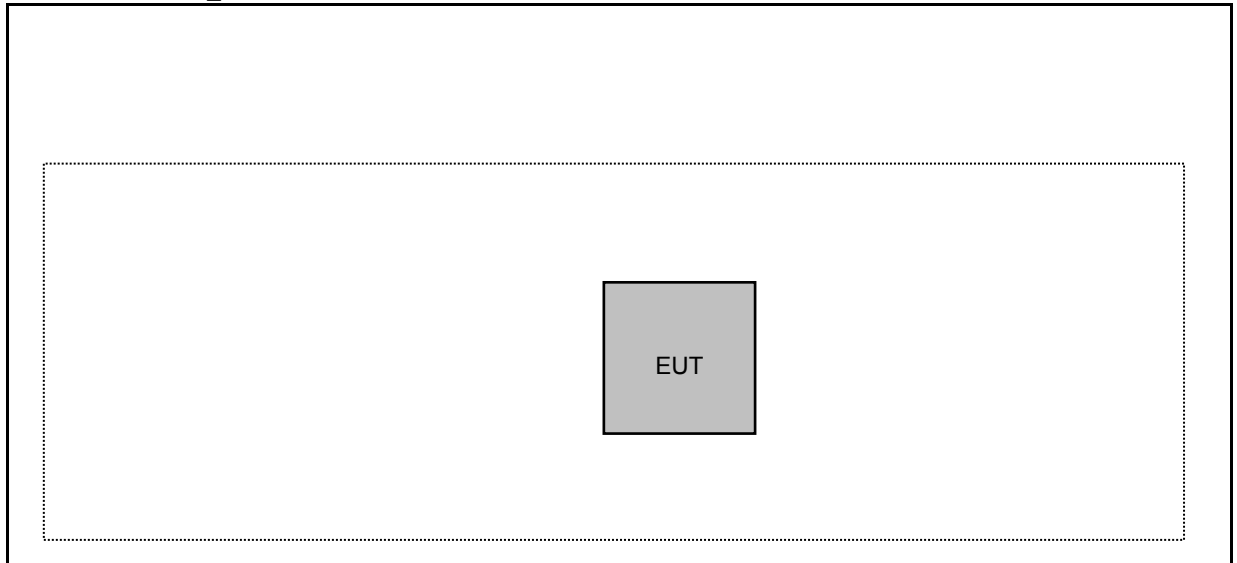

Devices Description					
	Product	Manufacturer	Model Number	Serial Number	Power Cord
(1)	---	---	---	---	---



3.4. Test Instruments

For Conducted Emission

Test Period: Jan. 15, 2019

Equipment	Manufacturer	Model Number	Serial Number	Cal. Date	Cal. Period
Test Receiver	R&S	ESCI	100367	05/21/2018	1 year
LISN	R&S	ENV216	101040	04/11/2018	1 year
LISN	R&S	ENV216	101041	03/23/2018	1 year
RF Cable	Woken	00100D1380194M	TE-02-03	05/17/2018	1 year

For Radiated Emissions

Test Period: Jan. 02 ~ Jan. 09, 2019

Equipment	Manufacturer	Model Number	Serial Number	Cal. Date	Cal. Period
Spectrum Analyzer (10 Hz~44 GHz)	Keysight	N9010A	MY52221312	01/15/2018	1 year
Pre Amplifier (1~26.5 GHz)	Agilent	8449B	MT-010	10/16/2018	1 year
Pre Amplifier (100 kHz~1.3 GHz)	Agilent	8447D	2944A11119	01/10/2018	1 year
Trilog Broadband Antenna	Schwarzbeck Mess-Elektronik	VULB9168	EX-041	10/23/2018	1 year
Horn Antenna (1~18 GHz)	SCHWARZBECK MESS-ELEKTRONIK	BBHA9120D	9120D-550	08/23/2018	1 year
Loop Antenna	COM-POWER CORPORATION	AL-130	121014	03/13/2018	1 year
RF Cable	EMCI	EMC104-N-N-6000	TE01-1	02/20/2018	1 year
Microwave Cable	EMCI	EMC102-KM-KM-1 4000	151001	02/20/2018	1 year
Broadband Horn Antenna	SCHWARZBECK MESS-ELEKTRONIK	9170	9170-320	08/07/2018	1 year
Microwave Cable	EMCI	EMC104-SM-SM-1 3000	170814	10/30/2018	1 year

For Conducted

Test Period: Jan. 12, 2019

Equipment	Manufacturer	Model Number	Serial Number	Cal. Date	Cal. Period
Spectrum Analyzer (20 Hz~26.5 GHz)	Agilent	N9020A	US47520902	09/25/2018	1 year
Power Sensor	Anritsu	MA2411B	1126022	08/29/2018	1 year
Power Meter	Anritsu	ML2495A	1135009	08/29/2018	1 year



3.5. Test Site Environment

Items	Required (IEC 60068-1)	Actual
Temperature (°C)	15-35	26
Humidity (%RH)	25-75	60
Barometric pressure (mbar)	860-1060	990

4 Measurement Procedure

4.1. AC Power Line Conducted Emission Measurement

■ Limit

Frequency (MHz)	Quasi-peak	Average
0.15 - 0.5	66 to 56	56 to 46
0.50 - 5.0	56	46
5.0 - 30.0	60	50

■ Test Setup

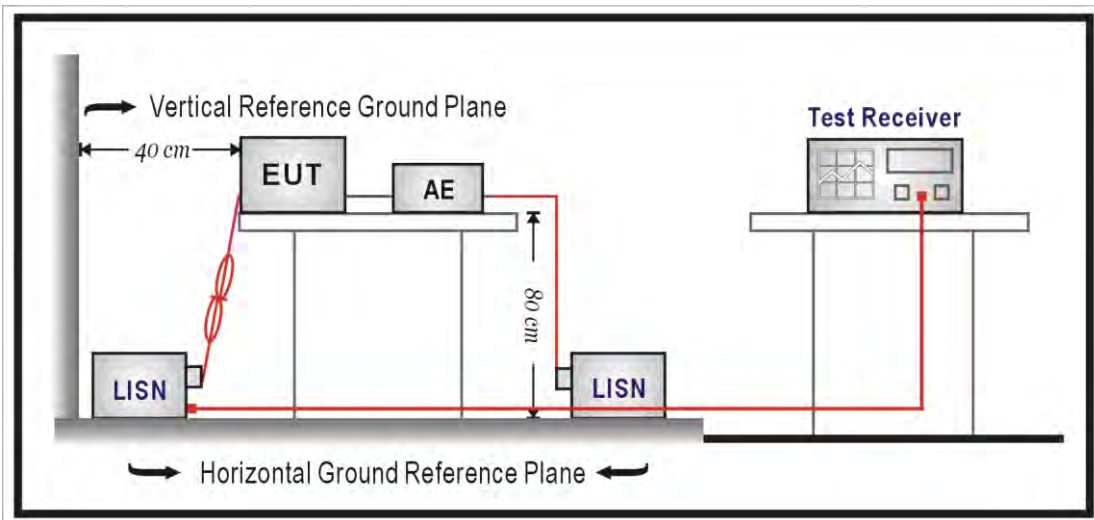

■ Test Procedure

The EUT and simulators are connected to the main power through a line impedance stabilization network (L.I.S.N.). This provides a $50 \Omega // 50 \mu\text{H}$ coupling impedance for the measuring equipment. The peripheral devices are also connected to the main power through a LISN that provides a $50 \Omega // 50 \mu\text{H}$ coupling impedance with 50 ohm termination.

Tabletop device shall be placed on a non-conducting platform, of nominal size 1 m by 1.5 m, raised 80 cm above the reference ground plane. The wall of screened room shall be located 40 cm to the rear of the EUT. Other surfaces of tabletop or floor standing EUT shall be at least 80 cm from any other ground conducting surface including one or more LISNs. For floor-standing device shall be placed under the EUT with a 12 mm insulating material.

Conducted emissions were investigated over the frequency range from 0.15 MHz to 30 MHz using a resolution bandwidth of 9 kHz. The equipment under test (EUT) shall be meet the limits in section 4.1, as applicable, including the average limit and the quasi-peak limit when using respectively, an average detector and quasi-peak detector measured in accordance with the methods described of related standard. When all of peak value were complied with quasi-peak and average limit from 150 kHz to 30 MHz then quasi-peak and average measurement was unnecessary.

The AMN shall be placed 0.8 m from the boundary of the unit under test and bonded to a ground reference plane for AMNs mounted on top of the ground reference plane. This distance is between the closest points of the AMN and the EUT. All other units of the EUT and associated equipment shall be at least 0.8 m from the AMN. If the mains power cable is longer than 1 m then the cable shall be folded back and forth at the centre of the lead to form a bundle no longer than 0.4 m. All of interconnecting cables that hang closer than 40 cm to the ground plane shall be folded back and forth in the center forming a bundle 30 cm to 40 cm long. All of EUT and AE shall be separate place more than 0.1 m. All 50Ω ports of the LISN shall be resistively terminated into 50Ω loads when not connected to the measuring instrument.

If the reading of the measuring receiver shows fluctuations close to the limit, the reading shall be observed for at least 15 s at each measurement frequency; the higher reading shall be recorded with the exception of any brief isolated high reading which shall be ignored.

4.2. Radiated Emission Measurement

■ Limit

According to §15.209(a), except as provided elsewhere in this subpart, the emissions from an intentional radiator shall not exceed the field strength levels specified in the following table:

Frequency (MHz)	Field Strength ($\mu\text{V}/\text{m}$ at meter)	Measurement Distance (meters)
0.009 – 0.490	$2400 / F$ (kHz)	300
0.490 – 1.705	$24000 / F$ (kHz)	30
1.705 – 30.0	30	30
30 - 88	100**	3
88-216	150**	3
216-960	200**	3
Above 960	500	3

** Except as provided in paragraph (g), fundamental emissions from intentional radiators operating under this Section shall not be located in the frequency bands 54-72 MHz, 76-88 MHz, 174-216 MHz or 470-806 MHz. However, operation within these frequency bands is permitted under other sections of this Part, e.g., Sections 15.231 and 15.241.

■ Setup

9 kHz ~ 30 MHz

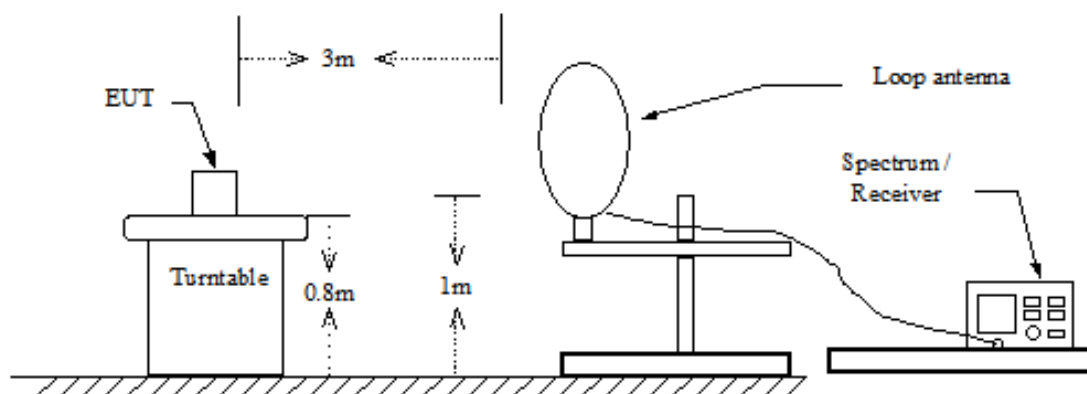

Below 1 GHz

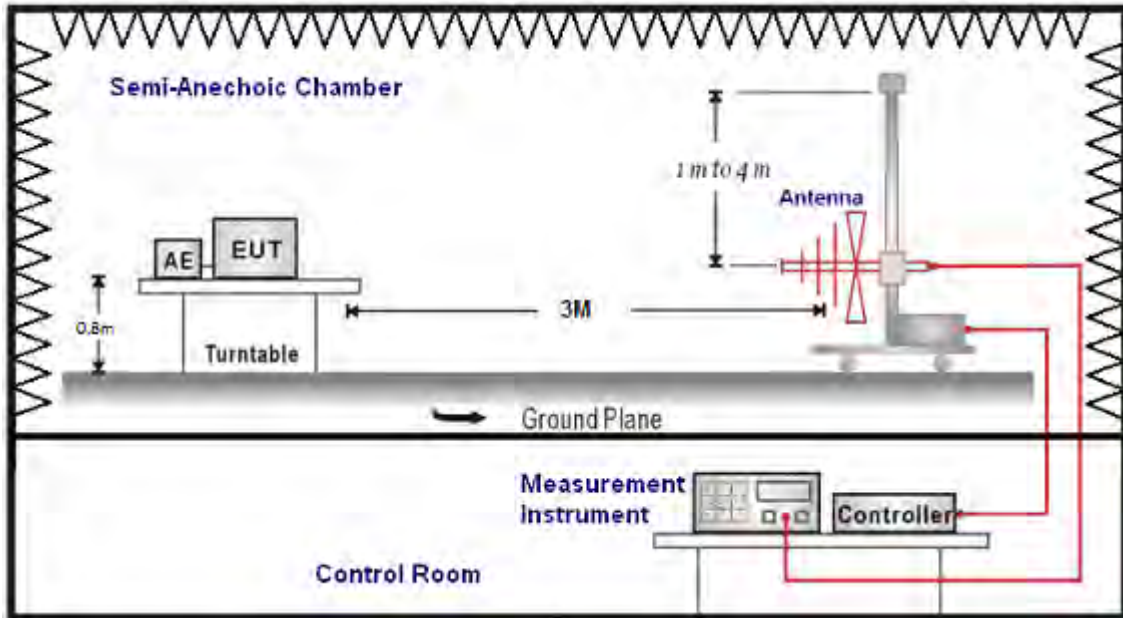

Above 1 GHz

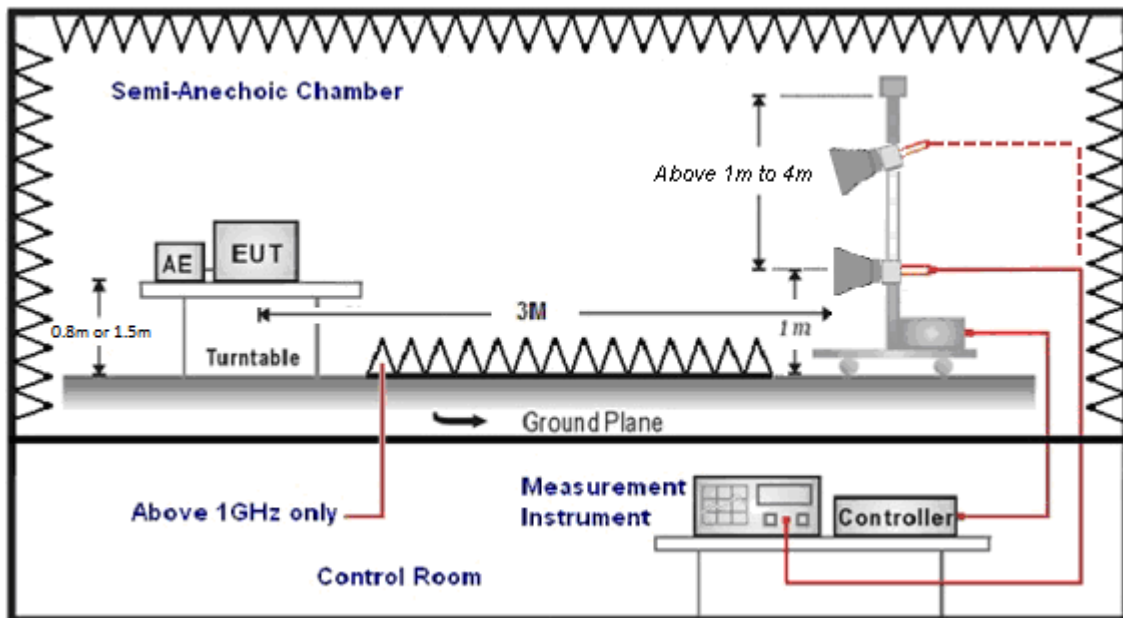

■ Test Procedure

Final radiation measurements were made on a three-meter, Semi Anechoic Chamber. The EUT system was placed on a nonconductive turntable which is 0.8 or 1.5 meters height, top surface 1.0 x 1.5 meter. The spectrum was examined from 250 MHz to 2.5 GHz in order to cover the whole spectrum below 10th harmonic which could generate from the EUT. During the test, EUT was set to transmit continuously & Measurements spectrum range from 9 kHz to 26.5 GHz is investigated.

For measurements below 1 GHz the resolution bandwidth is set to 100 kHz for peak detection measurements or 120 kHz for quasi-peak detection measurements. Peak detection is used unless otherwise noted as quasi-peak.

For measurements above 1 GHz the resolution bandwidth is set to 1 MHz, and then the video bandwidth is set to 3 MHz for peak measurements and 10 Hz for average measurements when Duty cycle >0.98 / $1/T$ for average measurements when Duty cycle <0.98 . A nonconductive material surrounded the EUT to supporting the EUT for standing on three orthogonal planes. At each condition, the EUT was rotated 360 degrees, and the antenna was raised and lowered from one to four meters to find the maximum emission levels. Measurements were taken using both horizontal and vertical antenna polarization.

SCHWARZBECK MESS-ELEKTRONIK Biconilog Antenna at 3 Meter and the SCHWARZBECK Double Ridged Guide Antenna was used in frequencies 1 –26.5 GHz at a distance of 3 meter. The antenna at an angle toward the source of the emission. All test results were extrapolated to equivalent signal at 3 meters utilizing an inverse linear distance extrapolation Factor (20 dB/decade).

For testing above 1 GHz, the emission level of the EUT in peak mode was 20 dB lower than average limit (that means the emission level in peak mode also complies with the limit in average mode), then testing will be stopped and peak values of EUT will be reported, otherwise, the emissions will be measured in average mode again and reported.

Appropriate preamplifiers were used for improving sensitivity and precautions were taken to avoid overloading or desensitizing the spectrum analyzer. No post – detector video filters were used in the test.

The spectrum analyzer's 6 dB bandwidth was set to 1 MHz, and the analyzer was operated in the peak detection mode, for frequencies both below and up 1 GHz. The average levels were obtained by subtracting the duty cycle correction factor from the peak readings.

The following procedures were used to convert the emission levels measured in decibels referenced to 1 microvolt (dBuV) into field intensity in micro volts pre meter (uV/m).

The actual field intensity in decibels referenced to 1 microvolt in to field intensity in micro volts per meter (dBuV/m).



The actual field intensity in referenced to 1 microvolt per meter (dBuV/m) is determined by algebraically adding the measured reading in dBuV, the antenna factor (dB), and cable loss (dB) and Subtracting the gain of preamplifier (dB) is auto calculate in spectrum analyzer.

(1) $\text{Amplitude (dBuV/m)} = \text{FI (dBuV)} + \text{AF (dBuV)} + \text{CL (dBuV)} - \text{Gain (dB)}$

FI= Reading of the field intensity.

AF= Antenna factor.

CL= Cable loss.

P.S Amplitude is auto calculate in spectrum analyzer.

(2) $\text{Actual Amplitude (dBuV/m)} = \text{Amplitude (dBuV)} - \text{Dis(dB)}$

The FCC specified emission limits were calculated according the EUT operating frequency and by following linear interpolation equations:

(a) For fundamental frequency : Transmitter Output < +30 dBm

(b) For spurious frequency : Spurious emission limits = fundamental emission limit /10

Data of measurement within this frequency range without mark in the table above means the reading of emissions are attenuated more than 20 dB below the permissible limits or the field strength is too small to be measured.

4.3. Maximum Conducted Output Power Measurement

■ Limit

For systems using digital modulation in the 2400-2483.5 MHz, the limit for maximum output power is 30 dBm.

And According to 15.247 (b), if transmitting antennas of directional gain greater than 6 dBi are used, the power shall be reduced by the amount in dB that the directional gain of the antenna exceeds 6 dBi.

■ Test Setup

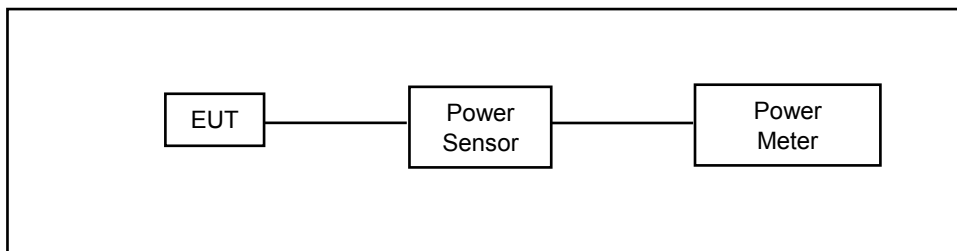

■ Test Procedure

The testing follows the Measurement Procedure of ANSI C63.10:2013 section 11.9.2.3.2 Method AVGPM.

The tests below are run with the EUT's transmitter set at high power in TX mode. The EUT is needed to force selection of output power level and channel number. While testing, EUT was set to transmit continuously. Remove the Subjective device's antenna and connect the RF output port to power sensor.

4.4. 6 dB RF Bandwidth Measurement

■ Limit

6 dB RF Bandwidth: Systems using digital modulation techniques may operate in the 2400–2483.5 MHz bands. The minimum 6 dB band-width shall be at least 500 kHz.

■ Test Setup

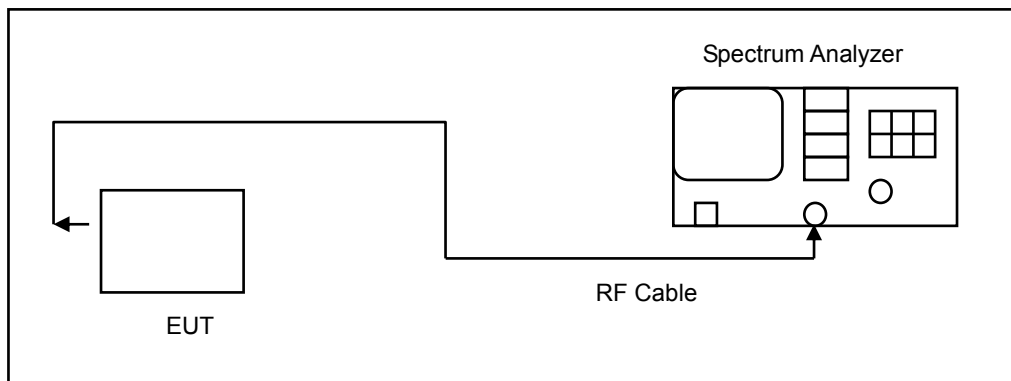

■ Test Procedure

The EUT tested to DTS test procedure of ANSI C63.10:2013 section 11.8.2 option2 for compliance to FCC 47CFR 15.247 requirements.

6 dB RF Bandwidth: The antenna port of the EUT was connected to the input of a spectrum analyzer. Analyzer RBW was set to 100 kHz. For each RF output channel investigated, the spectrum analyzer center frequency was set to the channel carrier. A peak output reading was taken, a DISPLAY line was drawn 6 dB lower than peak level. The 6 dB bandwidth was determined from where the channel output spectrum intersected the display line.

The test was performed at 3 channels (Channel low, middle, high)

4.5. Maximum Power Spectral Density Measurement

■ Limit

For digitally modulated systems, the power spectral density conducted from the intentional radiator to the antenna shall not be greater than 8 dBm in any 3 kHz band during any time interval of continuous transmission.

■ Test Setup

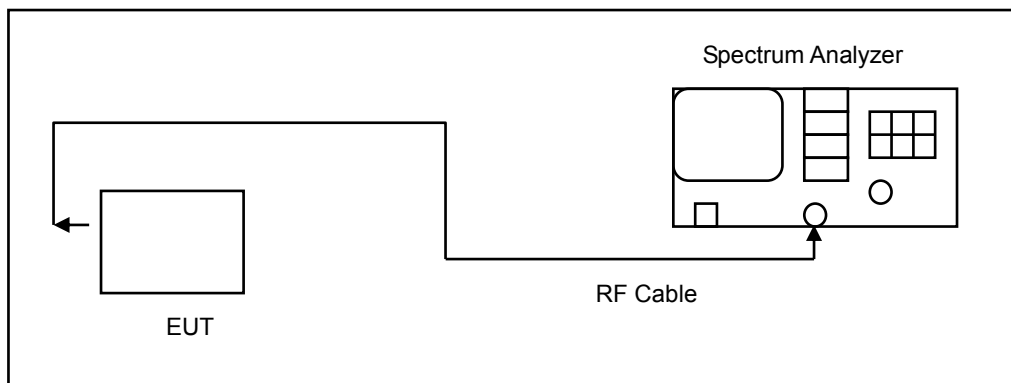

■ Test Procedure

The EUT tested to DTS test procedure of ANSI C63.10:2013 section 11.10.2 Method PKPSD for compliance to FCC 47CFR 15.247 requirements.

1. Set analyzer center frequency to DTS channel center frequency.
2. Set the span to 1.5 times the DTS bandwidth.
3. Set the RBW to: $3 \text{ kHz} \leq \text{RBW} \leq 100 \text{ kHz}$.
4. Set the VBW $\geq 3 \times \text{RBW}$.
5. Detector = peak.
6. Sweep time = auto couple.
7. Trace mode = max hold.
8. Allow trace to fully stabilize.
9. Use the peak marker function to determine the maximum amplitude level within the RBW.
10. If measured value exceeds limit, reduce RBW (no less than 3 kHz) and repeat.

4.6. Out of Band Conducted Emissions Measurement

■ Limit

In any 100 kHz bandwidth outside the frequency band in which the spread spectrum or digitally modulated intentional radiator is operating, the radio frequency power that is produced by the intentional radiator shall be at least 20 dB below that in the 100 kHz bandwidth within the band that contains the highest level of the desired power

■ Test Setup

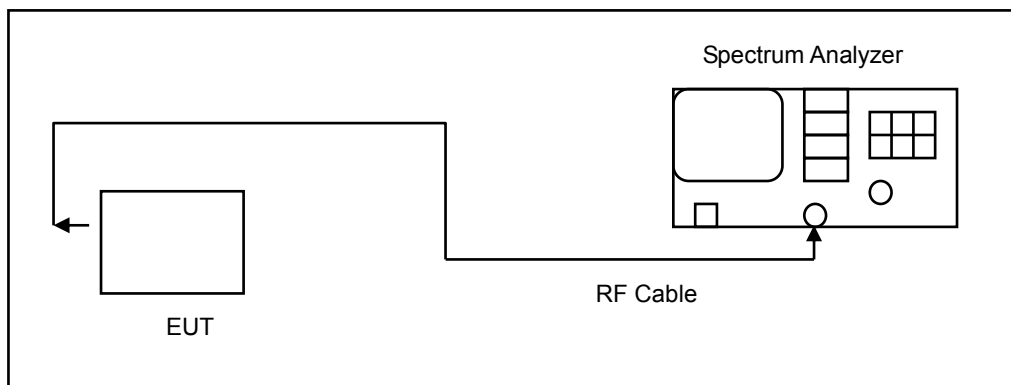

■ Test Procedure

In any 100 kHz bandwidth outside the EUT pass band, the RF power produced by the modulation products of the spreading sequence, the information sequence, and the carrier frequency shall be at least 20 Db below that of the maximum in-band 100 kHz emission, antenna output of the EUT was coupled directly to spectrum analyzer; if an external attenuator and/or cable was used, these losses are compensated for with the analyzer OFFSET function. All other types of emissions from the EUT shall meet the general limits for radiated frequencies outside the pass band. The test was performed at 3 channels.



4.7. Antenna Measurement

■ Limit

For intentional device, according to 15.203, an intentional radiator shall be designed to ensure that no antenna other than that furnished by the responsible party shall be used with the device.

And According to 15.247 (b), if transmitting antennas of directional gain greater than 6 dBi are used, the power shall be reduced by the amount in dB that the directional gain of the antenna exceeds 6 dBi.

■ Antenna Description

See section 2 – antenna information.



5 Test Results

Annex A. Conducted Emission

Standard:	FCC Part 15.247	Line:	L1
Test item:	Conducted Emission	Power:	AC 24 V/60 Hz
Test Mode:	Mode 1	Temp.(°C)/Hum.(%RH):	26(°C)/60 %RH
Description:			

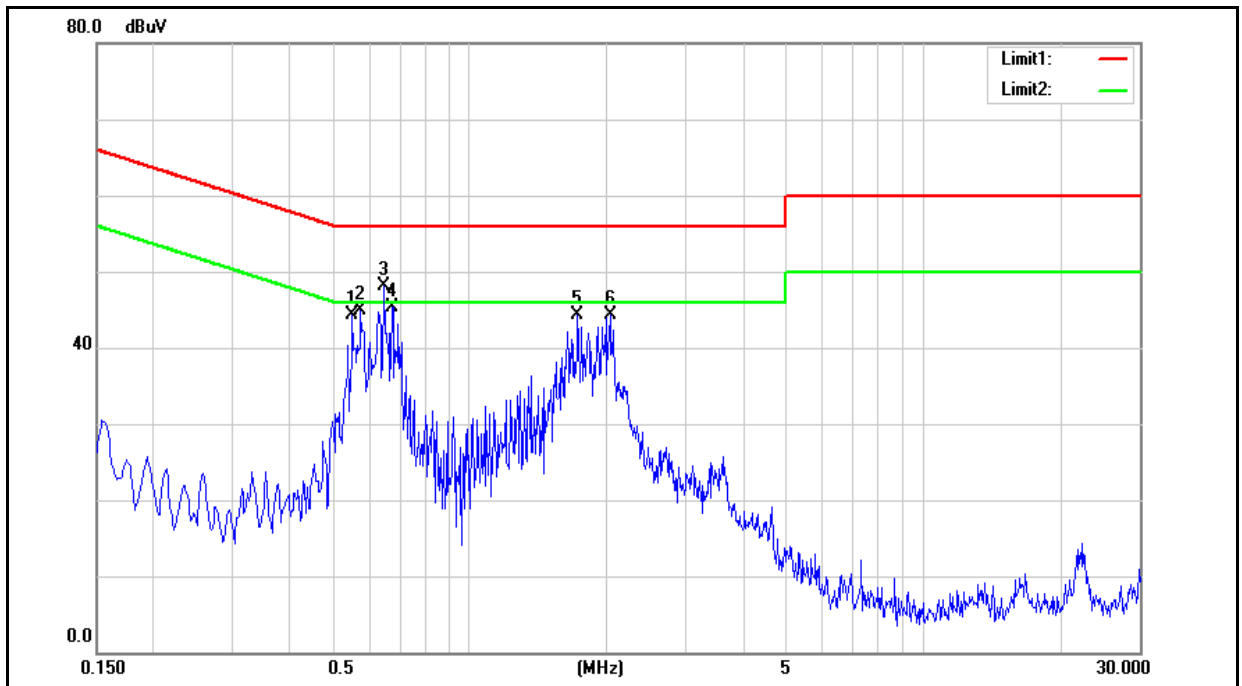

No.	Frequency (MHz)	QP reading (dBuV)	AVG reading (dBuV)	Correction factor (dB)	QP result (dBuV)	AVG result (dBuV)	QP limit (dBuV)	AVG limit (dBuV)	QP margin (dB)	AVG margin (dB)	Remark
1	0.5500	39.49	30.60	0.05	39.54	30.65	56.00	46.00	-16.46	-15.35	Pass
2	0.5740	41.16	30.64	0.05	41.21	30.69	56.00	46.00	-14.79	-15.31	Pass
3	0.6460	45.90	39.14	0.06	45.96	39.20	56.00	46.00	-10.04	-6.80	Pass
4	0.6740	44.09	36.77	0.06	44.15	36.83	56.00	46.00	-11.85	-9.17	Pass
5	1.7340	42.07	33.89	0.09	42.16	33.98	56.00	46.00	-13.84	-12.02	Pass
6	2.0420	41.74	33.03	0.10	41.84	33.13	56.00	46.00	-14.16	-12.87	Pass

Note: 1. Result (dBuV) = Correction factor (dB) + Reading(dBuV).

2. Correction factor (dB) = Cable loss (dB) + L.I.S.N. factor (dB).



Standard:	FCC Part 15.247	Line:	N
Test item:	Conducted Emission	Power:	AC 24 V/60 Hz
Test Mode:	Mode 1	Temp.(°C)/Hum.(%RH):	26(°C)/60 %RH
Description:			

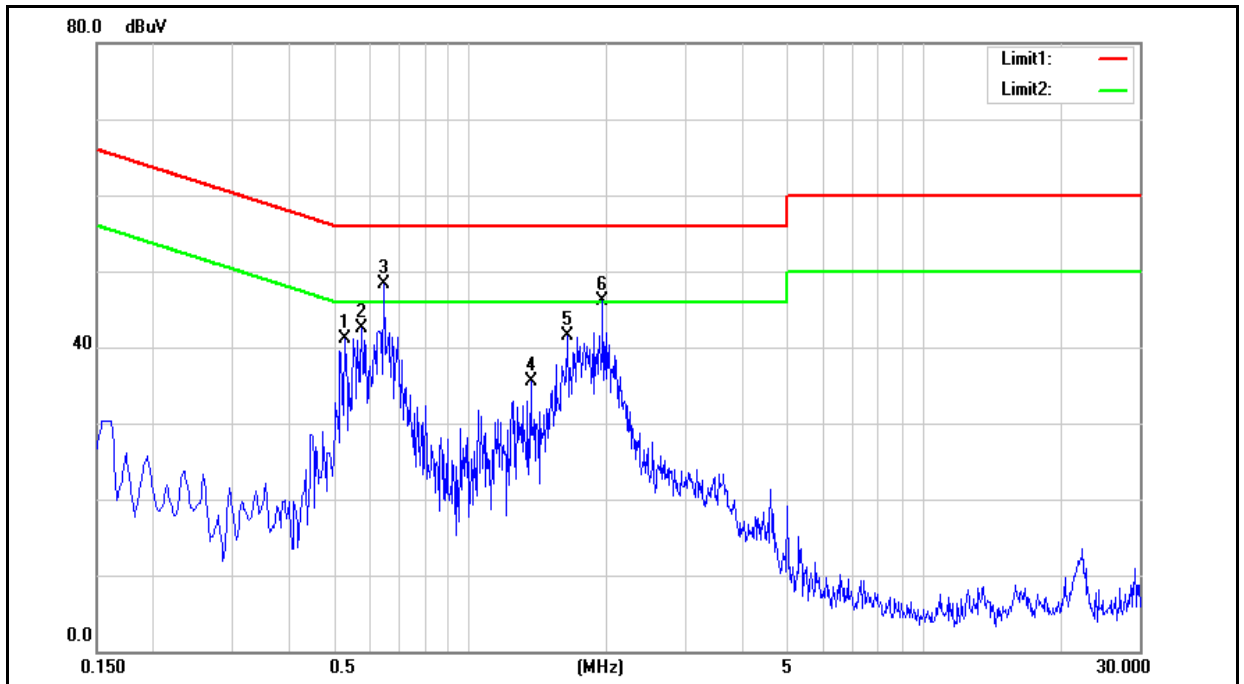

No.	Frequency (MHz)	QP reading (dBuV)	AVG reading (dBuV)	Correction factor (dB)	QP result (dBuV)	AVG result (dBuV)	QP limit (dBuV)	AVG limit (dBuV)	QP margin (dB)	AVG margin (dB)	Remark
1	0.5300	33.84	20.82	0.05	33.89	20.87	56.00	46.00	-22.11	-25.13	Pass
2	0.5780	36.03	24.84	0.05	36.08	24.89	56.00	46.00	-19.92	-21.11	Pass
3	0.6460	40.25	34.19	0.06	40.31	34.25	56.00	46.00	-15.69	-11.75	Pass
4	1.3660	30.14	23.21	0.08	30.22	23.29	56.00	46.00	-25.78	-22.71	Pass
5	1.6420	36.16	28.43	0.09	36.25	28.52	56.00	46.00	-19.75	-17.48	Pass
6	1.9660	42.11	33.71	0.10	42.21	33.81	56.00	46.00	-13.79	-12.19	Pass

Note: 1. Result (dBuV) = Correction factor (dB) + Reading(dBuV).

2. Correction factor (dB) = Cable loss (dB) + L.I.S.N. factor (dB).



Annex B. Conducted Test Results

Maximum Conducted Output Power Measurement

Test Mode	Frequency (MHz)	Data Rate	Average Output Power		Peak Output Power		
			Measurement Results		Measurement Results		Limit
			(dBm)	(W)	(dBm)	(W)	(dBm)
Mode 2	2412	1 M	14.96	0.031	17.07	0.051	≤ 30
	2437		15.91	0.039	17.89	0.062	≤ 30
	2462		16.41	0.044	18.31	0.068	≤ 30
	2437	2 M	15.85	0.038	17.85	0.061	≤ 30
	2437	5.5 M	15.75	0.038	17.84	0.061	≤ 30
	2437	11 M	15.86	0.039	17.86	0.061	≤ 30
Mode 3	2412	6 M	10.42	0.011	17.88	0.061	≤ 30
	2437		15.51	0.036	18.99	0.079	≤ 30
	2462		11.80	0.015	18.47	0.070	≤ 30
	2437	9 M	15.45	0.035	18.90	0.078	≤ 30
	2437	12 M	15.40	0.035	18.92	0.078	≤ 30
	2437	18 M	15.43	0.035	18.95	0.079	≤ 30
	2437	24 M	15.46	0.035	18.93	0.078	≤ 30
	2437	36 M	15.45	0.035	18.93	0.078	≤ 30
	2437	48 M	15.46	0.035	18.94	0.078	≤ 30
	2437	54 M	15.48	0.035	18.95	0.079	≤ 30
Mode 4	2412	6.5 M	10.46	0.011	17.88	0.061	≤ 30
	2437		14.74	0.030	18.97	0.079	≤ 30
	2462		11.74	0.015	18.67	0.074	≤ 30
	2437	14.4 M	14.70	0.030	18.90	0.078	≤ 30
	2437	21.7 M	14.68	0.029	18.89	0.077	≤ 30
	2437	28.9 M	14.69	0.029	18.88	0.077	≤ 30
	2437	43.3 M	14.70	0.030	18.90	0.078	≤ 30
	2437	57.8 M	14.66	0.029	18.92	0.078	≤ 30
	2437	65 M	14.68	0.029	18.91	0.078	≤ 30
	2437	72.2 M	14.68	0.029	18.89	0.077	≤ 30

Note: The relevant measured result has the offset with cable loss already.



6 dB RF Bandwidth Measurement

Test Mode	Frequency (MHz)	Measurement Results	Limit
		(kHz)	(kHz)
Mode 2	2412	9560	≥ 500
	2437	10050	≥ 500
	2462	10030	≥ 500
Mode 3	2412	15120	≥ 500
	2437	15130	≥ 500
	2462	15120	≥ 500
Mode 4	2412	15110	≥ 500
	2437	15130	≥ 500
	2462	15140	≥ 500

■ Test Graphs

Mode 2: IEEE 802.11b link mode	
2412	<p>Agilent Spectrum Analyzer - Occupied BW</p> <p>Center Freq: 2.41200000 GHz</p> <p>Occupied Bandwidth: 14.341 MHz</p> <p>Total Power: 21.6 dBm</p> <p>Transmit Freq Error: 60.431 kHz</p> <p>x dB Bandwidth: 9.560 MHz</p>
2437	<p>Agilent Spectrum Analyzer - Occupied BW</p> <p>Center Freq: 2.43700000 GHz</p> <p>Occupied Bandwidth: 14.578 MHz</p> <p>Total Power: 22.1 dBm</p> <p>Transmit Freq Error: 93.577 kHz</p> <p>x dB Bandwidth: 10.05 MHz</p>
2462	<p>Agilent Spectrum Analyzer - Occupied BW</p> <p>Center Freq: 2.46200000 GHz</p> <p>Occupied Bandwidth: 14.761 MHz</p> <p>Total Power: 22.6 dBm</p> <p>Transmit Freq Error: 92.139 kHz</p> <p>x dB Bandwidth: 10.03 MHz</p>



Mode 3: IEEE 802.11g link mode	
2412	<p>Agilent Spectrum Analyzer - Occupied BW</p> <p>Center Freq: 2.412000000 GHz</p> <p>Ref 20.00 dBm</p> <p>Occupied Bandwidth: 16.287 MHz</p> <p>Total Power: 16.0 dBm</p> <p>Transmit Freq Error: 18.334 kHz</p> <p>x dB Bandwidth: 15.12 MHz</p> <p>OBW Power: 99.00 %</p> <p>x dB: -6.00 dB</p>
2437	<p>Agilent Spectrum Analyzer - Occupied BW</p> <p>Center Freq: 2.437000000 GHz</p> <p>Ref 20.00 dBm</p> <p>Occupied Bandwidth: 17.962 MHz</p> <p>Total Power: 21.6 dBm</p> <p>Transmit Freq Error: 282.81 kHz</p> <p>x dB Bandwidth: 15.13 MHz</p> <p>OBW Power: 99.00 %</p> <p>x dB: -6.00 dB</p>
2462	<p>Agilent Spectrum Analyzer - Occupied BW</p> <p>Center Freq: 2.462000000 GHz</p> <p>Ref 20.00 dBm</p> <p>Occupied Bandwidth: 16.319 MHz</p> <p>Total Power: 17.7 dBm</p> <p>Transmit Freq Error: 23.696 kHz</p> <p>x dB Bandwidth: 15.12 MHz</p> <p>OBW Power: 99.00 %</p> <p>x dB: -6.00 dB</p>



Mode 4: IEEE 802.11n 2.4 GHz 20 MHz link mode	
2412	<p>Agilent Spectrum Analyzer - Occupied BW</p> <p>Center Freq 2.41200000 GHz</p> <p>Center Freq: 2.41200000 GHz</p> <p>Trig: Free Run</p> <p>Avg/Hold: 10/10</p> <p>Radio Std: None</p> <p>Radio Device: BTS</p> <p>Ref 20.00 dBm</p> <p>Center 2.412 GHz</p> <p>Res BW 100 kHz</p> <p>#VBW 300 kHz</p> <p>Span 30 MHz</p> <p>Sweep 2.933 ms</p> <p>Occupied Bandwidth 17.417 MHz</p> <p>Total Power 16.3 dBm</p> <p>Transmit Freq Error 37.243 kHz</p> <p>OBW Power 99.00 %</p> <p>x dB Bandwidth 15.11 MHz</p> <p>x dB -6.00 dB</p> <p>Frequency 2.41200000 GHz</p> <p>CF Step 3.000000 MHz</p> <p>Freq Offset 0 Hz</p>
2437	<p>Agilent Spectrum Analyzer - Occupied BW</p> <p>Center Freq 2.437000000 GHz</p> <p>Center Freq: 2.437000000 GHz</p> <p>Trig: Free Run</p> <p>Avg/Hold: 10/10</p> <p>Radio Std: None</p> <p>Radio Device: BTS</p> <p>Ref 20.00 dBm</p> <p>Center 2.437 GHz</p> <p>Res BW 100 kHz</p> <p>#VBW 300 kHz</p> <p>Span 30 MHz</p> <p>Sweep 2.933 ms</p> <p>Occupied Bandwidth 17.727 MHz</p> <p>Total Power 20.8 dBm</p> <p>Transmit Freq Error 60.055 kHz</p> <p>OBW Power 99.00 %</p> <p>x dB Bandwidth 15.13 MHz</p> <p>x dB -6.00 dB</p> <p>Frequency 2.437000000 GHz</p> <p>CF Step 3.000000 MHz</p> <p>Freq Offset 0 Hz</p>
2462	<p>Agilent Spectrum Analyzer - Occupied BW</p> <p>Center Freq 2.462000000 GHz</p> <p>Center Freq: 2.462000000 GHz</p> <p>Trig: Free Run</p> <p>Avg/Hold: 10/10</p> <p>Radio Std: None</p> <p>Radio Device: BTS</p> <p>Ref 20.00 dBm</p> <p>Center 2.462 GHz</p> <p>Res BW 100 kHz</p> <p>#VBW 300 kHz</p> <p>Span 30 MHz</p> <p>Sweep 2.933 ms</p> <p>Occupied Bandwidth 17.460 MHz</p> <p>Total Power 17.6 dBm</p> <p>Transmit Freq Error 39.276 kHz</p> <p>OBW Power 99.00 %</p> <p>x dB Bandwidth 15.14 MHz</p> <p>x dB -6.00 dB</p> <p>Frequency 2.462000000 GHz</p> <p>CF Step 3.000000 MHz</p> <p>Freq Offset 0 Hz</p>



**Maximum Power Spectral Density Measurement**

Test Mode	Frequency (MHz)	Measurement (dBm/3 kHz)	Limit (dBm/3 kHz)
Mode 2	2412	-10.379	≤ 8
	2437	-9.663	≤ 8
	2462	-9.275	≤ 8
Mode 3	2412	-16.040	≤ 8
	2437	-11.065	≤ 8
	2462	-14.860	≤ 8
Mode 4	2412	-14.818	≤ 8
	2437	-10.774	≤ 8
	2462	-13.628	≤ 8

■ Test Graphs

Mode 2: IEEE 802.11b Continuous TX mode	
2412	
2437	
2462	



Mode 3: IEEE 802.11g Continuous TX mode	
2412	 <p>Agilent Spectrum Analyzer - Swept SA</p> <p>Ref Offset: 11 dB, Ref: 11.00 dBm</p> <p>Mkr1 2.412 948 024 GHz, -16.040 dBm</p> <p>Center 2.412000 GHz, Span 22.68 MHz, #Res BW 3.0 kHz, #VBW 10 kHz, Sweep 2.392 s (40001 pts)</p>
2437	 <p>Agilent Spectrum Analyzer - Swept SA</p> <p>Ref Offset: 11 dB, Ref: 11.00 dBm</p> <p>Mkr1 2.438 581 1 GHz, -11.065 dBm</p> <p>Center 2.437000 GHz, Span 22.70 MHz, #Res BW 3.0 kHz, #VBW 10 kHz, Sweep 2.395 s (40001 pts)</p>
2462	 <p>Agilent Spectrum Analyzer - Swept SA</p> <p>Ref Offset: 11 dB, Ref: 11.00 dBm</p> <p>Mkr1 2.461 074 656 GHz, -14.860 dBm</p> <p>Center 2.462000 GHz, Span 22.68 MHz, #Res BW 3.0 kHz, #VBW 10 kHz, Sweep 2.392 s (40001 pts)</p>





Mode 4: IEEE 802.11n 2.4 GHz 20 MHz Continuous TX mode	
2412	<p>Agilent Spectrum Analyzer - Swept SA</p> <p>Ref Offset: 11 dB Ref: 11.00 dBm</p> <p>Mkr1 2.414 517 5 GHz -14.818 dBm</p> <p>Center 2.412000 GHz #Res BW 3.0 kHz #VBW 10 kHz Sweep 2.392 s (40001 pts)</p> <p>Span 22.67 MHz</p> <p>Frequency</p> <ul style="list-style-type: none">Auto TuneCenter Freq: 2.41200000 GHzStart Freq: 2.400665000 GHzStop Freq: 2.423335000 GHzCF Step: 2.267000 MHz (Auto)Freq Offset: 0 Hz
2437	<p>Agilent Spectrum Analyzer - Swept SA</p> <p>Ref Offset: 11 dB Ref: 11.00 dBm</p> <p>Mkr1 2.438 306 4 GHz -10.774 dBm</p> <p>Center 2.437000 GHz #Res BW 3.0 kHz #VBW 10 kHz Sweep 2.395 s (40001 pts)</p> <p>Span 22.70 MHz</p> <p>Frequency</p> <ul style="list-style-type: none">Auto TuneCenter Freq: 2.437000000 GHzStart Freq: 2.426650000 GHzStop Freq: 2.448350000 GHzCF Step: 2.270000 MHz (Auto)Freq Offset: 0 Hz
2462	<p>Agilent Spectrum Analyzer - Swept SA</p> <p>Ref Offset: 11 dB Ref: 11.00 dBm</p> <p>Mkr1 2.464 516 3 GHz -13.628 dBm</p> <p>Center 2.462000 GHz #Res BW 3.0 kHz #VBW 10 kHz Sweep 2.395 s (40001 pts)</p> <p>Span 22.71 MHz</p> <p>Frequency</p> <ul style="list-style-type: none">Auto TuneCenter Freq: 2.462000000 GHzStart Freq: 2.450645000 GHzStop Freq: 2.473355000 GHzCF Step: 2.271000 MHz (Auto)Freq Offset: 0 Hz

Out of Band Conducted Emissions Measurement

■ Test Graphs

Reference level

Mode 2: IEEE 802.11b Continuous TX mode	
2412	 <p>Agilent Spectrum Analyzer - Swept SA Center Freq 2.412000000 GHz Ref Offset 11 dB Ref 20.00 dBm Mkr1 2.411 025 GHz 5.334 dBm Center 2.412000 GHz #Res BW 100 kHz #VBW 300 kHz Span 14.34 MHz Sweep 1.400 ms (1001 pts)</p>
2437	 <p>Agilent Spectrum Analyzer - Swept SA Center Freq 2.437000000 GHz Ref Offset 11 dB Ref 20.00 dBm Mkr1 2.438 021 GHz 5.951 dBm Center 2.437000 GHz #Res BW 100 kHz #VBW 300 kHz Span 14.38 MHz Sweep 1.400 ms (1001 pts)</p>

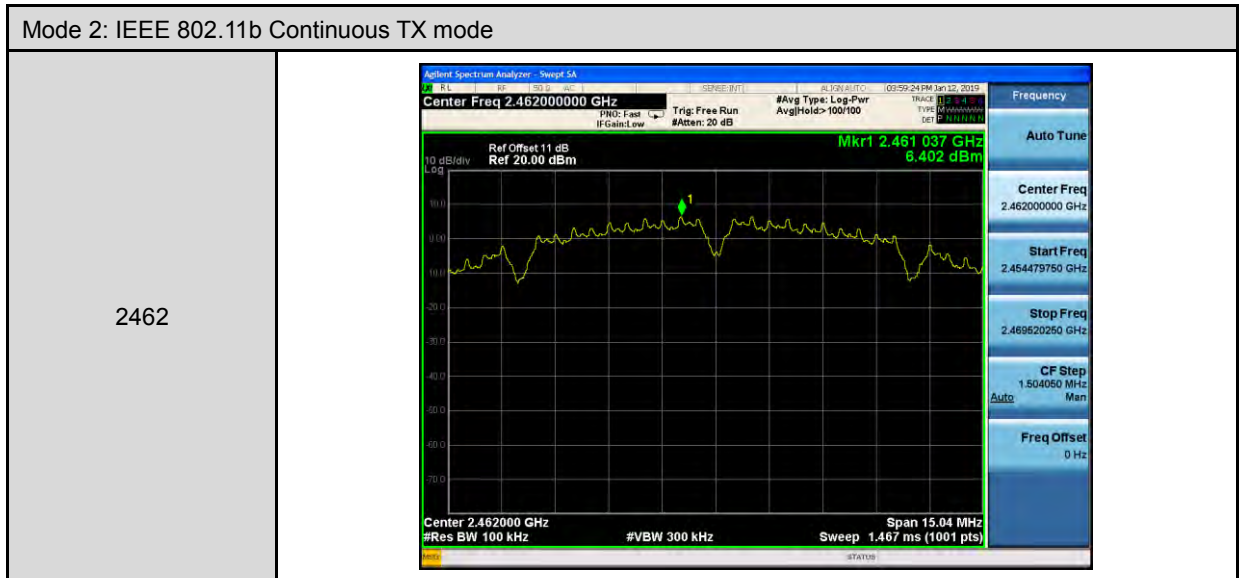



Mode 3: IEEE 802.11g Continuous TX mode	
2412	<p>Agilent Spectrum Analyzer - Swept SA</p> <p>Center Freq 2.412000000 GHz #Avg Type: Log-Pwr Avg/Hold: 100/100</p> <p>Ref Offset 11 dB Ref 20.00 dBm Mkr1 2.413 270 GHz -0.571 dBm</p> <p>Center 2.41200 GHz #Res BW 100 kHz #VBW 300 kHz Span 22.67 MHz Sweep 2.200 ms (1001 pts)</p>
2437	<p>Agilent Spectrum Analyzer - Swept SA</p> <p>Center Freq 2.437000000 GHz #Avg Type: Log-Pwr Avg/Hold: 100/100</p> <p>Ref Offset 11 dB Ref 20.00 dBm Mkr1 2.438 294 GHz 5.249 dBm</p> <p>Center 2.43700 GHz #Res BW 100 kHz #VBW 300 kHz Span 22.70 MHz Sweep 2.200 ms (1001 pts)</p>
2462	<p>Agilent Spectrum Analyzer - Swept SA</p> <p>Center Freq 2.462000000 GHz #Avg Type: Log-Pwr Avg/Hold: 100/100</p> <p>Ref Offset 11 dB Ref 20.00 dBm Mkr1 2.463 293 GHz 1.133 dBm</p> <p>Center 2.46200 GHz #Res BW 100 kHz #VBW 300 kHz Span 22.68 MHz Sweep 2.200 ms (1001 pts)</p>



Mode 4: IEEE 802.11n 2.4 GHz 20 MHz Continuous TX mode	
2412	<p>Agilent Spectrum Analyzer - Sweep 5A Center Freq 2.412000000 GHz Ref Offset 11 dB Ref 20.00 dBm Mkr1 2.413 292 GHz -0.220 dBm Span 22.67 MHz #Res BW 100 kHz #VBW 300 kHz Sweep 2.200 ms (1001 pts)</p>
2437	<p>Agilent Spectrum Analyzer - Sweep 5A Center Freq 2.437000000 GHz Ref Offset 11 dB Ref 20.00 dBm Mkr1 2.438 293 GHz 4.443 dBm Span 22.69 MHz #Res BW 100 kHz #VBW 300 kHz Sweep 2.200 ms (1001 pts)</p>
2462	<p>Agilent Spectrum Analyzer - Sweep 5A Center Freq 2.462000000 GHz Ref Offset 11 dB Ref 20.00 dBm Mkr1 2.463 294 GHz 1.220 dBm Span 22.70 MHz #Res BW 100 kHz #VBW 300 kHz Sweep 2.200 ms (1001 pts)</p>



Out of Band Conducted Spurious Emission

Mode 2: IEEE 802.11b Continuous TX mode																												
2412	<p>Agilent Spectrum Analyzer - Swept SA</p> <p>Center Freq 13.26500000 GHz</p> <p>Ref Offset: 11 dB Ref: 20.00 dBm</p> <p>Mkr2 2.3977 GHz -31.77 dBm</p> <p>Start 30 MHz #Res BW 100 kHz</p> <p>#VBW 300 kHz</p> <p>Stop 26.50 GHz Sweep 2.531 s (40001 pts)</p> <table border="1"> <thead> <tr> <th>MFR</th> <th>MODE</th> <th>TRF</th> <th>SCL</th> <th>X</th> <th>Y</th> <th>FUNCTION</th> <th>FUNCTION WIDTH</th> <th>FUNCTION VALUE</th> </tr> </thead> <tbody> <tr> <td>1</td> <td>N</td> <td>1</td> <td>f</td> <td>2.4103 GHz</td> <td>4.42 dBm</td> <td></td> <td></td> <td></td> </tr> <tr> <td>2</td> <td>N</td> <td>1</td> <td>f</td> <td>2.3977 GHz</td> <td>-31.77 dBm</td> <td></td> <td></td> <td></td> </tr> </tbody> </table>	MFR	MODE	TRF	SCL	X	Y	FUNCTION	FUNCTION WIDTH	FUNCTION VALUE	1	N	1	f	2.4103 GHz	4.42 dBm				2	N	1	f	2.3977 GHz	-31.77 dBm			
MFR	MODE	TRF	SCL	X	Y	FUNCTION	FUNCTION WIDTH	FUNCTION VALUE																				
1	N	1	f	2.4103 GHz	4.42 dBm																							
2	N	1	f	2.3977 GHz	-31.77 dBm																							
2437	<p>Agilent Spectrum Analyzer - Swept SA</p> <p>Center Freq 13.26500000 GHz</p> <p>Ref Offset: 11 dB Ref: 20.00 dBm</p> <p>Mkr2 24.7040 GHz -34.443 dBm</p> <p>Start 30 MHz #Res BW 100 kHz</p> <p>#VBW 300 kHz</p> <p>Stop 26.50 GHz Sweep 2.531 s (40001 pts)</p> <table border="1"> <thead> <tr> <th>MFR</th> <th>MODE</th> <th>TRF</th> <th>SCL</th> <th>X</th> <th>Y</th> <th>FUNCTION</th> <th>FUNCTION WIDTH</th> <th>FUNCTION VALUE</th> </tr> </thead> <tbody> <tr> <td>1</td> <td>N</td> <td>1</td> <td>f</td> <td>2.4355 GHz</td> <td>4.774 dBm</td> <td></td> <td></td> <td></td> </tr> <tr> <td>2</td> <td>N</td> <td>1</td> <td>f</td> <td>24.7040 GHz</td> <td>-34.443 dBm</td> <td></td> <td></td> <td></td> </tr> </tbody> </table>	MFR	MODE	TRF	SCL	X	Y	FUNCTION	FUNCTION WIDTH	FUNCTION VALUE	1	N	1	f	2.4355 GHz	4.774 dBm				2	N	1	f	24.7040 GHz	-34.443 dBm			
MFR	MODE	TRF	SCL	X	Y	FUNCTION	FUNCTION WIDTH	FUNCTION VALUE																				
1	N	1	f	2.4355 GHz	4.774 dBm																							
2	N	1	f	24.7040 GHz	-34.443 dBm																							
2462	<p>Agilent Spectrum Analyzer - Swept SA</p> <p>Center Freq 13.26500000 GHz</p> <p>Ref Offset: 11 dB Ref: 20.00 dBm</p> <p>Mkr2 24.7722 GHz -35.31 dBm</p> <p>Start 30 MHz #Res BW 100 kHz</p> <p>#VBW 300 kHz</p> <p>Stop 26.50 GHz Sweep 2.531 s (40001 pts)</p> <table border="1"> <thead> <tr> <th>MFR</th> <th>MODE</th> <th>TRF</th> <th>SCL</th> <th>X</th> <th>Y</th> <th>FUNCTION</th> <th>FUNCTION WIDTH</th> <th>FUNCTION VALUE</th> </tr> </thead> <tbody> <tr> <td>1</td> <td>N</td> <td>1</td> <td>f</td> <td>2.4606 GHz</td> <td>4.74 dBm</td> <td></td> <td></td> <td></td> </tr> <tr> <td>2</td> <td>N</td> <td>1</td> <td>f</td> <td>24.7722 GHz</td> <td>-35.31 dBm</td> <td></td> <td></td> <td></td> </tr> </tbody> </table>	MFR	MODE	TRF	SCL	X	Y	FUNCTION	FUNCTION WIDTH	FUNCTION VALUE	1	N	1	f	2.4606 GHz	4.74 dBm				2	N	1	f	24.7722 GHz	-35.31 dBm			
MFR	MODE	TRF	SCL	X	Y	FUNCTION	FUNCTION WIDTH	FUNCTION VALUE																				
1	N	1	f	2.4606 GHz	4.74 dBm																							
2	N	1	f	24.7722 GHz	-35.31 dBm																							



Mode 3: IEEE 802.11g Continuous TX mode																												
2412	<p>Agilent Spectrum Analyzer - Swept SA</p> <p>Center Freq 13.26500000 GHz Avg Type: Log-Pwr</p> <p>Ref Offset: 11 dB Ref: 20.00 dBm</p> <p>Mkr2 26.138 0 GHz -35.02 dBm</p> <p>Start 30 MHz #Res BW 100 kHz #VBW 300 kHz Stop 26.50 GHz Sweep 2.531 s (40001 pts)</p> <table border="1"> <thead> <tr> <th>MFR</th> <th>MODE</th> <th>TRF</th> <th>SCL</th> <th>X</th> <th>Y</th> <th>FUNCTION</th> <th>FUNCTION WIDTH</th> <th>FUNCTION VALUE</th> </tr> </thead> <tbody> <tr> <td>1</td> <td>N</td> <td>1</td> <td>f</td> <td>2.409 7 GHz</td> <td>-2.60 dBm</td> <td></td> <td></td> <td></td> </tr> <tr> <td>2</td> <td>N</td> <td>1</td> <td>f</td> <td>26.138 0 GHz</td> <td>-35.02 dBm</td> <td></td> <td></td> <td></td> </tr> </tbody> </table>	MFR	MODE	TRF	SCL	X	Y	FUNCTION	FUNCTION WIDTH	FUNCTION VALUE	1	N	1	f	2.409 7 GHz	-2.60 dBm				2	N	1	f	26.138 0 GHz	-35.02 dBm			
MFR	MODE	TRF	SCL	X	Y	FUNCTION	FUNCTION WIDTH	FUNCTION VALUE																				
1	N	1	f	2.409 7 GHz	-2.60 dBm																							
2	N	1	f	26.138 0 GHz	-35.02 dBm																							
2437	<p>Agilent Spectrum Analyzer - Swept SA</p> <p>Center Freq 13.26500000 GHz Avg Type: Log-Pwr</p> <p>Ref Offset: 11 dB Ref: 20.00 dBm</p> <p>Mkr2 24.807 2 GHz -35.93 dBm</p> <p>Start 30 MHz #Res BW 100 kHz #VBW 300 kHz Stop 26.50 GHz Sweep 2.531 s (40001 pts)</p> <table border="1"> <thead> <tr> <th>MFR</th> <th>MODE</th> <th>TRF</th> <th>SCL</th> <th>X</th> <th>Y</th> <th>FUNCTION</th> <th>FUNCTION WIDTH</th> <th>FUNCTION VALUE</th> </tr> </thead> <tbody> <tr> <td>1</td> <td>N</td> <td>1</td> <td>f</td> <td>2.439 4 GHz</td> <td>-4.19 dBm</td> <td></td> <td></td> <td></td> </tr> <tr> <td>2</td> <td>N</td> <td>1</td> <td>f</td> <td>24.807 2 GHz</td> <td>-35.93 dBm</td> <td></td> <td></td> <td></td> </tr> </tbody> </table>	MFR	MODE	TRF	SCL	X	Y	FUNCTION	FUNCTION WIDTH	FUNCTION VALUE	1	N	1	f	2.439 4 GHz	-4.19 dBm				2	N	1	f	24.807 2 GHz	-35.93 dBm			
MFR	MODE	TRF	SCL	X	Y	FUNCTION	FUNCTION WIDTH	FUNCTION VALUE																				
1	N	1	f	2.439 4 GHz	-4.19 dBm																							
2	N	1	f	24.807 2 GHz	-35.93 dBm																							
2462	<p>Agilent Spectrum Analyzer - Swept SA</p> <p>Center Freq 13.26500000 GHz Avg Type: Log-Pwr</p> <p>Ref Offset: 11 dB Ref: 20.00 dBm</p> <p>Mkr2 26.034 1 GHz -35.18 dBm</p> <p>Start 30 MHz #Res BW 100 kHz #VBW 300 kHz Stop 26.50 GHz Sweep 2.531 s (40001 pts)</p> <table border="1"> <thead> <tr> <th>MFR</th> <th>MODE</th> <th>TRF</th> <th>SCL</th> <th>X</th> <th>Y</th> <th>FUNCTION</th> <th>FUNCTION WIDTH</th> <th>FUNCTION VALUE</th> </tr> </thead> <tbody> <tr> <td>1</td> <td>N</td> <td>1</td> <td>f</td> <td>2.459 3 GHz</td> <td>-0.04 dBm</td> <td></td> <td></td> <td></td> </tr> <tr> <td>2</td> <td>N</td> <td>1</td> <td>f</td> <td>26.034 1 GHz</td> <td>-35.18 dBm</td> <td></td> <td></td> <td></td> </tr> </tbody> </table>	MFR	MODE	TRF	SCL	X	Y	FUNCTION	FUNCTION WIDTH	FUNCTION VALUE	1	N	1	f	2.459 3 GHz	-0.04 dBm				2	N	1	f	26.034 1 GHz	-35.18 dBm			
MFR	MODE	TRF	SCL	X	Y	FUNCTION	FUNCTION WIDTH	FUNCTION VALUE																				
1	N	1	f	2.459 3 GHz	-0.04 dBm																							
2	N	1	f	26.034 1 GHz	-35.18 dBm																							



Mode 4: IEEE 802.11n 2.4 GHz 20 MHz Continuous TX mode																									
2412	<p>Agilent Spectrum Analyzer - Swept SA</p> <p>Center Freq 13.26500000 GHz Avg Type: Log-Pwr</p> <p>Ref Offset: 11 dB Ref 20.00 dBm</p> <p>Mkr2 24.7867 GHz -35.05 dBm</p> <p>Start 30 MHz #Res BW 100 kHz #VBW 300 kHz Stop 26.50 GHz Sweep 2.531 s (40001 pts)</p> <table border="1"> <thead> <tr> <th>MKR MODE</th> <th>TRIG</th> <th>SCL</th> <th>X</th> <th>Y</th> <th>FUNCTION</th> <th>FUNCTION WIDTH</th> <th>FUNCTION VALUE</th> </tr> </thead> <tbody> <tr> <td>1</td> <td>N</td> <td>f</td> <td>2.4097 GHz</td> <td>-2.93 dBm</td> <td></td> <td></td> <td></td> </tr> <tr> <td>2</td> <td>N</td> <td>f</td> <td>24.7867 GHz</td> <td>-35.05 dBm</td> <td></td> <td></td> <td></td> </tr> </tbody> </table>	MKR MODE	TRIG	SCL	X	Y	FUNCTION	FUNCTION WIDTH	FUNCTION VALUE	1	N	f	2.4097 GHz	-2.93 dBm				2	N	f	24.7867 GHz	-35.05 dBm			
MKR MODE	TRIG	SCL	X	Y	FUNCTION	FUNCTION WIDTH	FUNCTION VALUE																		
1	N	f	2.4097 GHz	-2.93 dBm																					
2	N	f	24.7867 GHz	-35.05 dBm																					
2437	<p>Agilent Spectrum Analyzer - Swept SA</p> <p>Center Freq 13.26500000 GHz Avg Type: Log-Pwr</p> <p>Ref Offset: 11 dB Ref 20.00 dBm</p> <p>Mkr2 24.7470 GHz -35.52 dBm</p> <p>Start 30 MHz #Res BW 100 kHz #VBW 300 kHz Stop 26.50 GHz Sweep 2.531 s (40001 pts)</p> <table border="1"> <thead> <tr> <th>MKR MODE</th> <th>TRIG</th> <th>SCL</th> <th>X</th> <th>Y</th> <th>FUNCTION</th> <th>FUNCTION WIDTH</th> <th>FUNCTION VALUE</th> </tr> </thead> <tbody> <tr> <td>1</td> <td>N</td> <td>f</td> <td>2.4355 GHz</td> <td>3.29 dBm</td> <td></td> <td></td> <td></td> </tr> <tr> <td>2</td> <td>N</td> <td>f</td> <td>24.7470 GHz</td> <td>-35.52 dBm</td> <td></td> <td></td> <td></td> </tr> </tbody> </table>	MKR MODE	TRIG	SCL	X	Y	FUNCTION	FUNCTION WIDTH	FUNCTION VALUE	1	N	f	2.4355 GHz	3.29 dBm				2	N	f	24.7470 GHz	-35.52 dBm			
MKR MODE	TRIG	SCL	X	Y	FUNCTION	FUNCTION WIDTH	FUNCTION VALUE																		
1	N	f	2.4355 GHz	3.29 dBm																					
2	N	f	24.7470 GHz	-35.52 dBm																					
2462	<p>Agilent Spectrum Analyzer - Swept SA</p> <p>Center Freq 13.26500000 GHz Avg Type: Log-Pwr</p> <p>Ref Offset: 11 dB Ref 20.00 dBm</p> <p>Mkr2 24.7629 GHz -36.10 dBm</p> <p>Start 30 MHz #Res BW 100 kHz #VBW 300 kHz Stop 26.50 GHz Sweep 2.531 s (40001 pts)</p> <table border="1"> <thead> <tr> <th>MKR MODE</th> <th>TRIG</th> <th>SCL</th> <th>X</th> <th>Y</th> <th>FUNCTION</th> <th>FUNCTION WIDTH</th> <th>FUNCTION VALUE</th> </tr> </thead> <tbody> <tr> <td>1</td> <td>N</td> <td>f</td> <td>2.4633 GHz</td> <td>0.44 dBm</td> <td></td> <td></td> <td></td> </tr> <tr> <td>2</td> <td>N</td> <td>f</td> <td>24.7629 GHz</td> <td>-36.10 dBm</td> <td></td> <td></td> <td></td> </tr> </tbody> </table>	MKR MODE	TRIG	SCL	X	Y	FUNCTION	FUNCTION WIDTH	FUNCTION VALUE	1	N	f	2.4633 GHz	0.44 dBm				2	N	f	24.7629 GHz	-36.10 dBm			
MKR MODE	TRIG	SCL	X	Y	FUNCTION	FUNCTION WIDTH	FUNCTION VALUE																		
1	N	f	2.4633 GHz	0.44 dBm																					
2	N	f	24.7629 GHz	-36.10 dBm																					

Conducted Band Edge

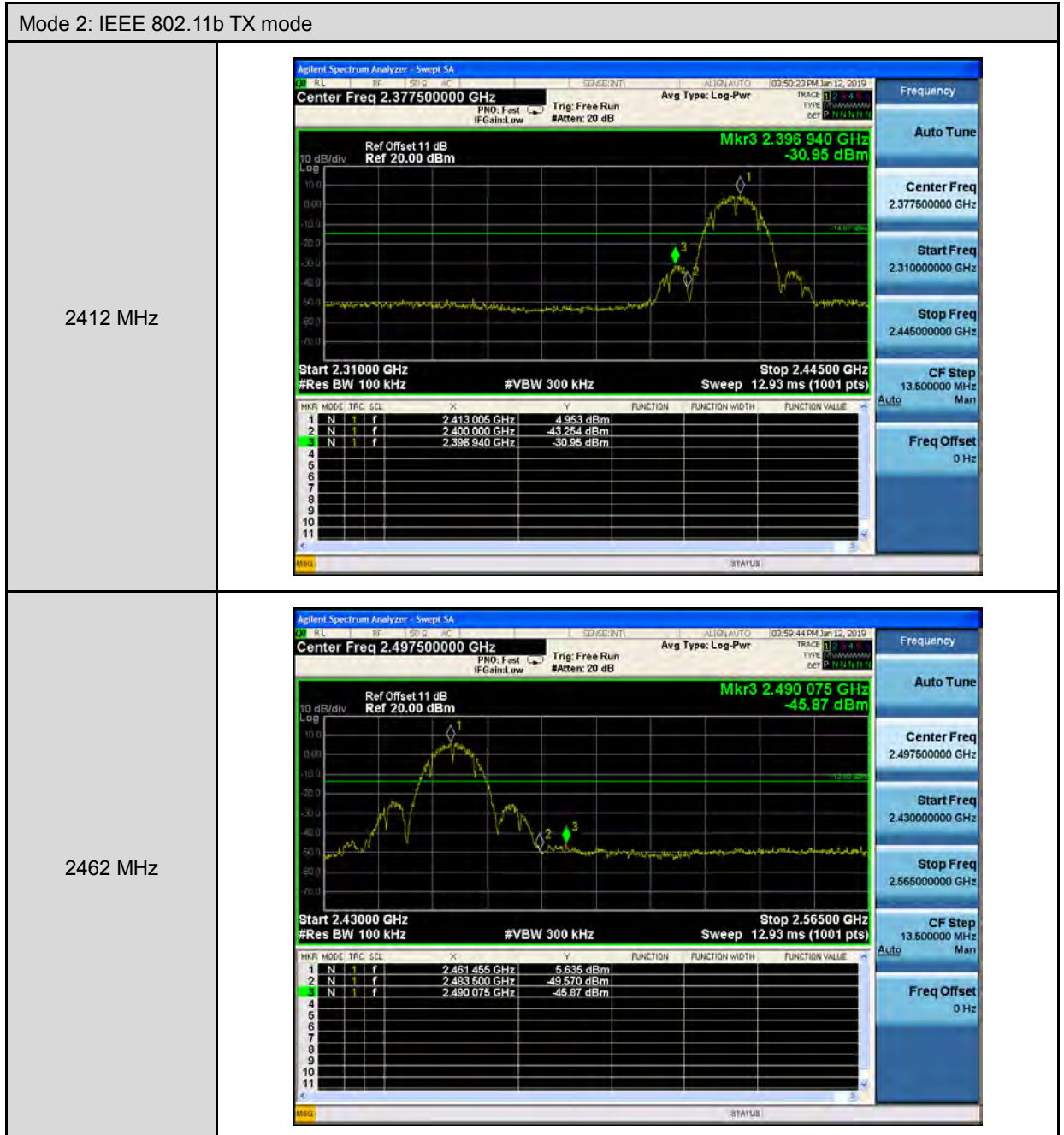

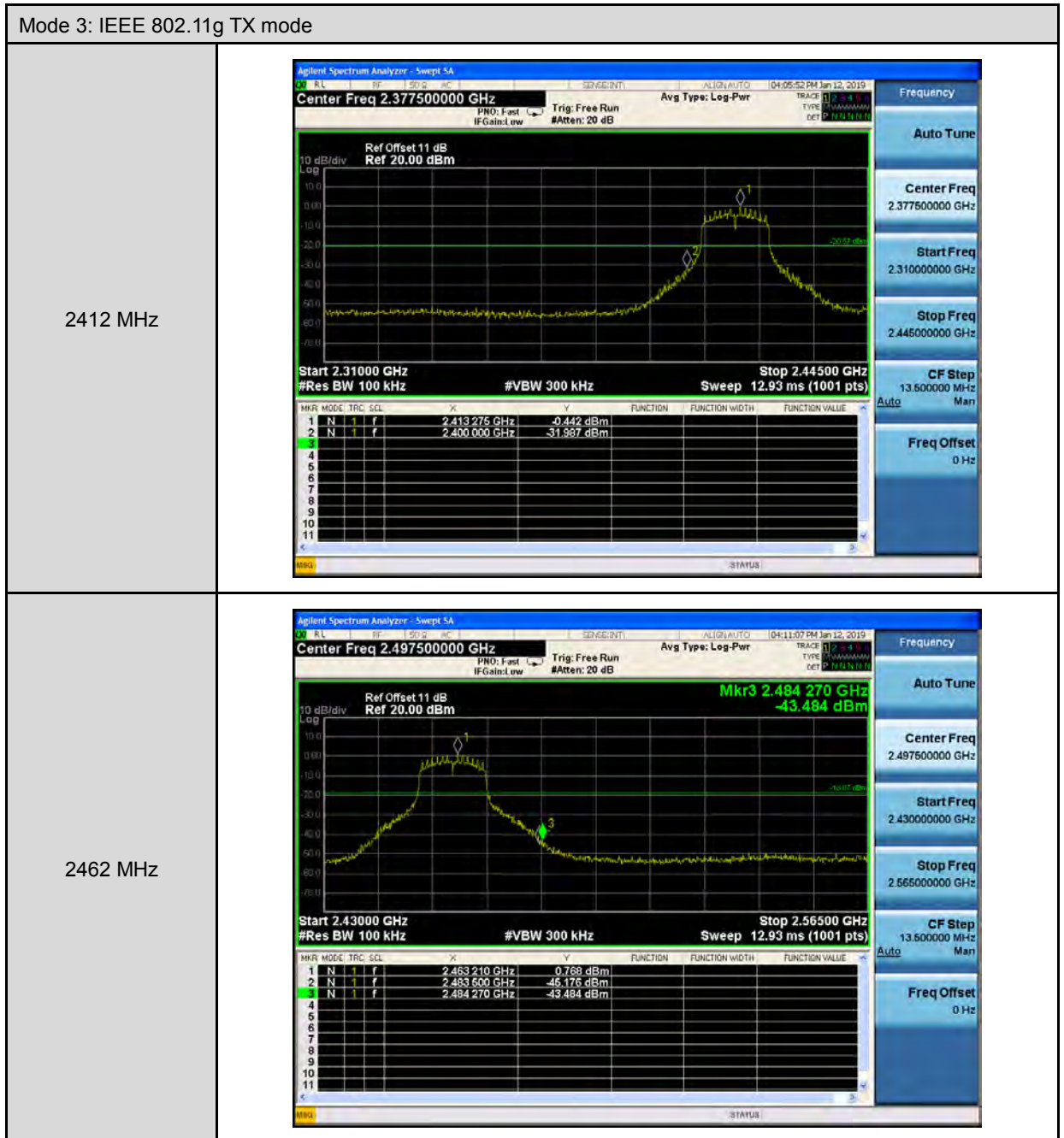



**Annex C. Radiated Emission Measurement****Harmonic**

Below 1 GHz

Standard:	FCC Part 15.247	Test Distance:	3 m				
Test item:	Harmonic	Power:	AC 24 V/60 Hz				
Test Mode:	Mode 1	Temp.(°C)/Hum.(%RH):	26(°C)/60 %RH				
Frequency (MHz)	Reading (dBuV)	Correct Factor (dB/m)	Result (dBuV/m)	Limit (dBuV/m)	Margin (dB)	Remark	Ant.Polar. H / V
155.1300	25.88	-5.20	20.68	43.50	-22.82	QP	H
283.1700	26.17	-3.96	22.21	46.00	-23.79	QP	H
476.2000	27.61	0.14	27.75	46.00	-18.25	QP	H
599.3900	27.54	2.76	30.30	46.00	-15.70	QP	H
669.2300	27.70	3.92	31.62	46.00	-14.38	QP	H
749.7400	26.86	5.93	32.79	46.00	-13.21	QP	H
166.7700	27.81	-5.34	22.47	43.50	-21.03	QP	V
309.3600	27.49	-3.32	24.17	46.00	-21.83	QP	V
571.2600	27.31	1.94	29.25	46.00	-16.75	QP	V
714.8200	27.18	4.96	32.14	46.00	-13.86	QP	V
798.2400	28.52	6.81	35.33	46.00	-10.67	QP	V
882.6300	27.73	8.06	35.79	46.00	-10.21	QP	V

Note:1.Result (dBuV/m) = Correct Factor (dB/m) + Reading(dBuV).

Example: 20.68=-5.20+25.88

2.Correction factor (dB/m) = Antenna Factor (dB/m) + Cable loss (dB) – Pre-Amplifier gain (dB).

3.When the peak results are less than average limit, so not need to evaluate the average.



Above 1 GHz

Standard:	FCC Part 15.247	Test Distance:	3 m
Test item:	Harmonic	Power:	DC 3.65 V
Frequency:	2412 MHz	Temp.(°C)/Hum.(%RH):	26(°C)/60 %RH
Mode:	Mode 2		
Ant.Polar.:	Horizontal		

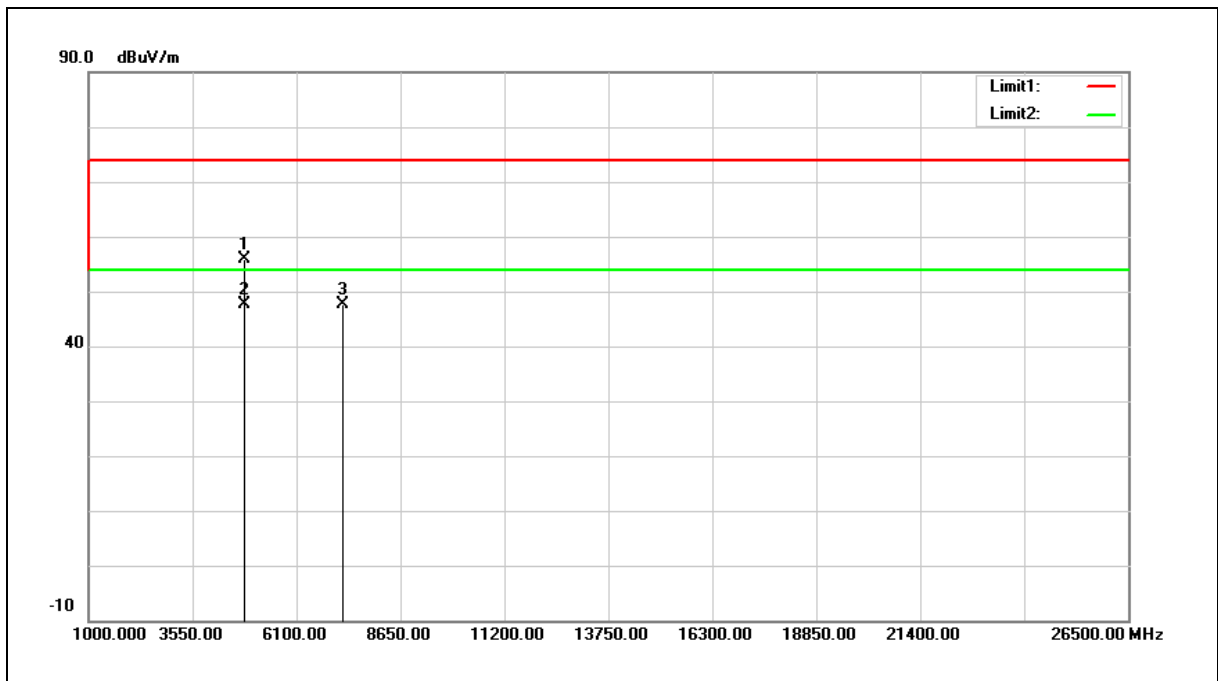

No.	Frequency (MHz)	Reading (dBuV)	Correct Factor (dB/m)	Result (dBuV/m)	Limit (dBuV/m)	Margin (dB)	Remark
1	4824.000	50.46	5.37	55.83	74.00	-18.17	peak
2	4824.000	42.15	5.37	47.52	54.00	-6.48	AVG
3	7236.000	35.61	11.90	47.51	74.00	-26.49	peak

Note:1.Result (dBuV/m) = Correct Factor (dB/m) + Reading(dBuV).

Example: 55.83=5.37+50.46

2.Correction factor (dB/m) = Antenna Factor (dB/m) + Cable loss (dB) – Pre-Amplifier gain (dB).

3.When the peak results are less than average limit, so not need to evaluate the average.



Standard:	FCC Part 15.247	Test Distance:	3 m
Test item:	Harmonic	Power:	DC 3.65 V
Frequency:	2412 MHz	Temp.(°C)/Hum.(%RH):	26(°C)/60 %RH
Mode:	Mode 2		
Ant.Polar.:	Vertical		

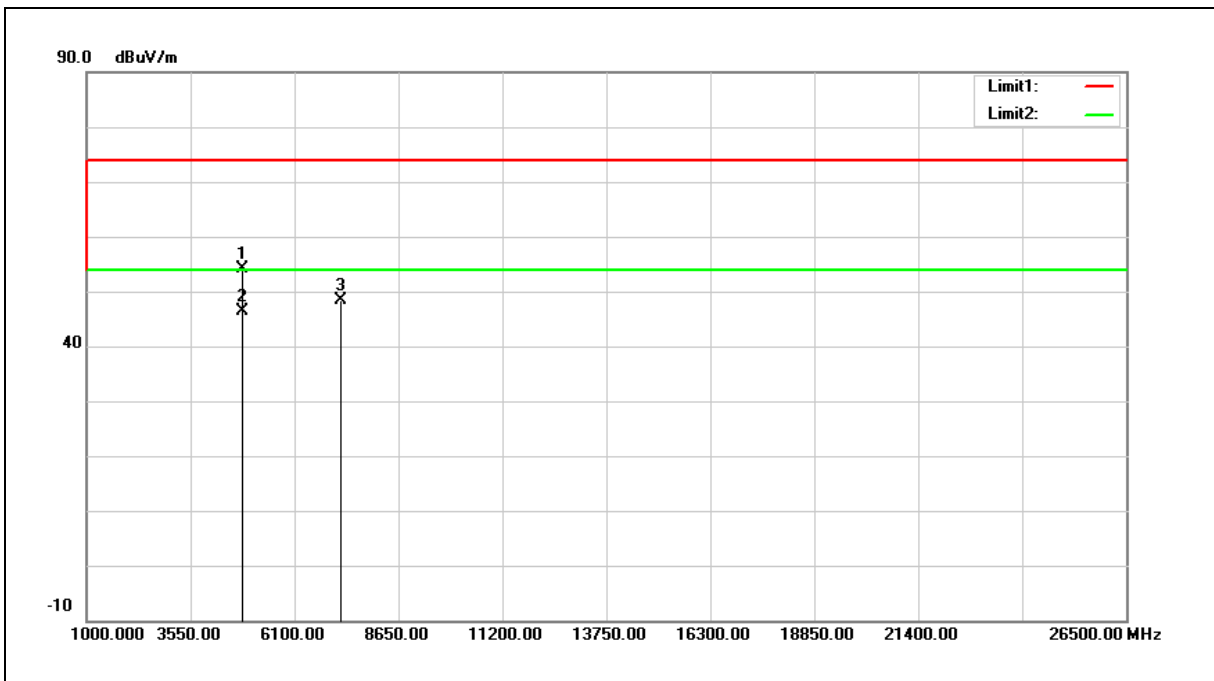

No.	Frequency (MHz)	Reading (dBuV)	Correct Factor (dB/m)	Result (dBuV/m)	Limit (dBuV/m)	Margin (dB)	Remark
1	4824.000	48.67	5.37	54.04	74.00	-19.96	peak
2	4824.000	41.06	5.37	46.43	54.00	-7.57	AVG
3	7236.000	36.52	11.90	48.42	74.00	-25.58	peak

Note:1.Result (dBuV/m) = Correct Factor (dB/m) + Reading(dBuV).

Example: 54.04=5.37+48.67

2.Correction factor (dB/m) = Antenna Factor (dB/m) + Cable loss (dB) – Pre-Amplifier gain (dB).

3.When the peak results are less than average limit, so not need to evaluate the average.



Standard:	FCC Part 15.247	Test Distance:	3 m
Test item:	Harmonic	Power:	DC 3.65 V
Frequency:	2437 MHz	Temp.(°C)/Hum.(%RH):	26(°C)/60 %RH
Mode:	Mode 2		
Ant.Polar.:	Horizontal		

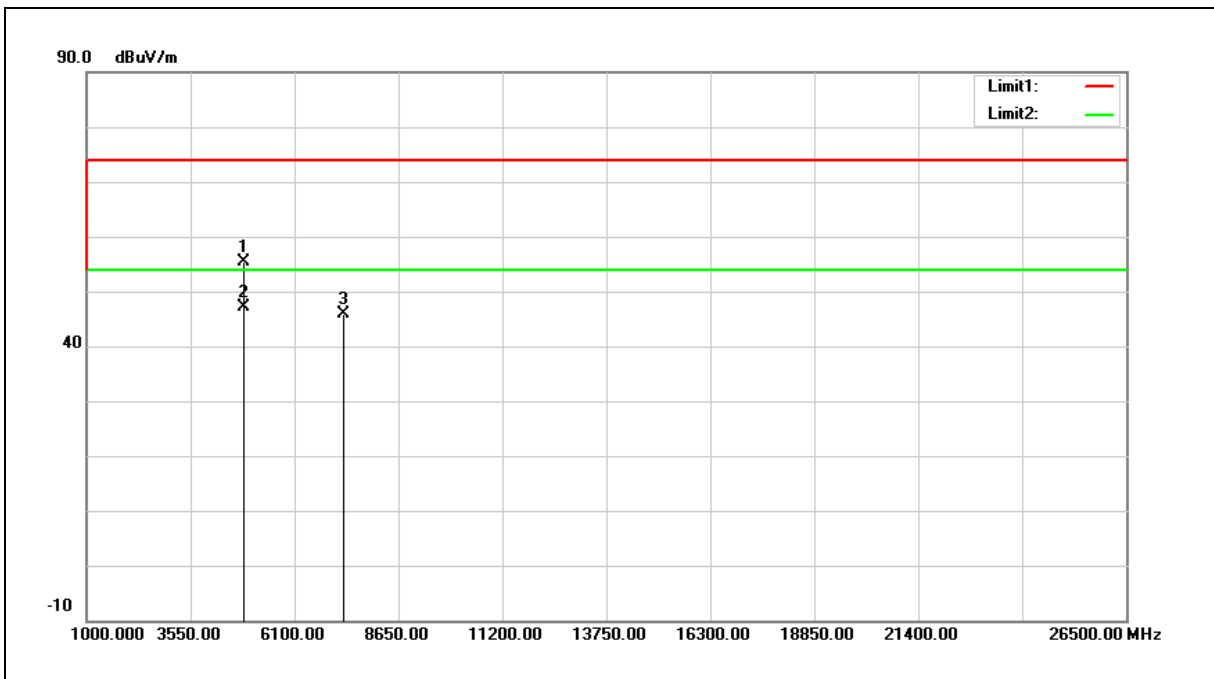

No.	Frequency (MHz)	Reading (dBuV)	Correct Factor (dB/m)	Result (dBuV/m)	Limit (dBuV/m)	Margin (dB)	Remark
1	4874.000	49.81	5.47	55.28	74.00	-18.72	peak
2	4874.000	41.59	5.47	47.06	54.00	-6.94	AVG
3	7311.000	33.66	12.13	45.79	74.00	-28.21	peak

Note:1.Result (dBuV/m) = Correct Factor (dB/m) + Reading(dBuV).

2.Correction factor (dB/m) = Antenna Factor (dB/m) + Cable loss (dB) – Pre-Amplifier gain (dB).

3.When the peak results are less than average limit, so not need to evaluate the average.



Standard:	FCC Part 15.247	Test Distance:	3 m
Test item:	Harmonic	Power:	DC 3.65 V
Frequency:	2437 MHz	Temp.(°C)/Hum.(%RH):	26(°C)/60 %RH
Mode:	Mode 2		
Ant.Polar.:	Vertical		

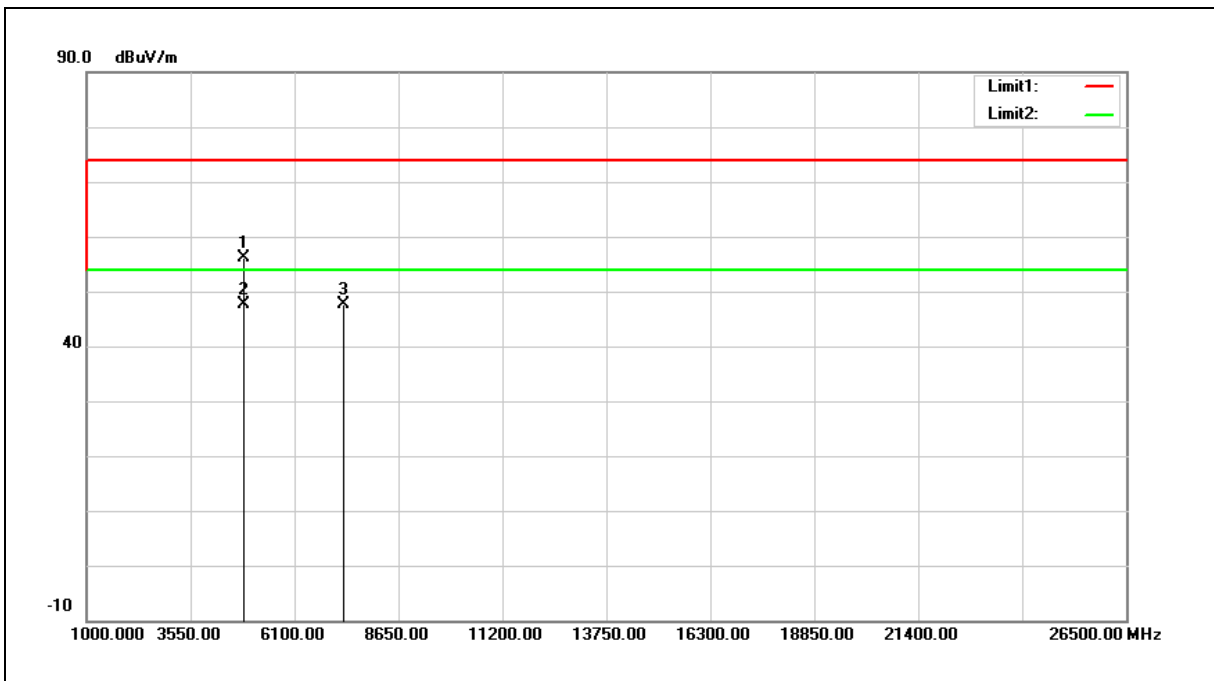

No.	Frequency (MHz)	Reading (dBuV)	Correct Factor (dB/m)	Result (dBuV/m)	Limit (dBuV/m)	Margin (dB)	Remark
1	4874.000	50.59	5.47	56.06	74.00	-17.94	peak
2	4874.000	42.26	5.47	47.73	54.00	-6.27	AVG
3	7311.000	35.40	12.13	47.53	74.00	-26.47	peak

Note:1.Result (dBuV/m) = Correct Factor (dB/m) + Reading(dBuV).

2.Correction factor (dB/m) = Antenna Factor (dB/m) + Cable loss (dB) – Pre-Amplifier gain (dB).

3.When the peak results are less than average limit, so not need to evaluate the average.



Standard:	FCC Part 15.247	Test Distance:	3 m
Test item:	Harmonic	Power:	DC 3.65 V
Frequency:	2462 MHz	Temp.(°C)/Hum.(%RH):	26(°C)/60 %RH
Mode:	Mode 2		
Ant.Polar.:	Horizontal		

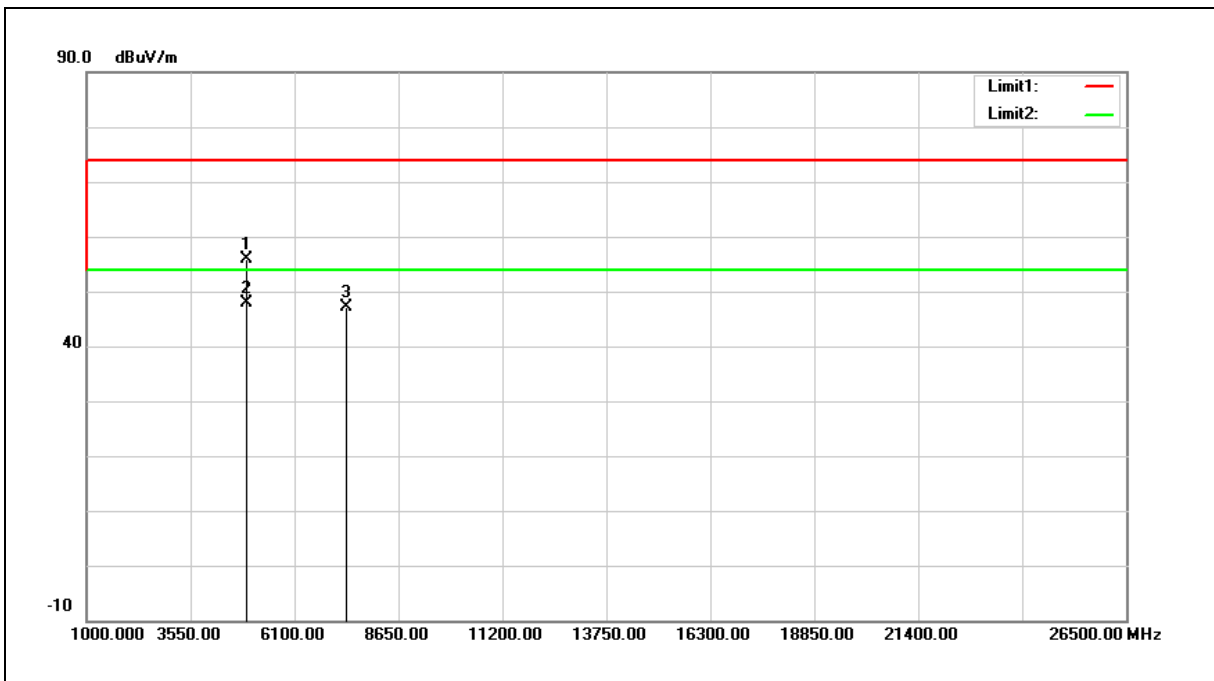

No.	Frequency (MHz)	Reading (dBuV)	Correct Factor (dB/m)	Result (dBuV/m)	Limit (dBuV/m)	Margin (dB)	Remark
1	4924.000	50.39	5.58	55.97	74.00	-18.03	peak
2	4924.000	42.35	5.58	47.93	54.00	-6.07	AVG
3	7386.000	34.85	12.36	47.21	74.00	-26.79	peak

Note:1.Result (dBuV/m) = Correct Factor (dB/m) + Reading(dBuV).

2.Correction factor (dB/m) = Antenna Factor (dB/m) + Cable loss (dB) – Pre-Amplifier gain (dB).

3.When the peak results are less than average limit, so not need to evaluate the average.



Standard:	FCC Part 15.247	Test Distance:	3 m
Test item:	Harmonic	Power:	DC 3.65 V
Frequency:	2462 MHz	Temp.(°C)/Hum.(%RH):	26(°C)/60 %RH
Mode:	Mode 2		
Ant.Polar.:	Vertical		

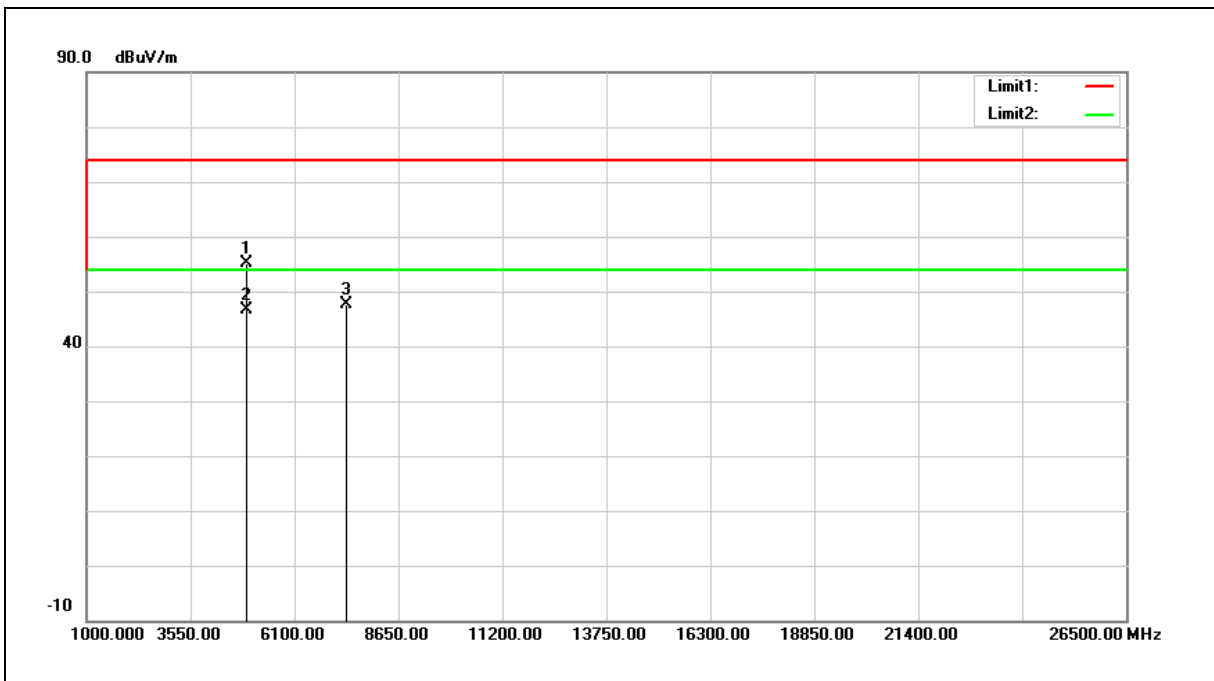

No.	Frequency (MHz)	Reading (dBuV)	Correct Factor (dB/m)	Result (dBuV/m)	Limit (dBuV/m)	Margin (dB)	Remark
1	4924.000	49.60	5.58	55.18	74.00	-18.82	peak
2	4924.000	41.00	5.58	46.58	54.00	-7.42	AVG
3	7386.000	35.33	12.36	47.69	74.00	-26.31	peak

Note:1.Result (dBuV/m) = Correct Factor (dB/m) + Reading(dBuV).

2.Correction factor (dB/m) = Antenna Factor (dB/m) + Cable loss (dB) – Pre-Amplifier gain (dB).

3.When the peak results are less than average limit, so not need to evaluate the average.



Standard:	FCC Part 15.247	Test Distance:	3 m
Test item:	Harmonic	Power:	DC 3.65 V
Frequency:	2412 MHz	Temp.(°C)/Hum.(%RH):	26(°C)/60 %RH
Mode:	Mode 3		
Ant.Polar.:	Horizontal		

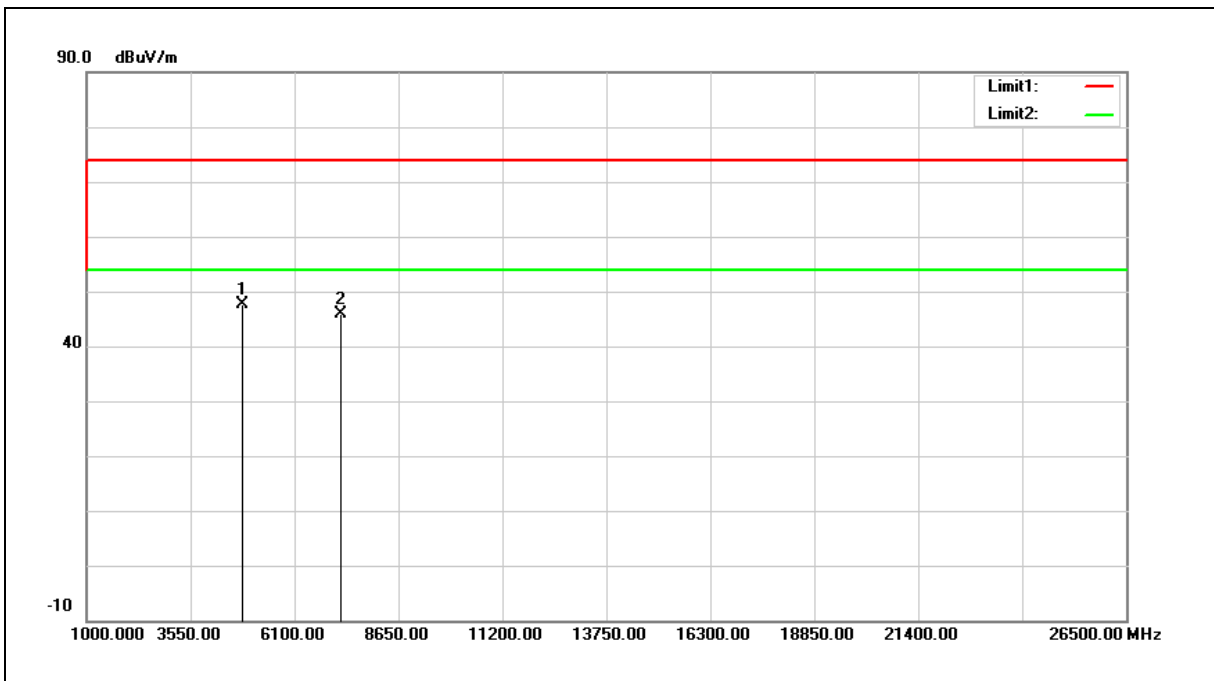

No.	Frequency (MHz)	Reading (dBuV)	Correct Factor (dB/m)	Result (dBuV/m)	Limit (dBuV/m)	Margin (dB)	Remark
1	4824.000	42.18	5.37	47.55	74.00	-26.45	peak
2	7236.000	33.94	11.90	45.84	74.00	-28.16	peak

Note: 1.Result (dBuV/m) = Correct Factor (dB/m) + Reading(dBuV).

2.Correction factor (dB/m) = Antenna Factor (dB/m) + Cable loss (dB) – Pre-Amplifier gain (dB).

3.When the peak results are less than average limit, so not need to evaluate the average.



Standard:	FCC Part 15.247	Test Distance:	3 m
Test item:	Harmonic	Power:	DC 3.65 V
Frequency:	2412 MHz	Temp.(°C)/Hum.(%RH):	26(°C)/60 %RH
Mode:	Mode 3		
Ant.Polar.:	Vertical		

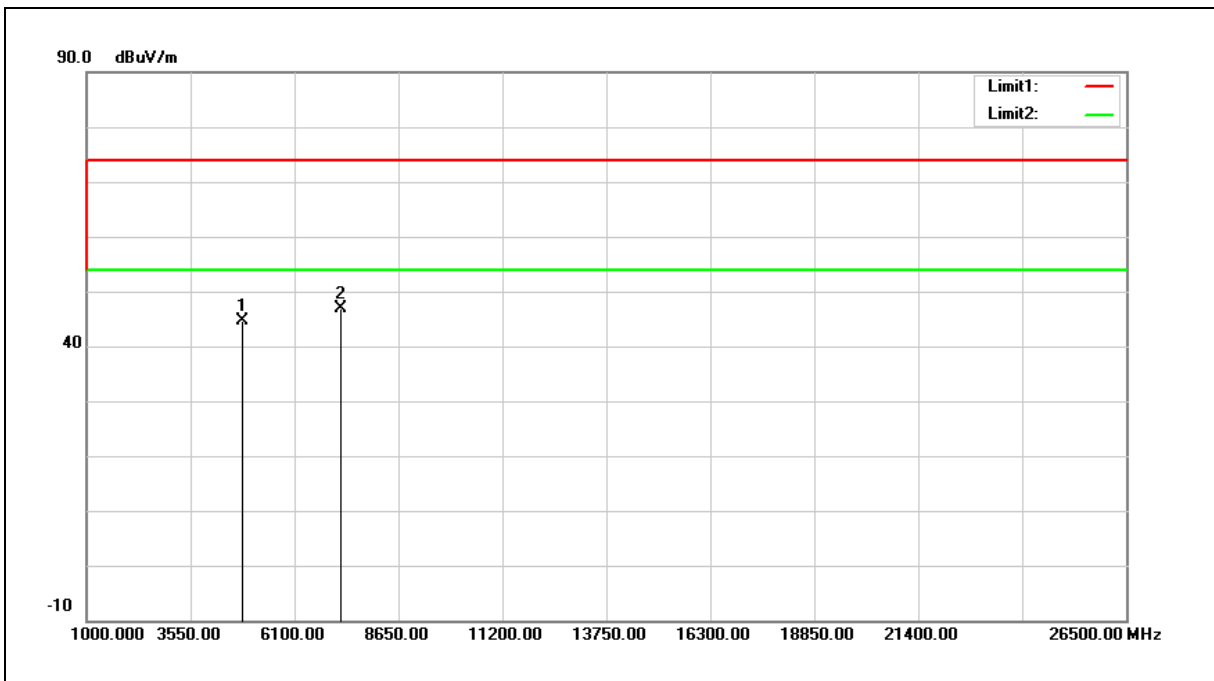

No.	Frequency (MHz)	Reading (dBuV)	Correct Factor (dB/m)	Result (dBuV/m)	Limit (dBuV/m)	Margin (dB)	Remark
1	4824.000	39.17	5.37	44.54	74.00	-29.46	peak
2	7236.000	34.94	11.90	46.84	74.00	-27.16	peak

- Note: 1.Result (dBuV/m) = Correct Factor (dB/m) + Reading(dBuV).
 2.Correction factor (dB/m) = Antenna Factor (dB/m) + Cable loss (dB) – Pre-Amplifier gain (dB).
 3.When the peak results are less than average limit, so not need to evaluate the average.



Standard:	FCC Part 15.247	Test Distance:	3 m
Test item:	Harmonic	Power:	DC 3.65 V
Frequency:	2437 MHz	Temp.(°C)/Hum.(%RH):	26(°C)/60 %RH
Mode:	Mode 3		
Ant.Polar.:	Horizontal		

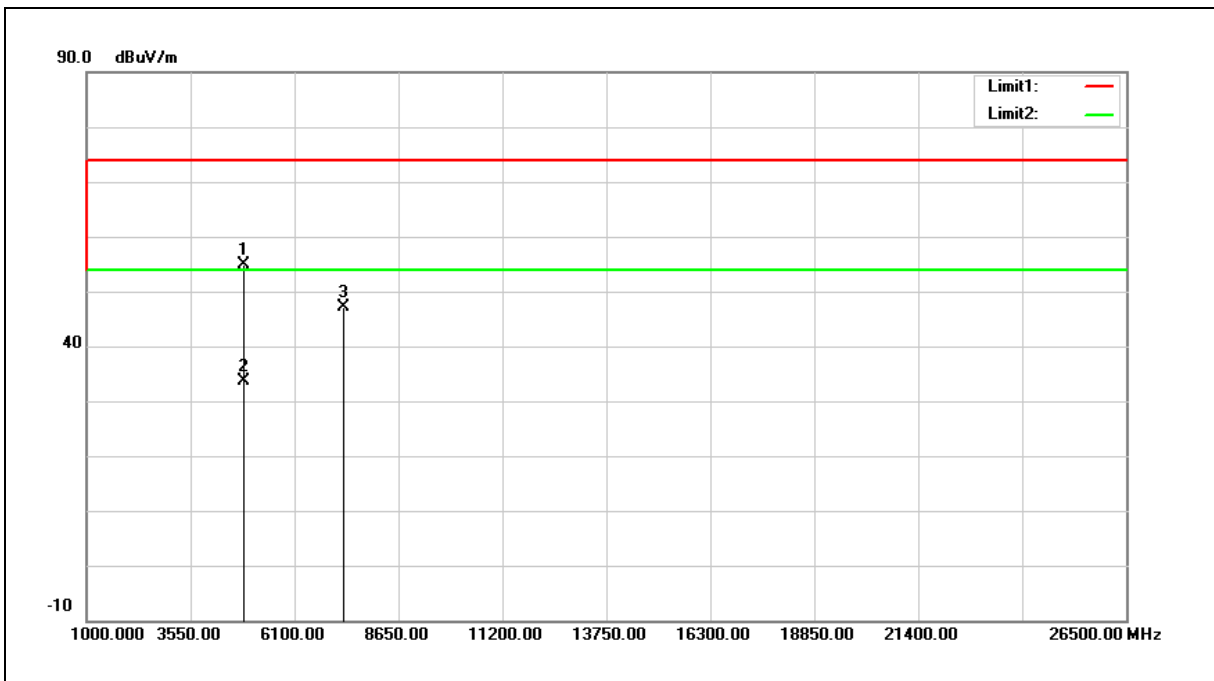

No.	Frequency (MHz)	Reading (dBuV)	Correct Factor (dB/m)	Result (dBuV/m)	Limit (dBuV/m)	Margin (dB)	Remark
1	4874.000	49.48	5.47	54.95	74.00	-19.05	peak
2	4874.000	28.24	5.47	33.71	54.00	-20.29	AVG
3	7311.000	35.10	12.13	47.23	74.00	-26.77	peak

Note:1.Result (dBuV/m) = Correct Factor (dB/m) + Reading(dBuV).

2.Correction factor (dB/m) = Antenna Factor (dB/m) + Cable loss (dB) – Pre-Amplifier gain (dB).

3.When the peak results are less than average limit, so not need to evaluate the average.



Standard:	FCC Part 15.247	Test Distance:	3 m
Test item:	Harmonic	Power:	DC 3.65 V
Frequency:	2437 MHz	Temp.(°C)/Hum.(%RH):	26(°C)/60 %RH
Mode:	Mode 3		
Ant.Polar.:	Vertical		

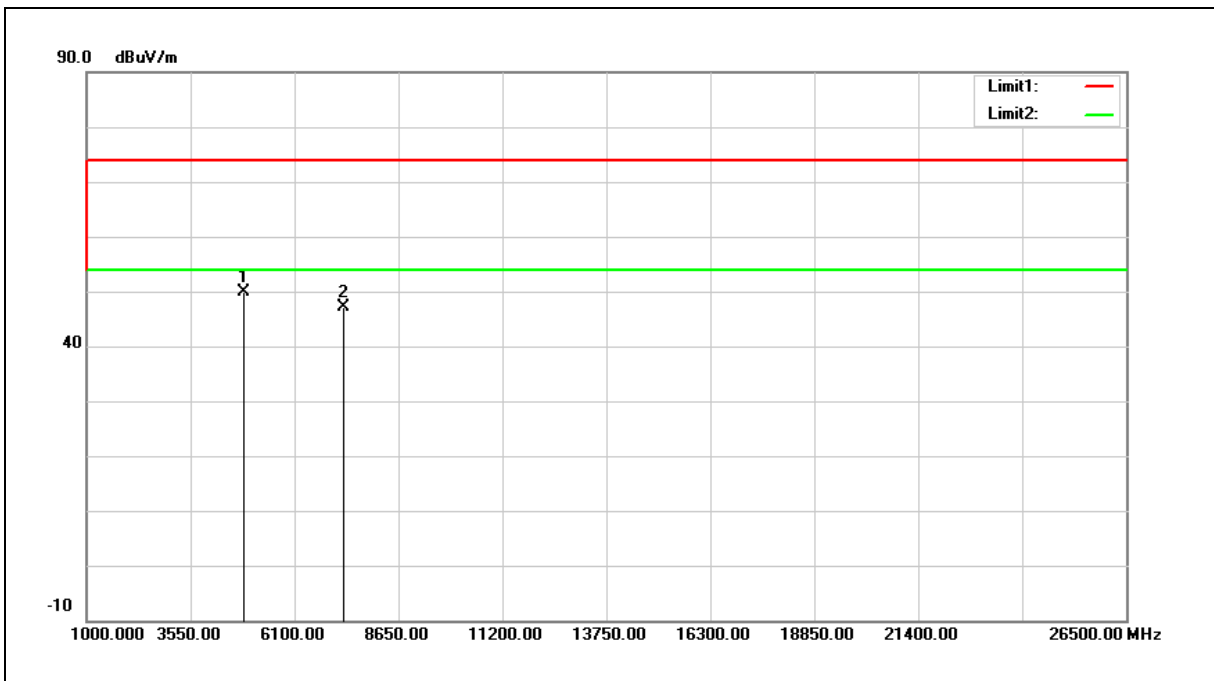

No.	Frequency (MHz)	Reading (dBuV)	Correct Factor (dB/m)	Result (dBuV/m)	Limit (dBuV/m)	Margin (dB)	Remark
1	4874.000	44.36	5.47	49.83	74.00	-24.17	peak
2	7311.000	35.11	12.13	47.24	74.00	-26.76	peak

Note: 1.Result (dBuV/m) = Correct Factor (dB/m) + Reading(dBuV).

2.Correction factor (dB/m) = Antenna Factor (dB/m) + Cable loss (dB) – Pre-Amplifier gain (dB).

3.When the peak results are less than average limit, so not need to evaluate the average.



Standard:	FCC Part 15.247	Test Distance:	3 m
Test item:	Harmonic	Power:	DC 3.65 V
Frequency:	2462 MHz	Temp.(°C)/Hum.(%RH):	26(°C)/60 %RH
Mode:	Mode 3		
Ant.Polar.:	Horizontal		

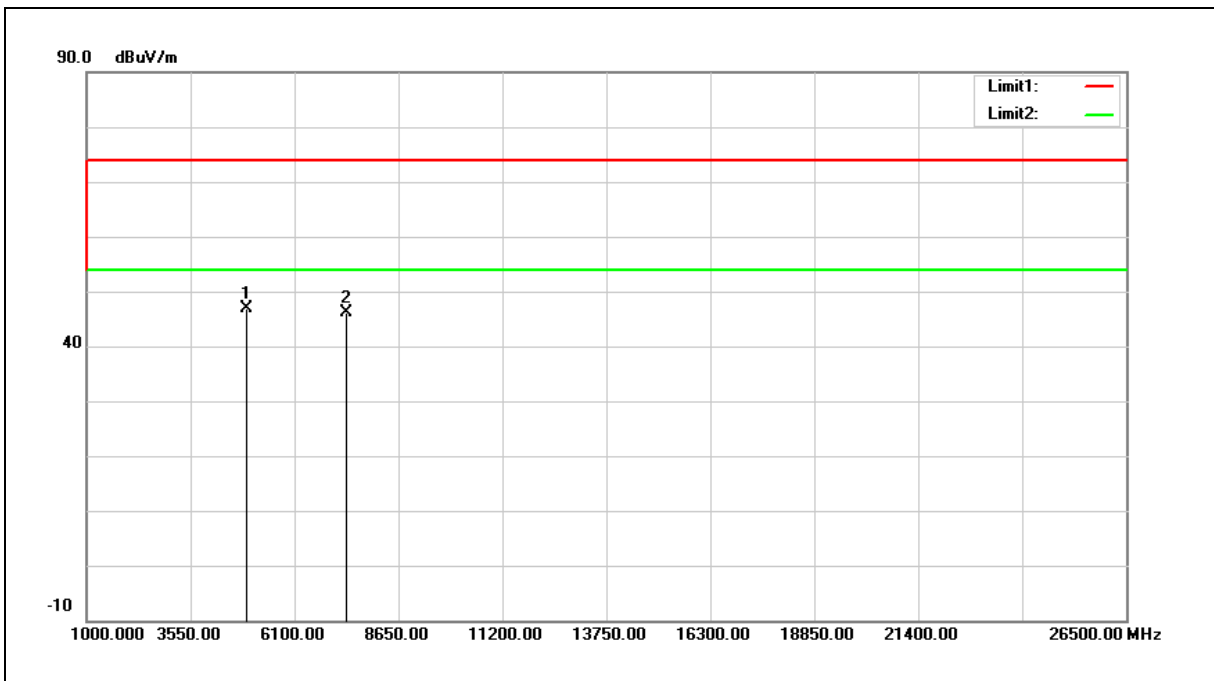

No.	Frequency (MHz)	Reading (dBuV)	Correct Factor (dB/m)	Result (dBuV/m)	Limit (dBuV/m)	Margin (dB)	Remark
1	4924.000	41.40	5.58	46.98	74.00	-27.02	peak
2	7386.000	33.73	12.36	46.09	74.00	-27.91	peak

Note: 1. Result (dBuV/m) = Correct Factor (dB/m) + Reading(dBuV).

2. Correction factor (dB/m) = Antenna Factor (dB/m) + Cable loss (dB) – Pre-Amplifier gain (dB).

3. When the peak results are less than average limit, so not need to evaluate the average.



Standard:	FCC Part 15.247	Test Distance:	3 m
Test item:	Harmonic	Power:	DC 3.65 V
Frequency:	2462 MHz	Temp.(°C)/Hum.(%RH):	26(°C)/60 %RH
Mode:	Mode 3		
Ant.Polar.:	Vertical		

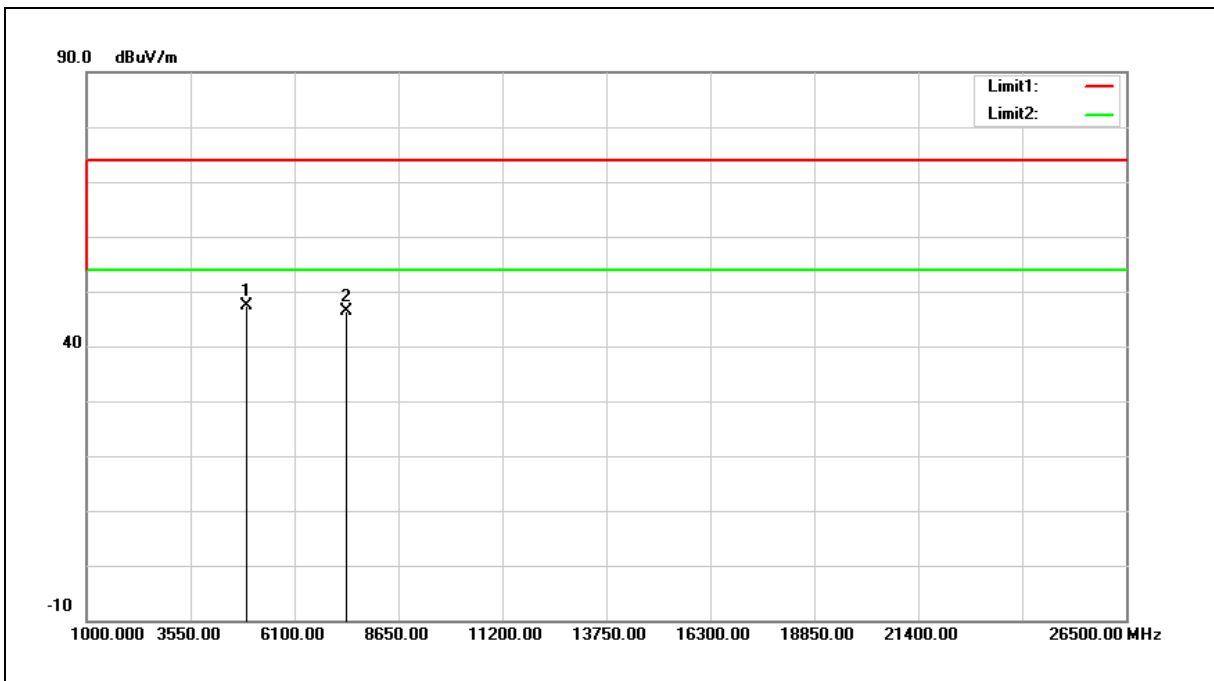

No.	Frequency (MHz)	Reading (dBuV)	Correct Factor (dB/m)	Result (dBuV/m)	Limit (dBuV/m)	Margin (dB)	Remark
1	4924.000	41.82	5.58	47.40	74.00	-26.60	peak
2	7386.000	34.04	12.36	46.40	74.00	-27.60	peak

- Note: 1.Result (dBuV/m) = Correct Factor (dB/m) + Reading(dBuV).
 2.Correction factor (dB/m) = Antenna Factor (dB/m) + Cable loss (dB) – Pre-Amplifier gain (dB).
 3.When the peak results are less than average limit, so not need to evaluate the average.



Standard:	FCC Part 15.247	Test Distance:	3 m
Test item:	Harmonic	Power:	DC 3.65 V
Frequency:	2412 MHz	Temp.(°C)/Hum.(%RH):	26(°C)/60 %RH
Mode:	Mode 4		
Ant.Polar.:	Horizontal		

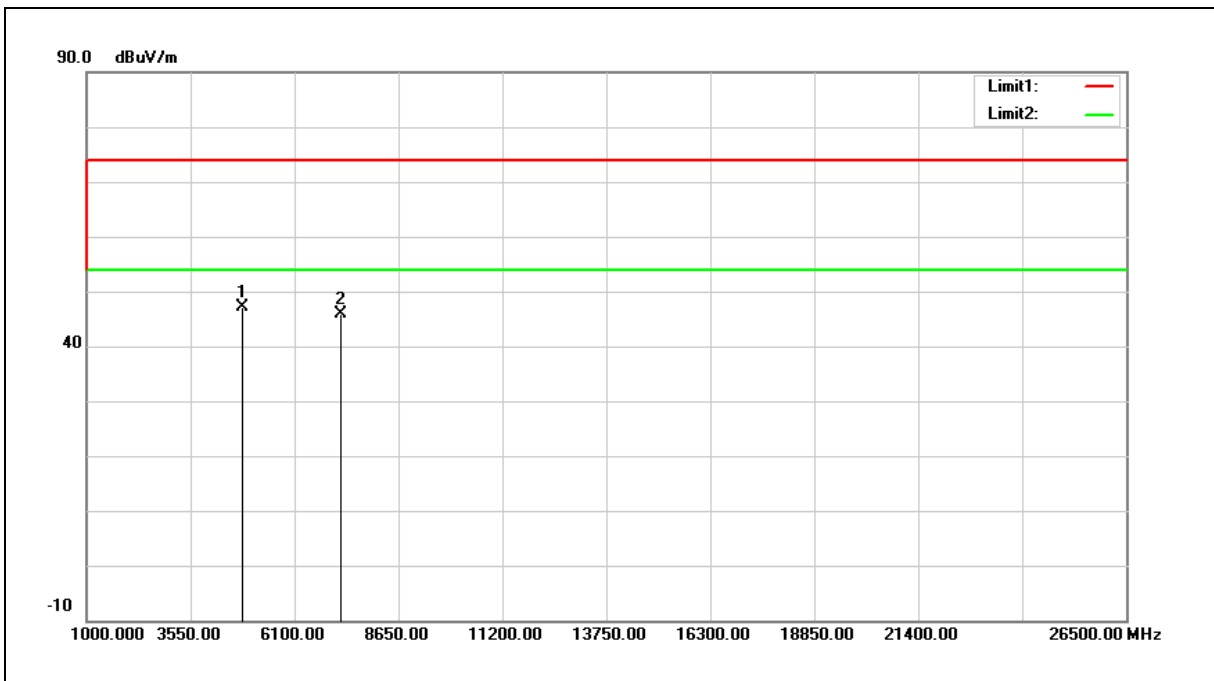

No.	Frequency (MHz)	Reading (dBuV)	Correct Factor (dB/m)	Result (dBuV/m)	Limit (dBuV/m)	Margin (dB)	Remark
1	4824.000	41.88	5.37	47.25	74.00	-26.75	peak
2	7236.000	34.10	11.90	46.00	74.00	-28.00	peak

Note: 1. Result (dBuV/m) = Correct Factor (dB/m) + Reading(dBuV).

2. Correction factor (dB/m) = Antenna Factor (dB/m) + Cable loss (dB) – Pre-Amplifier gain (dB).

3. When the peak results are less than average limit, so not need to evaluate the average.



Standard:	FCC Part 15.247	Test Distance:	3 m
Test item:	Harmonic	Power:	DC 3.65 V
Frequency:	2412 MHz	Temp.(°C)/Hum.(%RH):	26(°C)/60 %RH
Mode:	Mode 4		
Ant.Polar.:	Vertical		

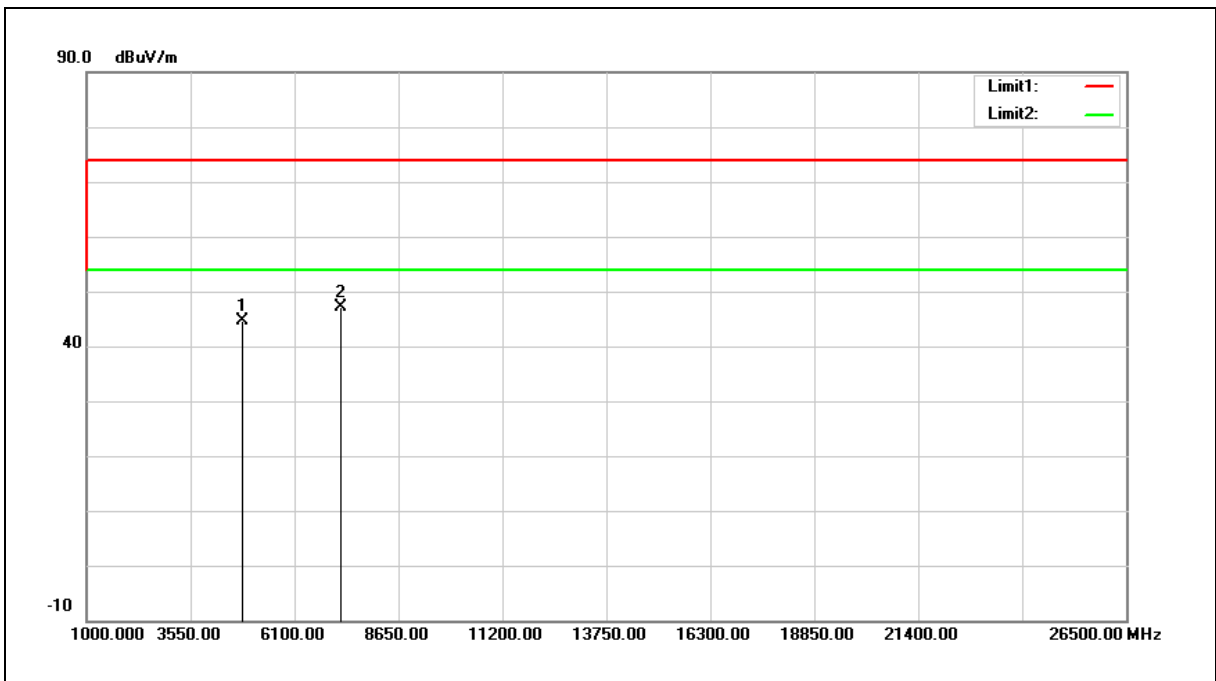

No.	Frequency (MHz)	Reading (dBuV)	Correct Factor (dB/m)	Result (dBuV/m)	Limit (dBuV/m)	Margin (dB)	Remark
1	4824.000	39.27	5.37	44.64	74.00	-29.36	peak
2	7236.000	35.31	11.90	47.21	74.00	-26.79	peak

- Note: 1.Result (dBuV/m) = Correct Factor (dB/m) + Reading(dBuV).
 2.Correction factor (dB/m) = Antenna Factor (dB/m) + Cable loss (dB) – Pre-Amplifier gain (dB).
 3.When the peak results are less than average limit, so not need to evaluate the average.



Standard:	FCC Part 15.247	Test Distance:	3 m
Test item:	Harmonic	Power:	DC 3.65 V
Frequency:	2437 MHz	Temp.(°C)/Hum.(%RH):	26(°C)/60 %RH
Mode:	Mode 4		
Ant.Polar.:	Horizontal		

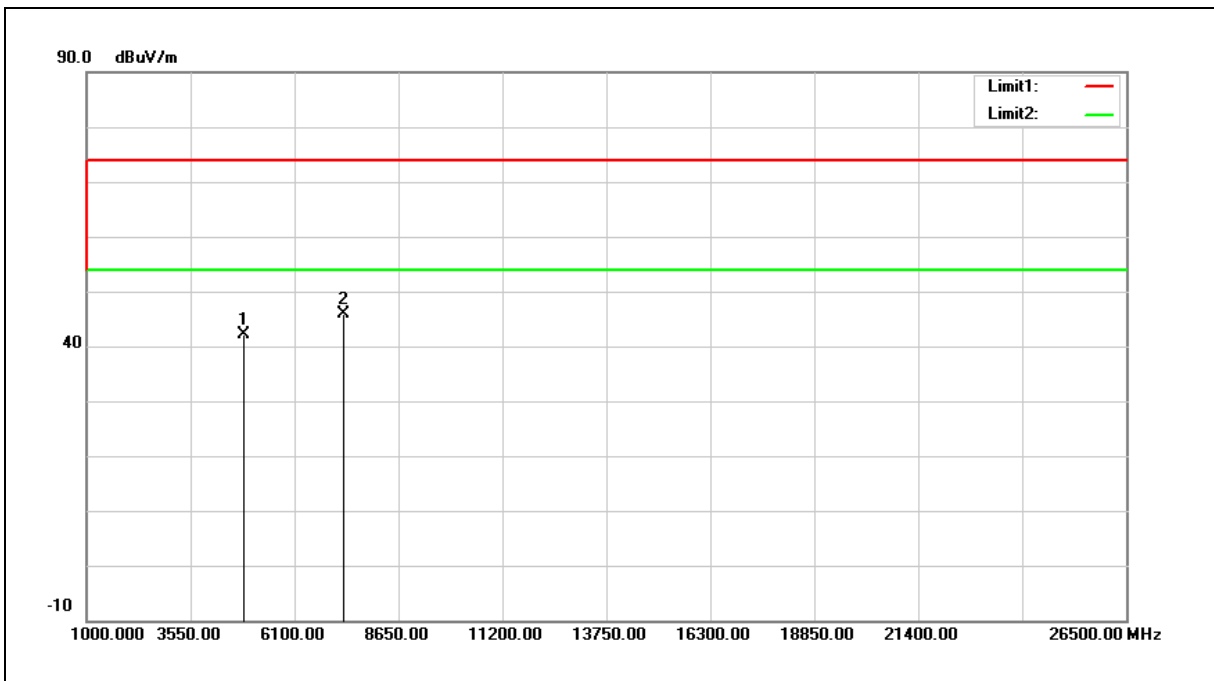

No.	Frequency (MHz)	Reading (dBuV)	Correct Factor (dB/m)	Result (dBuV/m)	Limit (dBuV/m)	Margin (dB)	Remark
1	4874.000	36.59	5.47	42.06	74.00	-31.94	peak
2	7311.000	33.84	12.13	45.97	74.00	-28.03	peak

Note: 1.Result (dBuV/m) = Correct Factor (dB/m) + Reading(dBuV).

2.Correction factor (dB/m) = Antenna Factor (dB/m) + Cable loss (dB) – Pre-Amplifier gain (dB).

3.When the peak results are less than average limit, so not need to evaluate the average.



Standard:	FCC Part 15.247	Test Distance:	3 m
Test item:	Harmonic	Power:	DC 3.65 V
Frequency:	2437 MHz	Temp.(°C)/Hum.(%RH):	26(°C)/60 %RH
Mode:	Mode 4		
Ant.Polar.:	Vertical		

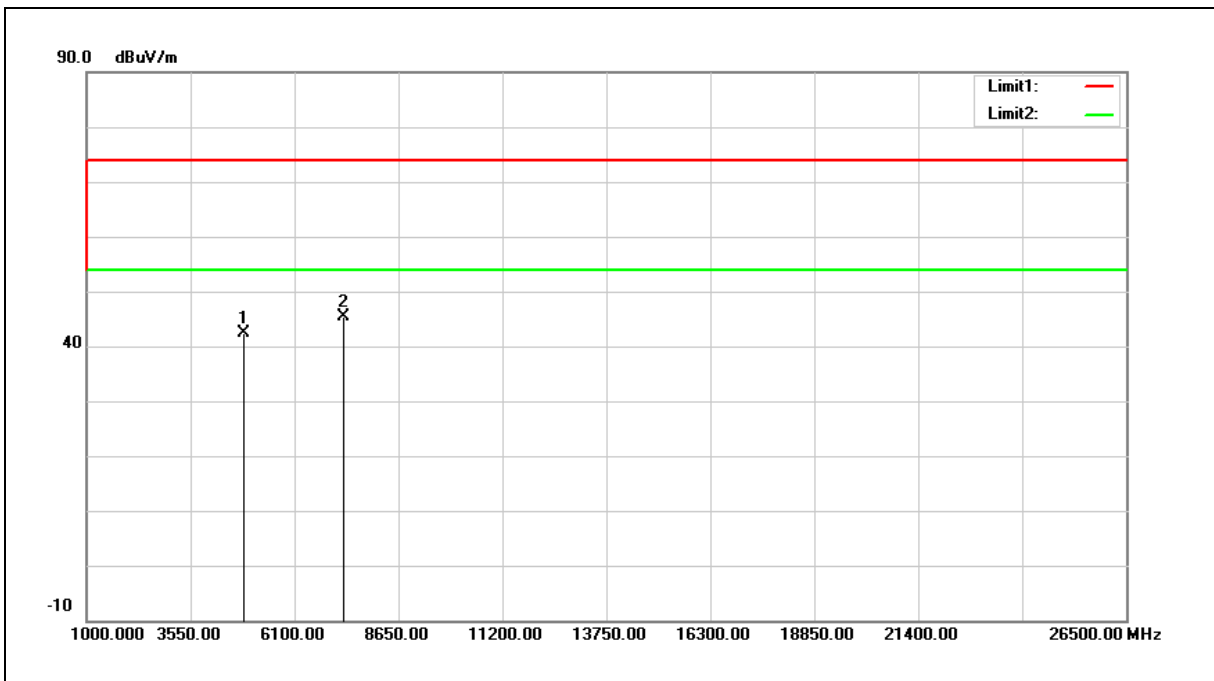

No.	Frequency (MHz)	Reading (dBuV)	Correct Factor (dB/m)	Result (dBuV/m)	Limit (dBuV/m)	Margin (dB)	Remark
1	4874.000	36.86	5.47	42.33	74.00	-31.67	peak
2	7311.000	33.37	12.13	45.50	74.00	-28.50	peak

- Note: 1.Result (dBuV/m) = Correct Factor (dB/m) + Reading(dBuV).
 2.Correction factor (dB/m) = Antenna Factor (dB/m) + Cable loss (dB) – Pre-Amplifier gain (dB).
 3.When the peak results are less than average limit, so not need to evaluate the average.



Standard:	FCC Part 15.247	Test Distance:	3 m
Test item:	Harmonic	Power:	DC 3.65 V
Frequency:	2462 MHz	Temp.(°C)/Hum.(%RH):	26(°C)/60 %RH
Mode:	Mode 4		
Ant.Polar.:	Horizontal		

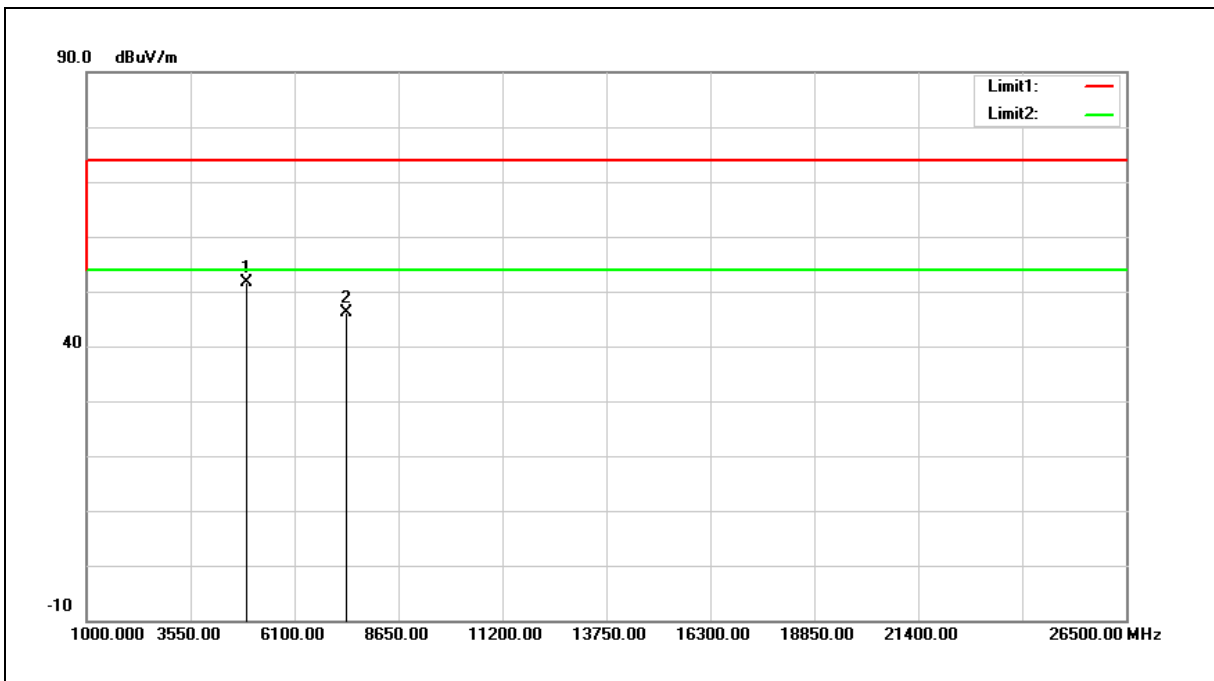

No.	Frequency (MHz)	Reading (dBuV)	Correct Factor (dB/m)	Result (dBuV/m)	Limit (dBuV/m)	Margin (dB)	Remark
1	4924.000	46.17	5.58	51.75	74.00	-22.25	peak
2	7386.000	33.80	12.36	46.16	74.00	-27.84	peak

- Note: 1.Result (dBuV/m) = Correct Factor (dB/m) + Reading(dBuV).
 2.Correction factor (dB/m) = Antenna Factor (dB/m) + Cable loss (dB) – Pre-Amplifier gain (dB).
 3.When the peak results are less than average limit, so not need to evaluate the average.



Standard:	FCC Part 15.247	Test Distance:	3 m
Test item:	Harmonic	Power:	DC 3.65 V
Frequency:	2462 MHz	Temp.(°C)/Hum.(%RH):	26(°C)/60 %RH
Mode:	Mode 4		
Ant.Polar.:	Vertical		

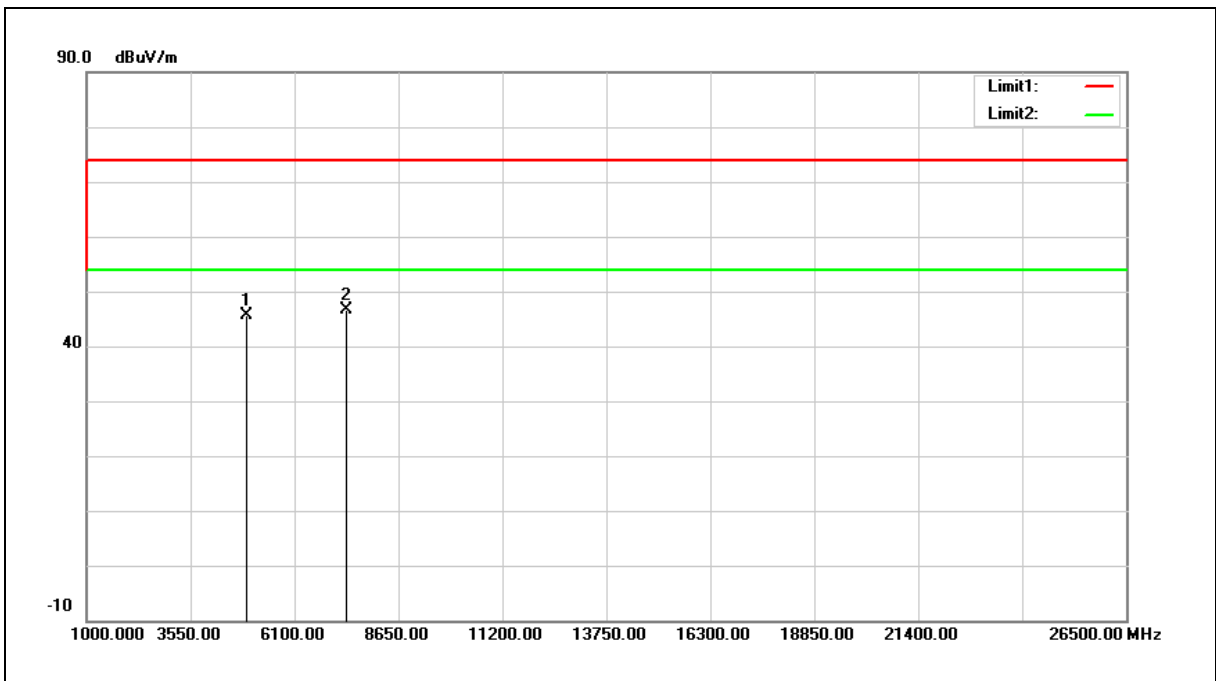

No.	Frequency (MHz)	Reading (dBuV)	Correct Factor (dB/m)	Result (dBuV/m)	Limit (dBuV/m)	Margin (dB)	Remark
1	4924.000	40.17	5.58	45.75	74.00	-28.25	peak
2	7386.000	34.29	12.36	46.65	74.00	-27.35	peak

Note: 1.Result (dBuV/m) = Correct Factor (dB/m) + Reading(dBuV).

2.Correction factor (dB/m) = Antenna Factor (dB/m) + Cable loss (dB) – Pre-Amplifier gain (dB).

3.When the peak results are less than average limit, so not need to evaluate the average.



Band Edge

Standard:	FCC Part 15.247	Test Distance:	3 m
Test item:	Band edge	Power:	DC 3.65 V
Frequency:	2412 MHz	Temp.(°C)/Hum.(%RH):	26(°C)/60 %RH
Mode:	Mode 2		
Ant.Polar.:	Horizontal		

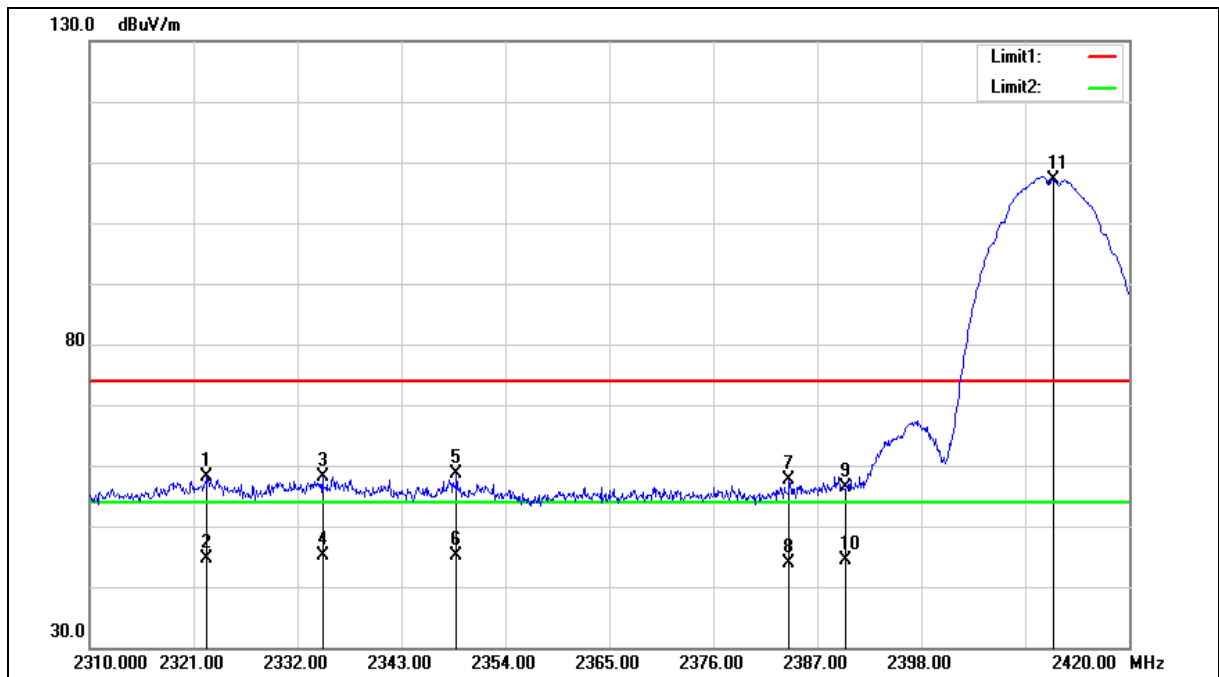



Standard:	FCC Part 15.247	Test Distance:	3 m
Test item:	Band edge	Power:	DC 3.65 V
Frequency:	2412 MHz	Temp.(°C)/Hum.(%RH):	26(°C)/60 %RH
Mode:	Mode 2		
Ant.Polar.:	Horizontal		

No.	Frequency (MHz)	Reading (dBuV)	Correct Factor (dB/m)	Result (dBuV/m)	Limit (dBuV/m)	Margin (dB)	Remark
1	2322.430	59.52	-1.41	58.11	74.00	-15.89	peak
2	2322.430	46.15	-1.41	44.74	54.00	-9.26	AVG
3	2334.640	59.43	-1.37	58.06	74.00	-15.94	peak
4	2334.640	46.52	-1.37	45.15	54.00	-8.85	AVG
5	2348.830	59.88	-1.31	58.57	74.00	-15.43	peak
6	2348.830	46.39	-1.31	45.08	54.00	-8.92	AVG
7	2384.030	58.72	-1.19	57.53	74.00	-16.47	peak
8	2384.030	45.10	-1.19	43.91	54.00	-10.09	AVG
9	2390.000	57.67	-1.17	56.50	74.00	-17.50	peak
10	2390.000	45.61	-1.17	44.44	54.00	-9.56	AVG
11	2412.000	108.22	-1.08	107.14	--	--	peak

Note:1.Result (dBuV/m) = Correct Factor (dB/m) + Reading(dBuV).

2.Correction factor (dB/m) = Antenna Factor (dB/m) + Cable loss (dB) – Pre-Amplifier gain (dB).

3.When the peak results are less than average limit, so not need to evaluate the average.



Standard:	FCC Part 15.247	Test Distance:	3 m
Test item:	Band edge	Power:	DC 3.65 V
Frequency:	2412 MHz	Temp.(°C)/Hum.(%RH):	26(°C)/60 %RH
Mode:	Mode 2		
Ant.Polar.:	Vertical		

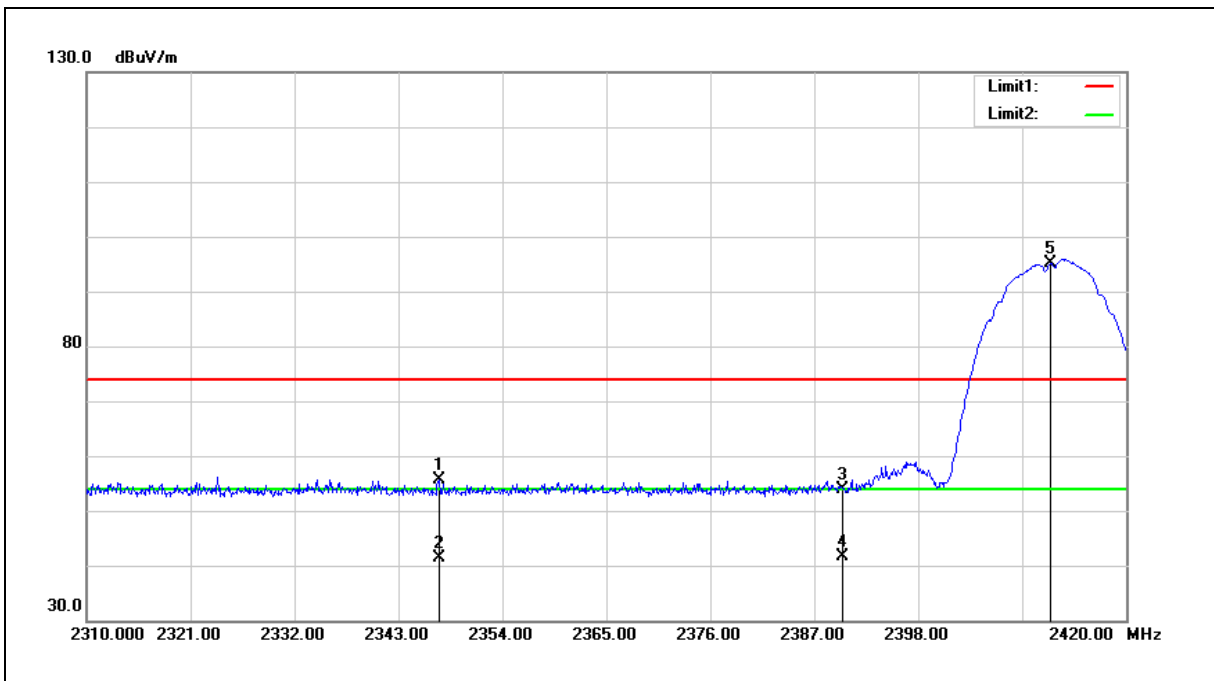

No.	Frequency (MHz)	Reading (dBuV)	Correct Factor (dB/m)	Result (dBuV/m)	Limit (dBuV/m)	Margin (dB)	Remark
1	2347.290	56.97	-1.32	55.65	74.00	-18.35	peak
2	2347.290	42.79	-1.32	41.47	54.00	-12.53	AVG
3	2390.000	55.10	-1.17	53.93	74.00	-20.07	peak
4	2390.000	42.87	-1.17	41.70	54.00	-12.30	AVG
5	2412.000	96.11	-1.08	95.03	--	--	peak

Note:1.Result (dBuV/m) = Correct Factor (dB/m) + Reading(dBuV).

2.Correction factor (dB/m) = Antenna Factor (dB/m) + Cable loss (dB) – Pre-Amplifier gain (dB).

3.When the peak results are less than average limit, so not need to evaluate the average.



Standard:	FCC Part 15.247	Test Distance:	3 m
Test item:	Band edge	Power:	DC 3.65 V
Frequency:	2462 MHz	Temp.(°C)/Hum.(%RH):	26(°C)/60 %RH
Mode:	Mode 2		
Ant.Polar.:	Horizontal		

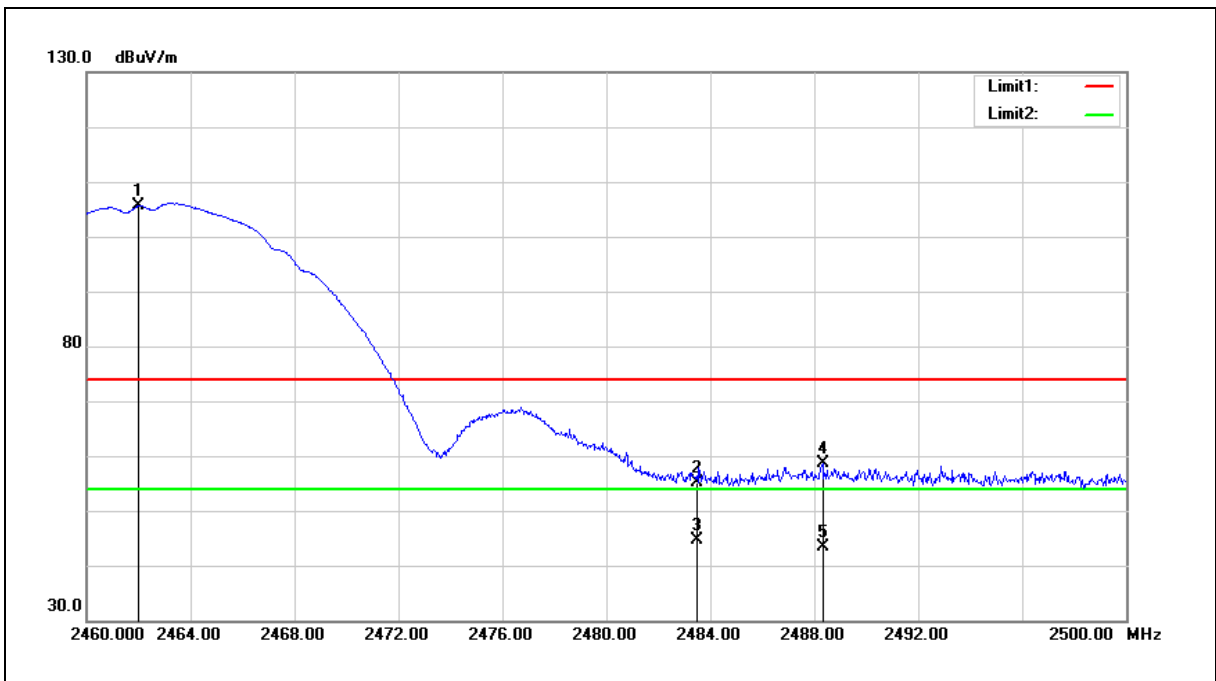

No.	Frequency (MHz)	Reading (dBuV)	Correct Factor (dB/m)	Result (dBuV/m)	Limit (dBuV/m)	Margin (dB)	Remark
1	2462.000	106.44	-0.90	105.54	--	--	peak
2	2483.500	55.93	-0.82	55.11	74.00	-18.89	peak
3	2483.500	45.46	-0.82	44.64	54.00	-9.36	AVG
4	2488.320	59.53	-0.80	58.73	74.00	-15.27	peak
5	2488.320	44.08	-0.80	43.28	54.00	-10.72	AVG

Note:1.Result (dBuV/m) = Correct Factor (dB/m) + Reading(dBuV).

2.Correction factor (dB/m) = Antenna Factor (dB/m) + Cable loss (dB) – Pre-Amplifier gain (dB).

3.When the peak results are less than average limit, so not need to evaluate the average.



Standard:	FCC Part 15.247	Test Distance:	3 m
Test item:	Band edge	Power:	DC 3.65 V
Frequency:	2462 MHz	Temp.(°C)/Hum.(%RH):	26(°C)/60 %RH
Mode:	Mode 2		
Ant.Polar.:	Vertical		

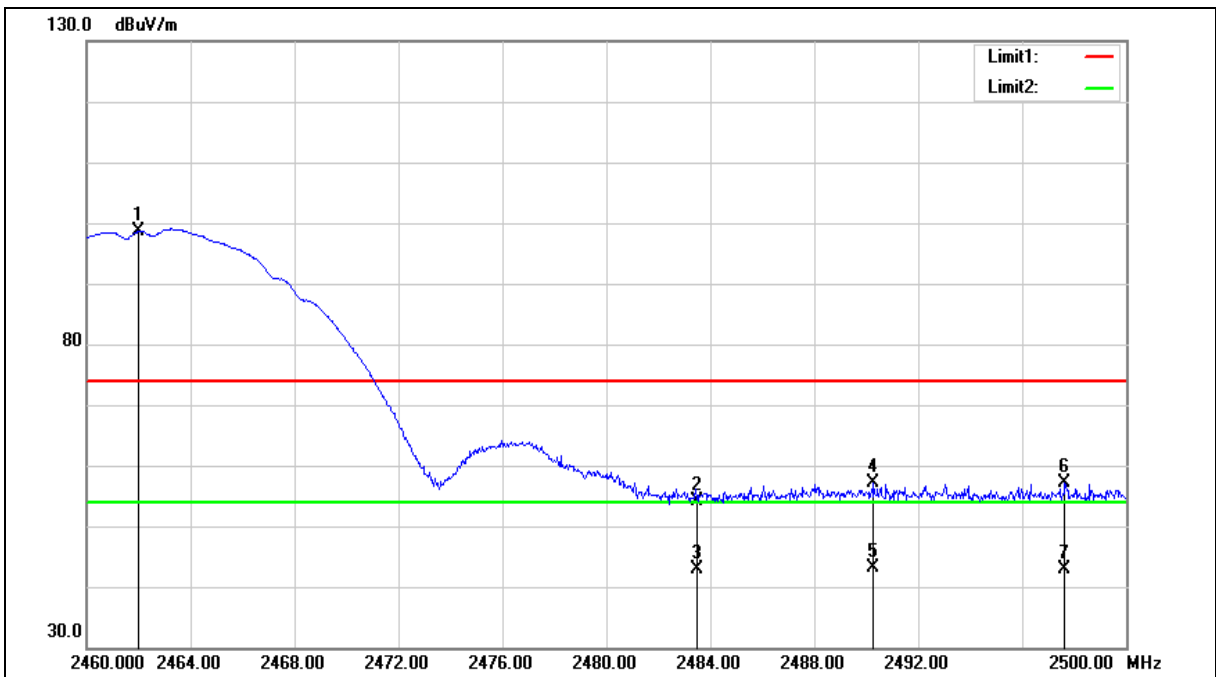



Standard:	FCC Part 15.247	Test Distance:	3 m
Test item:	Band edge	Power:	DC 3.65 V
Frequency:	2462 MHz	Temp.(°C)/Hum.(%RH):	26(°C)/60 %RH
Mode:	Mode 2		
Ant.Polar.:	Vertical		

No.	Frequency (MHz)	Reading (dBuV)	Correct Factor (dB/m)	Result (dBuV/m)	Limit (dBuV/m)	Margin (dB)	Remark
1	2462.000	99.50	-0.90	98.60	--	--	peak
2	2483.500	54.90	-0.82	54.08	74.00	-19.92	peak
3	2483.500	43.64	-0.82	42.82	54.00	-11.18	AVG
4	2490.280	57.83	-0.80	57.03	74.00	-16.97	peak
5	2490.280	43.89	-0.80	43.09	54.00	-10.91	AVG
6	2497.640	57.83	-0.77	57.06	74.00	-16.94	peak
7	2497.640	43.65	-0.77	42.88	54.00	-11.12	AVG

Note:1.Result (dBuV/m) = Correct Factor (dB/m) + Reading(dBuV).

2.Correction factor (dB/m) = Antenna Factor (dB/m) + Cable loss (dB) – Pre-Amplifier gain (dB).

3.When the peak results are less than average limit, so not need to evaluate the average.



Standard:	FCC Part 15.247	Test Distance:	3 m
Test item:	Band edge	Power:	DC 3.65 V
Frequency:	2412 MHz	Temp.(°C)/Hum.(%RH):	26(°C)/60 %RH
Mode:	Mode 3		
Ant.Polar.:	Horizontal		

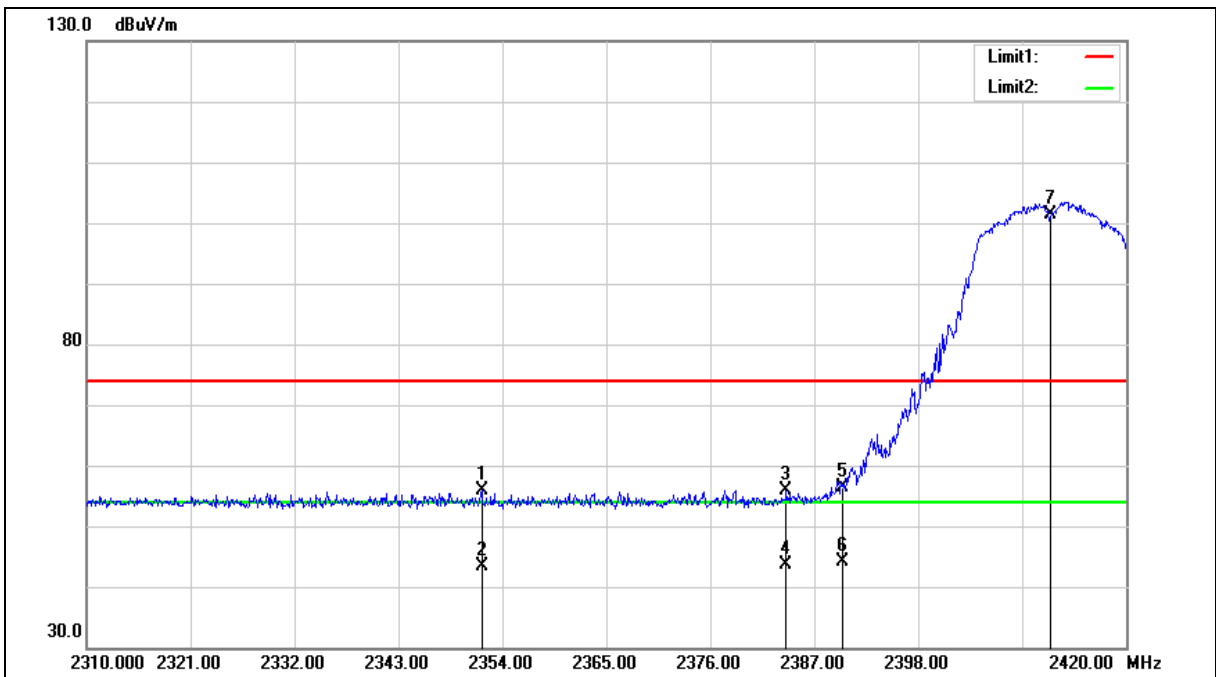



Standard:	FCC Part 15.247	Test Distance:	3 m
Test item:	Band edge	Power:	DC 3.65 V
Frequency:	2412 MHz	Temp.(°C)/Hum.(%RH):	26(°C)/60 %RH
Mode:	Mode 3		
Ant.Polar.:	Horizontal		

No.	Frequency (MHz)	Reading (dBuV)	Correct Factor (dB/m)	Result (dBuV/m)	Limit (dBuV/m)	Margin (dB)	Remark
1	2351.800	57.11	-1.30	55.81	74.00	-18.19	peak
2	2351.800	44.74	-1.30	43.44	54.00	-10.56	AVG
3	2384.030	57.03	-1.19	55.84	74.00	-18.16	peak
4	2384.030	44.87	-1.19	43.68	54.00	-10.32	AVG
5	2390.000	57.51	-1.17	56.34	74.00	-17.66	peak
6	2390.000	45.20	-1.17	44.03	54.00	-9.97	AVG
7	2412.000	102.40	-1.08	101.32	--	--	peak

Note:1.Result (dBuV/m) = Correct Factor (dB/m) + Reading(dBuV).

2.Correction factor (dB/m) = Antenna Factor (dB/m) + Cable loss (dB) – Pre-Amplifier gain (dB).

3.When the peak results are less than average limit, so not need to evaluate the average.



Standard:	FCC Part 15.247	Test Distance:	3 m
Test item:	Band edge	Power:	DC 3.65 V
Frequency:	2412 MHz	Temp.(°C)/Hum.(%RH):	26(°C)/60 %RH
Mode:	Mode 3		
Ant.Polar.:	Vertical		

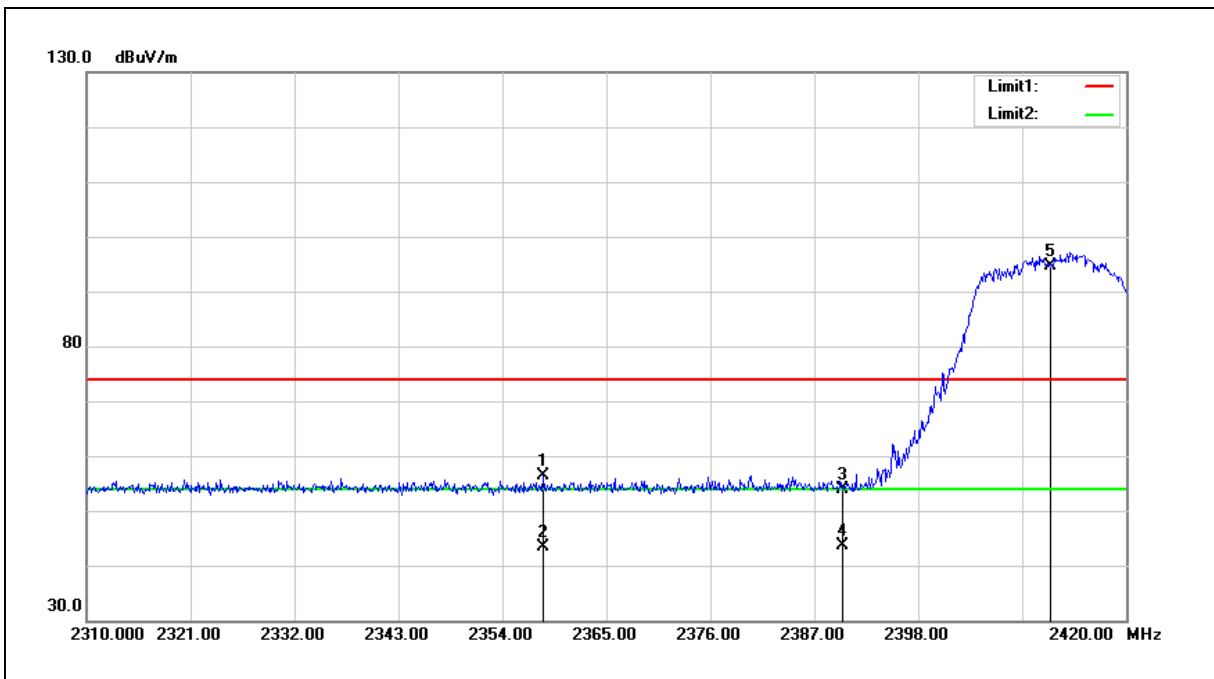

No.	Frequency (MHz)	Reading (dBuV)	Correct Factor (dB/m)	Result (dBuV/m)	Limit (dBuV/m)	Margin (dB)	Remark
1	2358.290	57.55	-1.28	56.27	74.00	-17.73	peak
2	2358.290	44.70	-1.28	43.42	54.00	-10.58	AVG
3	2390.000	55.09	-1.17	53.92	74.00	-20.08	peak
4	2390.000	44.71	-1.17	43.54	54.00	-10.46	AVG
5	2412.000	95.74	-1.08	94.66	--	--	peak

Note:1.Result (dBuV/m) = Correct Factor (dB/m) + Reading(dBuV).

2.Correction factor (dB/m) = Antenna Factor (dB/m) + Cable loss (dB) – Pre-Amplifier gain (dB).

3.When the peak results are less than average limit, so not need to evaluate the average.



Standard:	FCC Part 15.247	Test Distance:	3 m
Test item:	Band edge	Power:	DC 3.65 V
Frequency:	2462 MHz	Temp.(°C)/Hum.(%RH):	26(°C)/60 %RH
Mode:	Mode 3		
Ant.Polar.:	Horizontal		

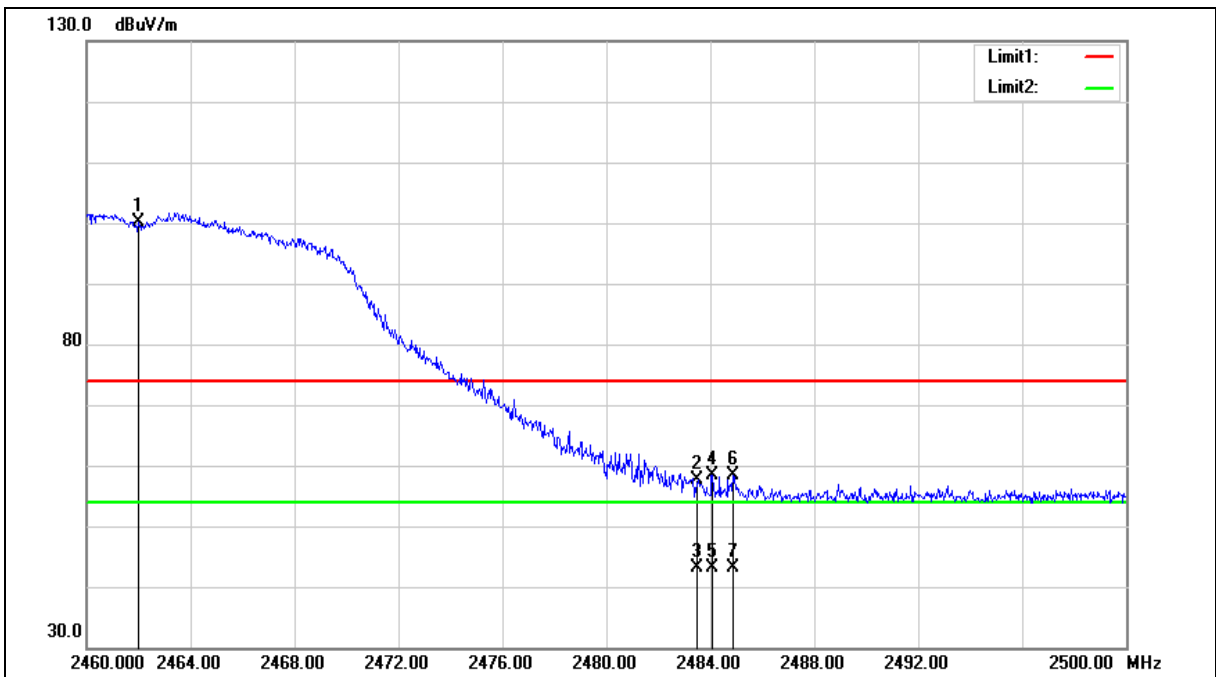



Standard:	FCC Part 15.247	Test Distance:	3 m
Test item:	Band edge	Power:	DC 3.65 V
Frequency:	2462 MHz	Temp.(°C)/Hum.(%RH):	26(°C)/60 %RH
Mode:	Mode 3		
Ant.Polar.:	Horizontal		

No.	Frequency (MHz)	Reading (dBuV)	Correct Factor (dB/m)	Result (dBuV/m)	Limit (dBuV/m)	Margin (dB)	Remark
1	2462.000	100.91	-0.90	100.01	--	--	peak
2	2483.500	58.41	-0.82	57.59	74.00	-16.41	peak
3	2483.500	43.90	-0.82	43.08	54.00	-10.92	AVG
4	2484.080	59.29	-0.82	58.47	74.00	-15.53	peak
5	2484.080	43.86	-0.82	43.04	54.00	-10.96	AVG
6	2484.880	59.17	-0.82	58.35	74.00	-15.65	peak
7	2484.880	43.84	-0.82	43.02	54.00	-10.98	AVG

Note:1.Result (dBuV/m) = Correct Factor (dB/m) + Reading(dBuV).

2.Correction factor (dB/m) = Antenna Factor (dB/m) + Cable loss (dB) – Pre-Amplifier gain (dB).

3.When the peak results are less than average limit, so not need to evaluate the average.



Standard:	FCC Part 15.247	Test Distance:	3 m
Test item:	Band edge	Power:	DC 3.65 V
Frequency:	2462 MHz	Temp.(°C)/Hum.(%RH):	26(°C)/60 %RH
Mode:	Mode 3		
Ant.Polar.:	Vertical		

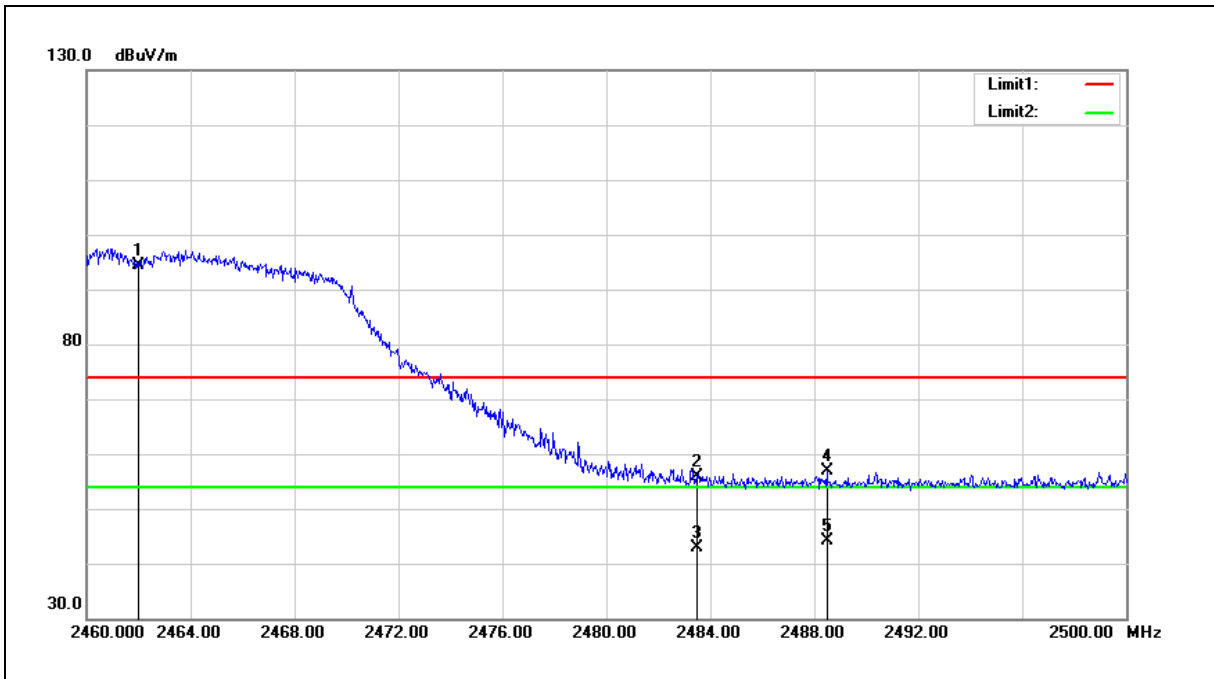

No.	Frequency (MHz)	Reading (dBuV)	Correct Factor (dB/m)	Result (dBuV/m)	Limit (dBuV/m)	Margin (dB)	Remark
1	2462.000	95.28	-0.90	94.38	--	--	peak
2	2483.500	56.68	-0.82	55.86	74.00	-18.14	peak
3	2483.500	43.70	-0.82	42.88	54.00	-11.12	AVG
4	2488.480	57.77	-0.80	56.97	74.00	-17.03	peak
5	2488.480	44.83	-0.80	44.03	54.00	-9.97	AVG

Note:1.Result (dBuV/m) = Correct Factor (dB/m) + Reading(dBuV).

2.Correction factor (dB/m) = Antenna Factor (dB/m) + Cable loss (dB) – Pre-Amplifier gain (dB).

3.When the peak results are less than average limit, so not need to evaluate the average.



Standard:	FCC Part 15.247	Test Distance:	3 m
Test item:	Band edge	Power:	DC 3.65 V
Frequency:	2412 MHz	Temp.(°C)/Hum.(%RH):	26(°C)/60 %RH
Mode:	Mode 4		
Ant.Polar.:	Horizontal		

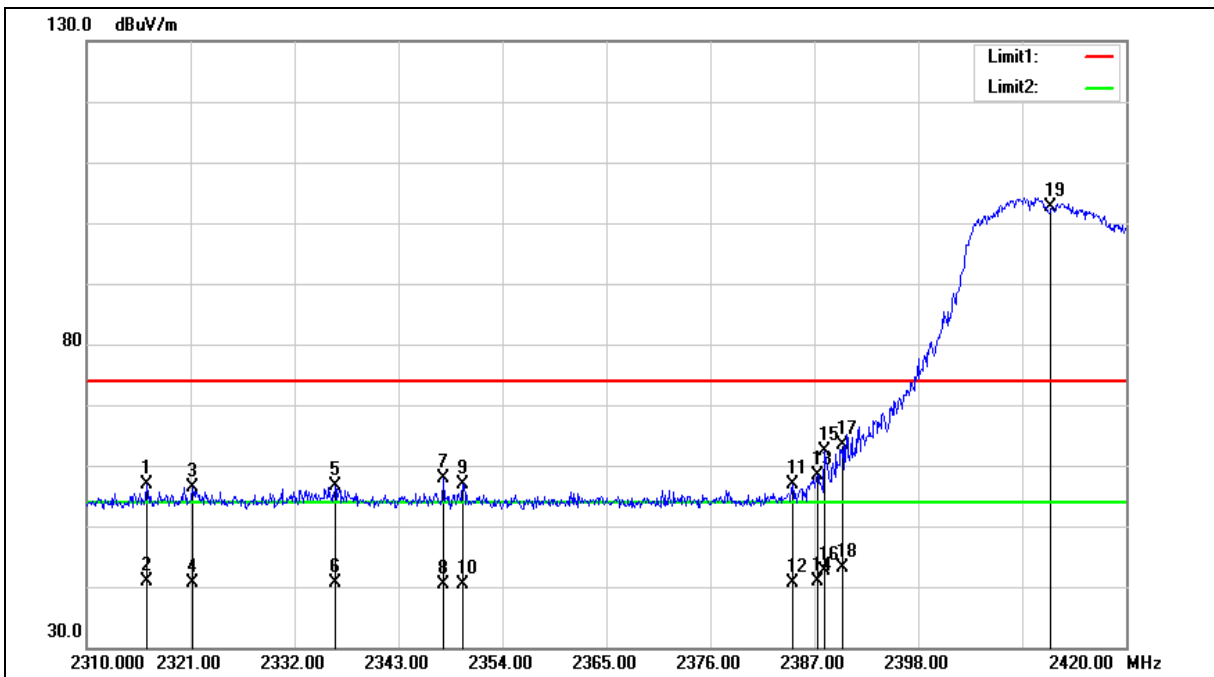



Standard:	FCC Part 15.247	Test Distance:	3 m
Test item:	Band edge	Power:	DC 3.65 V
Frequency:	2412 MHz	Temp.(°C)/Hum.(%RH):	26(°C)/60 %RH
Mode:	Mode 4		
Ant.Polar.:	Horizontal		

No.	Frequency (MHz)	Reading (dBuV)	Correct Factor (dB/m)	Result (dBuV/m)	Limit (dBuV/m)	Margin (dB)	Remark
1	2316.380	58.23	-1.44	56.79	74.00	-17.21	peak
2	2316.380	42.26	-1.44	40.82	54.00	-13.18	AVG
3	2321.220	57.80	-1.41	56.39	74.00	-17.61	peak
4	2321.220	41.94	-1.41	40.53	54.00	-13.47	AVG
5	2336.290	57.90	-1.36	56.54	74.00	-17.46	peak
6	2336.290	42.09	-1.36	40.73	54.00	-13.27	AVG
7	2347.730	59.25	-1.32	57.93	74.00	-16.07	peak
8	2347.730	41.81	-1.32	40.49	54.00	-13.51	AVG
9	2349.820	58.19	-1.31	56.88	74.00	-17.12	peak
10	2349.820	41.75	-1.31	40.44	54.00	-13.56	AVG
11	2384.690	58.09	-1.19	56.90	74.00	-17.10	peak
12	2384.690	41.82	-1.19	40.63	54.00	-13.37	AVG
13	2387.330	59.62	-1.17	58.45	74.00	-15.55	peak
14	2387.330	42.12	-1.17	40.95	54.00	-13.05	AVG
15	2388.100	63.62	-1.17	62.45	74.00	-11.55	peak
16	2388.100	43.80	-1.17	42.63	54.00	-11.37	AVG
17	2390.000	64.48	-1.17	63.31	74.00	-10.69	peak
18	2390.000	44.33	-1.17	43.16	54.00	-10.84	AVG
19	2412.000	103.61	-1.08	102.53	--	--	peak

Note:1.Result (dBuV/m) = Correct Factor (dB/m) + Reading(dBuV).

2.Correction factor (dB/m) = Antenna Factor (dB/m) + Cable loss (dB) – Pre-Amplifier gain (dB).

3.When the peak results are less than average limit, so not need to evaluate the average.



Standard:	FCC Part 15.247	Test Distance:	3 m
Test item:	Band edge	Power:	DC 3.65 V
Frequency:	2412 MHz	Temp.(°C)/Hum.(%RH):	26(°C)/60 %RH
Mode:	Mode 4		
Ant.Polar.:	Vertical		

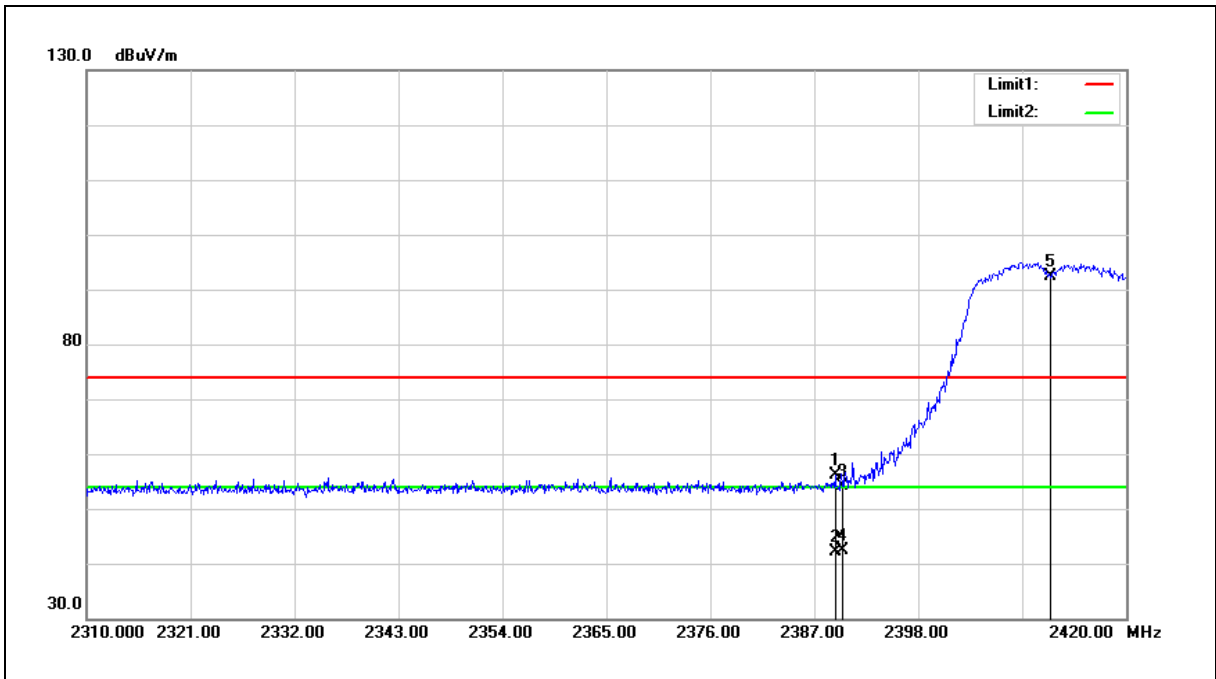

No.	Frequency (MHz)	Reading (dBuV)	Correct Factor (dB/m)	Result (dBuV/m)	Limit (dBuV/m)	Margin (dB)	Remark
1	2389.200	57.33	-1.17	56.16	74.00	-17.84	peak
2	2389.200	43.32	-1.17	42.15	54.00	-11.85	AVG
3	2390.000	55.36	-1.17	54.19	74.00	-19.81	peak
4	2390.000	43.48	-1.17	42.31	54.00	-11.69	AVG
5	2412.000	93.53	-1.08	92.45	--	--	peak

Note:1.Result (dBuV/m) = Correct Factor (dB/m) + Reading(dBuV).

2.Correction factor (dB/m) = Antenna Factor (dB/m) + Cable loss (dB) – Pre-Amplifier gain (dB).

3.When the peak results are less than average limit, so not need to evaluate the average.



Standard:	FCC Part 15.247	Test Distance:	3 m
Test item:	Band edge	Power:	DC 3.65 V
Frequency:	2462 MHz	Temp.(°C)/Hum.(%RH):	26(°C)/60 %RH
Mode:	Mode 4		
Ant.Polar.:	Horizontal		

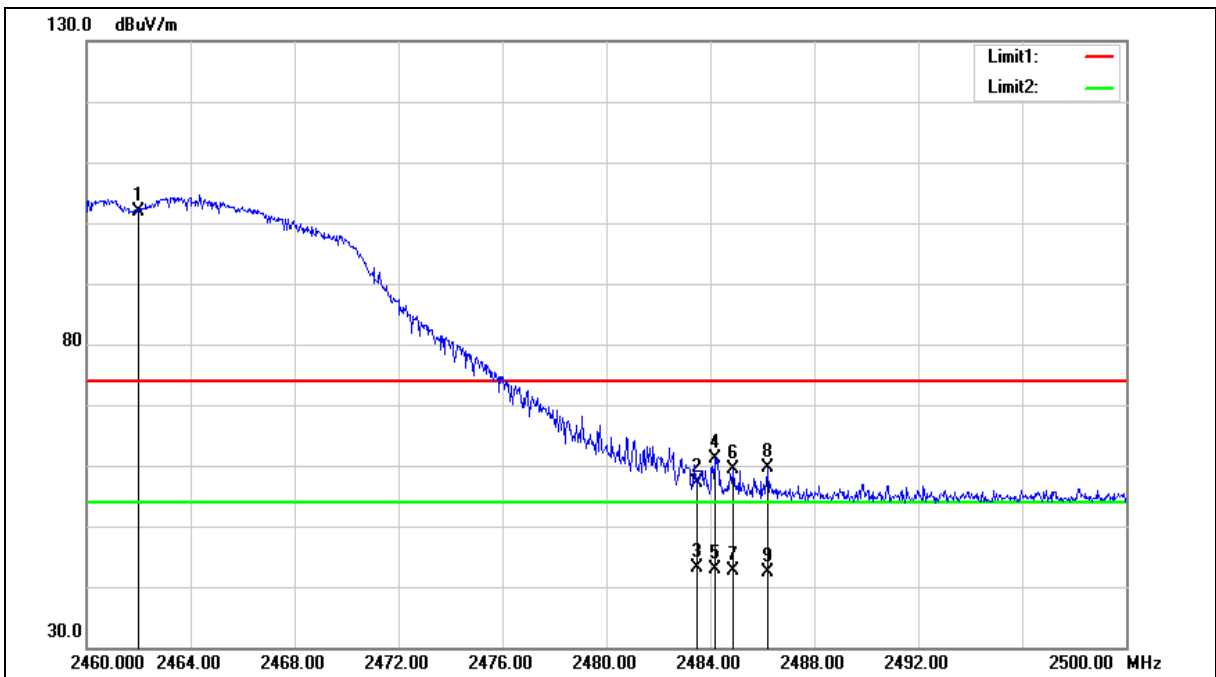



Standard:	FCC Part 15.247	Test Distance:	3 m
Test item:	Band edge	Power:	DC 3.65 V
Frequency:	2462 MHz	Temp.(°C)/Hum.(%RH):	26(°C)/60 %RH
Mode:	Mode 4		
Ant.Polar.:	Horizontal		

No.	Frequency (MHz)	Reading (dBUV)	Correct Factor (dB/m)	Result (dBUV/m)	Limit (dBUV/m)	Margin (dB)	Remark
1	2462.000	102.78	-0.90	101.88	--	--	peak
2	2483.500	57.88	-0.82	57.06	74.00	-16.94	peak
3	2483.500	43.94	-0.82	43.12	54.00	-10.88	AVG
4	2484.160	61.98	-0.82	61.16	74.00	-12.84	peak
5	2484.160	43.63	-0.82	42.81	54.00	-11.19	AVG
6	2484.880	60.11	-0.82	59.29	74.00	-14.71	peak
7	2484.880	43.37	-0.82	42.55	54.00	-11.45	AVG
8	2486.200	60.36	-0.82	59.54	74.00	-14.46	peak
9	2486.200	43.18	-0.82	42.36	54.00	-11.64	AVG

Note:1.Result (dBUV/m) = Correct Factor (dB/m) + Reading(dBUV).

2.Correction factor (dB/m) = Antenna Factor (dB/m) + Cable loss (dB) – Pre-Amplifier gain (dB).

3.When the peak results are less than average limit, so not need to evaluate the average.



Standard:	FCC Part 15.247	Test Distance:	3 m
Test item:	Band edge	Power:	DC 3.65 V
Frequency:	2462 MHz	Temp.(°C)/Hum.(%RH):	26(°C)/60 %RH
Mode:	Mode 4		
Ant.Polar.:	Vertical		

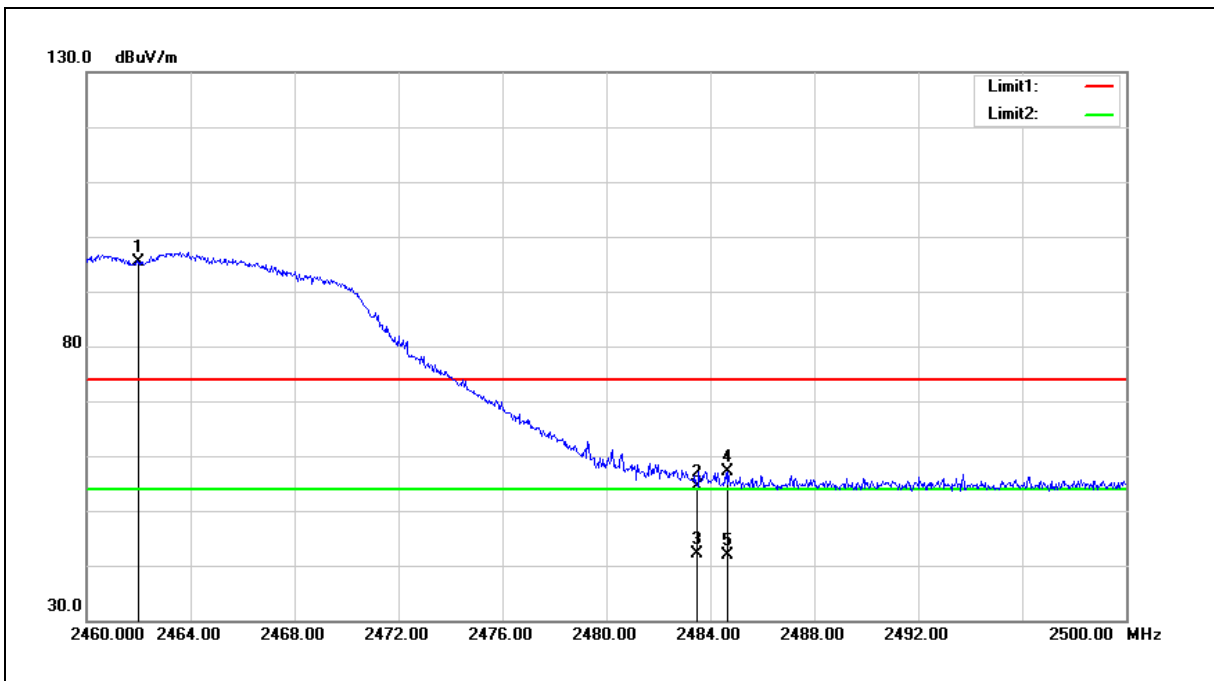

No.	Frequency (MHz)	Reading (dBuV)	Correct Factor (dB/m)	Result (dBuV/m)	Limit (dBuV/m)	Margin (dB)	Remark
1	2462.000	96.25	-0.90	95.35	--	--	peak
2	2483.500	55.12	-0.82	54.30	74.00	-19.70	peak
3	2483.500	42.93	-0.82	42.11	54.00	-11.89	AVG
4	2484.680	57.96	-0.82	57.14	74.00	-16.86	peak
5	2484.680	42.75	-0.82	41.93	54.00	-12.07	AVG

Note:1.Result (dBuV/m) = Correct Factor (dB/m) + Reading(dBuV).

2.Correction factor (dB/m) = Antenna Factor (dB/m) + Cable loss (dB) – Pre-Amplifier gain (dB).

3.When the peak results are less than average limit, so not need to evaluate the average.