



FCC Test Report

Equipment : Spotlight Cam Wired
Brand Name : RING
Model No. : Spotlight Cam Wired
FCC ID : 2AEUPBHARC001
Standard : 47 CFR FCC Part 15.247
Operating Band : 2400 MHz – 2483.5 MHz
Function : Point-to-multipoint; Point-to-point
Applicant : Bot Home Automation, Inc.
1523 26th St, Santa Monica, CA 90404, USA
Manufacturer : Chicony Electronics (Dong Guan) Co.,Ltd.
San Zhong Guan Li Qu, Qingxi Town, Dongguan City
Guangdong 523651 China

The product sample received on Jun. 07, 2017 and completely tested on Jun. 28, 2017. We, SPORTON, would like to declare that the tested sample has been evaluated in accordance with the procedures given in ANSI C63.10-2013 and shown compliance with the applicable technical standards.

The test results in this report apply exclusively to the tested model / sample. Without written approval of SPORTON INTERNATIONAL INC., the test report shall not be reproduced except in full.

Phoenix Chen
SPORTON INTERNATIONAL INC.





Table of Contents

1 GENERAL DESCRIPTION5

1.1 Information.....5

1.2 Testing Applied Standards6

1.3 Testing Location Information6

1.4 Measurement Uncertainty6

2 TEST CONFIGURATION OF EUT.....7

2.1 Test Condition7

2.2 Test Channel Mode7

2.3 The Worst Case Measurement Configuration.....8

2.4 Support Equipment.....9

2.5 Test Setup Diagram9

3 TRANSMITTER TEST RESULT11

3.1 AC Power-line Conducted Emissions11

3.2 DTS Bandwidth.....12

3.3 Maximum Conducted Output Power13

3.4 Power Spectral Density15

3.5 Emissions in Non-restricted Frequency Bands16

3.6 Emissions in Restricted Frequency Bands.....17

4 TEST EQUIPMENT AND CALIBRATION DATA21

APPENDIX A. TEST RESULTS OF AC POWER-LINE CONDUCTED EMISSIONS

APPENDIX B. TEST RESULTS OF DTS BANDWIDTH

APPENDIX C. TEST RESULTS OF MAXIMUM CONDUCTED OUTPUT POWER

APPENDIX D. TEST RESULTS OF POWER SPECTRAL DENSITY

APPENDIX E. TEST RESULTS OF EMISSIONS IN NON-RESTRICTED FREQUENCY BANDS

APPENDIX F. TEST RESULTS OF EMISSIONS IN RESTRICTED FREQUENCY BANDS

APPENDIX G. TEST PHOTOS

PHOTOGRAPHS OF EUT V01



Summary of Test Result

Conformance Test Specifications				
Report Clause	Ref. Std. Clause	Description	Limit	Result
1.1.2	15.203	Antenna Requirement	FCC 15.203	Complied
3.1	15.207	AC Power-line Conducted Emissions	FCC 15.207	Complied
3.2	15.247(a)	DTS Bandwidth	≥500kHz	Complied
3.3	15.247(b)	Maximum Conducted Output Power	Power [dBm]:30	Complied
3.4	15.247(e)	Power Spectral Density	PSD [dBm/3kHz]:8	Complied
3.5	15.247(d)	Emissions in Non-restricted Frequency Bands	Non-Restricted Bands: > 30 dBc	Complied
3.6	15.247(d)	Emissions in Restricted Frequency Bands	Restricted Bands: FCC 15.209	Complied



1 General Description

1.1 Information

1.1.1 RF General Information

Frequency Range (MHz)	IEEE Std. 802.11	Ch. Frequency (MHz)	Channel Number
2400-2483.5	b, g, n (HT20)	2412-2462	1-11 [11]
2400-2483.5	n (HT40)	2422-2452	3-9 [7]

Band	Mode	BWch (MHz)	Nant
2.4-2.4835GHz	802.11b	20	1TX
2.4-2.4835GHz	802.11g	20	1TX
2.4-2.4835GHz	802.11n HT20	20	2TX
2.4-2.4835GHz	802.11n HT40	40	1TX

Note:

- ◆ 11b mode uses a combination of DSSS-DBPSK, DQPSK, CCK modulation.
- ◆ 11g, HT20 and HT40 use a combination of OFDM-BPSK, QPSK, 16QAM, 64QAM modulation.
- ◆ BWch is the nominal channel bandwidth.

1.1.2 Antenna Information

Ant.	Port	Brand	Model Name	Antenna Type	Connector	Gain (dBi)
1	1	-	-	PCB	mini Murata	1.64

1.1.3 EUT Information

Operational Condition	
EUT Power Type	From Cradle
Beamforming Function	<input type="checkbox"/> With beamforming <input checked="" type="checkbox"/> Without beamforming
Type of EUT	
<input checked="" type="checkbox"/>	Stand-alone
<input type="checkbox"/>	Combined (EUT where the radio part is fully integrated within another device)
	Combined Equipment - Brand Name / Model No.: ...
<input type="checkbox"/>	Plug-in radio (EUT intended for a variety of host systems)
	Host System - Brand Name / Model No.: ...
<input type="checkbox"/>	Other:



1.1.4 Mode Test Duty Cycle

Mode	DC	DCF(dB)	T(s)	VBW(Hz) ≥ 1/T
802.11b	0.98	0.088	n/a (DC>=0.98)	n/a (DC>=0.98)
802.11g	0.873	0.59	1.403m	1k
802.11n HT20	0.858	0.665	1.312m	1k
802.11n HT40	0.749	1.255	651.875u	3k

1.2 Testing Applied Standards

According to the specifications of the manufacturer, the EUT must comply with the requirements of the following standards:

- ♦ 47 CFR FCC Part 15
- ♦ ANSI C63.10-2013
- ♦ KDB 558074 D01 v04
- ♦ KDB 662911 D01 v02r01

1.3 Testing Location Information

Testing Location		
<input checked="" type="checkbox"/>	HWA YA	ADD : No. 52, Huaya 1st Rd., Guishan Dist., Taoyuan City, Taiwan (R.O.C.) TEL : 886-3-327-3456 FAX : 886-3-327-0973
Test site Designation No. 553509 with FCC.		
<input type="checkbox"/>	JHUBEI	ADD : No.8, Ln. 724, Bo'ai St., Zhubei City, Hsinchu County, Taiwan (R.O.C.) TEL : 886-3-656-9065 FAX : 886-3-656-9085
Test site Designation No. TW0006 with FCC.		

Test Condition	Test Site No.	Test Engineer	Test Environment	Test Date
RF Conducted	TH06-HY	Wayne	22.5°C / 65.5%	27/Jun/2017
Radiated	03CH01-HY	Terry	23.5°C / 65%	28/Jun/2017
AC Conduction	CO01-LK	Alex	24°C / 68%	16/Jun/2017

1.4 Measurement Uncertainty

ISO/IEC 17025 requires that an estimate of the measurement uncertainties associated with the emissions test results be included in the report. The measurement uncertainties given below are based on a 95% confidence level (based on a coverage factor (k=2))

Test Items	Uncertainty	Remark
Conducted Emission (150kHz ~ 30MHz)	3.6 dB	Confidence levels of 95%
Radiated Emission (30MHz ~ 1,000MHz)	2.1 dB	Confidence levels of 95%
Radiated Emission (1GHz ~ 18GHz)	2.6 dB	Confidence levels of 95%
Radiated Emission (18GHz ~ 40GHz)	2.9 dB	Confidence levels of 95%
Conducted Emission	1.3 dB	Confidence levels of 95%



2 Test Configuration of EUT

2.1 Test Condition

RF Conducted	Abbreviation	Remark
TnomVnom	Tnom	20°C
-	Vnom	5V

2.2 Test Channel Mode

Test Software Version	DoS
-----------------------	-----

Mode	Power Setting
802.11b_(1Mbps)_1TX	-
2412MHz	20
2437MHz	20
2462MHz	20
802.11g_(6Mbps)_1TX	-
2412MHz	20
2437MHz	20
2462MHz	20
802.11n HT20_Nss2,(MCS8)_2TX	-
2412MHz	20
2437MHz	20
2462MHz	20
802.11n HT40_Nss1,(MCS0)_1TX	-
2422MHz	20
2437MHz	20
2452MHz	20

2.3 The Worst Case Measurement Configuration

The Worst Case Mode for Following Conformance Tests	
Tests Item	AC power-line conducted emissions
Condition	AC power-line conducted measurement for line and neutral
Operating Mode	Normal Link
1	Cradle Mode

The Worst Case Mode for Following Conformance Tests	
Tests Item	DTS Bandwidth Maximum Conducted Output Power Power Spectral Density Emissions in Non-restricted Frequency Bands
Test Condition	Conducted measurement at transmit chains

The Worst Case Mode for Following Conformance Tests			
Tests Item	missions in Restricted Frequency Bands		
Test Condition	Radiated measurement If EUT consist of multiple antenna assembly (multiple antenna are used in EUT regardless of spatial multiplexing MIMO configuration), the radiated test should be performed with highest antenna gain of each antenna type.		
Operating Mode < 1GHz	CTX		
1	Cradle Mode		
Operating Mode > 1GHz	CTX		
Orthogonal Planes of EUT	XPlane	Y Plane	Z Plane
			
Worst Planes of EUT			V

2.4 Support Equipment

Support Equipment – RF Conducted				
No.	Equipment	Brand Name	Model Name	FCC ID
1	Notebook	DELL	E5410	DoC
2	Adapter for NB	DELL	HA65NM130	DoC

Support Equipment – Radiated Emission				
No.	Equipment	Brand Name	Model Name	FCC ID
1	Notebook	DELL	E5530	R33002
2	AC adapter for NB	DELL	LA65NS2-01	-
3	UBS cable	-	-	-

Note: Support equipment No.3 was provided by customer.

Support Equipment – AC Conduction				
No.	Equipment	Brand Name	Model Name	FCC ID
1	Notebook	Dell	Latitude E5540	DoC

2.5 Test Setup Diagram

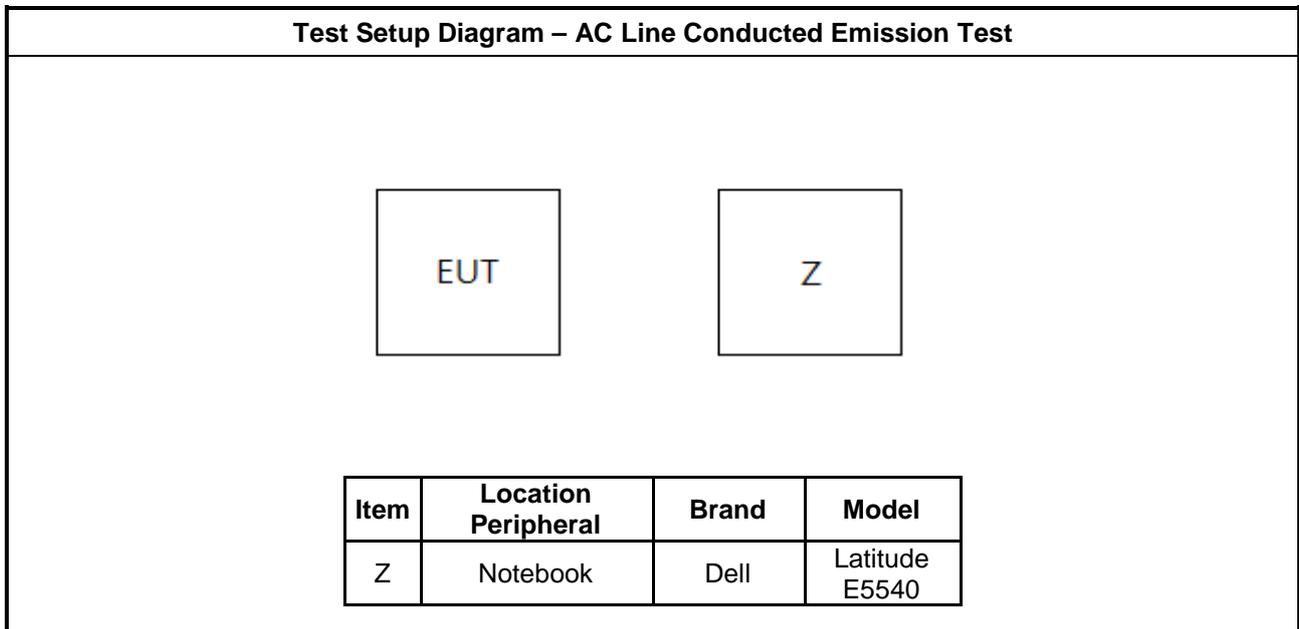

Test Setup Diagram - Radiated Test <1G

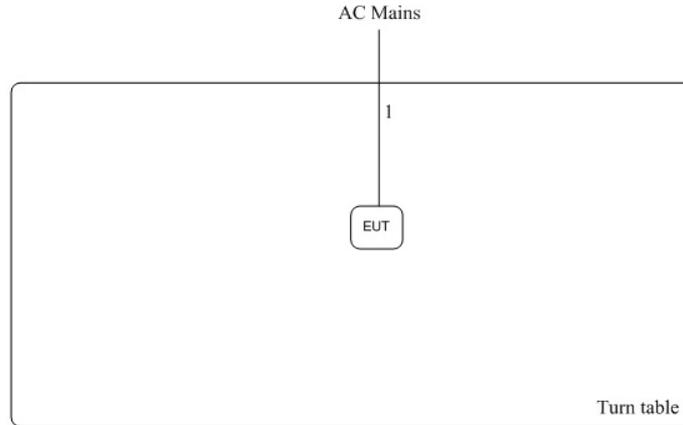

Item	Connection	Shielded	Length
1	AC Power line	No	2.5m

Test Setup Diagram - Radiated Test >1G

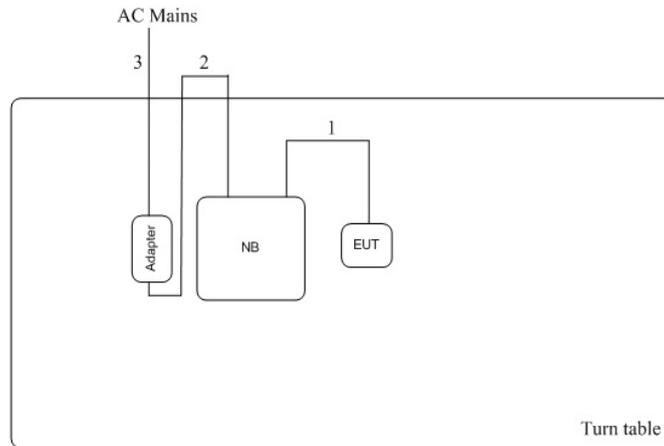

Item	Connection	Shielded	Length
1	USB cable	No	1m
2	DC Power line	No	1.8m
3	AC Power line	No	1.8m

3 Transmitter Test Result

3.1 AC Power-line Conducted Emissions

3.1.1 AC Power-line Conducted Emissions Limit

AC Power-line Conducted Emissions Limit		
Frequency Emission (MHz)	Quasi-Peak	Average
0.15-0.5	66 - 56 *	56 - 46 *
0.5-5	56	46
5-30	60	50

Note 1: * Decreases with the logarithm of the frequency.

3.1.2 Measuring Instruments

Refer a test equipment and calibration data table in this test report.

3.1.3 Test Procedures

Test Method
<input checked="" type="checkbox"/> Refer as ANSI C63.10-2013, clause 6.2 for AC power-line conducted emissions.

3.1.4 Test Setup

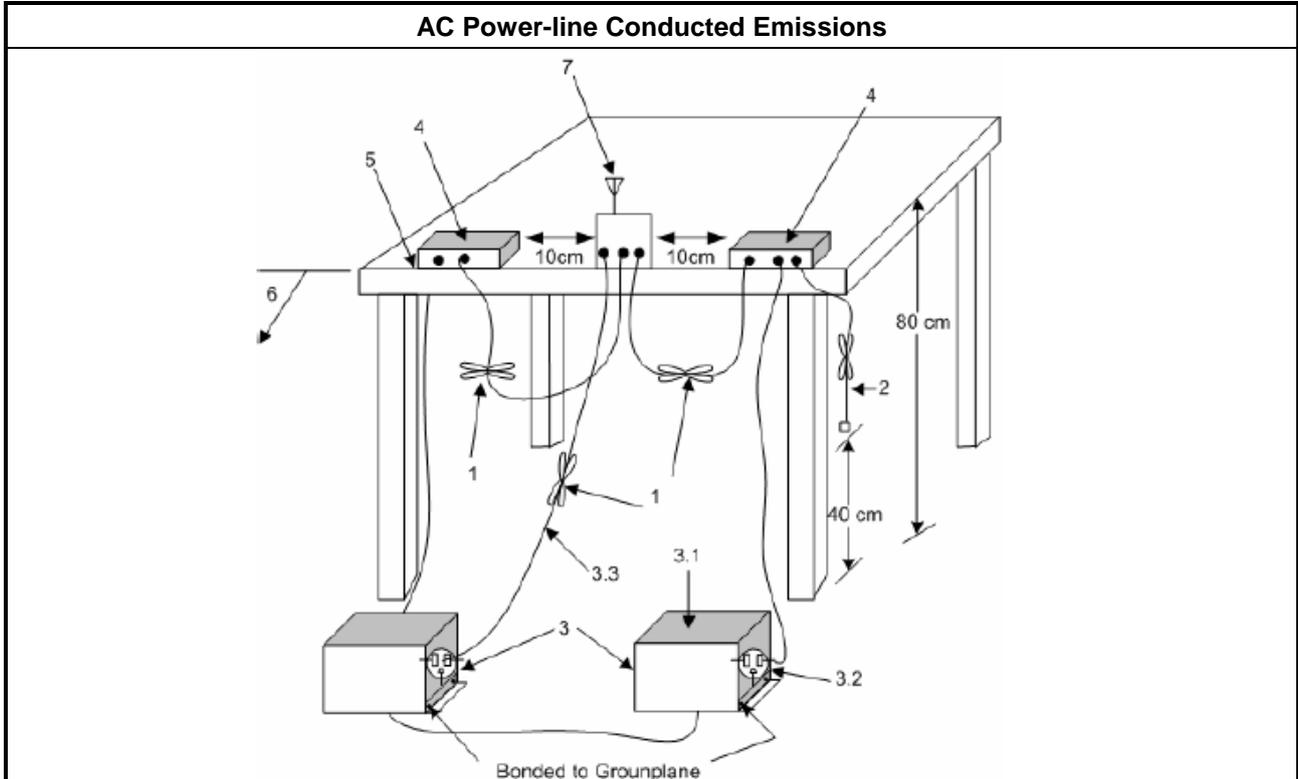

3.1.5 Test Result of AC Power-line Conducted Emissions

Refer as Appendix A

3.2 DTS Bandwidth

3.2.1 6dB Bandwidth Limit

6dB Bandwidth Limit
Systems using digital modulation techniques:
<ul style="list-style-type: none"> ▪ 6 dB bandwidth \geq 500 kHz.

3.2.2 Measuring Instruments

Refer a test equipment and calibration data table in this test report.

3.2.3 Test Procedures

Test Method
<ul style="list-style-type: none"> ▪ For the emission bandwidth shall be measured using one of the options below:
<input checked="" type="checkbox"/> Refer as KDB 558074, clause 8.1 Option 1 for 6 dB bandwidth measurement.
<input type="checkbox"/> Refer as KDB 558074, clause 8.2 Option 2 for 6 dB bandwidth measurement.
<input type="checkbox"/> Refer as ANSI C63.10, clause 6.9.3 for occupied bandwidth testing.

3.2.4 Test Setup

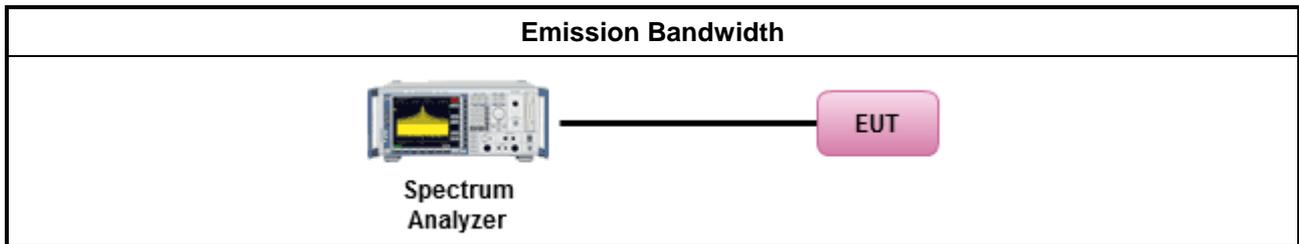

3.2.5 Test Result of Emission Bandwidth

Refer as Appendix B

3.3 Maximum Conducted Output Power

3.3.1 Maximum Conducted Output Power Limit

Maximum Conducted Output Power Limit	
	<ul style="list-style-type: none"> ▪ If $G_{TX} \leq 6$ dBi, then $P_{Out} \leq 30$ dBm (1 W)
	<ul style="list-style-type: none"> ▪ Point-to-multipoint systems (P2M): If $G_{TX} > 6$ dBi, then $P_{Out} = 30 - (G_{TX} - 6)$ dBm
	<ul style="list-style-type: none"> ▪ Point-to-point systems (P2P): If $G_{TX} > 6$ dBi, then $P_{Out} = 30 - (G_{TX} - 6)/3$ dBm
	<ul style="list-style-type: none"> ▪ Smart antenna system (SAS):
	<ul style="list-style-type: none"> - Single beam: If $G_{TX} > 6$ dBi, then $P_{Out} = 30 - (G_{TX} - 6)/3$ dBm
	<ul style="list-style-type: none"> - Overlap beam: If $G_{TX} > 6$ dBi, then $P_{Out} = 30 - (G_{TX} - 6)/3$ dBm
	<ul style="list-style-type: none"> - Aggregate power on all beams: If $G_{TX} > 6$ dBi, then $P_{Out} = 30 - (G_{TX} - 6)/3 + 8$ dBm
e.i.r.p. Power Limit:	
	<ul style="list-style-type: none"> ▪ 2400-2483.5 MHz Band
	<ul style="list-style-type: none"> ▪ Point-to-multipoint systems (P2M): $P_{eirp} \leq 36$ dBm (4 W)
	<ul style="list-style-type: none"> ▪ Point-to-point systems (P2P): $P_{eirp} \leq \text{MAX}(36, [P_{Out} + G_{TX}])$ dBm
	<ul style="list-style-type: none"> ▪ Smart antenna system (SAS)
	<ul style="list-style-type: none"> - Single beam: $P_{eirp} \leq \text{MAX}(36, P_{Out} + G_{TX})$ dBm
	<ul style="list-style-type: none"> - Overlap beam: $P_{eirp} \leq \text{MAX}(36, P_{Out} + G_{TX})$ dBm
	<ul style="list-style-type: none"> - Aggregate power on all beams: $P_{eirp} \leq \text{MAX}(36, [P_{Out} + G_{TX} + 8])$ dBm
<p>P_{Out} = maximum peak conducted output power or maximum conducted output power in dBm, G_{TX} = the maximum transmitting antenna directional gain in dBi.</p>	

3.3.2 Measuring Instruments

Refer a test equipment and calibration data table in this test report.

3.3.3 Test Procedures

Test Method	
<ul style="list-style-type: none"> ▪ Maximum Peak Conducted Output Power 	
<input type="checkbox"/>	Refer as KDB 558074, clause 9.1.1 Option 1 (RBW ≥ EBW method).
<input type="checkbox"/>	Refer as KDB 558074, clause 9.1.2 Option 2 (integrated band power method)
<input type="checkbox"/>	Refer as KDB 558074, clause 9.1.3 Option 3 (peak power meter for VBW ≥ DTS BW)
<ul style="list-style-type: none"> ▪ Maximum Average Conducted Output Power 	
Duty cycle ≥ 98%	
<input type="checkbox"/>	Refer as KDB 558074, clause 9.2.2.4 Method AVGSA-2 (spectral trace averaging).
Duty cycle < 98%	
<input type="checkbox"/>	Refer as KDB 558074, clause 9.2.2.5 Method AVGSA-2 Alt. (slow sweep speed)
RF power meter and average over on/off periods with duty factor or gated trigger	
<input checked="" type="checkbox"/>	Refer as KDB 558074, clause 9.2.3.1 Method AVGPM (using an RF average power meter).
<ul style="list-style-type: none"> ▪ For conducted measurement. 	
<ul style="list-style-type: none"> ▪ If the EUT supports multiple transmit chains using options given below: Refer as KDB 662911, In-band power measurements. Using the measure-and-sum approach, measured all transmit ports individually. Sum the power (in linear power units e.g., mW) of all ports for each individual sample and save them. 	
<ul style="list-style-type: none"> ▪ If multiple transmit chains, EIRP calculation could be following as methods: $P_{total} = P_1 + P_2 + \dots + P_n$ (calculated in linear unit [mW] and transfer to log unit [dBm]) $EIRP_{total} = P_{total} + DG$ 	

3.3.4 Test Setup

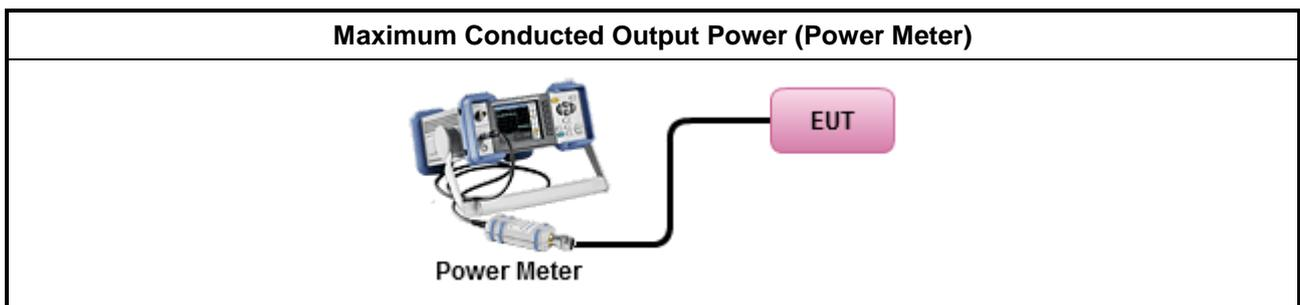

3.3.5 Test Result of Maximum Conducted Output Power

Refer as Appendix C

3.4 Power Spectral Density

3.4.1 Power Spectral Density Limit

Power Spectral Density Limit
<ul style="list-style-type: none"> Power Spectral Density (PSD) \leq 8 dBm/3kHz

3.4.2 Measuring Instruments

Refer a test equipment and calibration data table in this test report.

3.4.3 Test Procedures

Test Method	
<ul style="list-style-type: none"> Peak power spectral density procedures that the same method as used to determine the conducted output power. If maximum peak conducted output power was measured to demonstrate compliance to the output power limit, then the peak PSD procedure below (Method PKPSD) shall be used. If maximum conducted output power was measured to demonstrate compliance to the output power limit, then one of the average PSD procedures shall be used, as applicable based on the following criteria (the peak PSD procedure is also an acceptable option). 	
<input checked="" type="checkbox"/>	Refer as KDB 558074, clause 10.2 Method PKPSD (RBW=3-100kHz; Detector=peak).
<ul style="list-style-type: none"> For conducted measurement. 	
<ul style="list-style-type: none"> If The EUT supports multiple transmit chains using options given below: 	
<input checked="" type="checkbox"/>	Measure and sum the spectra across the outputs. Refer as KDB 662911, In-band power spectral density (PSD). Sample all transmit ports simultaneously using a spectrum analyzer for each transmit port. Where the trace bin-by-bin of each transmit port summing can be performed. (i.e., in the first spectral bin of output 1 is summed with that in the first spectral bin of output 2 and that from the first spectral bin of output 3, and so on up to the NTX output to obtain the value for the first frequency bin of the summed spectrum.). Add up the amplitude (power) values for the different transmit chains and use this as the new data trace.

3.4.4 Test Setup

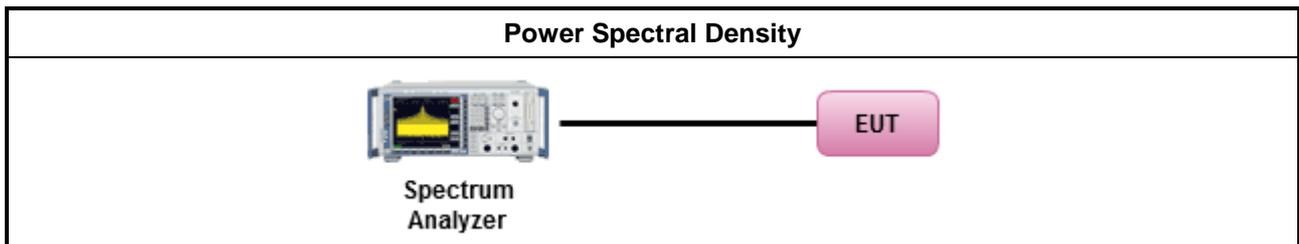

3.4.5 Test Result of Power Spectral Density

Refer as Appendix D

3.5 Emissions in Non-restricted Frequency Bands

3.5.1 Emissions in Non-restricted Frequency Bands Limit

Un-restricted Band Emissions Limit	
RF output power procedure	Limit (dB)
Peak output power procedure	20
Average output power procedure	30

Note 1: If the peak output power procedure is used to measure the fundamental emission power to demonstrate compliance to requirements, then the peak conducted output power measured within any 100 kHz outside the authorized frequency band shall be attenuated by at least 20 dB relative to the maximum measured in-band peak PSD level.

Note 2: If the average output power procedure is used to measure the fundamental emission power to demonstrate compliance to requirements, then the power in any 100 kHz outside of the authorized frequency band shall be attenuated by at least 30 dB relative to the maximum measured in-band average PSD level.

3.5.2 Measuring Instruments

Refer a test equipment and calibration data table in this test report.

3.5.3 Test Procedures

Test Method
<ul style="list-style-type: none"> Refer as KDB 558074, clause 11 for unwanted emissions into non-restricted bands.

3.5.4 Test Setup

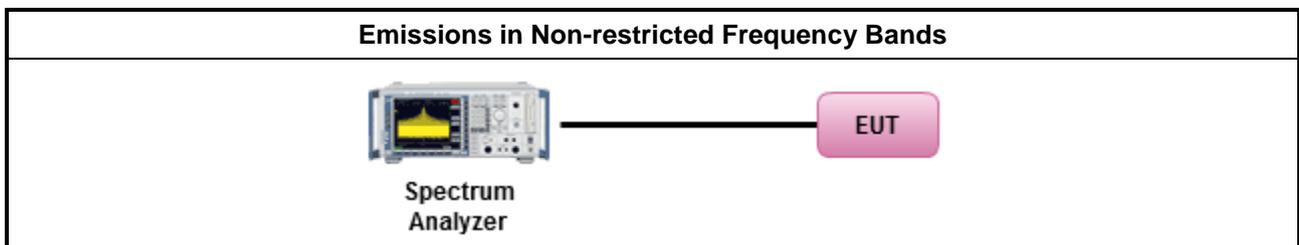

3.5.5 Test Result of Emissions in Non-restricted Frequency Bands

Refer as Appendix E



3.6 Emissions in Restricted Frequency Bands

3.6.1 Emissions in Restricted Frequency Bands Limit

Restricted Band Emissions Limit			
Frequency Range (MHz)	Field Strength (uV/m)	Field Strength (dBuV/m)	Measure Distance (m)
0.009~0.490	2400/F(kHz)	48.5 - 13.8	300
0.490~1.705	24000/F(kHz)	33.8 - 23	30
1.705~30.0	30	29	30
30~88	100	40	3
88~216	150	43.5	3
216~960	200	46	3
Above 960	500	54	3

Note 1: Test distance for frequencies at or above 30 MHz, measurements may be performed at a distance other than the limit distance provided they are not performed in the near field and the emissions to be measured can be detected by the measurement equipment. When performing measurements at a distance other than that specified, the results shall be extrapolated to the specified distance using an extrapolation factor of 20 dB/decade (inverse of linear distance for field-strength measurements, inverse of linear distance-squared for power-density measurements).

Note 2: Test distance for frequencies at below 30 MHz, measurements may be performed at a distance closer than the EUT limit distance; however, an attempt should be made to avoid making measurements in the near field. When performing measurements below 30 MHz at a closer distance than the limit distance, the results shall be extrapolated to the specified distance by either making measurements at a minimum of two or more distances on at least one radial to determine the proper extrapolation factor or by using the square of an inverse linear distance extrapolation factor (40 dB/decade). The test report shall specify the extrapolation method used to determine compliance of the EUT.

3.6.2 Measuring Instruments

Refer a test equipment and calibration data table in this test report.

3.6.3 Test Procedures

Test Method	
<ul style="list-style-type: none"> ▪ The average emission levels shall be measured in [duty cycle \geq 98 or duty factor]. 	
<ul style="list-style-type: none"> ▪ Refer as ANSI C63.10, clause 6.10.3 band-edge testing shall be performed at the lowest frequency channel and highest frequency channel within the allowed operating band. 	
<ul style="list-style-type: none"> ▪ For the transmitter unwanted emissions shall be measured using following options below: 	
<ul style="list-style-type: none"> ▪ Refer as KDB 558074, clause 12 for unwanted emissions into restricted bands. 	
	<ul style="list-style-type: none"> <input checked="" type="checkbox"/> Refer as KDB 558074, clause 12.2.5.3 (ANSI C63.10, clause 4.1.4.2.3), Reduced VBW\geq1/T.
	<ul style="list-style-type: none"> <input checked="" type="checkbox"/> Refer as KDB 558074, clause 12.2.4 measurement procedure peak limit.
<ul style="list-style-type: none"> ▪ For the transmitter band-edge emissions shall be measured using following options below: 	
<ul style="list-style-type: none"> ▪ Refer as KDB 558074 clause 13.1, When the performing peak or average radiated measurements, emissions within 2 MHz of the authorized band edge may be measured using the marker-delta method described below. 	
<ul style="list-style-type: none"> ▪ Refer as KDB 558074, clause 13.2 (ANSI C63.10, clause 6.10.6) for marker-delta method for band-edge measurements. 	
<ul style="list-style-type: none"> ▪ Refer as KDB 558074, clause 13.3 for narrower resolution bandwidth (100kHz) using the band power and summing the spectral levels (i.e., 1 MHz). 	
<ul style="list-style-type: none"> ▪ For conducted and cabinet radiation measurement, refer as KDB 558074, clause 12.2.2. 	
<ul style="list-style-type: none"> ▪ For conducted unwanted emissions into restricted bands (absolute emission limits). Devices with multiple transmit chains using options given below: (1) Measure and sum the spectra across the outputs or (2) Measure and add 10 log(N) dB 	
<ul style="list-style-type: none"> ▪ For KDB 662911 The methodology described here may overestimate array gain, thereby resulting in apparent failures to satisfy the out-of-band limits even if the device is actually compliant. In such cases, compliance may be demonstrated by performing radiated tests around the frequencies at which the apparent failures occurred. 	

3.6.4 Test Setup

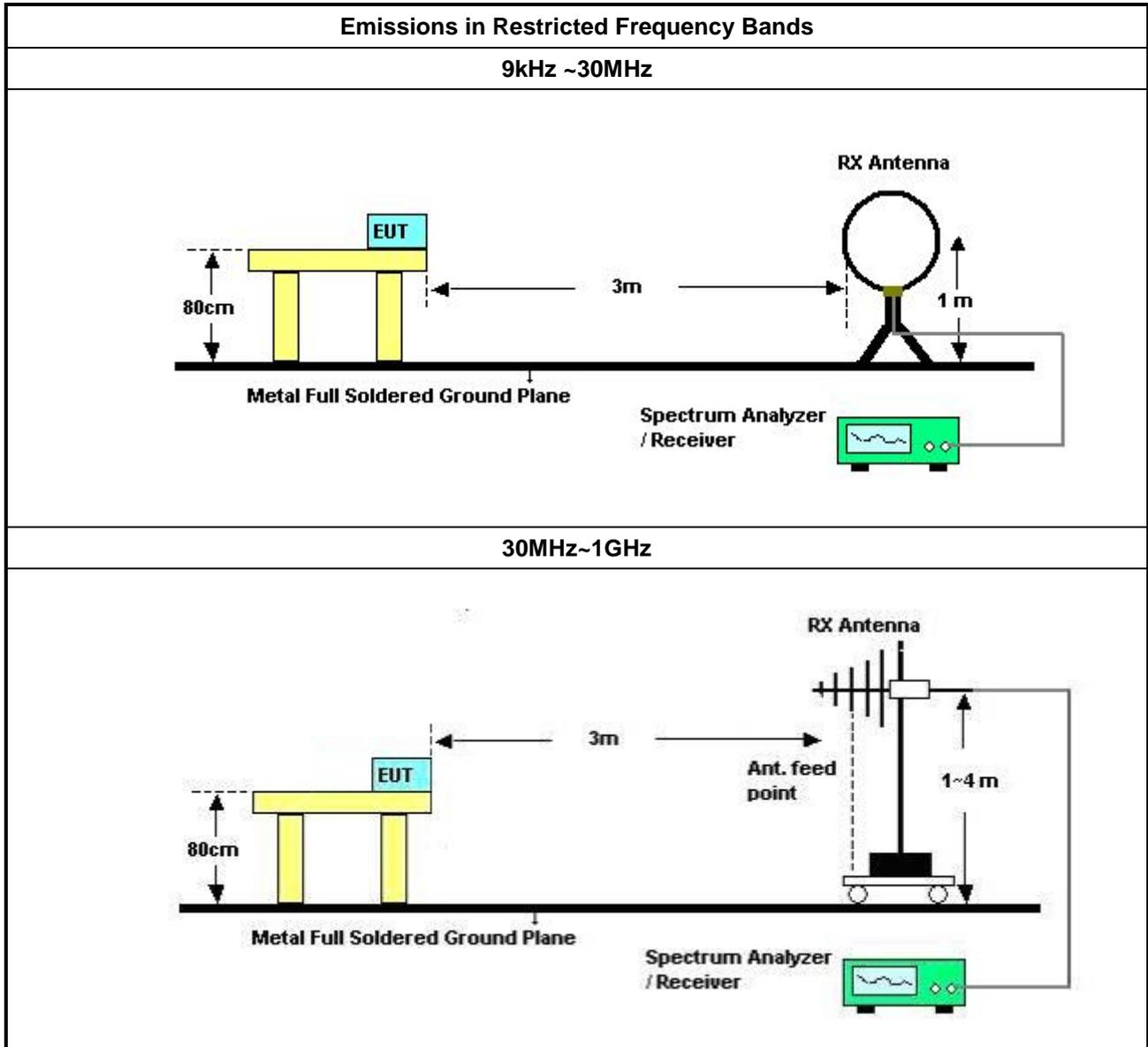

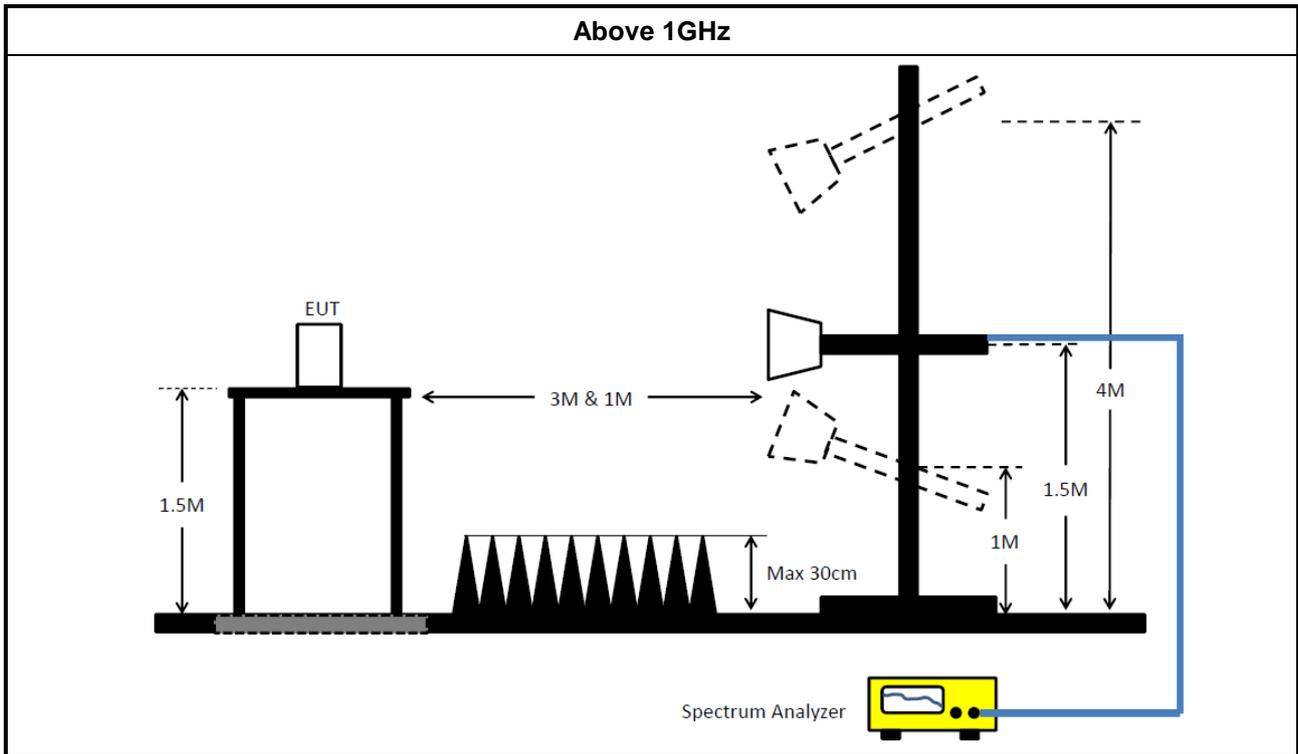

3.6.5 Test Result of Emissions in Restricted Frequency Bands (Below 30MHz)

The amplitude of spurious emissions which are attenuated by more than 20dB below the permissible value has no need to be reported. All amplitude of spurious emissions that are attenuated by more than 20 dB below the permissible value has no need to be reported.

3.6.6 Test Result of Emissions in Restricted Frequency Bands

Refer as Appendix F

4 Test Equipment and Calibration Data

Instrument for AC Conduction

Instrument	Manufacturer	Model No.	Serial No.	Spec.	Calibration Date	Calibration Due Date
Test Receiver	R&S	ESR3	102052	9 KHz ~ 3.6 GHz	05/Apr/2017	04/Apr/2018
Two-Line V-Network	R&S	ENV 216	100003	9 kHz ~ 30 MHz	30/Aug/2016	29/Aug/2017
RF Cable-CON	Weiyang	WY200	CB018	9 kHz ~ 30 MHz	07/Feb/2017	06/Feb/2018
Impul sbegrenzer Pulse Limiter	R&S	ESH3-Z2	100921	10 kHz ~ 30 MHz	20/Oct/2016	19/Oct/2017

Instrument for Radiated Test

Instrument	Manufacturer	Model No.	Serial No.	Spec.	Calibration Date	Calibration Due Date
3m Semi Anechoic Chamber	SIDT FRANKONIA	SAC-3M	03CH01-HY	30 MHz ~ 1 GHz	15/Mar/2017	14/Mar/2017
3m Semi Anechoic Chamber	TDK	SAC-3M	03CH01-HY	1GHz ~18 GHz 3m	15/Mar/2017	15/Mar/2018
Amplifier	COM-POWER	PA-103	161050	1 MHz ~ 1 GHz	11/Jul/2016	10/Jul/2017
Amplifier	Agilent	8449B	3008A02326	1GHz ~ 26.5GHz	12/Jul/2016	11/Jul/2017
Spectrum	R&S	FSV40	100593	9kHz ~ 40GHz	26/Oct/2016	25/Oct/2017
Bilog Antenna with 5dB Attenuator	SCHAFFNER& MTJ	CBL6112D & MTJ6102-05	2678&001	30 MHz ~ 2 GHz	30/Jul/2016	29/Jul/2017
Horn Antenna	SCHWARZBECK	BBHA 9120	BBHA9120D11 30	1GHz ~ 18GHz	07/Oct/2016	06/Oct/2017
Horn Antenna	SCHWARZBECK	BBHA 9170	BBHA9170339	18GHz ~ 40GHz	10/Apr/2017	09/Apr/2018
Loop Antenna	TESEQ	HLA 6120	24155	9 kHz~30 MHz	02/Mar/2017	01/Mar/2018
RF Cable-HIGH	SUHNER	SUCOFLEX 106	CB068-HF	26GHz ~ 40GHz	16/Sep/2016	15/Sep/2017
RF Cable-HIGH	SUHNER	SUCOFLEX 106	CB069-HF	1GHz ~ 26GHz	05/Nov/2016	04/Nov/2017
RF Cable-R03m	Jye Bao	RG142	CB019	9kHz ~ 1GHz	03/Jan/2017	02/Jan/2018

Instrument for Conducted Test

Instrument	Manufacturer	Model No.	Serial No.	Spec.	Calibration Date	Calibration Due Date
Spectrum Analyzer	R&S	FSV 40	101013	10Hz~40GHz	30/Dec/2016	29/Dec/2017
Power Sensor	Anritsu	MA2411B	1027452	300MHz~40GHz	24/Feb/2017	23/Feb/2018
Power Meter	Anritsu	ML2495A	1124009	300MHz~40GHz	24/Feb/2017	23/Feb/2018
Signal Generator	R&S	SMR40	100116	10MHz~40GHz	21/Jul/2016	20/Jul/2017
RF Cable-0.2m	HUBER+SUHNER	SUCOFLEX_104	MY677/3	30MHz~26.5GHz	02/Oct/2016	01/Oct/2017
RF Cable-0.2m	HUBER+SUHNER	SUCOFLEX_104	MY678/3	30MHz~26.5GHz	02/Oct/2016	01/Oct/2017
RF Cable-0.5m	HUBER+SUHNER	SUCOFLEX_104	MY10717/4	30MHz~26.5GHz	02/Oct/2016	01/Oct/2017



AC Power-line Conducted Emissions Result																																																																																																																																	
Operating Mode	1	Power Phase	Neutral																																																																																																																														
Operating Function	Cradle Mode																																																																																																																																
<div style="display: flex; justify-content: space-between;"> Level (dBuV) Date: 2017-06-16 </div>																																																																																																																																	
<table border="1" style="width:100%; border-collapse: collapse; margin-top: 10px;"> <thead> <tr> <th></th> <th>Freq</th> <th>Level</th> <th>Over Limit</th> <th>Limit Line</th> <th>Read Level</th> <th>LISN Factor</th> <th>Cable Loss</th> <th>Remark</th> </tr> <tr> <th></th> <th>MHz</th> <th>dBuV</th> <th>dB</th> <th>dBuV</th> <th>dBuV</th> <th>dB</th> <th>dB</th> <th></th> </tr> </thead> <tbody> <tr><td>1 @</td><td>0.150</td><td>50.39</td><td>-15.61</td><td>66.00</td><td>40.69</td><td>9.67</td><td>0.03</td><td>QP</td></tr> <tr><td>2</td><td>0.150</td><td>36.90</td><td>-19.10</td><td>56.00</td><td>27.20</td><td>9.67</td><td>0.03</td><td>Average</td></tr> <tr><td>3 @</td><td>0.167</td><td>48.51</td><td>-16.60</td><td>65.11</td><td>38.82</td><td>9.66</td><td>0.03</td><td>QP</td></tr> <tr><td>4</td><td>0.167</td><td>35.69</td><td>-19.42</td><td>55.11</td><td>26.00</td><td>9.66</td><td>0.03</td><td>Average</td></tr> <tr><td>5</td><td>0.203</td><td>43.35</td><td>-20.14</td><td>63.49</td><td>33.68</td><td>9.64</td><td>0.03</td><td>QP</td></tr> <tr><td>6</td><td>0.203</td><td>32.02</td><td>-21.47</td><td>53.49</td><td>22.35</td><td>9.64</td><td>0.03</td><td>Average</td></tr> <tr><td>7</td><td>0.535</td><td>31.91</td><td>-24.09</td><td>56.00</td><td>22.15</td><td>9.72</td><td>0.04</td><td>QP</td></tr> <tr><td>8</td><td>0.535</td><td>26.72</td><td>-19.28</td><td>46.00</td><td>16.96</td><td>9.72</td><td>0.04</td><td>Average</td></tr> <tr><td>9</td><td>3.044</td><td>27.47</td><td>-28.53</td><td>56.00</td><td>17.59</td><td>9.70</td><td>0.18</td><td>QP</td></tr> <tr><td>10</td><td>3.044</td><td>22.06</td><td>-23.94</td><td>46.00</td><td>12.18</td><td>9.70</td><td>0.18</td><td>Average</td></tr> <tr><td>11</td><td>10.070</td><td>23.86</td><td>-36.14</td><td>60.00</td><td>13.71</td><td>9.85</td><td>0.30</td><td>QP</td></tr> <tr><td>12</td><td>10.070</td><td>18.63</td><td>-31.37</td><td>50.00</td><td>8.48</td><td>9.85</td><td>0.30</td><td>Average</td></tr> </tbody> </table>					Freq	Level	Over Limit	Limit Line	Read Level	LISN Factor	Cable Loss	Remark		MHz	dBuV	dB	dBuV	dBuV	dB	dB		1 @	0.150	50.39	-15.61	66.00	40.69	9.67	0.03	QP	2	0.150	36.90	-19.10	56.00	27.20	9.67	0.03	Average	3 @	0.167	48.51	-16.60	65.11	38.82	9.66	0.03	QP	4	0.167	35.69	-19.42	55.11	26.00	9.66	0.03	Average	5	0.203	43.35	-20.14	63.49	33.68	9.64	0.03	QP	6	0.203	32.02	-21.47	53.49	22.35	9.64	0.03	Average	7	0.535	31.91	-24.09	56.00	22.15	9.72	0.04	QP	8	0.535	26.72	-19.28	46.00	16.96	9.72	0.04	Average	9	3.044	27.47	-28.53	56.00	17.59	9.70	0.18	QP	10	3.044	22.06	-23.94	46.00	12.18	9.70	0.18	Average	11	10.070	23.86	-36.14	60.00	13.71	9.85	0.30	QP	12	10.070	18.63	-31.37	50.00	8.48	9.85	0.30	Average
	Freq	Level	Over Limit	Limit Line	Read Level	LISN Factor	Cable Loss	Remark																																																																																																																									
	MHz	dBuV	dB	dBuV	dBuV	dB	dB																																																																																																																										
1 @	0.150	50.39	-15.61	66.00	40.69	9.67	0.03	QP																																																																																																																									
2	0.150	36.90	-19.10	56.00	27.20	9.67	0.03	Average																																																																																																																									
3 @	0.167	48.51	-16.60	65.11	38.82	9.66	0.03	QP																																																																																																																									
4	0.167	35.69	-19.42	55.11	26.00	9.66	0.03	Average																																																																																																																									
5	0.203	43.35	-20.14	63.49	33.68	9.64	0.03	QP																																																																																																																									
6	0.203	32.02	-21.47	53.49	22.35	9.64	0.03	Average																																																																																																																									
7	0.535	31.91	-24.09	56.00	22.15	9.72	0.04	QP																																																																																																																									
8	0.535	26.72	-19.28	46.00	16.96	9.72	0.04	Average																																																																																																																									
9	3.044	27.47	-28.53	56.00	17.59	9.70	0.18	QP																																																																																																																									
10	3.044	22.06	-23.94	46.00	12.18	9.70	0.18	Average																																																																																																																									
11	10.070	23.86	-36.14	60.00	13.71	9.85	0.30	QP																																																																																																																									
12	10.070	18.63	-31.37	50.00	8.48	9.85	0.30	Average																																																																																																																									
<p>Note 1: ">20dB" means emission levels that exceed the level of 20 dB below the applicable limit. Note 2: "N/F" means Nothing Found emissions (No emissions were detected.)</p>																																																																																																																																	

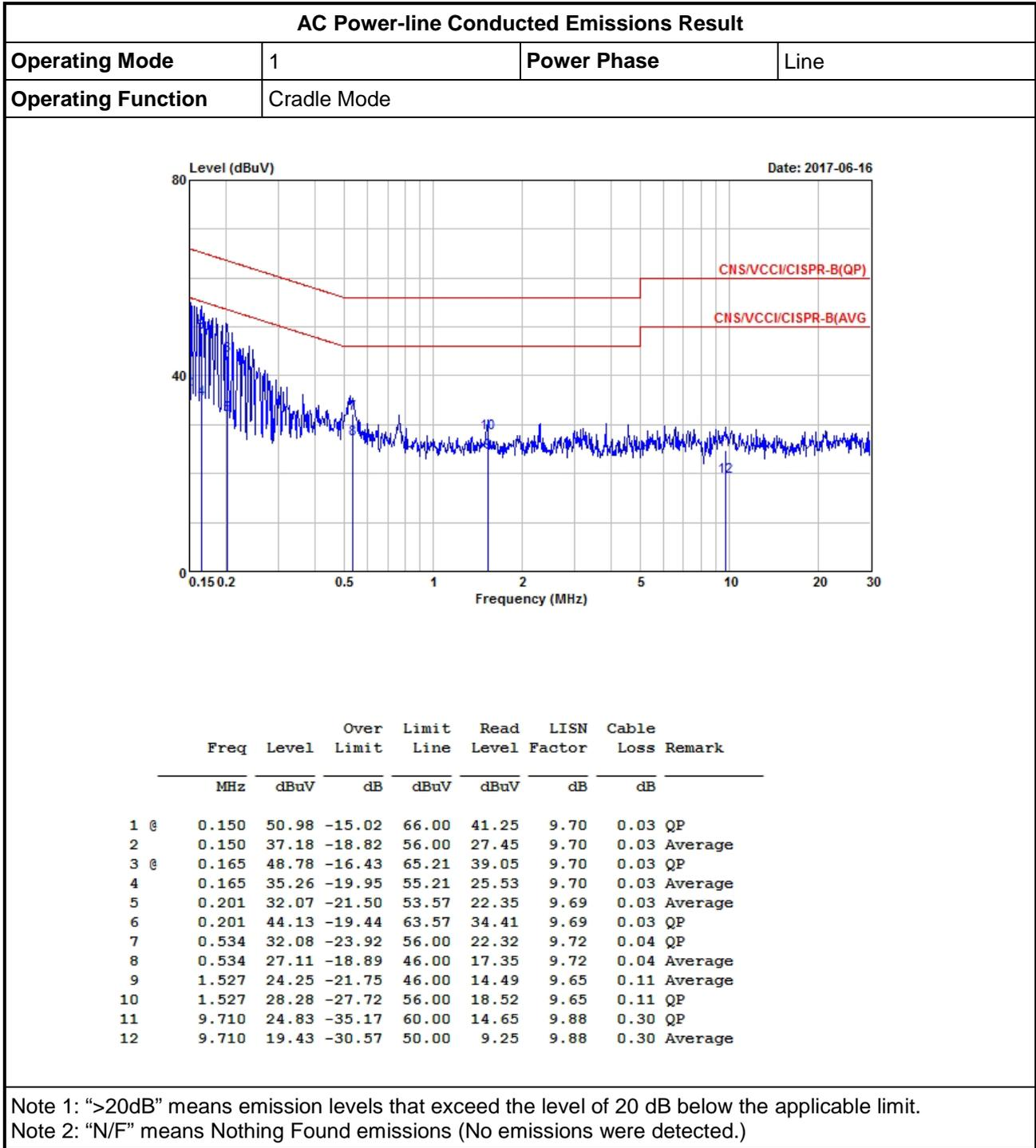



Summary

Mode	Max-N dB (Hz)	Max-OBW (Hz)	ITU-Code	Min-N dB (Hz)	Min-OBW (Hz)
802.11b_(1Mbps)_1TX	-	-	-	-	-
2.4-2.4835GHz	10.025M	14.568M	14M6G1D	10M	14.468M
802.11g_(6Mbps)_1TX	-	-	-	-	-
2.4-2.4835GHz	14.85M	16.317M	16M3D1D	13.975M	16.242M
802.11n HT20_Nss2,(MCS8)_2TX	-	-	-	-	-
2.4-2.4835GHz	15.025M	17.516M	17M5D1D	12.8M	17.366M
802.11n HT40_Nss1,(MCS0)_1TX	-	-	-	-	-
2.4-2.4835GHz	33.75M	35.882M	35M9D1D	32.5M	35.632M

Max-N dB = Maximum 6dB down bandwidth; **Max-OBW** = Maximum 99% occupied bandwidth;
Min-N dB = Minimum 6dB down bandwidth; **Min-OBW** = Minimum 99% occupied bandwidth;

Result

Mode	Result	Limit (Hz)	Port 1-N dB (Hz)	Port 1-OBW (Hz)	Port 2-N dB (Hz)	Port 2-OBW (Hz)
802.11b_(1Mbps)_1TX	-	-	-	-	-	-
2412MHz_TnomVnom	Pass	500k	10.025M	14.543M	-	-
2437MHz_TnomVnom	Pass	500k	10M	14.468M	-	-
2462MHz_TnomVnom	Pass	500k	10M	14.568M	-	-
802.11g_(6Mbps)_1TX	-	-	-	-	-	-
2412MHz_TnomVnom	Pass	500k	13.975M	16.242M	-	-
2437MHz_TnomVnom	Pass	500k	14.625M	16.317M	-	-
2462MHz_TnomVnom	Pass	500k	14.85M	16.267M	-	-
802.11n HT20_Nss2,(MCS8)_2TX	-	-	-	-	-	-
2412MHz_TnomVnom	Pass	500k	13.75M	17.366M	12.8M	17.441M
2437MHz_TnomVnom	Pass	500k	14.975M	17.491M	15.025M	17.516M
2462MHz_TnomVnom	Pass	500k	14.45M	17.416M	14.925M	17.441M
802.11n HT40_Nss1,(MCS0)_1TX	-	-	-	-	-	-
2422MHz_TnomVnom	Pass	500k	32.5M	35.632M	-	-
2437MHz_TnomVnom	Pass	500k	32.5M	35.882M	-	-
2452MHz_TnomVnom	Pass	500k	33.75M	35.632M	-	-

Port X-N dB = Port X 6dB down bandwidth; **Port X-OBW** = Port X 99% occupied bandwidth;

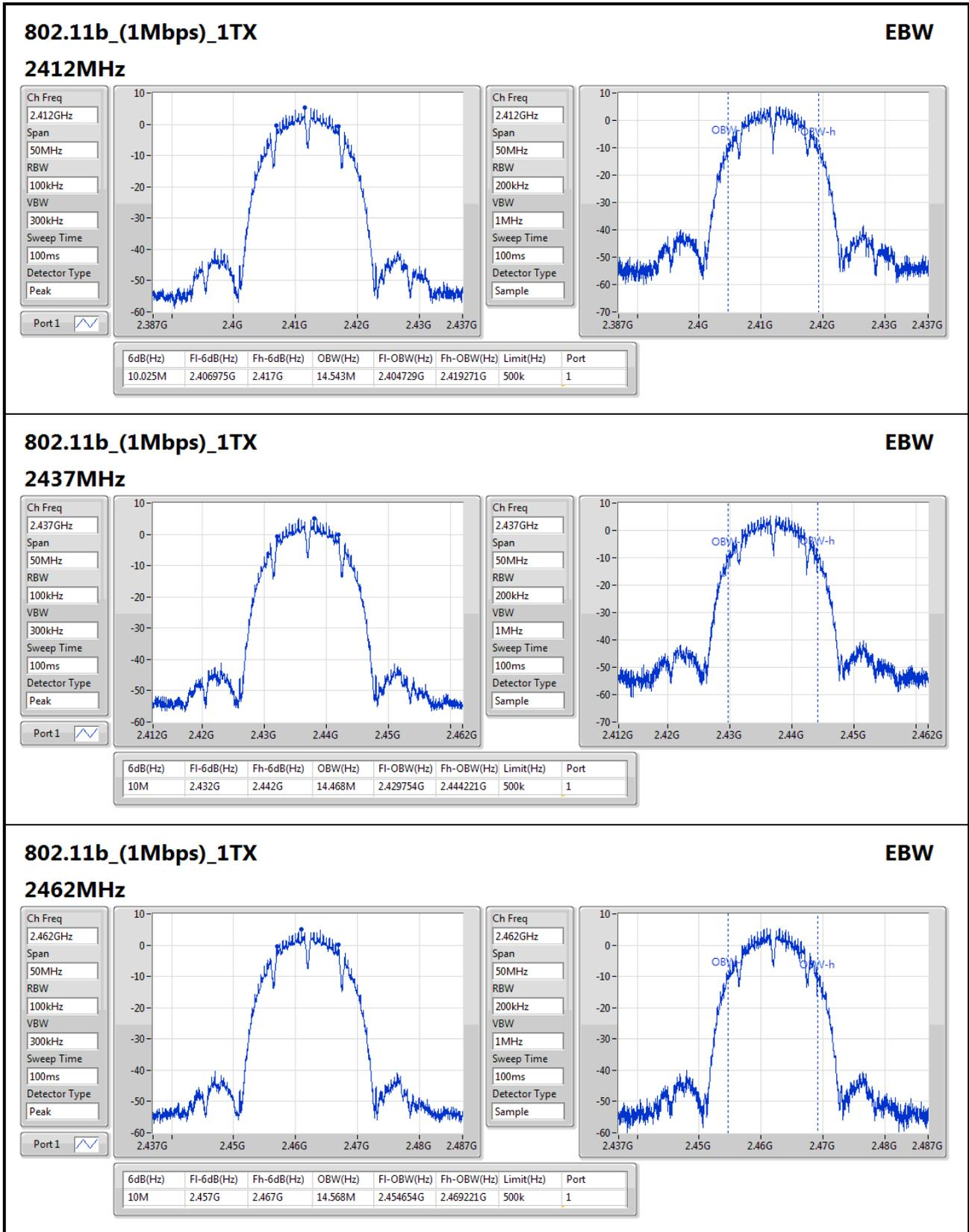

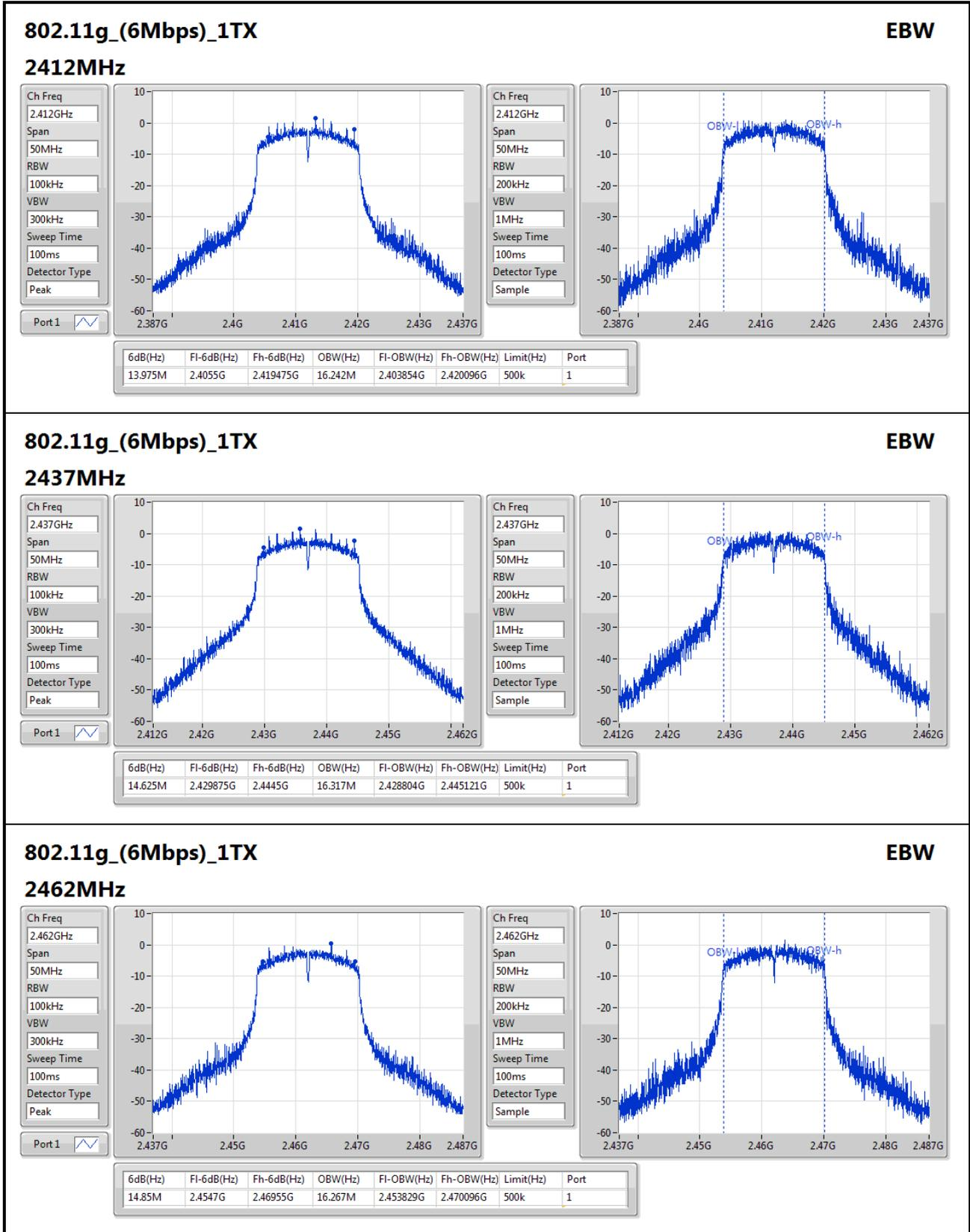

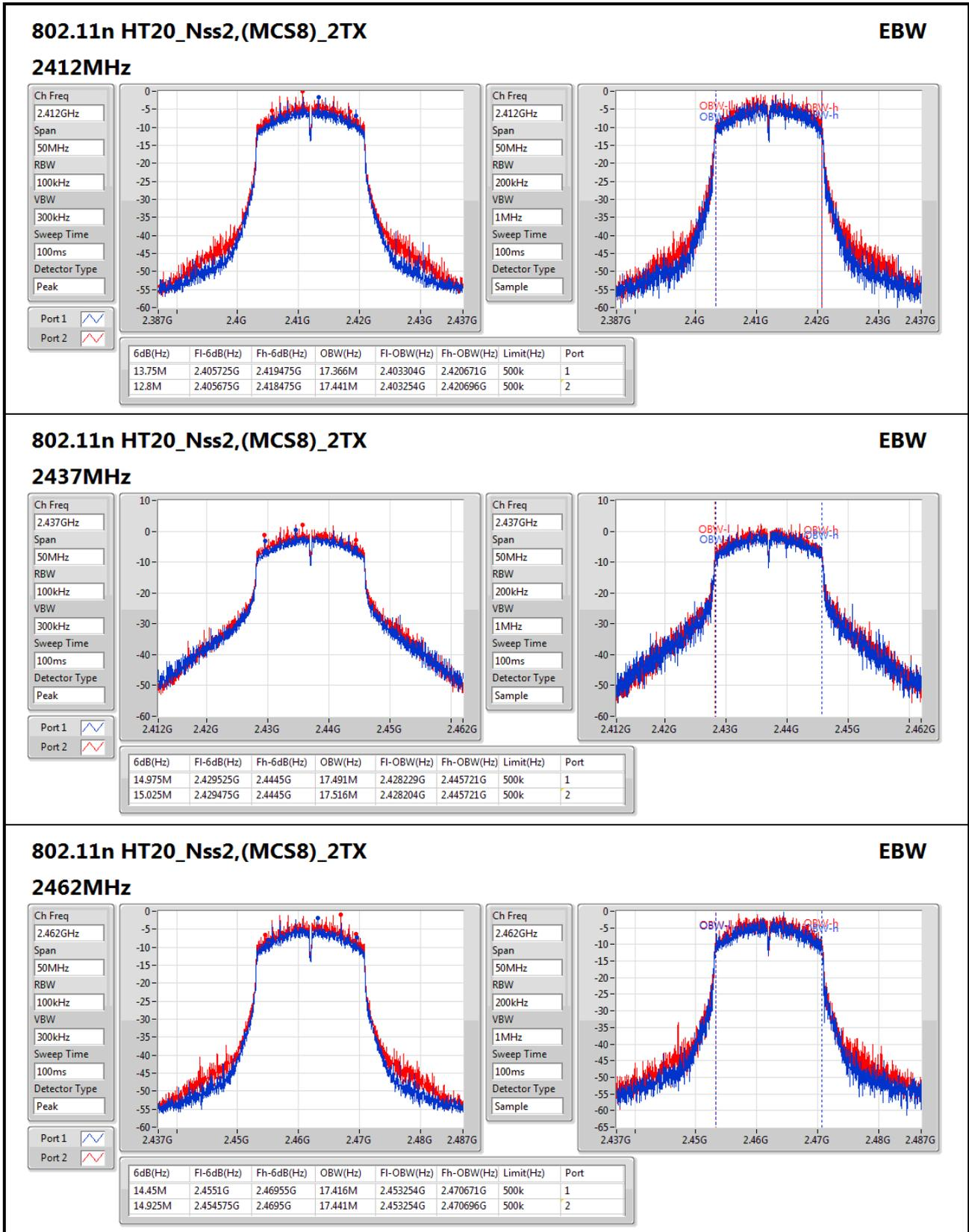

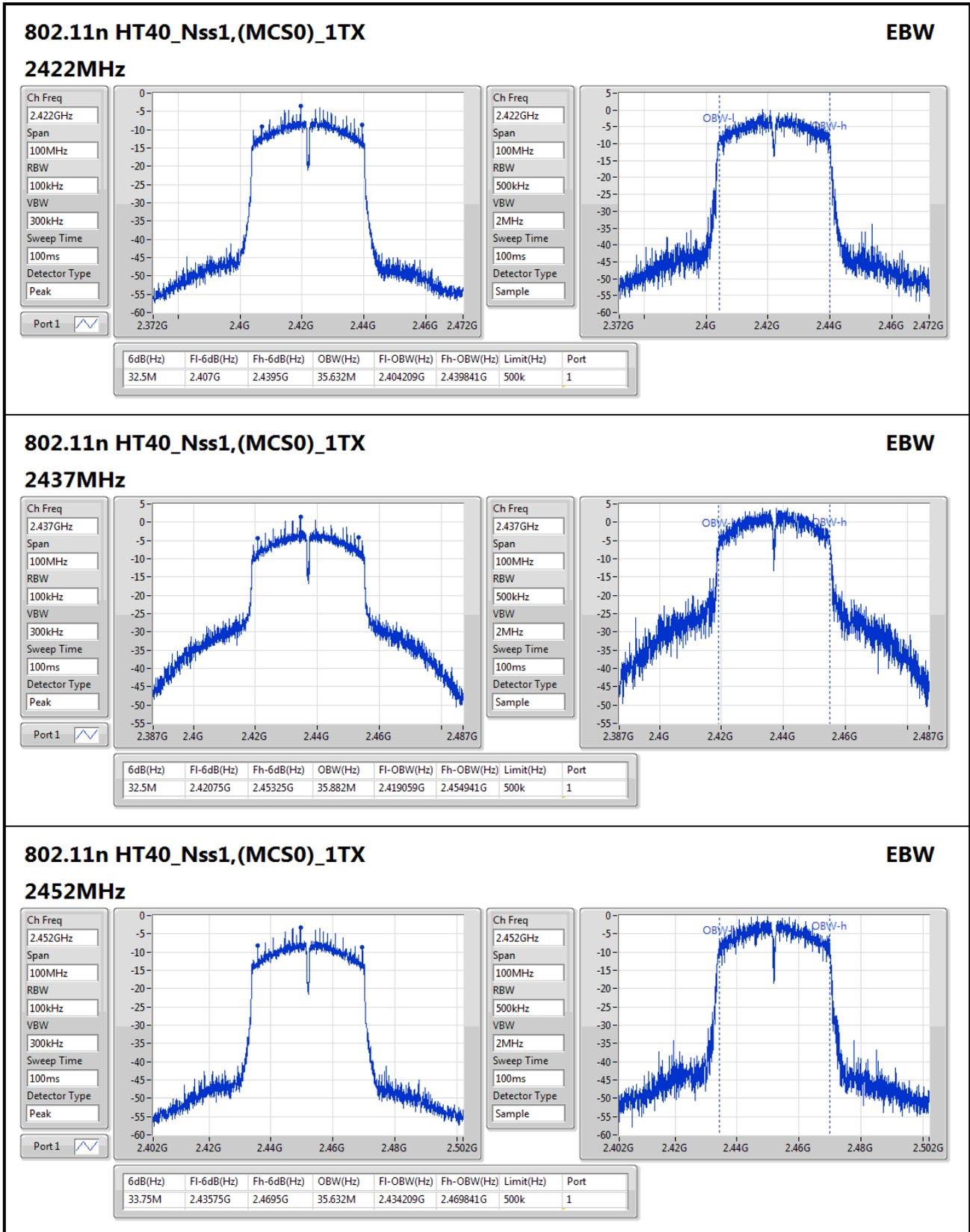



Summary

Mode	Total Power (dBm)	Total Power (W)
802.11b_(1Mbps)_1TX	-	-
2.4-2.4835GHz	14.67	0.02931
802.11g_(6Mbps)_1TX	-	-
2.4-2.4835GHz	11.99	0.01581
802.11n HT20_Nss2,(MCS8)_2TX	-	-
2.4-2.4835GHz	15.58	0.03614
802.11n HT40_Nss1,(MCS0)_1TX	-	-
2.4-2.4835GHz	13.73	0.02360

Result

Mode	Result	DG (dBi)	Port 1 (dBm)	Port 2 (dBm)	Total Power (dBm)	Power Limit (dBm)
802.11b_(1Mbps)_1TX	-	-	-	-	-	-
2412MHz_TnomVnom	Pass	1.64	14.62	-	14.62	30.00
2437MHz_TnomVnom	Pass	1.64	14.67	-	14.67	30.00
2462MHz_TnomVnom	Pass	1.64	14.61	-	14.61	30.00
802.11g_(6Mbps)_1TX	-	-	-	-	-	-
2412MHz_TnomVnom	Pass	1.64	11.89	-	11.89	30.00
2437MHz_TnomVnom	Pass	1.64	11.99	-	11.99	30.00
2462MHz_TnomVnom	Pass	1.64	11.78	-	11.78	30.00
802.11n HT20_Nss2,(MCS8)_2TX	-	-	-	-	-	-
2412MHz_TnomVnom	Pass	1.64	9.09	10.41	12.81	30.00
2437MHz_TnomVnom	Pass	1.64	11.96	13.11	15.58	30.00
2462MHz_TnomVnom	Pass	1.64	9.06	10.27	12.72	30.00
802.11n HT40_Nss1,(MCS0)_1TX	-	-	-	-	-	-
2422MHz_TnomVnom	Pass	1.64	8.82	-	8.82	30.00
2437MHz_TnomVnom	Pass	1.64	13.73	-	13.73	30.00
2452MHz_TnomVnom	Pass	1.64	8.86	-	8.86	30.00

DG = Directional Gain; Port X = Port X output power



Summary

Mode	PD (dBm/RBW)
802.11b_(1Mbps)_1TX	-
2.4-2.4835GHz	-9.35
802.11g_(6Mbps)_1TX	-
2.4-2.4835GHz	-12.40
802.11n HT20_Nss2,(MCS8)_2TX	-
2.4-2.4835GHz	-11.51
802.11n HT40_Nss1,(MCS0)_1TX	-
2.4-2.4835GHz	-14.02

RBW=3kHz.

Result

Mode	Result	DG (dBi)	Port 1 (dBm/RBW)	Port 2 (dBm/RBW)	PD (dBm/RBW)	PD Limit (dBm/RBW)
802.11b_(1Mbps)_1TX	-	-	-	-	-	-
2412MHz_TnomVnom	Pass	1.64	-9.54	-	-9.54	8.00
2437MHz_TnomVnom	Pass	1.64	-9.47	-	-9.47	8.00
2462MHz_TnomVnom	Pass	1.64	-9.35	-	-9.35	8.00
802.11g_(6Mbps)_1TX	-	-	-	-	-	-
2412MHz_TnomVnom	Pass	1.64	-12.40	-	-12.40	8.00
2437MHz_TnomVnom	Pass	1.64	-12.91	-	-12.91	8.00
2462MHz_TnomVnom	Pass	1.64	-14.02	-	-14.02	8.00
802.11n HT20_Nss2,(MCS8)_2TX	-	-	-	-	-	-
2412MHz_TnomVnom	Pass	1.64	-16.88	-15.20	-14.00	8.00
2437MHz_TnomVnom	Pass	1.64	-13.95	-12.52	-11.51	8.00
2462MHz_TnomVnom	Pass	1.64	-15.56	-14.53	-13.98	8.00
802.11n HT40_Nss1,(MCS0)_1TX	-	-	-	-	-	-
2422MHz_TnomVnom	Pass	1.64	-18.44	-	-18.44	8.00
2437MHz_TnomVnom	Pass	1.64	-14.02	-	-14.02	8.00
2452MHz_TnomVnom	Pass	1.64	-17.70	-	-17.70	8.00

DG = Directional Gain; RBW=3kHz;

PD = trace bin-by-bin of each transmits port summing can be performed maximum power density; **Port X** = Port X power density;

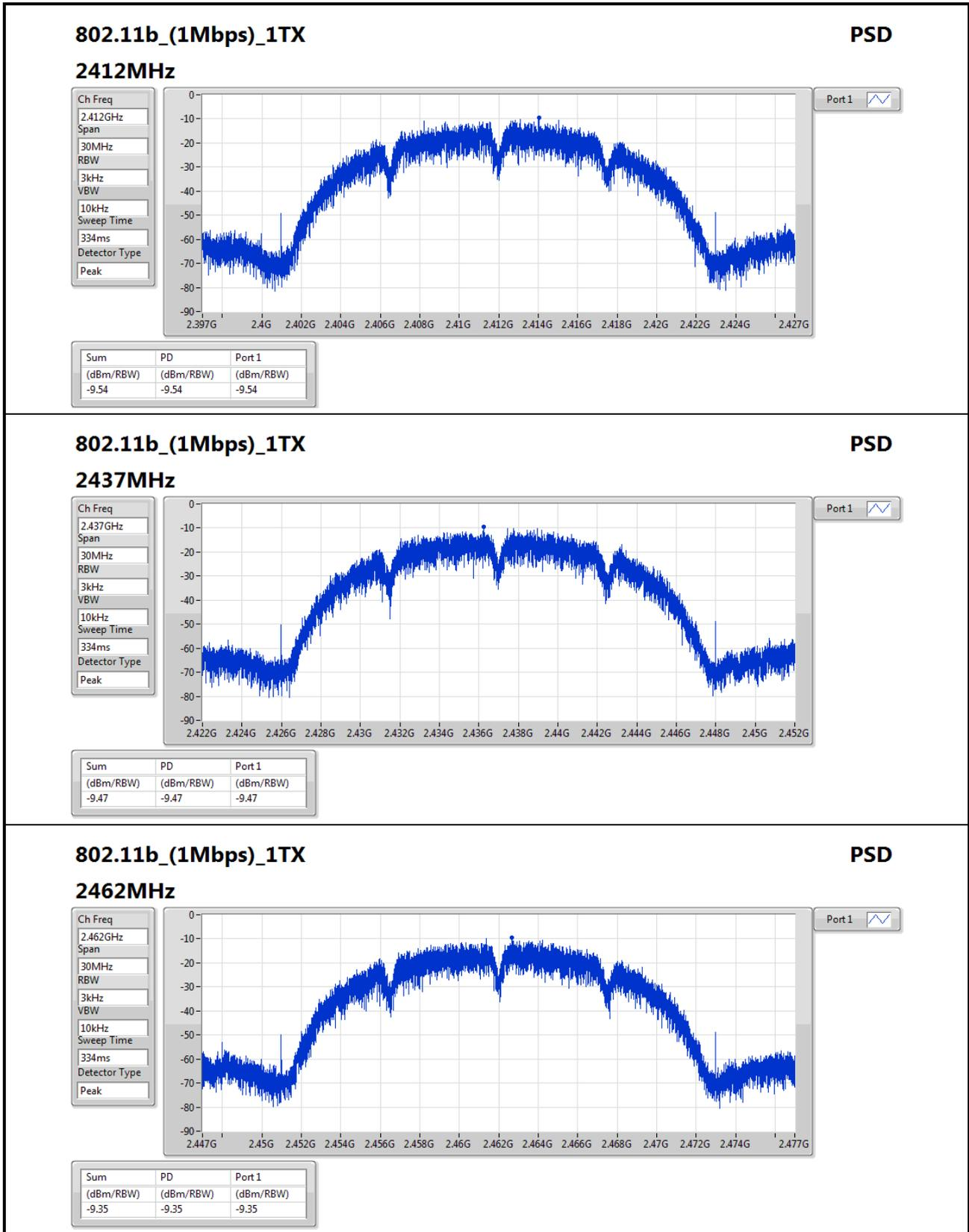

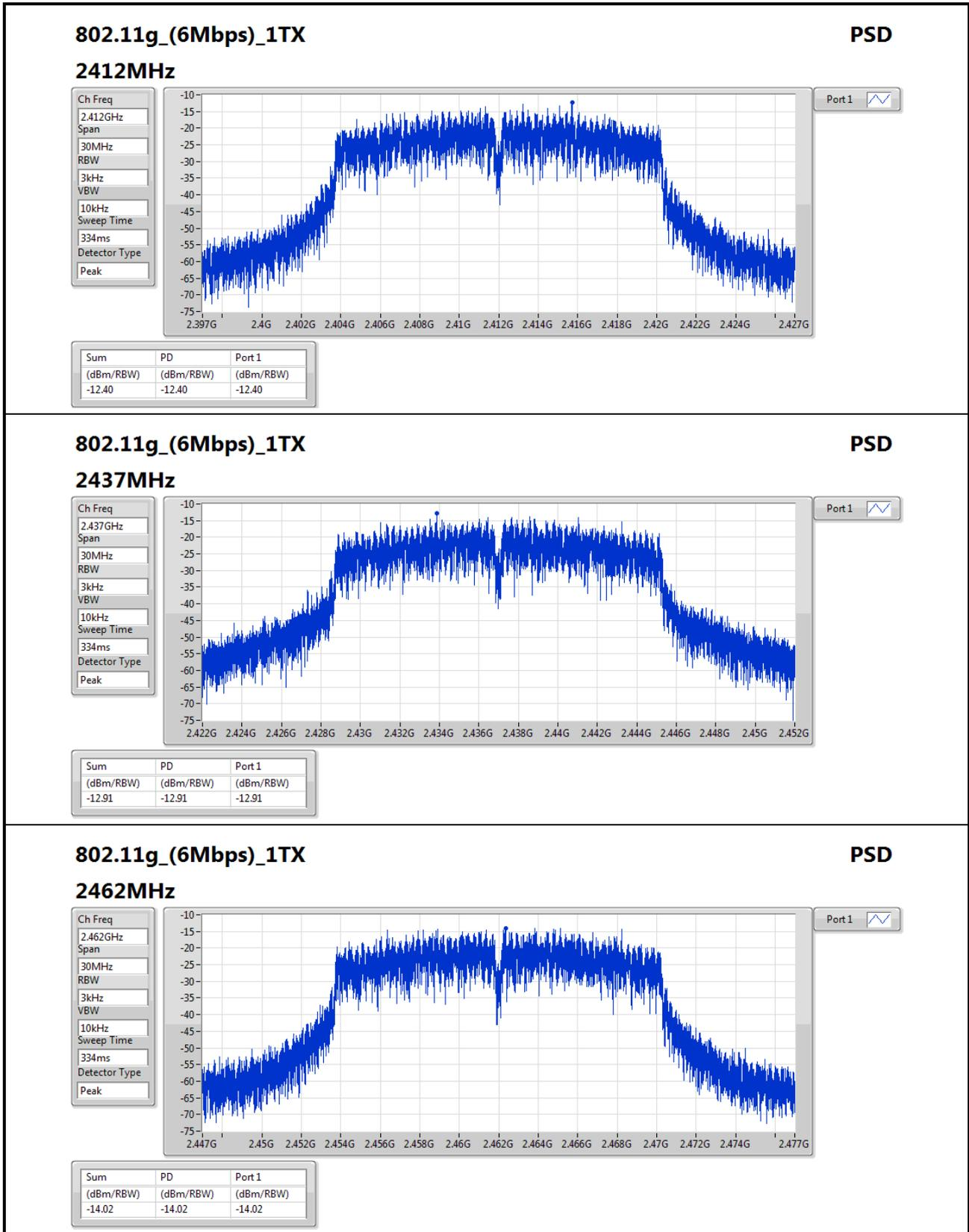

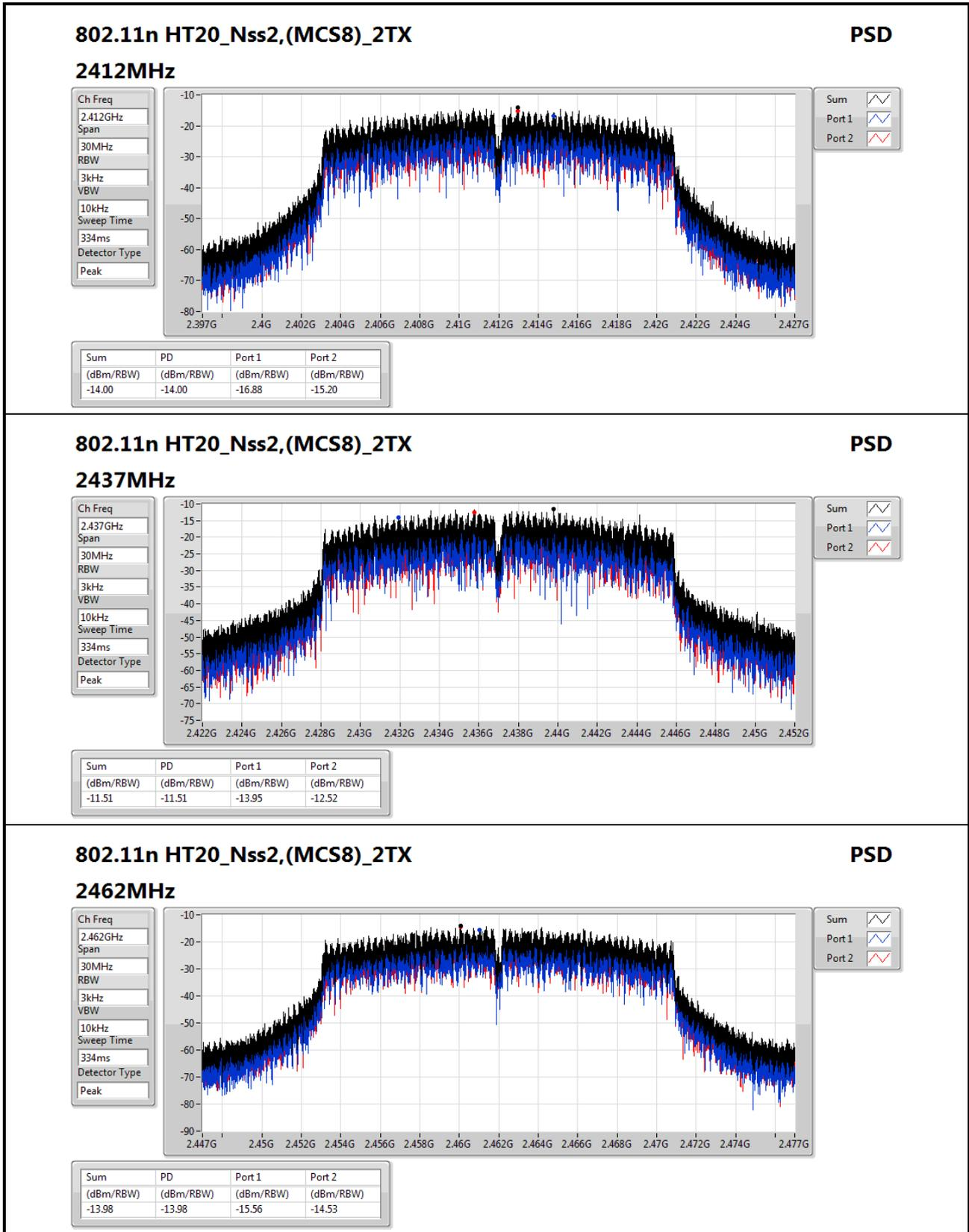
802.11n HT20_Nss2,(MCS8)_2TX
PSD

2462MHz

Ch Freq
2.462GHz

Span
30MHz

RBW
3kHz

VBW
10kHz

Sweep Time
334ms

Detector Type
Peak

Sum

Port 1

Port 2

Sum	PD	Port 1	Port 2
(dBm/RBW)	(dBm/RBW)	(dBm/RBW)	(dBm/RBW)
-13.98	-13.98	-15.56	-14.53

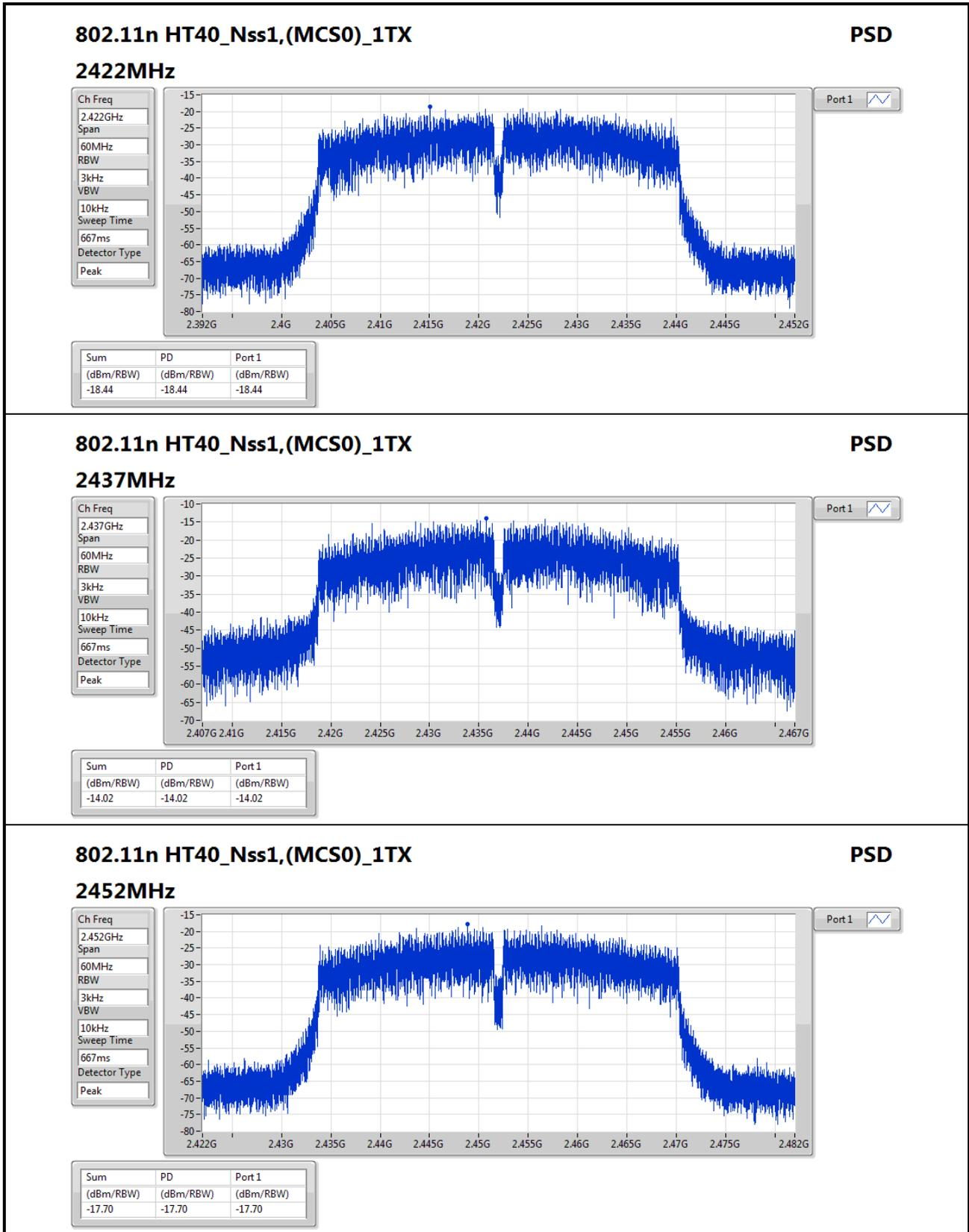
802.11n HT40_Nss1,(MCS0)_1TX
PSD

2452MHz

Ch Freq
2.452GHz

Span
60MHz

RBW
3kHz

VBW
10kHz

Sweep Time
667ms

Detector Type
Peak

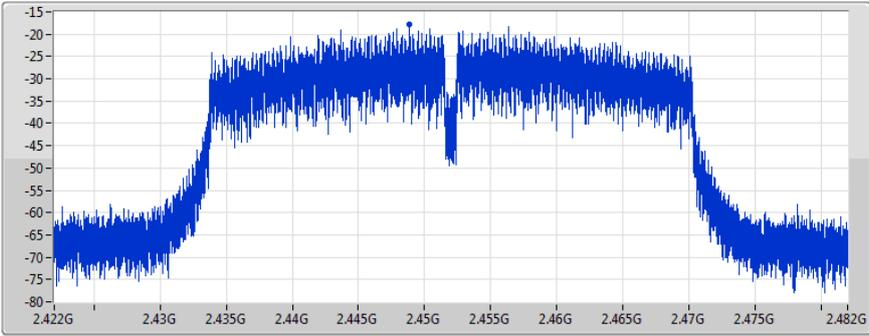

Port 1

Sum	PD	Port 1
(dBm/RBW)	(dBm/RBW)	(dBm/RBW)
-17.70	-17.70	-17.70



Summary

Mode	Result	Ref (Hz)	Ref (dBm)	Limit (dBm)	Freq (Hz)	Level (dBm)	Freq (Hz)	Level (dBm)	Freq (Hz)	Level (dBm)	Freq (Hz)	Level (dBm)	Port
802.11g_(6Mbps)_1TX	-	-	-	-	-	-	-	-	-	-	-	-	-
2.4-2.4835GHz	Pass	2.430728G	0.02	-29.98	2.302915G	-61.80	2.39952G	-30.32	2.5195G	-57.08	16.208879G	-53.45	1

Result

Mode	Result	Ref (Hz)	Ref (dBm)	Limit (dBm)	Freq (Hz)	Level (dBm)	Freq (Hz)	Level (dBm)	Freq (Hz)	Level (dBm)	Freq (Hz)	Level (dBm)	Port
802.11b_(1Mbps)_1TX	-	-	-	-	-	-	-	-	-	-	-	-	-
2412MHz_TnomVnom	Pass	2.436406G	8.00	-22.00	2.309905G	-58.82	2.39648G	-41.94	2.5135G	-56.89	16.234165G	-53.77	1
2437MHz_TnomVnom	Pass	2.436406G	8.00	-22.00	2.137485G	-61.51	2.39136G	-57.61	2.49294G	-55.28	17.287751G	-54.65	1
2462MHz_TnomVnom	Pass	2.436406G	8.00	-22.00	2.309905G	-60.95	2.3976G	-59.64	2.48742G	-53.31	16.565693G	-54.87	1
802.11g_(6Mbps)_1TX	-	-	-	-	-	-	-	-	-	-	-	-	-
2412MHz_TnomVnom	Pass	2.430728G	0.02	-29.98	2.302915G	-61.80	2.39952G	-30.32	2.5195G	-57.08	16.208879G	-53.45	1
2437MHz_TnomVnom	Pass	2.430728G	0.02	-29.98	2.302915G	-61.71	2.3992G	-57.51	2.48646G	-56.85	17.543421G	-54.95	1
2462MHz_TnomVnom	Pass	2.430728G	0.02	-29.98	861.81M	-61.85	2.39384G	-58.73	2.48534G	-45.09	17.509706G	-54.45	1
802.11n HT20_Nss2,(MCS8)_2TX	-	-	-	-	-	-	-	-	-	-	-	-	-
2412MHz_TnomVnom	Pass	2.435738G	3.81	-26.19	2.165445G	-61.44	2.39976G	-40.87	2.5011G	-59.32	16.222927G	-53.94	1
2412MHz_TnomVnom	Pass	2.435738G	3.81	-26.19	2.146805G	-60.94	2.39976G	-37.79	2.49454G	-59.18	16.551646G	-54.49	2
2437MHz_TnomVnom	Pass	2.435738G	3.81	-26.19	2.1503G	-61.66	2.39896G	-54.82	2.49022G	-56.98	15.197436G	-54.85	1
2437MHz_TnomVnom	Pass	2.435738G	3.81	-26.19	855.985M	-61.19	2.3996G	-55.52	2.49158G	-56.29	16.253832G	-54.03	2
2462MHz_TnomVnom	Pass	2.435738G	3.81	-26.19	2.111855G	-61.65	2.3984G	-59.43	2.4847G	-50.32	16.231355G	-53.76	1
2462MHz_TnomVnom	Pass	2.435738G	3.81	-26.19	2.11768G	-61.88	2.39928G	-58.92	2.48382G	-48.78	16.58536G	-53.78	2
802.11n HT40_Nss1,(MCS0)_1TX	-	-	-	-	-	-	-	-	-	-	-	-	-
2422MHz_TnomVnom	Pass	2.441917G	1.98	-28.02	2.195195G	-61.07	2.39632G	-42.76	2.51726G	-58.89	16.928469G	-54.80	1
2437MHz_TnomVnom	Pass	2.441917G	1.98	-28.02	2.309695G	-61.02	2.39984G	-32.83	2.48494G	-43.34	16.230133G	-53.84	1
2452MHz_TnomVnom	Pass	2.441917G	1.98	-28.02	766.235M	-61.83	2.39632G	-57.32	2.48574G	-47.40	16.207697G	-55.03	1

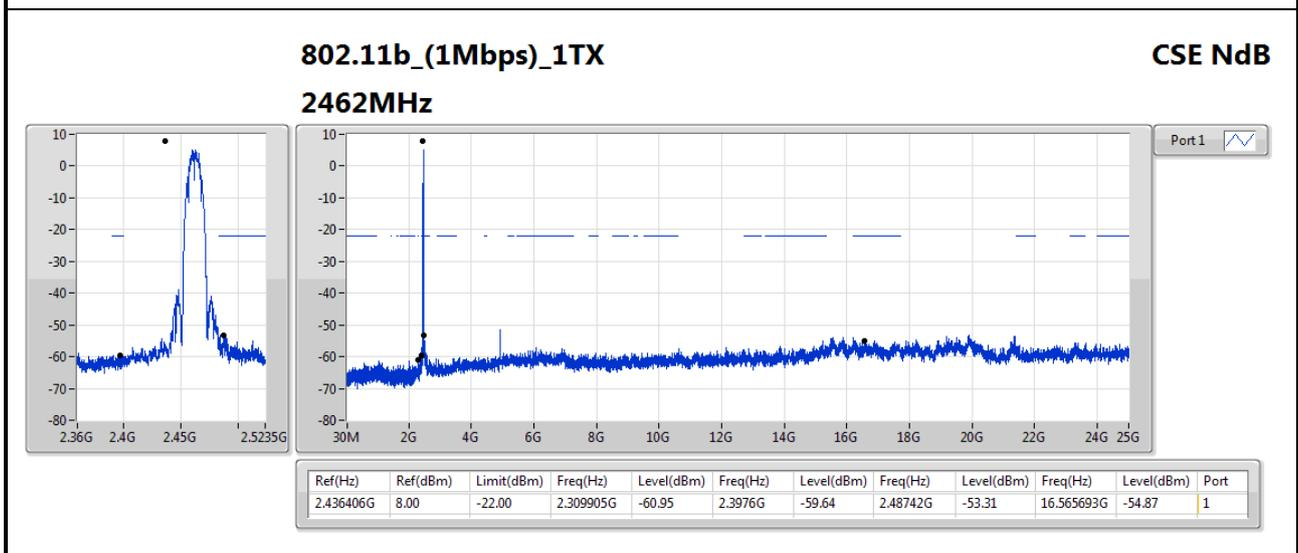
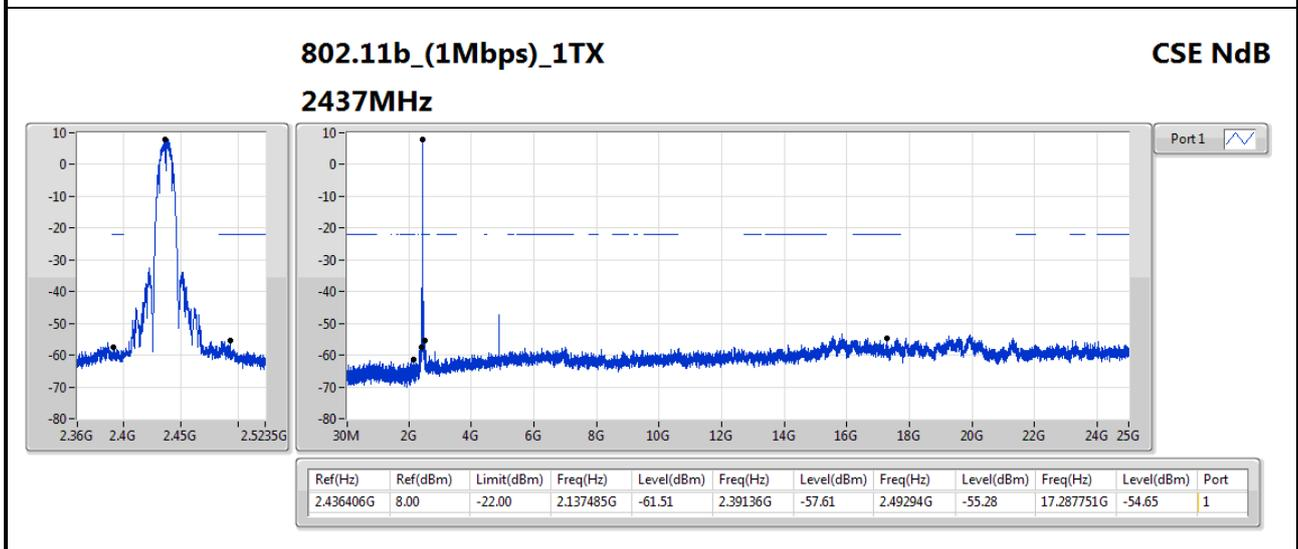
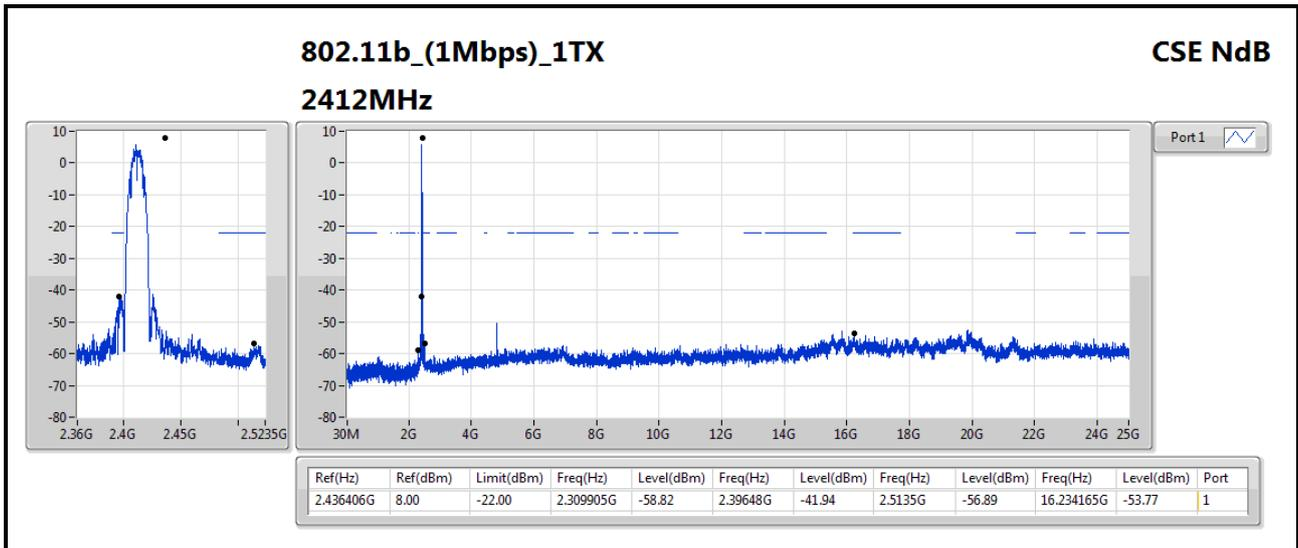

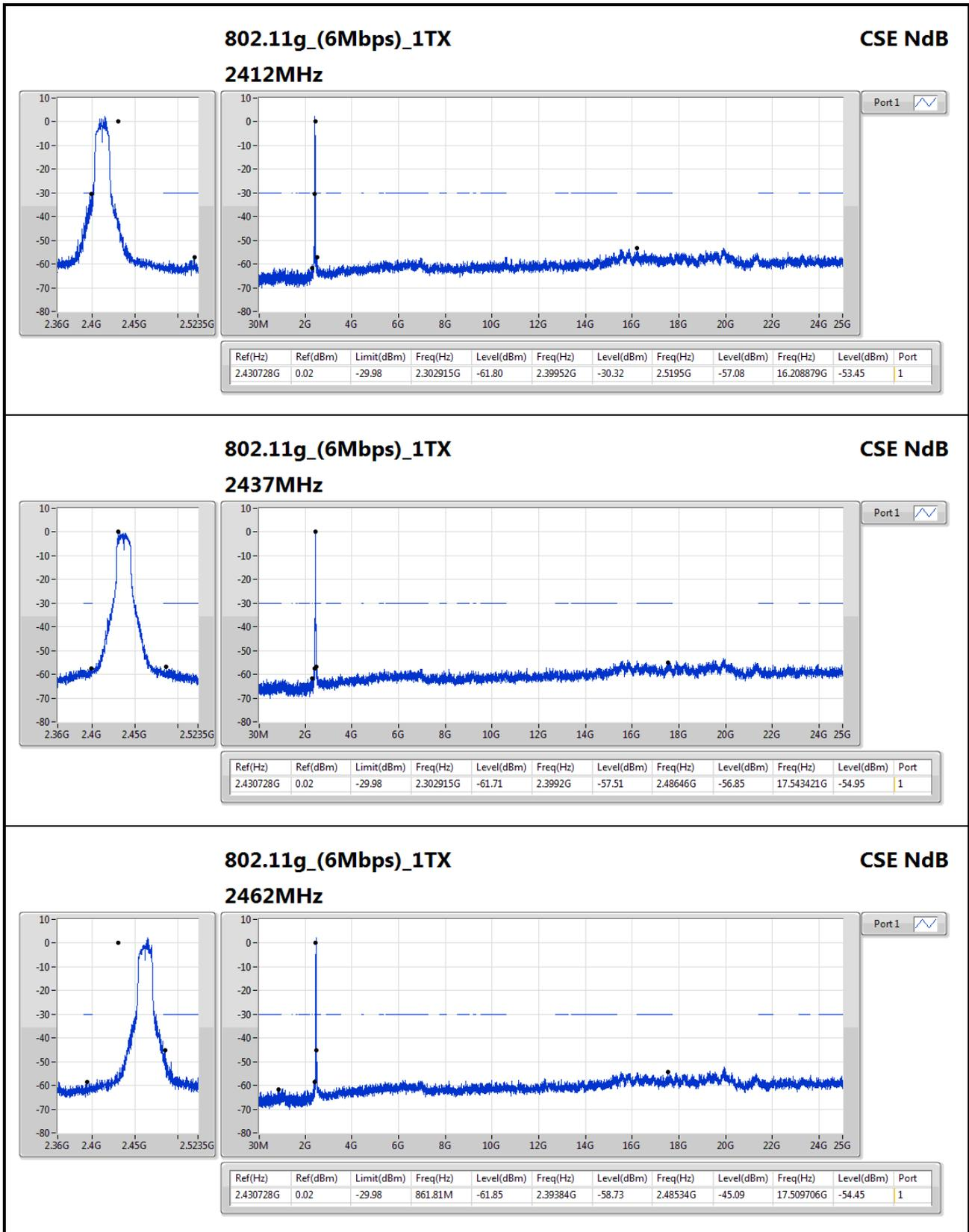

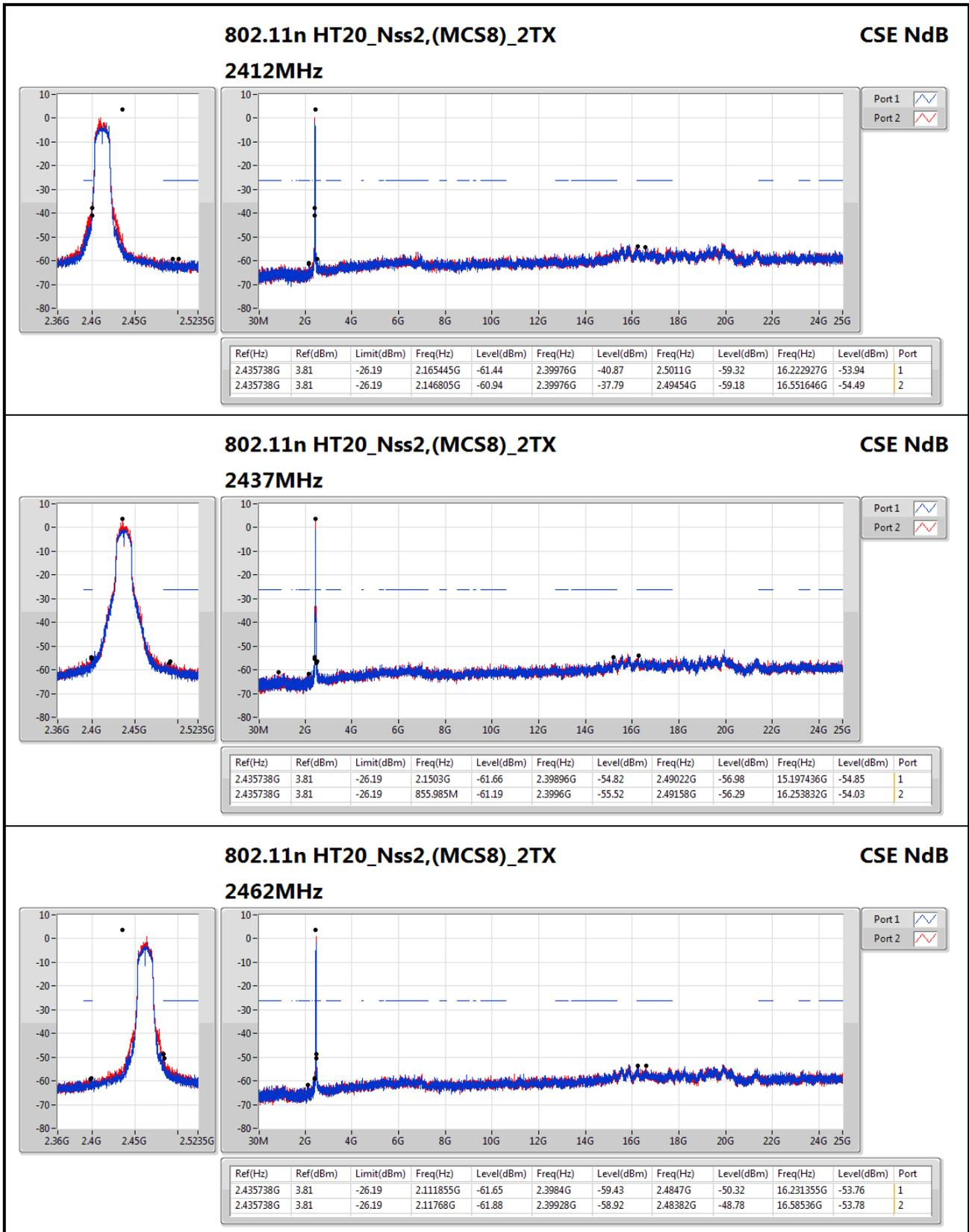

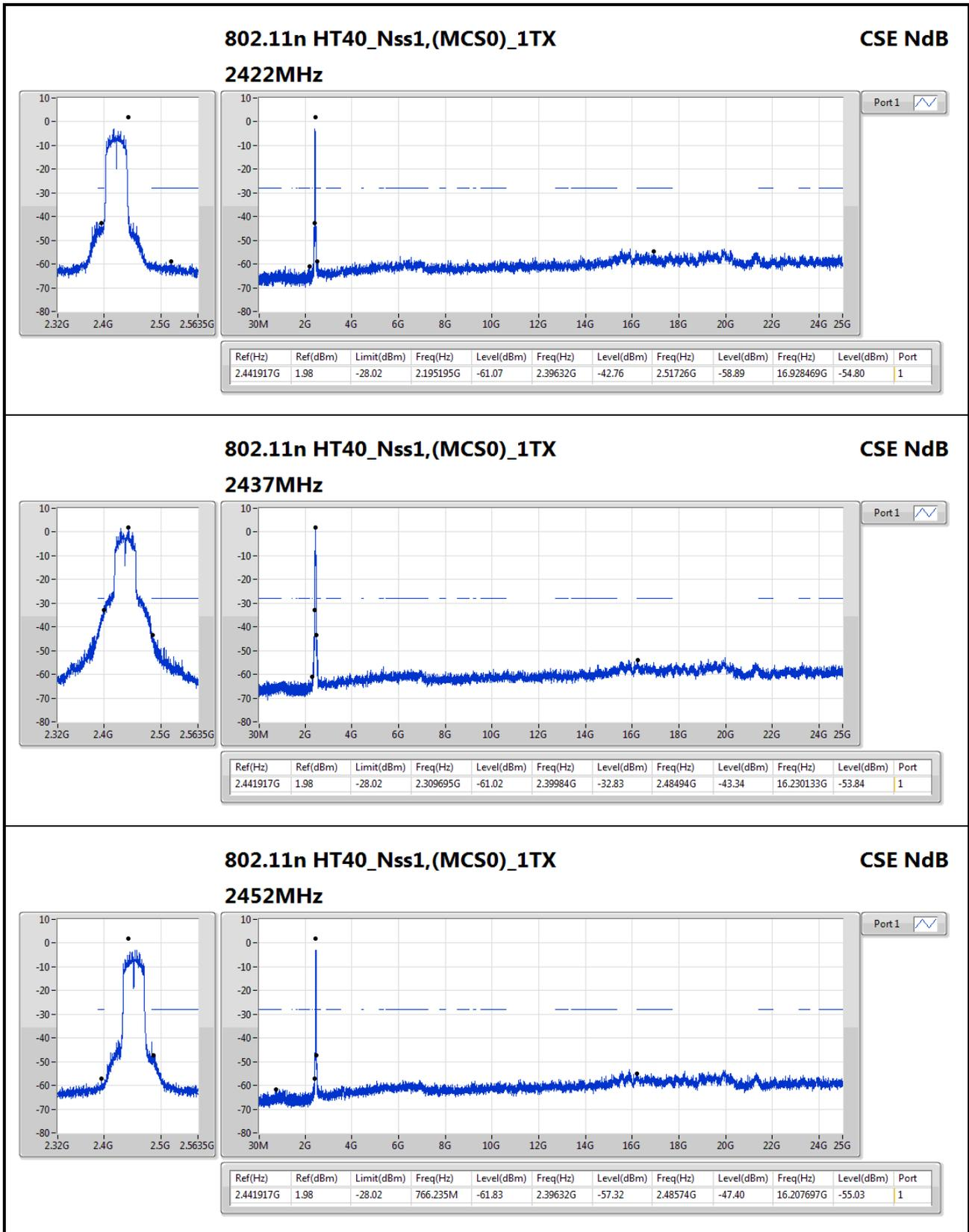



Summary

Mode	Result	Type	Freq (Hz)	Level (dBuV/m)	Limit (dBuV/m)	Margin (dB)	Factor (dB)	Dist (m)	Condition	Azimuth (°)	Height (m)	Comments
802.11b_(1Mbps)_1TX	-	-	-	-	-	-	-	-	-	-	-	-
2.4-2.4835GHz	Pass	PK	192.96M	40.10	43.50	-3.40	-16.62	3	Vertical	360	1.00	-



Result

Mode	Result	Type	Freq (Hz)	Level (dBuV/m)	Limit (dBuV/m)	Margin (dB)	Factor (dB)	Dist (m)	Condition	Azimuth (°)	Height (m)	Comments
802.11b_(1Mbps)_1TX	-	-	-	-	-	-	-	-	-	-	-	-
2437MHz	Pass	PK	208.48M	38.67	43.50	-4.83	-16.37	3	Horizontal	0	1.00	-
2437MHz	Pass	PK	274.44M	39.86	46.00	-6.14	-12.32	3	Horizontal	0	1.00	-
2437MHz	Pass	PK	311.3M	36.32	46.00	-9.68	-11.52	3	Horizontal	0	1.00	-
2437MHz	Pass	PK	695.42M	34.85	46.00	-11.15	-4.41	3	Horizontal	0	1.00	-
2437MHz	Pass	PK	743.92M	36.03	46.00	-9.97	-3.25	3	Horizontal	0	1.00	-
2437MHz	Pass	QP	150.28M	38.52	43.50	-4.98	-15.36	3	Horizontal	122	2.00	-
2437MHz	Pass	PK	148.34M	36.93	43.50	-6.57	-15.27	3	Vertical	360	1.00	-
2437MHz	Pass	PK	192.96M	40.10	43.50	-3.40	-16.62	3	Vertical	360	1.00	-
2437MHz	Pass	PK	276.38M	39.53	46.00	-6.47	-12.31	3	Vertical	360	1.00	-
2437MHz	Pass	PK	311.3M	34.72	46.00	-11.28	-11.52	3	Vertical	360	1.00	-
2437MHz	Pass	PK	328.76M	30.64	46.00	-15.36	-11.19	3	Vertical	360	1.00	-
2437MHz	Pass	PK	695.42M	32.55	46.00	-13.45	-4.41	3	Vertical	360	1.00	-

802.11b_(1Mbps)_1TX 2437MHz_Charge Mode

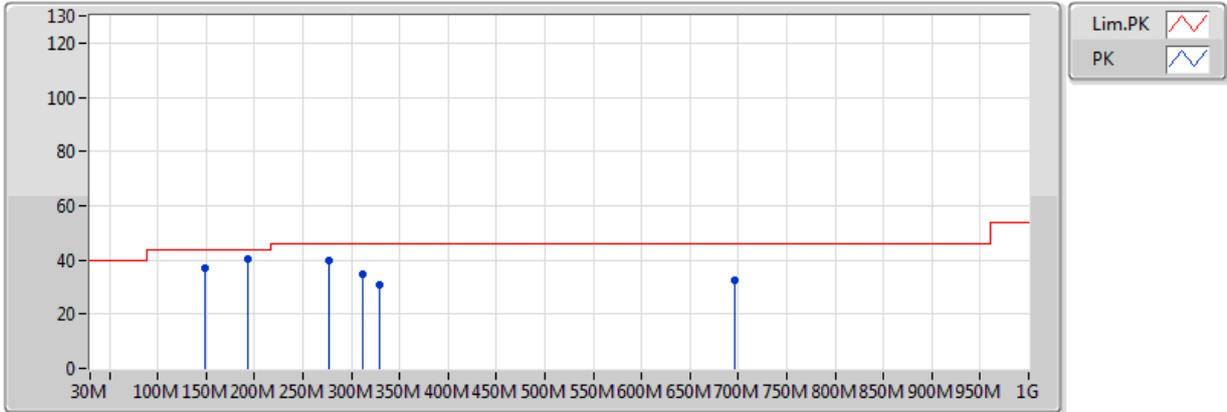

EUT = Z axis

Type	Freq (Hz)	Level (dBuV/m)	Limit (dBuV/m)	Margin (dB)	Factor (dB)	Dist (m)	Condition	Azimuth (°)	Height (m)	Comments	Raw (dBuV)	AF (dB)	CL (dB)	PA (dB)
PK	148.34M	36.93	43.50	-6.57	-15.27	3	Vertical	360	1.00	-	52.20	15.80	1.47	32.54
PK	192.96M	40.10	43.50	-3.40	-16.62	3	Vertical	360	1.00	-	56.72	14.19	1.68	32.50
PK	276.38M	39.53	46.00	-6.47	-12.31	3	Vertical	360	1.00	-	51.84	17.97	2.04	32.33
PK	311.3M	34.72	46.00	-11.28	-11.52	3	Vertical	360	1.00	-	46.24	18.56	2.18	32.27
PK	328.76M	30.64	46.00	-15.36	-11.19	3	Vertical	360	1.00	-	41.83	18.81	2.25	32.25
PK	695.42M	32.55	46.00	-13.45	-4.41	3	Vertical	360	1.00	-	36.96	24.05	3.30	31.76

802.11b_(1Mbps)_1TX 2437MHz_Charge Mode

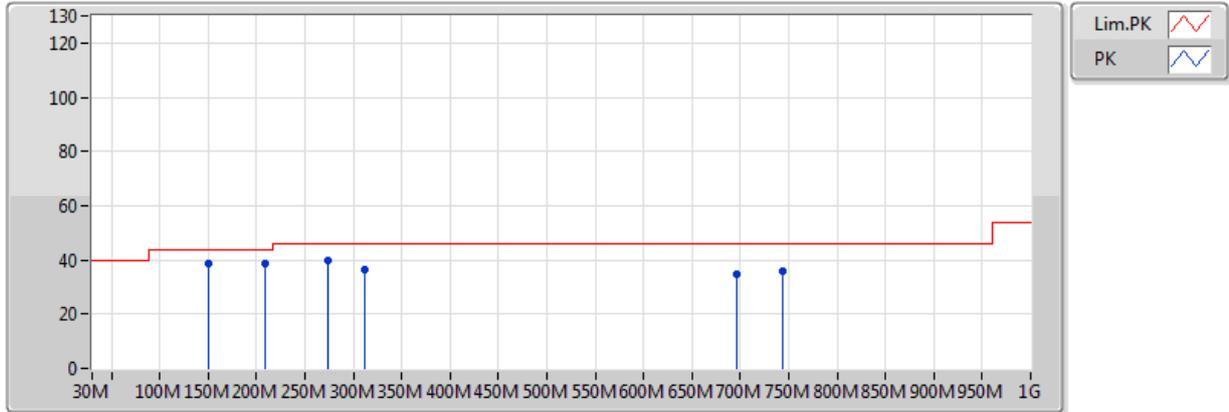

EUT = Z axis

Type	Freq (Hz)	Level (dBuV/m)	Limit (dBuV/m)	Margin (dB)	Factor (dB)	Dist (m)	Condition	Azimuth (°)	Height (m)	Comments	Raw (dBuV)	AF (dB)	CL (dB)	PA (dB)
PK	208.48M	38.67	43.50	-4.83	-16.37	3	Horizontal	0	1.00	-	55.04	14.35	1.75	32.47
PK	274.44M	39.86	46.00	-6.14	-12.32	3	Horizontal	0	1.00	-	52.18	17.98	2.03	32.33
PK	311.3M	36.32	46.00	-9.68	-11.52	3	Horizontal	0	1.00	-	47.84	18.56	2.18	32.27
PK	695.42M	34.85	46.00	-11.15	-4.41	3	Horizontal	0	1.00	-	39.26	24.05	3.30	31.76
PK	743.92M	36.03	46.00	-9.97	-3.25	3	Horizontal	0	1.00	-	39.28	24.84	3.65	31.74
QP	150.28M	38.52	43.50	-4.98	-15.36	3	Horizontal	122	2.00	-	53.88	15.69	1.48	32.54



Summary

Mode	Result	Type	Freq (Hz)	Level (dBuV/m)	Limit (dBuV/m)	Margin (dB)	Factor (dB)	Dist (m)	Condition	Azimuth (°)	Height (m)	Comments
802.11n HT40_Nss1,(MCS0)_1TX	-	-	-	-	-	-	-	-	-	-	-	-
2.4-2.4835GHz	Pass	AV	2.483502G	45.98	54.00	-8.02	2.28	3	Vertical	84	3.00	-



Result

Mode	Result	Type	Freq (Hz)	Level (dBuV/m)	Limit (dBuV/m)	Margin (dB)	Factor (dB)	Dist (m)	Condition	Azimuth (°)	Height (m)	Comments
802.11b_(1Mbps)_1TX	-	-	-	-	-	-	-	-	-	-	-	-
2412MHz	Pass	AV	2.3878G	43.29	54.00	-10.71	2.09	3	Horizontal	157	2.42	-
2412MHz	Pass	AV	2.4112G	87.55	Inf	-Inf	2.14	3	Horizontal	157	2.42	-
2412MHz	Pass	PK	2.3718G	56.64	74.00	-17.36	2.04	3	Horizontal	157	2.42	-
2412MHz	Pass	PK	2.411G	91.38	Inf	-Inf	2.14	3	Horizontal	157	2.42	-
2412MHz	Pass	AV	2.386G	43.35	54.00	-10.65	2.08	3	Vertical	85	2.44	-
2412MHz	Pass	AV	2.4112G	87.81	Inf	-Inf	2.14	3	Vertical	85	2.44	-
2412MHz	Pass	PK	2.3834G	55.98	74.00	-18.02	2.08	3	Vertical	85	2.44	-
2412MHz	Pass	PK	2.411G	91.66	Inf	-Inf	2.14	3	Vertical	85	2.44	-
2412MHz	Pass	AV	4.824G	36.42	54.00	-17.58	6.73	3	Horizontal	360	1.50	-
2412MHz	Pass	PK	4.824G	50.23	74.00	-23.77	6.73	3	Horizontal	360	1.50	-
2412MHz	Pass	AV	4.824G	37.33	54.00	-16.67	6.73	3	Vertical	0	1.50	-
2412MHz	Pass	PK	4.824G	51.23	74.00	-22.77	6.73	3	Vertical	0	1.50	-
2437MHz	Pass	AV	2.3838G	43.26	54.00	-10.74	2.08	3	Horizontal	159	2.09	-
2437MHz	Pass	AV	2.4362G	100.29	Inf	-Inf	2.19	3	Horizontal	159	2.09	-
2437MHz	Pass	AV	2.4878G	42.98	54.00	-11.02	2.29	3	Horizontal	159	2.09	-
2437MHz	Pass	PK	2.389998G	55.85	74.00	-18.15	2.09	3	Horizontal	159	2.09	-
2437MHz	Pass	PK	2.4362G	104.08	Inf	-Inf	2.19	3	Horizontal	159	2.09	-
2437MHz	Pass	PK	2.493G	55.01	74.00	-18.99	2.30	3	Horizontal	159	2.09	-
2437MHz	Pass	AV	2.383G	43.00	54.00	-11.00	2.07	3	Vertical	92	3.02	-
2437MHz	Pass	AV	2.4362G	101.11	Inf	-Inf	2.19	3	Vertical	92	3.02	-
2437MHz	Pass	AV	2.4886G	43.19	54.00	-10.81	2.29	3	Vertical	92	3.02	-
2437MHz	Pass	PK	2.345G	56.07	74.00	-17.93	1.97	3	Vertical	92	3.02	-
2437MHz	Pass	PK	2.4382G	104.99	Inf	-Inf	2.19	3	Vertical	92	3.02	-
2437MHz	Pass	PK	2.4942G	55.09	74.00	-18.91	2.30	3	Vertical	92	3.02	-
2437MHz	Pass	AV	4.874G	38.35	54.00	-15.65	6.82	3	Horizontal	360	1.50	-
2437MHz	Pass	PK	4.874G	50.19	74.00	-23.81	6.82	3	Horizontal	360	1.50	-
2437MHz	Pass	AV	4.874G	39.32	54.00	-14.68	6.82	3	Vertical	288	1.92	-
2437MHz	Pass	PK	4.874G	50.40	74.00	-23.60	6.82	3	Vertical	288	1.92	-
2462MHz	Pass	AV	2.4612G	95.71	Inf	-Inf	2.24	3	Horizontal	148	2.40	-
2462MHz	Pass	AV	2.4878G	43.72	54.00	-10.28	2.29	3	Horizontal	148	2.40	-
2462MHz	Pass	PK	2.4612G	99.47	Inf	-Inf	2.24	3	Horizontal	148	2.40	-
2462MHz	Pass	PK	2.4878G	55.46	74.00	-18.54	2.29	3	Horizontal	148	2.40	-
2462MHz	Pass	AV	2.4612G	96.95	Inf	-Inf	2.24	3	Vertical	91	2.85	-
2462MHz	Pass	AV	2.4878G	44.91	54.00	-9.09	2.29	3	Vertical	91	2.85	-
2462MHz	Pass	PK	2.4612G	100.69	Inf	-Inf	2.24	3	Vertical	91	2.85	-
2462MHz	Pass	PK	2.4916G	56.24	74.00	-17.76	2.29	3	Vertical	91	2.85	-
2462MHz	Pass	AV	4.924G	36.19	54.00	-17.81	6.92	3	Horizontal	0	1.50	-
2462MHz	Pass	PK	4.924G	50.43	74.00	-23.57	6.92	3	Horizontal	0	1.50	-
2462MHz	Pass	AV	4.924G	36.09	54.00	-17.91	6.92	3	Vertical	0	1.50	-
2462MHz	Pass	PK	4.924G	50.60	74.00	-23.40	6.92	3	Vertical	360	1.50	-
802.11g_(6Mbps)_1TX	-	-	-	-	-	-	-	-	-	-	-	-
2412MHz	Pass	AV	2.39G	44.12	54.00	-9.88	2.09	3	Horizontal	157	2.30	-
2412MHz	Pass	AV	2.4132G	89.20	Inf	-Inf	2.15	3	Horizontal	157	2.30	-
2412MHz	Pass	PK	2.39G	61.22	74.00	-12.78	2.09	3	Horizontal	157	2.30	-
2412MHz	Pass	PK	2.4146G	100.87	Inf	-Inf	2.15	3	Horizontal	157	2.30	-
2412MHz	Pass	AV	2.39G	43.64	54.00	-10.36	2.09	3	Vertical	85	2.45	-
2412MHz	Pass	AV	2.4108G	89.02	Inf	-Inf	2.14	3	Vertical	85	2.45	-



RSE TX above 1GHz Result

Appendix F.2

Mode	Result	Type	Freq (Hz)	Level (dBuV/m)	Limit (dBuV/m)	Margin (dB)	Factor (dB)	Dist (m)	Condition	Azimuth (°)	Height (m)	Comments
2412MHz	Pass	PK	2.3888G	60.75	74.00	-13.25	2.09	3	Vertical	85	2.45	-
2412MHz	Pass	PK	2.4108G	100.88	Inf	-Inf	2.14	3	Vertical	85	2.45	-
2412MHz	Pass	AV	4.824G	36.52	54.00	-17.48	6.73	3	Horizontal	0	1.50	-
2412MHz	Pass	PK	4.824G	50.26	74.00	-23.74	6.73	3	Horizontal	0	1.50	-
2412MHz	Pass	AV	4.824G	36.39	54.00	-17.61	6.73	3	Vertical	360	1.50	-
2412MHz	Pass	PK	4.824G	50.23	74.00	-23.77	6.73	3	Vertical	360	1.50	-
2437MHz	Pass	AV	2.3882G	42.88	54.00	-11.12	2.09	3	Horizontal	159	2.10	-
2437MHz	Pass	AV	2.4358G	88.85	Inf	-Inf	2.19	3	Horizontal	159	2.10	-
2437MHz	Pass	AV	2.4914G	42.91	54.00	-11.09	2.29	3	Horizontal	159	2.10	-
2437MHz	Pass	PK	2.3514G	56.12	74.00	-17.88	1.99	3	Horizontal	159	2.10	-
2437MHz	Pass	PK	2.4366G	101.40	Inf	-Inf	2.19	3	Horizontal	159	2.10	-
2437MHz	Pass	PK	2.499G	56.23	74.00	-17.77	2.31	3	Horizontal	159	2.10	-
2437MHz	Pass	AV	2.3862G	42.88	54.00	-11.12	2.08	3	Vertical	91	3.01	-
2437MHz	Pass	AV	2.4354G	89.52	Inf	-Inf	2.19	3	Vertical	91	3.01	-
2437MHz	Pass	AV	2.4842G	42.97	54.00	-11.03	2.28	3	Vertical	91	3.01	-
2437MHz	Pass	PK	2.3686G	56.69	74.00	-17.31	2.04	3	Vertical	91	3.01	-
2437MHz	Pass	PK	2.4366G	101.61	Inf	-Inf	2.19	3	Vertical	91	3.01	-
2437MHz	Pass	PK	2.483502G	57.08	74.00	-16.92	2.28	3	Vertical	91	3.01	-
2437MHz	Pass	AV	4.874G	36.63	54.00	-17.37	6.82	3	Horizontal	360	1.50	-
2437MHz	Pass	PK	4.874G	49.92	74.00	-24.08	6.82	3	Horizontal	360	1.50	-
2437MHz	Pass	AV	4.874G	36.65	54.00	-17.35	6.82	3	Vertical	0	1.50	-
2437MHz	Pass	PK	4.874G	49.28	74.00	-24.72	6.82	3	Vertical	0	1.50	-
2462MHz	Pass	AV	2.4604G	86.78	Inf	-Inf	2.23	3	Horizontal	126	2.28	-
2462MHz	Pass	AV	2.4836G	43.95	54.00	-10.05	2.28	3	Horizontal	126	2.28	-
2462MHz	Pass	PK	2.4604G	98.80	Inf	-Inf	2.23	3	Horizontal	126	2.28	-
2462MHz	Pass	PK	2.4844G	59.81	74.00	-14.19	2.28	3	Horizontal	126	2.28	-
2462MHz	Pass	AV	2.461G	89.79	Inf	-Inf	2.24	3	Vertical	90	2.84	-
2462MHz	Pass	AV	2.483502G	44.46	54.00	-9.54	2.28	3	Vertical	90	2.84	-
2462MHz	Pass	PK	2.4608G	101.69	Inf	-Inf	2.24	3	Vertical	90	2.84	-
2462MHz	Pass	PK	2.483502G	64.42	74.00	-9.58	2.28	3	Vertical	90	2.84	-
2462MHz	Pass	AV	4.924G	36.48	54.00	-17.52	6.92	3	Horizontal	360	1.50	-
2462MHz	Pass	PK	4.924G	50.45	74.00	-23.55	6.92	3	Horizontal	360	1.50	-
2462MHz	Pass	AV	4.924G	36.61	54.00	-17.39	6.92	3	Vertical	0	1.50	-
2462MHz	Pass	PK	4.924G	50.20	74.00	-23.80	6.92	3	Vertical	0	1.50	-
802.11n HT20_Nss2,(MCSB)_2TX	-	-	-	-	-	-	-	-	-	-	-	-
2412MHz	Pass	AV	2.39G	42.97	54.00	-11.03	2.09	3	Horizontal	142	2.10	-
2412MHz	Pass	AV	2.4134G	82.83	Inf	-Inf	2.15	3	Horizontal	142	2.10	-
2412MHz	Pass	PK	2.367G	56.29	74.00	-17.71	2.03	3	Horizontal	142	2.10	-
2412MHz	Pass	PK	2.4144G	100.02	Inf	-Inf	2.15	3	Horizontal	142	2.10	-
2412MHz	Pass	AV	2.3878G	42.89	54.00	-11.11	2.09	3	Vertical	95	2.09	-
2412MHz	Pass	AV	2.4138G	82.93	Inf	-Inf	2.15	3	Vertical	95	2.09	-
2412MHz	Pass	PK	2.3814G	56.31	74.00	-17.69	2.07	3	Vertical	95	2.09	-
2412MHz	Pass	PK	2.4102G	100.06	Inf	-Inf	2.14	3	Vertical	95	2.09	-
2412MHz	Pass	AV	4.824G	37.00	54.00	-17.00	6.73	3	Horizontal	360	1.50	-
2412MHz	Pass	PK	4.824G	50.69	74.00	-23.31	6.73	3	Horizontal	360	1.50	-
2412MHz	Pass	AV	4.824G	35.86	54.00	-18.14	6.73	3	Vertical	0	1.50	-
2412MHz	Pass	PK	4.824G	49.83	74.00	-24.17	6.73	3	Vertical	0	1.50	-
2437MHz	Pass	AV	2.387G	43.00	54.00	-11.00	2.08	3	Horizontal	144	2.24	-
2437MHz	Pass	AV	2.4354G	85.50	Inf	-Inf	2.19	3	Horizontal	144	2.24	-



RSE TX above 1GHz Result

Appendix F.2

Mode	Result	Type	Freq (Hz)	Level (dBuV/m)	Limit (dBuV/m)	Margin (dB)	Factor (dB)	Dist (m)	Condition	Azimuth (°)	Height (m)	Comments
2437MHz	Pass	AV	2.4926G	42.99	54.00	-11.01	2.30	3	Horizontal	144	2.24	-
2437MHz	Pass	PK	2.373G	55.93	74.00	-18.07	2.05	3	Horizontal	144	2.24	-
2437MHz	Pass	PK	2.433G	102.74	Inf	-Inf	2.18	3	Horizontal	144	2.24	-
2437MHz	Pass	PK	2.4882G	56.42	74.00	-17.58	2.29	3	Horizontal	144	2.24	-
2437MHz	Pass	AV	2.3834G	43.08	54.00	-10.92	2.08	3	Vertical	86	3.04	-
2437MHz	Pass	AV	2.4362G	85.98	Inf	-Inf	2.19	3	Vertical	86	3.04	-
2437MHz	Pass	AV	2.489G	43.16	54.00	-10.84	2.29	3	Vertical	86	3.04	-
2437MHz	Pass	PK	2.3742G	55.94	74.00	-18.06	2.05	3	Vertical	86	3.04	-
2437MHz	Pass	PK	2.4362G	102.77	Inf	-Inf	2.19	3	Vertical	86	3.04	-
2437MHz	Pass	PK	2.497G	56.02	74.00	-17.98	2.30	3	Vertical	86	3.04	-
2437MHz	Pass	AV	4.874G	36.12	54.00	-17.88	6.82	3	Horizontal	360	1.50	-
2437MHz	Pass	PK	4.874G	50.22	74.00	-23.78	6.82	3	Horizontal	360	1.50	-
2437MHz	Pass	AV	4.874G	36.03	54.00	-17.97	6.82	3	Vertical	0	1.50	-
2437MHz	Pass	PK	4.874G	50.58	74.00	-23.42	6.82	3	Vertical	0	1.50	-
2462MHz	Pass	AV	2.4632G	82.34	Inf	-Inf	2.24	3	Horizontal	146	2.76	-
2462MHz	Pass	AV	2.483502G	43.16	54.00	-10.84	2.28	3	Horizontal	146	2.76	-
2462MHz	Pass	PK	2.4602G	99.27	Inf	-Inf	2.23	3	Horizontal	146	2.76	-
2462MHz	Pass	PK	2.4838G	56.47	74.00	-17.53	2.28	3	Horizontal	146	2.76	-
2462MHz	Pass	AV	2.4608G	82.83	Inf	-Inf	2.24	3	Vertical	77	2.78	-
2462MHz	Pass	AV	2.485G	43.02	54.00	-10.98	2.28	3	Vertical	77	2.78	-
2462MHz	Pass	PK	2.4606G	99.32	Inf	-Inf	2.24	3	Vertical	77	2.78	-
2462MHz	Pass	PK	2.4916G	56.42	74.00	-17.58	2.29	3	Vertical	77	2.78	-
2462MHz	Pass	AV	4.924G	36.03	54.00	-17.97	6.92	3	Horizontal	360	1.50	-
2462MHz	Pass	PK	4.924G	49.70	74.00	-24.30	6.92	3	Horizontal	360	1.50	-
2462MHz	Pass	AV	4.924G	36.08	54.00	-17.92	6.92	3	Vertical	0	1.50	-
2462MHz	Pass	PK	4.924G	49.98	74.00	-24.02	6.92	3	Vertical	0	1.50	-
802.11n HT40_Nss1,(MCS0)_1TX	-	-	-	-	-	-	-	-	-	-	-	-
2422MHz	Pass	AV	2.39G	44.42	54.00	-9.58	2.09	3	Horizontal	155	2.34	-
2422MHz	Pass	AV	2.418G	78.44	Inf	-Inf	2.15	3	Horizontal	155	2.34	-
2422MHz	Pass	AV	2.4984G	42.90	54.00	-11.10	2.31	3	Horizontal	155	2.34	-
2422MHz	Pass	PK	2.3896G	60.47	74.00	-13.53	2.09	3	Horizontal	155	2.34	-
2422MHz	Pass	PK	2.4208G	93.35	Inf	-Inf	2.16	3	Horizontal	155	2.34	-
2422MHz	Pass	PK	2.4856G	55.56	74.00	-18.44	2.28	3	Horizontal	155	2.34	-
2422MHz	Pass	AV	2.39G	43.84	54.00	-10.16	2.09	3	Vertical	89	3.00	-
2422MHz	Pass	AV	2.4248G	78.25	Inf	-Inf	2.17	3	Vertical	89	3.00	-
2422MHz	Pass	AV	2.5G	43.02	54.00	-10.98	2.31	3	Vertical	89	3.00	-
2422MHz	Pass	PK	2.39G	58.23	74.00	-15.77	2.09	3	Vertical	89	3.00	-
2422MHz	Pass	PK	2.426G	94.05	Inf	-Inf	2.17	3	Vertical	89	3.00	-
2422MHz	Pass	PK	2.4924G	55.19	74.00	-18.81	2.30	3	Vertical	89	3.00	-
2422MHz	Pass	AV	4.844G	36.40	54.00	-17.60	6.76	3	Horizontal	0	1.50	-
2422MHz	Pass	PK	4.844G	49.24	74.00	-24.76	6.76	3	Horizontal	0	1.50	-
2422MHz	Pass	AV	4.844G	36.26	54.00	-17.74	6.76	3	Vertical	360	1.50	-
2422MHz	Pass	PK	4.844G	49.36	74.00	-24.64	6.76	3	Vertical	360	1.50	-
2437MHz	Pass	AV	2.389998G	44.82	54.00	-9.18	2.09	3	Horizontal	312	1.69	-
2437MHz	Pass	AV	2.4322G	80.87	Inf	-Inf	2.18	3	Horizontal	312	1.69	-
2437MHz	Pass	AV	2.483502G	44.28	54.00	-9.72	2.28	3	Horizontal	312	1.69	-
2437MHz	Pass	PK	2.389998G	62.22	74.00	-11.78	2.09	3	Horizontal	312	1.69	-
2437MHz	Pass	PK	2.431G	96.92	Inf	-Inf	2.18	3	Horizontal	312	1.69	-
2437MHz	Pass	PK	2.483502G	60.99	74.00	-13.01	2.28	3	Horizontal	312	1.69	-



RSE TX above 1GHz Result

Appendix F.2

Mode	Result	Type	Freq (Hz)	Level (dBuV/m)	Limit (dBuV/m)	Margin (dB)	Factor (dB)	Dist (m)	Condition	Azimuth (°)	Height (m)	Comments
2437MHz	Pass	AV	2.389998G	45.75	54.00	-8.25	2.09	3	Vertical	84	3.00	-
2437MHz	Pass	AV	2.4342G	82.77	Inf	-Inf	2.18	3	Vertical	84	3.00	-
2437MHz	Pass	AV	2.483502G	45.98	54.00	-8.02	2.28	3	Vertical	84	3.00	-
2437MHz	Pass	PK	2.389998G	65.17	74.00	-8.83	2.09	3	Vertical	84	3.00	-
2437MHz	Pass	PK	2.429G	98.96	Inf	-Inf	2.18	3	Vertical	84	3.00	-
2437MHz	Pass	PK	2.4838G	63.09	74.00	-10.91	2.28	3	Vertical	84	3.00	-
2437MHz	Pass	AV	4.874G	36.64	54.00	-17.36	6.82	3	Horizontal	0	1.50	-
2437MHz	Pass	PK	4.874G	50.47	74.00	-23.53	6.82	3	Horizontal	0	1.50	-
2437MHz	Pass	AV	4.874G	36.58	54.00	-17.42	6.82	3	Vertical	360	1.50	-
2437MHz	Pass	PK	4.874G	50.17	74.00	-23.83	6.82	3	Vertical	360	1.50	-
2452MHz	Pass	AV	2.384G	42.95	54.00	-11.05	2.08	3	Horizontal	126	2.06	-
2452MHz	Pass	AV	2.454G	77.31	Inf	-Inf	2.22	3	Horizontal	126	2.06	-
2452MHz	Pass	AV	2.4844G	43.67	54.00	-10.33	2.28	3	Horizontal	126	2.06	-
2452MHz	Pass	PK	2.3556G	56.69	74.00	-17.31	2.00	3	Horizontal	126	2.06	-
2452MHz	Pass	PK	2.4544G	92.83	Inf	-Inf	2.22	3	Horizontal	126	2.06	-
2452MHz	Pass	PK	2.4836G	57.82	74.00	-16.18	2.28	3	Horizontal	126	2.06	-
2452MHz	Pass	AV	2.3788G	42.92	54.00	-11.08	2.06	3	Vertical	92	1.91	-
2452MHz	Pass	AV	2.4492G	79.42	Inf	-Inf	2.21	3	Vertical	92	1.91	-
2452MHz	Pass	AV	2.4888G	43.78	54.00	-10.22	2.29	3	Vertical	92	1.91	-
2452MHz	Pass	PK	2.3868G	56.54	74.00	-17.46	2.08	3	Vertical	92	1.91	-
2452MHz	Pass	PK	2.4472G	94.99	Inf	-Inf	2.21	3	Vertical	92	1.91	-
2452MHz	Pass	PK	2.4836G	59.09	74.00	-14.91	2.28	3	Vertical	92	1.91	-
2452MHz	Pass	AV	4.904G	36.19	54.00	-17.81	6.88	3	Horizontal	360	1.50	-
2452MHz	Pass	PK	4.904G	49.81	74.00	-24.19	6.88	3	Horizontal	360	1.50	-
2452MHz	Pass	AV	4.904G	36.22	54.00	-17.78	6.88	3	Vertical	0	1.50	-
2452MHz	Pass	PK	4.904G	50.34	74.00	-23.66	6.88	3	Vertical	0	1.50	-

802.11b_(1Mbps)_1TX

2412MHz_TX

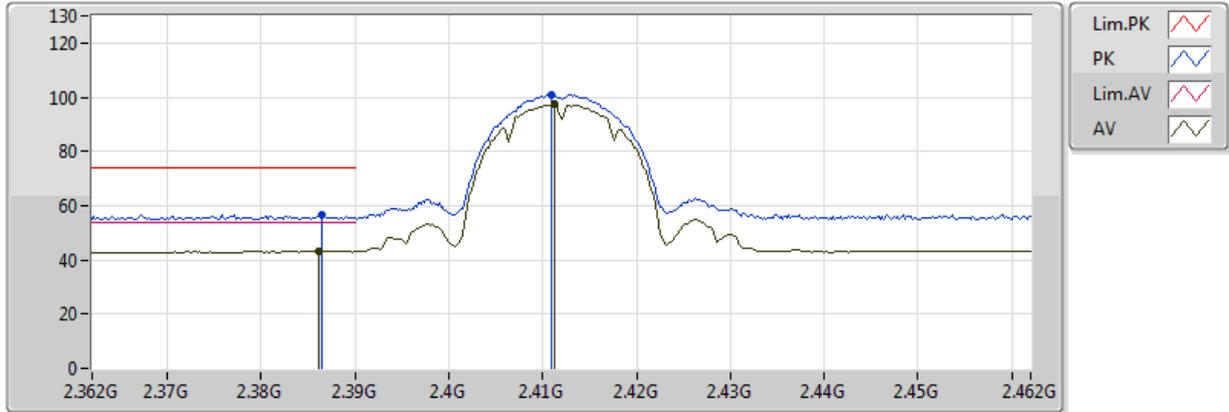

EUT = Z axis

Type	Freq (Hz)	Level (dBuV/m)	Limit (dBuV/m)	Margin (dB)	Factor (dB)	Dist (m)	Condition	Azimuth (°)	Height (m)	Comments	Raw (dBuV)	AF (dB)	CL (dB)	PA (dB)
AV	2.3862G	43.39	54.00	-10.61	2.08	3	Vertical	85	2.44	-	41.31	32.16	5.18	35.26
AV	2.4112G	97.25	Inf	-Inf	2.14	3	Vertical	85	2.44	-	95.11	32.19	5.21	35.26
PK	2.3864G	56.77	74.00	-17.23	2.08	3	Vertical	85	2.44	-	54.69	32.16	5.18	35.26
PK	2.411G	101.07	Inf	-Inf	2.14	3	Vertical	85	2.44	-	98.93	32.19	5.21	35.26

802.11b_(1Mbps)_1TX

2412MHz_TX

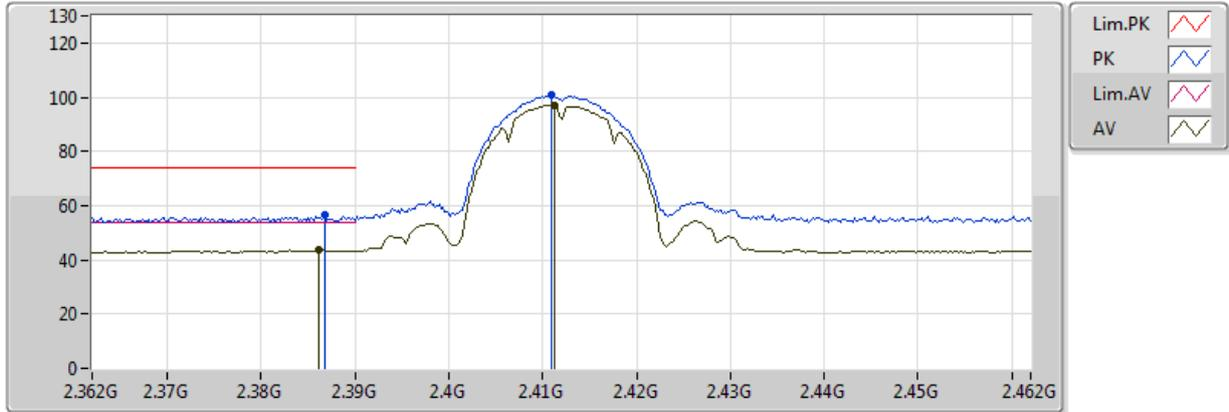

EUT = Z axis

Type	Freq (Hz)	Level (dBuV/m)	Limit (dBuV/m)	Margin (dB)	Factor (dB)	Dist (m)	Condition	Azimuth (°)	Height (m)	Comments	Raw (dBuV)	AF (dB)	CL (dB)	PA (dB)
AV	2.3862G	43.65	54.00	-10.35	2.08	3	Horizontal	157	2.42	-	41.57	32.16	5.18	35.26
AV	2.4112G	97.04	Inf	-Inf	2.14	3	Horizontal	157	2.42	-	94.90	32.19	5.21	35.26
PK	2.3868G	56.80	74.00	-17.20	2.08	3	Horizontal	157	2.42	-	54.71	32.16	5.18	35.26
PK	2.411G	100.78	Inf	-Inf	2.14	3	Horizontal	157	2.42	-	98.64	32.19	5.21	35.26

802.11b_(1Mbps)_1TX

2412MHz_TX

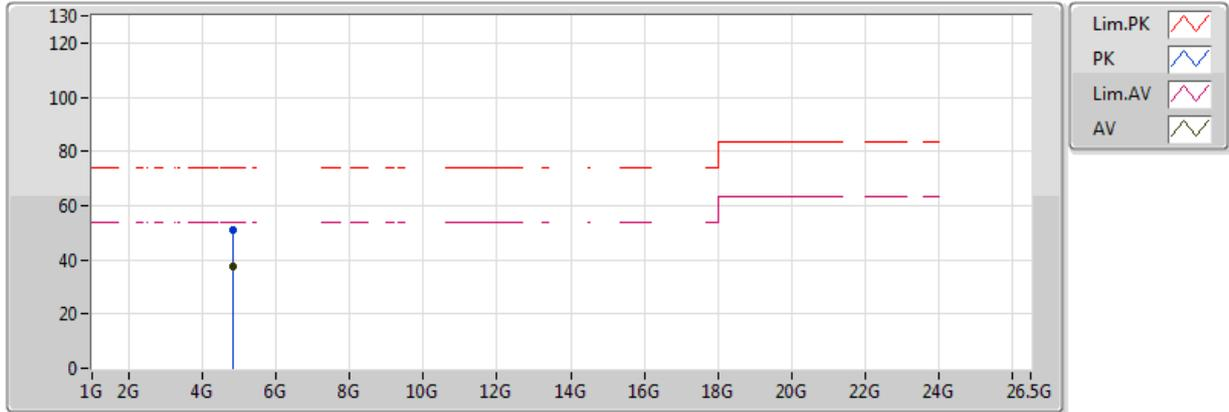

EUT = Z axis

Type	Freq (Hz)	Level (dBuV/m)	Limit (dBuV/m)	Margin (dB)	Factor (dB)	Dist (m)	Condition	Azimuth (°)	Height (m)	Comments	Raw (dBuV)	AF (dB)	CL (dB)	PA (dB)
AV	4.824G	37.33	54.00	-16.67	6.73	3	Vertical	0	1.50	-	30.60	34.23	7.37	34.87
PK	4.824G	51.23	74.00	-22.77	6.73	3	Vertical	0	1.50	-	44.50	34.23	7.37	34.87

802.11b_(1Mbps)_1TX

2412MHz_TX

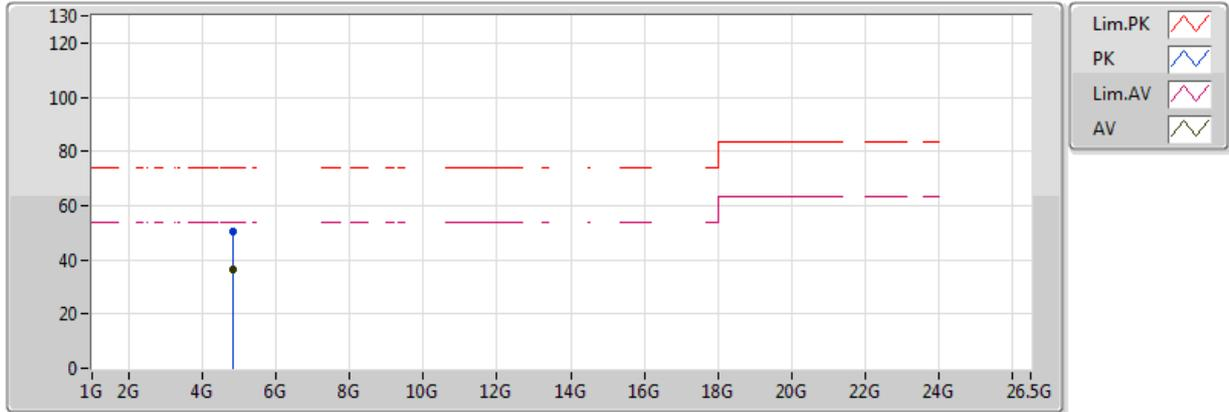

EUT = Z axis

Type	Freq (Hz)	Level (dBuV/m)	Limit (dBuV/m)	Margin (dB)	Factor (dB)	Dist (m)	Condition	Azimuth (°)	Height (m)	Comments	Raw (dBuV)	AF (dB)	CL (dB)	PA (dB)
AV	4.824G	36.42	54.00	-17.58	6.73	3	Horizontal	360	1.50	-	29.69	34.23	7.37	34.87
PK	4.824G	50.23	74.00	-23.77	6.73	3	Horizontal	360	1.50	-	43.50	34.23	7.37	34.87

802.11b_(1Mbps)_1TX

2437MHz_TX

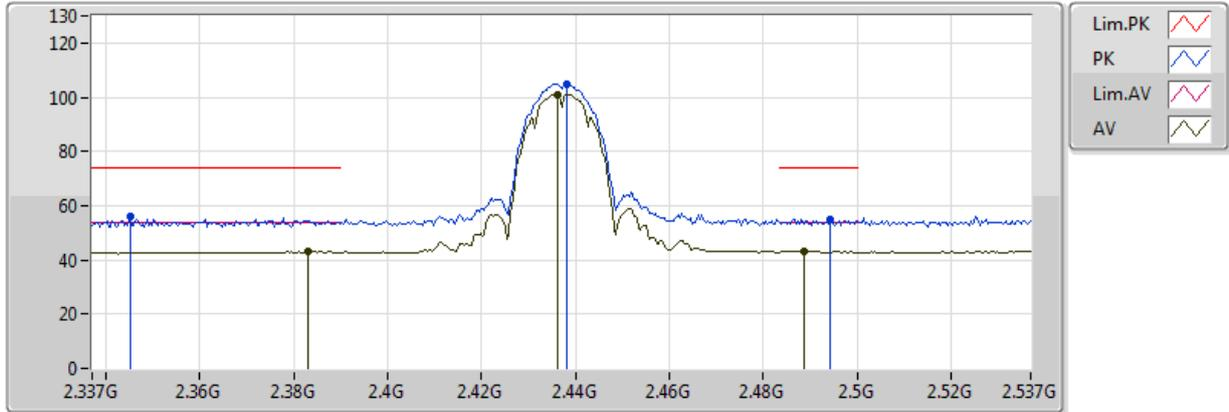

EUT = Z axis

Type	Freq (Hz)	Level (dBuV/m)	Limit (dBuV/m)	Margin (dB)	Factor (dB)	Dist (m)	Condition	Azimuth (°)	Height (m)	Comments	Raw (dBuV)	AF (dB)	CL (dB)	PA (dB)
AV	2.383G	43.00	54.00	-11.00	2.07	3	Vertical	92	3.02	-	40.92	32.16	5.17	35.26
AV	2.4362G	101.11	Inf	-Inf	2.19	3	Vertical	92	3.02	-	98.92	32.22	5.23	35.27
AV	2.4886G	43.19	54.00	-10.81	2.29	3	Vertical	92	3.02	-	40.90	32.29	5.28	35.28
PK	2.345G	56.07	74.00	-17.93	1.97	3	Vertical	92	3.02	-	54.10	32.11	5.12	35.25
PK	2.4382G	104.99	Inf	-Inf	2.19	3	Vertical	92	3.02	-	102.80	32.23	5.23	35.27
PK	2.4942G	55.09	74.00	-18.91	2.30	3	Vertical	92	3.02	-	52.79	32.29	5.28	35.28

802.11b_(1Mbps)_1TX

2437MHz_TX

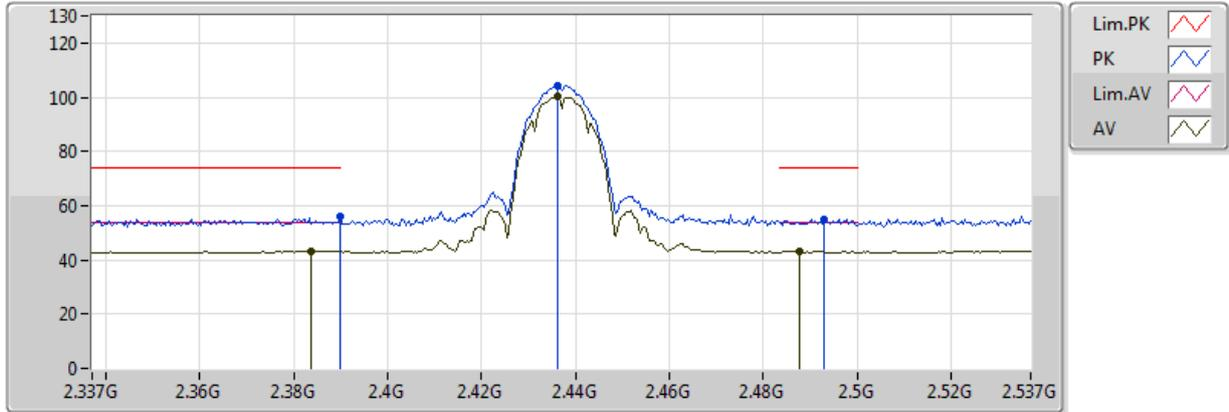

EUT = Z axis

Type	Freq (Hz)	Level (dBuV/m)	Limit (dBuV/m)	Margin (dB)	Factor (dB)	Dist (m)	Condition	Azimuth (°)	Height (m)	Comments	Raw (dBuV)	AF (dB)	CL (dB)	PA (dB)
AV	2.3838G	43.26	54.00	-10.74	2.08	3	Horizontal	159	2.09	-	41.18	32.16	5.18	35.26
AV	2.4362G	100.29	Inf	-Inf	2.19	3	Horizontal	159	2.09	-	98.10	32.22	5.23	35.27
AV	2.4878G	42.98	54.00	-11.02	2.29	3	Horizontal	159	2.09	-	40.70	32.29	5.28	35.28
PK	2.389998G	55.85	74.00	-18.15	2.09	3	Horizontal	159	2.09	-	53.75	32.17	5.18	35.26
PK	2.4362G	104.08	Inf	-Inf	2.19	3	Horizontal	159	2.09	-	101.89	32.22	5.23	35.27
PK	2.493G	55.01	74.00	-18.99	2.30	3	Horizontal	159	2.09	-	52.71	32.29	5.28	35.28

802.11b_(1Mbps)_1TX

2437MHz_TX

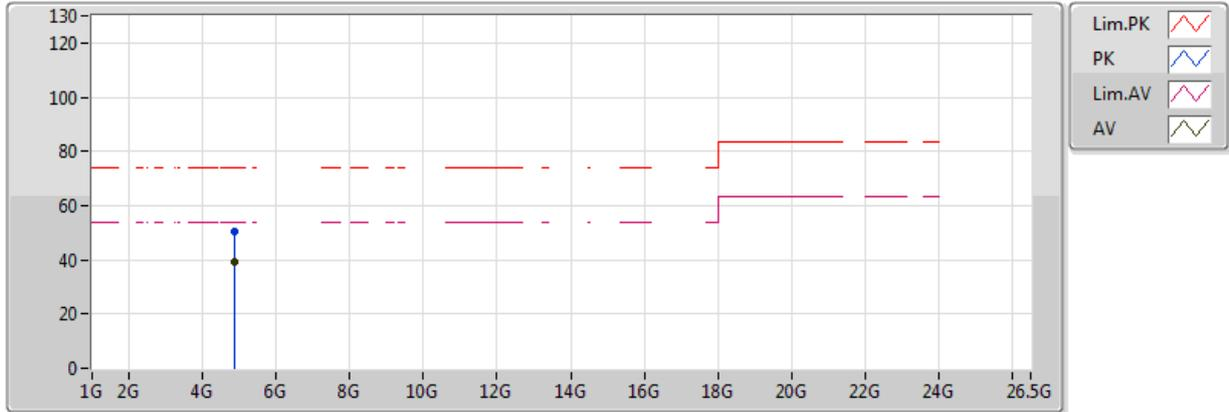

EUT = Z axis

Type	Freq (Hz)	Level (dBuV/m)	Limit (dBuV/m)	Margin (dB)	Factor (dB)	Dist (m)	Condition	Azimuth (°)	Height (m)	Comments	Raw (dBuV)	AF (dB)	CL (dB)	PA (dB)
AV	4.874G	39.32	54.00	-14.68	6.82	3	Vertical	288	1.92	-	32.50	34.25	7.43	34.86
PK	4.874G	50.40	74.00	-23.60	6.82	3	Vertical	288	1.92	-	43.58	34.25	7.43	34.86

802.11b_(1Mbps)_1TX

2437MHz_TX

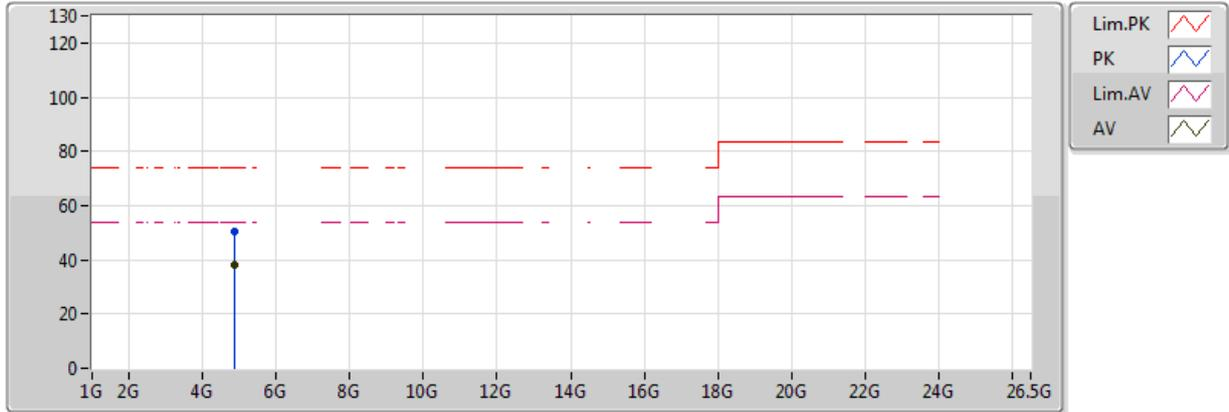

EUT = Z axis

Type	Freq (Hz)	Level (dBuV/m)	Limit (dBuV/m)	Margin (dB)	Factor (dB)	Dist (m)	Condition	Azimuth (°)	Height (m)	Comments	Raw (dBuV)	AF (dB)	CL (dB)	PA (dB)
AV	4.874G	38.35	54.00	-15.65	6.82	3	Horizontal	360	1.50	-	31.53	34.25	7.43	34.86
PK	4.874G	50.19	74.00	-23.81	6.82	3	Horizontal	360	1.50	-	43.37	34.25	7.43	34.86

802.11b_(1Mbps)_1TX

2462MHz_TX

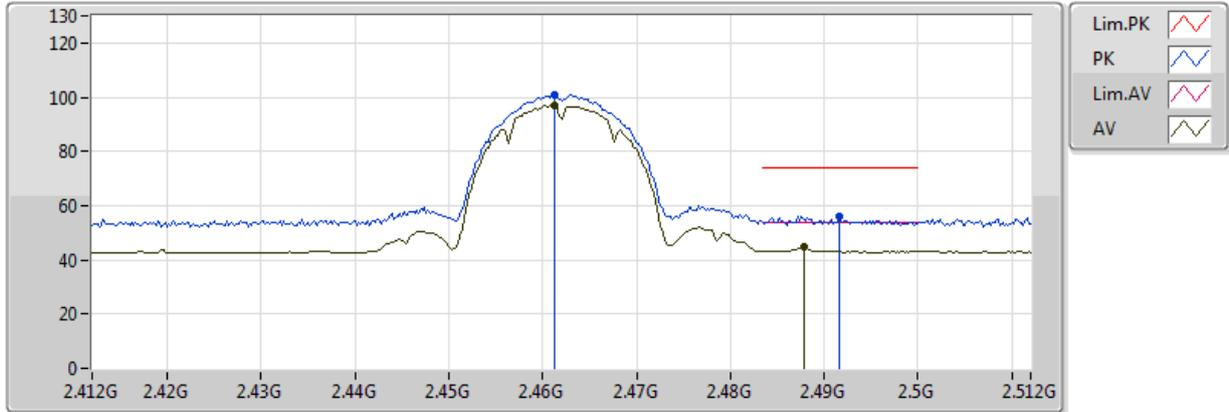

EUT = Z axis

Type	Freq (Hz)	Level (dBuV/m)	Limit (dBuV/m)	Margin (dB)	Factor (dB)	Dist (m)	Condition	Azimuth (°)	Height (m)	Comments	Raw (dBuV)	AF (dB)	CL (dB)	PA (dB)
AV	2.4612G	96.95	Inf	-Inf	2.24	3	Vertical	91	2.85	-	94.71	32.25	5.26	35.27
AV	2.4878G	44.91	54.00	-9.09	2.29	3	Vertical	91	2.85	-	42.62	32.29	5.28	35.28
PK	2.4612G	100.69	Inf	-Inf	2.24	3	Vertical	91	2.85	-	98.46	32.25	5.26	35.27
PK	2.4916G	56.24	74.00	-17.76	2.29	3	Vertical	91	2.85	-	53.95	32.29	5.28	35.28

802.11b_(1Mbps)_1TX

2462MHz_TX

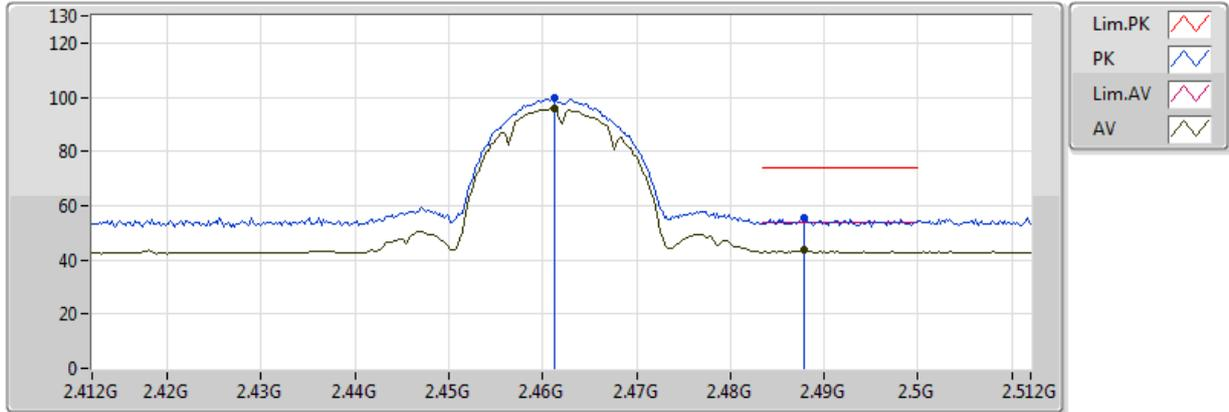

EUT = Z axis

Type	Freq (Hz)	Level (dBuV/m)	Limit (dBuV/m)	Margin (dB)	Factor (dB)	Dist (m)	Condition	Azimuth (°)	Height (m)	Comments	Raw (dBuV)	AF (dB)	CL (dB)	PA (dB)
AV	2.4612G	95.71	Inf	-Inf	2.24	3	Horizontal	148	2.40	-	93.47	32.25	5.26	35.27
AV	2.4878G	43.72	54.00	-10.28	2.29	3	Horizontal	148	2.40	-	41.43	32.29	5.28	35.28
PK	2.4612G	99.47	Inf	-Inf	2.24	3	Horizontal	148	2.40	-	97.24	32.25	5.26	35.27
PK	2.4878G	55.46	74.00	-18.54	2.29	3	Horizontal	148	2.40	-	53.17	32.29	5.28	35.28

802.11b_(1Mbps)_1TX

2462MHz_TX

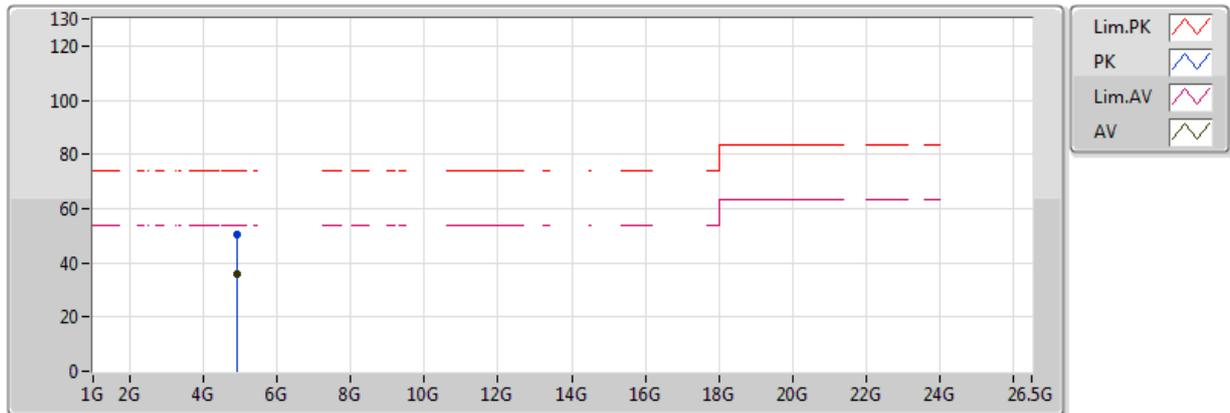

EUT = Z axis

Type	Freq (Hz)	Level (dBuV/m)	Limit (dBuV/m)	Margin (dB)	Factor (dB)	Dist (m)	Condition	Azimuth (°)	Height (m)	Comments	Raw (dBuV)	AF (dB)	CL (dB)	PA (dB)
AV	4.924G	36.09	54.00	-17.91	6.92	3	Vertical	360	1.50	-	29.17	34.27	7.49	34.84
PK	4.924G	50.60	74.00	-23.40	6.92	3	Vertical	360	1.50	-	43.68	34.27	7.49	34.84

802.11b_(1Mbps)_1TX

2462MHz_TX

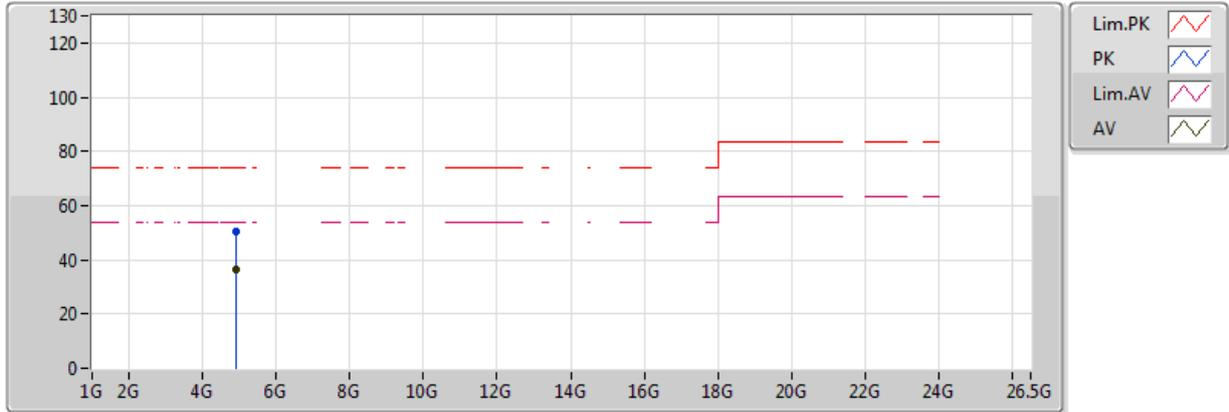

EUT = Z axis

Type	Freq (Hz)	Level (dBuV/m)	Limit (dBuV/m)	Margin (dB)	Factor (dB)	Dist (m)	Condition	Azimuth (°)	Height (m)	Comments	Raw (dBuV)	AF (dB)	CL (dB)	PA (dB)
AV	4.924G	36.19	54.00	-17.81	6.92	3	Horizontal	0	1.50	-	29.27	34.27	7.49	34.84
PK	4.924G	50.43	74.00	-23.57	6.92	3	Horizontal	0	1.50	-	43.51	34.27	7.49	34.84

802.11g_(6Mbps)_1TX

2412MHz_TX

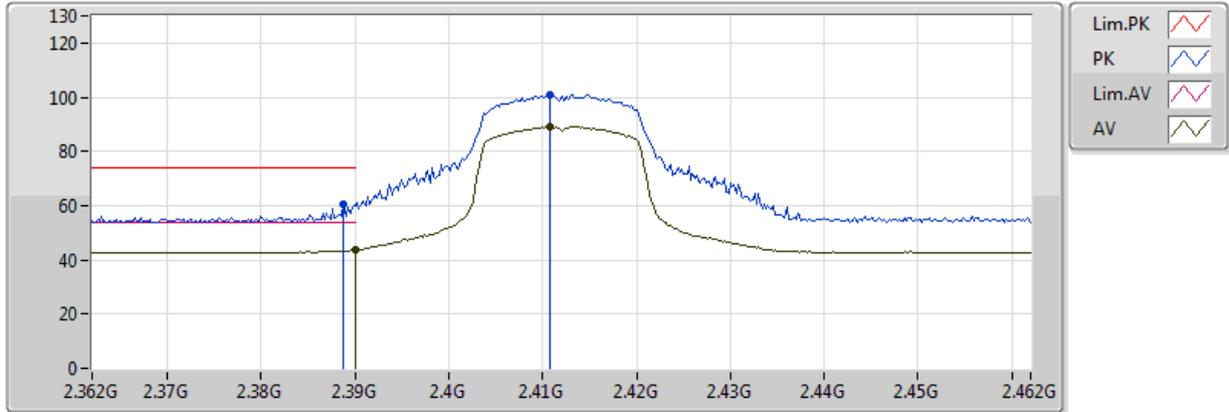

EUT = Z axis

Type	Freq (Hz)	Level (dBuV/m)	Limit (dBuV/m)	Margin (dB)	Factor (dB)	Dist (m)	Condition	Azimuth (°)	Height (m)	Comments	Raw (dBuV)	AF (dB)	CL (dB)	PA (dB)
AV	2.4108G	89.02	Inf	-Inf	2.14	3	Vertical	85	2.45	-	86.88	32.19	5.21	35.26
AV	2.39G	43.64	54.00	-10.36	2.09	3	Vertical	85	2.45	-	41.54	32.17	5.18	35.26
PK	2.4108G	100.88	Inf	-Inf	2.14	3	Vertical	85	2.45	-	98.74	32.19	5.21	35.26
PK	2.3888G	60.75	74.00	-13.25	2.09	3	Vertical	85	2.45	-	58.66	32.17	5.18	35.26



802.11g_(6Mbps)_1TX

2412MHz_TX

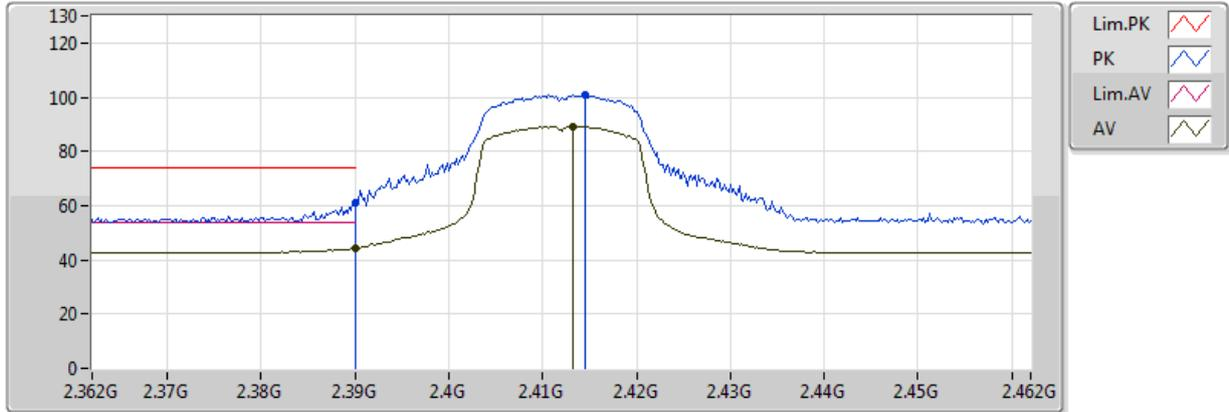

EUT = Z axis

Type	Freq (Hz)	Level (dBuV/m)	Limit (dBuV/m)	Margin (dB)	Factor (dB)	Dist (m)	Condition	Azimuth (°)	Height (m)	Comments	Raw (dBuV)	AF (dB)	CL (dB)	PA (dB)
AV	2.4132G	89.20	Inf	-Inf	2.15	3	Horizontal	157	2.30	-	87.05	32.20	5.21	35.26
AV	2.39G	44.12	54.00	-9.88	2.09	3	Horizontal	157	2.30	-	42.03	32.17	5.18	35.26
PK	2.4146G	100.87	Inf	-Inf	2.15	3	Horizontal	157	2.30	-	98.72	32.20	5.21	35.26
PK	2.39G	61.22	74.00	-12.78	2.09	3	Horizontal	157	2.30	-	59.13	32.17	5.18	35.26

802.11g_(6Mbps)_1TX

2412MHz_TX

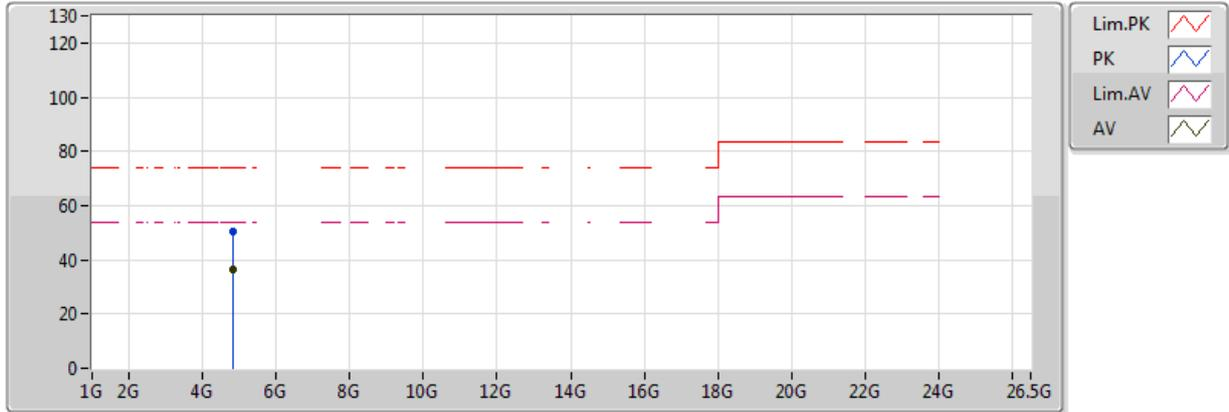

EUT = Z axis

Type	Freq (Hz)	Level (dBuV/m)	Limit (dBuV/m)	Margin (dB)	Factor (dB)	Dist (m)	Condition	Azimuth (°)	Height (m)	Comments	Raw (dBuV)	AF (dB)	CL (dB)	PA (dB)
AV	4.824G	36.39	54.00	-17.61	6.73	3	Vertical	360	1.50	-	29.66	34.23	7.37	34.87
PK	4.824G	50.23	74.00	-23.77	6.73	3	Vertical	360	1.50	-	43.50	34.23	7.37	34.87

802.11g_(6Mbps)_1TX

2412MHz_TX

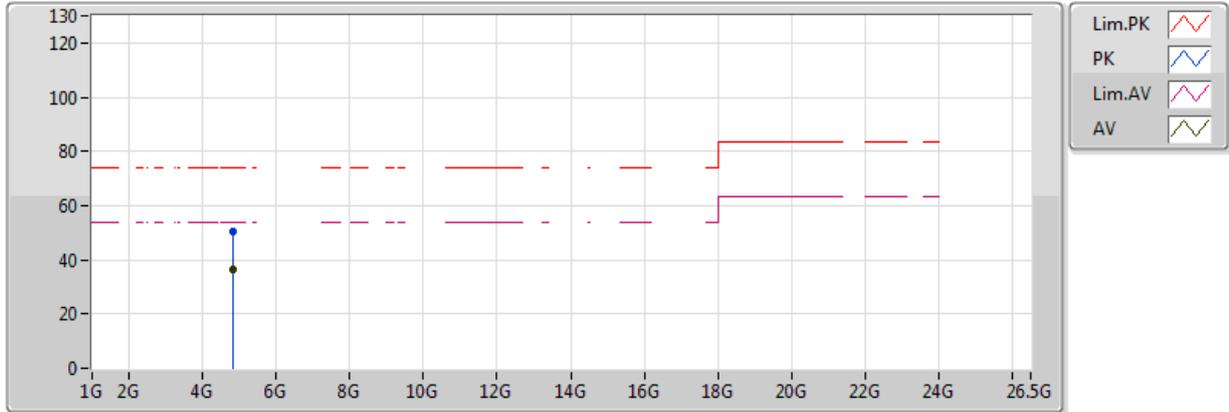

EUT = Z axis

Type	Freq (Hz)	Level (dBuV/m)	Limit (dBuV/m)	Margin (dB)	Factor (dB)	Dist (m)	Condition	Azimuth (°)	Height (m)	Comments	Raw (dBuV)	AF (dB)	CL (dB)	PA (dB)
AV	4.824G	36.52	54.00	-17.48	6.73	3	Horizontal	0	1.50	-	29.79	34.23	7.37	34.87
PK	4.824G	50.26	74.00	-23.74	6.73	3	Horizontal	0	1.50	-	43.53	34.23	7.37	34.87

802.11g_(6Mbps)_1TX

2437MHz_TX

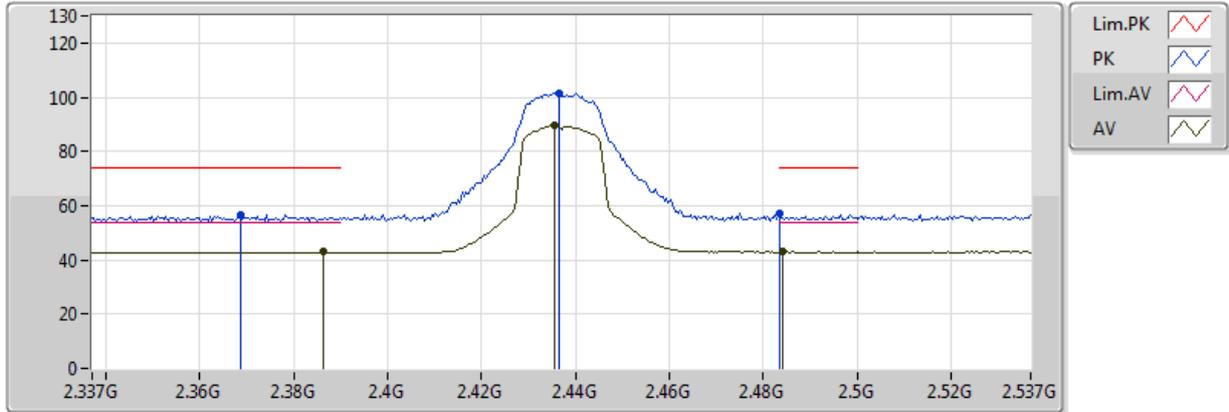

EUT = Z axis

Type	Freq (Hz)	Level (dBuV/m)	Limit (dBuV/m)	Margin (dB)	Factor (dB)	Dist (m)	Condition	Azimuth (°)	Height (m)	Comments	Raw (dBuV)	AF (dB)	CL (dB)	PA (dB)
AV	2.3862G	42.88	54.00	-11.12	2.08	3	Vertical	91	3.01	-	40.79	32.16	5.18	35.26
AV	2.4354G	89.52	Inf	-Inf	2.19	3	Vertical	91	3.01	-	87.33	32.22	5.23	35.27
AV	2.4842G	42.97	54.00	-11.03	2.28	3	Vertical	91	3.01	-	40.69	32.28	5.28	35.28
PK	2.3686G	56.69	74.00	-17.31	2.04	3	Vertical	91	3.01	-	54.66	32.14	5.15	35.26
PK	2.4366G	101.61	Inf	-Inf	2.19	3	Vertical	91	3.01	-	99.42	32.22	5.23	35.27
PK	2.483502G	57.08	74.00	-16.92	2.28	3	Vertical	91	3.01	-	54.80	32.28	5.28	35.28

802.11g_(6Mbps)_1TX

2437MHz_TX

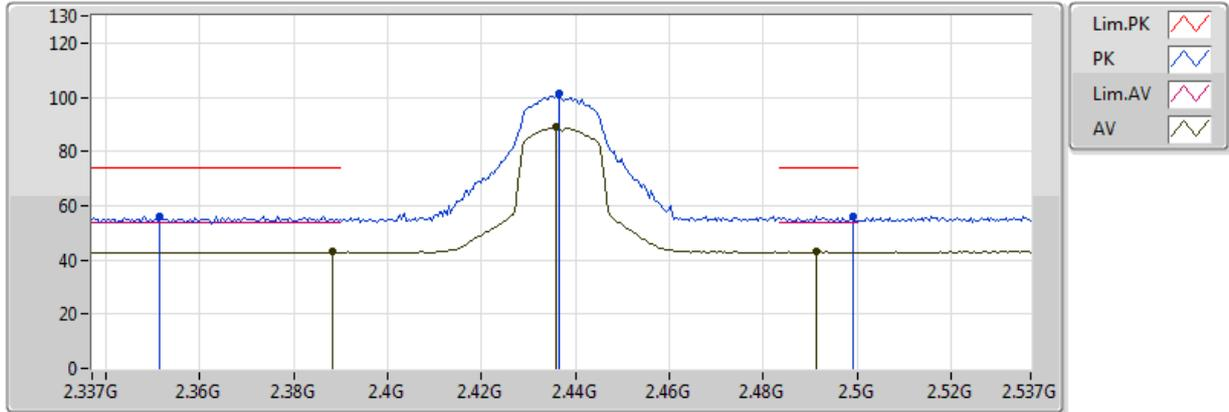

EUT = Z axis

Type	Freq (Hz)	Level (dBuV/m)	Limit (dBuV/m)	Margin (dB)	Factor (dB)	Dist (m)	Condition	Azimuth (°)	Height (m)	Comments	Raw (dBuV)	AF (dB)	CL (dB)	PA (dB)
AV	2.3882G	42.88	54.00	-11.12	2.09	3	Horizontal	159	2.10	-	40.79	32.16	5.18	35.26
AV	2.4358G	88.85	Inf	-Inf	2.19	3	Horizontal	159	2.10	-	86.67	32.22	5.23	35.27
AV	2.4914G	42.91	54.00	-11.09	2.29	3	Horizontal	159	2.10	-	40.62	32.29	5.28	35.28
PK	2.3514G	56.12	74.00	-17.88	1.99	3	Horizontal	159	2.10	-	54.13	32.12	5.13	35.26
PK	2.4366G	101.40	Inf	-Inf	2.19	3	Horizontal	159	2.10	-	99.22	32.22	5.23	35.27
PK	2.499G	56.23	74.00	-17.77	2.31	3	Horizontal	159	2.10	-	53.92	32.30	5.29	35.28

802.11g_(6Mbps)_1TX

2437MHz_TX

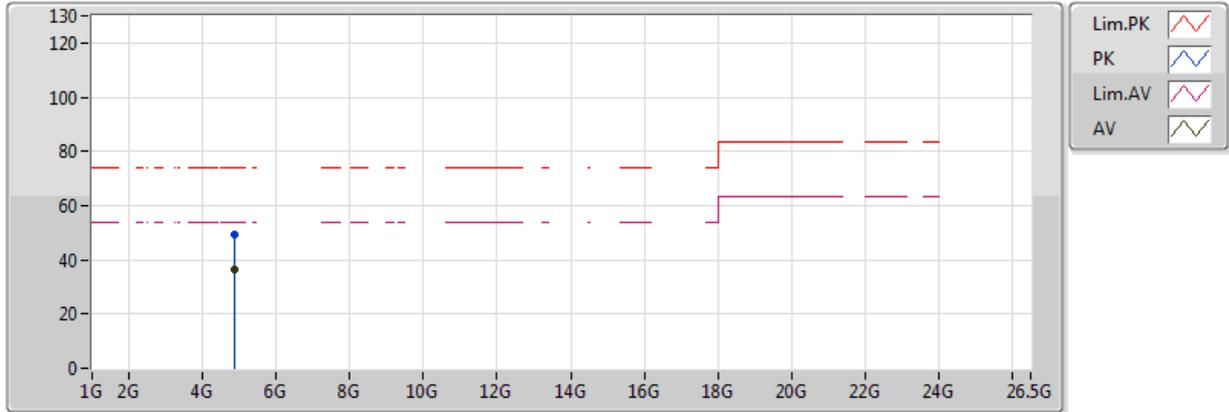

EUT = Z axis

Type	Freq (Hz)	Level (dBuV/m)	Limit (dBuV/m)	Margin (dB)	Factor (dB)	Dist (m)	Condition	Azimuth (°)	Height (m)	Comments	Raw (dBuV)	AF (dB)	CL (dB)	PA (dB)
AV	4.874G	36.65	54.00	-17.35	6.82	3	Vertical	0	1.50	-	29.83	34.25	7.43	34.86
PK	4.874G	49.28	74.00	-24.72	6.82	3	Vertical	0	1.50	-	42.46	34.25	7.43	34.86

802.11g_(6Mbps)_1TX

2437MHz_TX

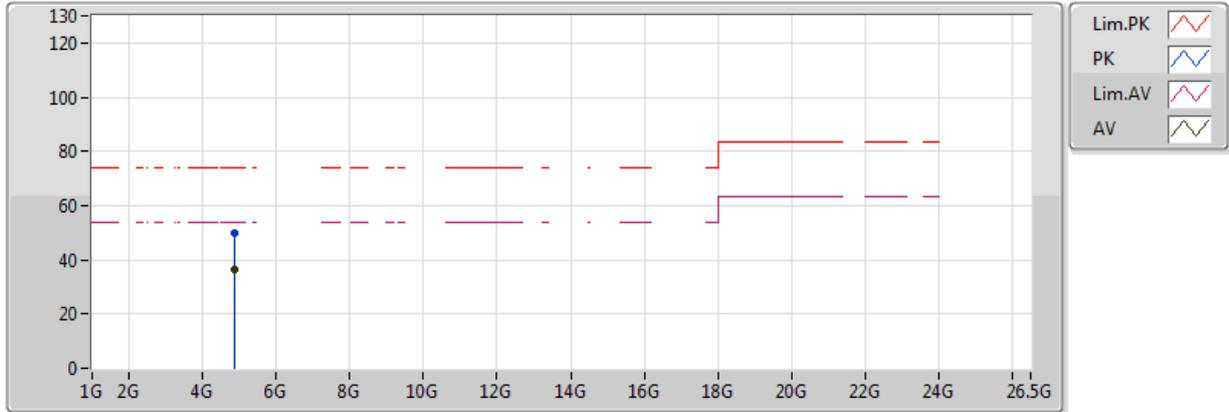

EUT = Z axis

Type	Freq (Hz)	Level (dBuV/m)	Limit (dBuV/m)	Margin (dB)	Factor (dB)	Dist (m)	Condition	Azimuth (°)	Height (m)	Comments	Raw (dBuV)	AF (dB)	CL (dB)	PA (dB)
AV	4.874G	36.63	54.00	-17.37	6.82	3	Horizontal	360	1.50	-	29.81	34.25	7.43	34.86
PK	4.874G	49.92	74.00	-24.08	6.82	3	Horizontal	360	1.50	-	43.10	34.25	7.43	34.86

802.11g_(6Mbps)_1TX

2462MHz_TX

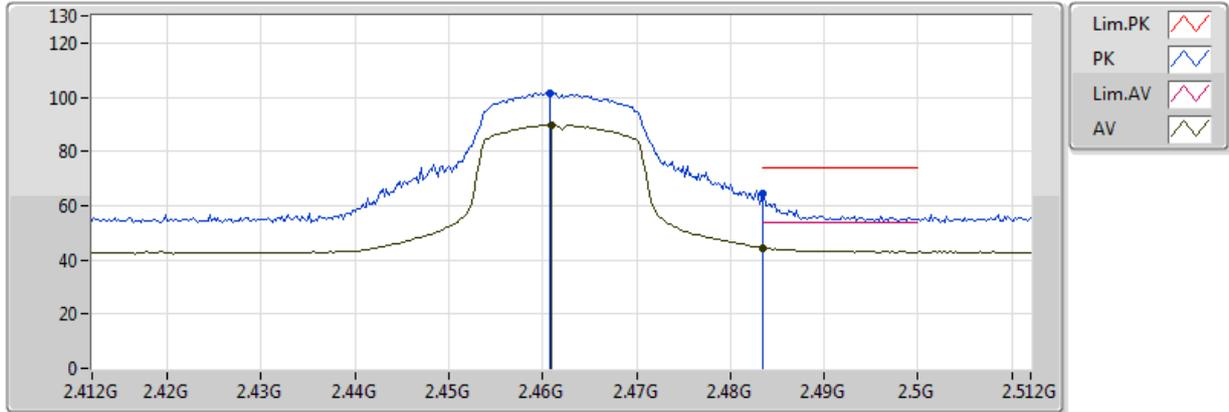

EUT = Z axis

Type	Freq (Hz)	Level (dBuV/m)	Limit (dBuV/m)	Margin (dB)	Factor (dB)	Dist (m)	Condition	Azimuth (°)	Height (m)	Comments	Raw (dBuV)	AF (dB)	CL (dB)	PA (dB)
AV	2.461G	89.79	Inf	-Inf	2.24	3	Vertical	90	2.84	-	87.55	32.25	5.25	35.27
AV	2.483502G	44.46	54.00	-9.54	2.28	3	Vertical	90	2.84	-	42.18	32.28	5.28	35.28
PK	2.4608G	101.69	Inf	-Inf	2.24	3	Vertical	90	2.84	-	99.45	32.25	5.25	35.27
PK	2.483502G	64.42	74.00	-9.58	2.28	3	Vertical	90	2.84	-	62.15	32.28	5.28	35.28

802.11g_(6Mbps)_1TX

2462MHz_TX

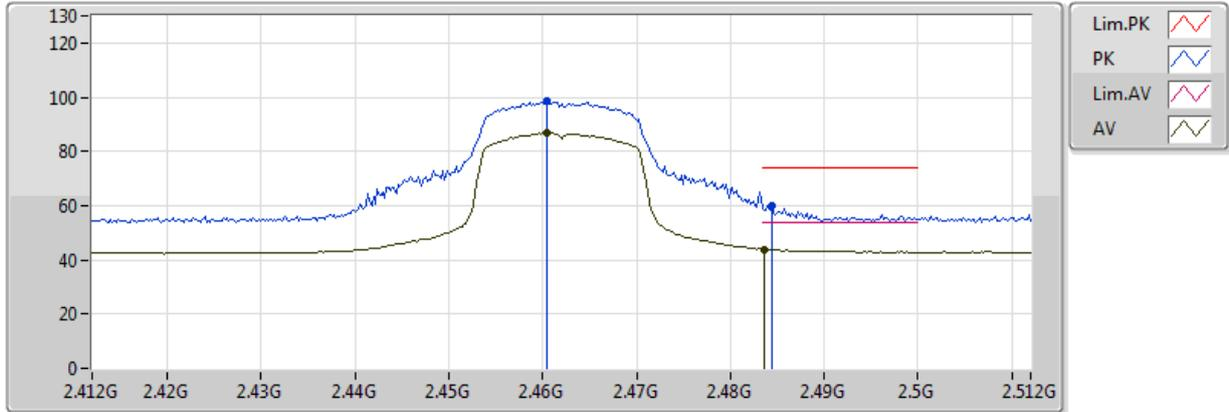

EUT = Z axis

Type	Freq (Hz)	Level (dBuV/m)	Limit (dBuV/m)	Margin (dB)	Factor (dB)	Dist (m)	Condition	Azimuth (°)	Height (m)	Comments	Raw (dBuV)	AF (dB)	CL (dB)	PA (dB)
AV	2.4604G	86.78	Inf	-Inf	2.23	3	Horizontal	126	2.28	-	84.55	32.25	5.25	35.27
AV	2.4836G	43.95	54.00	-10.05	2.28	3	Horizontal	126	2.28	-	41.67	32.28	5.28	35.28
PK	2.4604G	98.80	Inf	-Inf	2.23	3	Horizontal	126	2.28	-	96.57	32.25	5.25	35.27
PK	2.4844G	59.81	74.00	-14.19	2.28	3	Horizontal	126	2.28	-	57.53	32.28	5.28	35.28

802.11g_(6Mbps)_1TX

2462MHz_TX

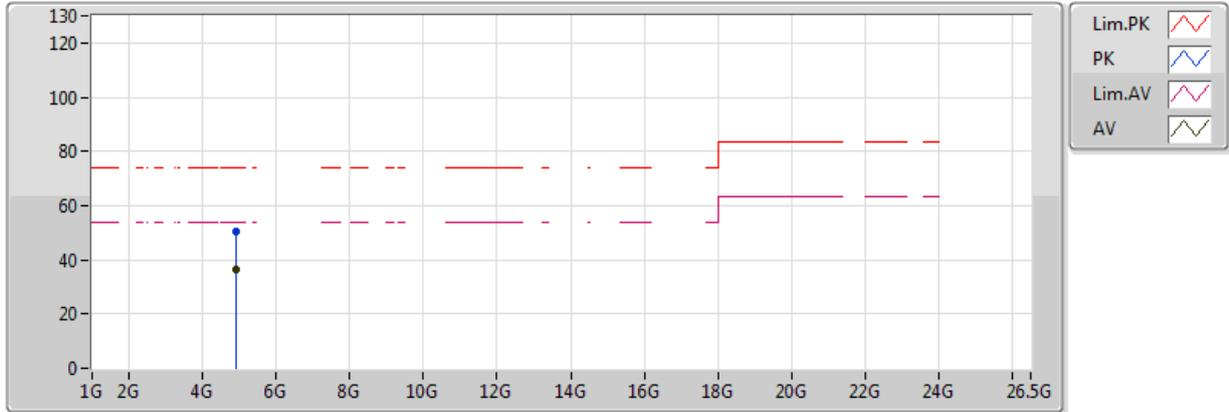

EUT = Z axis

Type	Freq (Hz)	Level (dBuV/m)	Limit (dBuV/m)	Margin (dB)	Factor (dB)	Dist (m)	Condition	Azimuth (°)	Height (m)	Comments	Raw (dBuV)	AF (dB)	CL (dB)	PA (dB)
AV	4.924G	36.61	54.00	-17.39	6.92	3	Vertical	0	1.50	-	29.69	34.27	7.49	34.84
PK	4.924G	50.20	74.00	-23.80	6.92	3	Vertical	0	1.50	-	43.28	34.27	7.49	34.84

802.11g_(6Mbps)_1TX

2462MHz_TX

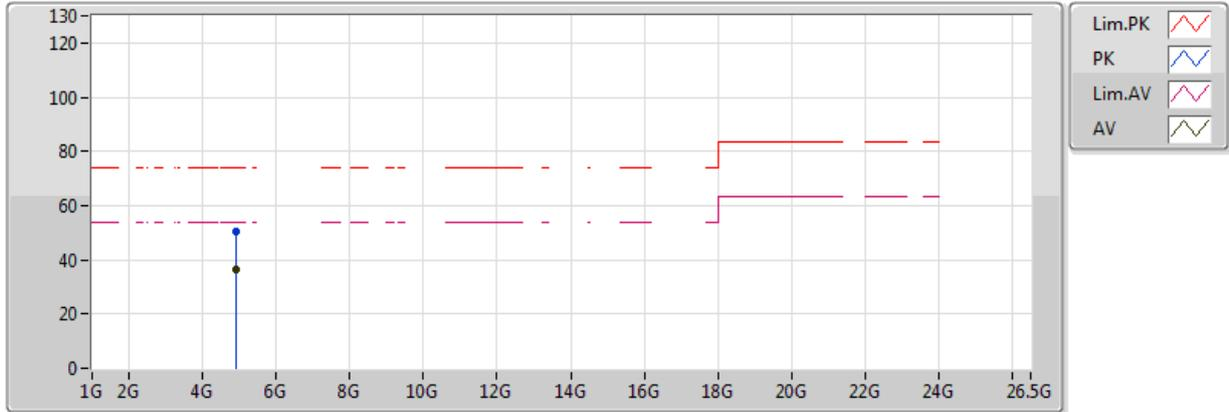

EUT = Z axis

Type	Freq (Hz)	Level (dBuV/m)	Limit (dBuV/m)	Margin (dB)	Factor (dB)	Dist (m)	Condition	Azimuth (°)	Height (m)	Comments	Raw (dBuV)	AF (dB)	CL (dB)	PA (dB)
AV	4.924G	36.48	54.00	-17.52	6.92	3	Horizontal	360	1.50	-	29.56	34.27	7.49	34.84
PK	4.924G	50.45	74.00	-23.55	6.92	3	Horizontal	360	1.50	-	43.53	34.27	7.49	34.84

**802.11n HT20_Nss2,(MCS8)_2TX
2412MHz_TX**

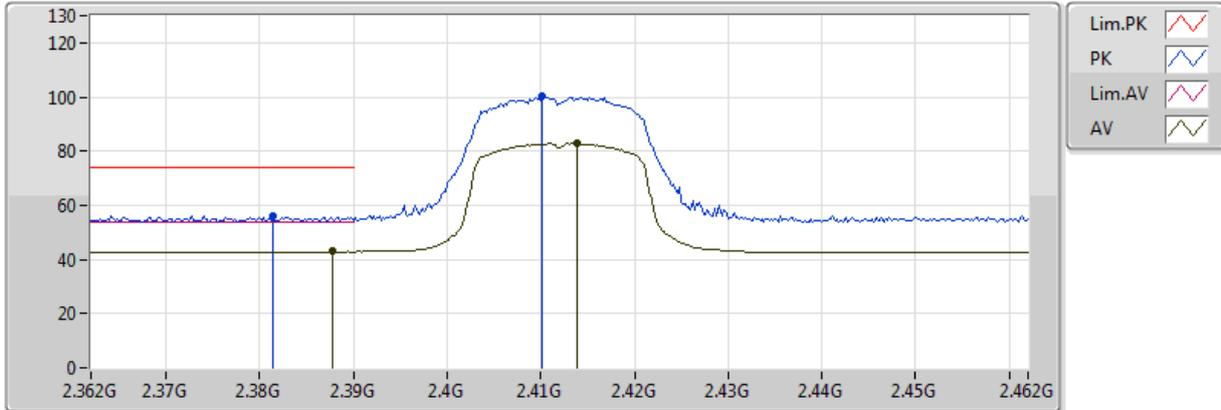

EUT = Z axis

Type	Freq (Hz)	Level (dBuV/m)	Limit (dBuV/m)	Margin (dB)	Factor (dB)	Dist (m)	Condition	Azimuth (°)	Height (m)	Comments	Raw (dBuV)	AF (dB)	CL (dB)	PA (dB)
AV	2.3878G	42.89	54.00	-11.11	2.09	3	Vertical	95	2.09	-	40.81	32.16	5.18	35.26
AV	2.4138G	82.93	Inf	-Inf	2.15	3	Vertical	95	2.09	-	80.78	32.20	5.21	35.26
PK	2.3814G	56.31	74.00	-17.69	2.07	3	Vertical	95	2.09	-	54.24	32.16	5.17	35.26
PK	2.4102G	100.06	Inf	-Inf	2.14	3	Vertical	95	2.09	-	97.93	32.19	5.21	35.26

802.11n HT20_Nss2,(MCS8)_2TX

2412MHz_TX

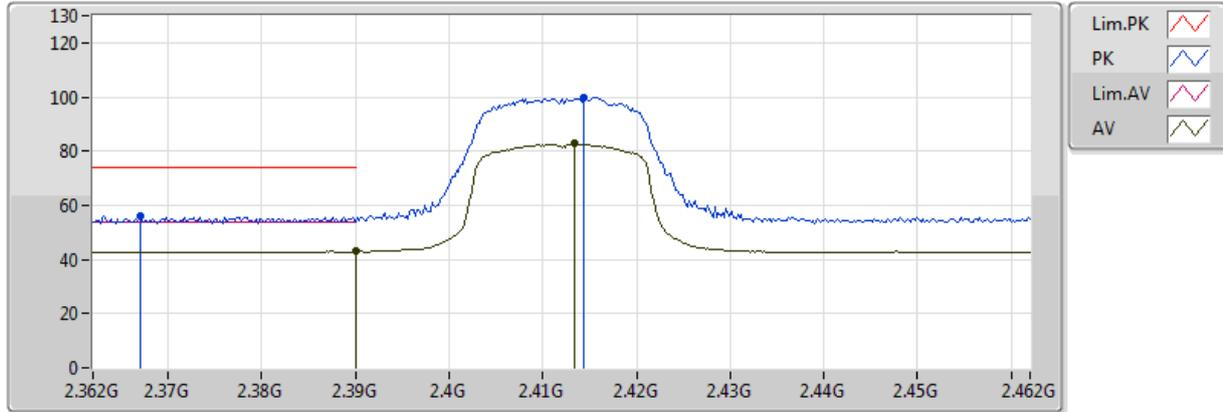

EUT = Z axis

Type	Freq (Hz)	Level (dBuV/m)	Limit (dBuV/m)	Margin (dB)	Factor (dB)	Dist (m)	Condition	Azimuth (°)	Height (m)	Comments	Raw (dBuV)	AF (dB)	CL (dB)	PA (dB)
AV	2.39G	42.97	54.00	-11.03	2.09	3	Horizontal	142	2.10	-	40.88	32.17	5.18	35.26
AV	2.4134G	82.83	Inf	-Inf	2.15	3	Horizontal	142	2.10	-	80.68	32.20	5.21	35.26
PK	2.367G	56.29	74.00	-17.71	2.03	3	Horizontal	142	2.10	-	54.26	32.14	5.15	35.26
PK	2.4144G	100.02	Inf	-Inf	2.15	3	Horizontal	142	2.10	-	97.87	32.20	5.21	35.26

802.11n HT20_Nss2,(MCS8)_2TX

2412MHz_TX

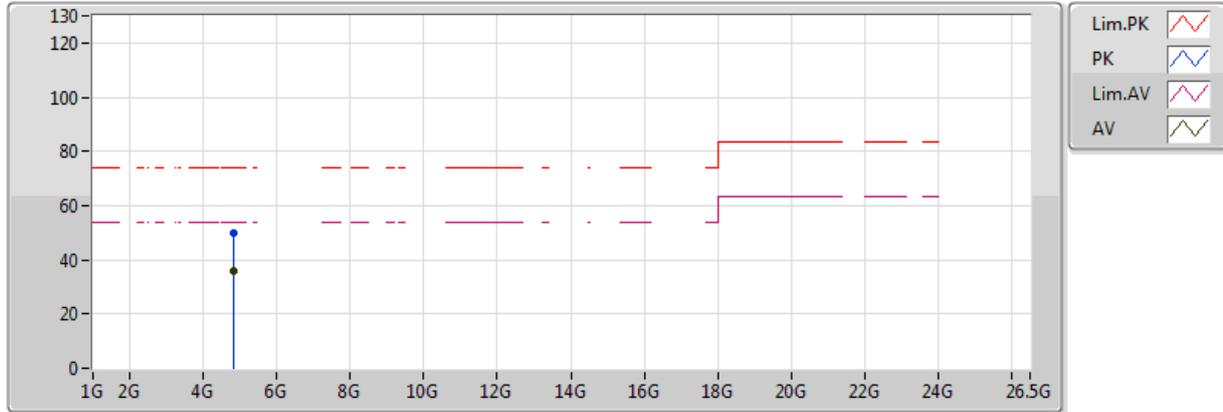

EUT = Z axis

Type	Freq (Hz)	Level (dBuV/m)	Limit (dBuV/m)	Margin (dB)	Factor (dB)	Dist (m)	Condition	Azimuth (°)	Height (m)	Comments	Raw (dBuV)	AF (dB)	CL (dB)	PA (dB)
AV	4.824G	35.86	54.00	-18.14	6.73	3	Vertical	0	1.50	-	29.13	34.23	7.37	34.87
PK	4.824G	49.83	74.00	-24.17	6.73	3	Vertical	0	1.50	-	43.10	34.23	7.37	34.87

802.11n HT20_Nss2,(MCS8)_2TX

2412MHz_TX

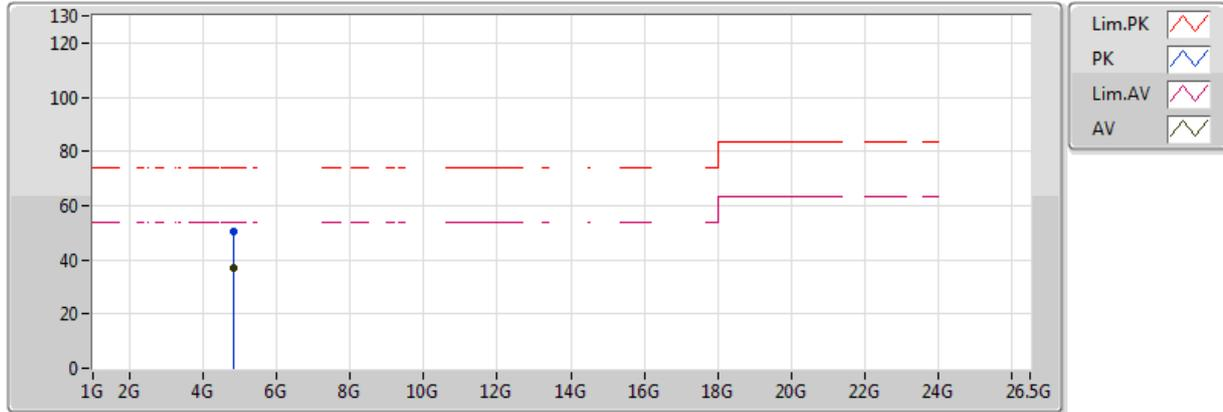

EUT = Z axis

Type	Freq (Hz)	Level (dBuV/m)	Limit (dBuV/m)	Margin (dB)	Factor (dB)	Dist (m)	Condition	Azimuth (°)	Height (m)	Comments	Raw (dBuV)	AF (dB)	CL (dB)	PA (dB)
AV	4.824G	37.00	54.00	-17.00	6.73	3	Horizontal	360	1.50	-	30.27	34.23	7.37	34.87
PK	4.824G	50.69	74.00	-23.31	6.73	3	Horizontal	360	1.50	-	43.96	34.23	7.37	34.87

802.11n HT20_Nss2,(MCS8)_2TX 2437MHz_TX

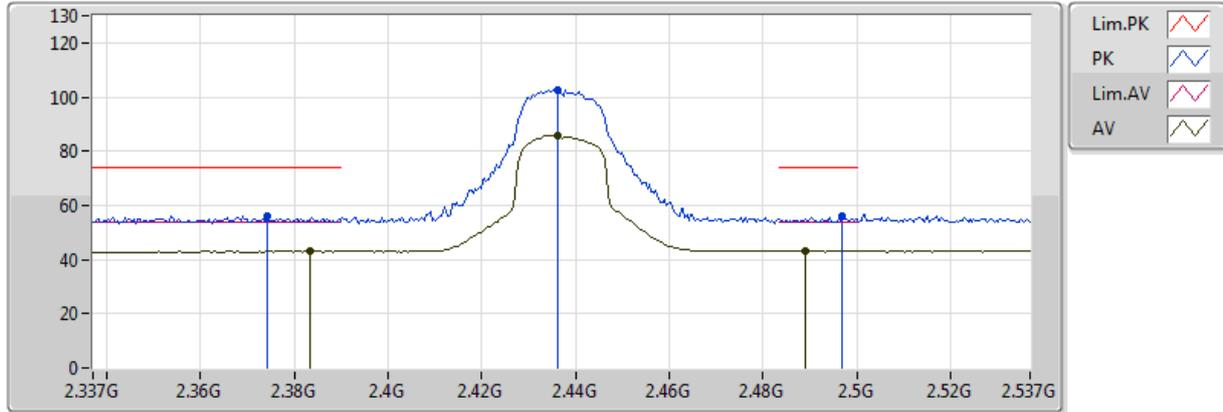

EUT = Z axis

Type	Freq (Hz)	Level (dBuV/m)	Limit (dBuV/m)	Margin (dB)	Factor (dB)	Dist (m)	Condition	Azimuth (°)	Height (m)	Comments	Raw (dBuV)	AF (dB)	CL (dB)	PA (dB)
AV	2.3834G	43.08	54.00	-10.92	2.08	3	Vertical	86	3.04	-	41.00	32.16	5.18	35.26
AV	2.4362G	85.98	Inf	-Inf	2.19	3	Vertical	86	3.04	-	83.80	32.22	5.23	35.27
AV	2.489G	43.16	54.00	-10.84	2.29	3	Vertical	86	3.04	-	40.87	32.29	5.28	35.28
PK	2.3742G	55.94	74.00	-18.06	2.05	3	Vertical	86	3.04	-	53.89	32.15	5.16	35.26
PK	2.4362G	102.77	Inf	-Inf	2.19	3	Vertical	86	3.04	-	100.58	32.22	5.23	35.27
PK	2.497G	56.02	74.00	-17.98	2.30	3	Vertical	86	3.04	-	53.72	32.30	5.29	35.28

802.11n HT20_Nss2,(MCS8)_2TX 2437MHz_TX

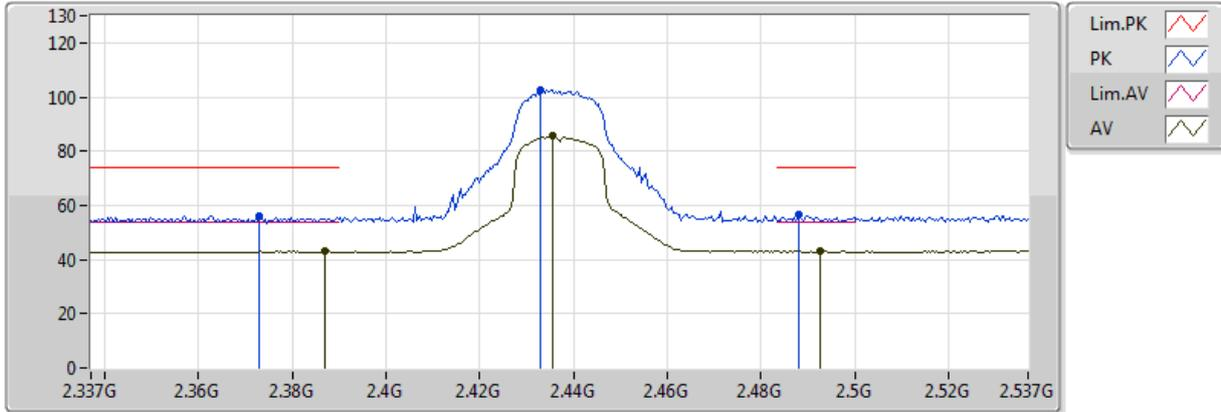

EUT = Z axis

Type	Freq (Hz)	Level (dBuV/m)	Limit (dBuV/m)	Margin (dB)	Factor (dB)	Dist (m)	Condition	Azimuth (°)	Height (m)	Comments	Raw (dBuV)	AF (dB)	CL (dB)	PA (dB)
AV	2.387G	43.00	54.00	-11.00	2.08	3	Horizontal	144	2.24	-	40.92	32.16	5.18	35.26
AV	2.4354G	85.50	Inf	-Inf	2.19	3	Horizontal	144	2.24	-	83.31	32.22	5.23	35.27
AV	2.4926G	42.99	54.00	-11.01	2.30	3	Horizontal	144	2.24	-	40.70	32.29	5.28	35.28
PK	2.373G	55.93	74.00	-18.07	2.05	3	Horizontal	144	2.24	-	53.88	32.14	5.16	35.26
PK	2.433G	102.74	Inf	-Inf	2.18	3	Horizontal	144	2.24	-	100.56	32.22	5.23	35.27
PK	2.4882G	56.42	74.00	-17.58	2.29	3	Horizontal	144	2.24	-	54.14	32.29	5.28	35.28

802.11n HT20_Nss2,(MCS8)_2TX

2437MHz_TX

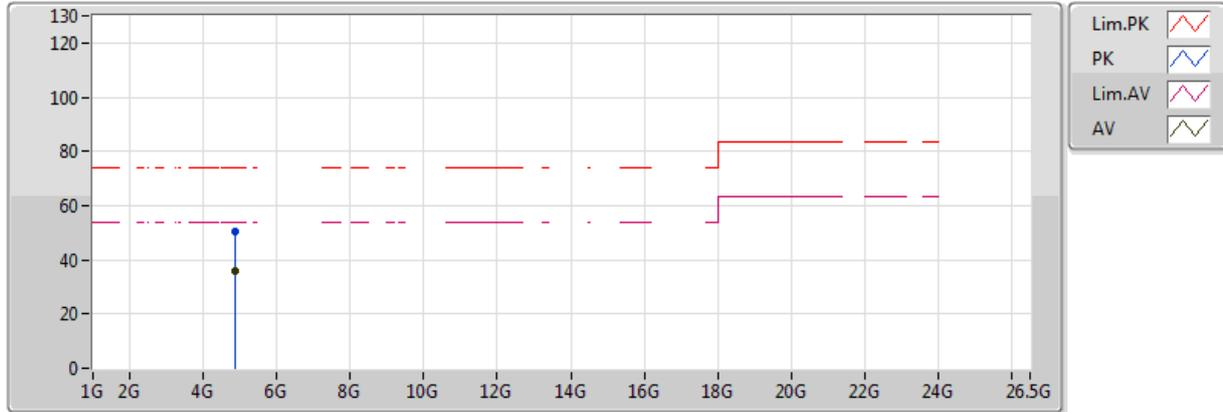

EUT = Z axis

Type	Freq (Hz)	Level (dBuV/m)	Limit (dBuV/m)	Margin (dB)	Factor (dB)	Dist (m)	Condition	Azimuth (°)	Height (m)	Comments	Raw (dBuV)	AF (dB)	CL (dB)	PA (dB)
AV	4.874G	36.03	54.00	-17.97	6.82	3	Vertical	0	1.50	-	29.21	34.25	7.43	34.86
PK	4.874G	50.58	74.00	-23.42	6.82	3	Vertical	0	1.50	-	43.76	34.25	7.43	34.86

**802.11n HT20_Nss2,(MCS8)_2TX
2437MHz_TX**

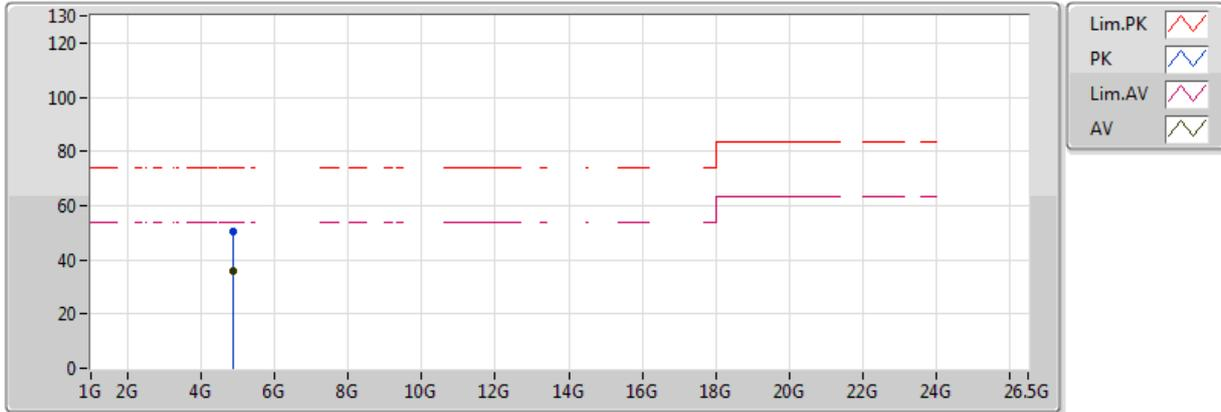

EUT = Z axis

Type	Freq (Hz)	Level (dBuV/m)	Limit (dBuV/m)	Margin (dB)	Factor (dB)	Dist (m)	Condition	Azimuth (°)	Height (m)	Comments	Raw (dBuV)	AF (dB)	CL (dB)	PA (dB)
AV	4.874G	36.12	54.00	-17.88	6.82	3	Horizontal	360	1.50	-	29.30	34.25	7.43	34.86
PK	4.874G	50.22	74.00	-23.78	6.82	3	Horizontal	360	1.50	-	43.40	34.25	7.43	34.86

802.11n HT20_Nss2,(MCS8)_2TX

2462MHz_TX

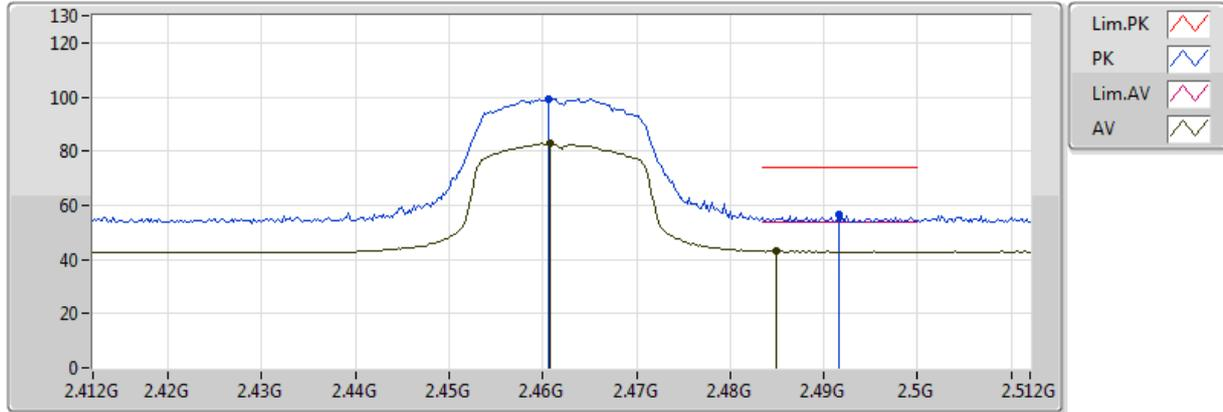

EUT = Z axis

Type	Freq (Hz)	Level (dBuV/m)	Limit (dBuV/m)	Margin (dB)	Factor (dB)	Dist (m)	Condition	Azimuth (°)	Height (m)	Comments	Raw (dBuV)	AF (dB)	CL (dB)	PA (dB)
AV	2.4608G	82.83	Inf	-Inf	2.24	3	Vertical	77	2.78	-	80.59	32.25	5.25	35.27
AV	2.485G	43.02	54.00	-10.98	2.28	3	Vertical	77	2.78	-	40.74	32.28	5.28	35.28
PK	2.4606G	99.32	Inf	-Inf	2.24	3	Vertical	77	2.78	-	97.08	32.25	5.25	35.27
PK	2.4916G	56.42	74.00	-17.58	2.29	3	Vertical	77	2.78	-	54.13	32.29	5.28	35.28

802.11n HT20_Nss2,(MCS8)_2TX

2462MHz_TX

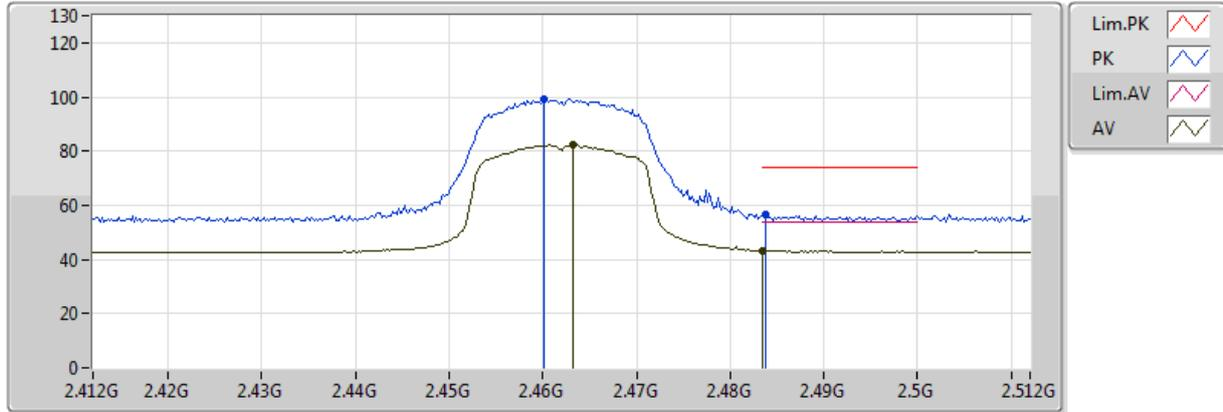

EUT = Z axis

Type	Freq (Hz)	Level (dBuV/m)	Limit (dBuV/m)	Margin (dB)	Factor (dB)	Dist (m)	Condition	Azimuth (°)	Height (m)	Comments	Raw (dBuV)	AF (dB)	CL (dB)	PA (dB)
AV	2.4632G	82.34	Inf	-Inf	2.24	3	Horizontal	146	2.76	-	80.10	32.26	5.26	35.27
AV	2.483502G	43.16	54.00	-10.84	2.28	3	Horizontal	146	2.76	-	40.88	32.28	5.28	35.28
PK	2.4602G	99.27	Inf	-Inf	2.23	3	Horizontal	146	2.76	-	97.04	32.25	5.25	35.27
PK	2.4838G	56.47	74.00	-17.53	2.28	3	Horizontal	146	2.76	-	54.19	32.28	5.28	35.28

802.11n HT20_Nss2,(MCS8)_2TX

2462MHz_TX

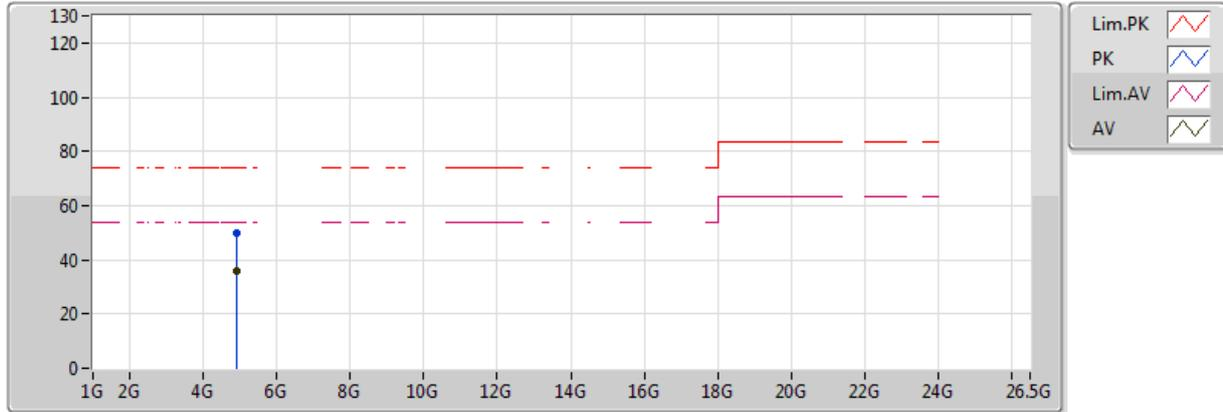

EUT = Z axis

Type	Freq (Hz)	Level (dBuV/m)	Limit (dBuV/m)	Margin (dB)	Factor (dB)	Dist (m)	Condition	Azimuth (°)	Height (m)	Comments	Raw (dBuV)	AF (dB)	CL (dB)	PA (dB)
AV	4.924G	36.08	54.00	-17.92	6.92	3	Vertical	0	1.50	-	29.16	34.27	7.49	34.84
PK	4.924G	49.98	74.00	-24.02	6.92	3	Vertical	0	1.50	-	43.06	34.27	7.49	34.84

802.11n HT20_Nss2,(MCS8)_2TX

2462MHz_TX

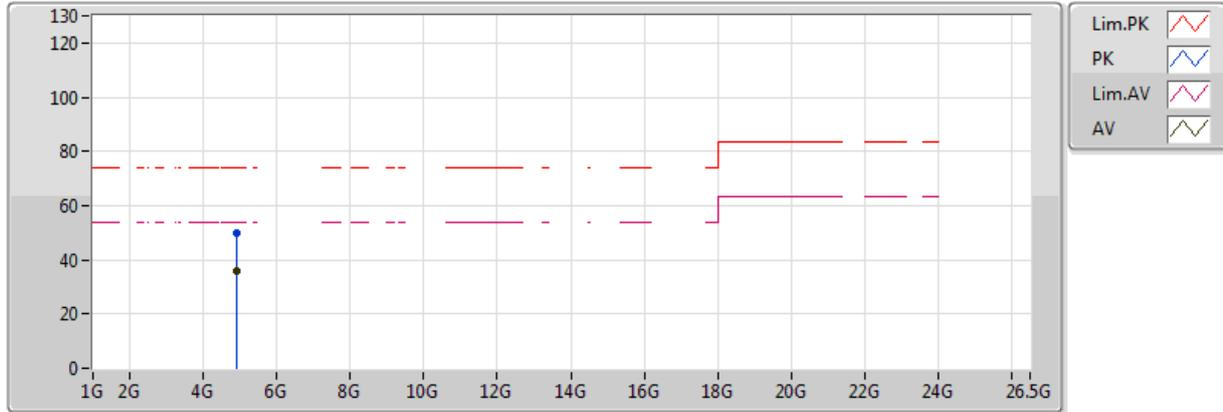

EUT = Z axis

Type	Freq (Hz)	Level (dBuV/m)	Limit (dBuV/m)	Margin (dB)	Factor (dB)	Dist (m)	Condition	Azimuth (°)	Height (m)	Comments	Raw (dBuV)	AF (dB)	CL (dB)	PA (dB)
AV	4.924G	36.03	54.00	-17.97	6.92	3	Horizontal	360	1.50	-	29.11	34.27	7.49	34.84
PK	4.924G	49.70	74.00	-24.30	6.92	3	Horizontal	360	1.50	-	42.78	34.27	7.49	34.84

802.11n HT40_Nss1,(MCS0)_1TX

2422MHz_TX

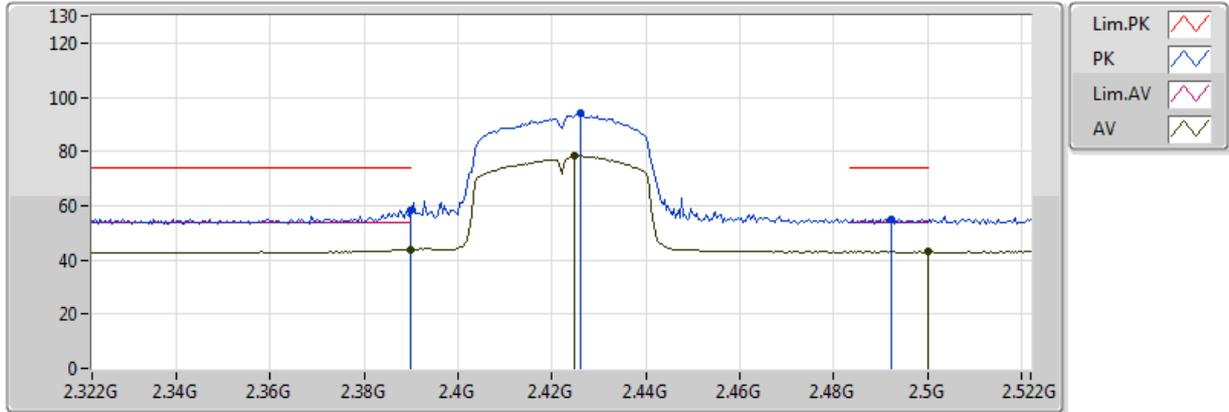

EUT = Z axis

Type	Freq (Hz)	Level (dBuV/m)	Limit (dBuV/m)	Margin (dB)	Factor (dB)	Dist (m)	Condition	Azimuth (°)	Height (m)	Comments	Raw (dBuV)	AF (dB)	CL (dB)	PA (dB)
AV	2.39G	43.84	54.00	-10.16	2.09	3	Vertical	89	3.00	-	41.75	32.17	5.18	35.26
AV	2.4248G	78.25	Inf	-Inf	2.17	3	Vertical	89	3.00	-	76.08	32.21	5.22	35.26
AV	2.5G	43.02	54.00	-10.98	2.31	3	Vertical	89	3.00	-	40.71	32.30	5.29	35.28
PK	2.39G	58.23	74.00	-15.77	2.09	3	Vertical	89	3.00	-	56.14	32.17	5.18	35.26
PK	2.426G	94.05	Inf	-Inf	2.17	3	Vertical	89	3.00	-	91.88	32.21	5.22	35.27
PK	2.4924G	55.19	74.00	-18.81	2.30	3	Vertical	89	3.00	-	52.89	32.29	5.28	35.28

802.11n HT40_Nss1,(MCS0)_1TX

2422MHz_TX

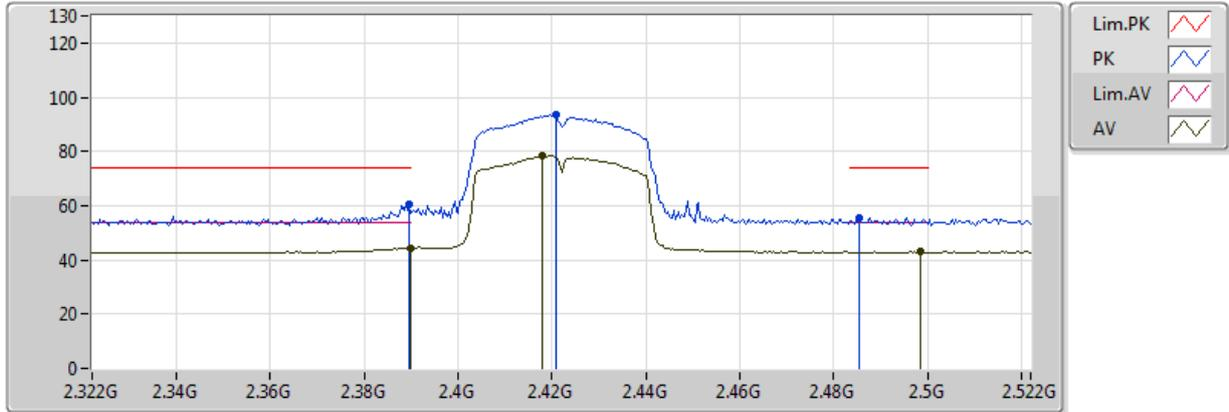

EUT = Z axis

Type	Freq (Hz)	Level (dBuV/m)	Limit (dBuV/m)	Margin (dB)	Factor (dB)	Dist (m)	Condition	Azimuth (°)	Height (m)	Comments	Raw (dBuV)	AF (dB)	CL (dB)	PA (dB)
AV	2.39G	44.42	54.00	-9.58	2.09	3	Horizontal	155	2.34	-	42.33	32.17	5.18	35.26
AV	2.418G	78.44	Inf	-Inf	2.15	3	Horizontal	155	2.34	-	76.28	32.20	5.22	35.26
AV	2.4984G	42.90	54.00	-11.10	2.31	3	Horizontal	155	2.34	-	40.60	32.30	5.29	35.28
PK	2.3896G	60.47	74.00	-13.53	2.09	3	Horizontal	155	2.34	-	58.38	32.17	5.18	35.26
PK	2.4208G	93.35	Inf	-Inf	2.16	3	Horizontal	155	2.34	-	91.19	32.20	5.22	35.26
PK	2.4856G	55.56	74.00	-18.44	2.28	3	Horizontal	155	2.34	-	53.28	32.28	5.28	35.28

802.11n HT40_Nss1,(MCS0)_1TX

2422MHz_TX

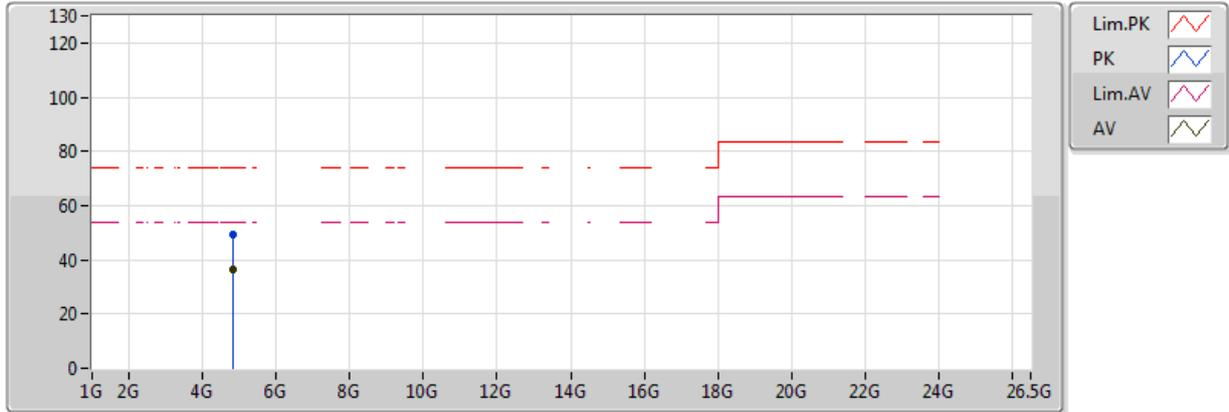

EUT = Z axis

Type	Freq (Hz)	Level (dBuV/m)	Limit (dBuV/m)	Margin (dB)	Factor (dB)	Dist (m)	Condition	Azimuth (°)	Height (m)	Comments	Raw (dBuV)	AF (dB)	CL (dB)	PA (dB)
AV	4.844G	36.26	54.00	-17.74	6.76	3	Vertical	360	1.50	-	29.50	34.24	7.39	34.87
PK	4.844G	49.36	74.00	-24.64	6.76	3	Vertical	360	1.50	-	42.60	34.24	7.39	34.87

802.11n HT40_Nss1,(MCS0)_1TX

2422MHz_TX

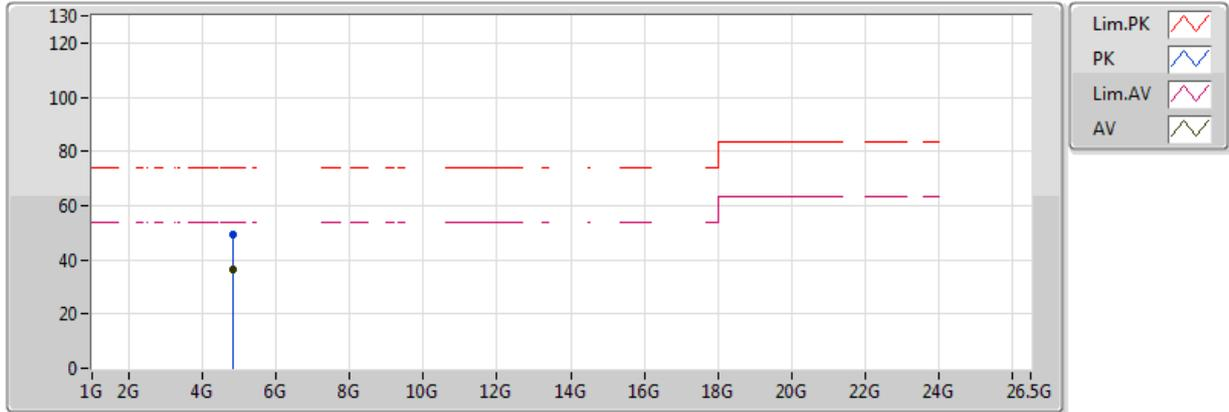

EUT = Z axis

Type	Freq (Hz)	Level (dBuV/m)	Limit (dBuV/m)	Margin (dB)	Factor (dB)	Dist (m)	Condition	Azimuth (°)	Height (m)	Comments	Raw (dBuV)	AF (dB)	CL (dB)	PA (dB)
AV	4.844G	36.40	54.00	-17.60	6.76	3	Horizontal	0	1.50	-	29.64	34.24	7.39	34.87
PK	4.844G	49.24	74.00	-24.76	6.76	3	Horizontal	0	1.50	-	42.48	34.24	7.39	34.87

**802.11n HT40_Nss1,(MCS0)_1TX
2437MHz_TX**

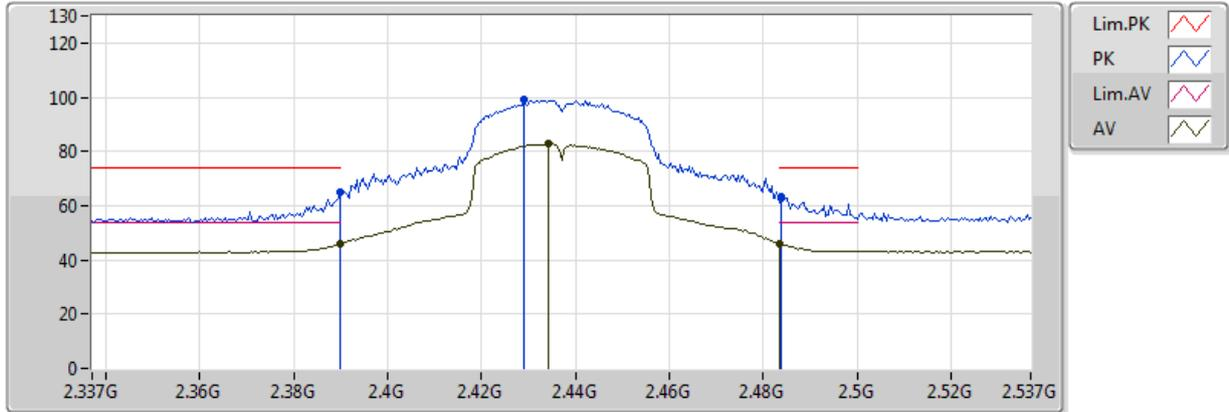

EUT = Z axis

Type	Freq (Hz)	Level (dBuV/m)	Limit (dBuV/m)	Margin (dB)	Factor (dB)	Dist (m)	Condition	Azimuth (°)	Height (m)	Comments	Raw (dBuV)	AF (dB)	CL (dB)	PA (dB)
AV	2.389998G	45.75	54.00	-8.25	2.09	3	Vertical	84	3.00	-	43.66	32.17	5.18	35.26
AV	2.4342G	82.77	Inf	-Inf	2.18	3	Vertical	84	3.00	-	80.58	32.22	5.23	35.27
AV	2.483502G	45.98	54.00	-8.02	2.28	3	Vertical	84	3.00	-	43.70	32.28	5.28	35.28
PK	2.389998G	65.17	74.00	-8.83	2.09	3	Vertical	84	3.00	-	63.07	32.17	5.18	35.26
PK	2.429G	98.96	Inf	-Inf	2.18	3	Vertical	84	3.00	-	96.78	32.21	5.23	35.27
PK	2.4838G	63.09	74.00	-10.91	2.28	3	Vertical	84	3.00	-	60.81	32.28	5.28	35.28

802.11n HT40_Nss1,(MCS0)_1TX

2437MHz_TX

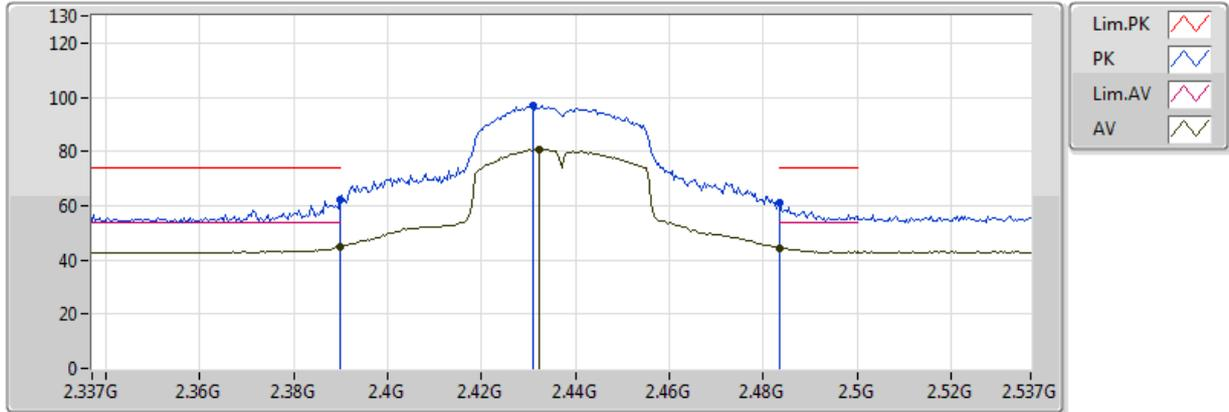

EUT = Z axis

Type	Freq (Hz)	Level (dBuV/m)	Limit (dBuV/m)	Margin (dB)	Factor (dB)	Dist (m)	Condition	Azimuth (°)	Height (m)	Comments	Raw (dBuV)	AF (dB)	CL (dB)	PA (dB)
AV	2.4322G	80.87	Inf	-Inf	2.18	3	Horizontal	312	1.69	-	78.69	32.22	5.23	35.27
AV	2.389998G	44.82	54.00	-9.18	2.09	3	Horizontal	312	1.69	-	42.72	32.17	5.18	35.26
AV	2.483502G	44.28	54.00	-9.72	2.28	3	Horizontal	312	1.69	-	42.01	32.28	5.28	35.28
PK	2.431G	96.92	Inf	-Inf	2.18	3	Horizontal	312	1.69	-	94.74	32.22	5.23	35.27
PK	2.389998G	62.22	74.00	-11.78	2.09	3	Horizontal	312	1.69	-	60.13	32.17	5.18	35.26
PK	2.483502G	60.99	74.00	-13.01	2.28	3	Horizontal	312	1.69	-	58.72	32.28	5.28	35.28

802.11n HT40_Nss1,(MCS0)_1TX

2437MHz_TX

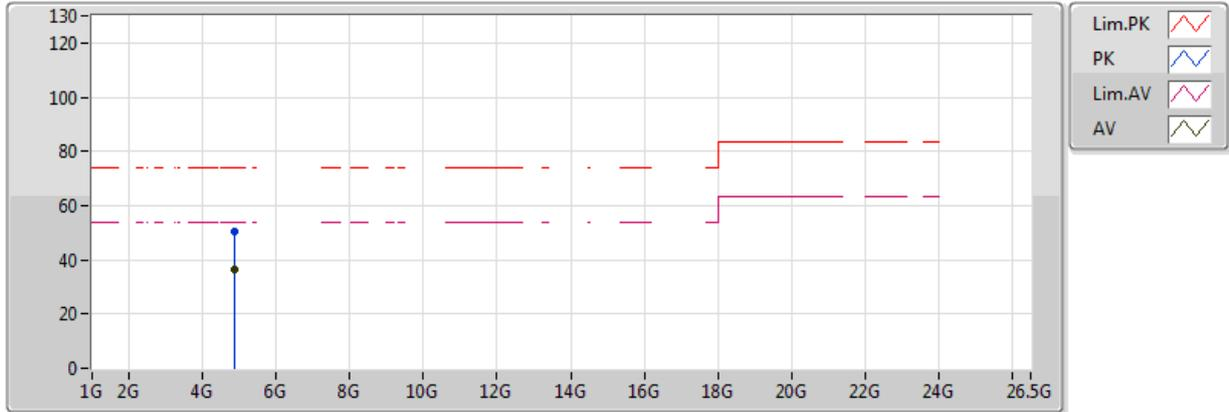

EUT = Z axis

Type	Freq (Hz)	Level (dBuV/m)	Limit (dBuV/m)	Margin (dB)	Factor (dB)	Dist (m)	Condition	Azimuth (°)	Height (m)	Comments	Raw (dBuV)	AF (dB)	CL (dB)	PA (dB)
AV	4.874G	36.58	54.00	-17.42	6.82	3	Vertical	360	1.50	-	29.76	34.25	7.43	34.86
PK	4.874G	50.17	74.00	-23.83	6.82	3	Vertical	360	1.50	-	43.35	34.25	7.43	34.86

802.11n HT40_Nss1,(MCS0)_1TX

2437MHz_TX

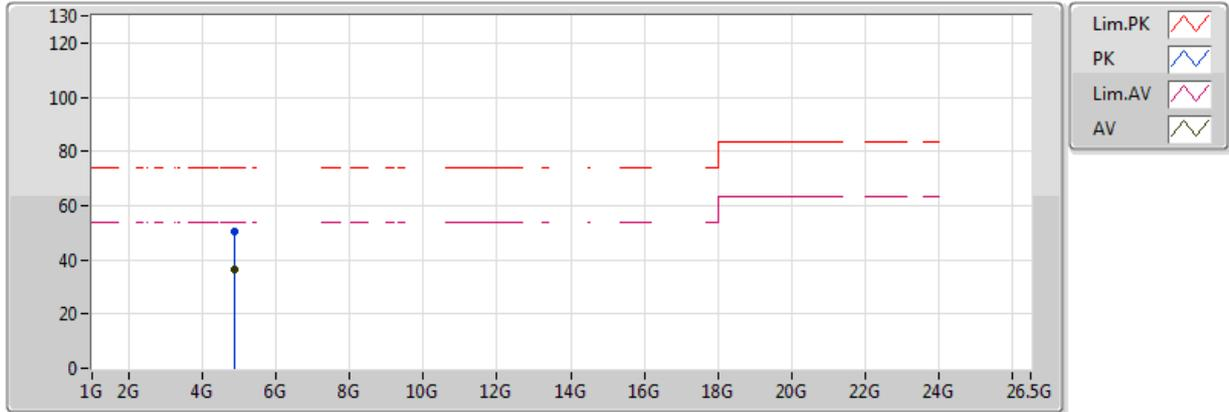

EUT = Z axis

Type	Freq (Hz)	Level (dBuV/m)	Limit (dBuV/m)	Margin (dB)	Factor (dB)	Dist (m)	Condition	Azimuth (°)	Height (m)	Comments	Raw (dBuV)	AF (dB)	CL (dB)	PA (dB)
AV	4.874G	36.64	54.00	-17.36	6.82	3	Horizontal	0	1.50	-	29.82	34.25	7.43	34.86
PK	4.874G	50.47	74.00	-23.53	6.82	3	Horizontal	0	1.50	-	43.65	34.25	7.43	34.86

**802.11n HT40_Nss1,(MCS0)_1TX
2452MHz_TX**

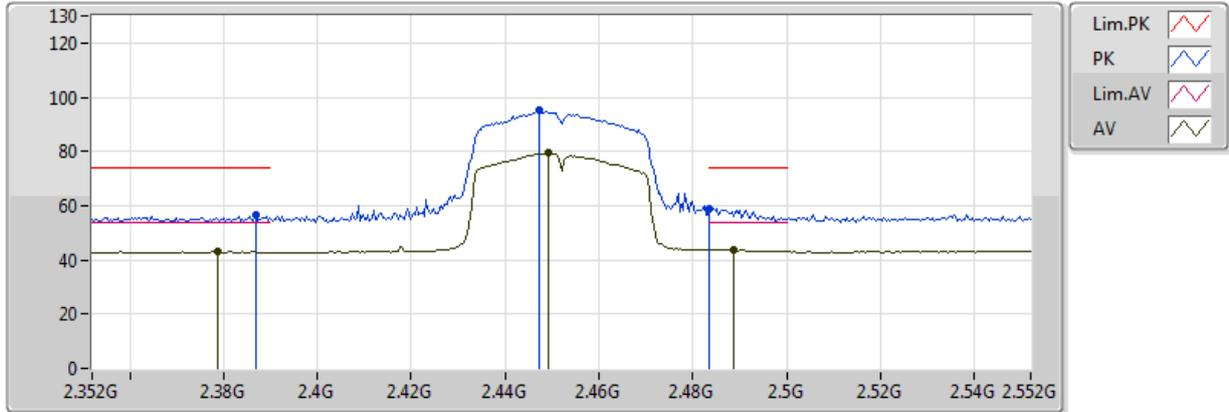

EUT = Z axis

Type	Freq (Hz)	Level (dBuV/m)	Limit (dBuV/m)	Margin (dB)	Factor (dB)	Dist (m)	Condition	Azimuth (°)	Height (m)	Comments	Raw (dBuV)	AF (dB)	CL (dB)	PA (dB)
AV	2.3788G	42.92	54.00	-11.08	2.06	3	Vertical	92	1.91	-	40.85	32.15	5.17	35.26
AV	2.4492G	79.42	Inf	-Inf	2.21	3	Vertical	92	1.91	-	77.21	32.24	5.24	35.27
AV	2.4888G	43.78	54.00	-10.22	2.29	3	Vertical	92	1.91	-	41.49	32.29	5.28	35.28
PK	2.3868G	56.54	74.00	-17.46	2.08	3	Vertical	92	1.91	-	54.46	32.16	5.18	35.26
PK	2.4472G	94.99	Inf	-Inf	2.21	3	Vertical	92	1.91	-	92.78	32.24	5.24	35.27
PK	2.4836G	59.09	74.00	-14.91	2.28	3	Vertical	92	1.91	-	56.81	32.28	5.28	35.28

802.11n HT40_Nss1,(MCS0)_1TX 2452MHz_TX

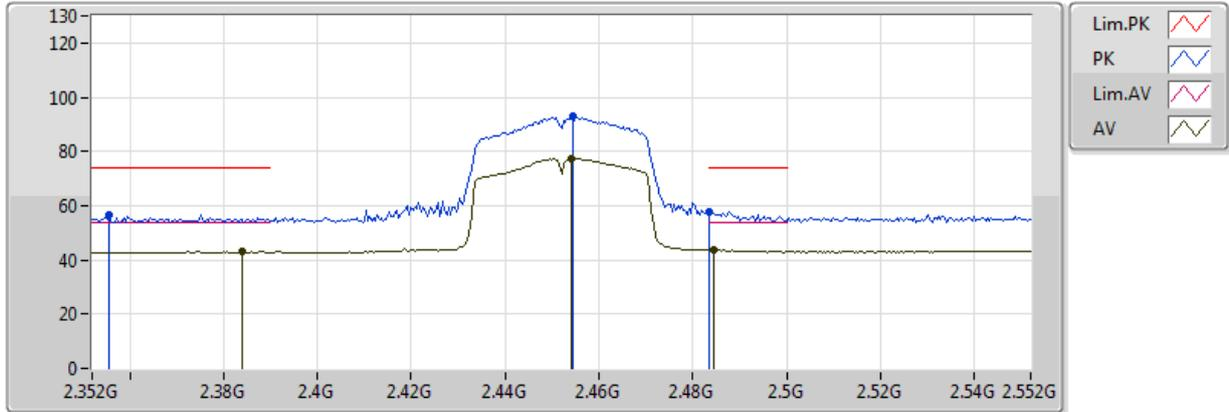

EUT = Z axis

Type	Freq (Hz)	Level (dBuV/m)	Limit (dBuV/m)	Margin (dB)	Factor (dB)	Dist (m)	Condition	Azimuth (°)	Height (m)	Comments	Raw (dBuV)	AF (dB)	CL (dB)	PA (dB)
AV	2.384G	42.95	54.00	-11.05	2.08	3	Horizontal	126	2.06	-	40.87	32.16	5.18	35.26
AV	2.454G	77.31	Inf	-Inf	2.22	3	Horizontal	126	2.06	-	75.08	32.24	5.25	35.27
AV	2.4844G	43.67	54.00	-10.33	2.28	3	Horizontal	126	2.06	-	41.38	32.28	5.28	35.28
PK	2.3556G	56.69	74.00	-17.31	2.00	3	Horizontal	126	2.06	-	54.69	32.12	5.13	35.26
PK	2.4544G	92.83	Inf	-Inf	2.22	3	Horizontal	126	2.06	-	90.61	32.25	5.25	35.27
PK	2.4836G	57.82	74.00	-16.18	2.28	3	Horizontal	126	2.06	-	55.54	32.28	5.28	35.28

802.11n HT40_Nss1,(MCS0)_1TX

2452MHz_TX

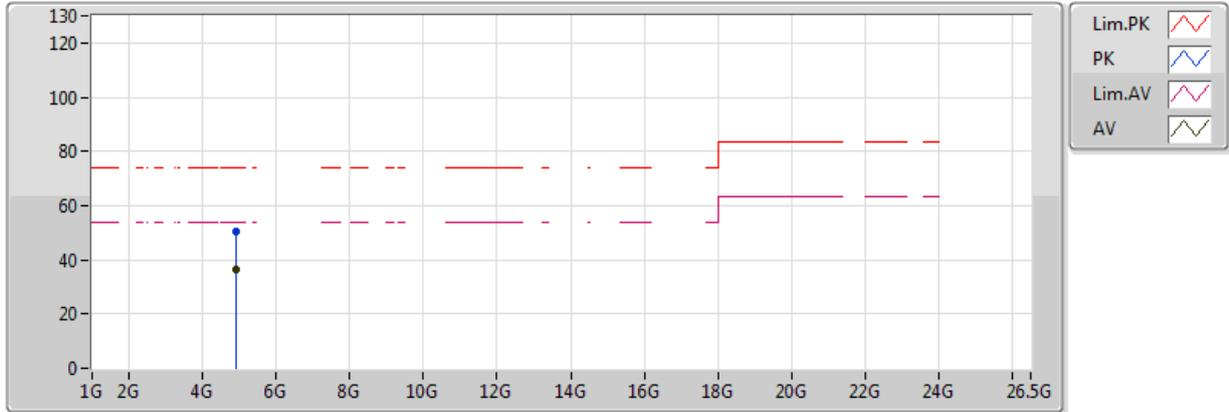

EUT = Z axis

Type	Freq (Hz)	Level (dBuV/m)	Limit (dBuV/m)	Margin (dB)	Factor (dB)	Dist (m)	Condition	Azimuth (°)	Height (m)	Comments	Raw (dBuV)	AF (dB)	CL (dB)	PA (dB)
AV	4.904G	36.22	54.00	-17.78	6.88	3	Vertical	0	1.50	-	29.34	34.26	7.47	34.85
PK	4.904G	50.34	74.00	-23.66	6.88	3	Vertical	0	1.50	-	43.46	34.26	7.47	34.85

802.11n HT40_Nss1,(MCS0)_1TX

2452MHz_TX

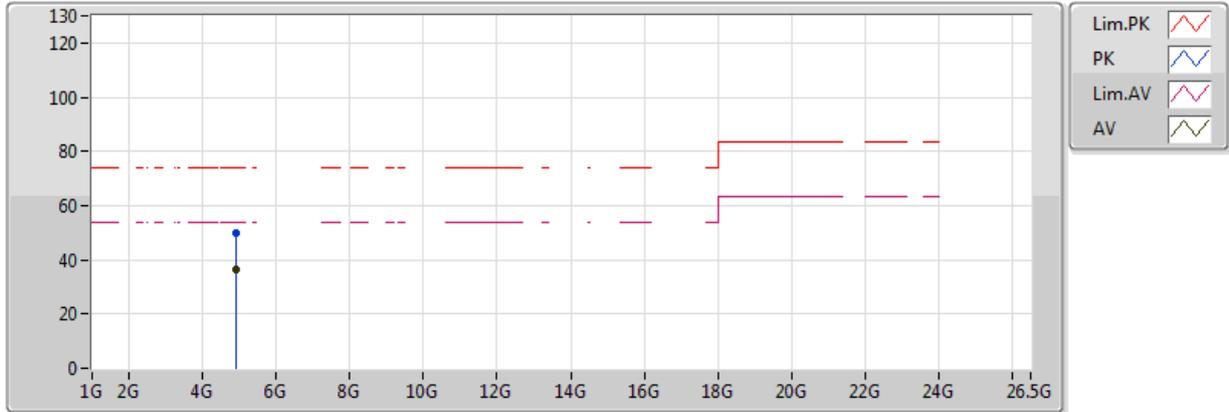

EUT = Z axis

Type	Freq (Hz)	Level (dBuV/m)	Limit (dBuV/m)	Margin (dB)	Factor (dB)	Dist (m)	Condition	Azimuth (°)	Height (m)	Comments	Raw (dBuV)	AF (dB)	CL (dB)	PA (dB)
AV	4.904G	36.19	54.00	-17.81	6.88	3	Horizontal	360	1.50	-	29.31	34.26	7.47	34.85
PK	4.904G	49.81	74.00	-24.19	6.88	3	Horizontal	360	1.50	-	42.93	34.26	7.47	34.85