



# Test Report

## FCC Part15 Subpart C

Product Name : Ring Bridge  
Model No. : 5B01S8  
FCC ID : 2AEUPBHARB001

Applicant : Ring, LLC.

Address : 1523 26th St, Santa Monica, CA 90404

Date of Receipt : Mar. 25, 2018

Test Date : Mar. 25, 2018 ~ Mar. 26, 2018

Issued Date : Mar. 29, 2019

Report No. : 1932200R-RF-US-P06V02

Report Version : V1.0

Note: This report was based on DEKRA Report No. 18C2098R-RF-US-P06V02, only Change the capacitance to reduce de-sense, so the RSE and output power re-test.

The test results relate only to the samples tested.

The test results shown in the test report are traceable to the national/international standard through the calibration of the equipment and evaluated measurement uncertainty herein.

This report must not be used to claim product endorsement by A2LA or any agency of the government.

The test report shall not be reproduced without the written approval of DEKRA Testing & Certification (Suzhou) Co., Ltd.

# Test Report Certification

Issued Date : Mar. 29, 2019  
Report No. : 1932200R-RF-US-P06V02



Product Name : Ring Bridge  
 Applicant : Ring, LLC.  
 Address : 1523 26th St, Santa Monica, CA 90404  
 Manufacturer : Ring, LLC.  
 Address : 1523 26th St, Santa Monica, CA 90404  
 Model No. : 5B01S8  
 FCC ID : 2AEUPBHARB001  
 EUT Voltage : DC 5V  
 Test Voltage : AC 120V/60Hz  
 Brand Name : ring  
 Applicable Standard : FCC CFR Title 47 Part 15 Subpart C  
 558074 D01 15.247 MEAS GUIDANCE V05R01  
 Test Result : Complied  
 Performed Location : DEKRA Testing & Certification (Suzhou) Co., Ltd.  
 No.99 Hongye Rd., Suzhou Industrial Park, Suzhou, 215006,  
 Jiangsu, China  
 TEL: +86-512-6251-5088 / FAX: +86-512-6251-5098  
 FCC Registration Number: CN1199

Documented By : Kitty Li  
 ( Adm. Specialist: Kitty Li )

Reviewed By : Frank He  
 (Senior Project Manager: Frank He )

Approved By : Jack Zhang  
 (Engineering Supervisor: Jack Zhang)

## TABLE OF CONTENTS

Description	Page
1. General Information .....	5
1.1. EUT Description .....	5
1.2. Antenna information .....	7
1.3. Mode of Operation.....	8
1.4. Tested System Details .....	8
1.5. Configuration of Tested System.....	9
1.6. EUT Exercise Software.....	10
2. Technical Test .....	11
2.1. Summary of Test Result.....	11
2.2. Test Frequency configuration:.....	12
2.3. Test Environment.....	13
2.4. Measurement Uncertainty.....	13
3. Emissions in restricted frequency bands .....	14
3.1. Test Equipment.....	14
3.2. Test Setup.....	15
3.3. Limit.....	16
3.4. Test Procedure .....	18
3.5. EUT test Axis definition.....	19
3.6. Test Result.....	20
4. Fundamental emission output power .....	28
4.1. Test Equipment.....	28
4.2. Test Setup.....	28
4.3. Limit.....	29
4.4. Test Procedure .....	30
4.5. EUT test definition .....	31
4.6. Test Result.....	32

### History of This Test Report

REPORT NO.	VERSION	DESCRIPTION	ISSUED DATE
1932200R-RF-US-P06V02	V1.0	Initial Issued Report	Mar. 26, 2019
1932200R-RF-US-P06V02	V1.1	Page 21, updated the RSE data.	Mar. 29, 2019

## 1. General Information

### 1.1. EUT Description

Product Name	Ring Bridge
Model No.	5B01S8
EUT Voltage	DC 5V
Frequency Range	902~928MHz
Channel Number	9
Type of Modulation	LoRa
Data Rate	DR4:12500bps
Channel Control	Auto

Working Frequency of Each Channel							
Channel	Frequency	Channel	Frequency	Channel	Frequency	Channel	Frequency
00	902.5 MHz	01	903.3 MHz	02	913.7 MHz	03	923.3 MHz
04	924.1 MHz	05	924.9 MHz	06	925.7 MHz	07	926.5 MHz
08	927.3 MHz	N/A	N/A	N/A	N/A	N/A	N/A

**1.2. Antenna information**

Model No.	N/A							
Antenna manufacturer	N/A							
Antenna Delivery	<input checked="" type="checkbox"/>	1*TX+1*RX	<input type="checkbox"/>	2*TX+2*RX	<input type="checkbox"/>	3*TX+3*RX	<input type="checkbox"/>	4*TX+4*RX
Antenna technology	<input checked="" type="checkbox"/>	SISO						
	<input type="checkbox"/>	MIMO	<input type="checkbox"/>	Basic				
			<input type="checkbox"/>	CDD				
			<input type="checkbox"/>	Sectorized				
			<input type="checkbox"/>	Beam-forming				
Antenna Type	<input type="checkbox"/>	External	<input type="checkbox"/>	Dipole				
			<input type="checkbox"/>	Sectorized				
	<input checked="" type="checkbox"/>	Internal	<input type="checkbox"/>	PIFA				
			<input checked="" type="checkbox"/>	PCB				
			<input type="checkbox"/>	Ceramic Chip Antenna				
			<input type="checkbox"/>	Metal plate type F antenna				
	Antenna Gain	-1dBi						

### 1.3. Mode of Operation

Test Modes List
Mode 1: Transmit

Note:

1. For portable device, radiated spurious emission was verified over X, Y, Z Axis, and shown the worst case on this report.
2. Regards to the frequency band operation for systems using DSSS modulation
3. The extreme test condition for voltage and temperature were declared by the manufacturer.
4. The reading values of all the test items contain cable loss.

### 1.4. Tested System Details

The types for all equipment, plus descriptions of all cables used in the tested system (including inserted cards) are:

No.	Product	Manufacturer	Model No.	Serial No.	Power Cord
1	Notebook	Lenovo	Think pad x220	SUA0600195	Power by adapter
A	USB Cable	N/A	N/A	N/A	Shield, 0.75m
B	Serial Cable	N/A	N/A	N/A	Shield, 0.75m
C	USB Cable	N/A	N/A	N/A	Shield, 10m
D	Serial Cable	N/A	N/A	N/A	Shield, 10m



### 1.5. Configuration of Tested System

Test setup Diagram- AC Line Conducted Emission Test

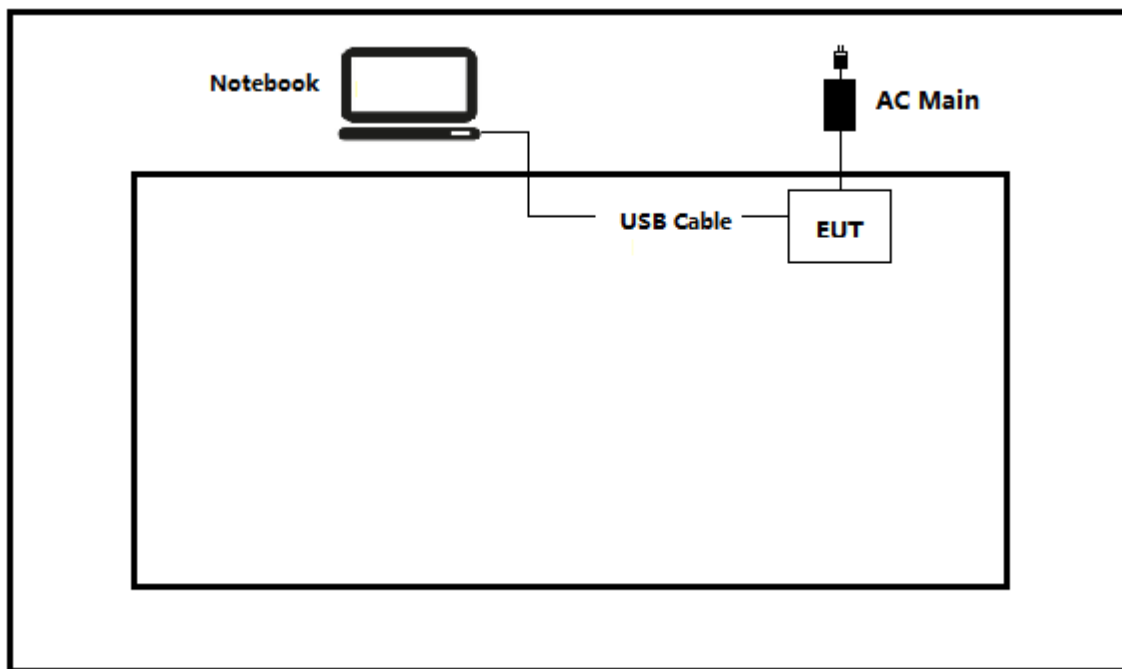

Test setup Diagram- Radiated Emission

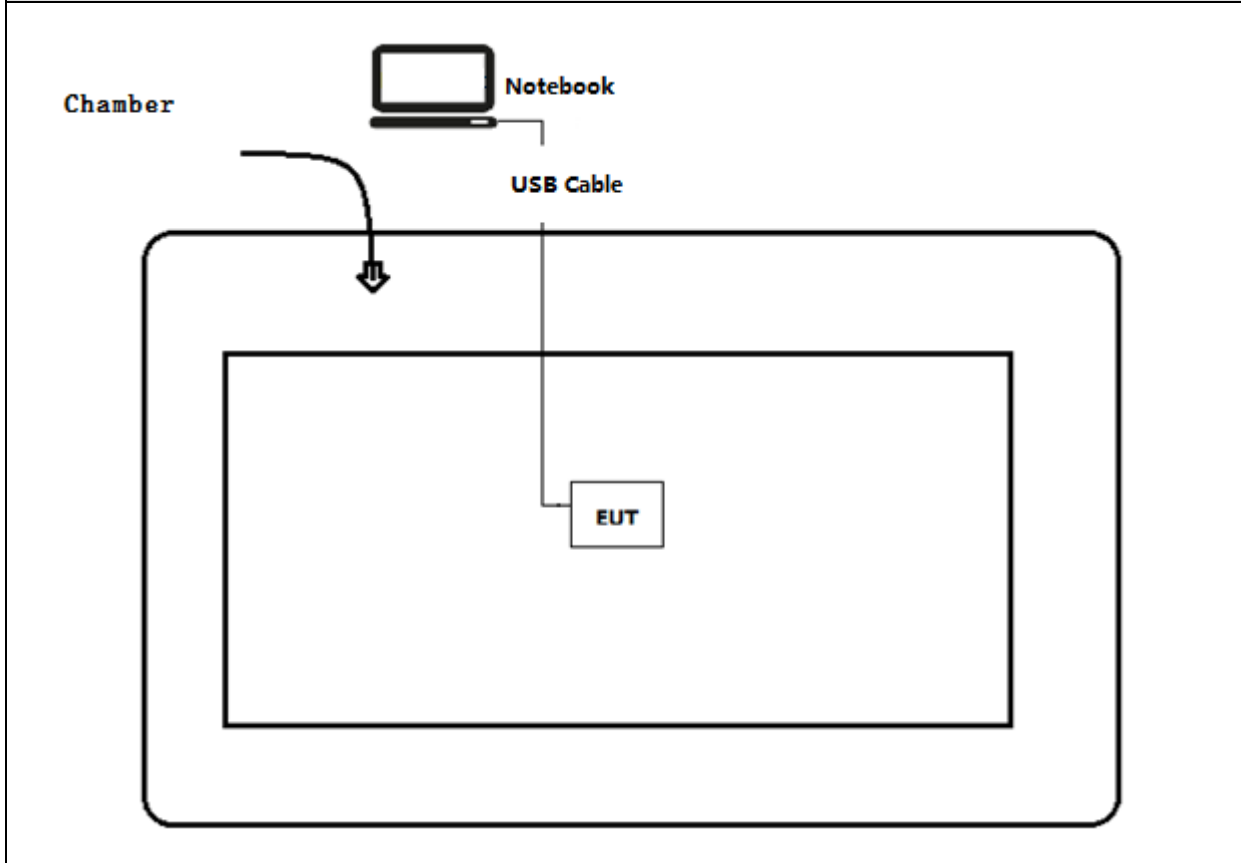

## 1.6. EUT Exercise Software

1	Setup the EUT and simulators as shown on above.
2	Turn on the power of all equipment.
3	Run “ cmd ” , and set the test mode and channel, then start continue Transmit.

## 2. Technical Test

### 2.1. Summary of Test Result

Performed Test Item	Normative References	Limit	Result
AC Power Line Conducted Emission	FCC CFR Title 47 Part 15 Subpart C: 2015 Section 15.207	FCC 15.207	PASS
Emissions in restricted frequency bands	FCC CFR Title 47 Part 15 Subpart C: 2015 Section 15.209	FCC 15.209	PASS
Emissions in non-restricted frequency bands	FCC CFR Title 47 Part 15 Subpart C: 2015 Section 15.247(d)	30dBc	PASS
Radiated Emission Band Edge	FCC CFR Title 47 Part 15 Subpart C: 2015 15.247(d)	FCC 15.209	PASS
Occupied Bandwidth	FCC CFR Title 47 Part 15 Subpart C: 2015 Section 15.247(a)(2)	500kHz	PASS
Fundamental emission output power	FCC CFR Title 47 Part 15 Subpart C: 2015 Section 15.247(b)(3)	30dBm	PASS
Power Spectral Density	FCC CFR Title 47 Part 15 Subpart C: 2015 Section 15.247(e)	8dBm/3kHz	PASS
Antenna Requirement	FCC CFR Title 47 Part 15 Subpart C: 2015 Section 15.203	FCC 15.203	PASS

**2.2. Test Frequency configuration:**

Channel	Frequency	Channel	Frequency	Channel	Frequency
Low	902.5 MHz	Mid	913.7 MHz	High	927.3MHz

### 2.3. Test Environment

Items	Required (IEC 68-1)	Actual
Temperature (°C)	15-35	21
Humidity (%RH)	25-75	50
Barometric pressure (mbar)	860-1060	950-1000

### 2.4. Measurement Uncertainty

Test Items	Uncertainty
AC Power Line Conducted Emission	±2.02dB
Radiated Emission	Below 1GHz ±3.8 dB
	Above 1GHz ±3.9 dB
RF Antenna Port Conducted Emission	±1.27dB
Radiated Emission Band Edge	±3.9dB
Occupied Bandwidth	±1kHz
Power Spectral Density	±1.27dB

### 3. Emissions in restricted frequency bands

#### 3.1. Test Equipment

Radiated Emission(Below 1GHz) / AC-2					
Instrument	Manufacturer	Type No.	Serial No.	Cal. Date	Cal. Due Date
EMI Test Receiver	R&S	ESCI	100573	2019.03.05	2020.03.04
Loop Antenna	R&S	HFH2-Z2	833799/003	2018.11.07	2019.11.06
Bilog Antenna	Teseq GmbH	CBL6112D	27611	2018.08.10	2019.08.09
Coaxial Cable	Huber+Suhner	SUCOFLEX 106	AC2-C	2019.02.28	2020.02.27
Temperature/Humidity Meter	Zhichen	ZC1-2	AC2-TH	2019.01.05	2020.01.04
Note: All equipments are calibrated with traceable calibrations. Each calibration is traceable to the national or international standards.					

Radiated Emission(Above 1GHz) / AC-5					
Instrument	Manufacturer	Type No.	Serial No.	Cal. Date	Cal. Due Date
Spectrum Analyzer	Agilent	E4446A	MY45300103	2019.01.04	2020.01.03
Preamplifier	Miteq	NSP1800-25	1364185	2018.05.03	2019.05.02
Preamplifier	QuieTek	AP-040G	CHM-0906001	2018.05.06	2019.05.05
DRG Horn	ETS-Lindgren	3117	00123988	2019.01.22	2020.01.20
Broad-Band Horn Antenna	Schwarzbeck	BBHA9170	294	2018.11.25	2019.11.23
Coaxial Cable	Huber+Suhner	SUCOFLEX 106	AC5-C1	2019.03.02	2020.03.01
Coaxial Cable	Huber+Suhner	SUCOFLEX 106	AC5-C2	2019.03.02	2020.03.01
Coaxial Cable	Huber+Suhner	SUCOFLEX 102	AC5-C3	2019.03.02	2020.03.01
EMI Receiver	Agilent	N9038A	MY51210196	2018.06.10	2019.06.09
Temperature/Humidity Meter	Zhichen	ZC1-2	AC5-TH	2019.01.04	2020.01.03
Note: All equipments are calibrated with traceable calibrations. Each calibration is traceable to the national or international standards.					

### 3.2. Test Setup

Below 30MHz Test Setup:

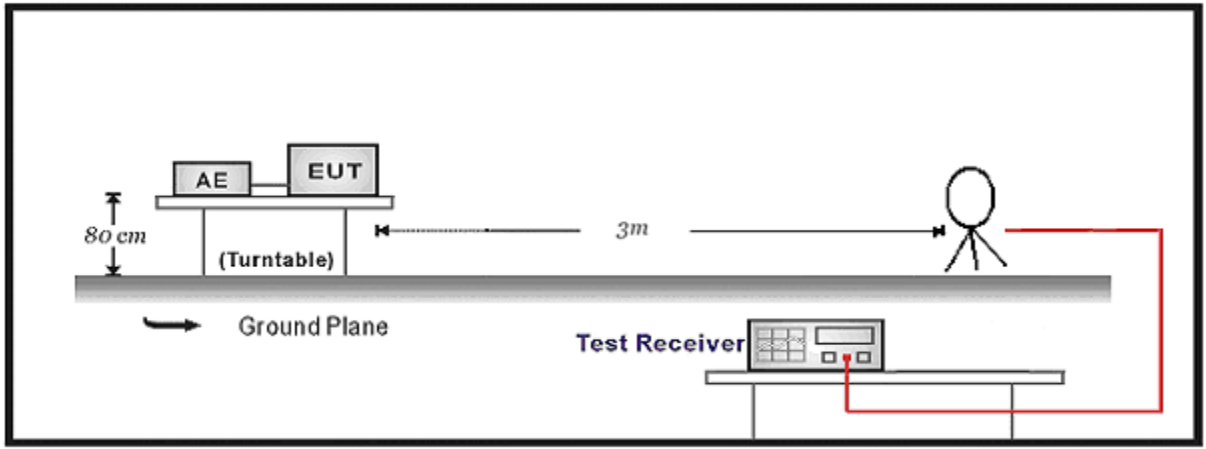

30MHz-1GHz Test Setup:

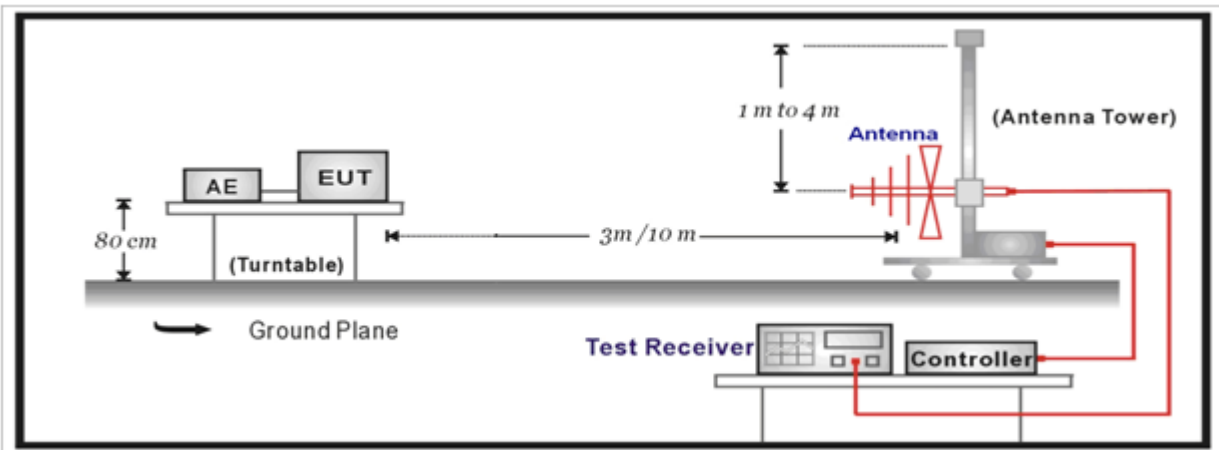

Above 1GHz Test Setup:

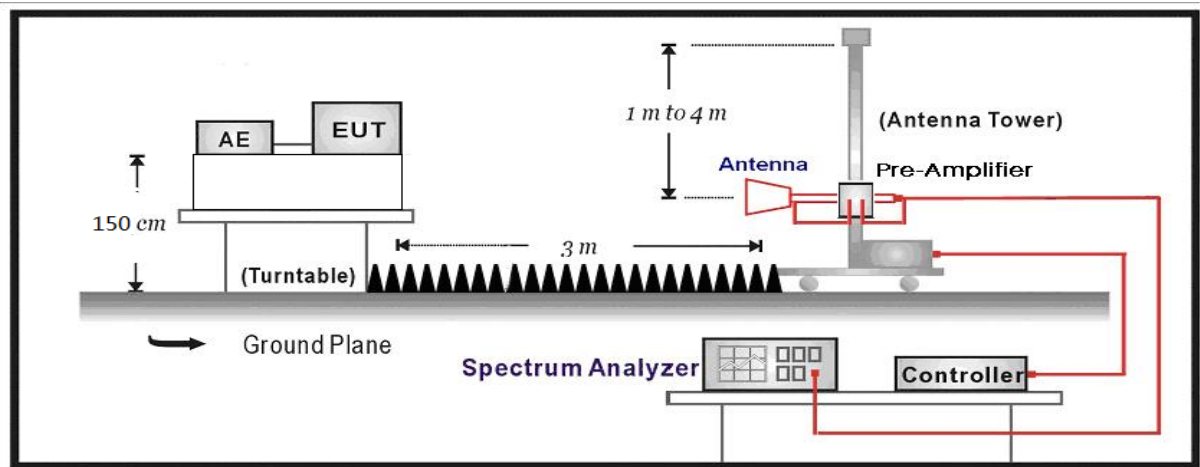

### 3.3. Limit

Restricted Bands of operation			
Frequency (MHz)	Frequency (MHz)	Frequency (MHz)	Frequency (GHz)
0.090 – 0.110	16.42 – 16.423	399.9 – 410	4.5 – 5.15
0.495 – 0.505	16.69475 – 16.69525	608 – 614	5.35 – 5.46
2.1735 – 2.1905	16.80425 – 16.80475	960 – 1240	7.25 – 7.75
4.125 – 4.128	25.5 – 25.67	1300 – 1427	8.025 – 8.5
4.17725 – 4.17775	37.5 – 38.25	1435 – 1626.5	9.0 – 9.2
4.20725 – 4.20775	73 – 74.6	1645.5 – 1646.5	9.3 – 9.5
6.215 – 6.218	74.8 – 75.2	1660 – 1710	10.6 – 12.7
6.26775 – 6.26825	108 – 121.94	1718.8 – 1722.2	13.25 – 13.4
6.31175 – 6.31225	123 – 138	2200 – 2300	14.47 – 14.5
8.291 – 8.294	149.9 – 150.05	2310 – 2390	15.35 – 16.2
8.362 – 8.366	156.52475 –	2483.5 – 2500	17.7 – 21.4
8.37625 – 8.38675	156.7 – 156.9	2690 – 2900	22.01 – 23.12
8.81425 – 8.81475	162.0125 – 167.17	3260 – 3267	23.6 – 24.0
12.29 – 12.293	167.72 – 173.2	3332 – 3339	31.2 – 31.8
12.51975–12.52025	240 – 285	3345.8 – 3358	36.43 – 36.5
12.57675–12.57725	322 – 335.4	3600 – 4400	
13.36 – 13.41			



Restricted Band Emissions Limit			
Frequency (MHz)	Field strength ( $\mu\text{V}/\text{m}$ )	Field strength ( $\text{dB}\mu\text{V}/\text{m}$ )	Measurement distance (m)
0.009 - 0.49	2400/F(kHz)	48.5 – 13.8	300 <sub>(Note 1)</sub>
0.49 - 1.705	24000/F(kHz)	33.8 - 23	30 <sub>(Note 1)</sub>
1.705 - 30	30	29.5	30 <sub>(Note 1)</sub>
30 - 88	100	40	3 <sub>(Note 2)</sub>
88 - 216	150	43.5	3 <sub>(Note 2)</sub>
216 - 960	200	46	3 <sub>(Note 2)</sub>
Above 960	500	54	3 <sub>(Note 2)</sub>



Note 1: At frequencies below 30 MHz, measurements may be performed at a distance closer than that specified in the regulations; however, an attempt should be made to avoid making measurements in the near field. Pending the development of an appropriate measurement procedure for measurements performed below 30 MHz, when performing measurements at a closer distance than specified, the results shall be extrapolated to the specified distance by either making measurements at a minimum of two distances on at least one radial to determine the proper extrapolation factor or by using the square of an inverse linear distance extrapolation factor (40 dB/decade).

Note 2: At frequencies at or above 30 MHz, measurements may be performed at a distance other than what is specified provided: measurements are not made in the near field except where it can be shown that near field measurements are appropriate due to the characteristics of the device; and it can be demonstrated that the signal levels needed to be measured at the distance employed can be detected by the measurement equipment. Measurements shall not be performed at a distance greater than 30 meters unless it can be further demonstrated that measurements at a distance of 30 meters or less are impractical. When performing measurements at a distance other than that specified, the results shall be extrapolated to the specified distance using an extrapolation factor of 20 dB/decade (inverse linear-distance for field strength measurements; inverse-linear-distance-squared for power density measurements).

### 3.4. Test Procedure

Test Method			
	References Rule	Chapter	Description
<input type="checkbox"/>	ANSI C63.10	11.11	Emissions in non-restricted frequency bands
	<input type="checkbox"/> ANSI C63.10	11.11.2	Reference level measurement
	<input type="checkbox"/> ANSI C63.10	11.11.3	Emission level measurement
<input checked="" type="checkbox"/>	ANSI C63.10	11.12	Emissions in restricted frequency bands
	<input checked="" type="checkbox"/> ANSI C63.10	11.12.1	Radiated emission measurements
	<input checked="" type="checkbox"/> ANSI C63.10	11.12.2.7	Radiated spurious emission test
	<input checked="" type="checkbox"/> ANSI C63.10	6.4	Radiated emissions from unlicensed wireless devices below 30 MHz
	<input checked="" type="checkbox"/> ANSI C63.10	6.5	Radiated emissions from unlicensed wireless devices in the frequency range of 30 MHz to 1000 MHz
	<input checked="" type="checkbox"/> ANSI C63.10	6.6	Radiated emissions from unlicensed wireless devices above 1 GHz
	<input type="checkbox"/> ANSI C63.10	11.12.2.3	Quasi-peak measurement procedure
	<input type="checkbox"/> ANSI C63.10	11.12.2.4	Peak power measurement procedure
	<input type="checkbox"/> ANSI C63.10	11.12.2.5	Average power measurement procedures
	<input type="checkbox"/> ANSI C63.10	11.12.2.5.1	Trace averaging with continuous EUT transmission at full power
	<input type="checkbox"/> ANSI C63.10	11.12.2.5.2	Trace averaging across ON and OFF times of the EUT transmissions followed by duty cycle correction
	<input type="checkbox"/> ANSI C63.10	11.12.2.5.3	Reduced VBW averaging across ON and OFF times of the EUT transmissions with max hold

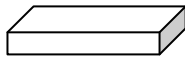
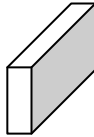
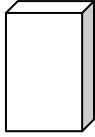
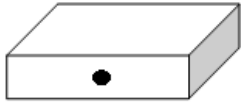
### 3.5. EUT test Axis definition

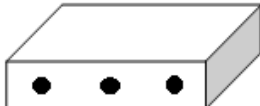
Item	Emissions in restricted frequency bands			
Device Category	<input checked="" type="checkbox"/>	Fixed position use		
	<input type="checkbox"/>	Mobile position use		
Test mode	Mode 1			
Test method	<input checked="" type="checkbox"/>	Radiated		
		X Axis	Y Axis	Z Axis
				
		Worst Axis <input checked="" type="checkbox"/>	Worst Axis <input type="checkbox"/>	Worst Axis <input type="checkbox"/>
	<input type="checkbox"/>	Conducted		
	<input type="checkbox"/>	Chain 1		
				
	<input type="checkbox"/>	Chain 1	Chain 2	
				
	<input type="checkbox"/>	Chain 1	Chain 2	Chain 3
				

### 3.6. Test Result

Engineer: Pawn	
Site: AC5	Time: 2019/03/25 - 16:29
Limit: FCC_Part15.209_RE(3m)	Margin: 0
Probe: Horn_3117_00167055(1-18GHz)	Polarity: Horizontal
EUT: Ring Bridge	Power: AC 120V/60Hz
Note: Mode1:Transmit at 902.5MHz by LORA	

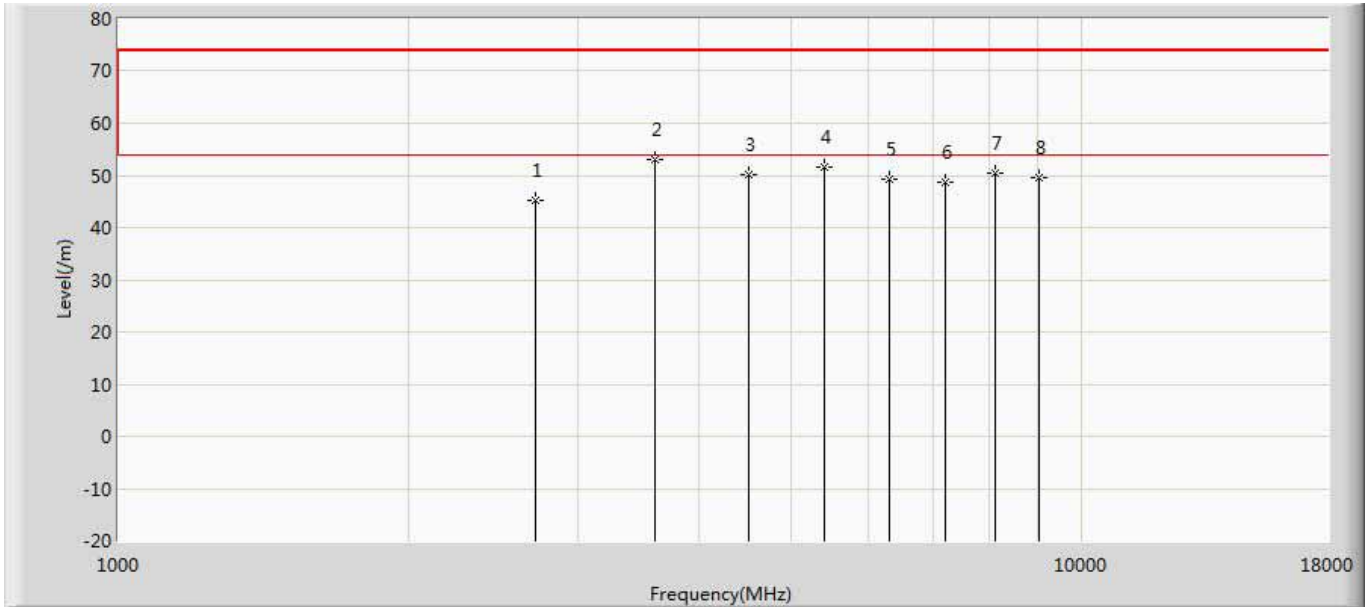

No	Mark	Frequency (MHz)	Measure Level (/m)	Reading Level ()	Over Limit (dB)	Limit (/m)	Factor (dB)	Type
1		2707.500	45.142	44.193	-28.858	74.000	0.949	PK
2	*	3609.500	53.156	50.473	-20.844	74.000	2.684	PK
3		4510.500	50.147	45.931	-23.853	74.000	4.216	PK
4		5411.500	51.658	46.249	-22.342	74.000	5.409	PK
5		6317.500	49.194	42.337	-24.806	74.000	6.857	PK
6		7220.000	48.657	40.976	-25.343	74.000	7.681	PK
7		8122.500	50.346	42.120	-23.654	74.000	8.225	PK
8		9025.000	49.436	40.203	-24.564	74.000	9.233	PK

Engineer: Pawn	
Site: AC5	Time: 2019/03/25 - 16:36
Limit: FCC_Part15.209_RE(3m)	Margin: 0
Probe: Horn_3117_00167055(1-18GHz)	Polarity: Vertical
EUT: Ring Bridge	Power: AC 120V/60Hz
Note: Mode1:Transmit at 902.5MHz by LORA	

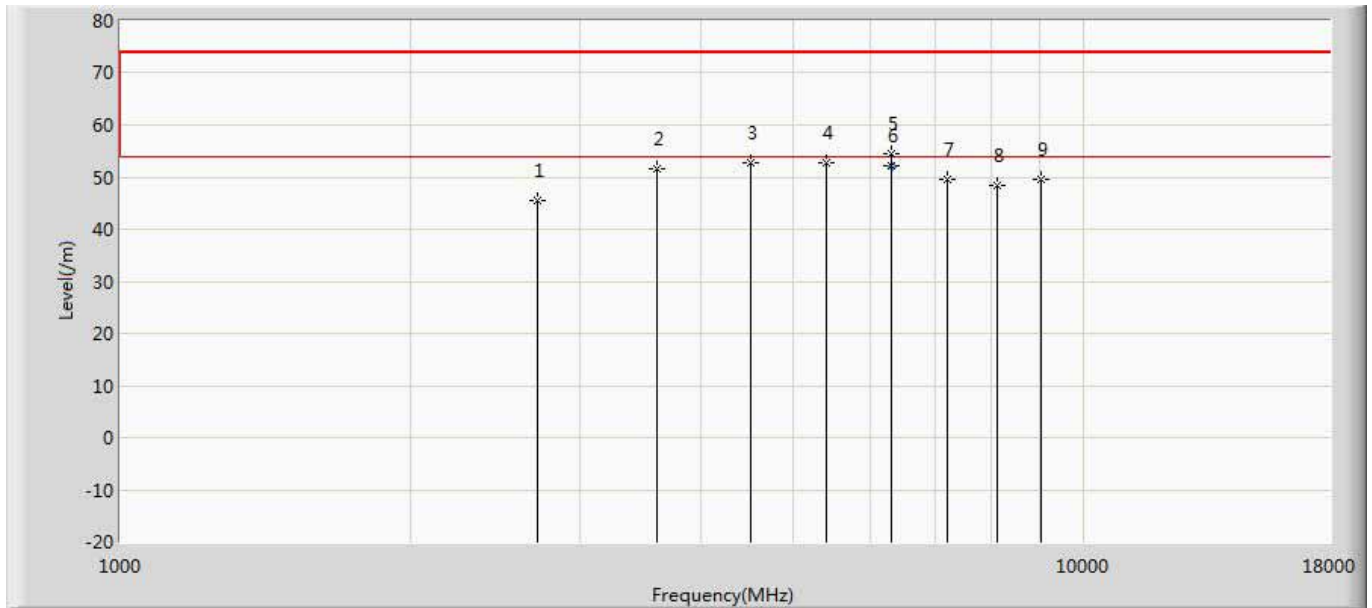

No	Mark	Frequency (MHz)	Measure Level (µm)	Reading Level (µm)	Over Limit (dB)	Limit (µm)	Factor (dB)	Type
1		2707.500	45.543	44.594	-28.457	74.000	0.949	PK
2		3609.500	51.547	48.864	-22.453	74.000	2.684	PK
3		4510.130	52.655	48.436	-21.345	74.000	4.219	PK
4		5411.500	52.841	47.432	-21.159	74.000	5.409	PK
5		6312.500	54.348	47.551	-19.652	74.000	6.798	PK
6	*	6312.500	52.112	45.314	-1.888	54.000	6.798	AV
7		7220.000	49.655	41.974	-24.345	74.000	7.681	PK
8		8122.500	48.319	40.093	-25.681	74.000	8.225	PK
9		9025.000	49.473	40.240	-24.527	74.000	9.233	PK

Engineer: Pawn	
Site: AC5	Time: 2019/03/25 - 16:40
Limit: FCC_Part15.209_RE(3m)	Margin: 0
Probe: Horn_3117_00167055(1-18GHz)	Polarity: Horizontal
EUT: Ring Bridge	Power: AC 120V/60Hz
Note: Mode1:Transmit at 913.7MHz by LORA	

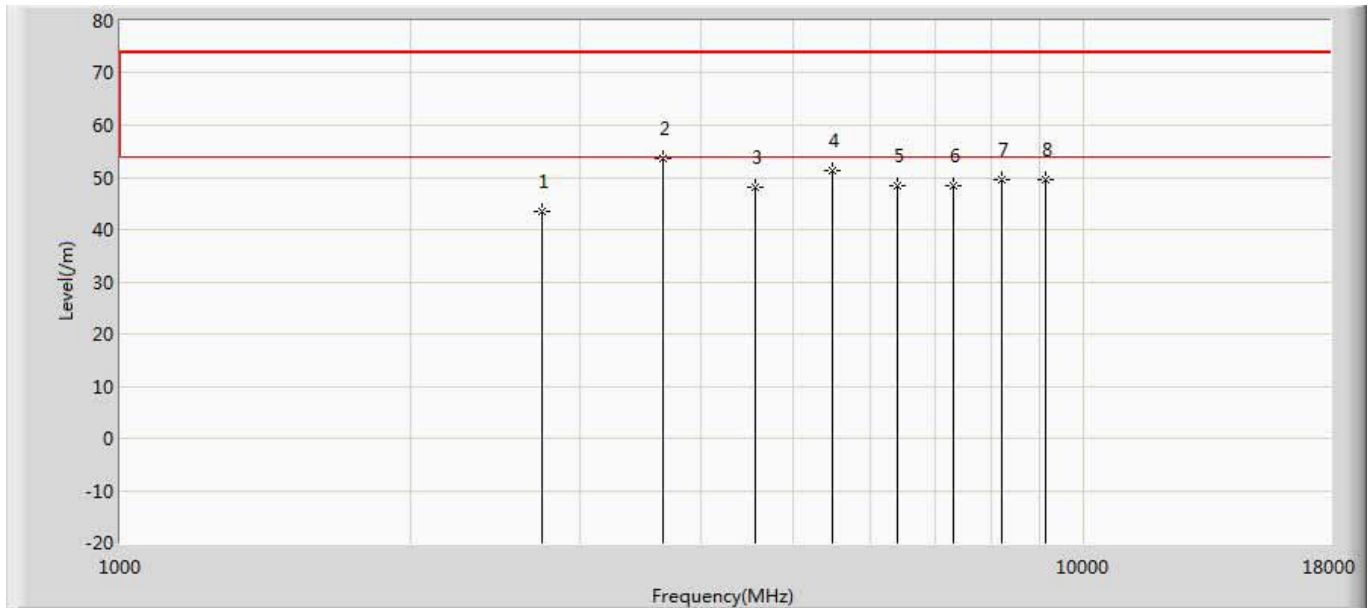

No	Mark	Frequency (MHz)	Measure Level (m)	Reading Level (m)	Over Limit (dB)	Limit (m)	Factor (dB)	Type
1		2741.100	43.564	42.559	-30.436	74.000	1.005	PK
2	*	3652.000	53.762	51.220	-20.238	74.000	2.542	PK
3		4568.500	48.024	43.858	-25.976	74.000	4.166	PK
4		5479.500	51.248	45.731	-22.752	74.000	5.517	PK
5		6395.900	48.324	41.467	-25.676	74.000	6.857	PK
6		7309.600	48.438	40.694	-25.562	74.000	7.744	PK
7		8223.300	49.433	41.092	-24.567	74.000	8.341	PK
8		9137.000	49.652	40.590	-24.348	74.000	9.061	PK

Engineer: Pawn	
Site: AC5	Time: 2019/03/25 - 16:45
Limit: FCC_Part15.209_RE(3m)	Margin: 0
Probe: Horn_3117_00167055(1-18GHz)	Polarity: Vertical
EUT: Ring Bridge	Power: AC 120V/60Hz
Note: Mode1:Transmit at 913.7MHz by LORA	

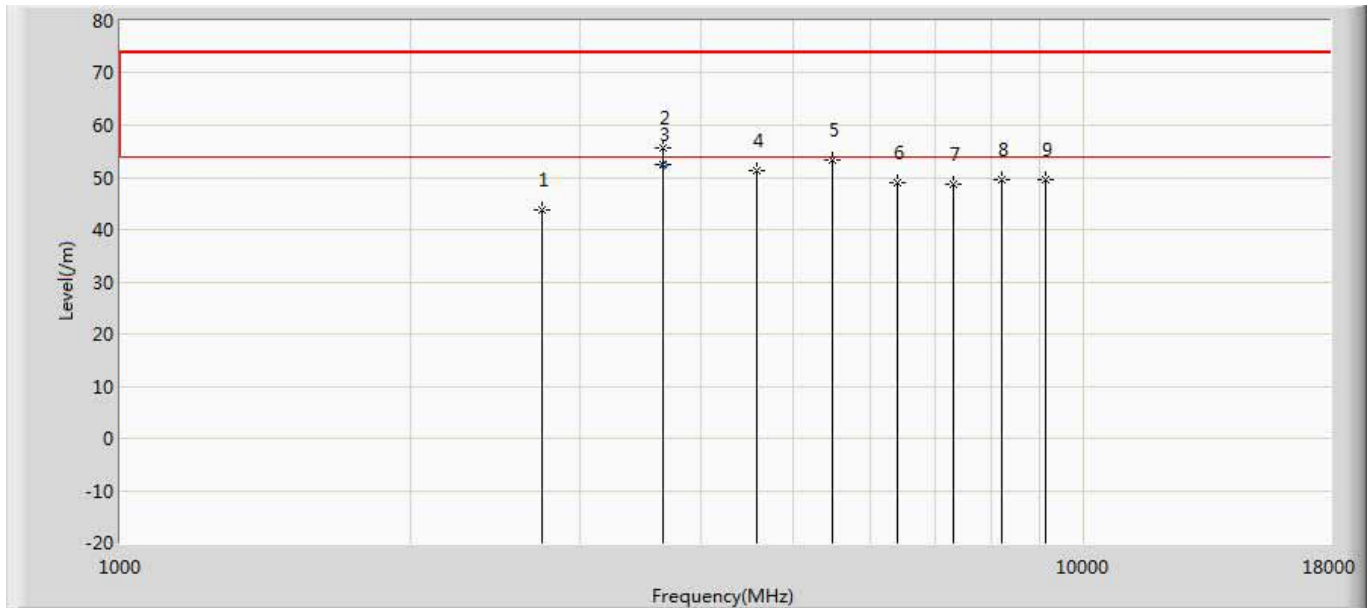

No	Mark	Frequency (MHz)	Measure Level (μm)	Reading Level (μm)	Over Limit (dB)	Limit (μm)	Factor (dB)	Type
1		2741.100	43.872	42.867	-30.128	74.000	1.005	PK
2		3652.000	55.530	52.988	-18.470	74.000	2.542	PK
3	*	3653.670	52.370	49.802	-1.630	54.000	2.567	AV
4		4570.000	51.437	47.268	-22.563	74.000	4.169	PK
5		5479.500	53.319	47.802	-20.681	74.000	5.517	PK
6		6395.900	49.125	42.268	-24.875	74.000	6.857	PK
7		7309.600	48.673	40.929	-25.327	74.000	7.744	PK
8		8223.300	49.432	41.091	-24.568	74.000	8.341	PK
9		9137.000	49.472	40.410	-24.528	74.000	9.061	PK

Engineer: Pawn	
Site: AC5	Time: 2019/03/25 - 16:50
Limit: FCC_Part15.209_RE(3m)	Margin: 0
Probe: Horn_3117_00167055(1-18GHz)	Polarity: Horizontal
EUT: Ring Bridge	Power: AC 120V/60Hz
Note: Mode1:Transmit at 927.3MHz by LORA	

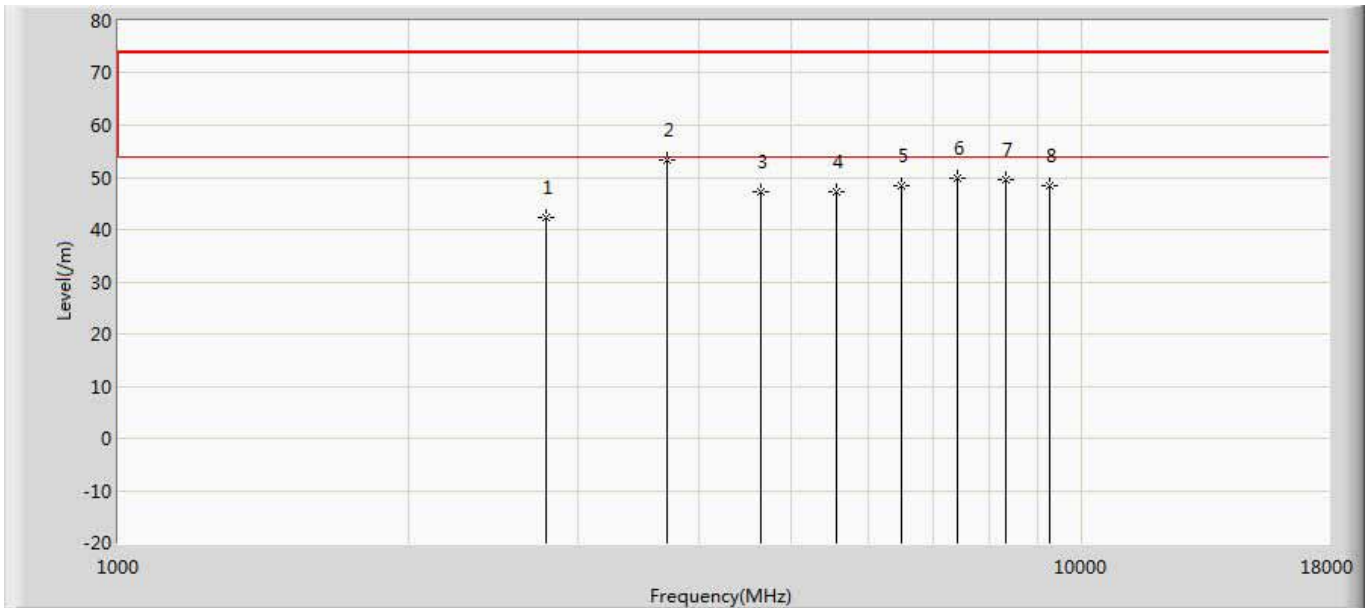

No	Mark	Frequency (MHz)	Measure Level (m)	Reading Level (m)	Over Limit (dB)	Limit (m)	Factor (dB)	Type
1		2781.900	42.453	41.314	-31.547	74.000	1.139	PK
2	*	3711.500	53.274	50.375	-20.726	74.000	2.899	PK
3		4636.500	47.327	43.126	-26.673	74.000	4.201	PK
4		5563.800	47.285	41.655	-26.715	74.000	5.630	PK
5		6491.100	48.491	41.470	-25.509	74.000	7.021	PK
6		7418.400	49.822	41.919	-24.178	74.000	7.903	PK
7		8345.700	49.668	41.444	-24.332	74.000	8.224	PK
8		9273.000	48.327	39.189	-25.673	74.000	9.137	PK



Engineer: Pawn	
Site: AC5	Time: 2019/03/25 - 17:08
Limit: FCC_Part15.209_RE(3m)	Margin: 0
Probe: Horn_3117_00167055(1-18GHz)	Polarity: Vertical
EUT: Ring Bridge	Power: AC 120V/60Hz
Note: Mode1:Transmit at 927.3MHz by LORA	

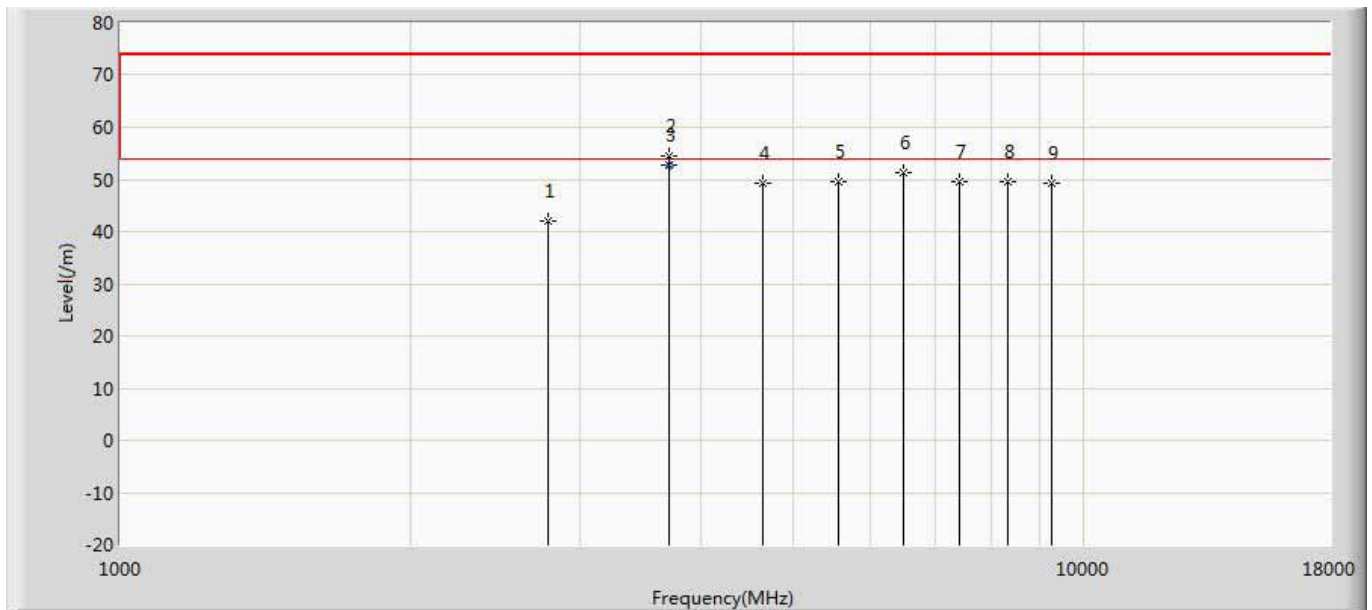

No	Mark	Frequency (MHz)	Measure Level (µm)	Reading Level (µm)	Over Limit (dB)	Limit (µm)	Factor (dB)	Type
1		2781.900	42.118	40.979	-31.882	74.000	1.139	PK
2		3711.500	54.631	51.732	-19.369	74.000	2.899	PK
3	*	3711.540	52.766	49.867	-1.234	54.000	2.899	AV
4		4636.500	49.238	45.037	-24.762	74.000	4.201	PK
5		5563.800	49.547	43.917	-24.453	74.000	5.630	PK
6		6491.100	51.184	44.163	-22.816	74.000	7.021	PK
7		7418.400	49.439	41.536	-24.561	74.000	7.903	PK
8		8345.700	49.482	41.258	-24.518	74.000	8.224	PK
9		9273.000	49.173	40.035	-24.827	74.000	9.137	PK

**Note:**

1. Measured Level = Reading Level + Factor.
2. The test frequency range, 9kHz~30MHz, the worst case are at least 20dB below the limits, therefore no data appear in the report.
3. This limit applies for using average detector, if the test result on peak is lower than average limit, then average measurement needn't be performed.
4. As the radiated emission was performed, so conducted emission was not tested.

**The worst case of Radiated Emission below 1GHz:**

Engineer: Leon	
Site: AC2	Time: 2019/03/25
Limit: FCC_Part15.209_RE(3m)_ClassB	Margin: 0
Probe: AC2_3M(30-1000M)	Polarity: Horizontal
EUT: Ring Bridge	Power: AC 120V/60Hz
Note: Mode 1	

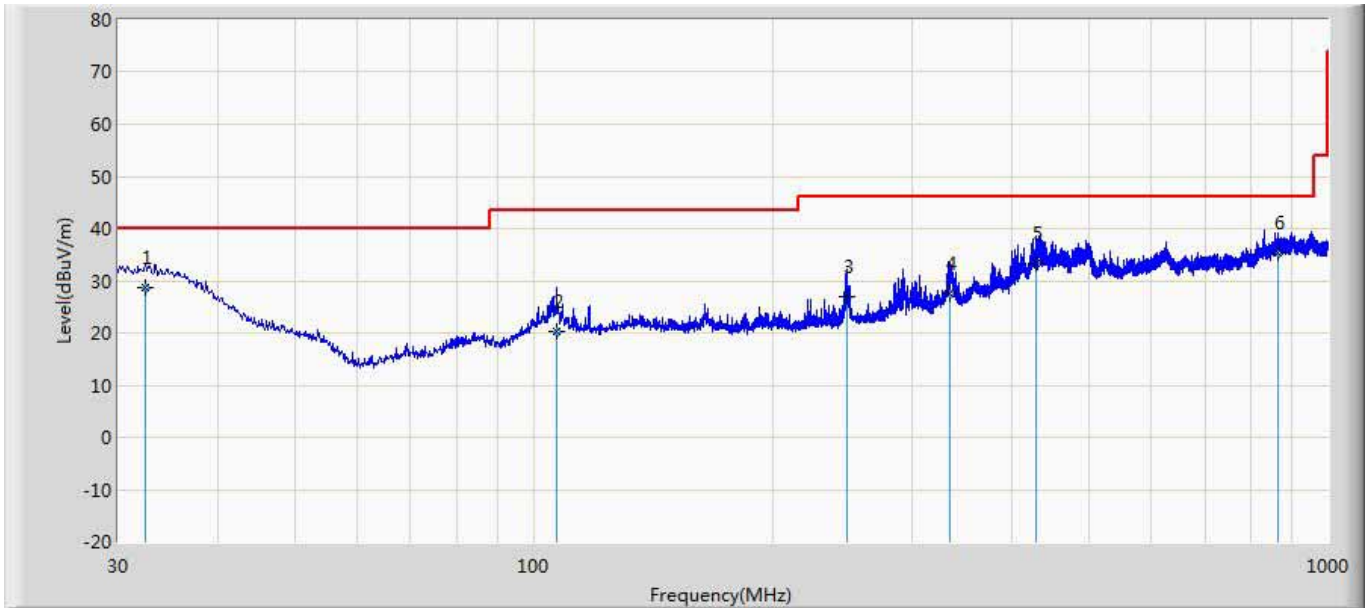

No	Mark	Frequency (MHz)	Measure Level (dBuV/m)	Reading Level (dBuV)	Over Limit (dB)	Limit (dBuV/m)	Probe (dB/m)	Cable (dB)	Amp (dB)	Ant Pos (cm)	Table Pos (deg)	Type
1		32.425	28.578	1.200	-11.422	40.000	20.733	6.645	0.000	300	208	QP
2		106.874	20.345	3.600	-23.155	43.500	9.824	6.921	0.000	400	138	QP
3		248.250	26.911	8.900	-19.089	46.000	10.450	7.561	0.000	200	0	QP
4		334.823	27.520	4.600	-18.480	46.000	15.185	7.735	0.000	100	324	QP
5		429.034	33.398	6.800	-12.602	46.000	18.622	7.975	0.000	300	316	QP
6	*	865.898	35.290	2.300	-10.710	46.000	23.822	9.168	0.000	300	151	QP

Note:

- " \* ", means this data is the worst emission level.
- Measurement Level = Reading Level + Factor(Probe+Cable-Amp).

Engineer: Leon	
Site: AC2	Time: 2019/03/25
Limit: FCC_Part15.209_RE(3m)_ClassB	Margin: 0
Probe: AC2_3M(30-1000M)	Polarity: Vertical
EUT: Ring Bridge	Power: AC 120V/60Hz
Note: Mode 1	

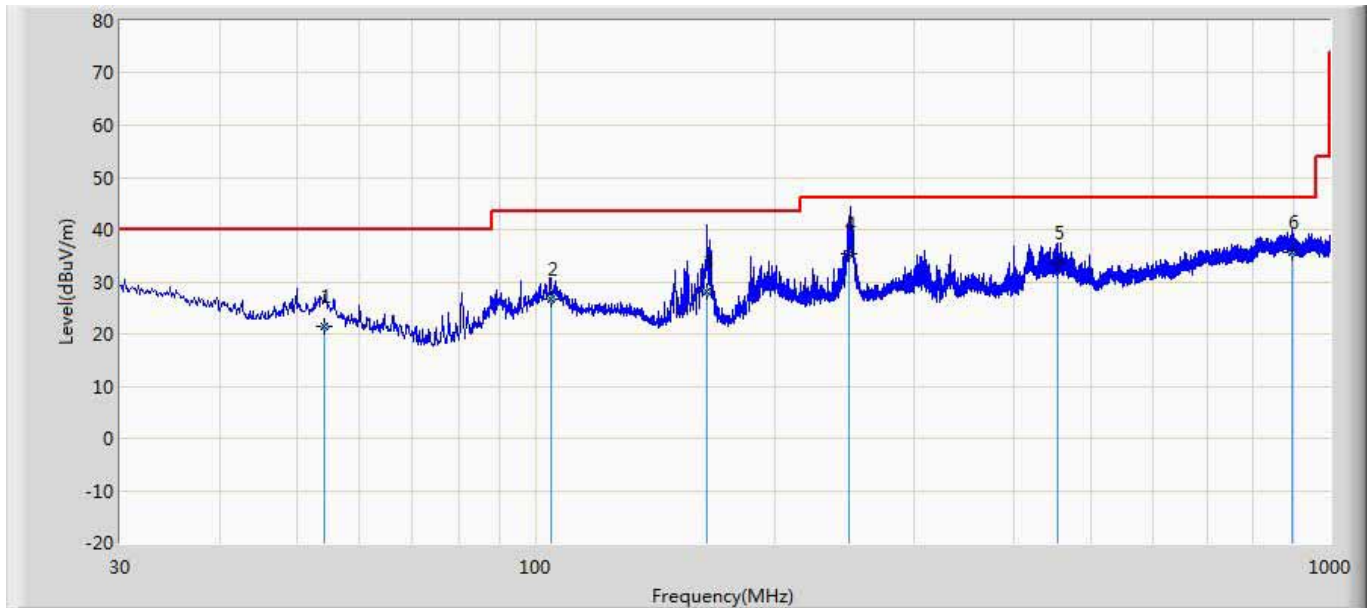

No	Mark	Frequency (MHz)	Measure Level (dBuV/m)	Reading Level (dBuV)	Over Limit (dB)	Limit (dBuV/m)	Probe (dB/m)	Cable (dB)	Amp (dB)	Ant Pos (cm)	Table Pos (deg)	Type
1		54.250	21.468	3.600	-18.532	40.000	11.250	6.618	0.000	100	32	QP
2		104.569	26.692	4.300	-16.808	43.500	15.487	6.905	0.000	100	340	QP
3		164.466	28.216	8.600	-15.284	43.500	12.355	7.261	0.000	100	32	QP
4		248.405	35.333	10.900	-10.667	46.000	16.871	7.562	0.000	100	74	QP
5		455.224	33.569	7.500	-12.431	46.000	18.070	7.999	0.000	300	180	QP
6	*	895.846	35.538	1.900	-10.462	46.000	24.399	9.240	0.000	200	309	QP

**Note:**

1. " \* ", means this data is the worst emission level.
2. Measurement Level = Reading Level + Factor(Probe+Cable-Amp).

## 4. Fundamental emission output power

### 4.1. Test Equipment

Fundamental emission output power/ TR-8					
Instrument	Manufacturer	Type No.	Serial No.	Cal. Date	Cal. Due Date
Spectrum Analyzer	Agilent	E4446A	MY45300103	2019.01.04	2020.01.03
Spectrum Analyzer	Agilent	N9010A	MY48030494	2019.02.04	2020.02.03
Wideband Peak Power Meter	Anritsu	ML2495A	0905006	2018.10.14	2019.10.13
Power Sensor	Anritsu	MA2411B	0846014	2018.10.14	2019.10.13
Temperature/Humidity Meter	zhicheng	ZC1-2	TR8-TH	2018.04.10	2019.04.09

Note: All equipments are calibrated with traceable calibrations. Each calibration is traceable to the national or international standards.

### 4.2. Test Setup

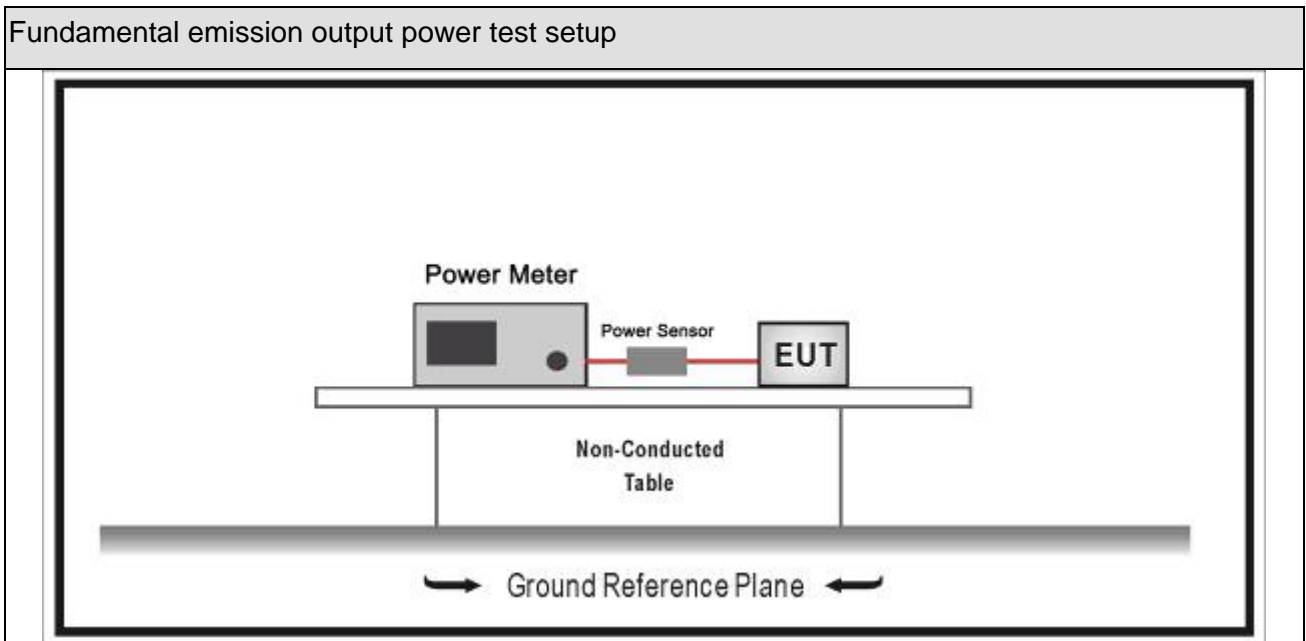



### 4.3. Limit

Fundamental emission output power Limit		
<input checked="" type="checkbox"/>	$G_{TX} < 6\text{dBi}$	$P_{out} \leq 30\text{dBm}$
<input type="checkbox"/>	$G_{TX} > 6\text{dBi}$	
<input type="checkbox"/>	Non-Fix point-point	$P_{out} \leq 30 - (G_{TX} - 6)$
<input type="checkbox"/>	Fix point-point	$P_{out} \leq 30 - [(G_{TX} - 6)]/3$
<input type="checkbox"/>	Point-to-multipoint	$P_{out} \leq 30 - (G_{TX} - 6)$
<input type="checkbox"/>	Overlap Beams	$P_{out} \leq 30 - [(G_{TX} - 6)]/3$
<input type="checkbox"/>	Aggregate power transmitted simultaneously on all beams	$P_{out} \leq 30 - [(G_{TX} - 6)]/3$
<input type="checkbox"/>	single directional beam	$P_{out} \leq 30 - [(G_{TX} - 6)]/3 + 8\text{dB}$
<p>Note 1 : <math>G_{TX}</math> directional gain of transmitting antennas.</p> <p>Note 2 : <math>P_{out}</math> is maximum peak conducted output power .</p>		

#### 4.4. Test Procedure

Fundamental emission output power Test Method						
	References Rule		Chapter	Description		
<input checked="" type="checkbox"/>	ANSI C63.10		11.9	Fundamental emission output power		
	<input type="checkbox"/>	ANSI C63.10		11.9.1	Maximum peak conducted output power	
		<input type="checkbox"/>	ANSI C63.10	11.9.1.1	RBW DTS bandwidth	
		<input type="checkbox"/>	ANSI C63.10	11.9.1.2	Integrated band power method	
		<input type="checkbox"/>	ANSI C63.10	11.9.1.3	PKPM1 Peak power meter method	
	<input checked="" type="checkbox"/>	ANSI C63.10		11.9.2	Maximum conducted (average) output power	
		<input type="checkbox"/>	ANSI C63.10		11.9.2.2	Measurement using a spectrum analyzer (SA)
			<input type="checkbox"/>	ANSI C63.10	11.9.2.2.2	Method AVGSA-1(Duty cycle 98%)
			<input type="checkbox"/>	ANSI C63.10	11.9.2.2.3	Method AVGSA-1A(Duty cycle 98%)
			<input type="checkbox"/>	ANSI C63.10	11.9.2.2.4	Method AVGSA-2(Duty cycle 98%)
			<input type="checkbox"/>	ANSI C63.10	11.9.2.2.5	Method AVGSA-2A(Duty cycle 98%)
			<input type="checkbox"/>	ANSI C63.10	11.9.2.2.4	Method AVGSA-3
			<input type="checkbox"/>	ANSI C63.10	11.9.2.2.5	Method AVGSA-3A
		<input checked="" type="checkbox"/>	ANSI C63.10		11.9.2.3	Measurement using a power meter (PM)
		<input checked="" type="checkbox"/>	ANSI C63.10	11.9.2.3.1	Method AVGPM	
		<input type="checkbox"/>	ANSI C63.10	11.9.2.3.2	Method AVGPM-G	

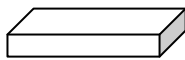
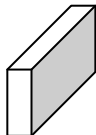
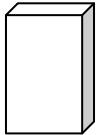
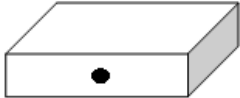
**4.5. EUT test definition**

Item	Fundamental emission output power			
Device Category	<input checked="" type="checkbox"/>	Fixed position use		
	<input type="checkbox"/>	Mobile position use		
Test mode	Mode 1			
Test method	<input type="checkbox"/>	Radiated		
		X Axis	Y Axis	Z Axis
				
		Worst Axis <input type="checkbox"/>	Worst Axis <input type="checkbox"/>	Worst Axis <input type="checkbox"/>
	<input checked="" type="checkbox"/>	Conducted		
	<input checked="" type="checkbox"/>	Chain 0		
				
	<input type="checkbox"/>	Chain 0	Chain 1	
				
<input type="checkbox"/>	Chain 0	Chain 1	Chain 2	
				

#### 4.6. Test Result

Product Name	: Ring Bridge	Power	: AC 120V/60Hz
Test Mode	: Mode1	Test Site	: TR8
Test Date	: 2019.03.25		

Mode	Channel	Test Frequency (MHz)	Average Power Output (dBm)	Antenna Gain (dBi)	Limit (dBm)	Result
1	Low	902.5	18.07	-1	30	Pass
1	Mid	913.7	18.18	-1	30	Pass
1	High	927.3	18.14	-1	30	Pass

\_\_\_\_\_ The End \_\_\_\_\_