



Test Report

FCC Part15 Subpart C

Product Name : Ring Bridge
Model No. : 5B01S8
FCC ID : 2AEUPBHARB001

Applicant : Ring, LLC.

Address : 1523 26th St, Santa Monica, CA 90404

Date of Receipt : Dec. 21, 2018
Test Date : Dec. 21, 2018 ~ Dec. 26, 2018
Issued Date : Jan. 04, 2019
Report No. : 18C2098R-RF-US-P06V02
Report Version : V1.1

The test results relate only to the samples tested.

The test results shown in the test report are traceable to the national/international standard through the calibration of the equipment and evaluated measurement uncertainty herein.

This report must not be used to claim product endorsement by TAF, A2LA or any agency of the government.

The test report shall not be reproduced without the written approval of DEKRA Testing & Certification (Suzhou) Co., Ltd.

Test Report Certification

Issued Date : Jan. 04, 2019
Report No. : 18C2098R-RF-US-P06V02



Product Name : Ring Bridge
 Applicant : Ring, LLC.
 Address : 1523 26th St, Santa Monica, CA 90404
 Manufacturer : Ring, LLC.
 Address : 1523 26th St, Santa Monica, CA 90404
 Model No. : 5B01S8
 FCC ID : 2AEUPBHARB001
 EUT Voltage : DC 5V
 Test Voltage : AC 120V/60Hz
 Brand Name : ring
 Applicable Standard : FCC CFR Title 47 Part 15 Subpart C
 KDB558074 D01V05
 Test Result : Complied
 Performed Location : DEKRA Testing & Certification (Suzhou) Co., Ltd.
 No.99 Hongye Rd., Suzhou Industrial Park, Suzhou, 215006,
 Jiangsu, China
 TEL: +86-512-6251-5088 / FAX: +86-512-6251-5098
 FCC Registration Number: CN1199

Documented By : Kathy Feng
 (Project Assistant: Kathy Feng)

Reviewed By : Frank He
 (Senior Project Manager: Frank He)

Approved By : Jack Zhang
 (Engineer Supervisor: Jack Zhang)

TABLE OF CONTENTS

Description	Page
1. General Information.....	6
1.1. EUT Description	6
1.2. Antenna information	8
1.3. Mode of Operation.....	9
1.4. Tested System Details	9
1.5. Configuration of Tested System.....	10
2. Technical Test.....	12
2.1. Summary of Test Result.....	12
2.2. Test Frequency configuration:.....	13
2.3. Duty Cycle	14
2.4. Test Environment.....	15
2.5. Measurement Uncertainty.....	15
3. AC Power Line Conducted Emission.....	16
3.1. Test Equipment.....	16
3.2. Test Setup.....	16
3.3. Limit.....	17
3.4. Test Procedure	17
3.5. Test Result.....	18
4. Emissions in restricted frequency bands	20
4.1. Test Equipment.....	20
4.2. Test Setup.....	21
4.3. Limit.....	22
4.4. Test Procedure	24
4.5. EUT test Axis definition.....	25
4.6. Test Result.....	26
5. Emissions in non-restricted frequency bands	34
5.1. Test Equipment.....	34
5.2. Test Setup.....	34
5.3. Limit.....	35
5.4. Test Procedure	36
5.5. EUT test Axis definition.....	37
5.6. Test Result.....	38
6. Occupied Bandwidth.....	39
6.1. Test Equipment.....	39
6.2. Test Setup.....	39
6.3. Limit.....	40
6.4. Test Procedure	40

- 6.5. EUT test definition41
- 6.6. Test Result.....42
- 7. Fundamental emission output power43
 - 7.1. Test Equipment.....43
 - 7.2. Test Setup.....43
 - 7.3. Limit.....44
 - 7.4. Test Procedure45
 - 7.5. EUT test definition46
 - 7.6. Test Result.....47
- 8. Power Spectral Density48
 - 8.1. Test Equipment.....48
 - 8.2. Test Setup.....48
 - 8.3. Limit.....48
 - 8.4. Test Procedure49
 - 8.5. EUT test definition50
 - 8.6. Test Result.....51
- 9. Antenna Requirement.....52
 - 9.1. Limit.....52
 - 9.2. Antenna Connector Construction.....52

History of This Test Report

REPORT NO.	VERSION	DESCRIPTION	ISSUED DATE
18C2098R-RF-US-P06V02	V1.0	Initial Issued Report	Jan. 03, 2019
18C2098R-RF-US-P06V02	V1.1	Page 27/28, add AV Value	Jan. 04, 2019

1. General Information

1.1. EUT Description

Product Name	Ring Bridge
Model No.	5B01S8
EUT Voltage	DC 5V
Frequency Range	902~928MHz
Channel Number	9
Type of Modulation	LoRa
Data Rate	DR4:12500bps
Channel Control	Auto

Working Frequency of Each Channel							
Channel	Frequency	Channel	Frequency	Channel	Frequency	Channel	Frequency
00	902.5 MHz	01	903.3 MHz	02	913.7 MHz	03	923.3 MHz
04	924.1 MHz	05	924.9 MHz	06	925.7 MHz	07	926.5 MHz
08	927.3 MHz	N/A	N/A	N/A	N/A	N/A	N/A

1.2. Antenna information

Model No.	N/A							
Antenna manufacturer	N/A							
Antenna Delivery	<input checked="" type="checkbox"/>	1*TX+1*RX	<input type="checkbox"/>	2*TX+2*RX	<input type="checkbox"/>	3*TX+3*RX	<input type="checkbox"/>	4*TX+4*RX
Antenna technology	<input checked="" type="checkbox"/>	SISO						
	<input type="checkbox"/>	MIMO	<input type="checkbox"/>	Basic				
			<input type="checkbox"/>	CDD				
			<input type="checkbox"/>	Sectorized				
			<input type="checkbox"/>	Beam-forming				
Antenna Type	<input type="checkbox"/>	External	<input type="checkbox"/>	Dipole				
			<input type="checkbox"/>	Sectorized				
	<input checked="" type="checkbox"/>	Internal	<input type="checkbox"/>	PIFA				
			<input checked="" type="checkbox"/>	PCB				
			<input type="checkbox"/>	Ceramic Chip Antenna				
			<input type="checkbox"/>	Metal plate type F antenna				
	Antenna Gain	-1dBi						

1.3. Mode of Operation

Test Modes List
Mode 1: Transmit

Note:

1. For portable device, radiated spurious emission was verified over X, Y, Z Axis, and shown the worst case on this report.
2. Regards to the frequency band operation for systems using DSSS modulation
3. The extreme test condition for voltage and temperature were declared by the manufacturer.
4. The reading values of all the test items contain cable loss.

1.4. Tested System Details

The types for all equipment, plus descriptions of all cables used in the tested system (including inserted cards) are:

No.	Product	Manufacturer	Model No.	Serial No.	Power Cord
1	Notebook	Lenovo	Think pad x220	SUA0600195	Power by adapter
A	USB Cable	N/A	N/A	N/A	Shield, 0.75m
B	Serial Cable	N/A	N/A	N/A	Shield, 0.75m
C	USB Cable	N/A	N/A	N/A	Shield, 10m
D	Serial Cable	N/A	N/A	N/A	Shield, 10m

1.5. Configuration of Tested System

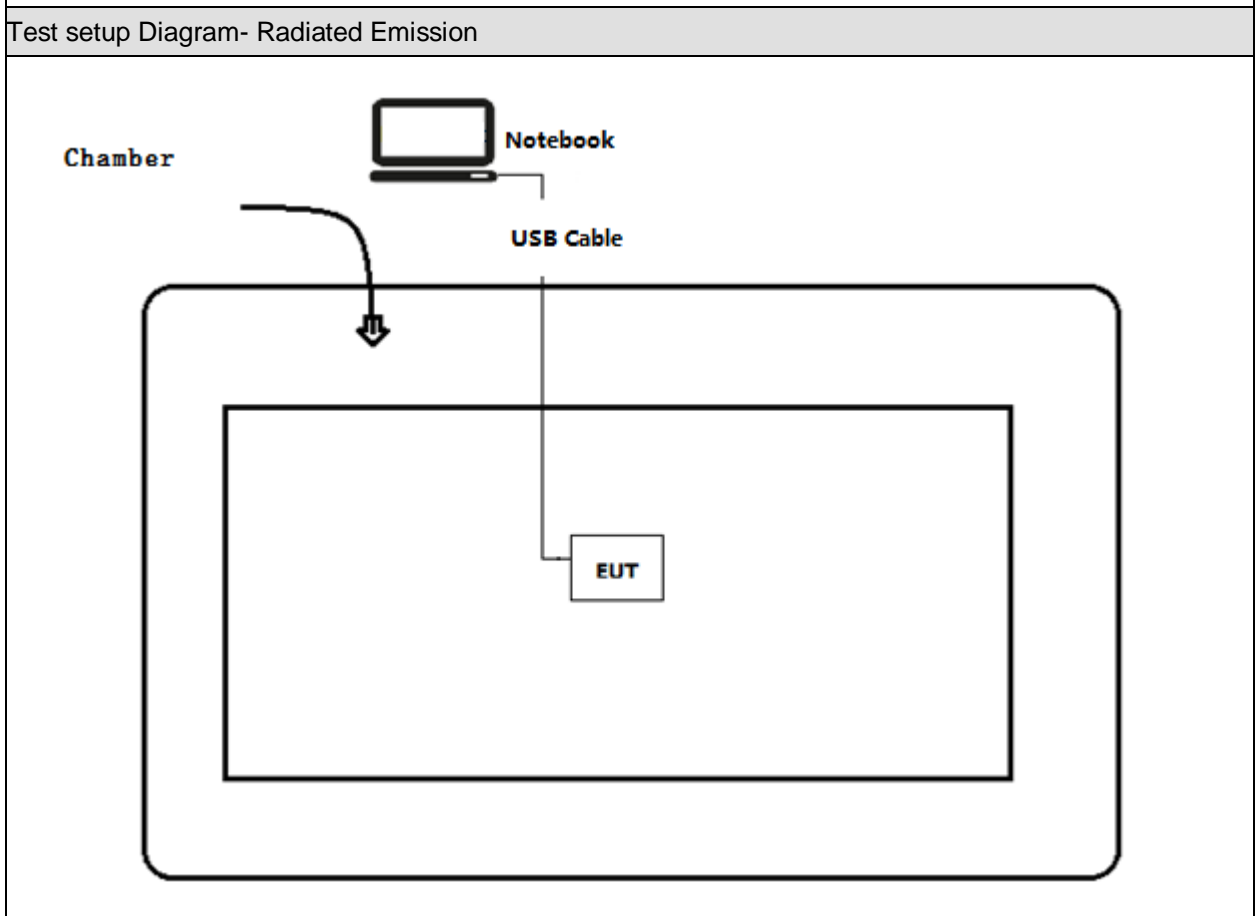
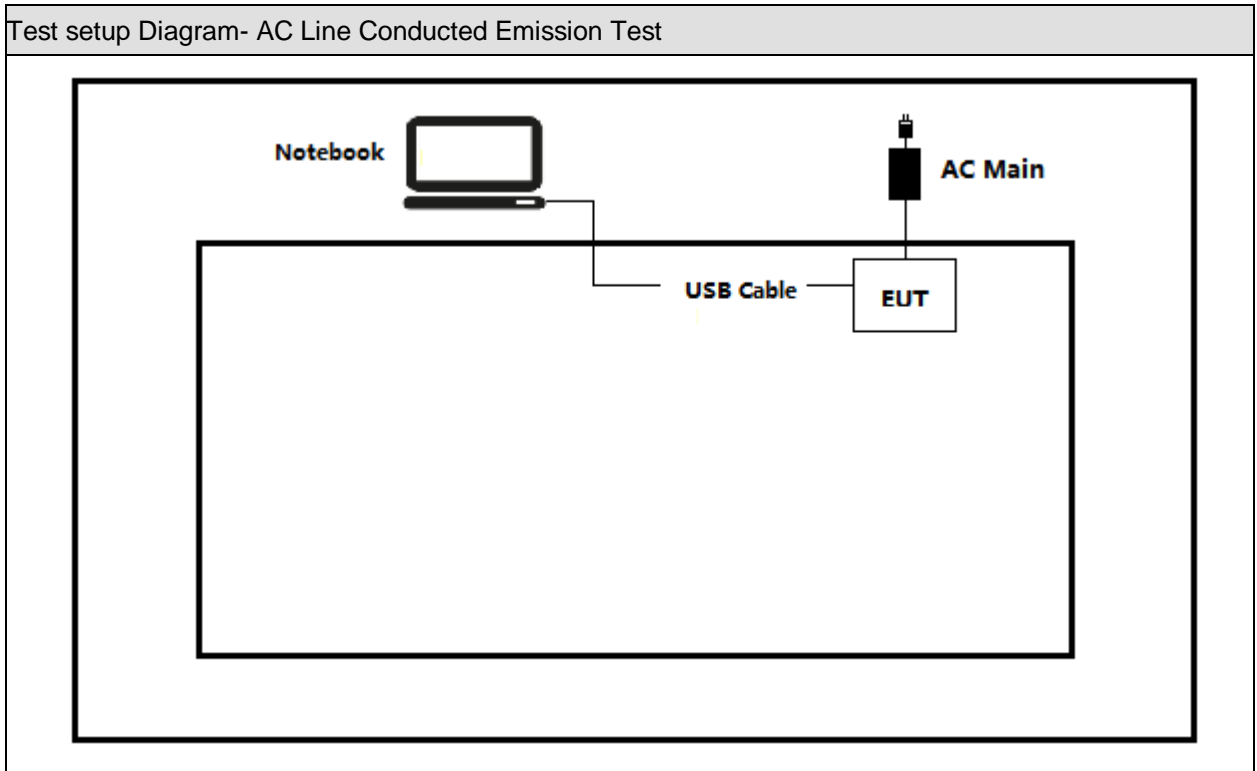

1.6. EUT Exercise Software

1	Setup the EUT and simulators as shown on above.
2	Turn on the power of all equipment.
3	Run cmd ", and set the test mode and channel, then start continue Transmit.

2. Technical Test

2.1. Summary of Test Result

Performed Test Item	Normative References	Limit	Result
AC Power Line Conducted Emission	FCC CFR Title 47 Part 15 Subpart C: 2015 Section 15.207	FCC 15.207	PASS
Emissions in restricted frequency bands	FCC CFR Title 47 Part 15 Subpart C: 2015 Section 15.209	FCC 15.209	PASS
Emissions in non-restricted frequency bands	FCC CFR Title 47 Part 15 Subpart C: 2015 Section 15.247(d)	$\geq 30\text{dBc}$	PASS
Radiated Emission Band Edge	FCC CFR Title 47 Part 15 Subpart C: 2015 15.247(d)	FCC 15.209	PASS
Occupied Bandwidth	FCC CFR Title 47 Part 15 Subpart C: 2015 Section 15.247(a)(2)	$\geq 500\text{kHz}$	PASS
Fundamental emission output power	FCC CFR Title 47 Part 15 Subpart C: 2015 Section 15.247(b)(3)	$\leq 30\text{dBm}$	PASS
Power Spectral Density	FCC CFR Title 47 Part 15 Subpart C: 2015 Section 15.247(e)	$\leq 8\text{dBm}/3\text{kHz}$	PASS
Antenna Requirement	FCC CFR Title 47 Part 15 Subpart C: 2015 Section 15.203	FCC 15.203	PASS

2.2. Test Frequency configuration:

Channel	Frequency	Channel	Frequency	Channel	Frequency
Low	902.5 MHz	Mid	913.7 MHz	High	927.3MHz

2.3. Duty Cycle

Test Mode	Tx On (ms)	Tx Off (ms)	VBW	Tx On + Tx Off (ms)	Duty Cycle
1	N/A	N/A	10Hz	N/A	100%

2.4. Test Environment

Items	Required (IEC 68-1)	Actual
Temperature (°C)	15-35	21
Humidity (%RH)	25-75	50
Barometric pressure (mbar)	860-1060	950-1000

2.5. Measurement Uncertainty

Test Items	Uncertainty
AC Power Line Conducted Emission	±2.02dB
Radiated Emission	Below 1GHz ±3.8 dB
	Above 1GHz ±3.9 dB
RF Antenna Port Conducted Emission	±1.27dB
Radiated Emission Band Edge	±3.9dB
Occupied Bandwidth	±1kHz
Power Spectral Density	±1.27dB

3. AC Power Line Conducted Emission

3.1. Test Equipment

AC Power Line Conducted Emission / TR-1					
Instrument	Manufacturer	Type No.	Serial No.	Cal. Date	Cal. Due Date
EMI Test Receiver	R&S	ESCI	100906	2018.03.05	2019.03.04
Two-Line V-Network	R&S	ENV 216	101189	2018.07.16	2019.07.15
Two-Line V-Network	R&S	ENV 216	101044	2018.09.04	2019.09.03
50ohm Coaxial Switch	Anritsu	MP59B	6200464462	N/A	N/A
50ohm Termination	SHX	TF2	07081402	2018.09.04	2019.09.03
Temperature/Humidity Meter	Zhichen	ZC1-2	TR1-TH	2018.01.05	2019.01.04

Note: All equipments are calibrated with traceable calibrations. Each calibration is traceable to the national or international standards.

3.2. Test Setup

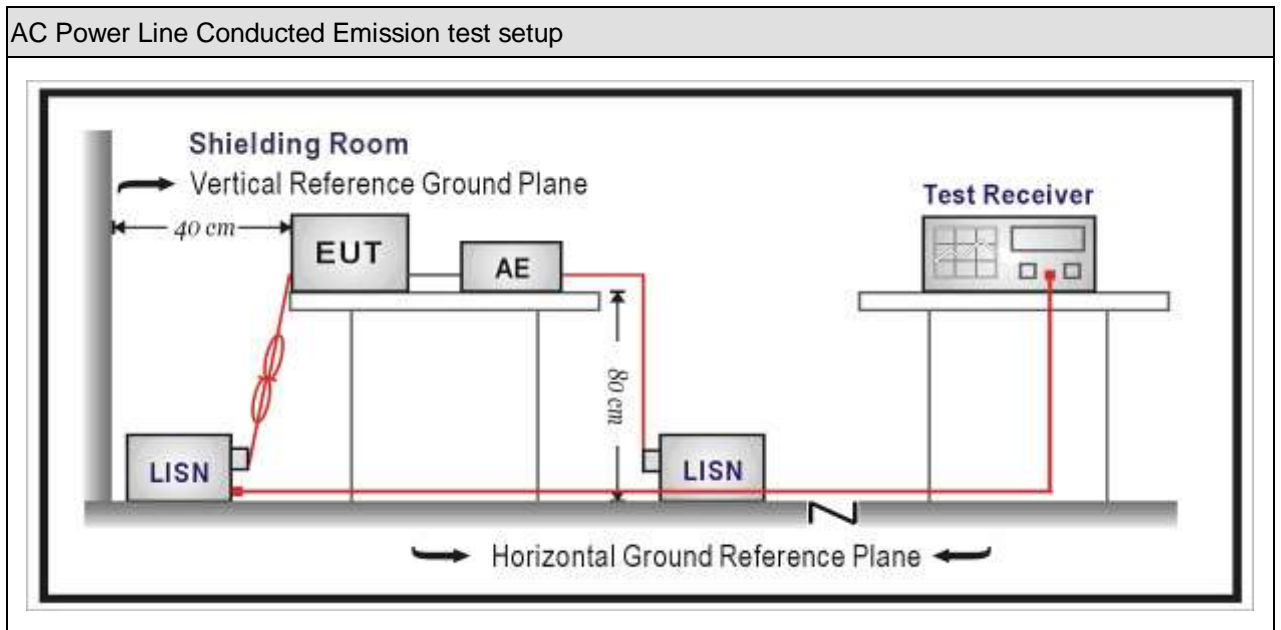

3.3. Limit

Frequency of Emission (MHz)	Conducted Limit	
	Quasi-peak (dB μ V)	Average(dB μ V)
0.15-0.5	66 to 56	56 to 46
0.5-5	56	46
5-30	60	50

Note 1: The lower limit shall apply at the transition frequencies.
 Note 2: The limit decreases linearly with the logarithm of the frequency in the range 0.15 MHz to 0.5 MHz.

3.4. Test Procedure

Test Method			
	References Rule	Chapter	Item
<input checked="" type="checkbox"/>	ANSI C63.10-2013	6.2	Standard test method for ac power-line conducted emissions from unlicensed wireless devices

3.5. Test Result

Engineer: Nero	
Site: TR1	Time: 2018/12/21
Limit: FCC_Part15.107_CE_AC Power_ClassB	Margin: 0
Probe: ENV216_101190(0.009-30MHz)	Polarity: Line
EUT: Ring Bridge	Power: AC 120V/60Hz
Note: Mode 1	

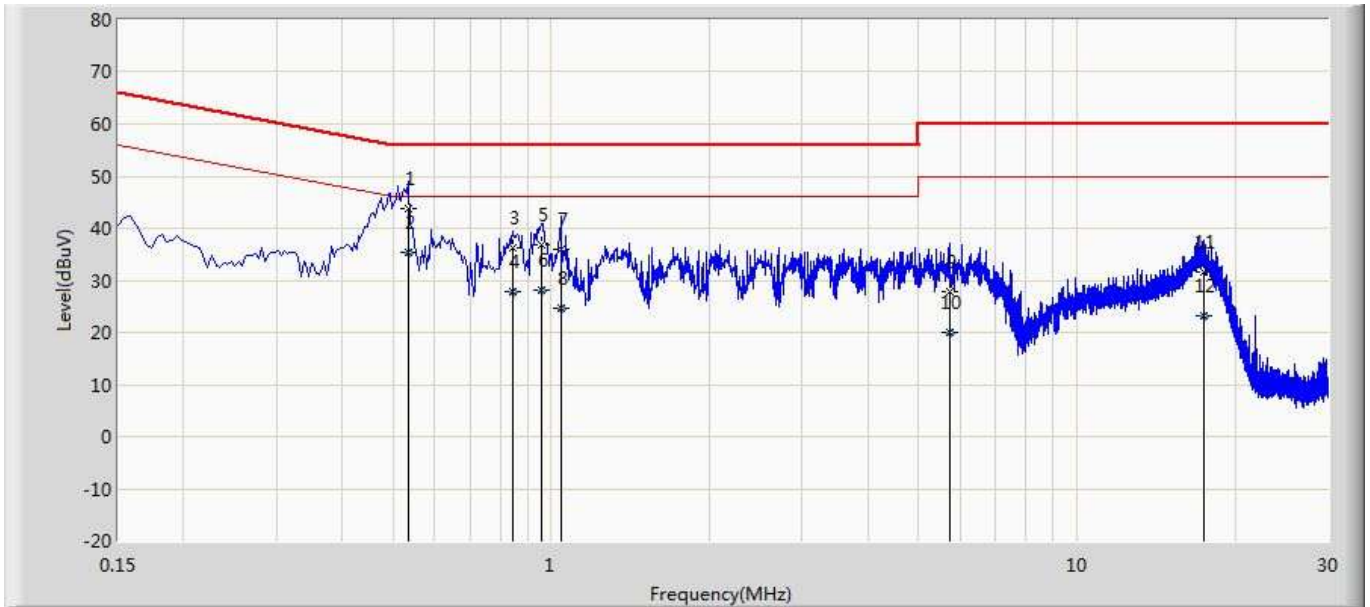

No	Mark	Frequency (MHz)	Measure Level (dBuV)	Reading Level (dBuV)	Over Limit (dB)	Limit (dBuV)	Probe (dB)	Cable (dB)	Amp (dB)	Type
1		0.534	43.710	34.066	-12.290	56.000	9.600	0.044	0.000	QP
2	*	0.534	35.370	25.726	-10.630	46.000	9.600	0.044	0.000	AV
3		0.846	36.098	26.439	-19.902	56.000	9.605	0.054	0.000	QP
4		0.846	27.784	18.125	-18.216	46.000	9.605	0.054	0.000	AV
5		0.958	36.906	27.238	-19.094	56.000	9.609	0.059	0.000	QP
6		0.958	28.130	18.462	-17.870	46.000	9.609	0.059	0.000	AV
7		1.042	35.870	26.198	-20.130	56.000	9.610	0.061	0.000	QP
8		1.042	24.560	14.889	-21.440	46.000	9.610	0.061	0.000	AV
9		5.726	27.897	18.070	-32.103	60.000	9.675	0.152	0.000	QP
10		5.726	19.927	10.100	-30.073	50.000	9.675	0.152	0.000	AV
11		17.470	31.707	21.420	-28.293	60.000	10.018	0.269	0.000	QP
12		17.470	23.076	12.788	-26.924	50.000	10.018	0.269	0.000	AV

Note:

1. " * ", means this data is the worst emission level.

2. Measurement Level = Reading Level + Factor(Probe+Cable-Amp).

Engineer: Nero	
Site: TR1	Time: 2018/12/21
Limit: FCC_Part15.107_CE_AC Power_ClassB	Margin: 0
Probe: ENV216_101190(0.009-30MHz)	Polarity: Neutral
EUT: Ring Bridge	Power: AC 120V/60Hz
Note: Mode 1	

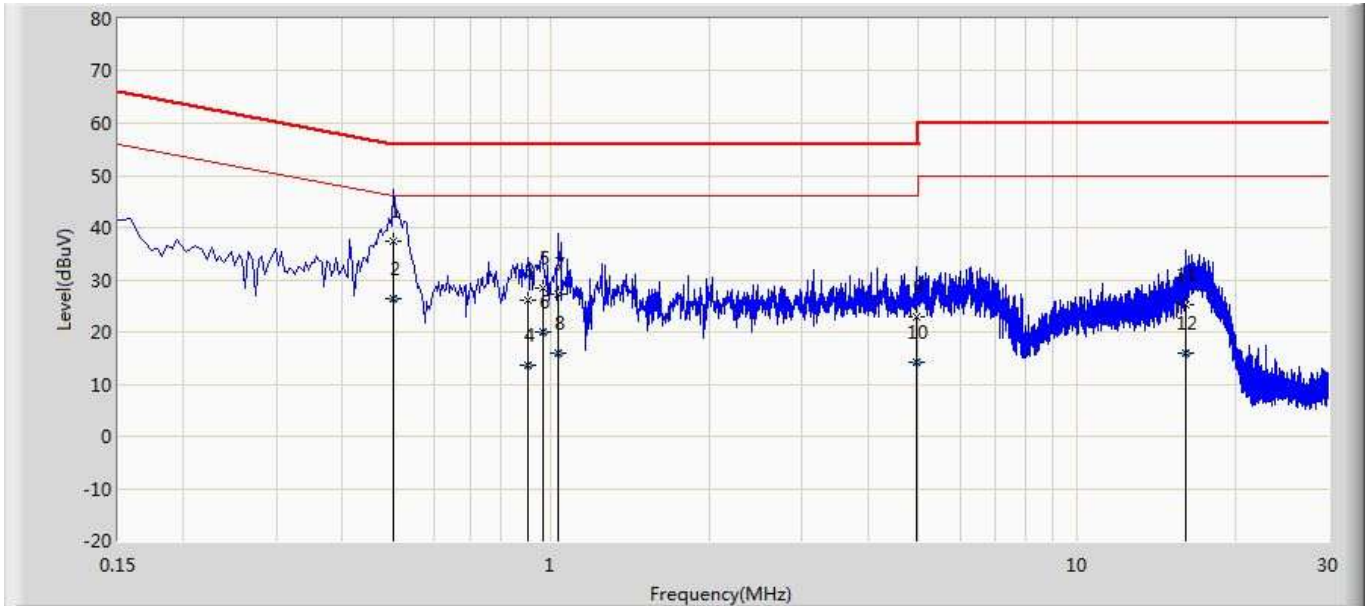

No	Mark	Frequency (MHz)	Measure Level (dBuV)	Reading Level (dBuV)	Over Limit (dB)	Limit (dBuV)	Probe (dB)	Cable (dB)	Amp (dB)	Type
1	*	0.502	37.400	27.765	-18.600	56.000	9.590	0.044	0.000	QP
2		0.502	26.459	16.824	-19.541	46.000	9.590	0.044	0.000	AV
3		0.902	26.182	16.536	-29.818	56.000	9.590	0.056	0.000	QP
4		0.902	13.603	3.957	-32.397	46.000	9.590	0.056	0.000	AV
5		0.962	28.520	18.871	-27.480	56.000	9.590	0.059	0.000	QP
6		0.962	19.991	10.342	-26.009	46.000	9.590	0.059	0.000	AV
7		1.030	27.288	17.636	-28.712	56.000	9.591	0.062	0.000	QP
8		1.030	15.869	6.217	-30.131	46.000	9.591	0.062	0.000	AV
9		4.954	22.835	13.044	-33.165	56.000	9.649	0.142	0.000	QP
10		4.954	14.130	4.339	-31.870	46.000	9.649	0.142	0.000	AV
11		16.134	25.284	15.016	-34.716	60.000	10.010	0.258	0.000	QP
12		16.134	15.848	5.580	-34.152	50.000	10.010	0.258	0.000	AV

Note:

1. " * ", means this data is the worst emission level.
2. Measurement Level = Reading Level + Factor(Probe+Cable-Amp).

4. Emissions in restricted frequency bands

4.1. Test Equipment

Radiated Emission(Below 1GHz) / AC-2					
Instrument	Manufacturer	Type No.	Serial No.	Cal. Date	Cal. Due Date
EMI Test Receiver	R&S	ESCI	100573	2018.03.05	2019.03.04
Loop Antenna	R&S	HFH2-Z2	833799/003	2018.11.07	2019.11.06
Bilog Antenna	Teseq GmbH	CBL6112D	27611	2018.08.10	2019.08.09
Coaxial Cable	Huber+Suhner	SUCOFLEX 106	AC2-C	2018.02.28	2019.02.27
Temperature/Humidity Meter	Zhichen	ZC1-2	AC2-TH	2018.01.05	2019.01.04
Note: All equipments are calibrated with traceable calibrations. Each calibration is traceable to the national or international standards.					

Radiated Emission(Above 1GHz) / AC-5					
Instrument	Manufacturer	Type No.	Serial No.	Cal. Date	Cal. Due Date
Spectrum Analyzer	Agilent	E4446A	MY45300103	2018.01.04	2019.01.03
Preamplifier	Miteq	NSP1800-25	1364185	2018.05.03	2019.05.02
Preamplifier	QuieTek	AP-040G	CHM-0906001	2018.05.06	2019.05.05
DRG Horn	ETS-Lindgren	3117	00123988	2018.01.22	2019.01.20
Broad-Band Horn Antenna	Schwarzbeck	BBHA9170	294	2018.11.25	2019.11.23
Coaxial Cable	Huber+Suhner	SUCOFLEX 106	AC5-C1	2018.03.02	2019.03.01
Coaxial Cable	Huber+Suhner	SUCOFLEX 106	AC5-C2	2018.03.02	2019.03.01
Coaxial Cable	Huber+Suhner	SUCOFLEX 102	AC5-C3	2018.03.02	2019.03.01
EMI Receiver	Agilent	N9038A	MY51210196	2018.06.10	2019.06.09
Temperature/Humidity Meter	Zhichen	ZC1-2	AC5-TH	2018.01.04	2019.01.03
Note: All equipments are calibrated with traceable calibrations. Each calibration is traceable to the national or international standards.					

4.2. Test Setup

Below 30MHz Test Setup:

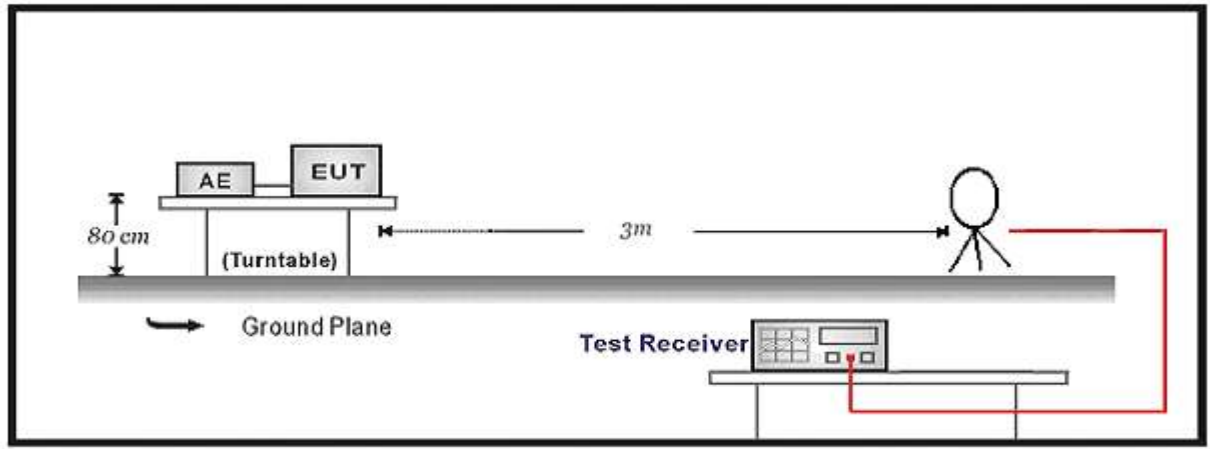

30MHz-1GHz Test Setup:

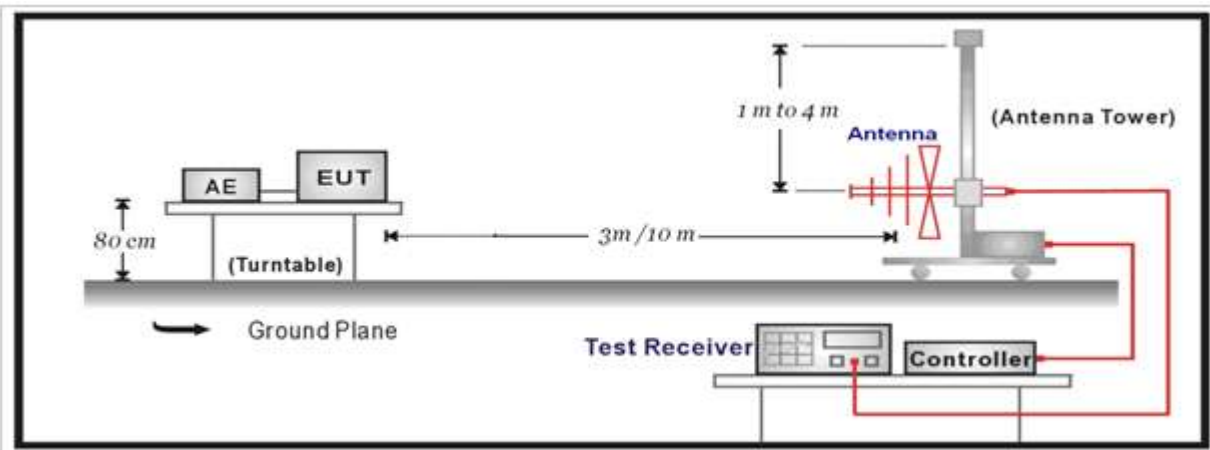

Above 1GHz Test Setup:

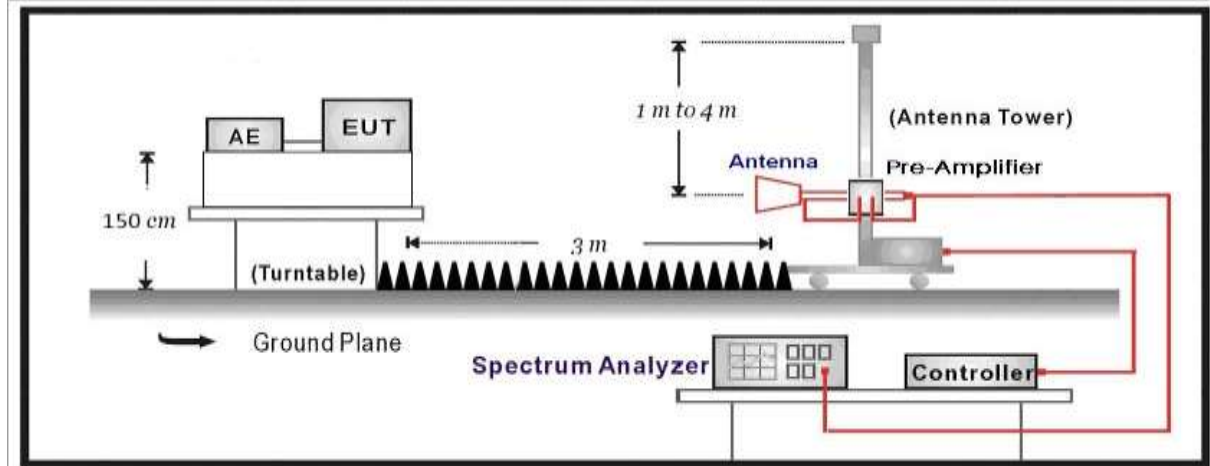

4.3. Limit

Restricted Bands of operation			
Frequency (MHz)	Frequency (MHz)	Frequency (MHz)	Frequency (GHz)
0.090 – 0.110	16.42 – 16.423	399.9 – 410	4.5 – 5.15
0.495 – 0.505	16.69475 – 16.69525	608 – 614	5.35 – 5.46
2.1735 – 2.1905	16.80425 – 16.80475	960 – 1240	7.25 – 7.75
4.125 – 4.128	25.5 – 25.67	1300 – 1427	8.025 – 8.5
4.17725 – 4.17775	37.5 – 38.25	1435 – 1626.5	9.0 – 9.2
4.20725 – 4.20775	73 – 74.6	1645.5 – 1646.5	9.3 – 9.5
6.215 – 6.218	74.8 – 75.2	1660 – 1710	10.6 – 12.7
6.26775 – 6.26825	108 – 121.94	1718.8 – 1722.2	13.25 – 13.4
6.31175 – 6.31225	123 – 138	2200 – 2300	14.47 – 14.5
8.291 – 8.294	149.9 – 150.05	2310 – 2390	15.35 – 16.2
8.362 – 8.366	156.52475 –	2483.5 – 2500	17.7 – 21.4
8.37625 – 8.38675	156.7 – 156.9	2690 – 2900	22.01 – 23.12
8.81425 – 8.81475	162.0125 – 167.17	3260 – 3267	23.6 – 24.0
12.29 – 12.293	167.72 – 173.2	3332 – 3339	31.2 – 31.8
12.51975–12.52025	240 – 285	3345.8 – 3358	36.43 – 36.5
12.57675–12.57725	322 – 335.4	3600 – 4400	
13.36 – 13.41			

Restricted Band Emissions Limit			
Frequency (MHz)	Field strength ($\mu\text{V/m}$)	Field strength ($\text{dB}\mu\text{V/m}$)	Measurement distance (m)
0.009 - 0.49	2400/F(kHz)	48.5 – 13.8	300 _(Note 1)
0.49 - 1.705	24000/F(kHz)	33.8 - 23	30 _(Note 1)
1.705 - 30	30	29.5	30 _(Note 1)
30 - 88	100	40	3 _(Note 2)
88 - 216	150	43.5	3 _(Note 2)
216 - 960	200	46	3 _(Note 2)
Above 960	500	54	3 _(Note 2)





Note 1: At frequencies below 30 MHz, measurements may be performed at a distance closer than that specified in the regulations; however, an attempt should be made to avoid making measurements in the near field. Pending the development of an appropriate measurement procedure for measurements performed below 30 MHz, when performing measurements at a closer distance than specified, the results shall be extrapolated to the specified distance by either making measurements at a minimum of two distances on at least one radial to determine the proper extrapolation factor or by using the square of an inverse linear distance extrapolation factor (40 dB/decade).

Note 2: At frequencies at or above 30 MHz, measurements may be performed at a distance other than what is specified provided: measurements are not made in the near field except where it can be shown that near field measurements are appropriate due to the characteristics of the device; and it can be demonstrated that the signal levels needed to be measured at the distance employed can be detected by the measurement equipment. Measurements shall not be performed at a distance greater than 30 meters unless it can be further demonstrated that measurements at a distance of 30 meters or less are impractical. When performing measurements at a distance other than that specified, the results shall be extrapolated to the specified distance using an extrapolation factor of 20 dB/decade (inverse linear-distance for field strength measurements; inverse-linear-distance-squared for power density measurements).

4.4. Test Procedure

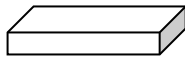
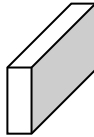
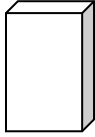
Test Method			
	References Rule	Chapter	Description
<input type="checkbox"/>	ANSI C63.10	11.11	Emissions in non-restricted frequency bands
	<input type="checkbox"/> ANSI C63.10	11.11.2	Reference level measurement
	<input type="checkbox"/> ANSI C63.10	11.11.3	Emission level measurement
<input checked="" type="checkbox"/>	ANSI C63.10	11.12	Emissions in restricted frequency bands
	<input checked="" type="checkbox"/> ANSI C63.10	11.12.1	Radiated emission measurements
	<input checked="" type="checkbox"/> ANSI C63.10	11.12.2.7	Radiated spurious emission test
	<input checked="" type="checkbox"/> ANSI C63.10	6.4	Radiated emissions from unlicensed wireless devices below 30 MHz
	<input checked="" type="checkbox"/> ANSI C63.10	6.5	Radiated emissions from unlicensed wireless devices in the frequency range of 30 MHz to 1000 MHz
	<input checked="" type="checkbox"/> ANSI C63.10	6.6	Radiated emissions from unlicensed wireless devices above 1 GHz
	<input type="checkbox"/> ANSI C63.10	11.12.2.3	Quasi-peak measurement procedure
	<input type="checkbox"/> ANSI C63.10	11.12.2.4	Peak power measurement procedure
	<input type="checkbox"/> ANSI C63.10	11.12.2.5	Average power measurement procedures
	<input type="checkbox"/> ANSI C63.10	11.12.2.5.1	Trace averaging with continuous EUT transmission at full power
	<input type="checkbox"/> ANSI C63.10	11.12.2.5.2	Trace averaging across ON and OFF times of the EUT transmissions followed by duty cycle correction
	<input type="checkbox"/> ANSI C63.10	11.12.2.5.3	Reduced VBW averaging across ON and OFF times of the EUT transmissions with max hold

4.5. EUT test Axis definition

Item	Emissions in restricted frequency bands			
Device Category	<input checked="" type="checkbox"/>	Fixed position use		
	<input type="checkbox"/>	Mobile position use		
Test mode	Mode 1			
Test method	<input checked="" type="checkbox"/>	Radiated		
		X Axis	Y Axis	Z Axis
				
		Worst Axis <input checked="" type="checkbox"/>	Worst Axis <input type="checkbox"/>	Worst Axis <input type="checkbox"/>
	<input type="checkbox"/>	Conducted		
	<input type="checkbox"/>	Chain 1		
				
	<input type="checkbox"/>	Chain 1	Chain 2	
				
	<input type="checkbox"/>	Chain 1	Chain 2	Chain 3
				

4.6. Test Result

Engineer: Pawn	
Site: AC5	Time: 2018/12/24 - 22:42
Limit: FCC_Part15.209_RE(3m)	Margin: 0
Probe: Horn_3117_00167055(1-18GHz)	Polarity: Horizontal
EUT: Ring Bridge	Power: AC 120V/60Hz
Note: Mode1:Transmit at 902.5MHz by Lora	

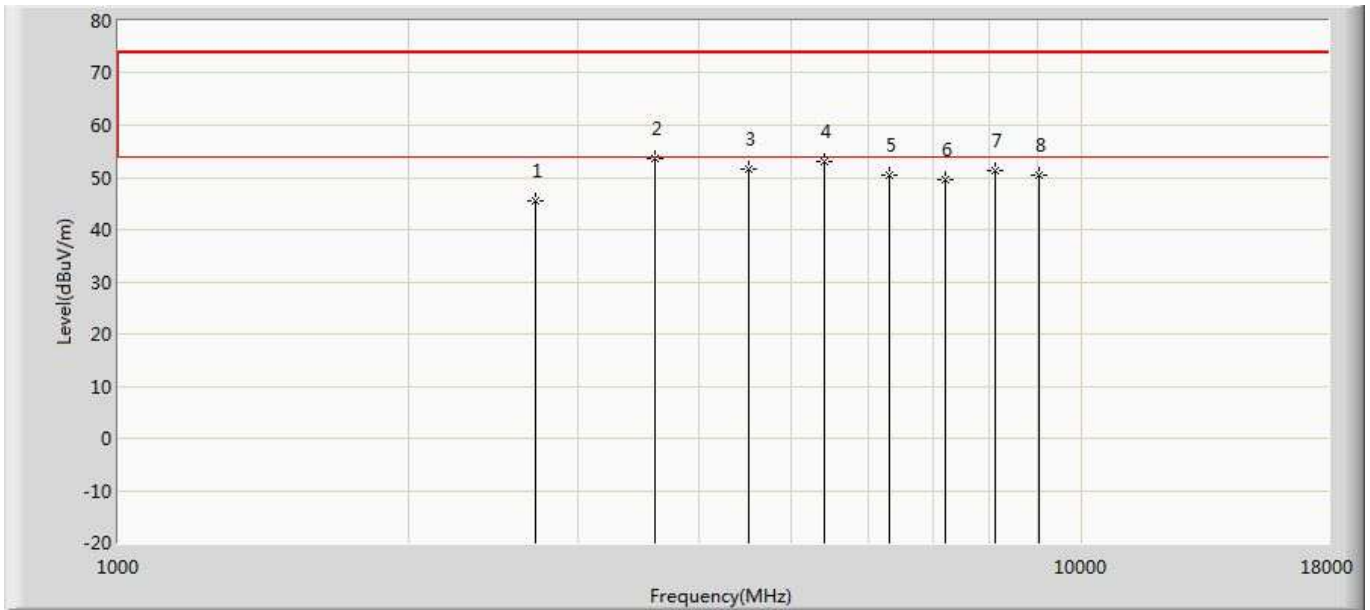

No	Mark	Frequency (MHz)	Measure Level (dBuV/m)	Reading Level (dBuV)	Over Limit (dB)	Limit (dBuV/m)	Factor (dB)	Type
1		2707.500	45.464	45.109	-28.536	74.000	0.355	PK
2	*	3609.500	53.729	51.660	-20.271	74.000	2.070	PK
3		4510.500	51.455	47.182	-22.545	74.000	4.273	PK
4		5411.500	52.915	46.018	-21.085	74.000	6.897	PK
5		6317.500	50.545	41.984	-23.455	74.000	8.561	PK
6		7220.000	49.657	40.511	-24.343	74.000	9.147	PK
7		8122.500	51.221	40.871	-22.779	74.000	10.350	PK
8		9025.000	50.466	39.419	-23.534	74.000	11.047	PK

Engineer: Pawn	
Site: AC5	Time: 2018/12/24 - 22:42
Limit: FCC_Part15.209_RE(3m)	Margin: 0
Probe: Horn_3117_00167055(1-18GHz)	Polarity: Vertical
EUT: Ring Bridge	Power: AC 120V/60Hz
Note: Mode1:Transimit at 902.5MHz by Lora	

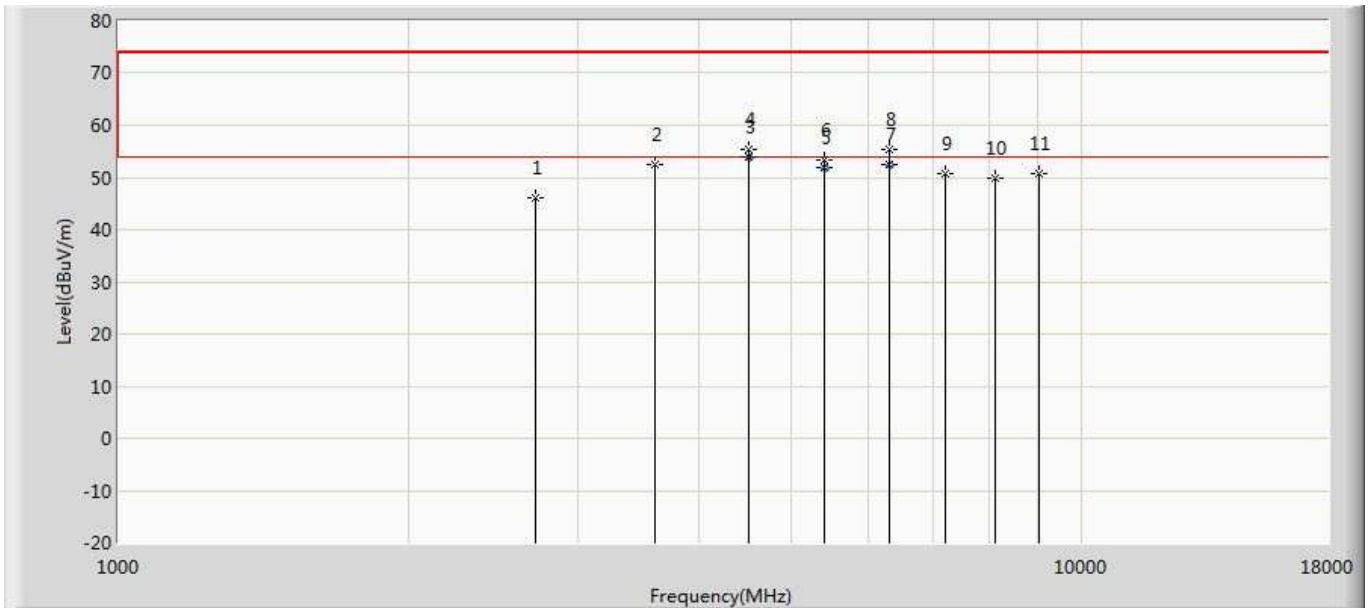

No	Mark	Frequency (MHz)	Measure Level (dBuV/m)	Reading Level (dBuV)	Over Limit (dB)	Limit (dBuV/m)	Factor (dB)	Type
1		2707.500	46.187	45.832	-27.813	74.000	0.355	PK
2		3609.500	52.540	50.471	-21.460	74.000	2.070	PK
3	*	4510.130	53.860	49.580	-0.140	54.000	4.280	AV
4		4510.500	55.472	51.199	-18.528	74.000	4.273	PK
5		5411.250	51.878	44.980	-2.122	54.000	6.898	AV
6		5411.500	53.355	46.458	-20.645	74.000	6.897	PK
7		6312.480	52.341	43.789	-1.659	54.000	8.551	AV
8		6312.500	55.457	46.905	-18.543	74.000	8.553	PK
9		7220.000	50.818	41.672	-23.182	74.000	9.147	PK
10		8122.500	49.795	39.445	-24.205	74.000	10.350	PK
11		9025.000	50.642	39.595	-23.358	74.000	11.047	PK

Engineer: Pawn	
Site: AC5	Time: 2018/12/24 - 22:42
Limit: FCC_Part15.209_RE(3m)	Margin: 0
Probe: Horn_3117_00167055(1-18GHz)	Polarity: Horizontal
EUT: Ring Bridge	Power: AC 120V/60Hz
Note: Mode1:Transimit at 913.7MHz by Lora	

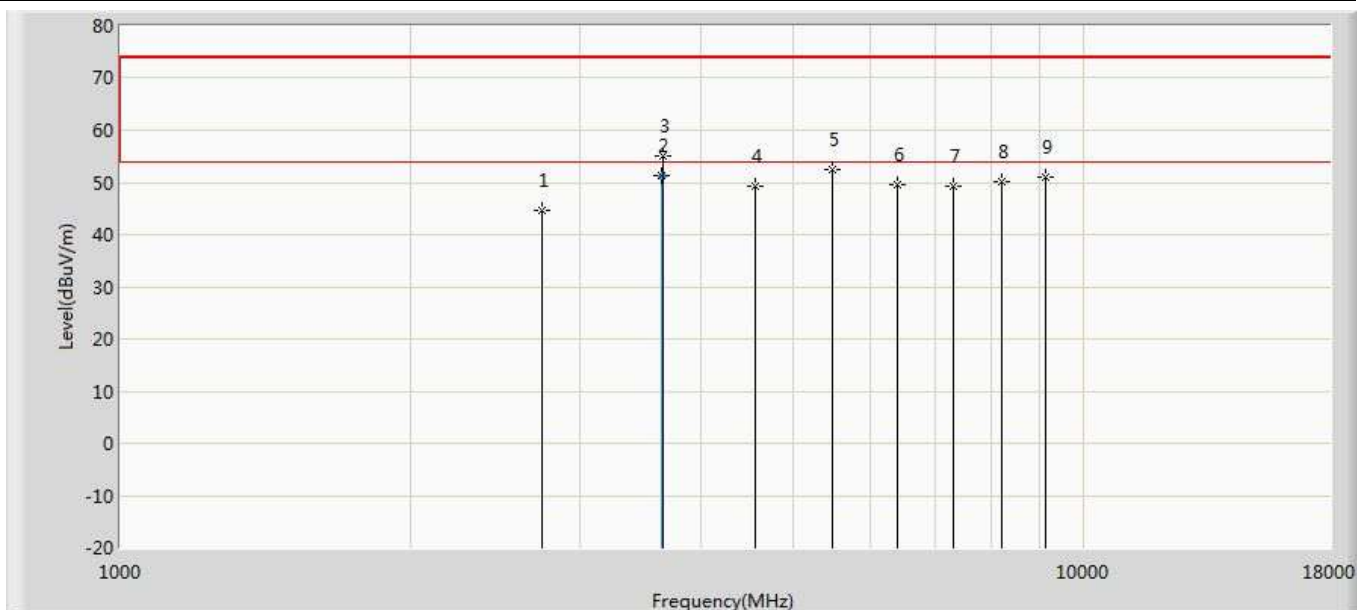

No	Mark	Frequency (MHz)	Measure Level (dBuV/m)	Reading Level (dBuV)	Over Limit (dB)	Limit (dBuV/m)	Factor (dB)	Type
1		2741.100	44.732	44.303	-29.268	74.000	0.429	PK
2	*	3651.880	51.215	49.180	-2.785	54.000	2.035	AV
3		3652.000	54.969	52.935	-19.031	74.000	2.034	PK
4		4568.500	49.157	44.489	-24.843	74.000	4.668	PK
5		5479.500	52.555	45.614	-21.445	74.000	6.941	PK
6		6395.900	49.701	41.164	-24.299	74.000	8.537	PK
7		7309.600	49.415	40.498	-24.585	74.000	8.917	PK
8		8223.300	50.241	39.982	-23.759	74.000	10.259	PK
9		9137.000	50.898	40.266	-23.102	74.000	10.631	PK

Engineer: Pawn	
Site: AC5	Time: 2018/12/24 - 22:42
Limit: FCC_Part15.209_RE(3m)	Margin: 0
Probe: Horn_3117_00167055(1-18GHz)	Polarity: Vertical
EUT: Ring Bridge	Power: AC 120V/60Hz
Note: Mode1:Transimit at 913.7MHz by Lora	

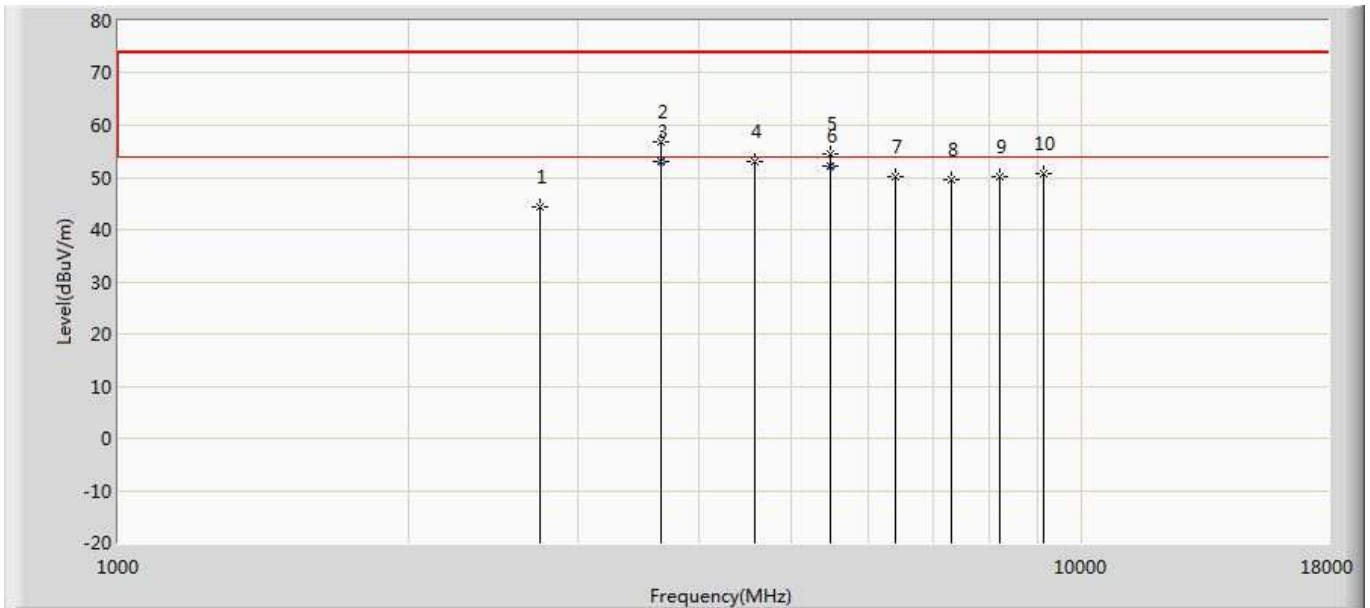

No	Mark	Frequency (MHz)	Measure Level (dBuV/m)	Reading Level (dBuV)	Over Limit (dB)	Limit (dBuV/m)	Factor (dB)	Type
1		2741.100	44.372	43.943	-29.628	74.000	0.429	PK
2		3652.000	56.773	54.739	-17.227	74.000	2.034	PK
3	*	3654.530	53.149	51.096	-0.851	54.000	2.053	AV
4		4570.000	52.978	48.301	-21.022	74.000	4.677	PK
5		5479.500	54.454	47.513	-19.546	74.000	6.941	PK
6		5479.680	52.173	45.230	-1.827	54.000	6.943	AV
7		6395.900	50.205	41.668	-23.795	74.000	8.537	PK
8		7309.600	49.503	40.586	-24.497	74.000	8.917	PK
9		8223.300	50.009	39.750	-23.991	74.000	10.259	PK
10		9137.000	50.695	40.063	-23.305	74.000	10.631	PK

Engineer: Pawn	
Site: AC5	Time: 2018/12/24 - 22:43
Limit: FCC_Part15.209_RE(3m)	Margin: 0
Probe: Horn_3117_00167055(1-18GHz)	Polarity: Horizontal
EUT: Ring Bridge	Power: AC 120V/60Hz
Note: Mode1:Transimit at 927.3MHz by Lora	

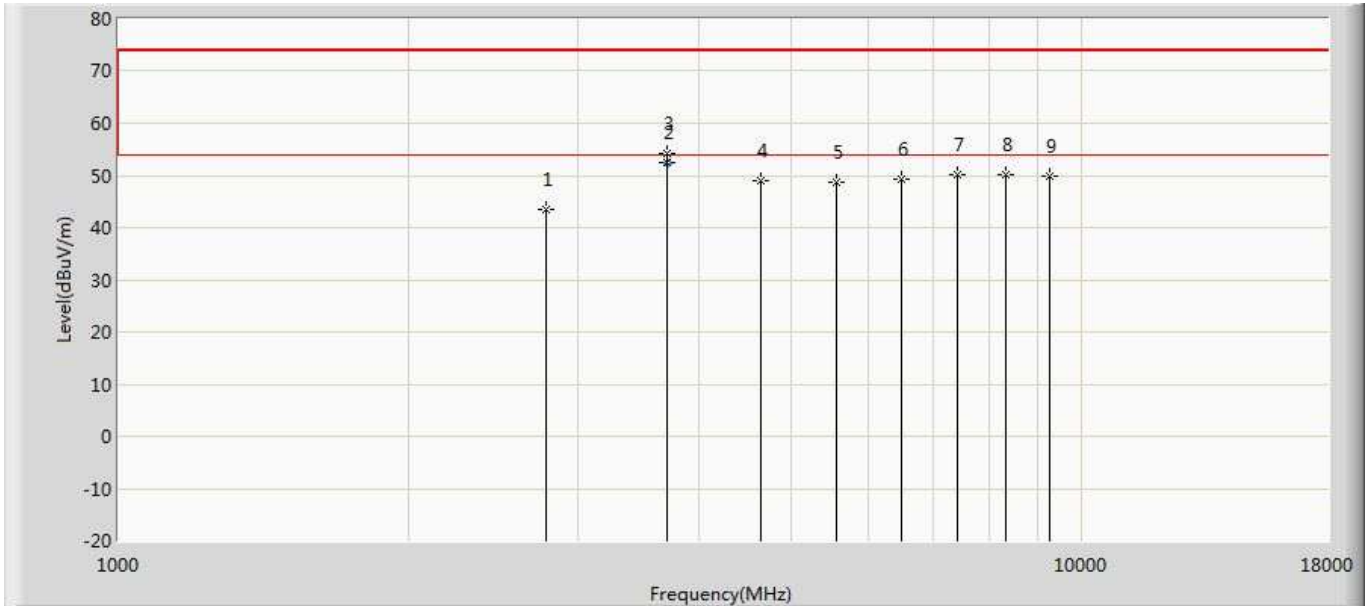

No	Mark	Frequency (MHz)	Measure Level (dBuV/m)	Reading Level (dBuV)	Over Limit (dB)	Limit (dBuV/m)	Factor (dB)	Type
1		2781.900	43.538	42.854	-30.462	74.000	0.683	PK
2	*	3709.230	52.411	50.170	-1.589	54.000	2.242	AV
3		3711.500	54.279	52.008	-19.721	74.000	2.271	PK
4		4636.500	48.952	44.501	-25.048	74.000	4.452	PK
5		5563.800	48.818	41.726	-25.182	74.000	7.092	PK
6		6491.100	49.275	40.588	-24.725	74.000	8.687	PK
7		7418.400	50.047	40.538	-23.953	74.000	9.509	PK
8		8345.700	50.064	39.683	-23.936	74.000	10.381	PK
9		9273.000	49.940	38.801	-24.060	74.000	11.139	PK

Engineer: Pawn	
Site: AC5	Time: 2018/12/24 - 22:43
Limit: FCC_Part15.209_RE(3m)	Margin: 0
Probe: Horn_3117_00167055(1-18GHz)	Polarity: Vertical
EUT: Ring Bridge	Power: AC 120V/60Hz
Note: Mode1:Transimit at 927.3MHz by Lora	

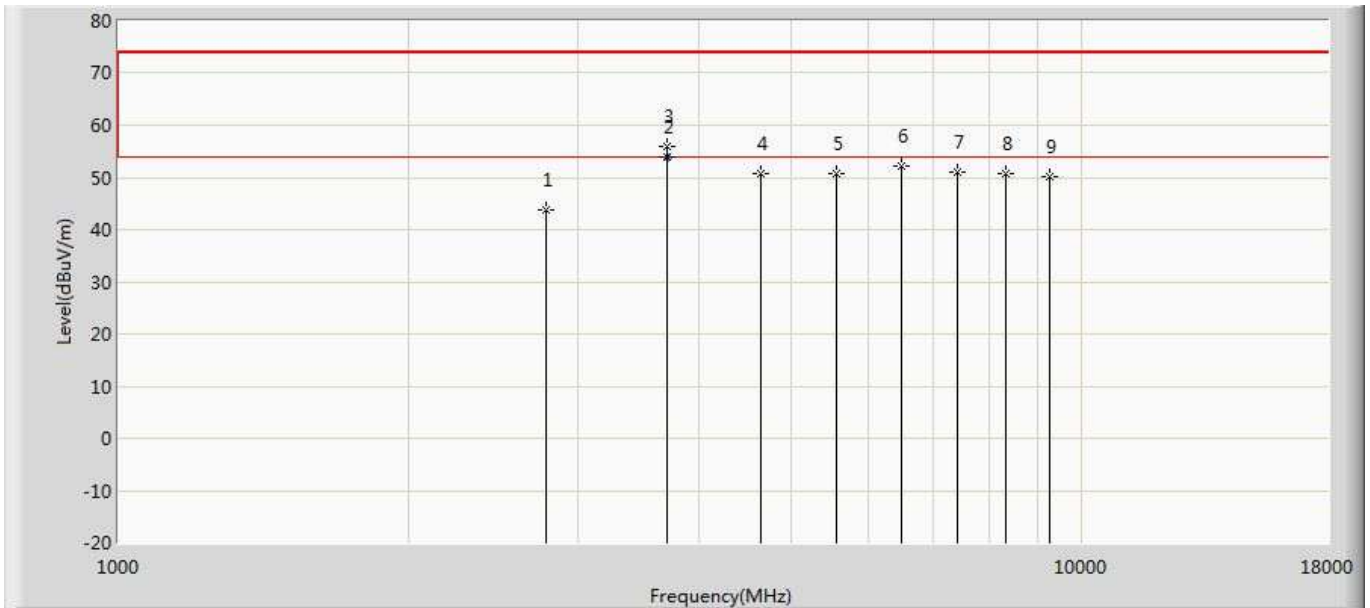

No	Mark	Frequency (MHz)	Measure Level (dBuV/m)	Reading Level (dBuV)	Over Limit (dB)	Limit (dBuV/m)	Factor (dB)	Type
1		2781.900	43.708	43.024	-30.292	74.000	0.683	PK
2	*	3710.850	53.902	51.640	-0.098	54.000	2.262	AV
3		3711.500	55.926	53.655	-18.074	74.000	2.271	PK
4		4636.500	50.612	46.161	-23.388	74.000	4.452	PK
5		5563.800	50.657	43.565	-23.343	74.000	7.092	PK
6		6491.100	52.077	43.390	-21.923	74.000	8.687	PK
7		7418.400	50.958	41.449	-23.042	74.000	9.509	PK
8		8345.700	50.642	40.261	-23.358	74.000	10.381	PK
9		9273.000	50.101	38.962	-23.899	74.000	11.139	PK

Note:

1. Measured Level = Reading Level + Factor.
2. The test frequency range, 9kHz~30MHz, the worst case are at least 20dB below the limits, therefore no data appear in the report.
3. This limit applies for using average detector, if the test result on peak is lower than average limit, then average measurement needn't be performed.
4. As the radiated emission was performed, so conducted emission was not tested.

The worst case of Radiated Emission below 1GHz:

Engineer: Leon	
Site: AC2	Time: 2018/12/21
Limit: FCC_Part15.209_RE(3m)_ClassB	Margin: 0
Probe: AC2_3M(30-1000M)	Polarity: Horizontal
EUT: Ring Bridge	Power: AC 120V/60Hz
Note: Mode 1	

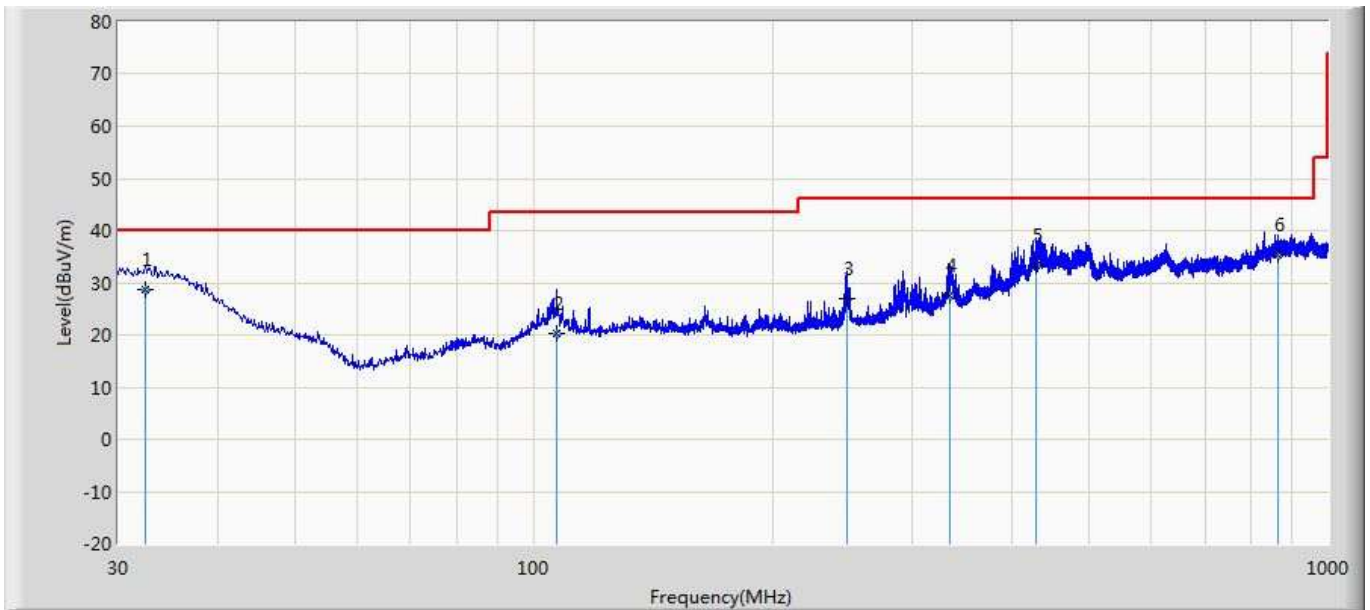

No	Mark	Frequency (MHz)	Measure Level (dBuV/m)	Reading Level (dBuV)	Over Limit (dB)	Limit (dBuV/m)	Probe (dB/m)	Cable (dB)	Amp (dB)	Ant Pos (cm)	Table Pos (deg)	Type
1		32.425	28.578	1.200	-11.422	40.000	20.733	6.645	0.000	300	208	QP
2		106.874	20.345	3.600	-23.155	43.500	9.824	6.921	0.000	400	138	QP
3		248.250	26.911	8.900	-19.089	46.000	10.450	7.561	0.000	200	0	QP
4		334.823	27.520	4.600	-18.480	46.000	15.185	7.735	0.000	100	324	QP
5		429.034	33.398	6.800	-12.602	46.000	18.622	7.975	0.000	300	316	QP
6	*	865.898	35.290	2.300	-10.710	46.000	23.822	9.168	0.000	300	151	QP

Note:

1. " * ", means this data is the worst emission level.
2. Measurement Level = Reading Level + Factor(Probe+Cable-Amp).

Engineer: Leon	
Site: AC2	Time: 2018/12/21
Limit: FCC_Part15.209_RE(3m)_ClassB	Margin: 0
Probe: AC2_3M(30-1000M)	Polarity: Vertical
EUT: Ring Bridge	Power: AC 120V/60Hz
Note: Mode 1	

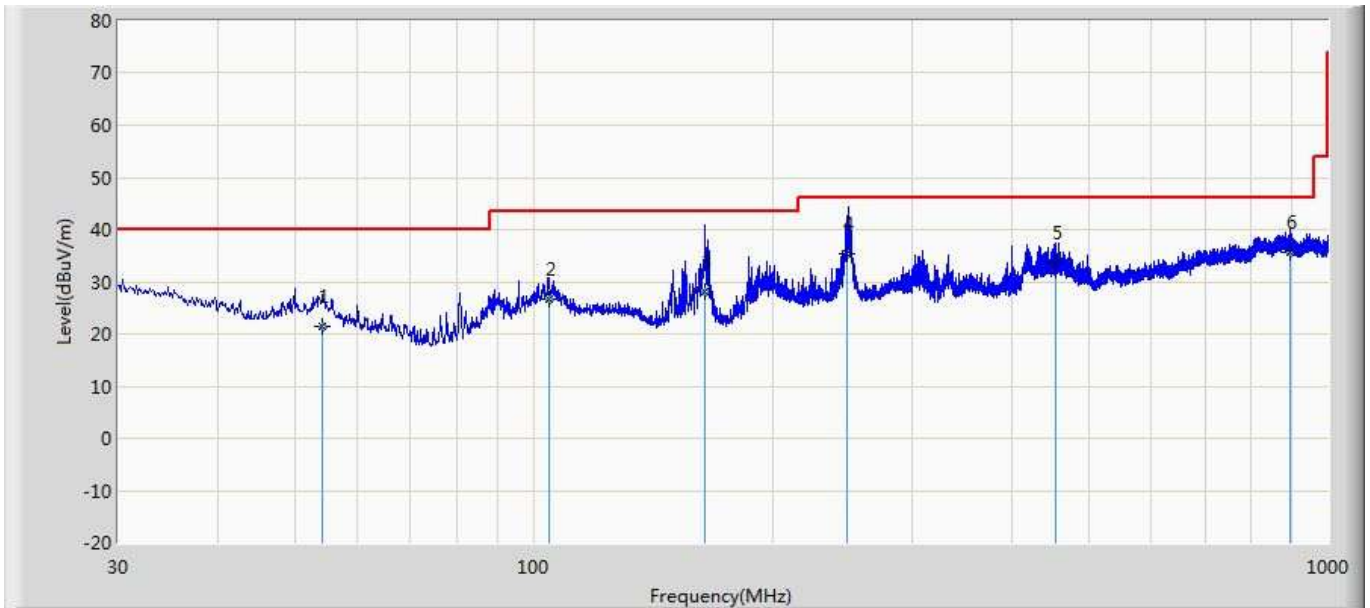

No	Mark	Frequency (MHz)	Measure Level (dBuV/m)	Reading Level (dBuV)	Over Limit (dB)	Limit (dBuV/m)	Probe (dB/m)	Cable (dB)	Amp (dB)	Ant Pos (cm)	Table Pos (deg)	Type
1		54.250	21.468	3.600	-18.532	40.000	11.250	6.618	0.000	100	32	QP
2		104.569	26.692	4.300	-16.808	43.500	15.487	6.905	0.000	100	340	QP
3		164.466	28.216	8.600	-15.284	43.500	12.355	7.261	0.000	100	32	QP
4		248.405	35.333	10.900	-10.667	46.000	16.871	7.562	0.000	100	74	QP
5		455.224	33.569	7.500	-12.431	46.000	18.070	7.999	0.000	300	180	QP
6	*	895.846	35.538	1.900	-10.462	46.000	24.399	9.240	0.000	200	309	QP

Note:

1. " * ", means this data is the worst emission level.
2. Measurement Level = Reading Level + Factor(Probe+Cable-Amp).

5. Emissions in non-restricted frequency bands

5.1. Test Equipment

Emissions in non-restricted frequency bands / TR-8					
Instrument	Manufacturer	Type No.	Serial No.	Cal. Date	Cal. Due Date
Spectrum Analyzer	Agilent	N9010A	MY48030494	2018.02.04	2019.02.03
EXA Spectrum Analyzer	Keysight	N9010A	MY55370495	2018.04.09	2019.04.08
MXA Signal Analyzer	Keysight	N9020A	MY56060147	2018.04.09	2019.04.08
Temperature/Humidity Meter	zhichen	ZC1-2	TR8-TH	2018.04.10	2019.04.09

Note: All equipments are calibrated with traceable calibrations. Each calibration is traceable to the national or international standards.

5.2. Test Setup

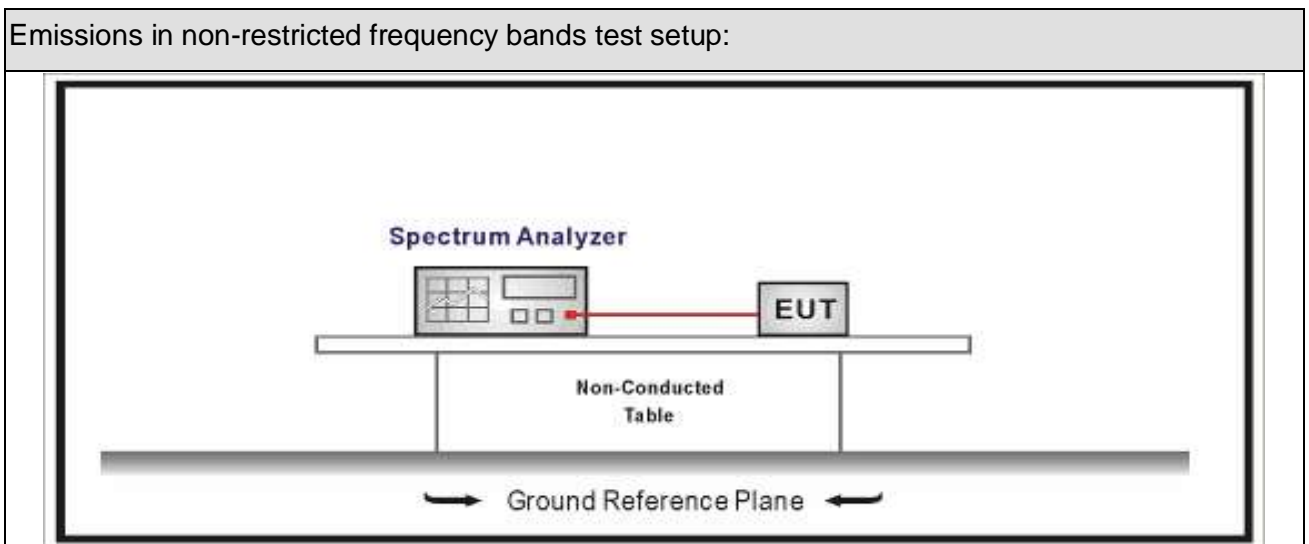



5.3. Limit

Un-Restricted Band Emissions Limit	
RF Output power (Detection methods)	Limit(dB)
RF Output power(Average detector)	30c(Note1)
RF Output power(PK detector)	20c(Note2)
<p>Note 1: If maximum conducted (average) output power was used to demonstrate compliance as described in 9.2, then the peak power in any 100 kHz bandwidth outside of the authorized frequency band shall be attenuated by at least 30 dB relative to the maximum in-band peak PSD level in 100 kHz (i.e., 30 dBc).</p> <p>Note 2: If the maximum peak conducted output power procedure was used, then the peak output power measured in any 100 kHz bandwidth outside of the authorized frequency band shall be attenuated by at least 20 dB relative to the maximum in-band peak PSD level in 100 kHz (i.e., 20 dBc).</p>	

5.4. Test Procedure

Test Method			
	References Rule	Chapter	Description
<input checked="" type="checkbox"/>	ANSI C63.10	11.11	Emissions in non-restricted frequency bands
	<input checked="" type="checkbox"/> ANSI C63.10	11.11.2	Reference level measurement
	<input checked="" type="checkbox"/> ANSI C63.10	11.11.3	Emission level measurement
<input type="checkbox"/>	ANSI C63.10	11.12	Emissions in restricted frequency bands
	<input type="checkbox"/> ANSI C63.10	11.12.1	Radiated emission measurements
	<input type="checkbox"/> ANSI C63.10	11.12.2.7	Radiated spurious emission test
<input type="checkbox"/>	ANSI C63.10	6.4	Radiated emissions from unlicensed wireless devices below 30 MHz
<input type="checkbox"/>	ANSI C63.10	6.5	Radiated emissions from unlicensed wireless devices in the frequency range of 30 MHz to 1000 MHz
<input type="checkbox"/>	ANSI C63.10	6.6	Radiated emissions from unlicensed wireless devices above 1 GHz
	<input checked="" type="checkbox"/> ANSI C63.10	11.12.2	Antenna-port conducted measurements
	<input type="checkbox"/> ANSI C63.10	11.12.2.3	Quasi-peak measurement procedure
	<input type="checkbox"/> ANSI C63.10	11.12.2.4	Peak power measurement procedure
	<input type="checkbox"/> ANSI C63.10	11.12.2.5	Average power measurement procedures
	<input type="checkbox"/> ANSI C63.10	11.12.2.5.1	Trace averaging with continuous EUT transmission at full power
	<input type="checkbox"/> ANSI C63.10	11.12.2.5.2	Trace averaging across ON and OFF times of the EUT transmissions followed by duty cycle correction
	<input type="checkbox"/> ANSI C63.10	11.12.2.5.3	Reduced VBW averaging across ON and OFF times of the EUT transmissions with max hold

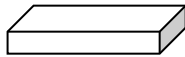
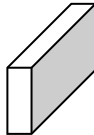
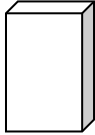
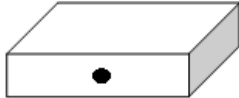
5.5. EUT test Axis definition

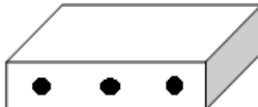
Item	Emissions in non-restricted frequency bands		
Device Category	<input checked="" type="checkbox"/> Fixed position use		
	<input type="checkbox"/> Mobile position use		
Test mode	Mode 1		
Test method	<input type="checkbox"/> Radiated		
	X Axis	Y Axis	Z Axis
			
	Worst Axis <input type="checkbox"/>	Worst Axis <input type="checkbox"/>	Worst Axis <input type="checkbox"/>
	<input checked="" type="checkbox"/> Conducted		
	<input checked="" type="checkbox"/> Chain 0		
			
	<input type="checkbox"/> Chain 0	Chain 1	
			
	<input type="checkbox"/> Chain 0	Chain 1	Chain 2
			

5.6. Test Result

Product Name	: Ring Bridge	Power	: AC 120V/60Hz
Test Mode	: Mode1	Test Site	: TR8
Test Date	: 2018.12.25		

Mode 1 Channel(902.5MHz)

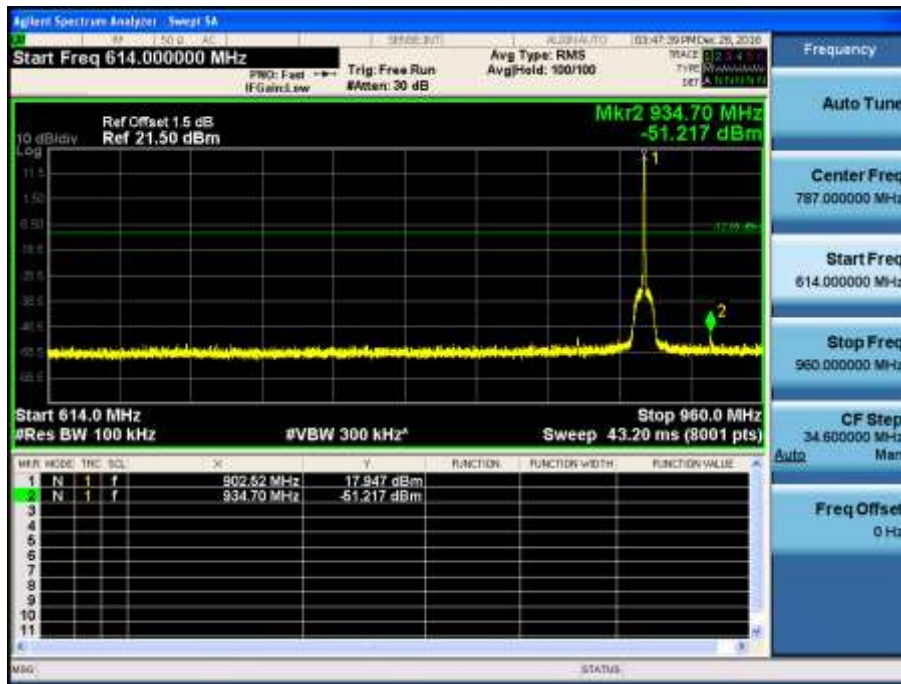

Mode 1 Channel(927.3MHz)

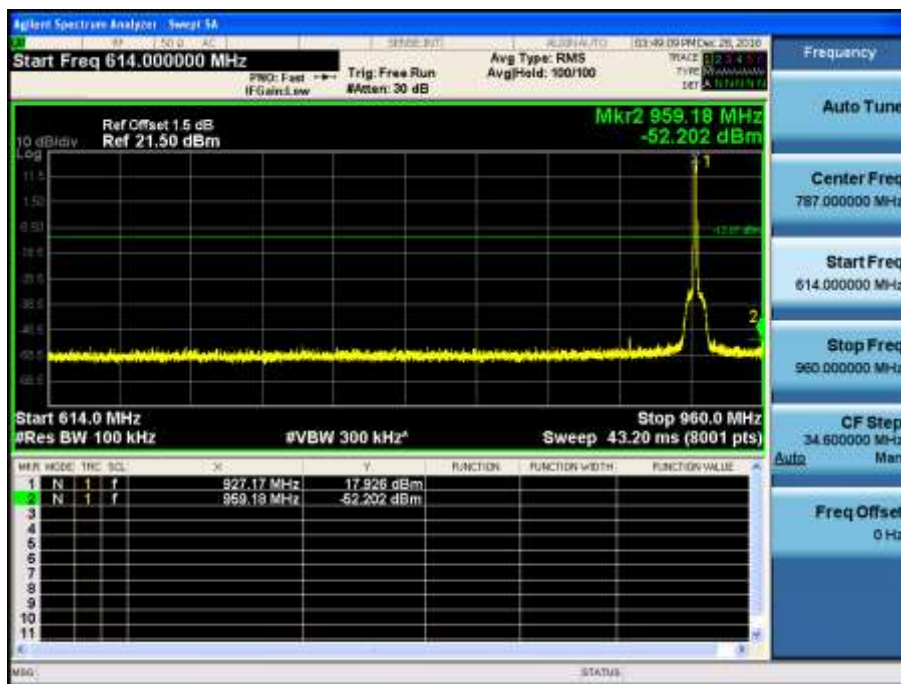

6. Occupied Bandwidth

6.1. Test Equipment

Occupied Bandwidth / TR-8					
Instrument	Manufacturer	Type No.	Serial No.	Cal. Date	Cal. Due Date
Spectrum Analyzer	Agilent	N9010A	MY48030494	2018.02.04	2019.02.03
EXA Spectrum Analyzer	Keysight	N9010A	MY55370495	2018.04.09	2019.04.08
MXA Signal Analyzer	Keysight	N9020A	MY56060147	2018.04.09	2019.04.08
Temperature/Humidity Meter	zhichen	ZC1-2	TR8-TH	2018.04.10	2019.04.09

Note: All equipments are calibrated with traceable calibrations. Each calibration is traceable to the national or international standards.

6.2. Test Setup

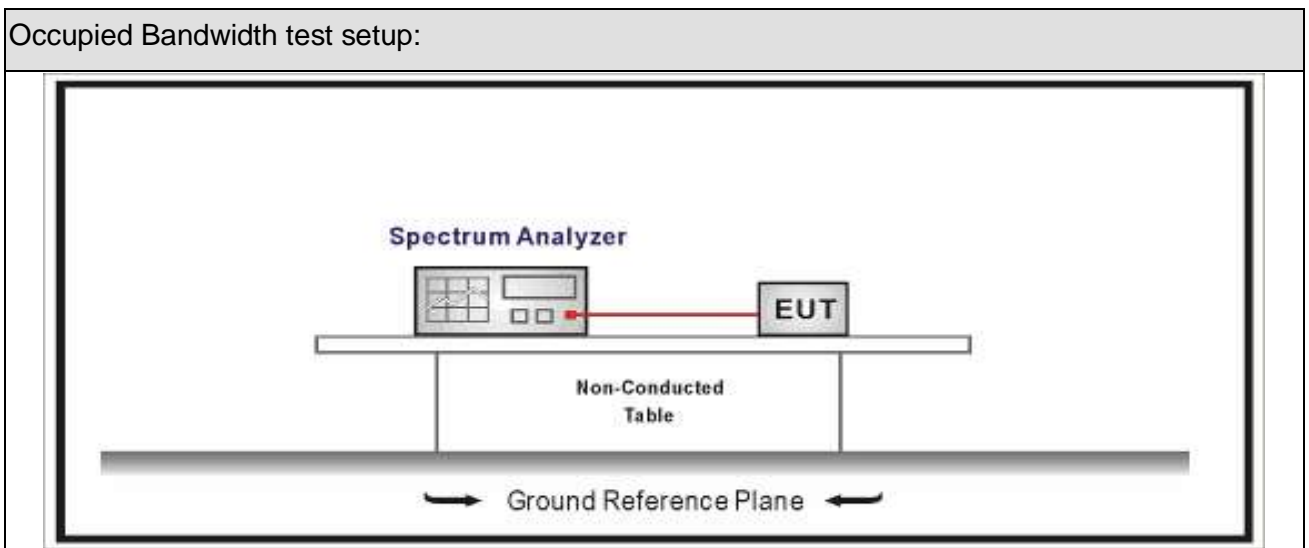



6.3. Limit

Occupied Bandwidth
Systems using digital modulation techniques operate in the 902-928 MHz .The minimum 6 dB bandwidth shall be at least 500 kHz

6.4. Test Procedure

Test Method			
	Reference Rule	Chapter	Description
<input checked="" type="checkbox"/>	ANSI C63.10	11.8	DTS bandwidth
	<input type="checkbox"/> ANSI C63.10	11.8.1	Option 1
	<input checked="" type="checkbox"/> ANSI C63.10	11.8.2	Option 2

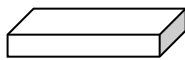
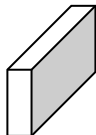
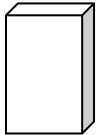
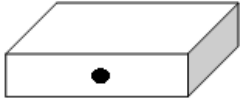
6.5. EUT test definition

Item	Occupied Bandwidth			
Device Category	<input checked="" type="checkbox"/>	Fixed position use		
	<input type="checkbox"/>	Mobile position use		
Test mode	Mode 1			
Test method	<input type="checkbox"/>	Radiated		
		X Axis	Y Axis	Z Axis
				
		Worst Axis <input type="checkbox"/>	Worst Axis <input type="checkbox"/>	Worst Axis <input type="checkbox"/>
	<input checked="" type="checkbox"/>	Conducted		
	<input checked="" type="checkbox"/>	Chain 0		
				
	<input type="checkbox"/>	Chain 0	Chain 1	
				
	<input type="checkbox"/>	Chain 0	Chain 1	Chain 2
				

6.6. Test Result

Product Name	: Ring Bridge	Power	: AC 120V/60Hz
Test Mode	: Mode1	Test Site	: TR8
Test Date	: 2018.12.25		

Mode	CH.	Test Freq. (MHz)	99% Occupied Bandwidth (KHz)	6dB Occupied Bandwidth (KHz)	Limit (kHz)	Result
1	Low	902.5	669.96	641.7	>500	Pass
1	Mid	913.7	672.72	636.9	>500	Pass
1	High	927.3	689.65	644.0	>500	Pass

Note : The worst case of Occupied Bandwidth as below :

Mode 1 High Channel (914.2MHz)



7. Fundamental emission output power

7.1. Test Equipment

Fundamental emission output power/ TR-8					
Instrument	Manufacturer	Type No.	Serial No.	Cal. Date	Cal. Due Date
Spectrum Analyzer	Agilent	E4446A	MY45300103	2018.01.04	2019.01.03
Spectrum Analyzer	Agilent	N9010A	MY48030494	2018.02.04	2019.02.03
Wideband Peak Power Meter	Anritsu	ML2495A	0905006	2018.10.14	2019.10.13
Power Sensor	Anritsu	MA2411B	0846014	2018.10.14	2019.10.13
Temperature/Humidity Meter	zhicheng	ZC1-2	TR8-TH	2018.04.10	2019.04.09

Note: All equipments are calibrated with traceable calibrations. Each calibration is traceable to the national or international standards.

7.2. Test Setup

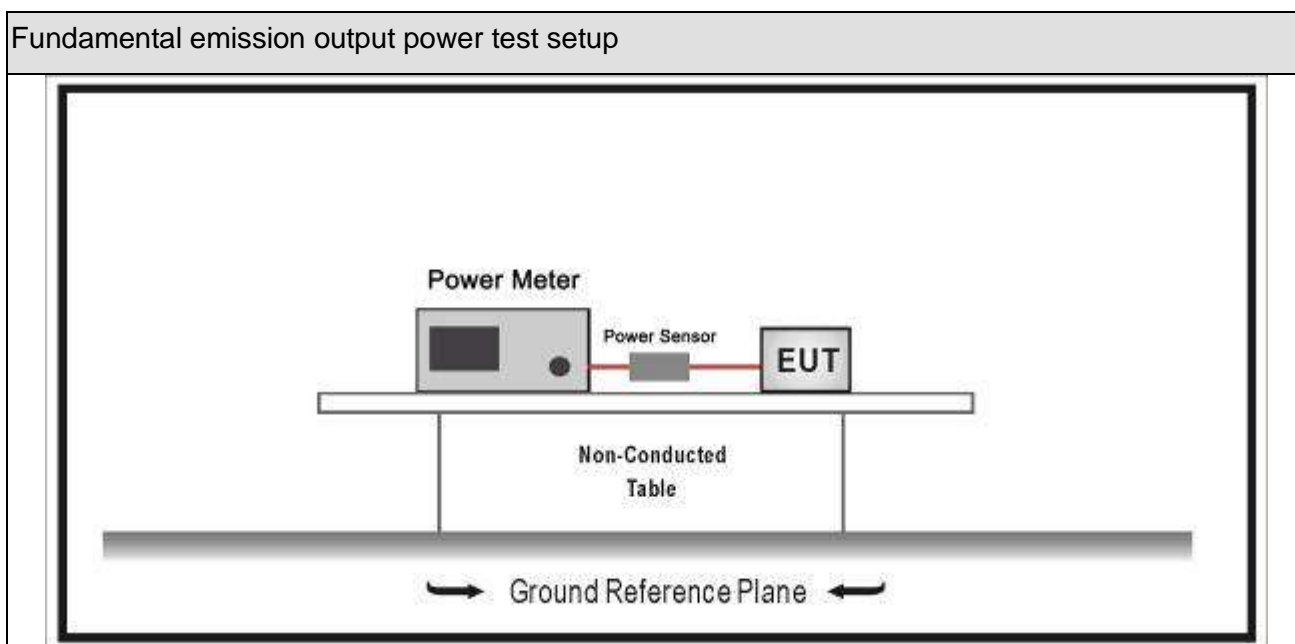



7.3. Limit

Fundamental emission output power Limit		
<input checked="" type="checkbox"/>	$G_{TX} < 6\text{dBi}$	$P_{out} \leq 30\text{dBm}$
<input type="checkbox"/>	$G_{TX} > 6\text{dBi}$	
<input type="checkbox"/>	Non-Fix point-point	$P_{out} \leq 30 - (G_{TX} - 6)$
<input type="checkbox"/>	Fix point-point	$P_{out} \leq 30 - [(G_{TX} - 6)]/3$
<input type="checkbox"/>	Point-to-multipoint	$P_{out} \leq 30 - (G_{TX} - 6)$
<input type="checkbox"/>	Overlap Beams	$P_{out} \leq 30 - [(G_{TX} - 6)]/3$
<input type="checkbox"/>	Aggregate power transmitted simultaneously on all beams	$P_{out} \leq 30 - [(G_{TX} - 6)]/3$
<input type="checkbox"/>	single directional beam	$P_{out} \leq 30 - [(G_{TX} - 6)]/3 + 8\text{dB}$
Note 1 : G_{TX} directional gain of transmitting antennas.		
Note 2 : P_{out} is maximum peak conducted output power .		

7.4. Test Procedure

Fundamental emission output power Test Method						
	References Rule		Chapter	Description		
<input checked="" type="checkbox"/>	ANSI C63.10		11.9	Fundamental emission output power		
	<input type="checkbox"/>	ANSI C63.10		11.9.1	Maximum peak conducted output power	
		<input type="checkbox"/>	ANSI C63.10	11.9.1.1	RBW \geq DTS bandwidth	
		<input type="checkbox"/>	ANSI C63.10	11.9.1.2	Integrated band power method	
		<input type="checkbox"/>	ANSI C63.10	11.9.1.3	PKPM1 Peak power meter method	
	<input checked="" type="checkbox"/>	ANSI C63.10		11.9.2	Maximum conducted (average) output power	
		<input type="checkbox"/>	ANSI C63.10		11.9.2.2	Measurement using a spectrum analyzer (SA)
			<input type="checkbox"/>	ANSI C63.10	11.9.2.2.2	Method AVGSA-1(Duty cycle \geq 98%)
			<input type="checkbox"/>	ANSI C63.10	11.9.2.2.3	Method AVGSA-1A(Duty cycle \geq 98%)
			<input type="checkbox"/>	ANSI C63.10	11.9.2.2.4	Method AVGSA-2(Duty cycle \leq 98%)
			<input type="checkbox"/>	ANSI C63.10	11.9.2.2.5	Method AVGSA-2A(Duty cycle \leq 98%)
			<input type="checkbox"/>	ANSI C63.10	11.9.2.2.4	Method AVGSA-3
			<input type="checkbox"/>	ANSI C63.10	11.9.2.2.5	Method AVGSA-3A
		<input checked="" type="checkbox"/>	ANSI C63.10		11.9.2.3	Measurement using a power meter (PM)
		<input checked="" type="checkbox"/>	ANSI C63.10	11.9.2.3.1	Method AVGPM	
<input type="checkbox"/>		ANSI C63.10	11.9.2.3.2	Method AVGPM-G		

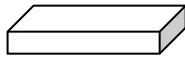
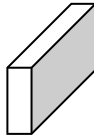
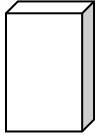
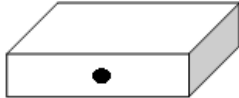
7.5. EUT test definition

Item	Fundamental emission output power		
Device Category	<input checked="" type="checkbox"/> Fixed position use		
	<input type="checkbox"/> Mobile position use		
Test mode	Mode 1		
Test method	<input type="checkbox"/> Radiated		
	X Axis	Y Axis	Z Axis
			
	Worst Axis <input type="checkbox"/>	Worst Axis <input type="checkbox"/>	Worst Axis <input type="checkbox"/>
	<input checked="" type="checkbox"/> Conducted		
	<input checked="" type="checkbox"/> Chain 0		
			
	<input type="checkbox"/> Chain 0	Chain 1	
			
	<input type="checkbox"/> Chain 0	Chain 1	Chain 2
			

7.6. Test Result

Product Name	: Ring Bridge	Power	: AC 120V/60Hz
Test Mode	: Mode1	Test Site	: TR8
Test Date	: 2018.12.27		

Mode	Channel	Test Frequency (MHz)	Average Power Output (dBm)	Antenna Gain (dBi)	Limit (dBm)	Result
1	Low	902.5	18.14	-1	30	Pass
1	Mid	913.7	18.26	-1	30	Pass
1	High	927.3	18.24	-1	30	Pass

8. Power Spectral Density

8.1. Test Equipment

Power Spectral Density / TR-8					
Instrument	Manufacturer	Type No.	Serial No.	Cal. Date	Cal. Due Date
Spectrum Analyzer	Agilent	N9010A	MY48030494	2018.02.04	2019.02.03
EXA Spectrum Analyzer	Keysight	N9010A	MY55370495	2018.04.09	2019.04.08
MXA Signal Analyzer	Keysight	N9020A	MY56060147	2018.04.09	2019.04.08
Temperature/Humidity Meter	zhichen	ZC1-2	TR8-TH	2018.04.10	2019.04.09

Note: All equipments are calibrated with traceable calibrations. Each calibration is traceable to the national or international standards.

8.2. Test Setup

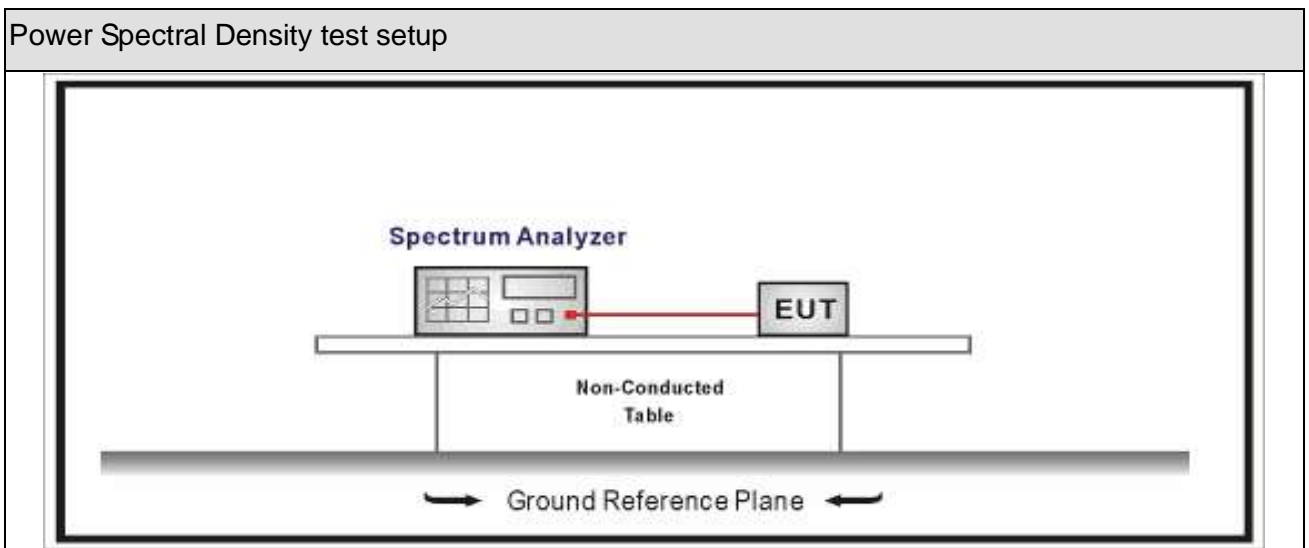



8.3. Limit

Power Spectral Density Limit
Power Spectral Density $\leq 8\text{dBm}/3\text{kHz}$

8.4. Test Procedure

Power Spectral Density Test Method			
	References Rule	Chapter	Description
<input checked="" type="checkbox"/>	ANSI C63.10	11.10	Maximum power spectral density level in the fundamental emission
<input type="checkbox"/>	ANSI C63.10	11.10.2	Method PKPSD (peak PSD)
<input checked="" type="checkbox"/>	ANSI C63.10	11.10.3	Method AVGPSD-1(Duty cycle \geq 98%)
<input type="checkbox"/>	ANSI C63.10	11.10.4	Method AVGPSD-1A(Duty cycle \geq 98%)
<input type="checkbox"/>	ANSI C63.10	11.10.5	Method AVGPSD-2(Duty cycle < 98%)
<input type="checkbox"/>	ANSI C63.10	11.10.6	Method AVGPSD-2A(Duty cycle < 98%)
<input type="checkbox"/>	ANSI C63.10	11.10.7	Method AVGPSD-3
<input type="checkbox"/>	ANSI C63.10	11.10.8	Method AVGPSD-3A

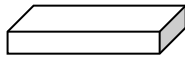
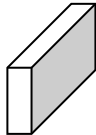
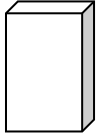
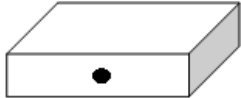
8.5. EUT test definition

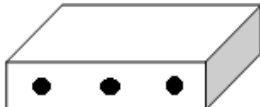
Item	Power Spectral Density Test Method			
Device Category	<input checked="" type="checkbox"/>	Fixed position use		
	<input type="checkbox"/>	Mobile position use		
Test mode	Mode 1			
Test method	<input type="checkbox"/>	Radiated		
		X Axis	Y Axis	Z Axis
				
		Worst Axis <input type="checkbox"/>	Worst Axis <input type="checkbox"/>	Worst Axis <input type="checkbox"/>
	<input checked="" type="checkbox"/>	Conducted		
	<input checked="" type="checkbox"/>	Chain 0		
				
	<input type="checkbox"/>	Chain 0	Chain 1	
				
	<input type="checkbox"/>	Chain 0	Chain 1	Chain 2
				

8.6. Test Result

Product Name	: Ring Bridge	Power	: AC 120V/60Hz
Test Mode	: Mode1	Test Site	: TR8
Test Date	: 2018.12.26		

Mode	Channel	Test Frequency (MHz)	Measurement PSD (dBm/3kHz)	Limit (dBm/3kHz)	Result
1	Low	902.5	-2.317	8.0	Pass
1	Mid	913.7	-5.767	8.0	Pass
1	High	927.3	-1.254	8.0	Pass

Mode 1 High Channel (927.3MHz)

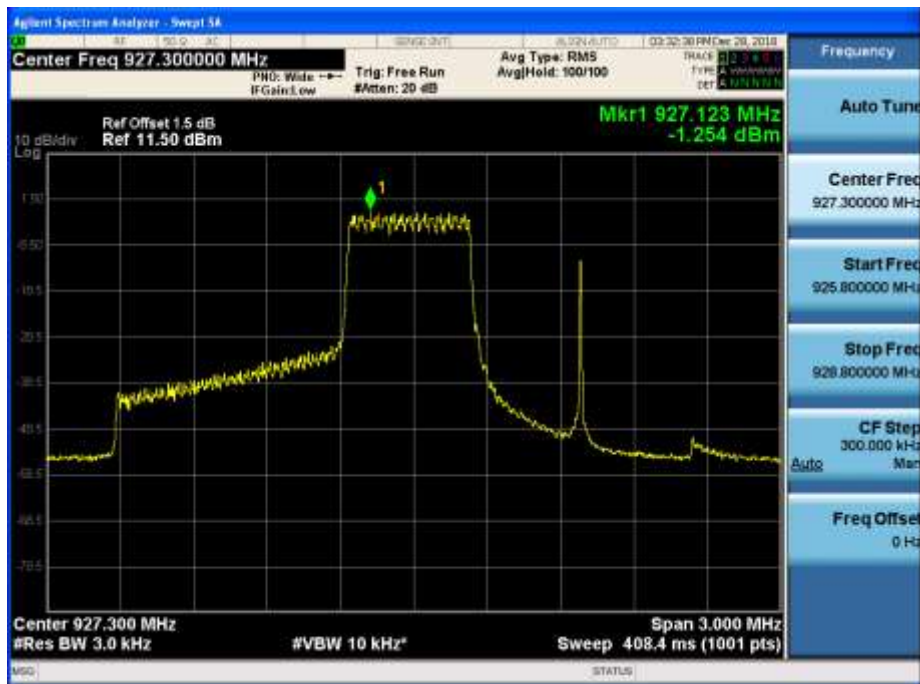

9. Antenna Requirement

9.1. Limit

Antenna Requirement Limit
<p>An intentional radiator shall be designed to ensure that no antenna other than that furnished by the responsible party shall be used with the device. The use of a permanently attached antenna or of an antenna that uses a unique coupling to the intentional radiator shall be considered sufficient to comply with the provisions of this section. The manufacturer may design the unit so that a broken antenna can be replaced by the user, but the use of a standard antenna jack or electrical connector is prohibited. This requirement does not apply to carrier current devices or to devices operated under the provisions of §15.211, §15.213, §15.217, §15.219, or §15.221. Further, this requirement does not apply to intentional radiators that must be professionally installed, such as perimeter protection systems and some field disturbance sensors, or to other intentional radiators which, in accordance with §15.31(d), must be measured at the installation site. However, the installer shall be responsible for ensuring that the proper antenna is employed so that the limits in this part are not exceeded.</p>

9.2. Antenna Connector Construction

Antenna Connector Construction	
<input checked="" type="checkbox"/>	The use of a permanently attached antenna
<input type="checkbox"/>	The antenna use of a unique coupling to the intentional radiator
<input type="checkbox"/>	The use of a nonstandard antenna jack or electrical connector
Please refer to the attached document "Internal Photograph " to show the antenna connector.	

_____ The End _____