



# FCC RF Test Report

APPLICANT : Ring LLC  
EQUIPMENT : Video Doorbell Pro 2  
BRAND NAME : Ring  
MODEL NAME : 5AT2S2  
FCC ID : 2AEUPBHALP031  
STANDARD : FCC Part 15 Subpart C §15.247  
CLASSIFICATION : (DSS) Spread Spectrum Transmitter

The product was received on Sep. 08, 2020 and testing was completed on Nov. 02, 2020. We, Sporton International (Kunshan) Inc., would like to declare that the tested sample has been evaluated in accordance with the test procedures and has been in compliance with the applicable technical standards.

The test results in this report apply exclusively to the tested model / sample. Without written approval of Sporton International (Kunshan) Inc., the test report shall not be reproduced except in full.

*Jason Jia*

Reviewed by: Jason Jia / Supervisor

*James Huang*

Approved by: James Huang / Manager



**Sporton International (Kunshan) Inc.**

**No. 1098, Pengxi North Road, Kunshan Economic Development Zone Jiangsu Province 215300  
People's Republic of China**



# TABLE OF CONTENTS

**REVISION HISTORY.....3**

**SUMMARY OF TEST RESULT .....4**

**1 GENERAL DESCRIPTION.....5**

1.1 Applicant .....5

1.2 Manufacturer.....5

1.3 Product Feature of Equipment Under Test.....5

1.4 Product Specification of Equipment Under Test.....5

1.5 Modification of EUT .....6

1.6 Testing Location .....6

1.7 Test Software.....6

1.8 Applicable Standards.....6

**2 TEST CONFIGURATION OF EQUIPMENT UNDER TEST.....7**

2.1 Carrier Frequency Channel .....7

2.2 Test Mode.....8

2.3 Connection Diagram of Test System.....9

2.4 Support Unit used in test configuration and system .....10

2.5 EUT Operation Test Setup .....10

2.6 Measurement Results Explanation Example.....10

**3 TEST RESULT .....11**

3.1 Number of Channel Measurement .....11

3.2 Hopping Channel Separation Measurement .....13

3.3 Dwell Time Measurement.....19

3.4 20dB and 99% Bandwidth Measurement .....21

3.5 Output Power Measurement.....32

3.6 Conducted Band Edges Measurement .....33

3.7 Conducted Spurious Emission Measurement .....40

3.8 Radiated Band Edges and Spurious Emission Measurement .....50

3.9 AC Conducted Emission Measurement.....54

3.10 Antenna Requirements.....56

**4 LIST OF MEASURING EQUIPMENT.....57**

**5 UNCERTAINTY OF EVALUATION.....58**

**APPENDIX A. CONDUCTED TEST RESULTS**

**APPENDIX B. AC CONDUCTED EMISSION TEST RESULT**

**APPENDIX C. RADIATED SPURIOUS EMISSION**

**APPENDIX D. DUTY CYCLE PLOTS**

**APPENDIX E. SETUP PHOTOGRAPHS**





## SUMMARY OF TEST RESULT

Report Section	FCC Rule	Description	Limit	Result	Remark
3.1	15.247(a)(1)	Number of Channels	≥ 15Chs	Pass	-
3.2	15.247(a)(1)	Hopping Channel Separation	≥ 2/3 of 20dB BW	Pass	-
3.3	15.247(a)(1)	Dwell Time of Each Channel	≤ 0.4sec in 31.6sec period	Pass	-
3.4	15.247(a)(1)	20dB Bandwidth	NA	Pass	-
3.4	-	99% Bandwidth	-	Pass	-
3.5	15.247(b)(1)	Peak Output Power	≤ 125 mW	Pass	-
3.6	15.247(d)	Conducted Band Edges	≤ 20dBc	Pass	-
3.7	15.247(d)	Conducted Spurious Emission	≤ 20dBc	Pass	-
3.8	15.247(d)	Radiated Band Edges and Radiated Spurious Emission	15.209(a) & 15.247(d)	Pass	Under limit 3.45 dB at 47.460 MHz
3.9	15.207	AC Conducted Emission	15.207(a)	Pass	Under limit 22.39 dB at 16.839 MHz
3.10	15.203 & 15.247(b)	Antenna Requirement	N/A	Pass	-

**Declaration of Conformity:**

The test results with all measurement uncertainty excluded are presented in accordance with the regulation limits or requirements declared by manufacturers.

**Comments and Explanations:**

The declared of product specification for EUT presented in the report are provided by the manufacturer, and the manufacturer takes all the responsibilities for the accuracy of product specification.



# 1 General Description

## 1.1 Applicant

Ring LLC  
1523 26th St, Santa Monica, CA 90404, USA

## 1.2 Manufacturer

Goertek Inc.  
No.268 Dongfang Road High-Tech Industrial Development District, Weifang Shandong, China

## 1.3 Product Feature of Equipment Under Test

Product Feature	
Equipment	Video Doorbell Pro 2
Brand Name	Ring
Model Name	5AT2S2
FCC ID	2AEUPBHALP031
EUT supports Radios application	WLAN 2.4GHz 802.11b/g/n HT20 WLAN 5GHz 802.11a/n HT20/HT40 WLAN 5GHz 802.11ac VHT20/VHT40/VHT80 Bluetooth BR/EDR/LE LoRa DTS/LoRa FHSS/FSK FHSS/ Radar
HW Version	R6
SW Version	7.1.61
EUT Stage	Production Unit

**Remark:** The above EUT's information was declared by manufacturer. Please refer to the specifications or user's manual for more detailed description.

## 1.4 Product Specification of Equipment Under Test

Standards-related Product Specification	
Tx/Rx Frequency Range	2402 MHz ~ 2480 MHz
Number of Channels	79
Carrier Frequency of Each Channel	2402+n*1 MHz; n=0~78
Maximum Output Power to Antenna	Bluetooth BR (1Mbps) : 9.61 dBm (0.0091 W) Bluetooth EDR (2Mbps) : 9.46 dBm (0.0088 W) Bluetooth EDR (3Mbps) : 9.93 dBm (0.0098 W)
99% Occupied Bandwidth	Bluetooth BR (1Mbps) : 0.915MHz Bluetooth EDR (2Mbps) : 1.198MHz Bluetooth EDR (3Mbps) : 1.204MHz
Antenna Type / Gain	Loop Antenna with gain 1.75 dBi
Type of Modulation	Bluetooth BR (1Mbps) : GFSK Bluetooth EDR (2Mbps) : $\pi/4$ -DQPSK Bluetooth EDR (3Mbps) : 8-DPSK



### 1.5 Modification of EUT

No modifications are made to the EUT during all test items.

### 1.6 Testing Location

Sporton International (Kunshan) Inc. is accredited to ISO/IEC 17025:2017 by American Association for Laboratory Accreditation with Certificate Number 5145.02.

<b>Test Firm</b>	Sporton International (Kunshan) Inc.		
<b>Test Site Location</b>	No. 1098, Pengxi North Road, Kunshan Economic Development Zone Jiangsu Province 215300 People's Republic of China TEL : +86-512-57900158 FAX : +86-512-57900958		
<b>Test Site No.</b>	<b>Sporton Site No.</b>	<b>FCC Designation No.</b>	<b>FCC Test Firm Registration No.</b>
	CO01-KS 03CH06-KS TH01-KS	CN1257	314309

### 1.7 Test Software

Item	Site	Manufacture	Name	Version
1.	03CH06-KS	AUDIX	E3	6.2009-8-24al
2.	CO01-KS	AUDIX	E3	6.2009-8-24

### 1.8 Applicable Standards

According to the specifications of the manufacturer, the EUT must comply with the requirements of the following standards:

- 47 CFR Part 15 Subpart C §15.247
- FCC KDB 558074 D01 15.247 Meas Guidance v05r02
- ANSI C63.10-2013

**Remark:**

1. All test items were verified and recorded according to the standards and without any deviation during the test.
2. This EUT has also been tested and complied with the requirements of FCC Part 15, Subpart B, recorded in a separate test report.



## 2 Test Configuration of Equipment Under Test

### 2.1 Carrier Frequency Channel

Frequency Band	Channel	Freq. (MHz)	Channel	Freq. (MHz)	Channel	Freq. (MHz)
2400-2483.5 MHz	0	2402	27	2429	54	2456
	1	2403	28	2430	55	2457
	2	2404	29	2431	56	2458
	3	2405	30	2432	57	2459
	4	2406	31	2433	58	2460
	5	2407	32	2434	59	2461
	6	2408	33	2435	60	2462
	7	2409	34	2436	61	2463
	8	2410	35	2437	62	2464
	9	2411	36	2438	63	2465
	10	2412	37	2439	64	2466
	11	2413	38	2440	65	2467
	12	2414	39	2441	66	2468
	13	2415	40	2442	67	2469
	14	2416	41	2443	68	2470
	15	2417	42	2444	69	2471
	16	2418	43	2445	70	2472
	17	2419	44	2446	71	2473
	18	2420	45	2447	72	2474
	19	2421	46	2448	73	2475
	20	2422	47	2449	74	2476
	21	2423	48	2450	75	2477
	22	2424	49	2451	76	2478
	23	2425	50	2452	77	2479
	24	2426	51	2453	78	2480
	25	2427	52	2454	-	-
	26	2428	53	2455	-	-



## 2.2 Test Mode

- a. The EUT has been associated with peripherals and configuration operated in a manner tended to maximize its emission characteristics in a typical application. Frequency range investigated: conduction emission (150 kHz to 30 MHz), radiation emission (9 kHz to the 10th harmonic of the highest fundamental frequency or to 40 GHz, whichever is lower). For radiated measurement, pre-scanned in three orthogonal panels, X, Y, Z. The worst cases (Y plane) were recorded in this report, and the worst mode of radiated spurious emissions is Bluetooth 3Mbps mode, and recorded in this report.
- b. AC power line Conducted Emission was tested under maximum output power.

The following summary table is showing all test modes to demonstrate in compliance with the standard.

Summary table of Test Cases			
Test Item	Data Rate / Modulation		
	Bluetooth BR 1Mbps GFSK	Bluetooth EDR 2Mbps π/4-DQPSK	Bluetooth EDR 3Mbps 8-DPSK
Conducted Test Cases	Mode 1: CH00_2402 MHz Mode 2: CH39_2441 MHz Mode 3: CH78_2480 MHz	Mode 4: CH00_2402 MHz Mode 5: CH39_2441 MHz Mode 6: CH78_2480 MHz	Mode 7: CH00_2402 MHz Mode 8: CH39_2441 MHz Mode 9: CH78_2480 MHz
Radiated Test Cases	Bluetooth EDR 3Mbps 8-DPSK Mode 1: CH00_2402 MHz Mode 2: CH39_2441 MHz Mode 3: CH78_2480 MHz		
AC Conducted Emission	Mode 1 : Lora Tx + Bluetooth Link + WLAN Link (2.4G) + Adapter + 24G Radar Tx		
<b>Remark:</b> <ol style="list-style-type: none"> <li>1. For radiated test cases, the worst mode data rate 3Mbps was reported only, because this data rate has the highest RF output power at preliminary tests, and no other significantly frequencies found in conducted spurious emission.</li> <li>2. For Radiated Test Cases, The tests were performed with Adapter.</li> </ol>			



## 2.3 Connection Diagram of Test System

For Radiated Emission:

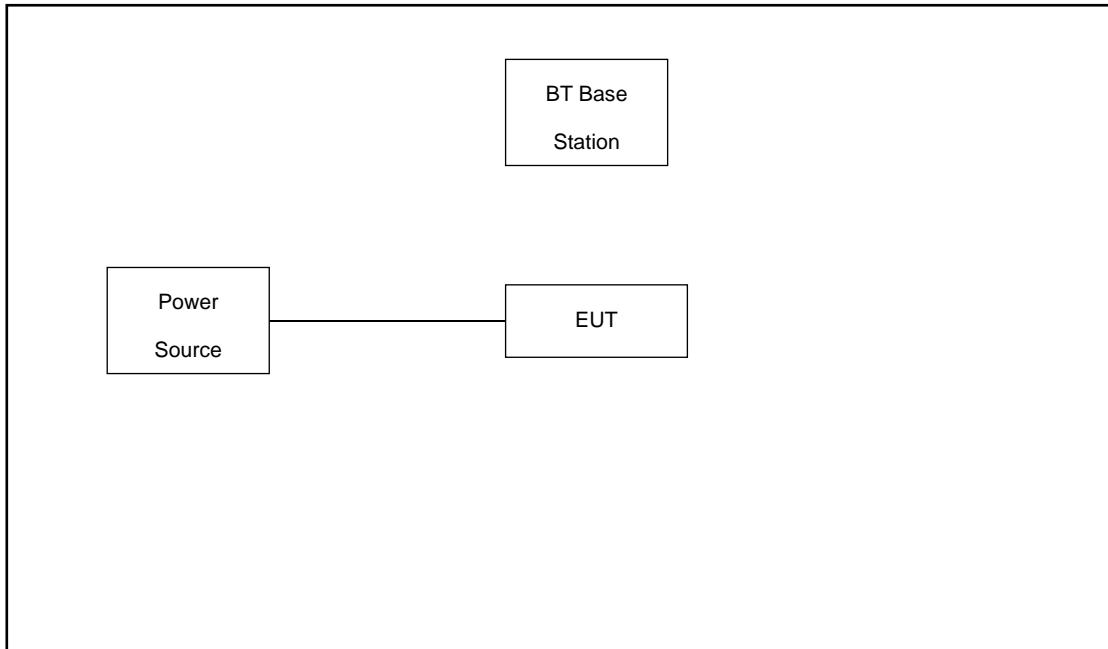

For AC Conducted Emission:

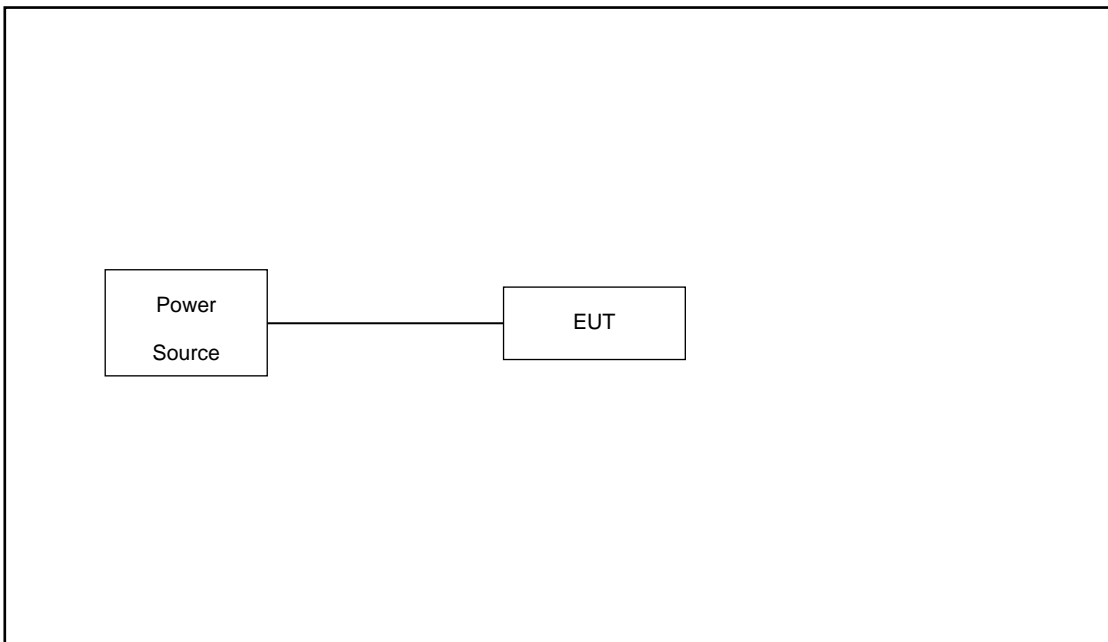

## 2.4 Support Unit used in test configuration and system

Item	Equipment	Trade Name	Model Name	FCC ID	Data Cable	Power Cord
1.	Bluetooth Base Station	R&S	CBT	N/A	N/A	Unshielded, 1.8m
2.	Phone	MOTO	XT1952-1	XXXX	N/A	N/A
3.	WLAN AP	D-link	DIR-655	KA21R655B1	N/A	Unshielded, 1.8m
4.	Notebook	Lenovo	G480	QDS-BRCM1050I	N/A	AC I/P: Unshielded, 1.8 m DC O/P: Shielded, 1.8 m

## 2.5 EUT Operation Test Setup

For Bluetooth function, the engineering test program was provided and enabled to make EUT connect with Bluetooth base station to continuous transmit/receive.

For AC power line conducted emissions, the EUT was set to connect with the WLAN AP under large package sizes transmission.

## 2.6 Measurement Results Explanation Example

**For all conducted test items:**

The offset level is set in the spectrum analyzer to compensate the RF cable loss between EUT conducted output port and spectrum analyzer. With the offset compensation, the spectrum analyzer reading level is exactly the EUT RF output level.

Example:

The spectrum analyzer offset is derived from RF cable loss.

*Offset = RF cable loss.*

Following shows an offset computation example with cable loss 5.5 dB.

$$\begin{aligned} \text{Offset(dB)} &= \text{RF cable loss(dB)} . \\ &= 5.5 \text{ (dB)} \end{aligned}$$

### 3 Test Result

#### 3.1 Number of Channel Measurement

##### 3.1.1 Limits of Number of Hopping Frequency

Frequency hopping systems in the 2400-2483.5 MHz band shall use at least 15 channels.

##### 3.1.2 Measuring Instruments

The measuring equipment is listed in the section 4 of this test report.

##### 3.1.3 Test Procedure

1. The testing follows ANSI C63.10-2013 clause 7.8.3.
2. The RF output of EUT was connected to the spectrum analyzer by RF cable and attenuator. The path loss was compensated to the results for each measurement.
3. Set to the maximum power setting and enable the EUT transmit continuously.
4. Enable the EUT hopping function.
5. Use the following spectrum analyzer settings: Span = the frequency band of operation; RBW = 300kHz; VBW  $\geq$  RBW; Sweep = auto; Detector function = peak; Trace = max hold.
6. The number of hopping frequency used is defined as the number of total channel.
7. Record the measurement data derived from spectrum analyzer.

##### 3.1.4 Test Setup



##### 3.1.5 Test Result of Number of Hopping Frequency

Please refer to Appendix A.



Number of Hopping Channel Plot on Channel 00 - 78

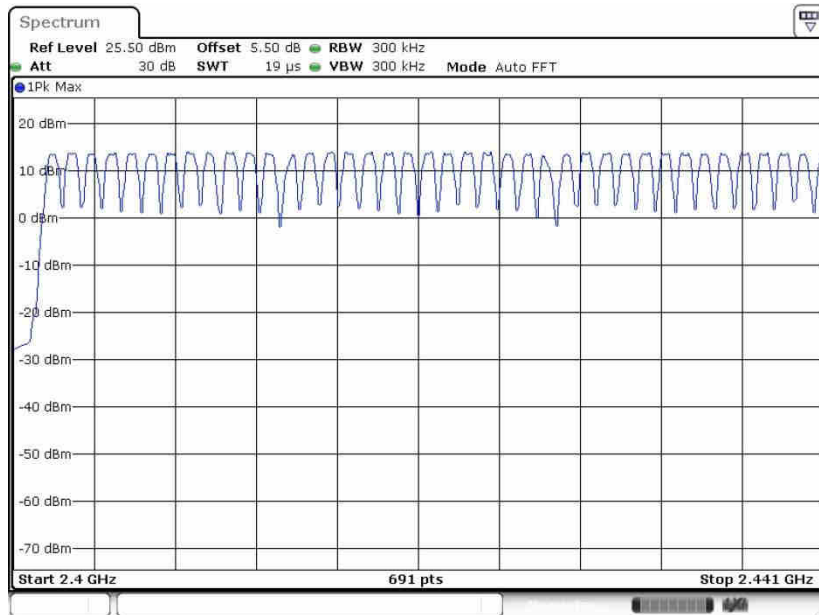

Date: 26 SEP 2020 13:10:26

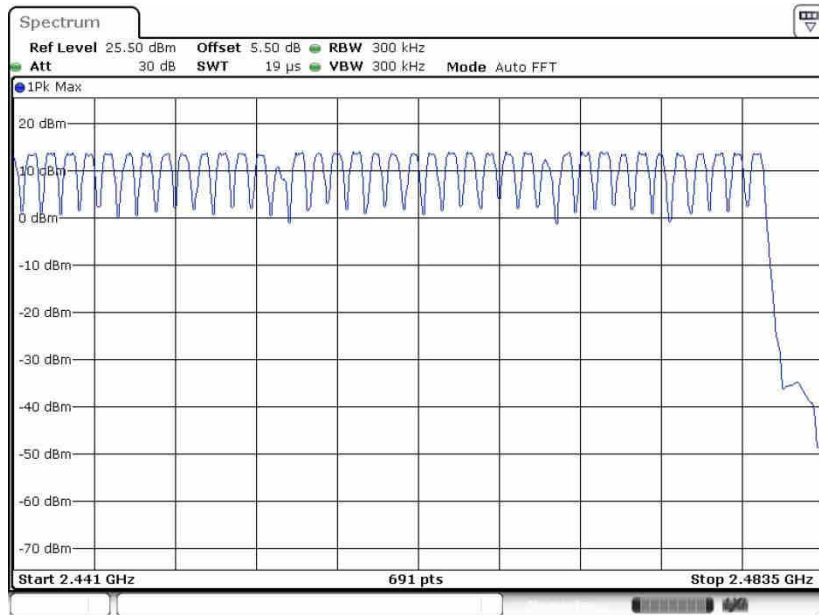

Date: 26 SEP 2020 13:10:53

## 3.2 Hopping Channel Separation Measurement

### 3.2.1 Limit of Hopping Channel Separation

Frequency hopping systems operating in the 2400-2483.5 MHz band may have hopping channel carrier frequencies that are separated by 25 kHz or two-thirds of the 20 dB bandwidth of the hopping channel, whichever is greater.

### 3.2.2 Measuring Instruments

The measuring equipment is listed in the section 4 of this test report.

### 3.2.3 Test Procedures

1. The testing follows ANSI C63.10-2013 clause 7.8.2.
2. The RF output of EUT was connected to the spectrum analyzer by RF cable and attenuator. The path loss was compensated to the results for each measurement.
3. Set to the maximum power setting and enable the EUT transmit continuously.
4. Enable the EUT hopping function.
5. Use the following spectrum analyzer settings:  
Span = wide enough to capture the peaks of two adjacent channels;  
RBW = 300kHz; VBW  $\geq$  RBW; Sweep = auto; Detector function = peak; Trace = max hold.
6. Measure and record the results in the test report.

### 3.2.4 Test Setup



### 3.2.5 Test Result of Hopping Channel Separation

Please refer to Appendix A.



<1Mbps>

Channel Separation Plot on Channel 00 - 01

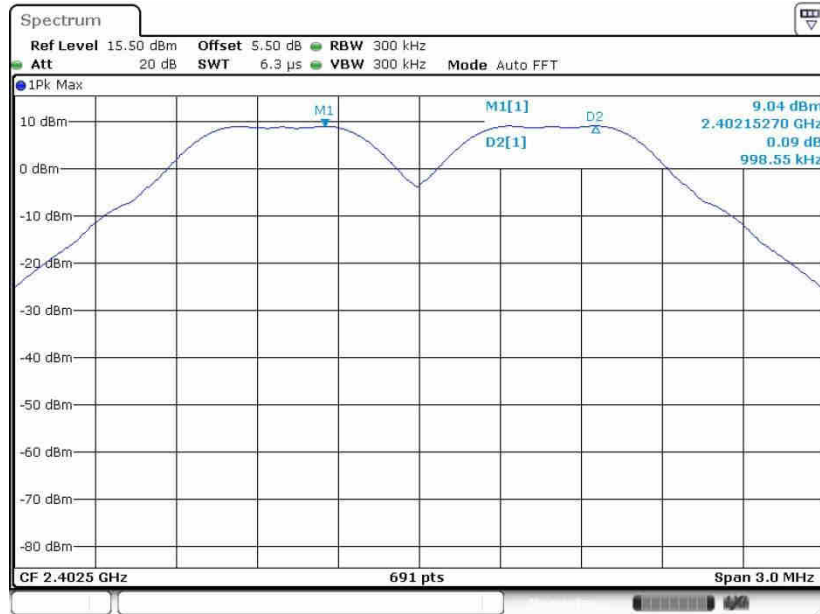

Date: 26.SEP.2020 06:17:33

Channel Separation Plot on Channel 39 - 40

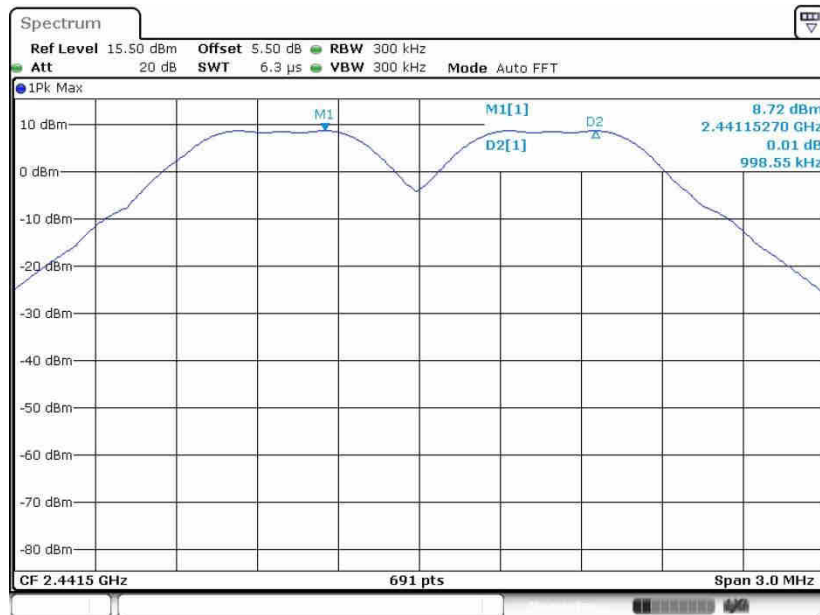

Date: 26.SEP.2020 12:52:06



Channel Separation Plot on Channel 77 - 78

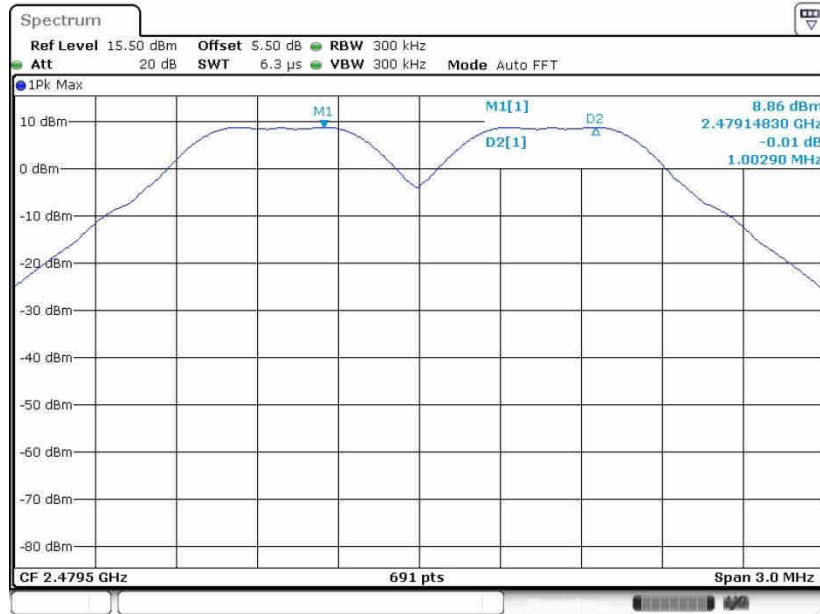

Date: 26.SEP.2020 13:01:09

<2Mbps>

Channel Separation Plot on Channel 00 - 01

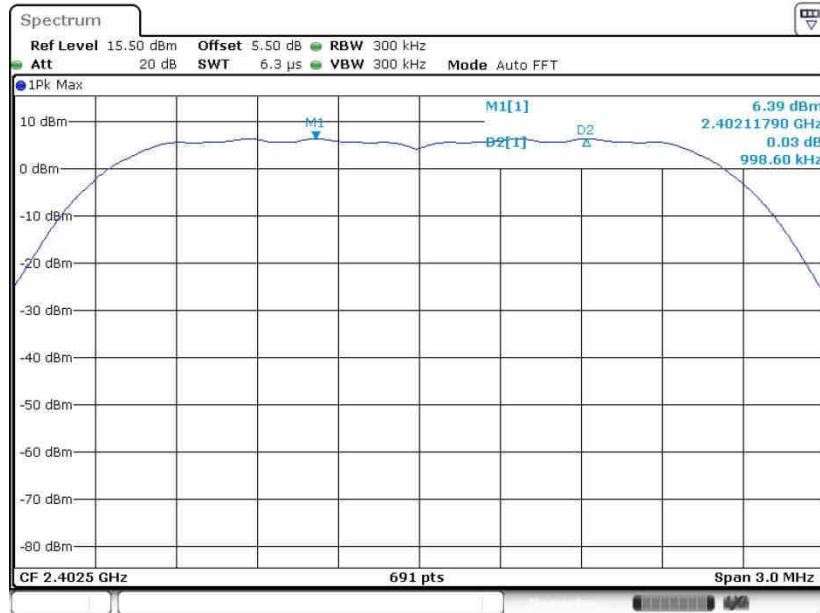

Date: 26.SEP.2020 13:17:41



Channel Separation Plot on Channel 39 - 40

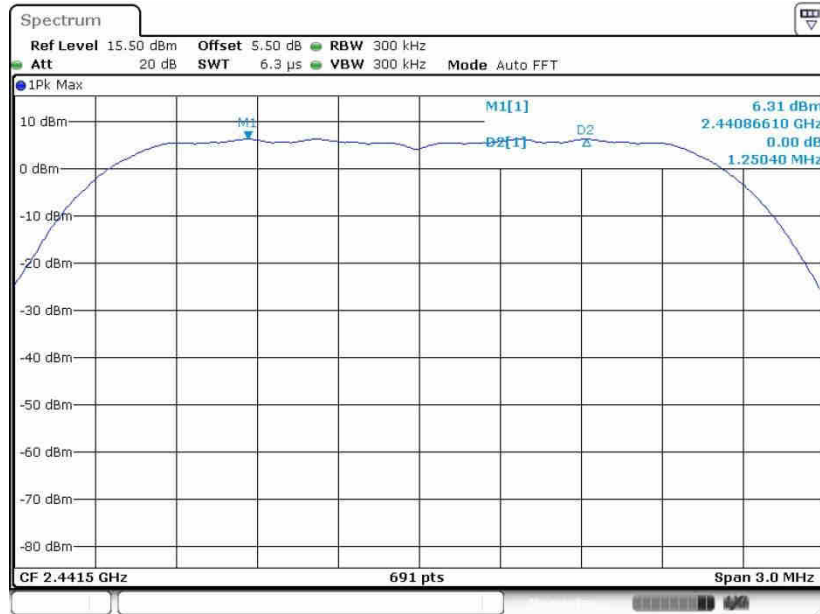

Date: 26.SEP.2020 13:24:20

Channel Separation Plot on Channel 77 - 78

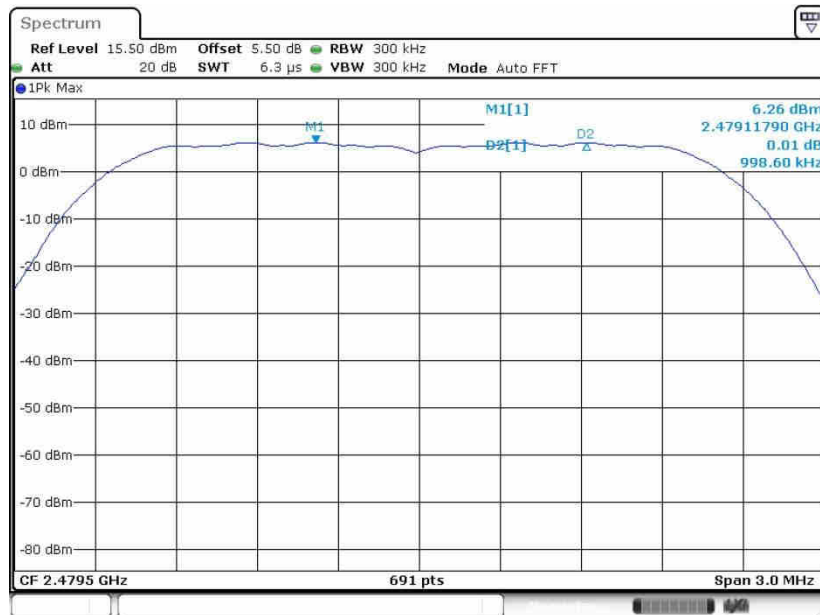

Date: 26.SEP.2020 13:31:26





<3Mbps>

Channel Separation Plot on Channel 00 - 01

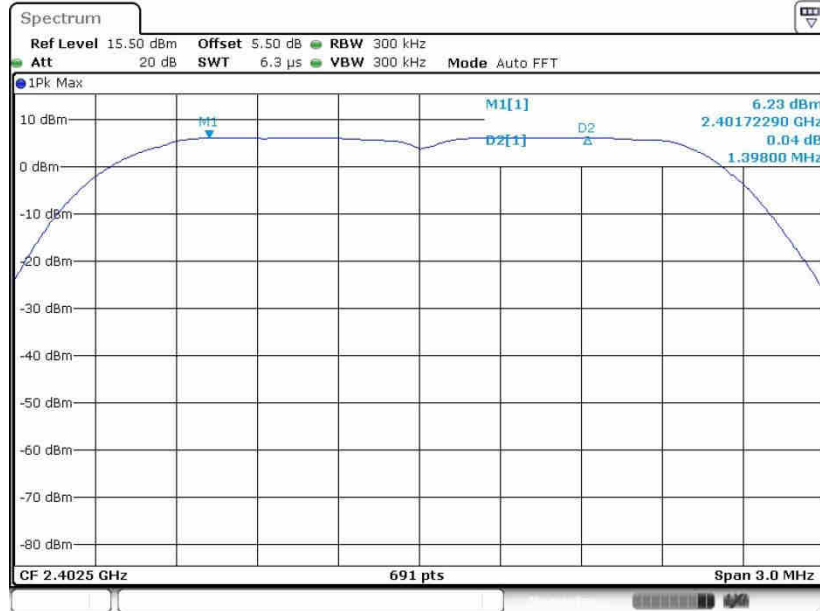

Date: 26.SEP.2020 13:50:44

Channel Separation Plot on Channel 39 - 40

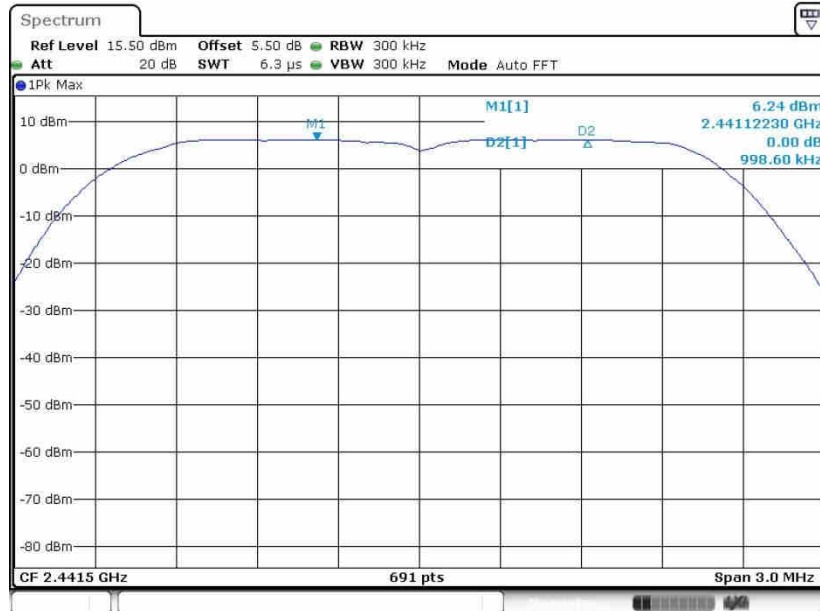

Date: 26.SEP.2020 13:44:50



Channel Separation Plot on Channel 77 - 78

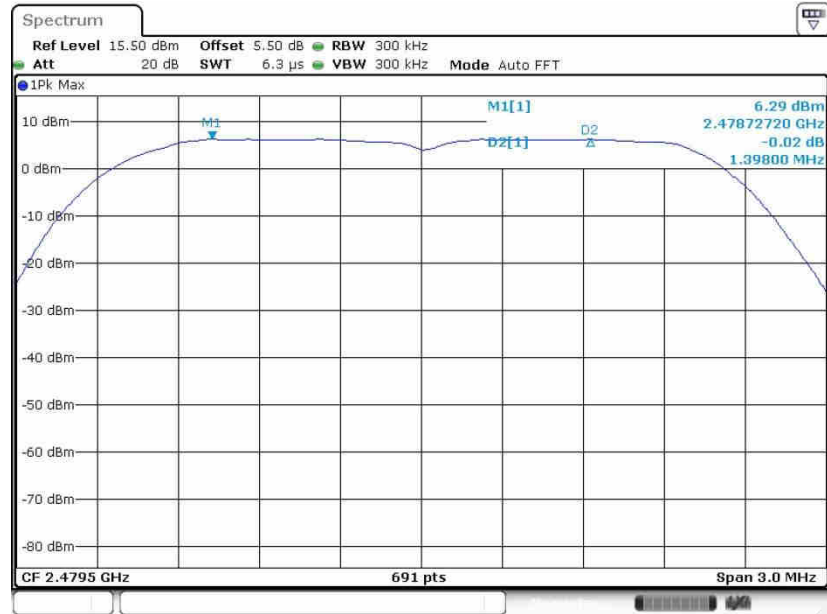

Date: 26.SEP.2020 13:37:09

### 3.3 Dwell Time Measurement

#### 3.3.1 Limit of Dwell Time

The average time of occupancy on any channel shall not be greater than 0.4 seconds within a period of 0.4 seconds multiplied by the number of hopping channels employed.

#### 3.3.2 Measuring Instruments

The measuring equipment is listed in the section 4 of this test report.

#### 3.3.3 Test Procedures

1. The testing follows ANSI C63.10-2013 clause 7.8.4.
2. The RF output of EUT was connected to the spectrum analyzer by RF cable and attenuator. The path loss was compensated to the results for each measurement.
3. Set to the maximum power setting and enable the EUT transmit continuously.
4. Enable the EUT hopping function.
5. Use the following spectrum analyzer settings: Span = zero span, centered on a hopping channel; RBW = 1 MHz; VBW  $\geq$  RBW; Sweep = as necessary to capture the entire dwell time per hopping channel; Detector function = peak; Trace = max hold.
6. Measure and record the results in the test report.

#### 3.3.4 Test Setup





### 3.3.5 Test Result of Dwell Time

Please refer to Appendix A.

Package Transfer Time Plot

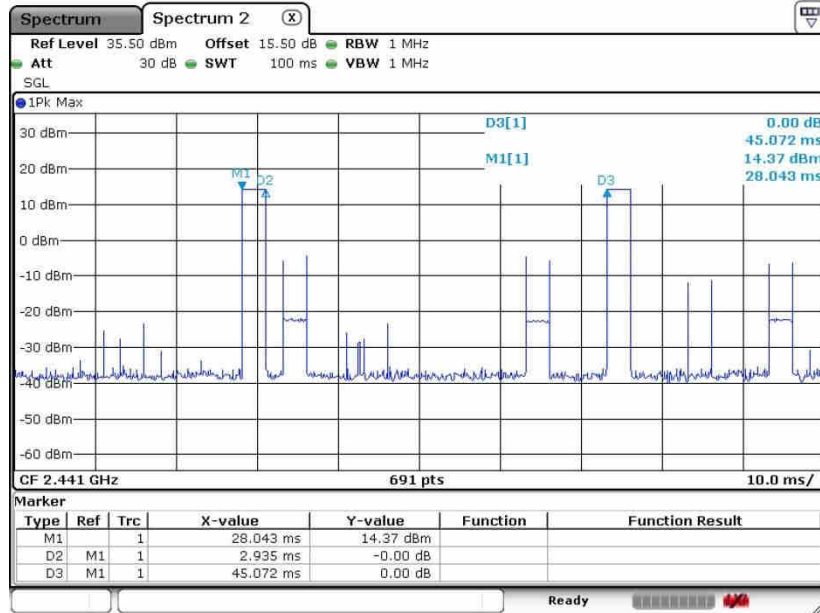

Date: 29.OCT.2020 09:23:11

**Remark:**

- In normal mode, hopping rate is 1600 hops/s with 6 slots (5 Transmit and 1 Receive slot) in 79 hopping channels.  
With channel hopping rate (1600 / 6 / 79) in Occupancy Time Limit (0.4 x 79) (s), Hops Over Occupancy Time comes to (1600 / 6 / 79) x (0.4 x 79) = 106.67 hops.
- In AFH mode, hopping rate is 800 hops/s with 6 slots in 20 hopping channels.  
With channel hopping rate (800 / 6 / 20) in Occupancy Time Limit (0.4 x 20) (s), Hops Over Occupancy Time comes to (800 / 6 / 20) x (0.4 x 20) = 53.33 hops.
- Dwell Time(s) = Hops Over Occupancy Time (hops) x Package Transfer Time

## 3.4 20dB and 99% Bandwidth Measurement

### 3.4.1 Limit of 20dB and 99% Bandwidth

Reporting only

### 3.4.2 Measuring Instruments

The measuring equipment is listed in the section 4 of this test report.

### 3.4.3 Test Procedures

1. The testing follows ANSI C63.10-2013 clause 6.9.2 and 6.9.3.
2. The RF output of EUT was connected to the spectrum analyzer by RF cable and attenuator. The path loss was compensated to the results for each measurement.
3. Set to the maximum power setting and enable the EUT transmit continuously.
4. Use the following spectrum analyzer settings for 20dB Bandwidth measurement.  
Span = approximately 2 to 5 times the 20 dB bandwidth, centered on a hopping channel;  
RBW  $\geq$  1% of the 20 dB bandwidth; VBW  $\geq$  RBW; Sweep = auto; Detector function = peak;  
Trace = max hold.
5. Use the following spectrum analyzer settings for 99 % Bandwidth measurement.  
Span = approximately 1.5 to 5 times the 99% bandwidth, centered on a hopping channel;  
RBW  $\geq$  1% of the 99% bandwidth; VBW  $\geq$  RBW; Sweep = auto; Detector function = peak;  
Trace = max hold.
6. Measure and record the results in the test report.

### 3.4.4 Test Setup

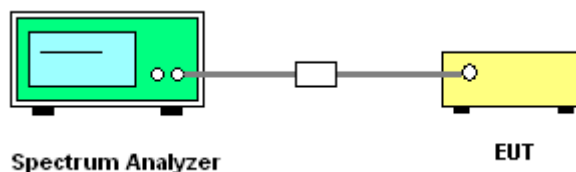

### 3.4.5 Test Result of 20dB Bandwidth

Please refer to Appendix A.



<1Mbps>

20 dB Bandwidth Plot on Channel 00

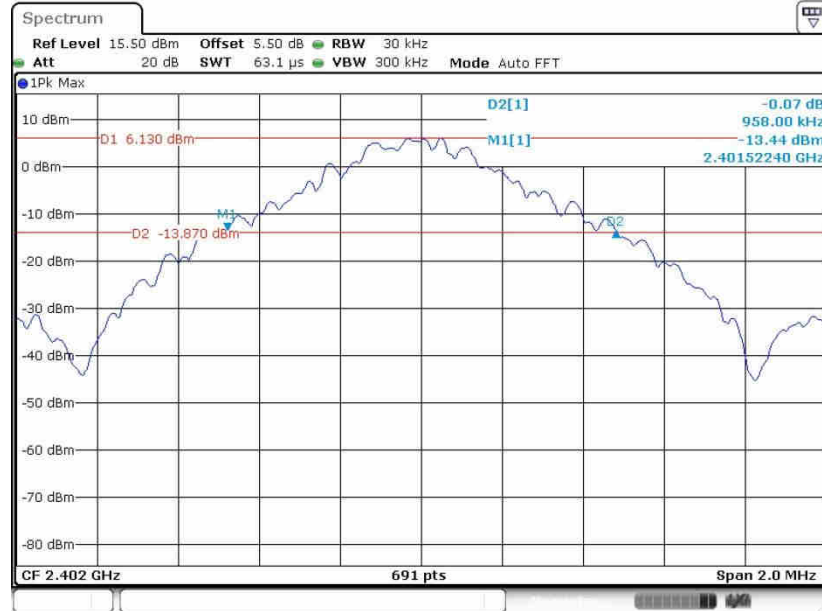

Date: 26.SEP.2020 06:19:20

20 dB Bandwidth Plot on Channel 39



Date: 26.SEP.2020 12:53:27



20 dB Bandwidth Plot on Channel 78

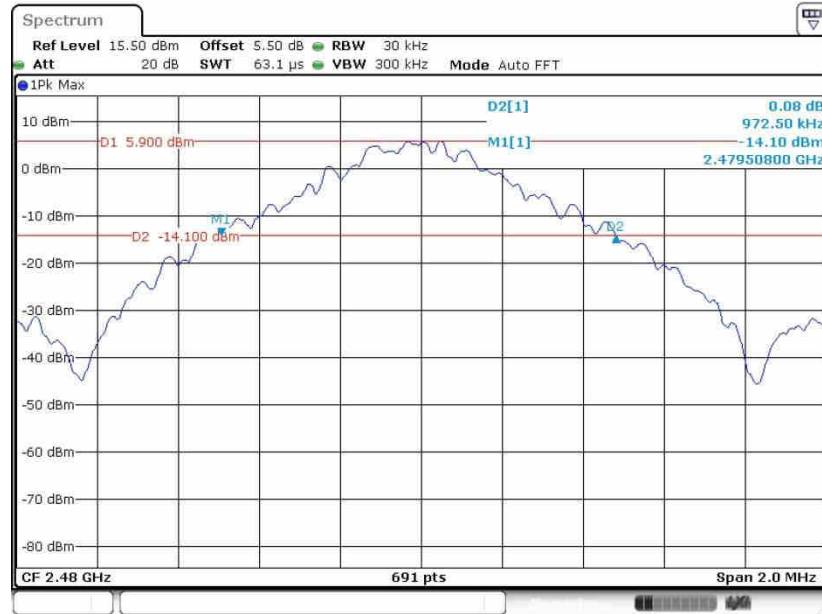

Date: 26.SEP.2020 13:02:24

<2Mbps>

20 dB Bandwidth Plot on Channel 00

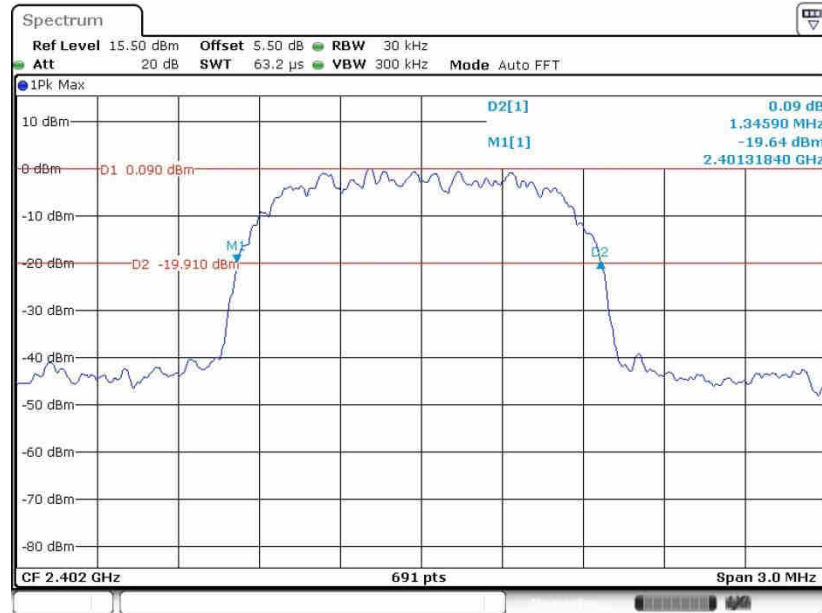

Date: 26.SEP.2020 13:18:42



### 20 dB Bandwidth Plot on Channel 39

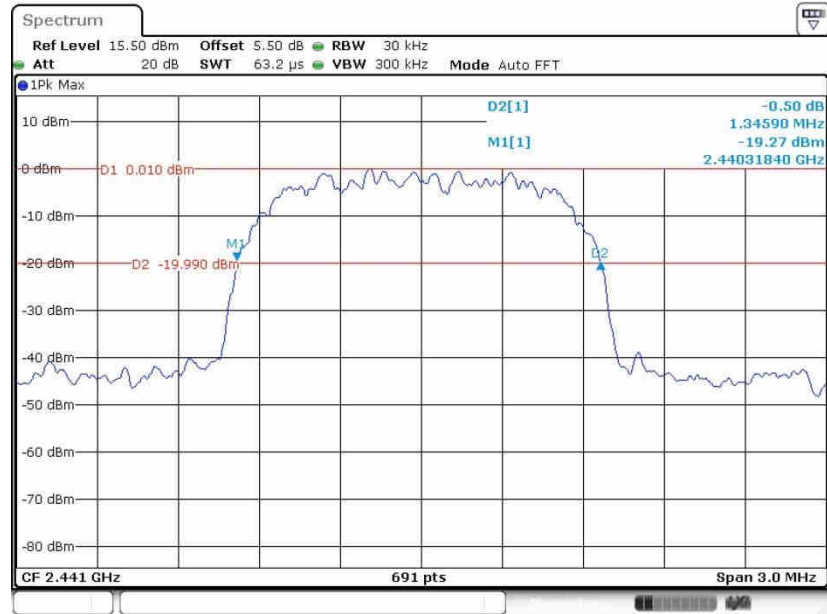

Date: 26.SEP.2020 13:25:31

### 20 dB Bandwidth Plot on Channel 78

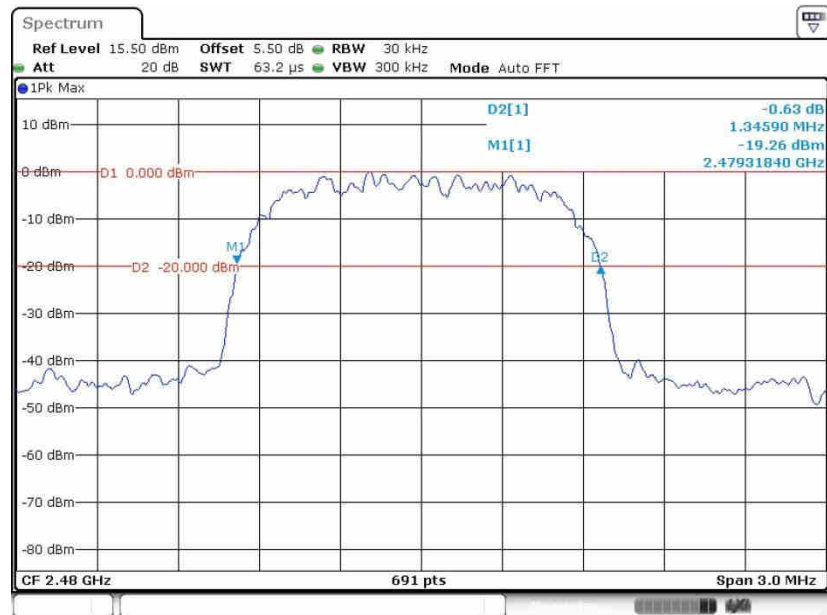

Date: 26.SEP.2020 13:32:28





<3Mbps>

20 dB Bandwidth Plot on Channel 00

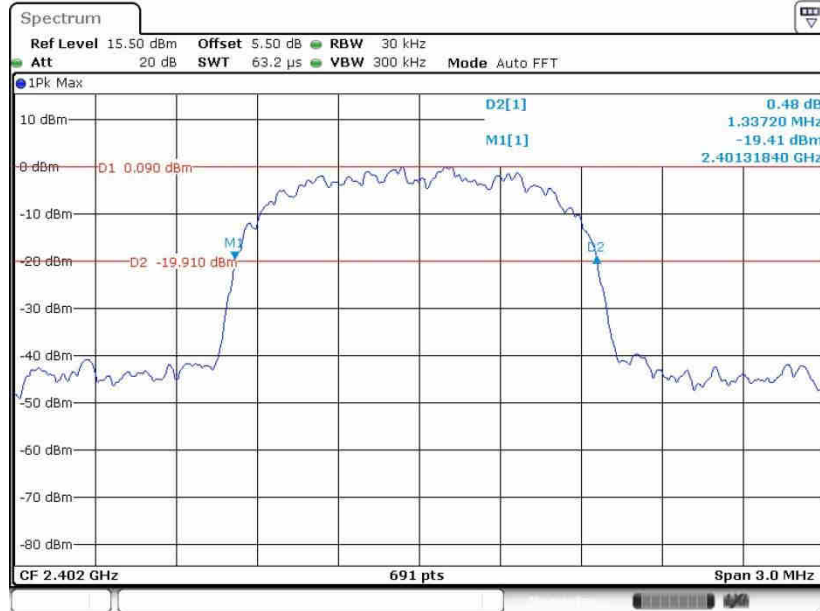

Date: 26.SEP.2020 13:51:45

20 dB Bandwidth Plot on Channel 39

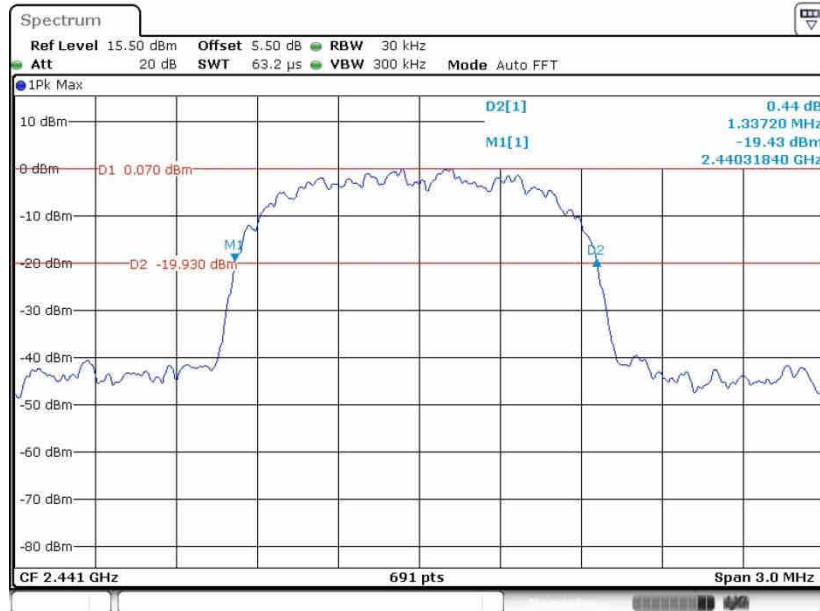

Date: 26.SEP.2020 13:45:54



20 dB Bandwidth Plot on Channel 78

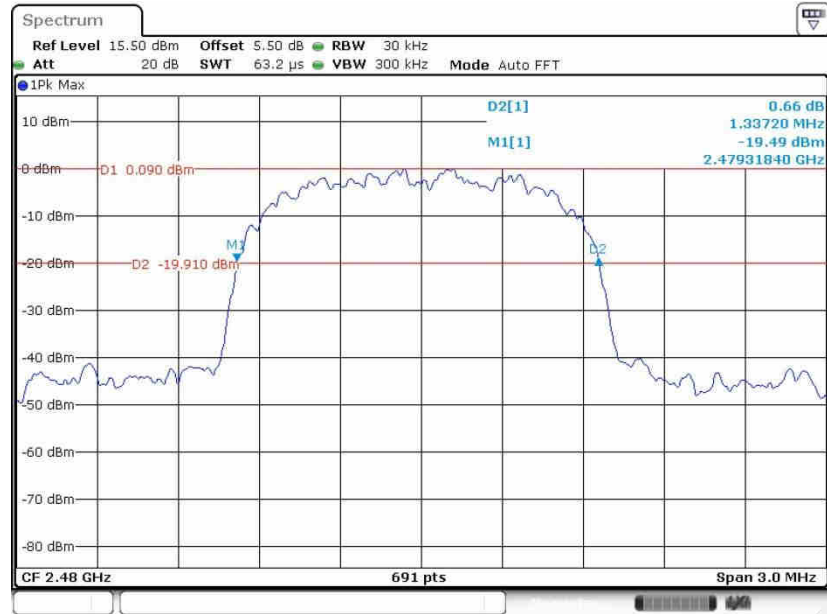

Date: 26.SEP.2020 13:38:15



### 3.4.6 Test Result of 99% Occupied Bandwidth

Please refer to Appendix A.

<1Mbps>

#### 99% Occupied Bandwidth Plot on Channel 00



Date: 26.SEP.2020 06:21:22



99% Occupied Bandwidth Plot on Channel 39



Date: 26.SEP.2020 12:54:03

99% Occupied Bandwidth Plot on Channel 78

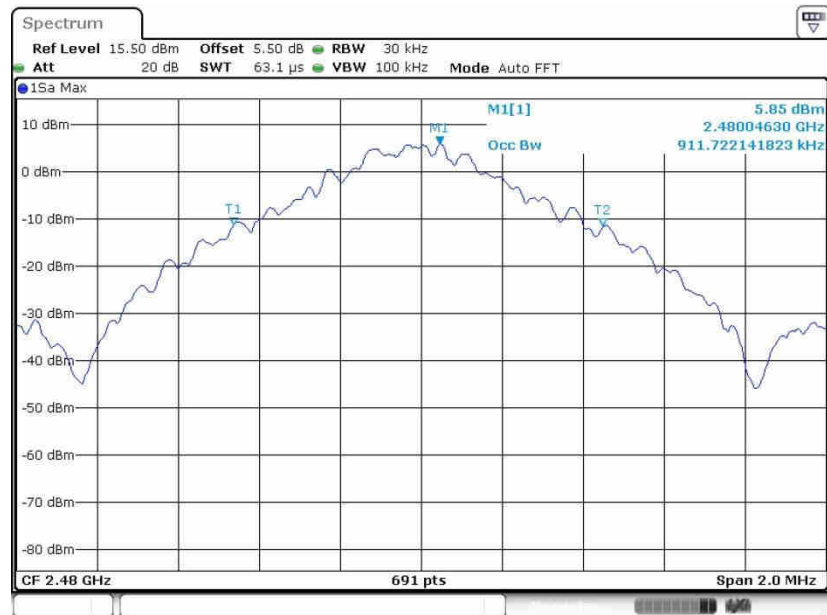

Date: 26.SEP.2020 13:03:46



<2Mbps>

99% Occupied Bandwidth Plot on Channel 00

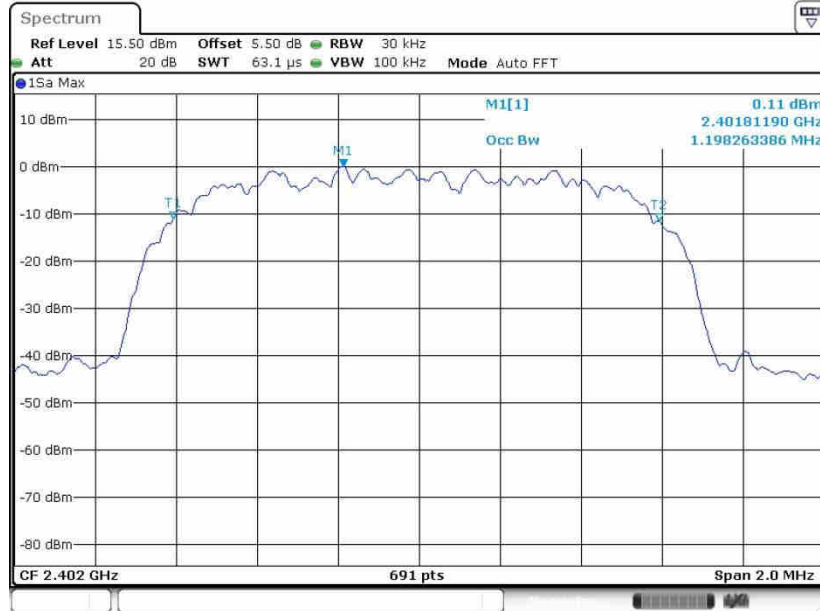

Date: 26.SEP.2020 13:19:56

99% Occupied Bandwidth Plot on Channel 39

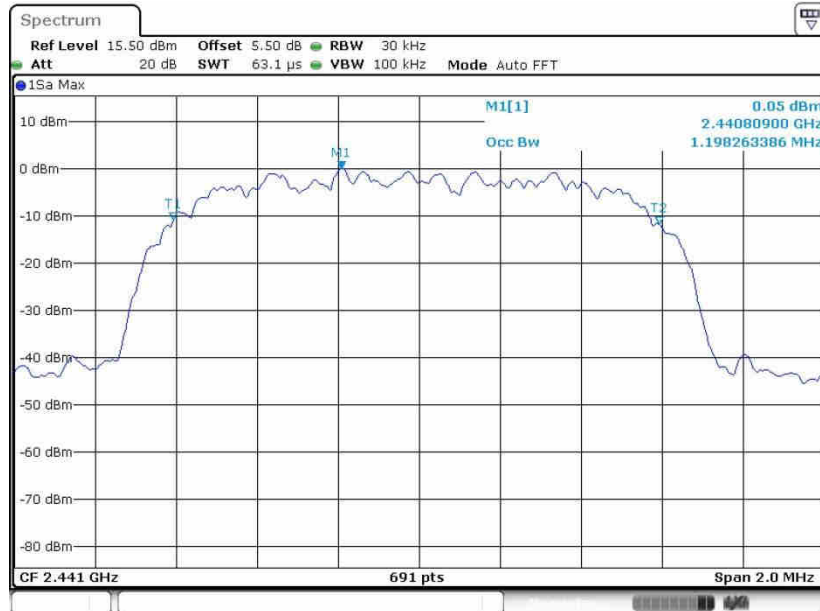

Date: 26.SEP.2020 13:26:10



99% Occupied Bandwidth Plot on Channel 78

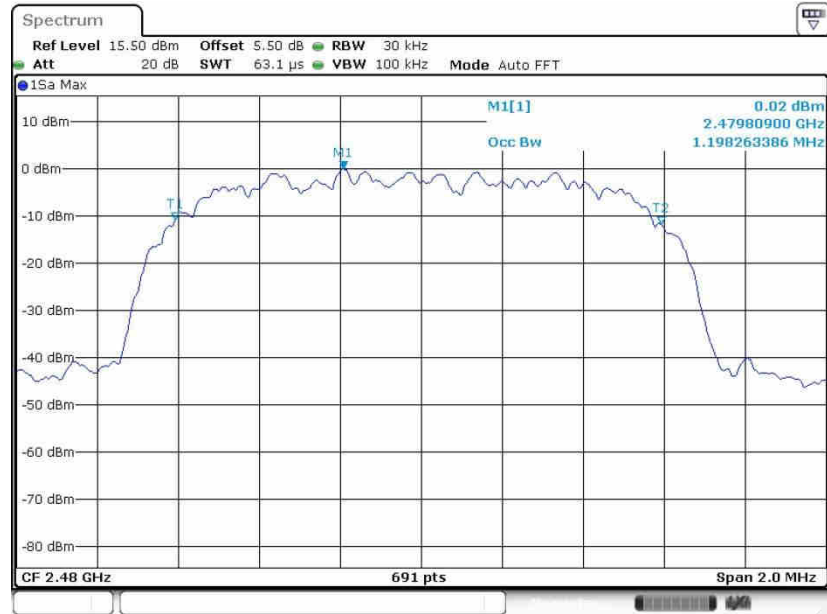

Date: 26.SEP.2020 13:33:38

<3Mbps>

99% Occupied Bandwidth Plot on Channel 00

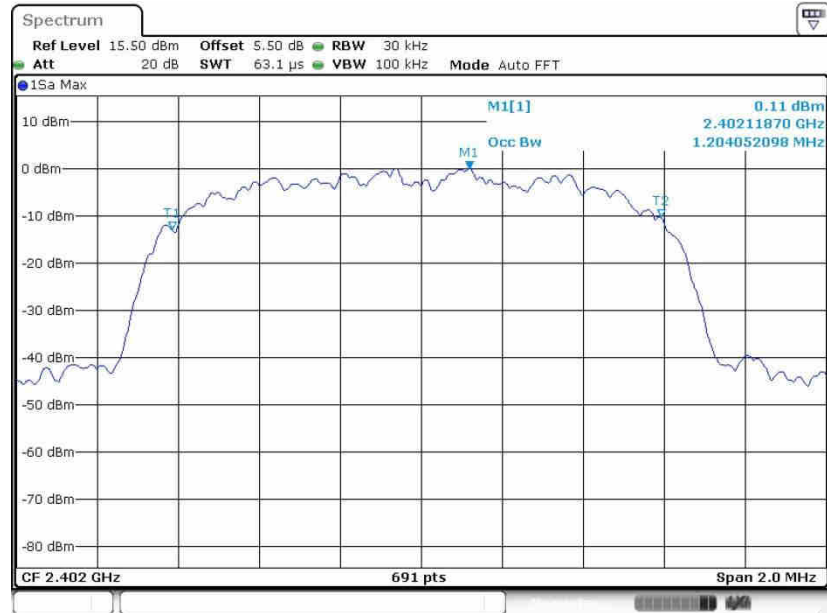

Date: 26.SEP.2020 13:52:41



99% Occupied Bandwidth Plot on Channel 39

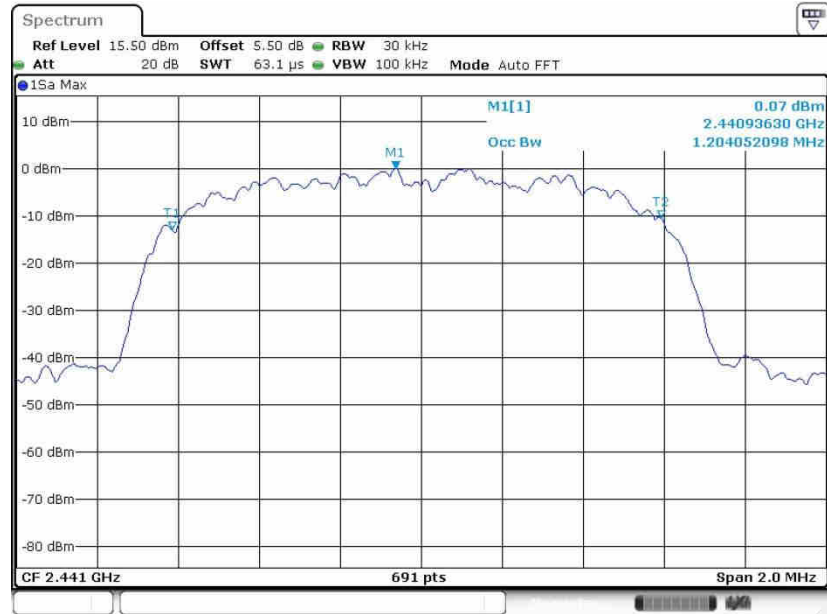

Date: 26.SEP.2020 13:46:29

99% Occupied Bandwidth Plot on Channel 78

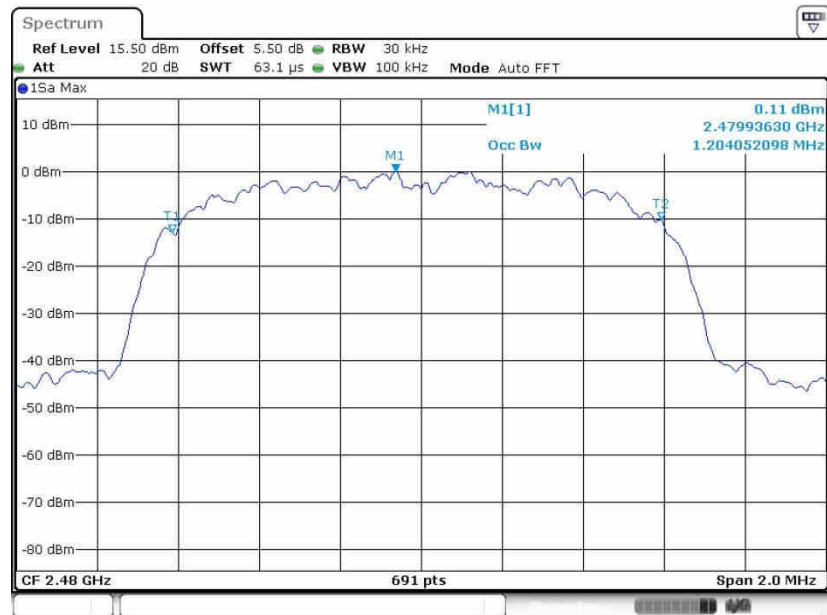

Date: 26.SEP.2020 13:39:11

Note : The occupied channel bandwidth is maintained within the band of operation for all of the modulations.

## 3.5 Output Power Measurement

### 3.5.1 Limit of Output Power

The maximum peak conducted output power of the intentional radiator shall not exceed the following:

(1) For frequency hopping systems operating in the 2400-2483.5 MHz band employing at least 75 non-overlapping hopping channels, and all frequency hopping systems in the 5725-5850 MHz band: 1 watt. For all other frequency hopping systems in the 2400-2483.5 MHz band 0.125 watts. The power limit for 1Mbps, 2Mbps, 3Mbps and AFH modes are 0.125 watts.

### 3.5.2 Measuring Instruments

The measuring equipment is listed in the section 4 of this test report.

### 3.5.3 Test Procedures

1. The testing follows ANSI C63.10-2013 clause 7.8.5.
2. The RF output of EUT was connected to the power meter by RF cable and attenuator. The path loss was compensated to the results for each measurement.
3. Set to the maximum power setting and enable the EUT transmit continuously.
4. Measure the conducted output power with cable loss and record the results in the test report.
5. Measure and record the results in the test report.

### 3.5.4 Test Setup

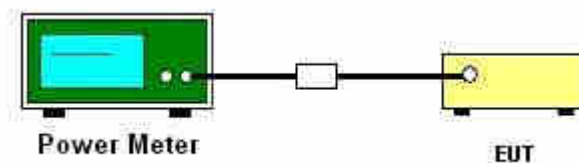

### 3.5.5 Test Result of Peak Output Power

Please refer to Appendix A.



## 3.6 Conducted Band Edges Measurement

### 3.6.1 Limit of Band Edges

In any 100 kHz bandwidth outside the intentional radiation frequency band, the radio frequency power shall be at least 20 dB below the highest level of the radiated power. In addition, radiated emissions which fall in the restricted bands must also comply with the radiated emission limits.

### 3.6.2 Measuring Instruments

The measuring equipment is listed in the section 4 of this test report.

### 3.6.3 Test Procedures

1. The testing follows ANSI C63.10-2013 clause 7.8.6.
2. Set to the maximum power setting and enable the EUT transmit continuously.
3. Set RBW = 100kHz, VBW = 300kHz. Band edge emissions must be at least 20 dB down from the highest emission level within the authorized band as measured with a 100kHz RBW. The attenuation shall be 30 dB instead of 20 dB when RMS conducted output power procedure is used.
4. Enable hopping function of the EUT and then repeat step 2. and 3.
5. Measure and record the results in the test report.

### 3.6.4 Test Setup





### 3.6.5 Test Result of Conducted Band Edges

<1Mbps>

#### Low Band Edge Plot on Channel 00

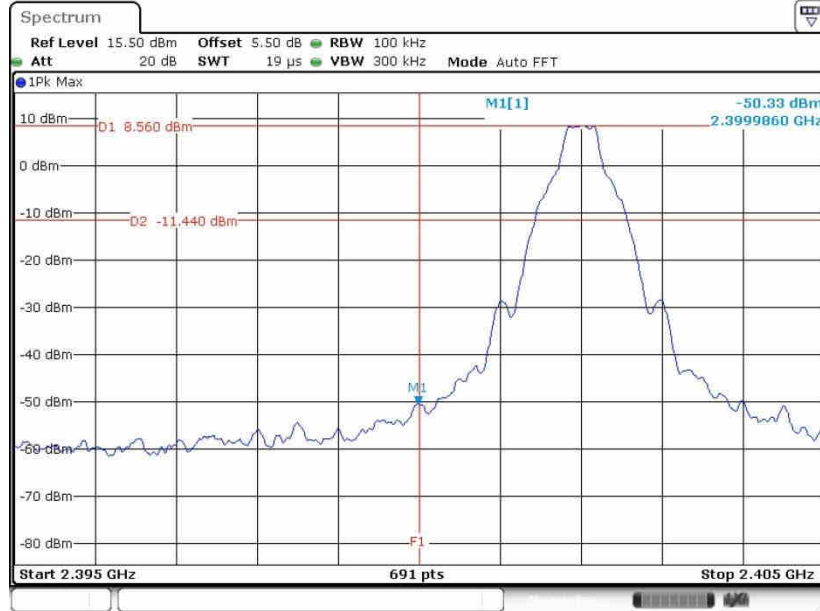

#### High Band Edge Plot on Channel 78

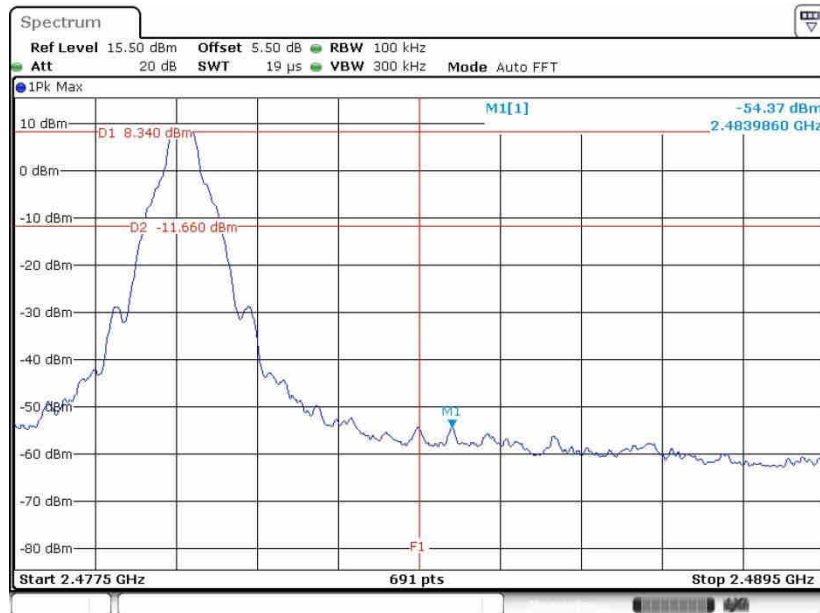



<2Mbps>

Low Band Edge Plot on Channel 00

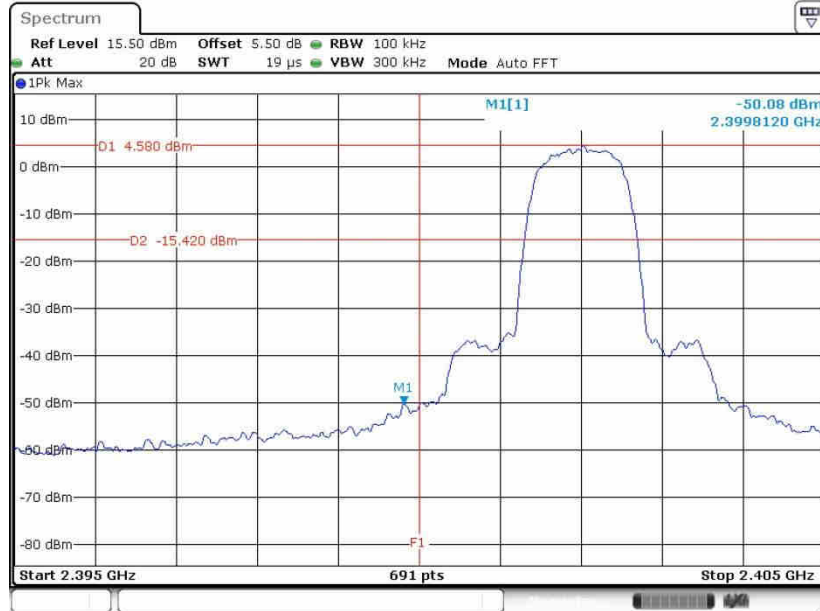

Date: 26.SEP.2020 13:19:22

High Band Edge Plot on Channel 78

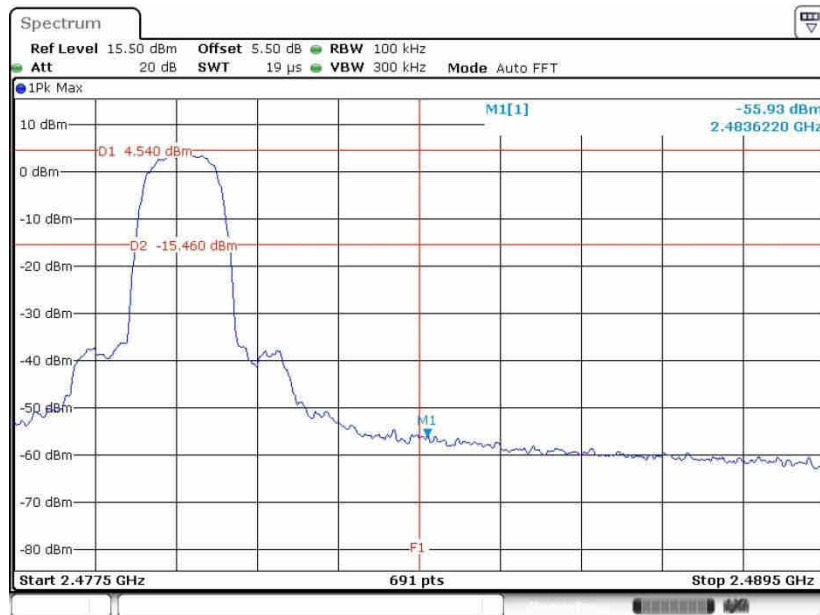

Date: 26.SEP.2020 13:32:54



<3Mbps>

Low Band Edge Plot on Channel 00

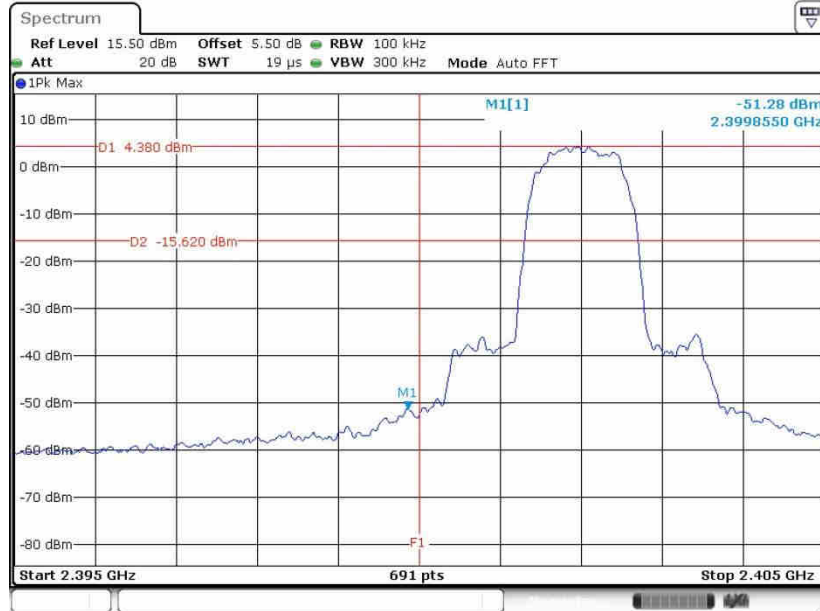

Date: 26.SEP.2020 13:52:06

High Band Edge Plot on Channel 78

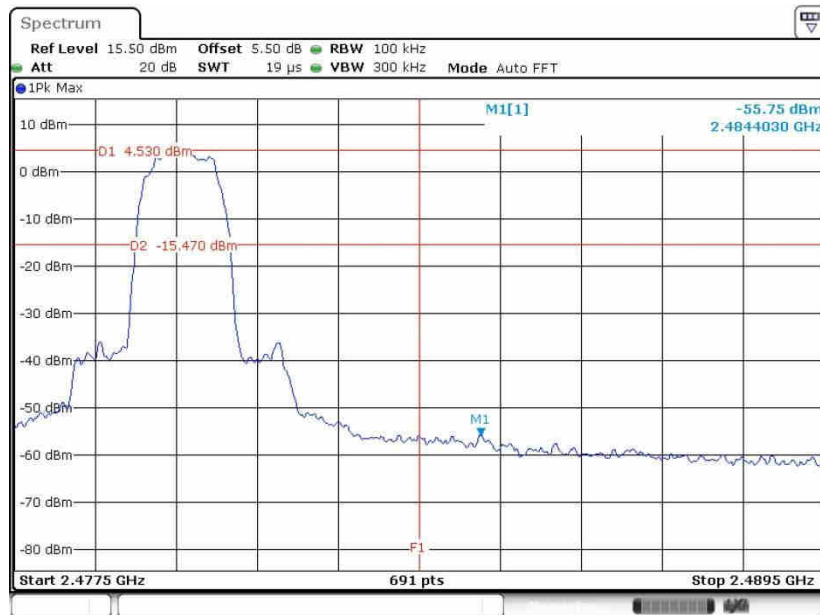

Date: 26.SEP.2020 13:38:35



### 3.6.6 Test Result of Conducted Hopping Mode Band Edges

<1Mbps>

#### Hopping Mode Low Band Edge Plot



Date: 26 SEP.2020 13:06:12

#### Hopping Mode High Band Edge Plot

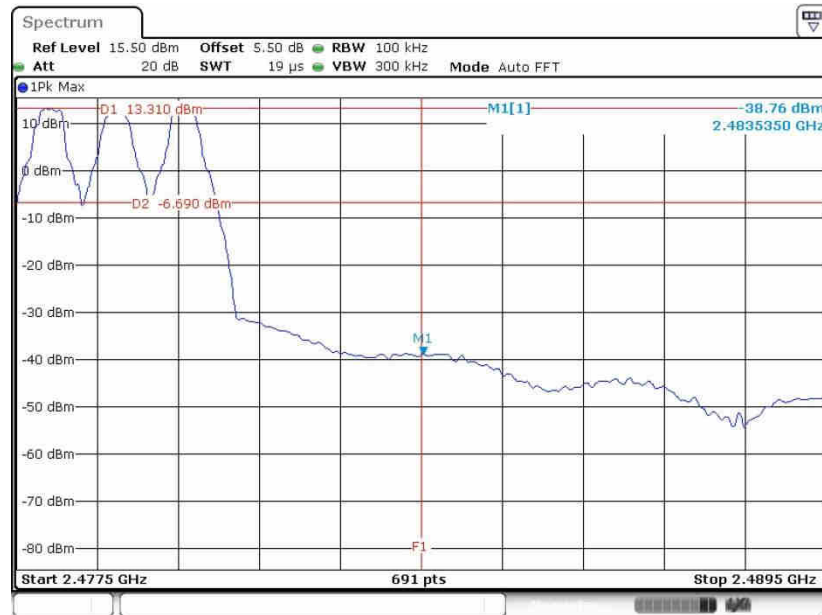

Date: 26 SEP.2020 13:05:30



<2Mbps>

Hopping Mode Low Band Edge Plot

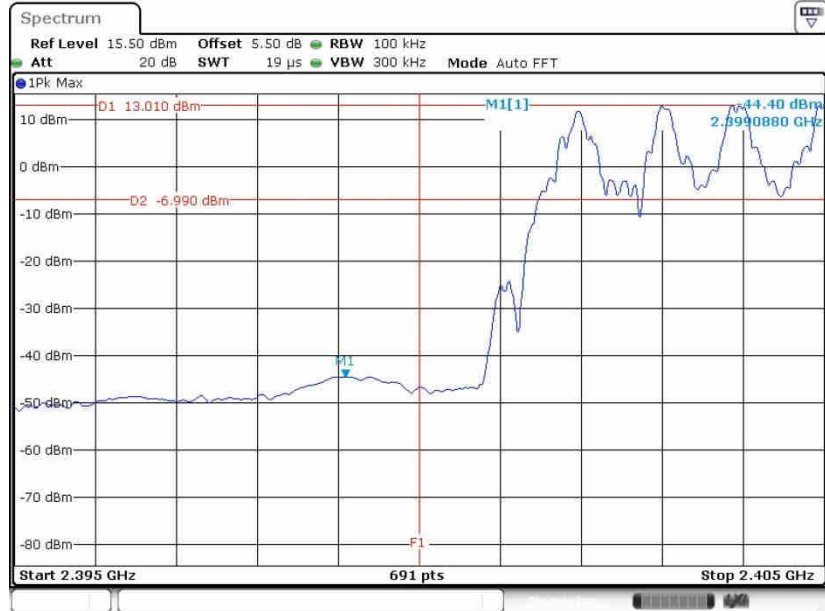

Date: 26.SEP.2020 13:07:39

Hopping Mode High Band Edge Plot

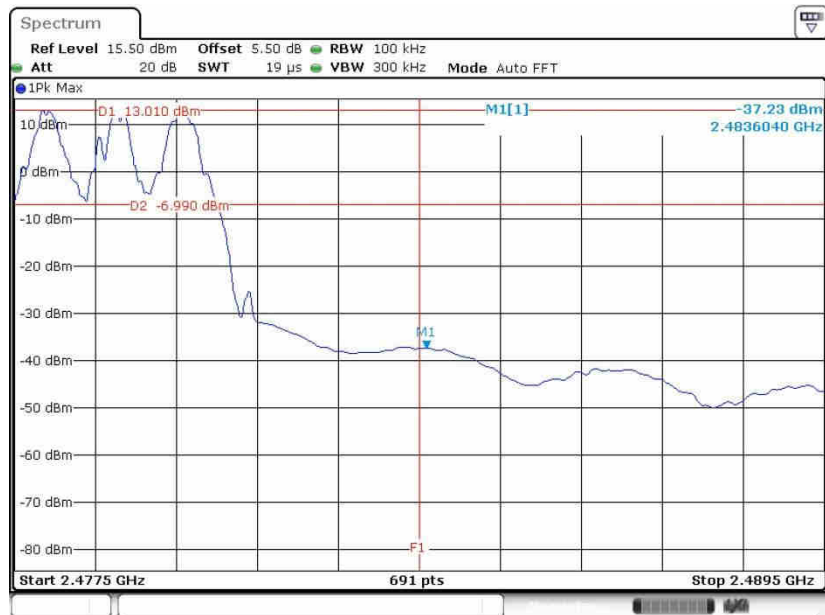

Date: 26.SEP.2020 13:08:02



<3Mbps>

Hopping Mode Low Band Edge Plot

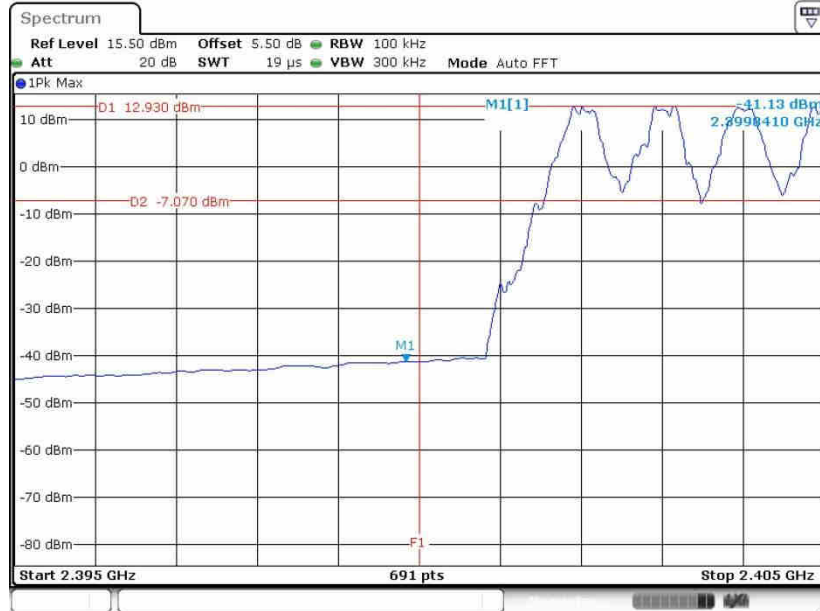

Date: 26.SEP.2020 13:09:22

Hopping Mode High Band Edge Plot



Date: 26.SEP.2020 13:08:50

## 3.7 Conducted Spurious Emission Measurement

### 3.7.1 Limit of Spurious Emission Measurement

In any 100 kHz bandwidth outside the intentional radiation frequency band, the radio frequency power shall be at least 20 dB below the highest level of the radiated power. In addition, radiated emissions which fall in the restricted bands must also comply with the radiated emission limits.

### 3.7.2 Measuring Instruments

The measuring equipment is listed in the section 4 of this test report.

### 3.7.3 Test Procedure

1. The testing follows ANSI C63.10-2013 clause 7.8.8.
2. The RF output of EUT was connected to the spectrum analyzer by RF cable and attenuator. The path loss was compensated to the results for each measurement.
3. Set to the maximum power setting and enable the EUT transmit continuously.
4. Set RBW = 100 kHz, VBW = 300kHz, scan up through 10th harmonic. All harmonics / spurs must be at least 20 dB down from the highest emission level within the authorized band as measured with a 100 kHz RBW.
5. Measure and record the results in the test report.
6. The RF fundamental frequency should be excluded against the limit line in the operating frequency band.

### 3.7.4 Test Setup

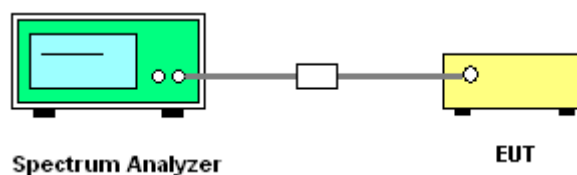





### 3.7.5 Test Result of Conducted Spurious Emission

<1Mbps>

CSE Plot on Ch 00 between 30MHz ~ 3 GHz

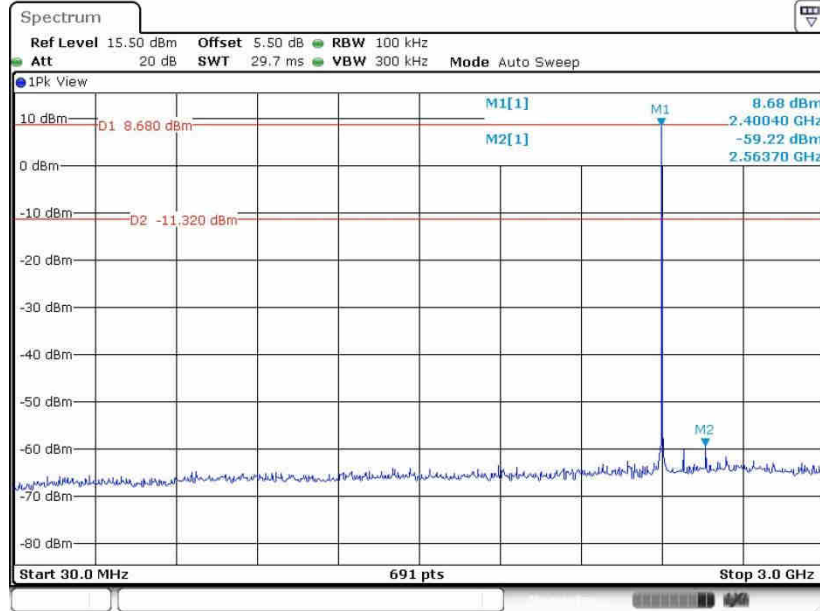

Date: 26.SEP.2020 06:22:22

1Mbps CSE Plot on Ch 00 between 2 GHz ~ 25 GHz

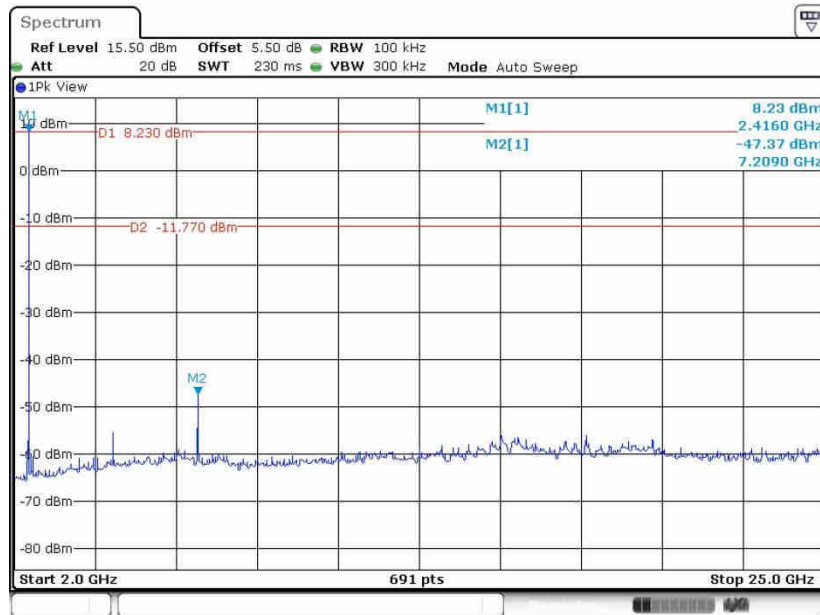

Date: 26.SEP.2020 06:22:53



CSE Plot on Ch 39 between 30MHz ~ 3 GHz

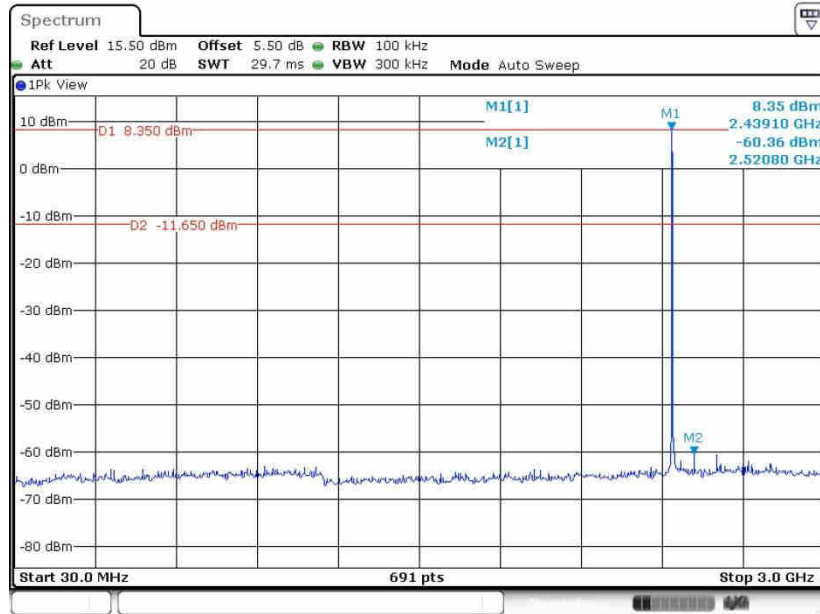

Date: 26.SEP.2020 12:54:36

CSE Plot on Ch 39 between 2 GHz ~ 25 GHz

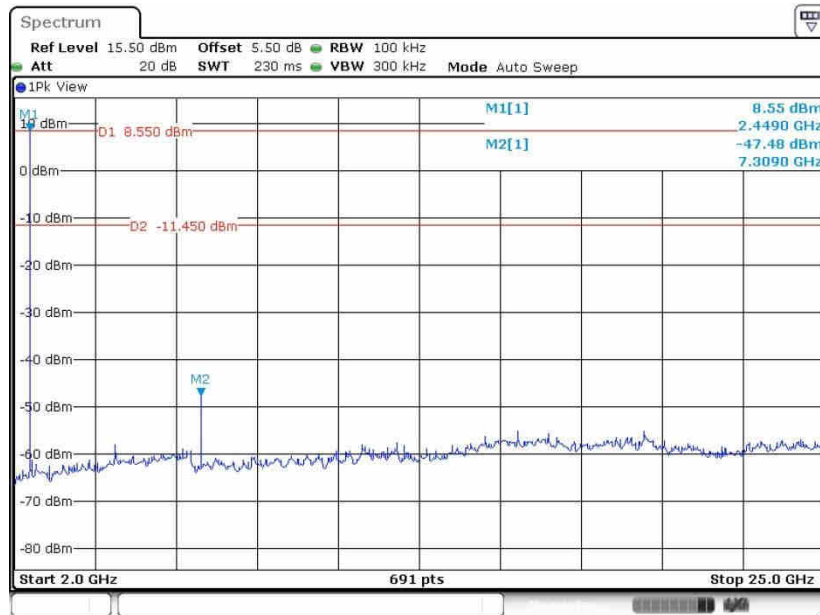

Date: 26.SEP.2020 12:57:21



CSE Plot on Ch 78 between 30MHz ~ 3 GHz

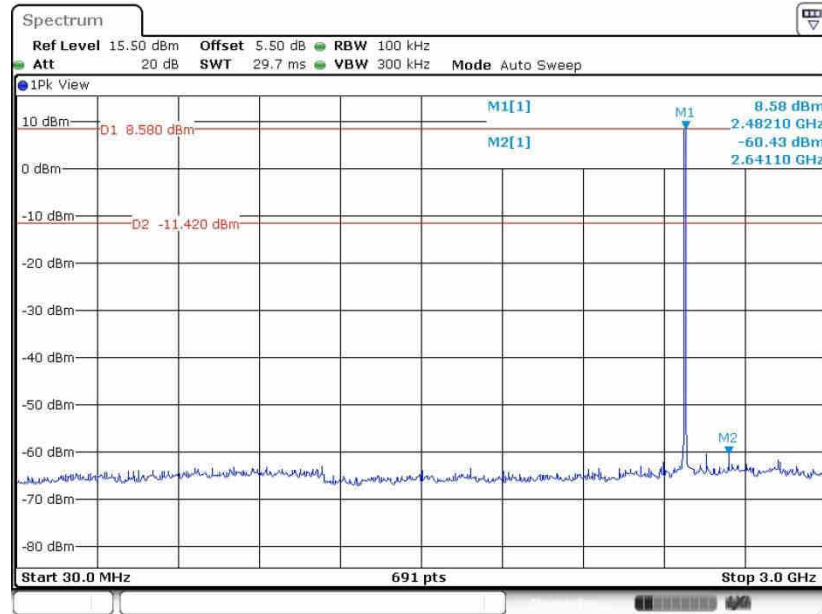

Date: 26.SEP.2020 13:04:22

CSE Plot on Ch 78 between 2 GHz ~ 25 GHz

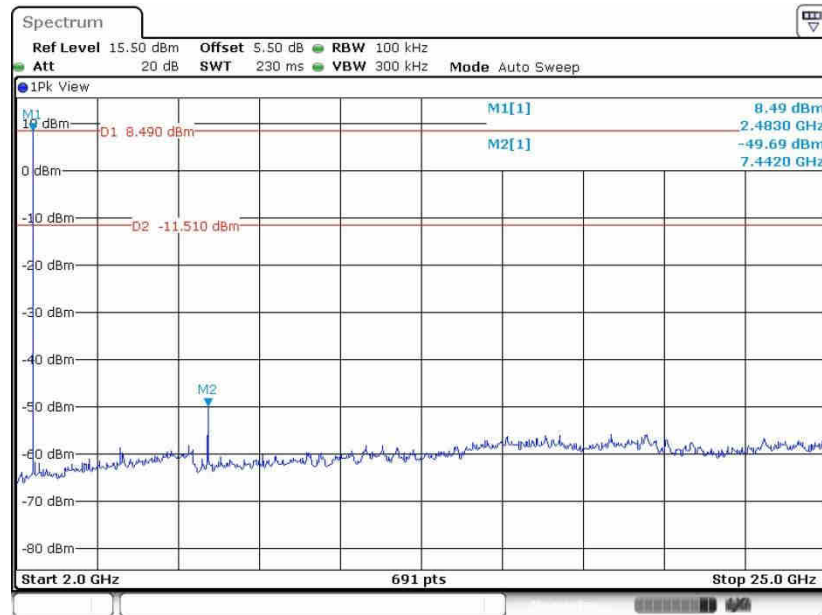

Date: 26.SEP.2020 13:04:50



<2Mbps>

CSE Plot on Ch 00 between 30MHz ~ 3 GHz

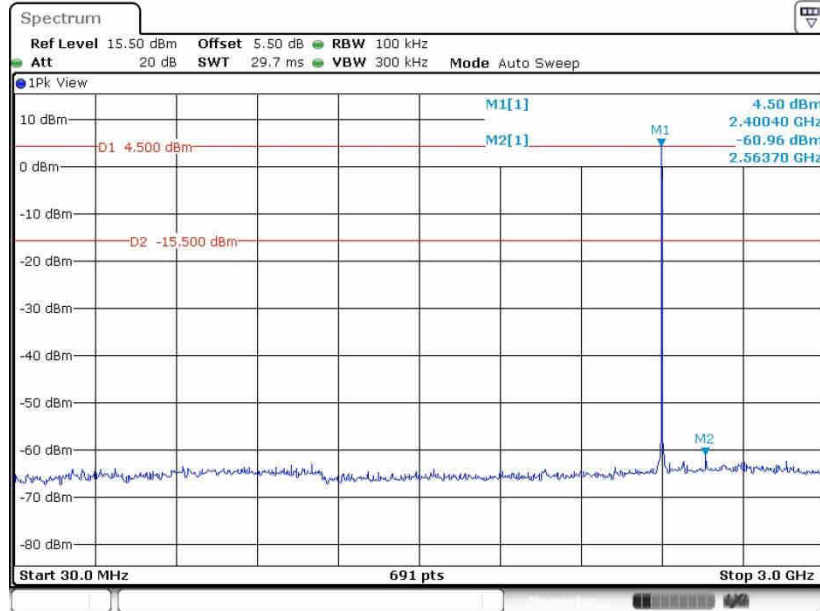

Date: 26.SEP.2020 13:21:34

CSE Plot on Ch 00 between 2 GHz ~ 25 GHz

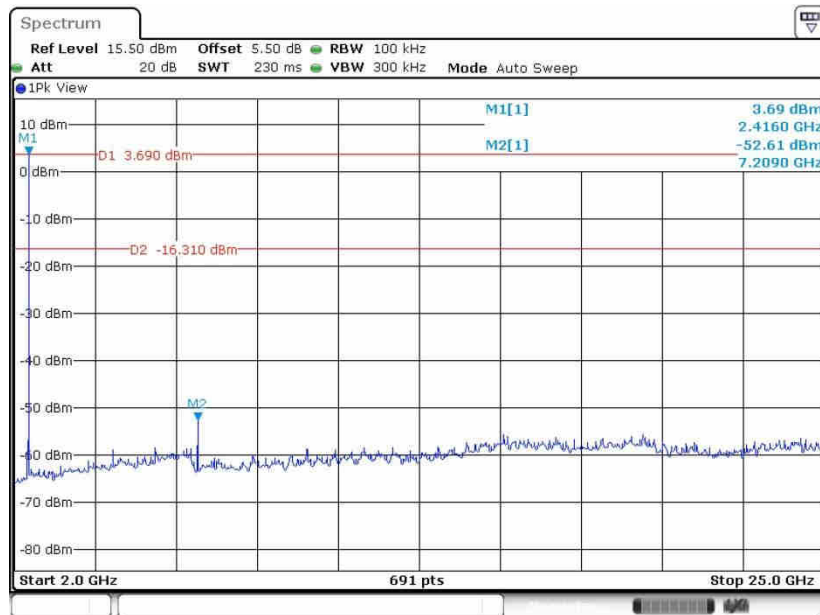

Date: 26.SEP.2020 13:22:10



CSE Plot on Ch 39 between 30MHz ~ 3 GHz

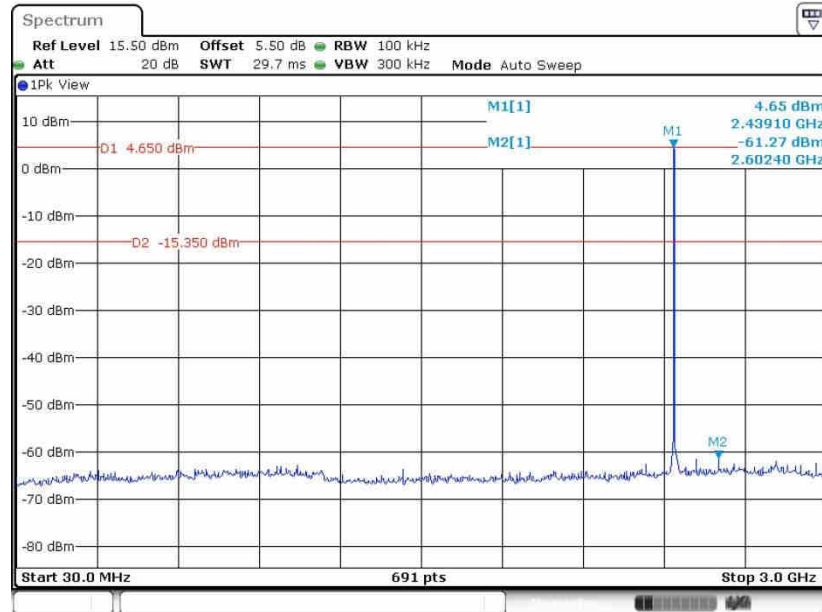

Date: 26.SEP.2020 13:26:52

CSE Plot on Ch 39 between 2 GHz ~ 25 GHz

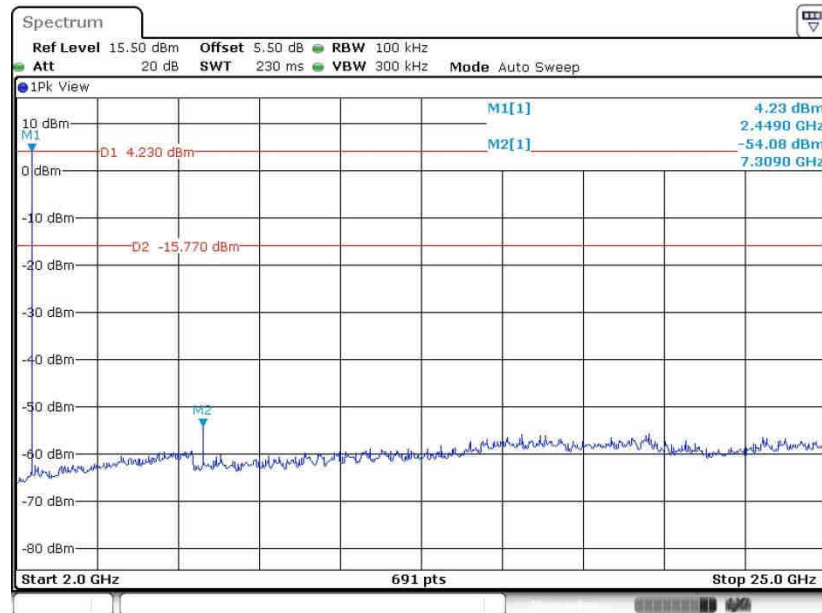

Date: 26.SEP.2020 13:27:27



CSE Plot on Ch 78 between 30MHz ~ 3 GHz

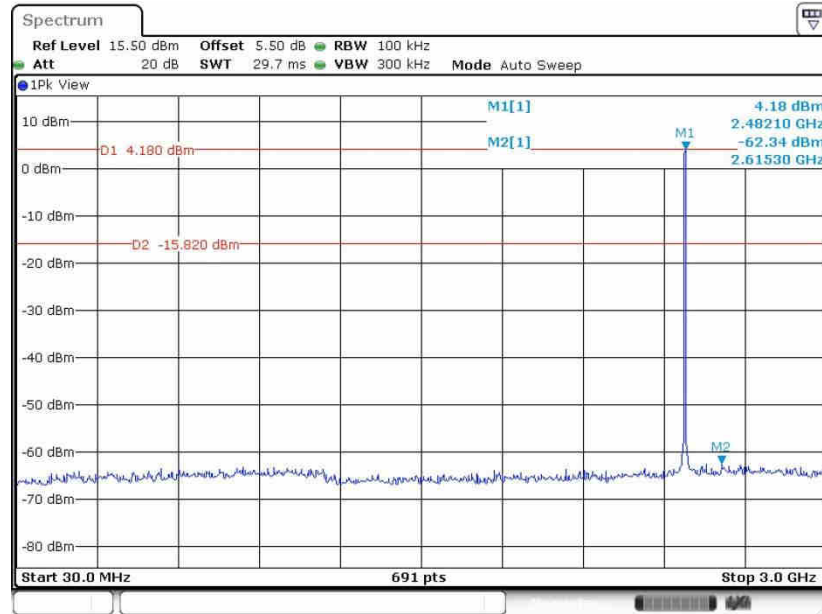

Date: 26.SEP.2020 13:34:12

CSE Plot on Ch 78 between 2 GHz ~ 25 GHz

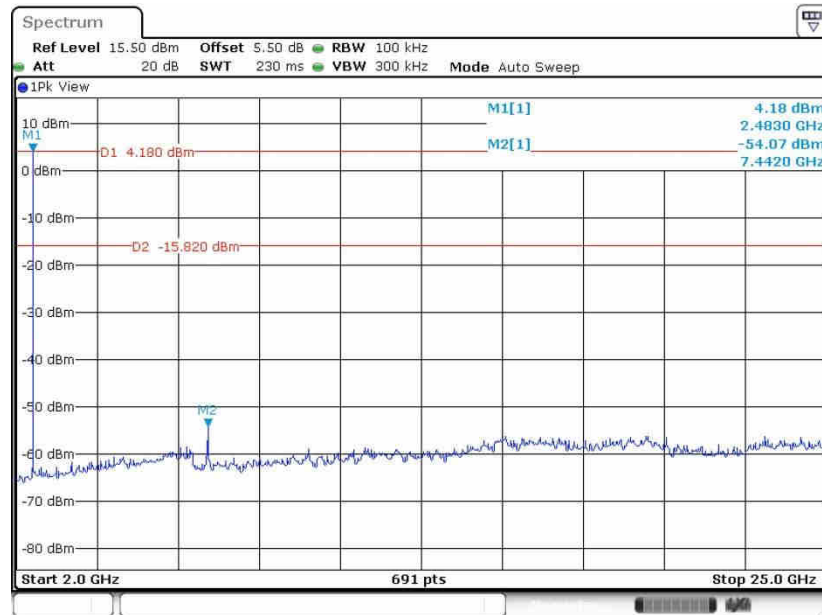

Date: 26.SEP.2020 13:34:43



<3Mbps>

CSE Plot on Ch 00 between 30MHz ~ 3 GHz

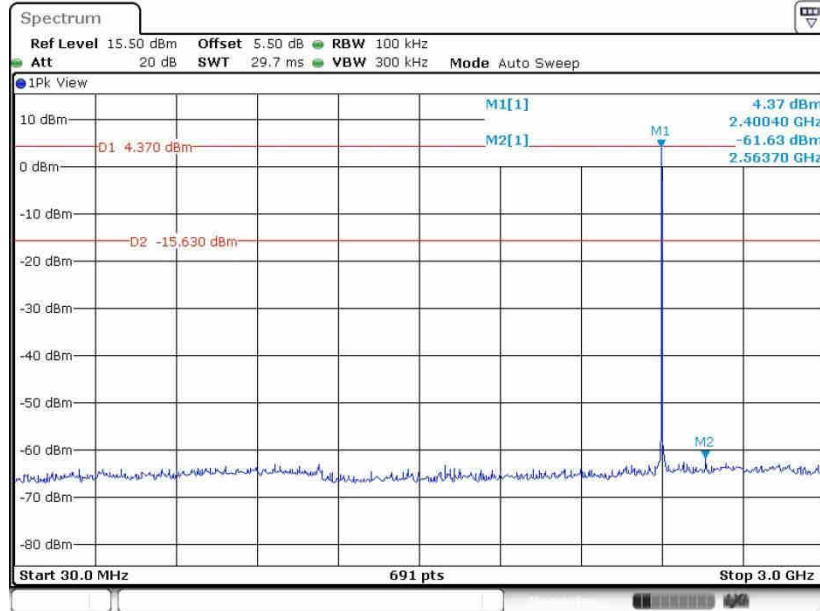

Date: 26.SEP.2020 13:53:13

CSE Plot on Ch 00 between 2 GHz ~ 25 GHz

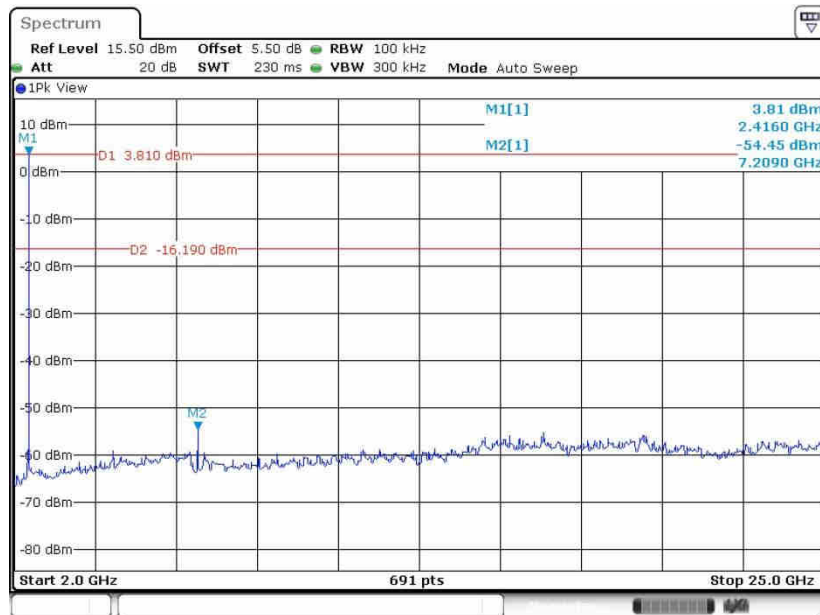

Date: 26.SEP.2020 13:53:50



CSE Plot on Ch 39 between 30MHz ~ 3 GHz

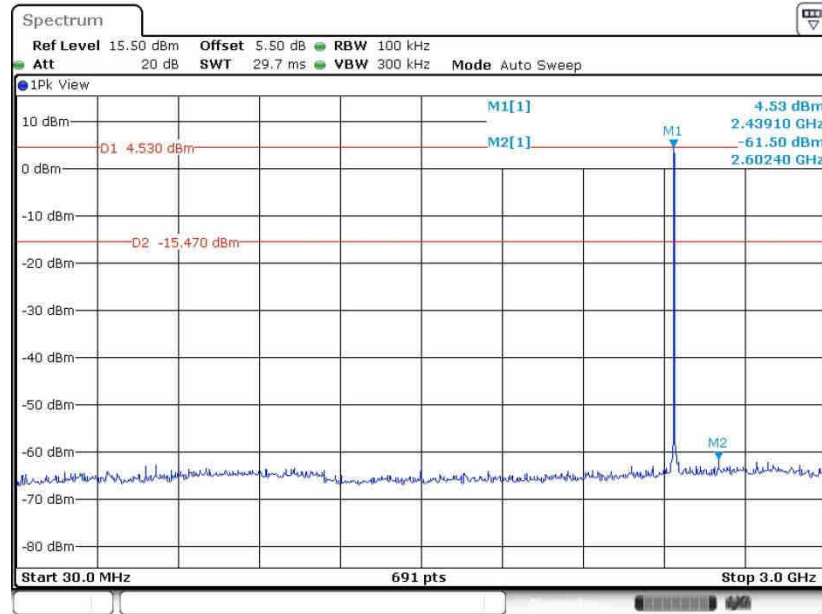

Date: 26.SEP.2020 13:47:36

CSE Plot on Ch 39 between 2 GHz ~ 25 GHz

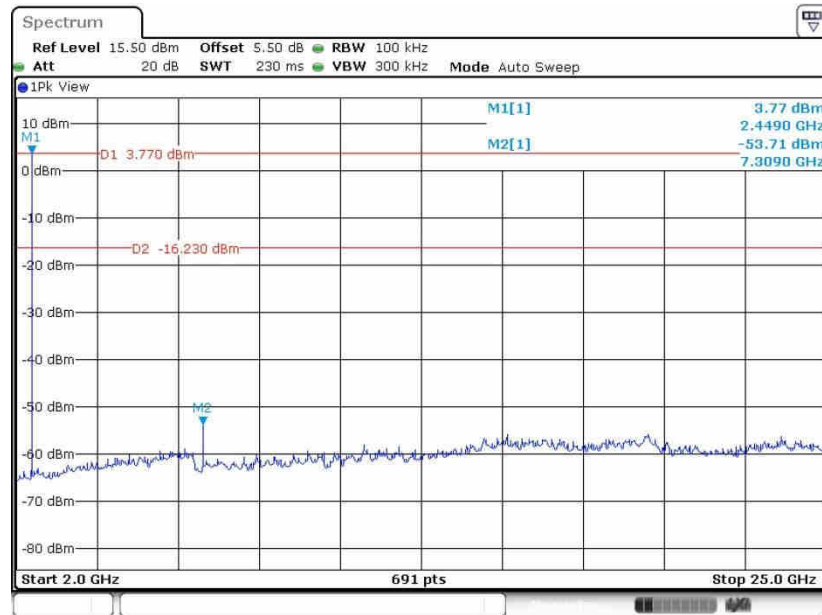

Date: 26.SEP.2020 13:48:05





CSE Plot on Ch 78 between 30MHz ~ 3 GHz

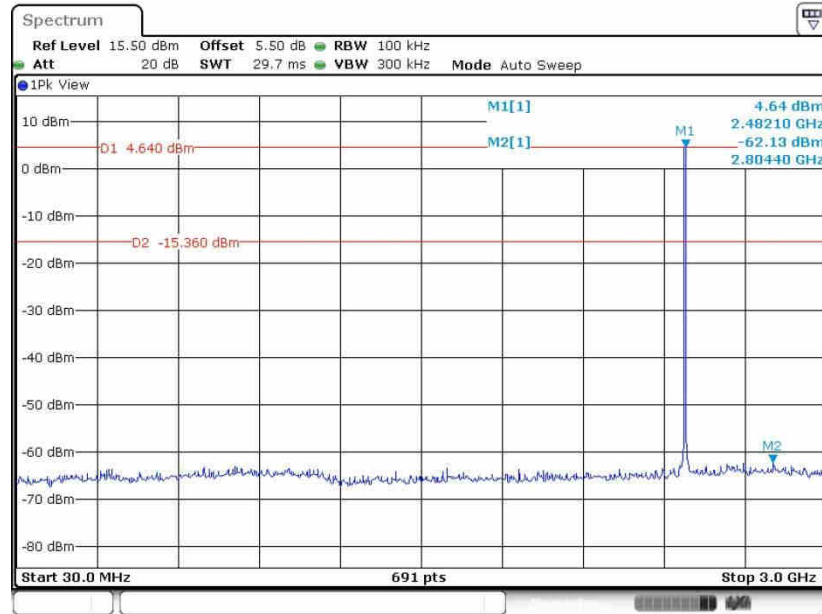

Date: 26.SEP.2020 13:40:04

CSE Plot on Ch 78 between 2 GHz ~ 25 GHz

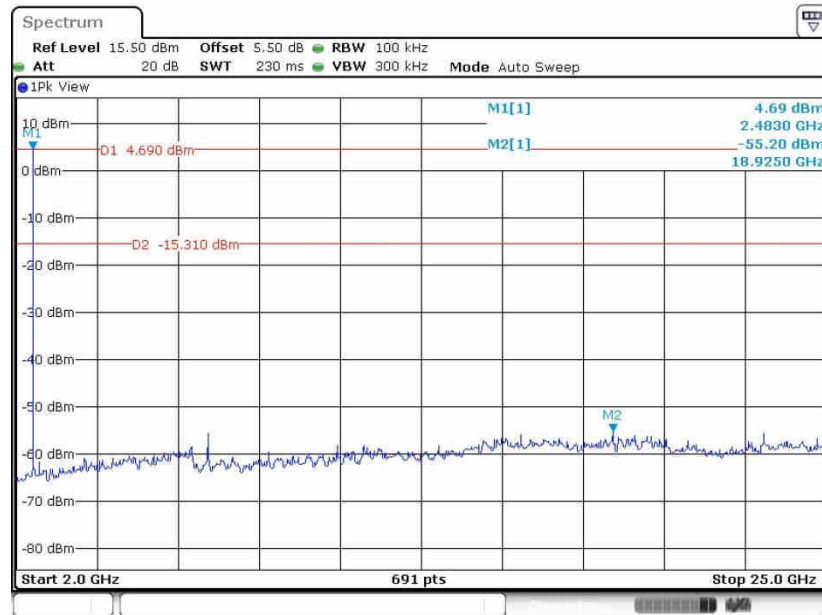

Date: 26.SEP.2020 13:40:34



### 3.8 Radiated Band Edges and Spurious Emission Measurement

#### 3.8.1 Limit of Radiated Band Edges and Spurious Emission

In any 100 kHz bandwidth outside the intentional radiator frequency band, all harmonics/spurious must be at least 20 dB below the highest emission level within the authorized band. In addition, radiated emissions which fall in the restricted bands must also comply with the limits as below.

Frequency (MHz)	Field Strength (microvolts/meter)	Measurement Distance (meters)
0.009 – 0.490	2400/F(kHz)	300
0.490 – 1.705	24000/F(kHz)	30
1.705 – 30.0	30	30
30 – 88	100	3
88 – 216	150	3
216 - 960	200	3
Above 960	500	3

#### 3.8.2 Measuring Instruments

The measuring equipment is listed in the section 4 of this test report.



### 3.8.3 Test Procedures

1. The EUT was placed on a turntable with 0.8 meter for frequency below 1GHz and 1.5 meter for frequency above 1GHz respectively above ground.
2. The EUT was set 3 meters from the interference receiving antenna, which was mounted on the top of a variable height antenna tower.
3. For each suspected emission, the EUT was arranged to its worst case and then tune the Antenna tower (from 1 m to 4 m) and turntable (from 0 degree to 360 degrees) to find the maximum reading. A pre-amp and a high pass filter are used for the test in order to get better signal level to comply with the guidelines.
4. Set to the maximum power setting and enable the EUT transmit continuously.
5. Use the following spectrum analyzer settings:
  - (1) Span shall wide enough to fully capture the emission being measured;
  - (2) Set RBW=100 kHz for  $f < 1 \text{ GHz}$ , RBW=1MHz for  $f > 1\text{GHz}$  ; VBW  $\geq$  RBW; Sweep = auto; Detector function = peak; Trace = max hold for peak
  - (3) For average measurement: use duty cycle correction factor method per 15.35(c).  
Duty cycle = On time/100 milliseconds  
On time =  $N_1 * L_1 + N_2 * L_2 + \dots + N_{n-1} * L_{n-1} + N_n * L_n$   
Where  $N_1$  is number of type 1 pulses,  $L_1$  is length of type 1 pulses, etc.  
Average Emission Level = Peak Emission Level +  $20 * \log(\text{Duty cycle})$
6. Corrected Reading: Antenna Factor + Cable Loss + Read Level - Preamp Factor = Level
7. For testing below 1GHz, if the emission level of the EUT in peak mode was 3 dB lower than the limit specified, then peak values of EUT will be reported, otherwise, the emissions will be repeated one by one using the CISPR quasi-peak method and reported.
8. For testing above 1GHz, the emission level of the EUT in peak mode was 20dB lower than peak limit (that means the emission level in average mode also complies with the limit in average mode), then peak values of EUT will be reported, otherwise, the emissions will be measured in average mode again and reported.

Note: The average levels were calculated from the peak level corrected with duty cycle correction factor (-25.00dB) derived from  $20 \log(\text{dwell time}/100\text{ms})$ . This correction is only for signals that hop with the fundamental signal, such as band-edge and harmonic. Other spurious signals that are independent of the hopping signal would not use this correction.

### 3.8.4 Test Setup

For radiated emissions below 30MHz

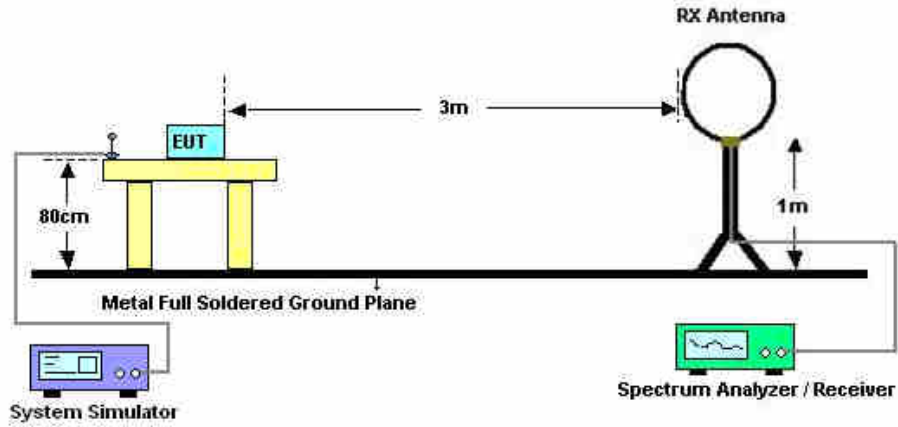

For radiated emissions from 30MHz to 1GHz

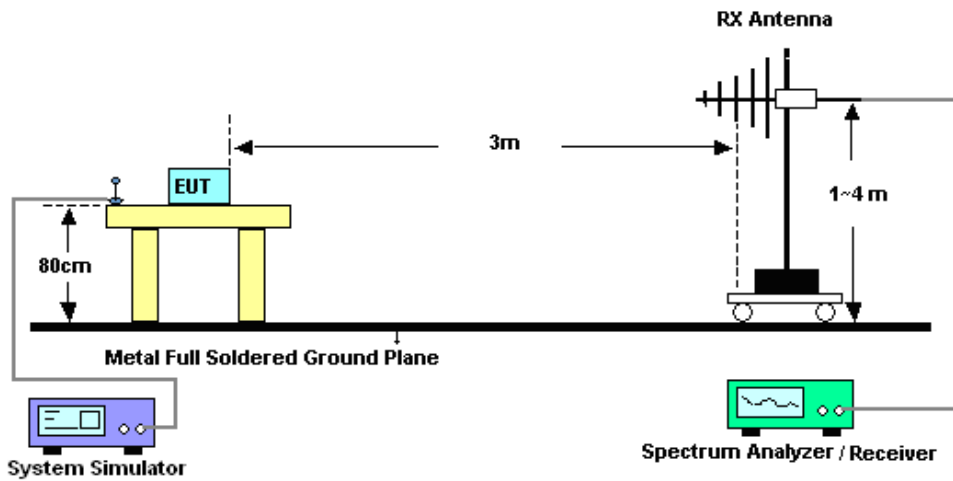

For radiated emissions above 1GHz

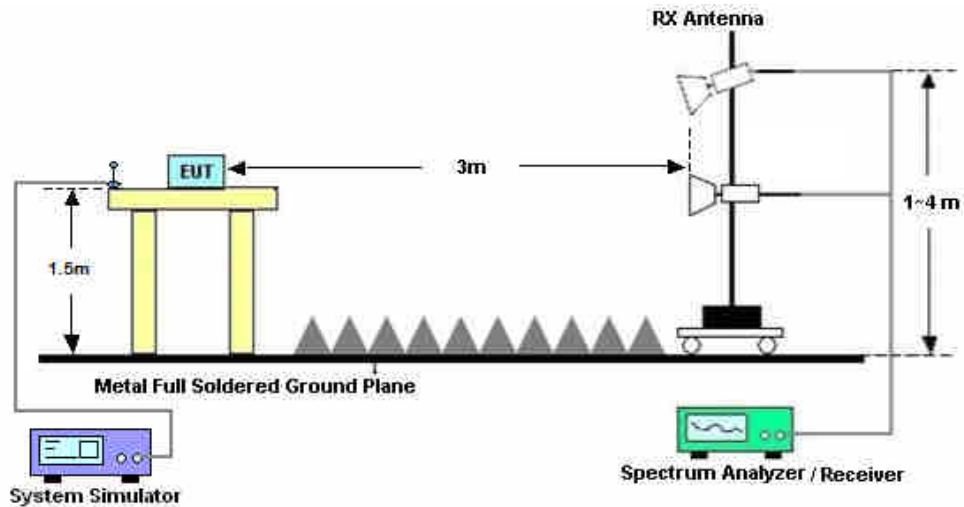



### **3.8.5 Test Results of Radiated Spurious Emissions (9 kHz ~ 30 MHz)**

The low frequency, which started from 9 kHz to 30MHz, was pre-scanned and the result which was 20dB lower than the limit line was not reported.

There is a comparison data of both open-field test site and semi-Anechoic chamber, and the result came out very similar.

### **3.8.6 Test Result of Radiated Spurious at Band Edges**

Please refer to Appendix C.

### **3.8.7 Test Result of Radiated Spurious Emission (30MHz ~ 10th Harmonic or 40GHz, whichever is lower)**

Please refer to Appendix C.

### **3.8.8 Duty cycle correction factor for average measurement**

Please refer to Appendix D.

### 3.9 AC Conducted Emission Measurement

#### 3.9.1 Limit of AC Conducted Emission

For equipment that is designed to be connected to the public utility (AC) power line, the radio frequency voltage that is conducted back onto the AC power line on any frequency or frequencies within the band 150 kHz to 30 MHz shall not exceed the limits in the following table.

Frequency of emission (MHz)	Conducted limit (dB $\mu$ V)	
	Quasi-peak	Average
0.15-0.5	66 to 56*	56 to 46*
0.5-5	56	46
5-30	60	50

\*Decreases with the logarithm of the frequency.

#### 3.9.2 Measuring Instruments

The measuring equipment is listed in the section 4 of this test report.

#### 3.9.3 Test Procedures

1. The EUT was placed 0.4 meter from the conducting wall of the shielding room was kept at least 80 centimeters from any other grounded conducting surface.
2. Connect EUT to the power mains through a line impedance stabilization network (LISN).
3. All the support units are connecting to the other LISN.
4. The LISN provides 50 ohm coupling impedance for the measuring instrument.
5. The FCC states that a 50 ohm, 50 microhenry LISN should be used.
6. Both sides of AC line were checked for maximum conducted interference.
7. The frequency range from 150 kHz to 30 MHz was searched.
8. Set the test-receiver system to Peak Detect Function and specified bandwidth (IF Bandwidth = 9kHz) with Maximum Hold Mode. Then measurement is also conducted by Average Detector and Quasi-Peak Detector Function respectively.

### 3.9.4 Test Setup

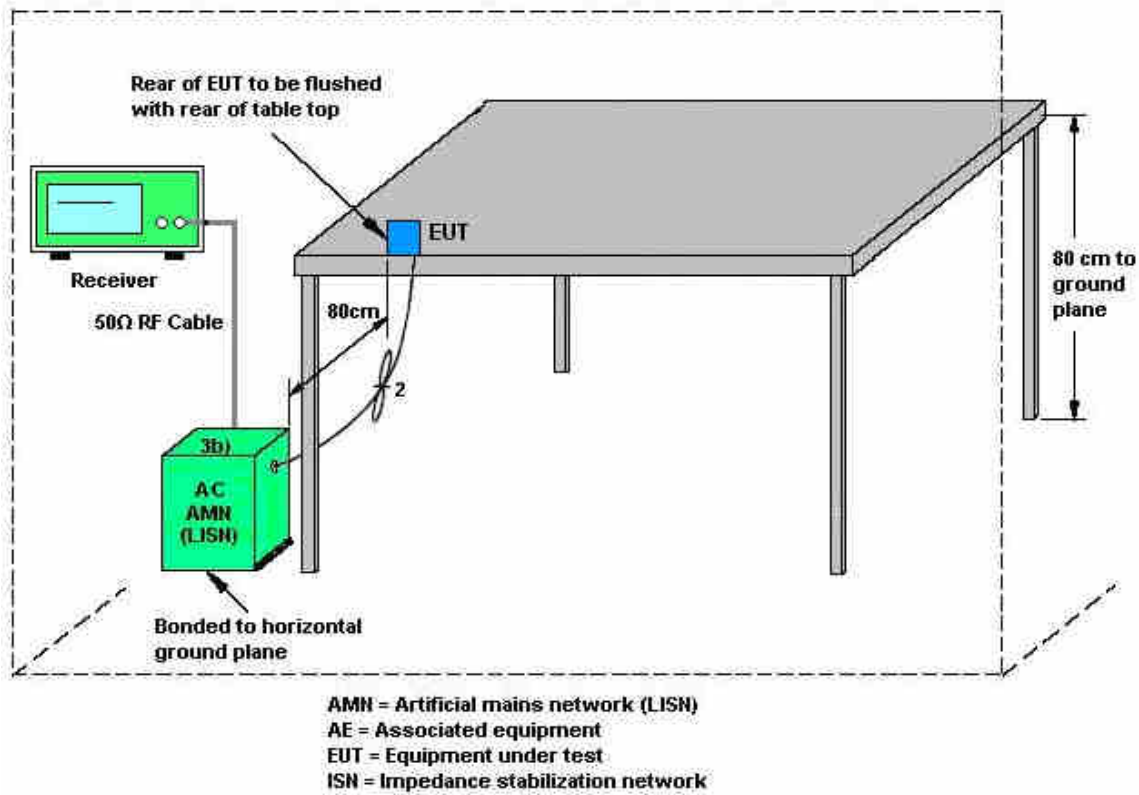

### 3.9.5 Test Result of AC Conducted Emission

Please refer to Appendix B.



## **3.10 Antenna Requirements**

### **3.10.1 Standard Applicable**

If directional gain of transmitting antennas is greater than 6dBi, the power shall be reduced by the same level in dB comparing to gain minus 6dBi. The use of a permanently attached antenna or of an antenna that uses a unique coupling to the intentional radiator shall be considered sufficient to comply with the rule.

### **3.10.2 Antenna Anti-Replacement Construction**

An embedded-in antenna design is used.

### **3.10.3 Antenna Gain**

The antenna peak gain of EUT is less than 6 dBi. Therefore, it is not necessary to reduce maximum peak output power limit.





## 4 List of Measuring Equipment

Instrument	Manufacturer	Model No.	Serial No.	Characteristics	Calibration Date	Test Date	Due Date	Remark
Spectrum Analyzer	R&S	FSV40	101040	10Hz~40GHz	Nov. 02, 2019	Sep. 26, 2020~ Oct. 29, 2020	Nov. 01, 2020	Conducted (TH01-KS)
Pulse Power Sensor	Anritsu	MA2411B	0917070	300MHz~40GHz	Jan. 15, 2020	Sep. 26, 2020~ Oct. 29, 2020	Jan. 14, 2021	Conducted (TH01-KS)
Power Meter	Anritsu	ML2495A	1005002	50MHz Bandwidth	Jan. 08, 2020	Sep. 26, 2020~ Oct. 29, 2020	Jan. 07, 2021	Conducted (TH01-KS)
EMI Test Receiver	Keysight	N9038A	MY564000 04	3Hz~8.5GHz;Max 30dBm	Oct. 18, 2019	Sep. 28, 2020	Oct. 17, 2020	Radiation (03CH06-KS)
EXA Spectrum Analyzer	Keysight	N9010A	MY551502 08	10Hz-44GHz	Apr. 14, 2020	Sep. 28, 2020	Apr. 13, 2021	Radiation (03CH06-KS)
Loop Antenna	R&S	HFH2-Z2	100321	9kHz~30MHz	Nov. 10, 2019	Sep. 28, 2020	Nov. 09, 2020	Radiation (03CH06-KS)
Bilog Antenna	TeseQ	CBL6111D	49921	30MHz-1GHz	May 29, 2020	Sep. 28, 2020	May 28, 2021	Radiation (03CH06-KS)
Double Ridge Horn Antenna	ETS-Lindgren	3117	00218652	1GHz~18GHz	Apr. 27, 2020	Sep. 28, 2020	Apr. 26, 2021	Radiation (03CH06-KS)
SHF-EHF Horn	Com-power	AH-840	101115	18GHz~40GHz	Nov. 10, 2019	Sep. 28, 2020	Nov. 09, 2020	Radiation (03CH06-KS)
Amplifier	SONOMA	310N	187289	9KHz ~1GHZ	Apr. 14, 2020	Sep. 28, 2020	Apr. 13, 2021	Radiation (03CH06-KS)
Amplifier	MITEQ	EM18G40GG A	060728	18~40GHz	Jan. 08, 2020	Sep. 28, 2020	Jan. 07, 2021	Radiation (03CH06-KS)
high gain Amplifier	MITEQ	AMF-7D-0010 1800-30-10P	2025788	1Ghz-18Ghz	Jan. 02, 2020	Sep. 28, 2020	Jan. 01, 2021	Radiation (03CH06-KS)
Amplifier	Keysight	83017A	MY532702 03	500MHz~26.5GHz	Apr. 15, 2020	Sep. 28, 2020	Apr. 14, 2021	Radiation (03CH06-KS)
AC Power Source	Chroma	61601	F1040900 04	N/A	NCR	Sep. 28, 2020	NCR	Radiation (03CH06-KS)
Turn Table	ChamPro	EM 1000-T	060762-T	0~360 degree	NCR	Sep. 28, 2020	NCR	Radiation (03CH06-KS)
Antenna Mast	ChamPro	EM 1000-A	060762-A	1 m~4 m	NCR	Sep. 28, 2020	NCR	Radiation (03CH06-KS)
EMI Receiver	R&S	ESCI7	100768	9kHz~7GHz;	Apr. 14, 2020	Nov. 02, 2020	Apr. 13, 2021	Conduction (CO01-KS)
AC LISN (for auxiliary equipment)	MessTec	AN3016	060103	9kHz~30MHz	Oct. 17, 2020	Nov. 02, 2020	Oct. 16, 2021	Conduction (CO01-KS)
AC LISN	MessTec	AN3016	060105	9kHz~30MHz	Oct. 28, 2020	Nov. 02, 2020	Oct. 27, 2021	Conduction (CO01-KS)
AC Power Source	Chroma	61602	ABP00000 0811	AC 0V~300V, 45Hz~1000Hz	Oct. 17, 2020	Nov. 02, 2020	Oct. 16, 2021	Conduction (CO01-KS)

NCR: No Calibration Required



## 5 Uncertainty of Evaluation

The measurement uncertainties shown below were calculated in accordance with the requirements of ANSI 63.10-2013. All the measurement uncertainty value were shown with a coverage K=2 to indicate 95% level of confidence. The measurement data show herein meets or exceeds the CISPR measurement uncertainty values specified in CISPR 16-4-2 and can be compared directly to specified limit to determine compliance.

### Uncertainty of Conducted Emission Measurement (150 kHz ~ 30 MHz)

Measuring Uncertainty for a Level of Confidence of 95% (U = 2Uc(y))	2.94dB
---	--------

### Uncertainty of Radiated Emission Measurement (30 MHz ~ 1000 MHz)

Measuring Uncertainty for a Level of Confidence of 95% (U = 2Uc(y))	5.0dB
---	-------

### Uncertainty of Radiated Emission Measurement (1000 MHz ~ 18000 MHz)

Measuring Uncertainty for a Level of Confidence of 95% (U = 2Uc(y))	5.0dB
---	-------

### Uncertainty of Radiated Emission Measurement (18000 MHz ~ 40000 MHz)

Measuring Uncertainty for a Level of Confidence of 95% (U = 2Uc(y))	5.0dB
---	-------



## **Appendix A. Conducted Test Results**

**Bluetooth**

Test Engineer:	Rise liu	Temperature:	21~24	°C
Test Date:	2020/9/26~2020/10/29	Relative Humidity:	45~51	%

<b>TEST RESULTS DATA</b>									
<b>20dB and 99% Occupied Bandwidth and Hopping Channel Separation</b>									
Mod.	Data Rate	NTX	CH.	Freq. (MHz)	20db BW (MHz)	99% Bandwidth (MHz)	Hopping Channel Separation Measurement (MHz)	Hopping Channel Separation Measurement Limit (MHz)	Pass/Fail
DH	1Mbps	1	0	2402	0.958	0.915	998.550	0.6387	Pass
DH	1Mbps	1	39	2441	0.961	0.912	998.550	0.6406	Pass
DH	1Mbps	1	78	2480	0.973	0.912	1002.900	0.6483	Pass
2DH	2Mbps	1	0	2402	1.346	1.198	998.600	0.8973	Pass
2DH	2Mbps	1	39	2441	1.346	1.198	1250.400	0.8973	Pass
2DH	2Mbps	1	78	2480	1.346	1.198	998.600	0.8973	Pass
3DH	3Mbps	1	0	2402	1.337	1.204	1398.000	0.8915	Pass
3DH	3Mbps	1	39	2441	1.337	1.204	998.600	0.8915	Pass
3DH	3Mbps	1	78	2480	1.337	1.204	1398.000	0.8915	Pass

<b>TEST RESULTS DATA</b>						
<b>Dwell Time</b>						
Mod.	Hopping Channel Number Rate	Hops Over Occupancy Time(hops)	Package Transfer Time (msec)	Dwell Time (sec)	Limits (sec)	Pass/Fail
Nomal	79	106.67	2.94	0.31	0.4	Pass
AFH	20	53.33	2.94	0.16	0.4	Pass

<b>TEST RESULTS DATA</b>					
<b>Peak Power Table</b>					
DH	CH.	NTX	Peak Power (dBm)	Power Limit (dBm)	Test Result
DH1	0	1	9.35	20.97	Pass
	39	1	<b>9.61</b>	20.97	Pass
	78	1	9.54	20.97	Pass
2DH	CH.	NTX	Peak Power (dBm)	Power Limit (dBm)	Test Result
2DH1	0	1	9.19	20.97	Pass
	39	1	<b>9.46</b>	20.97	Pass
	78	1	9.34	20.97	Pass
3DH	CH.	NTX	Peak Power (dBm)	Power Limit (dBm)	Test Result
3DH1	0	1	9.68	20.97	Pass
	39	1	<b>9.93</b>	20.97	Pass
	78	1	9.81	20.97	Pass

<b>TEST RESULTS DATA</b>			
<b>Number of Hopping Frequency</b>			
Number of Hopping (Channel)	Adaptive Frequency Hopping (Channel)	Limits (Channel)	Pass/Fail
79	79	> 15	Pass



## Appendix B. AC Conducted Emission Test Results

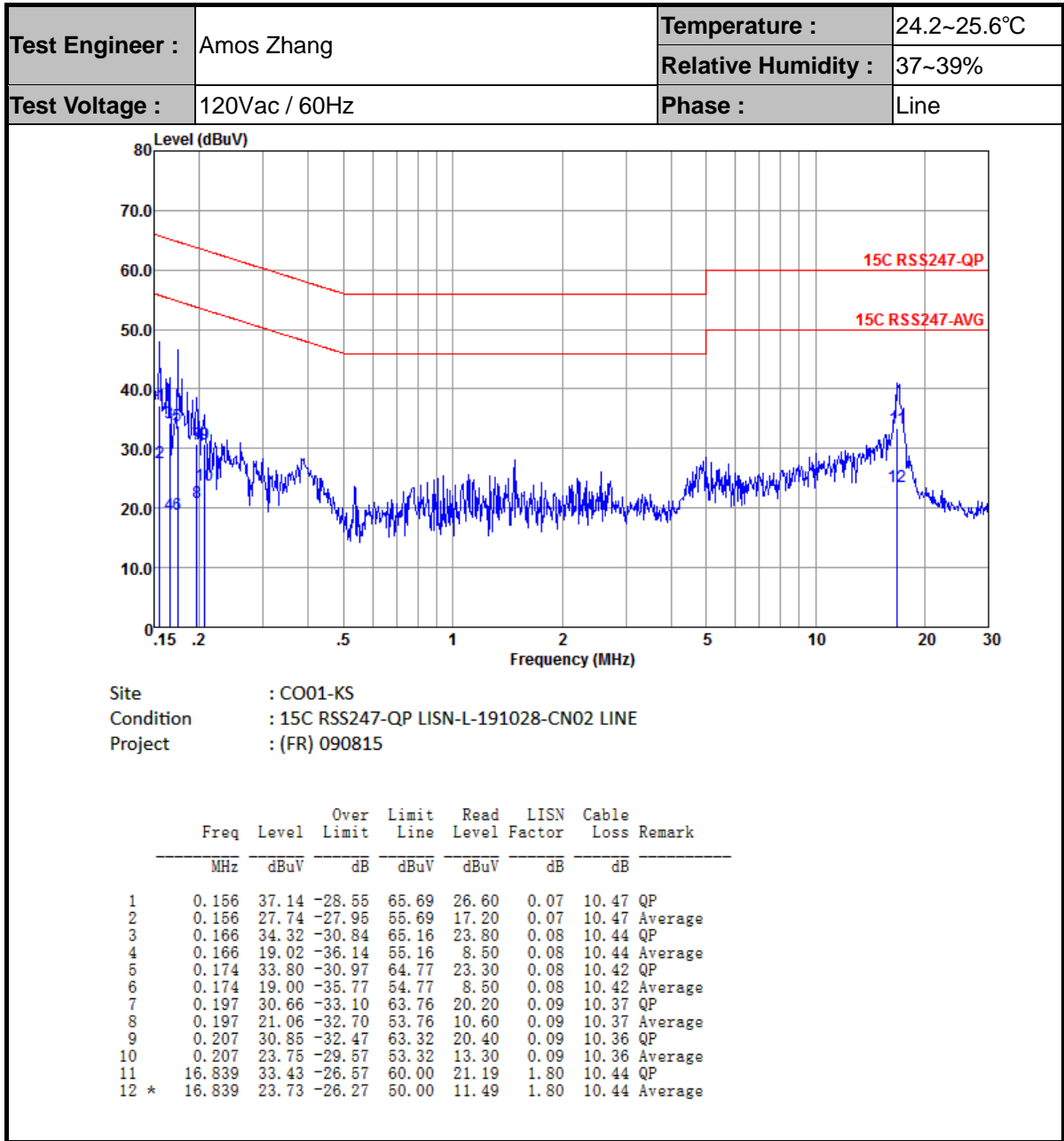



Test Engineer :	Amos Zhang	Temperature :	24.2~25.6°C
		Relative Humidity :	37~39%
Test Voltage :	120Vac / 60Hz	Phase :	Neutral

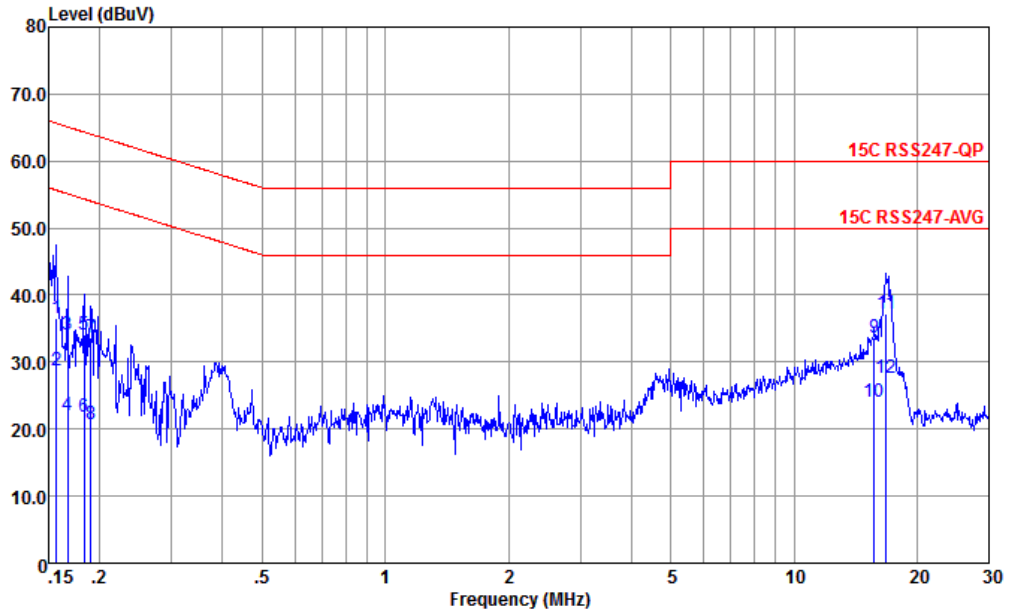

Site : CO01-KS  
 Condition : 15C RSS247-QP LISN-N-191028-CN02 NEUTRAL  
 Project : (FR) 090815

	Freq	Level	Over	Limit	Read	LISN	Cable	Remark
	MHz	dBuV	Limit	Line	Level	Factor	Loss	
			dB	dBuV	dBuV	dB	dB	
1	0.156	36.52	-29.13	65.65	25.91	0.15	10.46	QP
2	0.156	28.82	-26.83	55.65	18.21	0.15	10.46	Average
3	0.167	34.19	-30.93	65.12	23.59	0.16	10.44	QP
4	0.167	22.09	-33.03	55.12	11.49	0.16	10.44	Average
5	0.183	34.06	-30.27	64.33	23.50	0.16	10.40	QP
6	0.183	21.76	-32.57	54.33	11.20	0.16	10.40	Average
7	0.190	33.65	-30.37	64.02	23.11	0.16	10.38	QP
8	0.190	20.75	-33.27	54.02	10.21	0.16	10.38	Average
9	15.718	33.67	-26.33	60.00	21.20	2.06	10.41	QP
10	15.718	24.07	-25.93	50.00	11.60	2.06	10.41	Average
11	16.839	37.31	-22.69	60.00	24.59	2.28	10.44	QP
12 *	16.839	27.61	-22.39	50.00	14.89	2.28	10.44	Average

Note:

1. Level(dBμV) = Read Level(dBμV) + LISN Factor(dB) + Cable Loss(dB)
2. Over Limit(dB) = Level(dBμV) – Limit Line(dBμV)



### Appendix C. Radiated Spurious Emission

2.4GHz 2400~2483.5MHz

BT (Band Edge @ 3m)

BT	Note	Frequency	Level	Over	Limit	Read	Antenna	Path	Preamp	Ant	Table	Peak	Pol.
		( MHz )	( dBμV/m )	( dB )	( dBμV/m )	( dBμV )	( dB/m )	( dB )	( dB )	( cm )	( deg )	( P/A )	( H/V )
BT CH00 2402MHz		2360.7	53.97	-20.03	74	48.61	32	7.37	34.01	300	125	P	H
		2360.7	28.97	-25.03	54	-	-	-	-	-	-	A	H
	*	2402	101.01	-	-	95.36	32.2	7.43	33.98	300	125	P	H
		2402	76.01	-	-	-	-	-	-	-	-	A	H
		2362.26	53.65	-20.35	74	48.29	32	7.37	34.01	139	326	P	V
		2362.26	28.65	-25.35	54	-	-	-	-	-	-	A	V
	*	2402	97.99	-	-	92.34	32.2	7.43	33.98	139	326	P	V
		2402	72.99	-	-	-	-	-	-	-	-	A	V
BT CH 78 2480MHz		2487.94	53.78	-20.22	74	48.18	31.94	7.59	33.93	312	128	P	H
		2487.94	28.78	-25.22	54	-	-	-	-	-	-	A	H
	*	2480	98.01	-	-	92.4	31.99	7.56	33.94	312	128	P	H
		2480	73.01	-	-	-	-	-	-	-	-	A	H
		2498.98	53.93	-20.07	74	48.33	31.94	7.59	33.93	148	330	P	V
		2498.98	28.93	-25.07	54	-	-	-	-	-	-	A	V
	*	2480	97.03	-	-	91.42	31.99	7.56	33.94	148	330	P	V
		2480	72.03	-	-	-	-	-	-	-	-	A	V
Remark	1. No other spurious found. 2. All results are PASS against Peak and Average limit line.												



2.4GHz 2400~2483.5MHz

BT (Harmonic @ 3m)

BT	Note	Frequency ( MHz )	Level ( dBμV/m )	Over Limit ( dB )	Limit Line ( dBμV/m )	Read Level ( dBμV )	Antenna Factor ( dB/m )	Path Loss ( dB )	Preamp Factor ( dB )	Ant Pos ( cm )	Table Pos ( deg )	Peak Avg. ( P/A )	Pol. ( H/V )
BT CH 00 2402MHz		4806	41.49	-32.51	74	58.26	35.16	10.65	62.58	100	360	P	H
		4806	42.95	-31.05	74	59.72	35.16	10.65	62.58	100	360	P	V
BT CH 39 2441MHz		4884	42.61	-31.39	74	58.89	35.17	10.75	62.2	100	360	P	H
		7320	44.4	-29.6	74	56.32	36.87	13.35	62.14	100	360	P	H
		4884	42.92	-31.08	74	59.2	35.17	10.75	62.2	100	360	P	V
		7320	43.47	-30.53	74	55.39	36.87	13.35	62.14	100	360	P	V
BT CH 78 2480MHz		4962	40.7	-33.3	74	56.67	35.19	10.87	62.03	100	360	P	H
		7440	42.32	-31.68	74	54.09	36.89	13.45	62.11	100	360	P	H
		4962	40.84	-33.16	74	56.81	35.19	10.87	62.03	100	360	P	V
		7440	42.21	-31.79	74	53.98	36.89	13.45	62.11	100	360	P	V
Remark	1. No other spurious found. 2. All results are PASS against Peak and Average limit line.												





Emission below 1GHz

2.4GHz BT (LF)

BT	Note	Frequency	Level	Over	Limit	Read	Antenna	Path	Preamp	Ant	Table	Peak	Pol.
		( MHz )	( dBμV/m )	( dB )	( dBμV/m )	( dBμV )	( dB/m )	( dB )	( dB )	( cm )	( deg )	( P/A )	( H/V )
2.4GHz BT LF		83.35	29.34	-10.66	40	52.39	14.6	1.25	38.9	100	360	P	H
		151.25	23.74	-19.76	43.5	43.14	17.48	1.81	38.69	-	-	P	H
		181.32	25.34	-18.16	43.5	44.98	16.75	2	38.39	-	-	P	H
		275.41	33.23	-12.77	46	48.87	19.81	2.49	37.94	-	-	P	H
		359.8	26.44	-19.56	46	39.39	21.65	2.85	37.45	-	-	P	H
		452.92	24.43	-21.57	46	34.77	23.65	3.21	37.2	-	-	P	H
		47.46	36.55	-3.45	40	58.34	16.15	0.76	38.7	200	360	P	V
		80.44	33.12	-6.88	40	56.8	14	1.22	38.9	-	-	P	V
		139.61	22.57	-20.93	43.5	41.92	17.63	1.74	38.72	-	-	P	V
		191.99	22.24	-21.26	43.5	41.96	16.49	2.07	38.28	-	-	P	V
		253.1	33.07	-12.93	46	49.75	19.45	2.39	38.52	-	-	P	V
		309.36	19.89	-26.11	46	34.19	20.43	2.65	37.38	-	-	P	V
Remark	1. No other spurious found. 2. All results are PASS against limit line.												



Note symbol

*	<b>Fundamental Frequency</b> which can be ignored. However, the level of any unwanted emissions shall not exceed the level of the fundamental frequency.
!	Test result is <b>over limit</b> line.
P/A	<b>Peak</b> or <b>Average</b>
H/V	<b>Horizontal</b> or <b>Vertical</b>



A calculation example for radiated spurious emission is shown as below:

BT	Note	Frequency	Level	Over	Limit	Read	Antenna	Path	Preamp	Ant	Table	Peak	Pol.
		( MHz )	( dBμV/m )	( dB )	( dBμV/m )	( dBμV )	( dB/m )	( dB )	( dB )	( cm )	( deg )	( P/A )	( H/V )
BT CH 00 2402MHz		2390	55.45	-18.55	74	54.51	32.22	4.58	35.86	103	308	P	H
		2390	43.54	-10.46	54	42.6	32.22	4.58	35.86	103	308	A	H

1. Path Loss(dB) = Cable loss(dB) + Filter loss(dB) + Attenuator loss(dB)
2. Level(dBμV/m) =  
Antenna Factor(dB/m) + Path Loss(dB) + Read Level(dBμV) - Preamp Factor(dB)
3. Over Limit(dB) = Level(dBμV/m) – Limit Line(dBμV/m)

**For Peak Limit @ 2390MHz:**

1. Level(dBμV/m)  
= Antenna Factor(dB/m) + Path Loss(dB) + Read Level(dBμV) - Preamp Factor(dB)  
= 32.22(dB/m) + 4.58(dB) + 54.51(dBμV) – 35.86 (dB)  
= 55.45 (dBμV/m)
2. Over Limit(dB)  
= Level(dBμV/m) – Limit Line(dBμV/m)  
= 55.45(dBμV/m) – 74(dBμV/m)  
= -18.55(dB)

**For Average Limit @ 2390MHz:**

1. Level(dBμV/m)  
= Antenna Factor(dB/m) + Path Loss(dB) + Read Level(dBμV) - Preamp Factor(dB)  
= 32.22(dB/m) + 4.58(dB) + 42.6(dBμV) – 35.86 (dB)  
= 43.54 (dBμV/m)
2. Over Limit(dB)  
= Level(dBμV/m) – Limit Line(dBμV/m)  
= 43.54(dBμV/m) – 54(dBμV/m)  
= -10.46(dB)

Both peak and average measured complies with the limit line, so test result is “PASS”.

## Appendix D. Duty Cycle Plots

### 3DH5 on time (Count Pulses) Plot on Channel 00

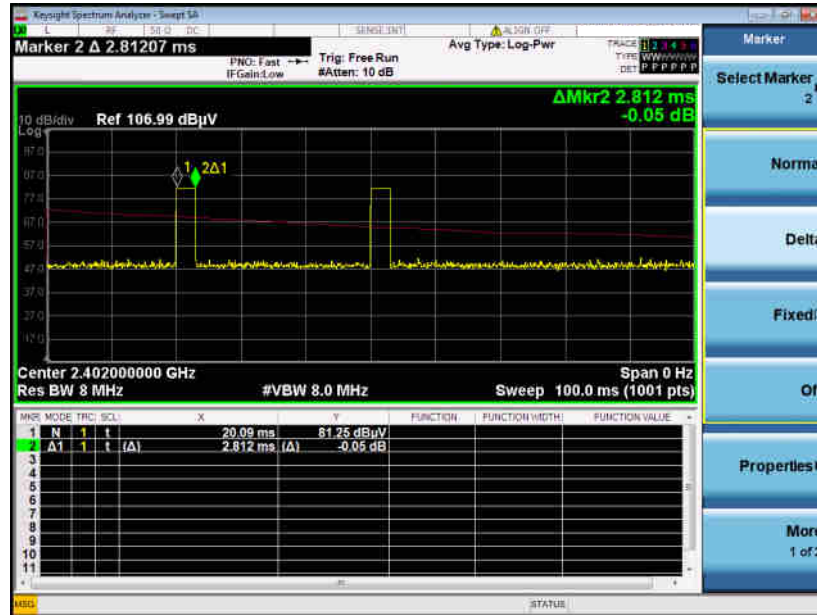

**Note:**

1. Worst case Duty cycle = on time/100 milliseconds =  $2 * 2.812 / 100 = 5.62 \%$
2. Worst case Duty cycle correction factor =  $20 * \log(\text{Duty cycle}) = -25.00 \text{ dB}$
3. 3DH5 has the highest duty cycle worst case and is reported.