



FCC RADIO TEST REPORT

Applicant : Ring LLC
Address : 1523 26th Street, Santa Monica, CA 90404 United States
Equipment : Chime Pro (2nd Generation)
Model No. : 5UM2E5
Trade Name : Ring
FCC ID : 2AEUPBHACP021

I HEREBY CERTIFY THAT :

The sample was received on Aug. 14, 2019 and the testing was completed on Oct. 25, 2019 at CerpPASS Technology Corp. The test result refers exclusively to the test presented test model / sample. Without written approval of CerpPASS Technology Corp., the test report shall not be reproduced except in full.

Approved by:

Mark Liao / Supervisor

Laboratory Accreditation:

CerpPASS Technology Corporation Test Laboratory





CONTENTS

- 1. Summary of Test Procedure and Test Results5
 - 1.1. Applicable Standards5
- 2. Test Configuration of Equipment under Test6
 - 2.1. Feature of Equipment under Test.....6
 - 2.2. Carrier Frequency of Channels7
 - 2.3. Test Mode and Test Software8
 - 2.4. Description of Test System.....9
 - 2.5. General Information of Test.....9
 - 2.6. Measurement Uncertainty10
- 3. Test Equipment and Ancillaries Used for Tests11
- 4. Antenna Requirements.....12
 - 4.1. Standard Applicable12
 - 4.2. Antenna Construction and Directional Gain.....12
- 5. Test of AC Power Line Conducted Emission13
 - 5.1. Test Limit13
 - 5.2. Test Procedures13
 - 5.3. Typical Test Setup14
 - 5.4. Test Result and Data15
 - 5.5. Test Photographs19
- 6. Test of Spurious Emission (Radiated)20
 - 6.1. Test Limit20
 - 6.2. Test Procedures20
 - 6.3. Typical Test Setup21
 - 6.4. Test Result and Data (9kHz ~ 30MHz).....22
 - 6.5. Test Result and Data (30MHz ~ 1GHz).....22
 - 6.6. Test Result and Data (1GHz ~ 40GHz).....26
 - 6.7. Restricted Bands of Operation86
 - 6.8. Test Photographs (30MHz ~ 1GHz)87
 - 6.9. Test Photographs (1GHz ~ 40GHz)88
- 7. On Time, Duty Cycle and Measurement methods89
 - 7.1. Test Limit89
 - 7.2. Test Procedure89
 - 7.3. Test Setup Layout89
 - 7.4. Test Result and Data89
 - 7.5. Measurement Methods89
- 8. 6dB Bandwidth & 99% Occupied Bandwidth92
 - 8.1. Test Limit92
 - 8.2. Test Procedure92
 - 8.3. Test Setup Layout92
 - 8.4. Test Result and Data (6dB Bandwidth)93
 - 8.5. Test Result and Data (99% Occupied Bandwidth)94
- 9. 26dB Bandwidth & 99% Occupied Bandwidth111
 - 9.1. Test Limit111
 - 9.2. Test Procedure111



- 9.3. Test Setup Layout 111
- 9.4. Test Result and Data (26dB Bandwidth) 112
- 9.5. Test Result and Data (99% Occupied Bandwidth) 114
- 10. Average Power 148
 - 10.1. Test Limit 148
 - 10.2. Test Procedure 149
 - 10.3. Test Setup Layout 149
 - 10.4. Test Result and Data 150
- 11. Power Spectral Density 153
 - 11.1. Test Limit 153
 - 11.2. Test Procedure 153
 - 11.3. Test Setup Layout 153
 - 11.4. Test Result and Data 154
- 12. Frequency Stability 181
 - 12.1. Test Procedure 181
 - 12.2. Test Setup Layout 181
 - 12.3. Test Result and Data 182
- 13. Radio Frequency Exposure 183
 - 13.1. Applicable Standards 183
 - 13.2. EUT Specification 183
 - 13.3. Test Results 183
 - 13.4. Calculation 184
 - 13.5. Maximum Permissible Exposure 185



History of this test report

Report No.	Issue Date	Description
TEFE1908104	Oct. 30, 2019	Original



1. Summary of Test Procedure and Test Results

1.1. Applicable Standards

ANSI C63.10:2013

FCC Rules and Regulations Part 15 Subpart E §15.407

KDB789033

FCC Rule	Description of Test	Result
15.203	Antenna Requirement	PASS
15.207(a)	AC Power Line Conducted Emission	PASS
15.407(b) 15.209	Radiated Spurious Emission	PASS
15.407(a)	26 dB & Occupied Bandwidth	PASS
15.407	6 dB Bandwidth	PASS
15.407 (a) & (a)(3)	Average Power	PASS
15.407(a)	Power Spectral Density	PASS
15.407(g)	Frequency Stability	PASS
2.1091	Radio Frequency Exposure	PASS

*The lab has lowered the uncertainty risk of test equipment, environment, and staff technicians according to ISO-IEC17025. Therefore we define test result as compliant when it complies with the standard without further evaluation of test result uncertainty.

*This EUT has been also tested and compiled with the requirement of FCC Part 15, Subpart B, recorded in a separate test report(TEFD1908104).



2. Test Configuration of Equipment under Test

2.1. Feature of Equipment under Test

Frequency Range	BLE: 2400-2483.5MHz 802.11b/g/n: 2400-2483.5MHz 802.11a/n/ac: 5150-5250MHz, 5725-5850MHz
Modulation Type	BLE: GFSK 802.11b: CCK, DQPSK, DBPSK 802.11g/n/a: BPSK, QPSK, 16QAM, 64QAM 802.11ac: BPSK, QPSK, 16QAM, 64QAM, 256QAM
Modulation Technology	DSSS, OFDM, DTS
Data Rate	BLE: GFSK: 1Mbps WLAN: 2.4G 802.11b: 1, 2, 5.5, 11Mbps 802.11g: 6, 9, 12, 18, 24, 36, 48, 54Mbps 802.11n: MCS0 – MCS15, HT20/40 ,VHT20,VHT40 5G 802.11a: 6, 9, 12, 18, 24, 36, 48, 54Mbps 802.11n: MCS0 – MCS15, HT20/40 802.11ac: MCS0 – MCS9, VHT20/40/80
Antenna Type	FPC Antenna(BLE) FPCB Antenna(WLAN)
Antenna Gain	BLE: 2400-2483.5MHz: ANT A: 2.69dBi WLAN: 2400-2483.5MHz: ANT A: 3.55dBi, ANT B: 3.37dBi 5150-5250MHz: ANT A: 4.67dBi, ANT B: 2.49dBi 5725-5850MHz: ANT A: 4.2dBi, ANT B: 4.99dBi

Note:

1. For a more detailed features description, please refer to the manufacturer's specifications or the User's Manual.
2. 802.11ac VHT20, VHT40 and VHT80 support beamforming.



2.2. Carrier Frequency of Channels

Band: 5150MHz-5250MHz

802.11a, 802.11n HT20, 802.11ac VHT20

Channel	Frequency(MHz)	Channel	Frequency(MHz)
*36	5180	*44	5220
40	5200	*48	5240

802.11n HT40, 802.11ac VHT40

Channel	Frequency(MHz)	Channel	Frequency(MHz)
*38	5190	*46	5230

802.11ac VHT80

Channel	Frequency(MHz)
*42	5210

Band: 5725MHz -5850MHz

802.11a, 802.11n HT20, 802.11ac VHT20

Channel	Frequency(MHz)	Channel	Frequency(MHz)
*149	5745	161	5805
153	5765	*165	5825
*157	5785		

802.11n HT40, 802.11ac VHT40

Channel	Frequency(MHz)	Channel	Frequency(MHz)
*151	5755	*159	5795

802.11ac VHT80

Channel	Frequency(MHz)
*155	5775

Note: Channels remarked * are selected to perform test.



2.3. Test Mode and Test Software

- a. During testing, the interface cables and equipment positions were varied according to ANSI C63.10.
- b. The complete test system included remote workstation and EUT for RF test. The remote workstation included Notebook.
- c. An executive program, " QRCT ver.3.0.276.0 " under Windows OS system was executed to transmit and receive data via WLAN. (Non BeamForming)
- d. An executive program, " iwpriv command " under Windows OS system was executed to transmit and receive data via WLAN. (BeamForming)
- e. The following test modes were performed for the test:

Conducted Emissions from the AC mains power ports	
Test Mode	Operating Description
1	802.11a (6Mbps) , Non BeamForming
2	802.11ac VHT20 (6.5Mbps) , Non BeamForming
3	802.11ac VHT40 (13.5Mbps) , Non BeamForming
4	802.11ac VHT80 (29.3Mbps) , Non BeamForming
5	802.11ac VHT20 (6.5Mbps) , BeamForming
6	802.11ac VHT40 (13.5Mbps) , BeamForming
7	802.11ac VHT80 (29.3Mbps) , BeamForming
caused "Test Mode 1,6" generated the worst case, it was reported as the final data.	
Radiation Emissions (30MHz ~ 1GHz)	
Test Mode	Operating Description
1	802.11a (6Mbps) , Non BeamForming
2	802.11ac VHT20 (6.5Mbps) , Non BeamForming
3	802.11ac VHT40 (13.5Mbps) , Non BeamForming
4	802.11ac VHT80 (29.3Mbps) , Non BeamForming
5	802.11ac VHT20 (6.5Mbps) , BeamForming
6	802.11ac VHT40 (13.5Mbps) , BeamForming
7	802.11ac VHT80 (29.3Mbps) , BeamForming
caused "Test Mode 1,6" generated the worst case, they were reported as the final data.	
Radiation Emissions (1GHz ~ 40GHz)	
Test Mode	Operating Description
1	802.11a (6Mbps) , Non BeamForming
2	802.11ac VHT20 (6.5Mbps) , Non BeamForming
3	802.11ac VHT40 (13.5Mbps) , Non BeamForming
4	802.11ac VHT80 (29.3Mbps) , Non BeamForming
5	802.11ac VHT20 (6.5Mbps) , BeamForming
6	802.11ac VHT40 (13.5Mbps) , BeamForming
7	802.11ac VHT80 (29.3Mbps) , BeamForming
caused "Test Mode 1~7" generated the worst case, they were reported as the final data.	

**2.4. Description of Test System**

N/A

2.5. General Information of Test

Test Site	Cerpass Technology Corporation Test Laboratory Address: No.10, Ln. 2, Lianfu St., Luzhu Dist., Taoyuan City 33848, Taiwan (R.O.C.) Tel:+886-3-3226-888 Fax:+886-3-3226-881	
	FCC	TW1439, TW1079
	IC	4934E-1, 4934E-2
	VCCI	T-2205 for Telecommunication test C-4663 for Conducted emission test R-4218 for Radiated emission test G-10812, G-10813 for radiated disturbance above 1GHz
Frequency Range Investigated:	Conducted: from 150kHz to 30 MHz Radiation: from 30 MHz to 40,000MHz	
Test Distance:	The test distance of radiated emission from antenna to EUT is 3 M.	

Test Item	Test Site	Finish Date	Environmental Conditions	Tested By
RF Conducted	RFCON01-NK	2019/10/25	22°C / 63%	Nick Guan
Radiated Emissions	3M02-NK	2019/10/25	22°C / 64%	Vic Yeh
RF Conduction	CON01-NK	2019/10/25	24°C / 43%	Leon Huang



2.6. Measurement Uncertainty

Measurement Item	Uncertainty
AC Power Line Conduction(150K~30MHz)	±1.60dB
Radiated Spurious Emission(9KHz~30MHz)	±3.405dB
Radiated Spurious Emission(30MHz~1GHz)	±5.326dB
Radiated Spurious Emission(1GHz~40GHz)	±5.011dB
6dB Bandwidth	±4.407%
26dB Bandwidth	±4.459%
Occupied Bandwidth	±4.403%
Peak Output Power(Conducted Power Meter)	±1.31dB
Power Spectral Density	±2.106dB
Duty Cycle	±0.17%
Frequency Stability	±156.543Hz
Temperature	±1.2°C
Humidity	±2.7%



3. Test Equipment and Ancillaries Used for Tests

Test Item	Radiated Emissions				
Test Site	Semi Anechoic Room(3M02-NK)				
Instrument	Manufacturer	Model No	Serial No	Calibration Date	Valid Date
Bilog Antenna	Schwarzbeck	VULB9168	369	2019/03/29	2020/03/28
Active Loop Antenna	EMCO	6507	40855	2019/05/24	2020/05/23
Horn Antenna	EMCO	3115	31589	2019/04/01	2020/03/31
Horn Antenna	EMCO	3116	31974	2019/09/17	2020/09/16
EMI Receiver	ROHDE & SCHWARZ	ESCI	101423	2019/05/14	2020/05/13
Spectrum Analyzer	ROHDE & SCHWARZ	FSP 40	100047	2019/03/28	2020/03/27
Preamplifier	EM Electronics corp.	EM330	60660	2019/03/11	2020/03/10
Preamplifier	Agilent	8449B	3008A01954	2019/03/11	2020/03/10
Preamplifier	EMC INSTRUMENTS	EMC184045	980065	2018/10/31	2019/10/30
Bluetooth Tester	ROHDE & SCHWARZ	CBT	101133	2019/04/07	2020/04/06
Cable-3in1(30M-1G)	HARBOUR INDUSTRIES	LL142	CCE1315	2019/04/09	2020/04/08
Cable-3in1(30M-1G)	HARBOUR INDUSTRIES	LL142	CCE1316	2019/09/20	2020/09/19
Cable-0.5m(1G-40G)	HUBER SUHNER	SUCOFLEX 100	805443/4	2019/05/20	2020/05/19
Cable-3m(1G-40G)	HUBER SUHNER	SUCOFLEX 100	805796/4	2019/05/20	2020/05/19
Cable-8m(1G-40G)	HUBER SUHNER	SUCOFLEX 100	805795/4	2019/05/20	2020/05/19
E3	AUDIX	v8.2014-8-6	RK-000529	NA	NA

Test Item	RF Conducted				
Test Site	RFCON01-NK				
Instrument	Manufacturer	Model No	Serial No	Calibration Date	Valid Date
Spectrum Analyzer	ROHDE & SCHWARZ	FSP 40	100047	2019/03/28	2020/03/27
Bluetooth Tester	ROHDE & SCHWARZ	CBT	101133	2019/04/07	2020/04/06
Attenuator	KEYSIGHT	8491B	MY39250703	2019/09/12	2020/09/11
TEMP & HUMIDITY CHAMBER	T-MACHINE	TMJ-9712	T-12-040111	2019/08/28	2020/08/27
Power Meter	Anritsu	ML2495A	1224005	2019/4/11	2020/04/10
Power Sensor	Anritsu	MA2411B	1207295	2019/04/09	2020/04/08

Test Item	AC Power Line Conducted Emission				
Test Site	CON01-NK				
Instrument	Manufacturer	Model No	Serial No	Calibration Date	Valid Date
EMI Receiver	ROHDE & SCHWARZ	ESCI	100443	2019/03/29	2020/03/28
Line Impedance Stabilization Network	Schwarzbeck	NSLK 8127	8127-568	2019/03/15	2020/03/14
Pulse Limiter	ROHDE & SCHWARZ	ESH3-Z2	101934	2019/03/12	2020/03/11
Cable-6m(9k~300M)	NA	EMC5D-BM-BM-6	130606	2019/03/14	2020/03/13
E3	AUDIX	v8.2014-8-6	RK-000531	NA	NA



4. Antenna Requirements

4.1. Standard Applicable

For intentional device, according to FCC 47 CFR Section 15.203, an intentional radiator shall be designed to ensure that no antenna other than that furnished by the responsible party shall be used with the device.

And according to FCC 47 CFR Section 15.407 (a), if transmitting antennas of directional gain greater than 6dBi are used, the power shall be reduced by the amount in dB that the directional gain of the antenna exceeds 6dBi.

4.2. Antenna Construction and Directional Gain

Antenna Type	FPCB Antenna
Antenna Gain	2412-2462MHz: ANT A: 3.55dBi, ANT B: 3.37dBi 5150MHz-5250MHz: ANT A: 4.67dBi, ANT B: 2.49dBi 5725MHz -5850MHz: ANT A: 4.2dBi, ANT B: 4.99dBi

(Non-Beamforming)

2412-2462MHz
For Power directional gain= $G_{ant} = 3.55$ dBi For PSD directional gain = $10 \log[(10^{G1/20} + 10^{G2/20})^2 / N_{ANT}]$ = 6.47 (dBi)
5180MHz~5240MHz
For Power directional gain= $G_{ant} = 4.67$ dBi For PSD directional gain = $10 \log[(10^{G1/20} + 10^{G2/20})^2 / N_{ANT}]$ = 6.66 (dBi)
5745MHz~5825MHz
For Power directional gain= $G_{ant} = 4.99$ dBi For PSD directional gain = $10 \log[(10^{G1/20} + 10^{G2/20})^2 / N_{ANT}]$ = 7.61 (dBi)

(Beamforming)

2412-2462MHz
For Power directional gain= $10 \log[(10^{G1/20} + 10^{G2/20})^2 / N_{ANT}] = 6.47$ (dBi) For PSD directional gain = $10 \log[(10^{G1/20} + 10^{G2/20})^2 / N_{ANT}] = 6.47$ (dBi)
5150MHz -5250MHz
For Power directional gain= $10 \log[(10^{G1/20} + 10^{G2/20})^2 / N_{ANT}] = 6.66$ (dBi) For PSD directional gain = $10 \log[(10^{G1/20} + 10^{G2/20})^2 / N_{ANT}] = 6.66$ (dBi)
5725MHz -5850MHz
For Power directional gain= $10 \log[(10^{G1/20} + 10^{G2/20})^2 / N_{ANT}] = 7.61$ (dBi) For PSD directional gain = $10 \log[(10^{G1/20} + 10^{G2/20})^2 / N_{ANT}] = 7.61$ (dBi)



5. Test of AC Power Line Conducted Emission

5.1. Test Limit

Conducted Emissions were measured from 150 kHz to 30 MHz with a bandwidth of 9 KHz, according to the methods defined in ANSI C63.4-2014. The EUT was placed on a nonmetallic stand in a shielded room 0.8 meters above the ground plane. The interface cables and equipment positioning were varied within limits of reasonable applications to determine the position produced maximum conducted emissions.

Frequency (MHz)	Quasi Peak (dB μ V)	Average (dB μ V)
0.15 – 0.5	66-56*	56-46*
0.5 – 5.0	56	46
5.0 – 30.0	60	50

*Decreases with the logarithm of the frequency.

5.2. Test Procedures

- The EUT was placed 0.4 meter from the conducting wall of the shielding room was kept at least 80 centimeters from any other grounded conducting surface.
- Connect EUT to the power mains through a line impedance stabilization network (LISN).
- All the support units are connecting to the other LISN.
- The LISN provides 50 ohm coupling impedance for the measuring instrument.
- The FCC states that a 50 ohm, 50 micro-Henry LISN should be used.
- Both sides of AC line were checked for maximum conducted interference.
- The frequency range from 150 kHz to 30 MHz was searched.
- Set the test-receiver system to Peak Detect Function and Specified Bandwidth with Maximum Hold Mode.



5.3. Typical Test Setup

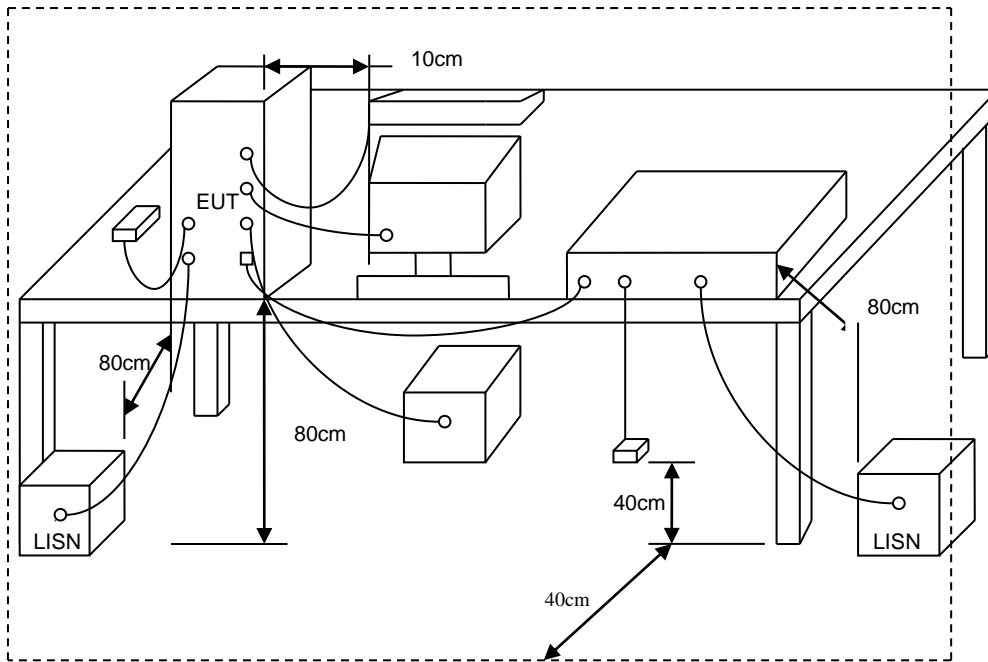



5.4. Test Result and Data

Power	: AC 120V / 60Hz	Pol/Phase	: LINE
Test Mode	: Mode 1, Band4		

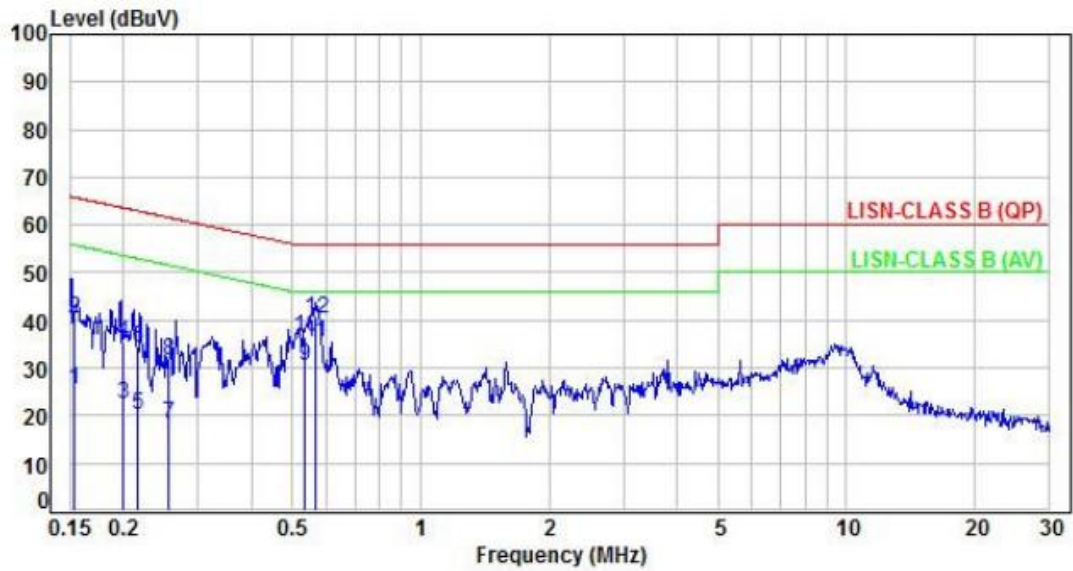

No.	Frequency (MHz)	Factor (dB)	Reading (dBuV)	Level (dBuV)	Limit (dBuV)	Margin (dB)	Detector	P/F
1	0.15	9.92	15.37	25.29	55.85	-30.56	Average	P
2	0.15	9.92	30.40	40.32	65.85	-25.53	QP	P
3	0.20	9.92	12.40	22.32	53.61	-31.29	Average	P
4	0.20	9.92	25.57	35.49	63.61	-28.12	QP	P
5	0.22	9.92	10.04	19.96	52.94	-32.98	Average	P
6	0.22	9.92	24.17	34.09	62.94	-28.85	QP	P
7	0.26	9.92	8.17	18.09	51.54	-33.45	Average	P
8	0.26	9.92	21.57	31.49	61.54	-30.05	QP	P
9	0.53	9.95	20.62	30.57	46.00	-15.43	Average	P
10	0.53	9.95	26.66	36.61	56.00	-19.39	QP	P
11	0.56	9.95	25.35	35.30	46.00	-10.70	Average	P
12	0.56	9.95	30.31	40.26	56.00	-15.74	QP	P

Note: Level=Reading+Factor
 Margin=Level-Limit
 Factor=(LISN or ISN or Current Probe)Factor + Cable Loss



Power	: AC 120V / 60Hz	Pol/Phase	: NEUTRAL
Test Mode	: Mode 1, Band4		

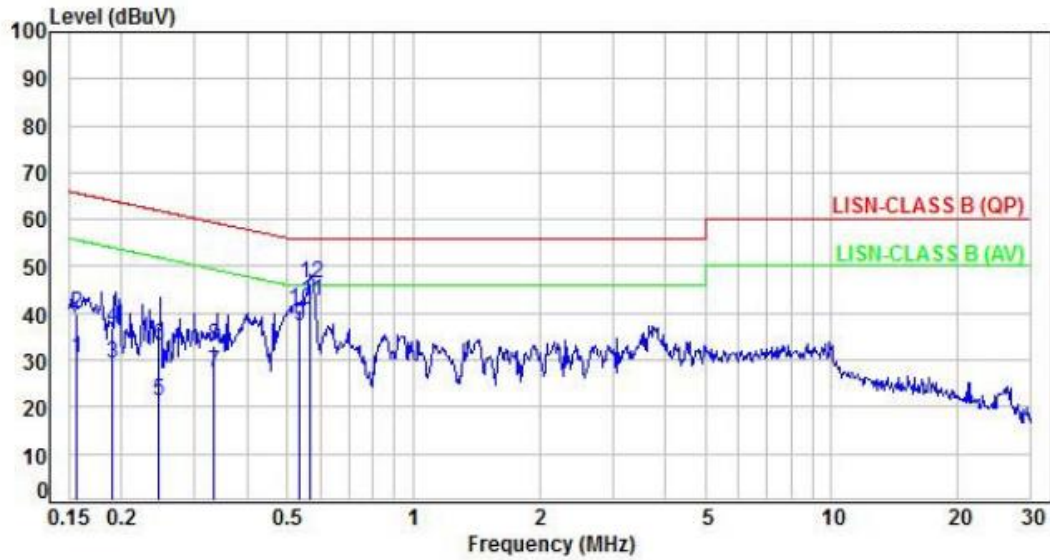

No.	Frequency (MHz)	Factor (dB)	Reading (dBuV)	Level (dBuV)	Limit (dBuV)	Margin (dB)	Detector	P/F
1	0.16	9.95	20.61	30.56	55.66	-25.10	Average	P
2	0.16	9.95	30.06	40.01	65.66	-25.65	QP	P
3	0.19	9.95	19.45	29.40	54.01	-24.61	Average	P
4	0.19	9.95	26.95	36.90	64.01	-27.11	QP	P
5	0.25	9.95	11.48	21.43	51.90	-30.47	Average	P
6	0.25	9.95	23.09	33.04	61.90	-28.86	QP	P
7	0.33	9.96	17.55	27.51	49.35	-21.84	Average	P
8	0.33	9.96	23.12	33.08	59.35	-26.27	QP	P
9	0.53	9.96	27.16	37.12	46.00	-8.88	Average	P
10	0.53	9.96	30.62	40.58	56.00	-15.42	QP	P
11	0.57	9.96	32.61	42.57	46.00	-3.43	Average	P
12	0.57	9.96	36.27	46.23	56.00	-9.77	QP	P

Note: Level=Reading+Factor
 Margin=Level-Limit
 Factor=(LISN or ISN or Current Probe)Factor + Cable Loss



Power	: AC 120V / 60Hz	Pol/Phase	: LINE
Test Mode	: Mode 6, Band4		:

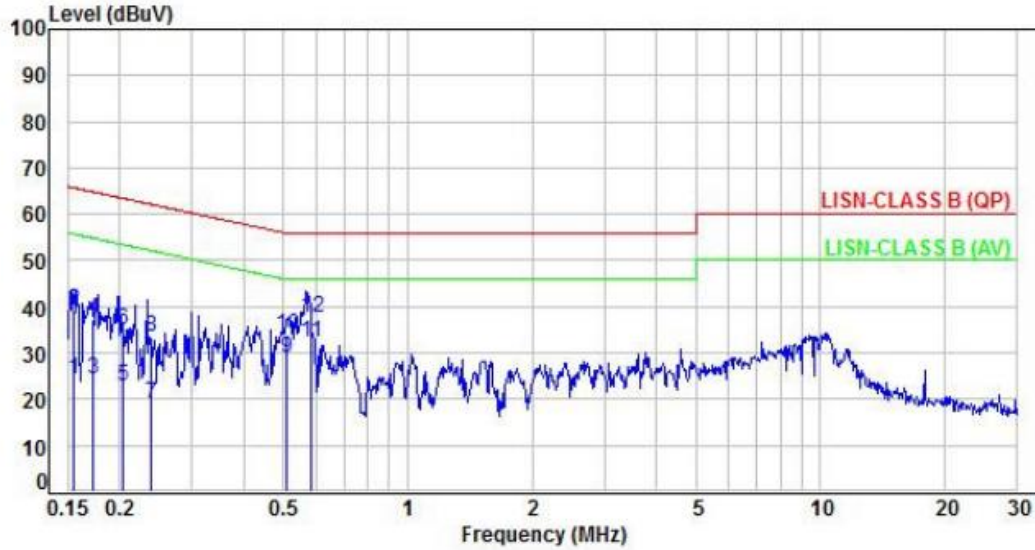

No.	Frequency (MHz)	Factor (dB)	Reading (dBuV)	Level (dBuV)	Limit (dBuV)	Margin (dB)	Detector	P/F
1	0.16	9.92	14.45	24.37	55.70	-31.33	Average	P
2	0.16	9.92	29.22	39.14	65.70	-26.56	QP	P
3	0.17	9.92	14.45	24.37	54.83	-30.46	Average	P
4	0.17	9.92	27.26	37.18	64.83	-27.65	QP	P
5	0.20	9.92	13.05	22.97	53.42	-30.45	Average	P
6	0.20	9.92	25.20	35.12	63.42	-28.30	QP	P
7	0.24	9.92	9.05	18.97	52.14	-33.17	Average	P
8	0.24	9.92	23.48	33.40	62.14	-28.74	QP	P
9	0.51	9.95	18.89	28.84	46.00	-17.16	Average	P
10	0.51	9.95	23.82	33.77	56.00	-22.23	QP	P
11	0.58	9.95	22.49	32.44	46.00	-13.56	Average	P
12	0.58	9.95	27.84	37.79	56.00	-18.21	QP	P

Note: Level=Reading+Factor
 Margin=Level-Limit
 Factor=(LISN or ISN or Current Probe)Factor + Cable Loss



Power	: AC 120V / 60Hz	Pol/Phase	: NEUTRAL
Test Mode	: Mode 6, Band4		

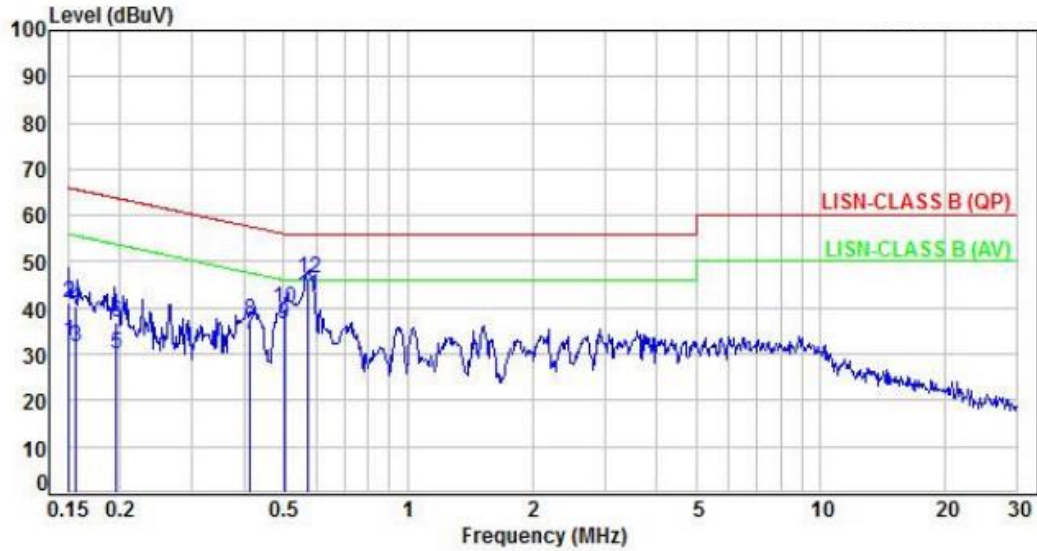

No.	Frequency (MHz)	Factor (dB)	Reading (dBuV)	Level (dBuV)	Limit (dBuV)	Margin (dB)	Detector	P/F
1	0.15	9.95	22.56	32.51	55.97	-23.46	Average	P
2	0.15	9.95	31.18	41.13	65.97	-24.84	QP	P
3	0.16	9.95	21.45	31.40	55.65	-24.25	Average	P
4	0.16	9.95	30.31	40.26	65.65	-25.39	QP	P
5	0.20	9.95	20.19	30.14	53.75	-23.61	Average	P
6	0.20	9.95	27.09	37.04	63.75	-26.71	QP	P
7	0.41	9.96	24.24	34.20	47.56	-13.36	Average	P
8	0.41	9.96	27.49	37.45	57.56	-20.11	QP	P
9	0.50	9.96	26.55	36.51	46.00	-9.49	Average	P
10	0.50	9.96	29.87	39.83	56.00	-16.17	QP	P
11	0.57	9.96	32.51	42.47	46.00	-3.53	Average	P
12	0.57	9.96	36.32	46.28	56.00	-9.72	QP	P

Note: Level=Reading+Factor
 Margin=Level-Limit
 Factor=(LISN or ISN or Current Probe)Factor + Cable Loss



6. Test of Spurious Emission (Radiated)

6.1. Test Limit

Undesirable emission limits. Except as shown in paragraph (b)(7) of this section, the maximum emissions outside of the frequency bands of operation shall be attenuated in accordance with the following limits:

- (1) For transmitters operating in the 5.15-5.25 GHz band: All emissions outside of the 5.15-5.35 GHz band shall not exceed an e.i.r.p. of -27 dBm/MHz.
- (2) For transmitters operating in the 5.25-5.35 GHz band: All emissions outside of the 5.15-5.35 GHz band shall not exceed an e.i.r.p. of -27 dBm/MHz.
- (3) For transmitters operating in the 5.47-5.725 GHz band: All emissions outside of the 5.47-5.725 GHz band shall not exceed an e.i.r.p. of -27 dBm/MHz.
- (4) For transmitters operating in the 5.725-5.85 GHz band:
All emissions shall be limited to a level of -27 dBm/MHz at 75 MHz or more above or below the band edge increasing linearly to 10 dBm/MHz at 25 MHz above or below the band edge, and from 25MHz above or below the band edge increasing linearly to a level of 15.6 dBm/MHz at 5 MHz above or below the band edge, and from 5 MHz above or below the band edge increasing linearly to a level of 27dBm/MHz at the band edge.
- (5) The emission measurements shall be performed using a minimum resolution bandwidth of 1 MHz. A lower resolution bandwidth may be employed near the band edge, when necessary, provided the measured energy is integrated to show the total power over 1 MHz.
- (6) Unwanted emissions below 1 GHz must comply with the general field strength limits set forth in §15.209. Further, any U-NII devices using an AC power line are required to comply also with the conducted limits set forth in §15.207.
- (7) The provisions of §15.205 apply to intentional radiators operating under this section.
- (8) When measuring the emission limits, the nominal carrier frequency shall be adjusted as close to the upper and lower frequency band edges as the design of the equipment permits.

6.2. Test Procedures

- a. The EUT was placed on a rotatable table top 0.8 meter above ground.
- b. The EUT was set 3 meters from the interference receiving antenna which was mounted on the top of a variable height antenna tower.
- c. The table was rotated 360 degrees to determine the position of the highest radiation.
- d. The antenna is a broadband antenna and its height is varied between one meter and four meters above ground to find the maximum value of the field strength both horizontal polarization and vertical polarization of the antenna are set to make the measurement.
- e. For each suspected emission the EUT was arranged to its worst case and then tune the antenna tower (from 1 M to 4 M) and turn table (from 0 degree to 360 degrees) to find the maximum reading.
- f. Set the test-receiver system to Peak or CISPR quasi-peak Detect Function and specified bandwidth with Maximum Hold Mode.
- g. If the emission level of the EUT in peak mode was 3 dB lower than the limit specified, then testing will be stopped and peak values of EUT will be reported, otherwise, the emissions which do not have 3 dB margin will be repeated one by one using the quasi-peak method and reported.
- h. For testing above 1GHz, the emission level of the EUT in peak mode was 20dB lower than average limit (that means the emission level in peak mode also complies with the limit in average mode), then testing will be stopped and peak values of EUT will be reported, otherwise, the emissions will be measured in average mode again and reported.
- i. "Cone of radiation" has been considered to be 3dB bandwidth of the measurement antenna.



6.3. Typical Test Setup

Below 30MHz test setup

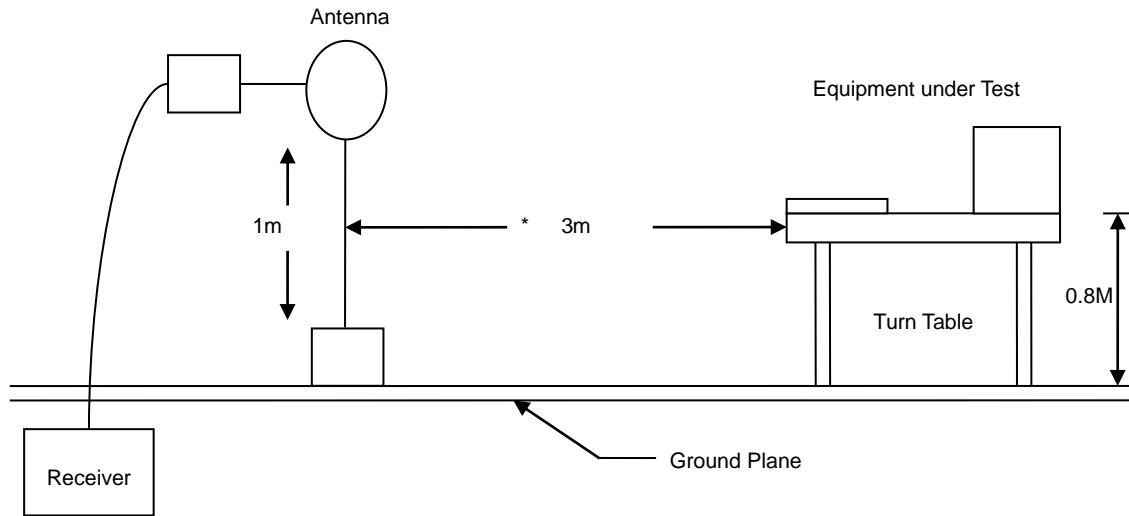

30MHz- 1GHz Test Setup

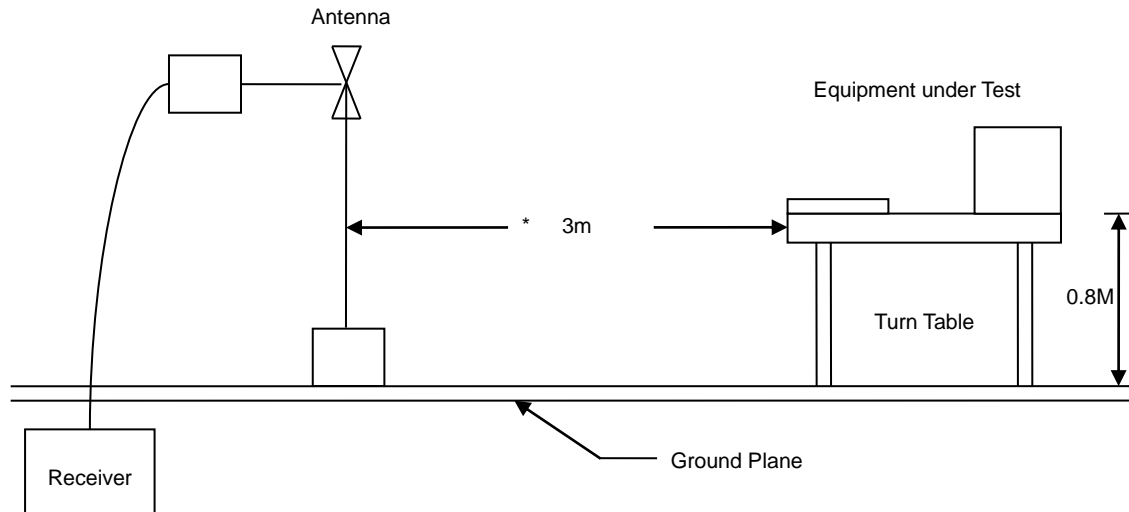

Above 1GHz Test Setup

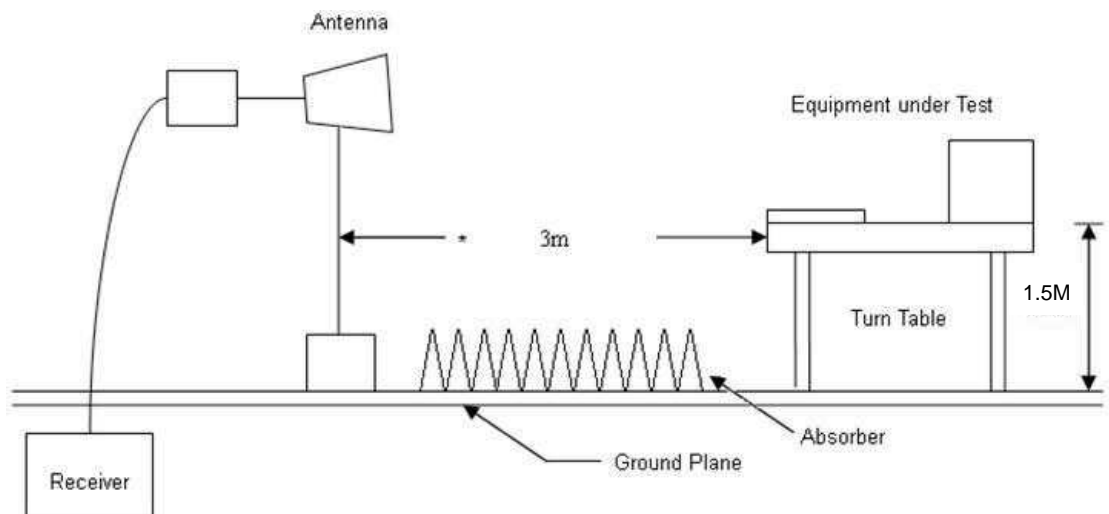



6.4. Test Result and Data (9kHz ~ 30MHz)

The 9kHz - 30MHz spurious emission is under limit 20dB more.

6.5. Test Result and Data (30MHz ~ 1GHz)

Power	: AC 120V / 60 Hz	Pol/Phase	: VERTICAL
Test Mode	: Mode 1		

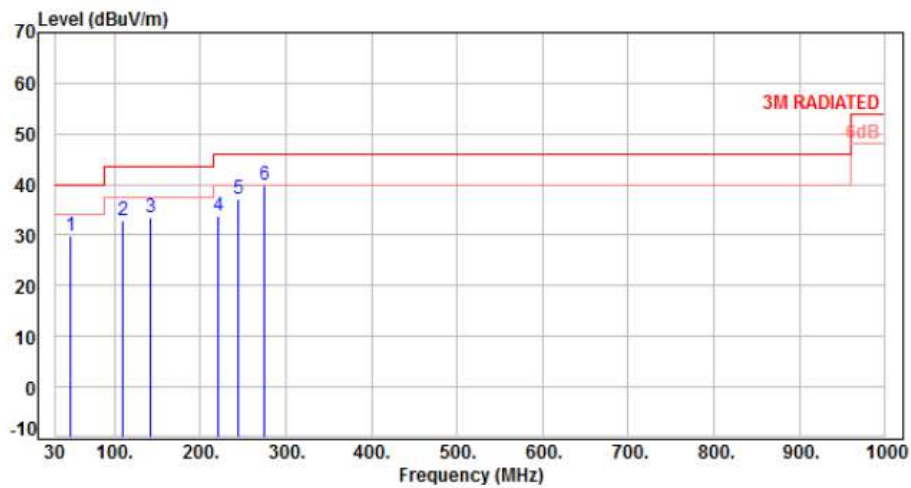

No.	Frequency (MHz)	Factor (dB)	Reading (dBuV)	Level (dBuV/m)	Limit (dBuV/m)	Margin (dB)	Detector	Height (cm)	Azimuth (deg)	P/F
1	47.55	-9.31	39.04	29.73	40.00	-10.27	Peak	100	0	P
2	109.95	-12.44	45.24	32.80	43.50	-10.70	Peak	100	0	P
3	142.25	-9.70	43.18	33.48	43.50	-10.02	Peak	100	0	P
4	220.64	-11.93	45.74	33.81	46.00	-12.19	Peak	100	0	P
5	245.18	-10.44	47.57	37.13	46.00	-8.87	Peak	100	0	P
6	274.83	-9.20	49.12	39.92	46.00	-6.08	Peak	100	0	P

Note: Level=Reading+Factor
Margin=Level-Limit
Factor=Antenna Factor + cable loss - Amplifier Factor



Power	: AC 120V / 60 Hz	Pol/Phase	: HORIZONTAL
Test Mode	: Mode 1		:

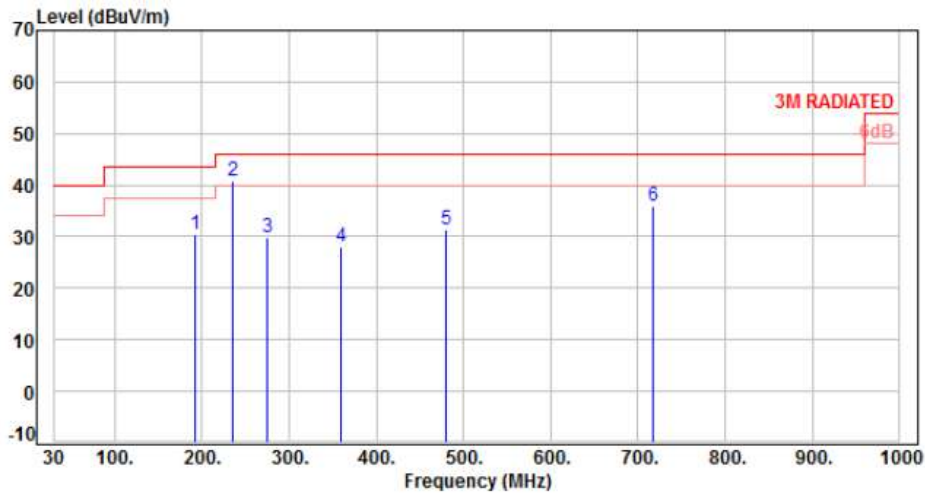

No.	Frequency (MHz)	Factor (dB)	Reading (dBuV)	Level (dBuV/m)	Limit (dBuV/m)	Margin (dB)	Detector	Height (cm)	Azimuth (deg)	P/F
1	191.42	-11.69	42.28	30.59	43.50	-12.91	Peak	100	0	P
2	235.22	-10.80	51.51	40.71	46.00	-5.29	Peak	100	0	P
3	274.78	-9.20	39.15	29.95	46.00	-16.05	Peak	100	0	P
4	359.36	-6.82	34.86	28.04	46.00	-17.96	Peak	100	0	P
5	480.76	-3.95	35.38	31.43	46.00	-14.57	Peak	100	0	P
6	716.93	0.30	35.52	35.82	46.00	-10.18	Peak	100	0	P

Note: Level=Reading+Factor
 Margin=Level-Limit
 Factor=Antenna Factor + cable loss - Amplifier Factor



Power	: AC 120V / 60 Hz	Pol/Phase	: VERTICAL
Test Mode	: Mode 6		:

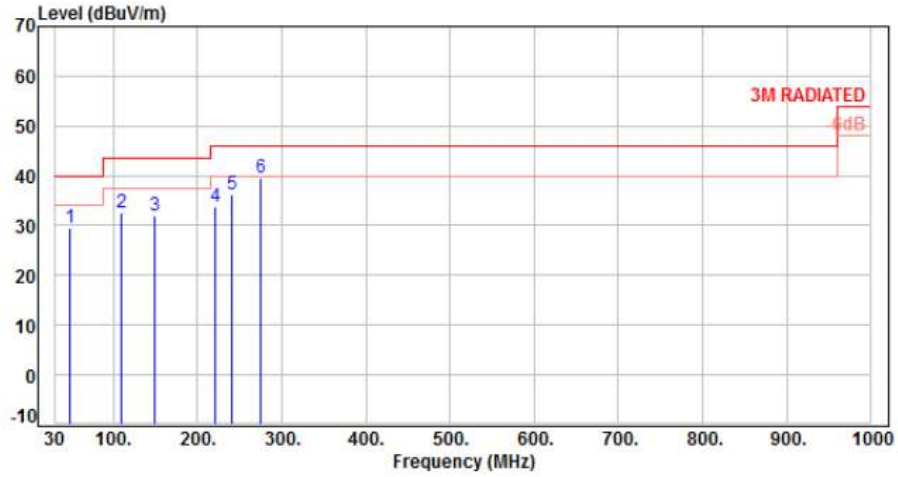

No.	Frequency (MHz)	Factor (dB)	Reading (dBuV)	Level (dBuV/m)	Limit (dBuV/m)	Margin (dB)	Detector	Height (cm)	Azimuth (deg)	P/F
1	47.82	-9.31	38.77	29.46	40.00	-10.54	Peak	100	0	P
2	109.28	-12.52	45.01	32.49	43.50	-11.01	Peak	100	0	P
3	148.66	-9.51	41.57	32.06	43.50	-11.44	Peak	100	0	P
4	220.63	-11.93	45.65	33.72	46.00	-12.28	Peak	100	0	P
5	240.94	-10.55	46.77	36.22	46.00	-9.78	Peak	100	0	P
6	274.62	-9.21	48.89	39.68	46.00	-6.32	Peak	100	0	P

Note: Level=Reading+Factor
Margin=Level-Limit
Factor=Antenna Factor + cable loss - Amplifier Factor



Power	: AC 120V / 60 Hz	Pol/Phase	: HORIZONTAL
Test Mode	: Mode 6		:

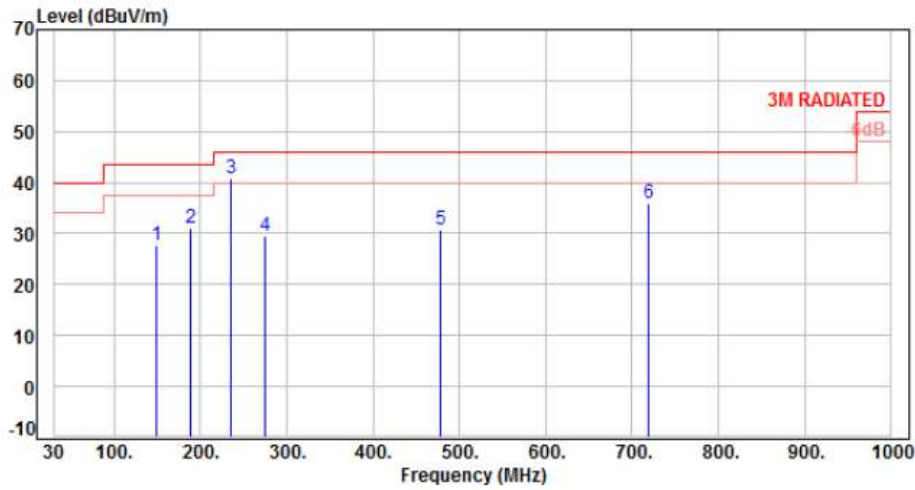

No.	Frequency (MHz)	Factor (dB)	Reading (dBuV)	Level (dBuV/m)	Limit (dBuV/m)	Margin (dB)	Detector	Height (cm)	Azimuth (deg)	P/F
1	148.75	-9.51	37.20	27.69	43.50	-15.81	Peak	100	0	P
2	189.36	-11.60	42.58	30.98	43.50	-12.52	Peak	100	0	P
3	235.78	-10.78	51.71	40.93	46.00	-5.07	Peak	100	0	P
4	274.82	-9.20	38.82	29.62	46.00	-16.38	Peak	100	0	P
5	478.52	-3.98	34.80	30.82	46.00	-15.18	Peak	100	0	P
6	718.55	0.33	35.64	35.97	46.00	-10.03	Peak	100	0	P

Note: Level=Reading+Factor
Margin=Level-Limit
Factor=Antenna Factor + cable loss - Amplifier Factor



6.6. Test Result and Data (1GHz ~ 40GHz)

Power	: AC 120V / 60Hz	Pol/Phase	: VERTICAL
Test Mode	: Mode 1, Band 1, CH36		:

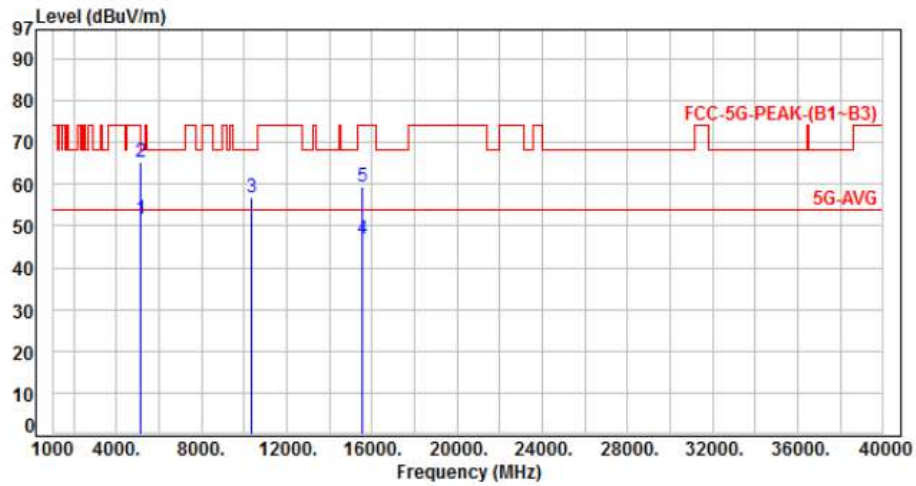

No.	Frequency (MHz)	Factor (dB)	Reading (dBuV)	Level (dBuV/m)	Limit (dBuV/m)	Margin (dB)	Detector	Height (cm)	Azimuth (deg)	P/F
1	5150.00	4.73	46.76	51.49	54.00	-2.51	Average	198	176	P
2	5150.00	4.73	60.53	65.26	74.00	-8.74	Peak	198	176	P
3	10360.00	11.43	45.26	56.69	68.20	-11.51	Peak	100	133	P
4	15540.00	14.27	32.47	46.74	54.00	-7.26	Average	100	205	P
5	15540.00	14.27	45.17	59.44	74.00	-14.56	Peak	100	205	P

Note: Level=Reading+Factor
 Margin=Level-Limit
 Factor=Antenna Factor + cable loss - Amplifier Factor



Power	: AC 120V / 60Hz	Pol/Phase	: HORIZONTAL
Test Mode	: Mode 1, Band 1, CH36		:

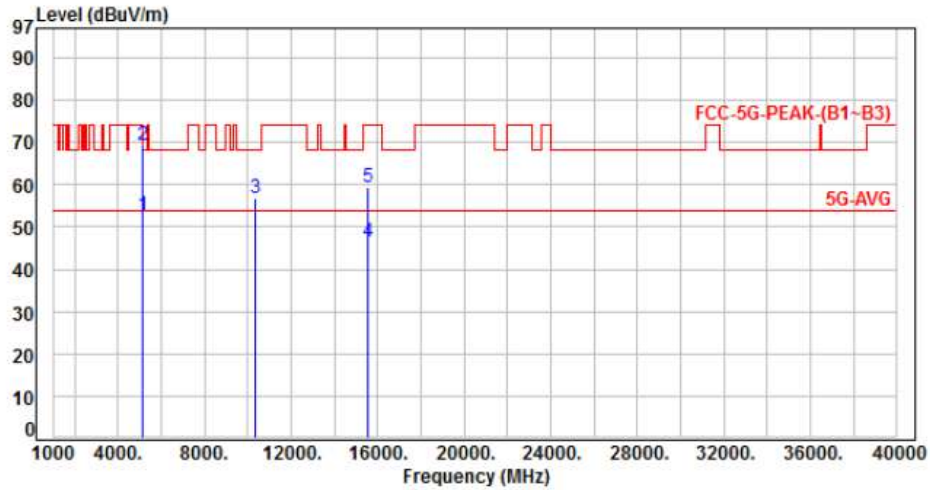

No.	Frequency (MHz)	Factor (dB)	Reading (dBuV)	Level (dBuV/m)	Limit (dBuV/m)	Margin (dB)	Detector	Height (cm)	Azimuth (deg)	P/F
1	5150.00	4.73	48.03	52.76	54.00	-1.24	Average	118	0	P
2	5150.00	4.73	64.50	69.23	74.00	-4.77	Peak	118	0	P
3	10360.00	11.43	45.39	56.82	68.20	-11.38	Peak	100	116	P
4	15540.00	14.27	32.37	46.64	54.00	-7.36	Average	121	68	P
5	15540.00	14.27	45.24	59.51	74.00	-14.49	Peak	121	68	P

Note: Level=Reading+Factor
Margin=Level-Limit
Factor=Antenna Factor + cable loss - Amplifier Factor



Power	: AC 120V / 60Hz	Pol/Phase	: VERTICAL
Test Mode	: Mode 1, Band 1, CH44		:

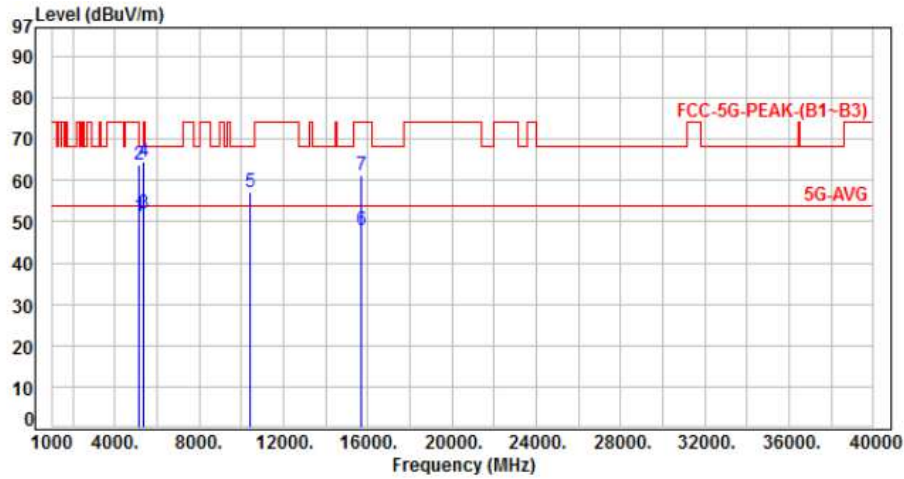

No.	Frequency (MHz)	Factor (dB)	Reading (dBuV)	Level (dBuV/m)	Limit (dBuV/m)	Margin (dB)	Detector	Height (cm)	Azimuth (deg)	P/F
1	5150.00	4.73	46.63	51.36	54.00	-2.64	Average	168	285	P
2	5150.00	4.73	59.12	63.85	74.00	-10.15	Peak	168	285	P
3	5350.00	5.07	46.82	51.89	54.00	-2.11	Average	168	285	P
4	5350.00	5.07	59.56	64.63	74.00	-9.37	Peak	168	285	P
5	10440.00	11.55	45.48	57.03	68.20	-11.17	Peak	100	247	P
6	15660.00	13.72	34.39	48.11	54.00	-5.89	Average	171	329	P
7	15660.00	13.72	47.48	61.20	74.00	-12.80	Peak	171	329	P

Note: Level=Reading+Factor
Margin=Level-Limit
Factor=Antenna Factor + cable loss - Amplifier Factor



Power	: AC 120V / 60Hz	Pol/Phase	: HORIZONTAL
Test Mode	: Mode 1, Band 1, CH44		:

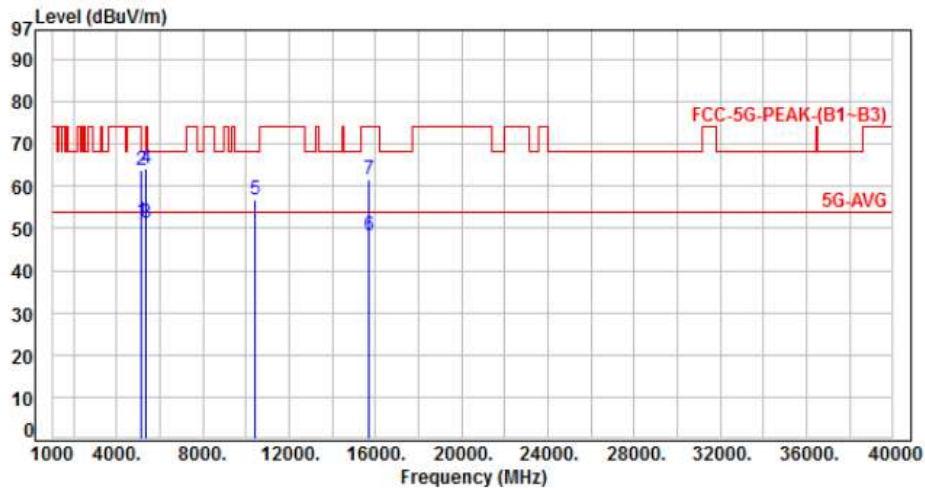

No.	Frequency (MHz)	Factor (dB)	Reading (dBUV)	Level (dBUV/m)	Limit (dBUV/m)	Margin (dB)	Detector	Height (cm)	Azimuth (deg)	P/F
1	5150.00	4.73	46.93	51.66	54.00	-2.34	Average	132	2	P
2	5150.00	4.73	59.13	63.86	74.00	-10.14	Peak	132	2	P
3	5350.00	5.07	46.33	51.40	54.00	-2.60	Average	132	2	P
4	5350.00	5.07	59.25	64.32	74.00	-9.68	Peak	132	2	P
5	10440.00	11.55	45.32	56.87	68.20	-11.33	Peak	100	158	P
6	15660.00	13.72	34.62	48.34	54.00	-5.66	Average	297	3	P
7	15660.00	13.72	47.69	61.41	74.00	-12.59	Peak	297	3	P

Note: Level=Reading+Factor
 Margin=Level-Limit
 Factor=Antenna Factor + cable loss - Amplifier Factor



Power	: AC 120V / 60Hz	Pol/Phase	: VERTICAL
Test Mode	: Mode 1, Band 1, CH48		:

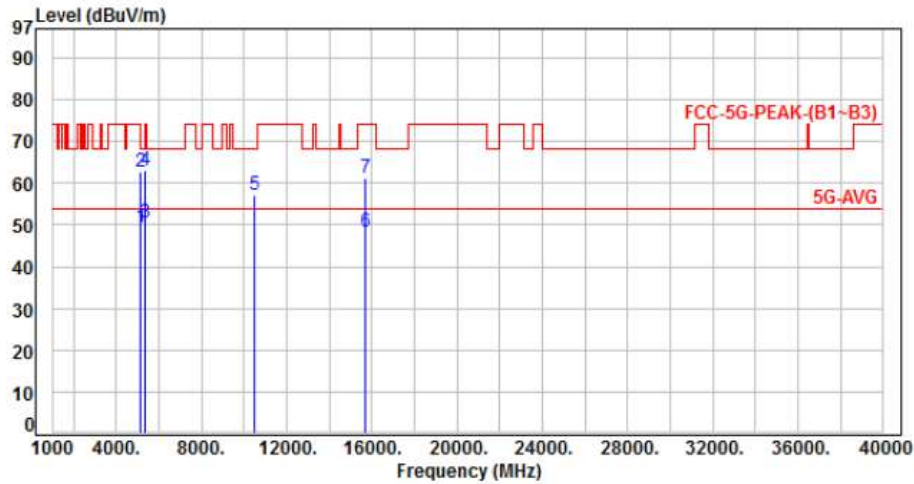

No.	Frequency (MHz)	Factor (dB)	Reading (dBUV)	Level (dBUV/m)	Limit (dBUV/m)	Margin (dB)	Detector	Height (cm)	Azimuth (deg)	P/F
1	5150.00	4.73	44.80	49.53	54.00	-4.47	Average	201	85	P
2	5150.00	4.73	58.15	62.88	74.00	-11.12	Peak	201	85	P
3	5350.00	5.07	45.51	50.58	54.00	-3.42	Average	201	85	P
4	5350.00	5.07	57.95	63.02	74.00	-10.98	Peak	201	85	P
5	10480.00	11.65	45.70	57.35	68.20	-10.85	Peak	100	234	P
6	15720.00	13.60	34.58	48.18	54.00	-5.82	Average	167	337	P
7	15720.00	13.60	47.62	61.22	74.00	-12.78	Peak	167	337	P

Note: Level=Reading+Factor
Margin=Level-Limit
Factor=Antenna Factor + cable loss - Amplifier Factor



Power	: AC 120V / 60Hz	Pol/Phase	: HORIZONTAL
Test Mode	: Mode 1, Band 1, CH48		:

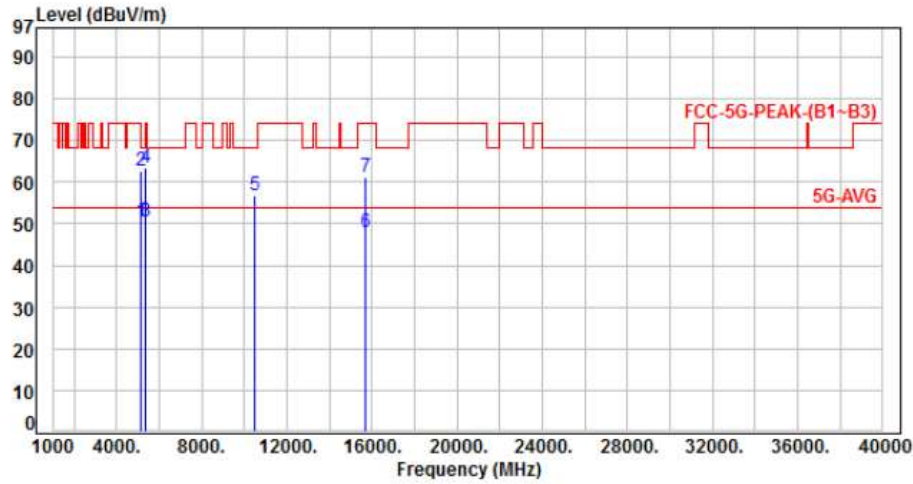

No.	Frequency (MHz)	Factor (dB)	Reading (dBuV)	Level (dBuV/m)	Limit (dBuV/m)	Margin (dB)	Detector	Height (cm)	Azimuth (deg)	P/F
1	5150.00	4.73	45.64	50.37	54.00	-3.63	Average	127	2	P
2	5150.00	4.73	57.96	62.69	74.00	-11.31	Peak	127	2	P
3	5350.00	5.07	45.35	50.42	54.00	-3.58	Average	127	2	P
4	5350.00	5.07	58.53	63.60	74.00	-10.40	Peak	127	2	P
5	10480.00	11.65	45.16	56.81	68.20	-11.39	Peak	100	146	P
6	15720.00	13.60	34.30	47.90	54.00	-6.10	Average	300	0	P
7	15720.00	13.60	47.45	61.05	74.00	-12.95	Peak	300	0	P

Note: Level=Reading+Factor
 Margin=Level-Limit
 Factor=Antenna Factor + cable loss - Amplifier Factor



Power	: AC 120V / 60Hz	Pol/Phase	: VERTICAL
Test Mode	: Mode 2, Band 1, CH36		:

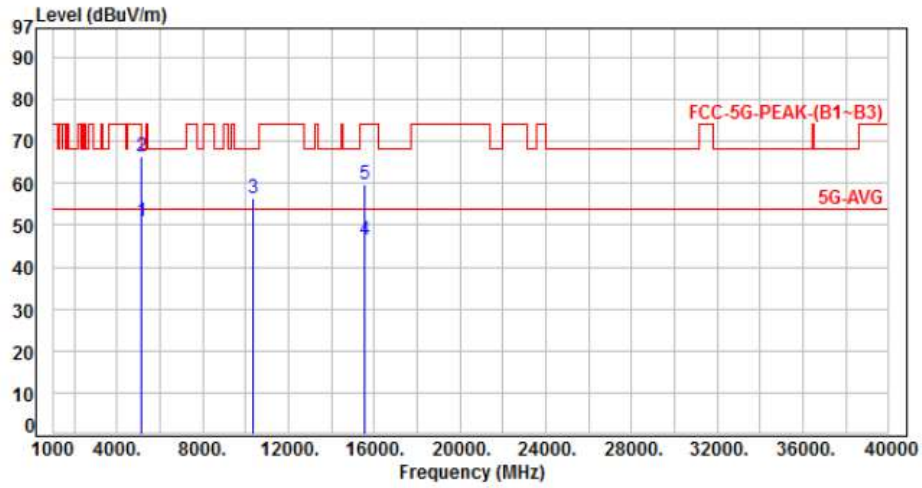

No.	Frequency (MHz)	Factor (dB)	Reading (dBuV)	Level (dBuV/m)	Limit (dBuV/m)	Margin (dB)	Detector	Height (cm)	Azimuth (deg)	P/F
1	5150.00	4.73	46.30	51.03	54.00	-2.97	Average	157	273	P
2	5150.00	4.73	61.72	66.45	74.00	-7.55	Peak	157	273	P
3	10360.00	11.43	44.98	56.41	68.20	-11.79	Peak	100	147	P
4	15540.00	14.27	32.22	46.49	54.00	-7.51	Average	100	239	P
5	15540.00	14.27	45.47	59.74	74.00	-14.26	Peak	100	239	P

Note: Level=Reading+Factor
Margin=Level-Limit
Factor=Antenna Factor + cable loss - Amplifier Factor



Power	: AC 120V / 60Hz	Pol/Phase	: HORIZONTAL
Test Mode	: Mode 2, Band 1, CH36		:

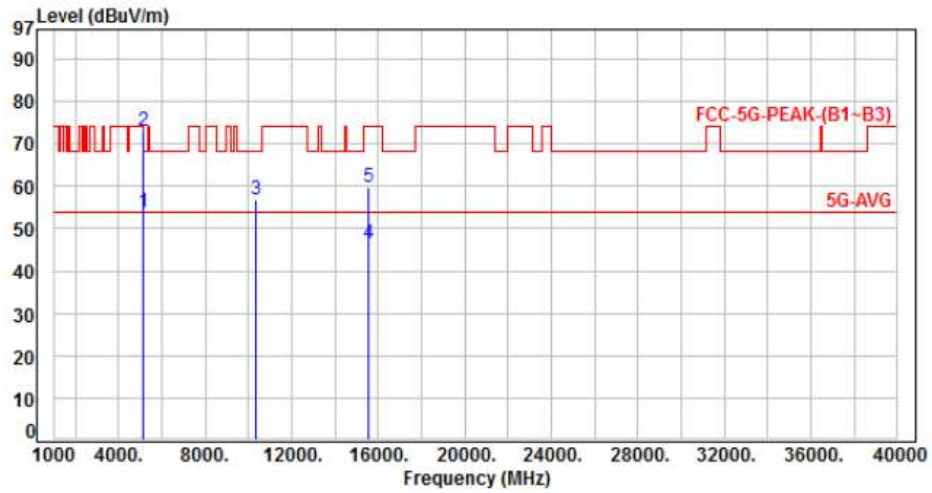

No.	Frequency (MHz)	Factor (dB)	Reading (dBuV)	Level (dBuV/m)	Limit (dBuV/m)	Margin (dB)	Detector	Height (cm)	Azimuth (deg)	P/F
1	5150.00	4.73	49.08	53.81	54.00	-0.19	Average	110	0	P
2	5150.00	4.73	68.16	72.89	74.00	-1.11	Peak	110	0	P
3	10360.00	11.43	45.26	56.69	68.20	-11.51	Peak	115	86	P
4	15540.00	14.27	32.14	46.41	54.00	-7.59	Average	130	75	P
5	15540.00	14.27	45.44	59.71	74.00	-14.29	Peak	130	75	P

Note: Level=Reading+Factor
Margin=Level-Limit
Factor=Antenna Factor + cable loss - Amplifier Factor



Power	: AC 120V / 60Hz	Pol/Phase	: VERTICAL
Test Mode	: Mode 2, Band 1, CH44		

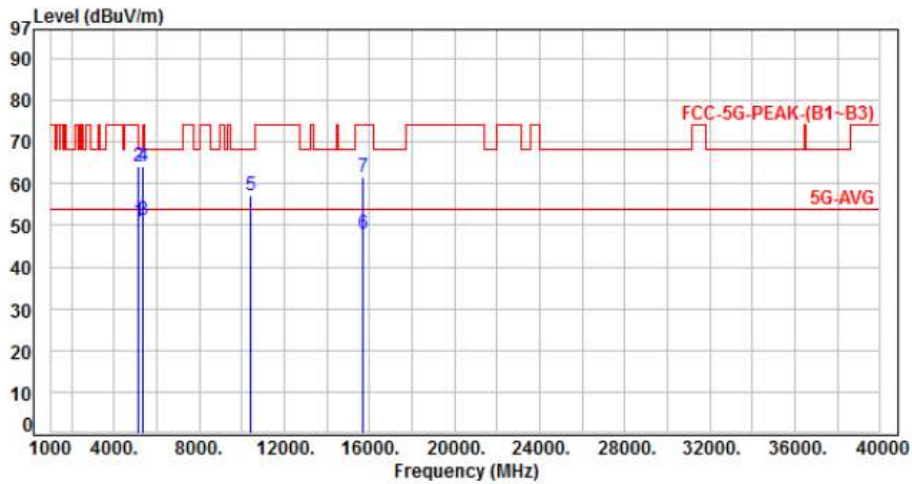

No.	Frequency (MHz)	Factor (dB)	Reading (dBuV)	Level (dBuV/m)	Limit (dBuV/m)	Margin (dB)	Detector	Height (cm)	Azimuth (deg)	P/F
1	5150.00	4.73	46.11	50.84	54.00	-3.16	Average	160	292	P
2	5150.00	4.73	59.26	63.99	74.00	-10.01	Peak	160	292	P
3	5350.00	5.07	46.24	51.31	54.00	-2.69	Average	160	292	P
4	5350.00	5.07	58.97	64.04	74.00	-9.96	Peak	160	292	P
5	10440.00	11.55	45.54	57.09	68.20	-11.11	Peak	100	259	P
6	15660.00	13.72	34.13	47.85	54.00	-6.15	Average	183	331	P
7	15660.00	13.72	47.82	61.54	74.00	-12.46	Peak	183	331	P

Note: Level=Reading+Factor
 Margin=Level-Limit
 Factor=Antenna Factor + cable loss - Amplifier Factor



Power	: AC 120V / 60Hz	Pol/Phase	: HORIZONTAL
Test Mode	: Mode 2, Band 1, CH44		:

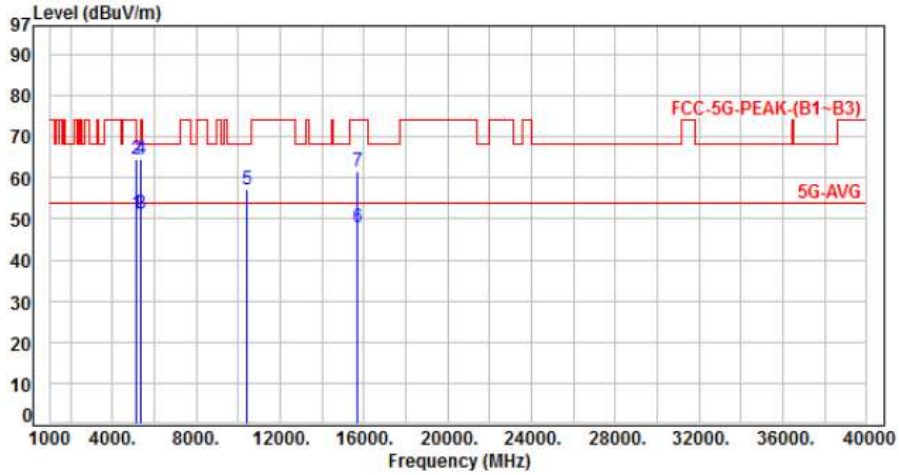

No.	Frequency (MHz)	Factor (dB)	Reading (dBuV)	Level (dBuV/m)	Limit (dBuV/m)	Margin (dB)	Detector	Height (cm)	Azimuth (deg)	P/F
1	5150.00	4.73	46.43	51.16	54.00	-2.84	Average	121	1	P
2	5150.00	4.73	59.72	64.45	74.00	-9.55	Peak	121	1	P
3	5350.00	5.07	46.38	51.45	54.00	-2.55	Average	121	1	P
4	5350.00	5.07	59.65	64.72	74.00	-9.28	Peak	121	1	P
5	10440.00	11.55	45.63	57.18	68.20	-11.02	Peak	100	189	P
6	15660.00	13.72	34.31	48.03	54.00	-5.97	Average	100	171	P
7	15660.00	13.72	47.98	61.70	74.00	-12.30	Peak	100	171	P

Note: Level=Reading+Factor
Margin=Level-Limit
Factor=Antenna Factor + cable loss - Amplifier Factor



Power	: AC 120V / 60Hz	Pol/Phase	: VERTICAL
Test Mode	: Mode 2, Band 1, CH48		:

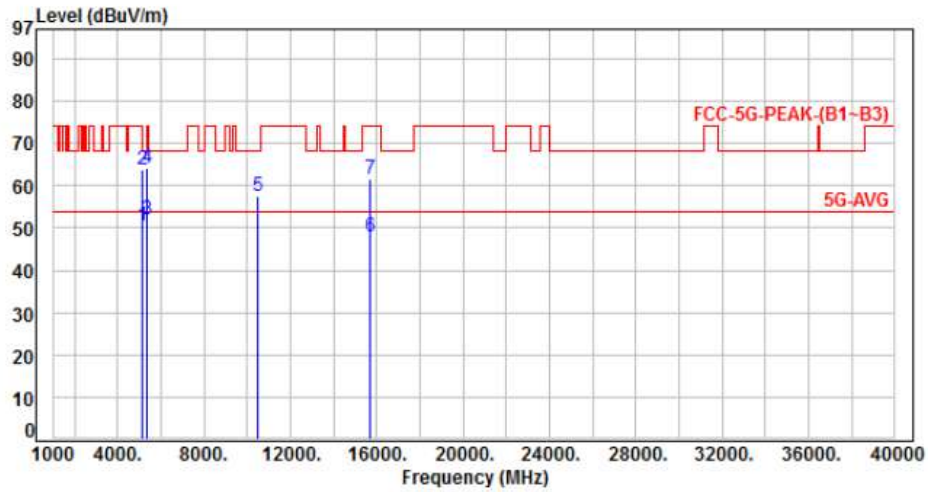

No.	Frequency (MHz)	Factor (dB)	Reading (dBuV)	Level (dBuV/m)	Limit (dBuV/m)	Margin (dB)	Detector	Height (cm)	Azimuth (deg)	P/F
1	5150.00	4.73	45.97	50.70	54.00	-3.30	Average	163	66	P
2	5150.00	4.73	58.92	63.65	74.00	-10.35	Peak	163	66	P
3	5350.00	5.07	46.91	51.98	54.00	-2.02	Average	163	66	P
4	5350.00	5.07	59.04	64.11	74.00	-9.89	Peak	163	66	P
5	10480.00	11.65	45.92	57.57	68.20	-10.63	Peak	100	206	P
6	15720.00	13.60	34.26	47.86	54.00	-6.14	Average	174	206	P
7	15720.00	13.60	47.88	61.48	74.00	-12.52	Peak	174	206	P

Note: Level=Reading+Factor
 Margin=Level-Limit
 Factor=Antenna Factor + cable loss - Amplifier Factor



Power	: AC 120V / 60Hz	Pol/Phase	: HORIZONTAL
Test Mode	: Mode 2, Band 1, CH48		:

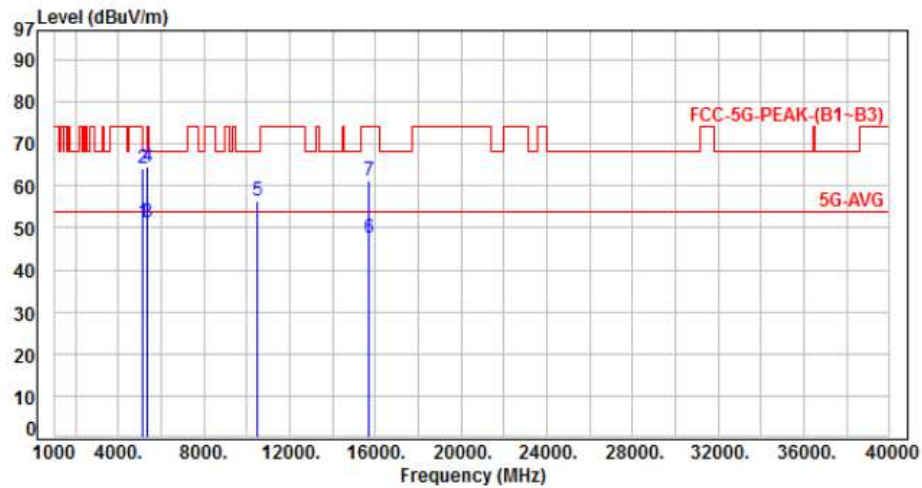

No.	Frequency (MHz)	Factor (dB)	Reading (dBuV)	Level (dBuV/m)	Limit (dBuV/m)	Margin (dB)	Detector	Height (cm)	Azimuth (deg)	P/F
1	5150.00	4.73	46.48	51.21	54.00	-2.79	Average	105	2	P
2	5150.00	4.73	59.61	64.34	74.00	-9.66	Peak	105	2	P
3	5350.00	5.07	46.38	51.45	54.00	-2.55	Average	105	2	P
4	5350.00	5.07	59.55	64.62	74.00	-9.38	Peak	105	2	P
5	10480.00	11.65	44.85	56.50	68.20	-11.70	Peak	100	162	P
6	15720.00	13.60	34.11	47.71	54.00	-6.29	Average	100	138	P
7	15720.00	13.60	47.65	61.25	74.00	-12.75	Peak	100	138	P

Note: Level=Reading+Factor
Margin=Level-Limit
Factor=Antenna Factor + cable loss - Amplifier Factor



Power	: AC 120V / 60Hz	Pol/Phase	: VERTICAL
Test Mode	: Mode 3, Band 1, CH38		:

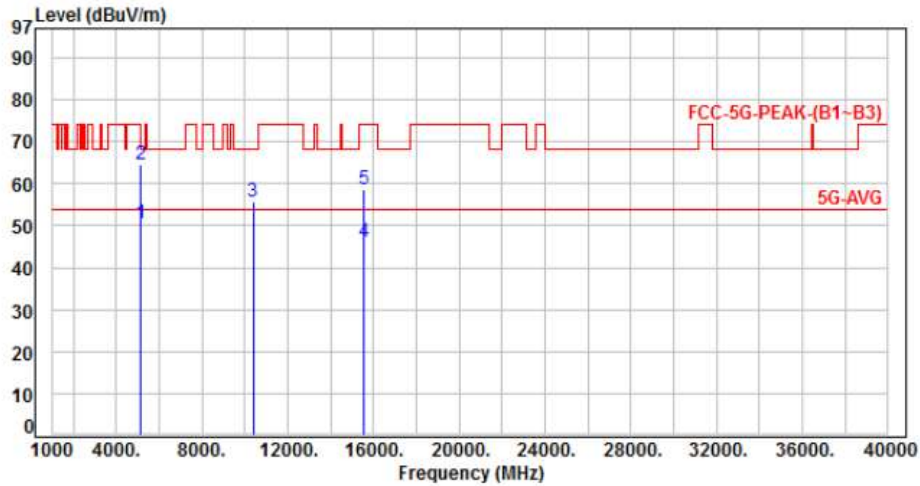

No.	Frequency (MHz)	Factor (dB)	Reading (dBuV)	Level (dBuV/m)	Limit (dBuV/m)	Margin (dB)	Detector	Height (cm)	Azimuth (deg)	P/F
1	5150.00	4.73	45.95	50.68	54.00	-3.32	Average	205	211	P
2	5150.00	4.73	59.64	64.37	74.00	-9.63	Peak	205	211	P
3	10380.00	11.44	44.16	55.60	68.20	-12.60	Peak	100	302	P
4	15570.00	14.07	32.09	46.16	54.00	-7.84	Average	219	42	P
5	15570.00	14.07	44.76	58.83	74.00	-15.17	Peak	219	42	P

Note: Level=Reading+Factor
 Margin=Level-Limit
 Factor=Antenna Factor + cable loss - Amplifier Factor



Power	: AC 120V / 60Hz	Pol/Phase	: HORIZONTAL
Test Mode	: Mode 3, Band 1, CH38		:

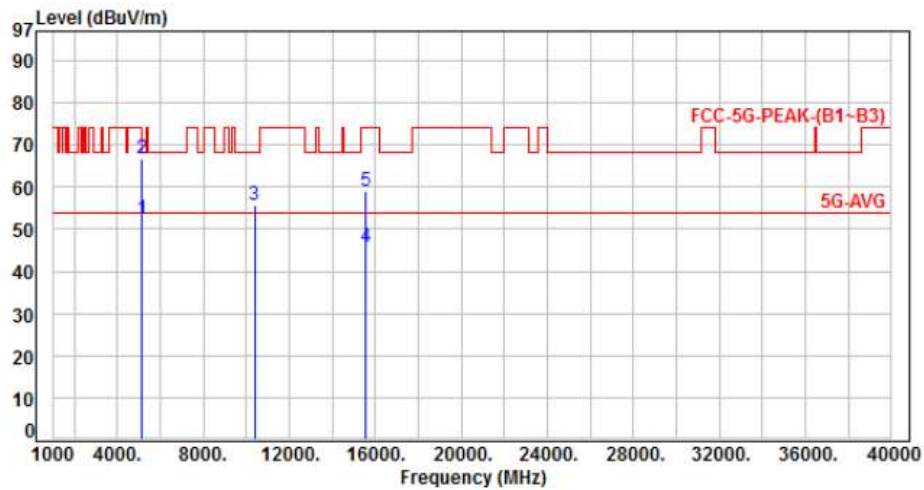

No.	Frequency (MHz)	Factor (dB)	Reading (dBuV)	Level (dBuV/m)	Limit (dBuV/m)	Margin (dB)	Detector	Height (cm)	Azimuth (deg)	P/F
1	5150.00	4.73	47.80	52.53	54.00	-1.47	Average	220	0	P
2	5150.00	4.73	61.98	66.71	74.00	-7.29	Peak	220	0	P
3	10380.00	11.44	44.25	55.69	68.20	-12.51	Peak	100	322	P
4	15570.00	14.07	31.70	45.77	54.00	-8.23	Average	152	355	P
5	15570.00	14.07	44.99	59.06	74.00	-14.94	Peak	152	355	P

Note: Level=Reading+Factor
Margin=Level-Limit
Factor=Antenna Factor + cable loss - Amplifier Factor



Power	: AC 120V / 60Hz	Pol/Phase	: VERTICAL
Test Mode	: Mode 3, Band 1, CH46		:

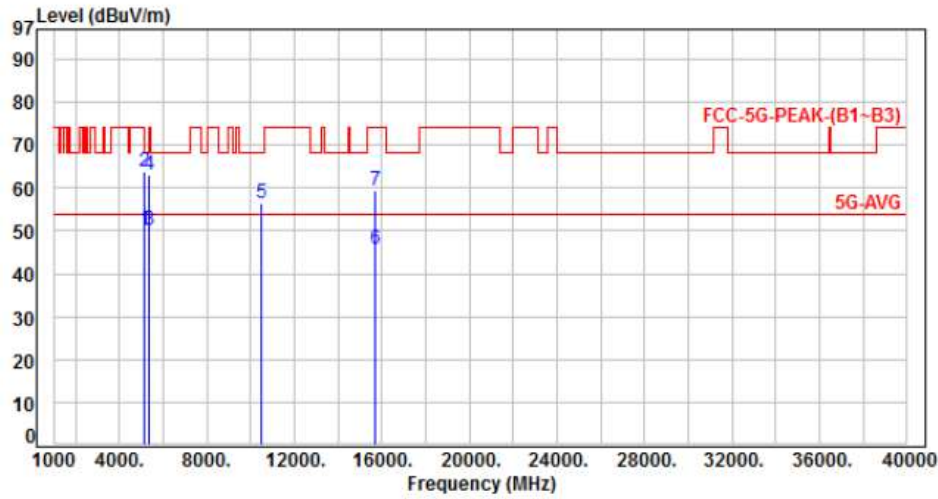

No.	Frequency (MHz)	Factor (dB)	Reading (dBuV)	Level (dBuV/m)	Limit (dBuV/m)	Margin (dB)	Detector	Height (cm)	Azimuth (deg)	P/F
1	5150.00	4.73	45.48	50.21	54.00	-3.79	Average	145	262	P
2	5150.00	4.73	59.12	63.85	74.00	-10.15	Peak	145	262	P
3	5350.00	5.07	45.25	50.32	54.00	-3.68	Average	145	262	P
4	5350.00	5.07	58.10	63.17	74.00	-10.83	Peak	145	262	P
5	10460.00	11.60	44.85	56.45	68.20	-11.75	Peak	100	318	P
6	15690.00	13.64	32.22	45.86	54.00	-8.14	Average	235	16	P
7	15690.00	13.64	45.77	59.41	74.00	-14.59	Peak	235	16	P

Note: Level=Reading+Factor
 Margin=Level-Limit
 Factor=Antenna Factor + cable loss - Amplifier Factor



Power	: AC 120V / 60Hz	Pol/Phase	: HORIZONTAL
Test Mode	: Mode 3, Band 1, CH46		:

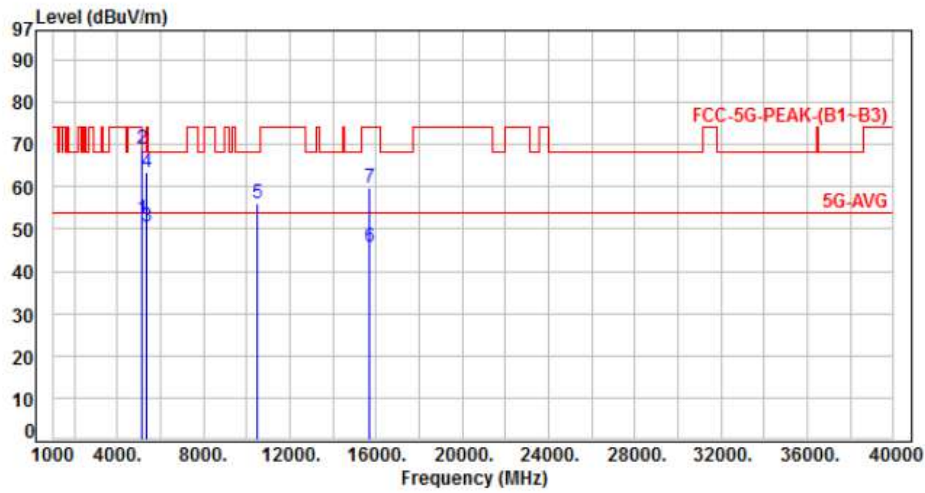

No.	Frequency (MHz)	Factor (dB)	Reading (dBuV)	Level (dBuV/m)	Limit (dBuV/m)	Margin (dB)	Detector	Height (cm)	Azimuth (deg)	P/F
1	5150.00	4.73	47.72	52.45	54.00	-1.55	Average	228	0	P
2	5150.00	4.73	64.11	68.84	74.00	-5.16	Peak	228	0	P
3	5350.00	5.07	45.37	50.44	54.00	-3.56	Average	228	0	P
4	5350.00	5.07	58.48	63.55	74.00	-10.45	Peak	228	0	P
5	10460.00	11.60	44.34	55.94	68.20	-12.26	Peak	100	346	P
6	15690.00	13.64	32.20	45.84	54.00	-8.16	Average	165	342	P
7	15690.00	13.64	45.95	59.59	74.00	-14.41	Peak	165	342	P

Note: Level=Reading+Factor
 Margin=Level-Limit
 Factor=Antenna Factor + cable loss - Amplifier Factor



Power	: AC 120V / 60Hz	Pol/Phase	: VERTICAL
Test Mode	: Mode 4, Band 1, CH42		:

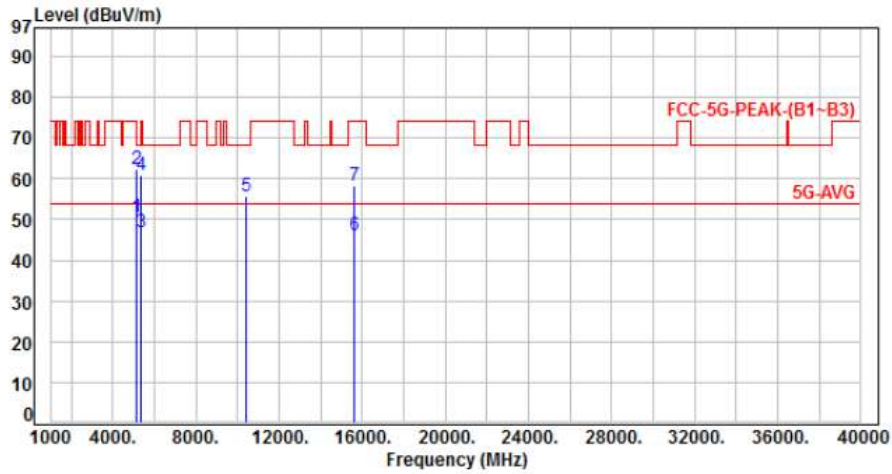

No.	Frequency (MHz)	Factor (dB)	Reading (dBuV)	Level (dBuV/m)	Limit (dBuV/m)	Margin (dB)	Detector	Height (cm)	Azimuth (deg)	P/F
1	5150.00	4.73	45.70	50.43	54.00	-3.57	Average	152	260	P
2	5150.00	4.73	57.56	62.29	74.00	-11.71	Peak	152	260	P
3	5350.00	5.07	41.87	46.94	54.00	-7.06	Average	152	260	P
4	5350.00	5.07	55.72	60.79	74.00	-13.21	Peak	152	260	P
5	10420.00	11.49	44.27	55.76	68.20	-12.44	Peak	100	274	P
6	15630.00	13.80	32.26	46.06	54.00	-7.94	Average	223	102	P
7	15630.00	13.80	44.52	58.32	74.00	-15.68	Peak	223	102	P

Note: Level=Reading+Factor
 Margin=Level-Limit
 Factor=Antenna Factor + cable loss - Amplifier Factor



Power	: AC 120V / 60Hz	Pol/Phase	: HORIZONTAL
Test Mode	: Mode 4, Band 1, CH42		:

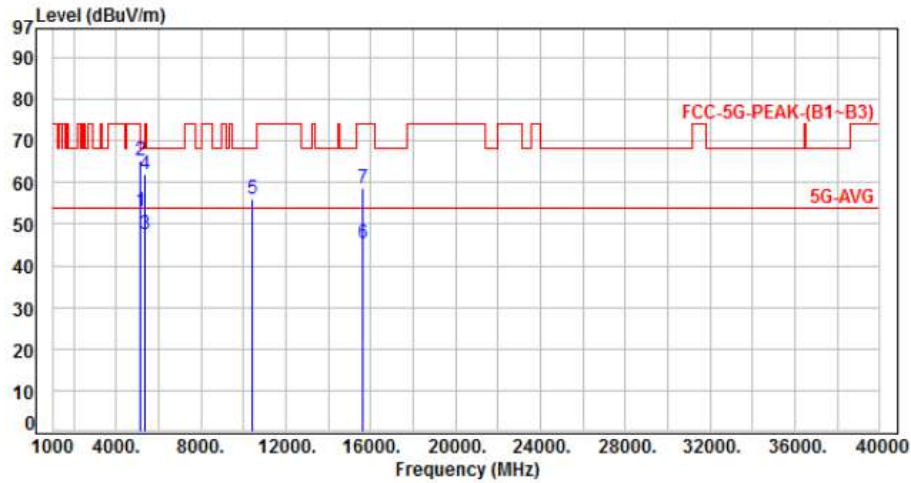

No.	Frequency (MHz)	Factor (dB)	Reading (dBuV)	Level (dBuV/m)	Limit (dBuV/m)	Margin (dB)	Detector	Height (cm)	Azimuth (deg)	P/F
1	5150.00	4.73	48.31	53.04	54.00	-0.96	Average	110	0	P
2	5150.00	4.73	60.55	65.28	74.00	-8.72	Peak	110	0	P
3	5350.00	5.07	42.40	47.47	54.00	-6.53	Average	110	0	P
4	5350.00	5.07	56.95	62.02	74.00	-11.98	Peak	110	0	P
5	10420.00	11.49	44.49	55.98	68.20	-12.22	Peak	100	286	P
6	15630.00	13.80	31.56	45.36	54.00	-8.64	Average	162	347	P
7	15630.00	13.80	44.72	58.52	74.00	-15.48	Peak	162	347	P

Note: Level=Reading+Factor
 Margin=Level-Limit
 Factor=Antenna Factor + cable loss - Amplifier Factor



Power	: AC 120V / 60Hz	Pol/Phase	: VERTICAL
Test Mode	: Mode 1, Band 4, CH149		:

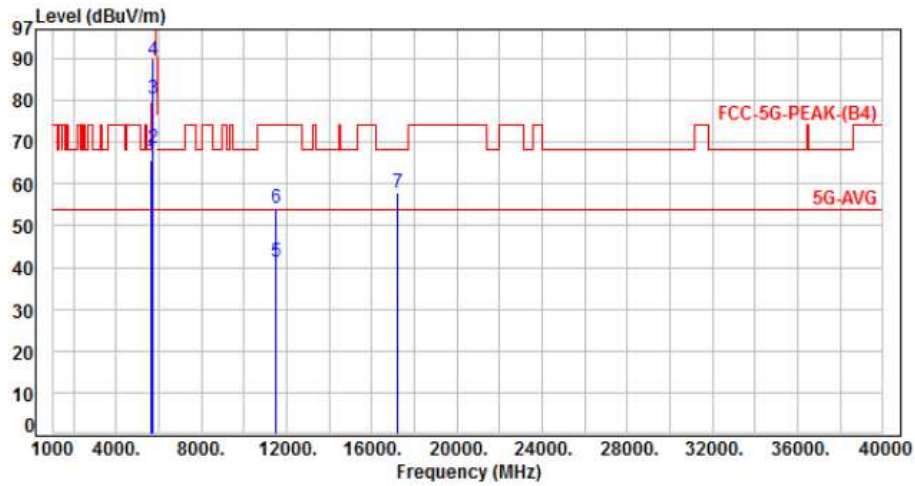

No.	Frequency (MHz)	Factor (dB)	Reading (dBuV)	Level (dBuV/m)	Limit (dBuV/m)	Margin (dB)	Detector	Height (cm)	Azimuth (deg)	P/F
1	5650.00	-11.01	76.50	65.49	68.20	-2.71	Peak	100	300	P
2	5700.00	-11.12	79.84	68.72	105.20	-36.48	Peak	100	300	P
3	5720.00	-11.13	91.43	80.30	110.80	-30.50	Peak	100	300	P
4	5725.00	-11.13	100.72	89.59	122.20	-32.61	Peak	100	300	P
5	11490.00	-4.06	45.29	41.23	54.00	-12.77	Average	100	156	P
6	11490.00	-4.06	58.45	54.39	74.00	-19.61	Peak	100	156	P
7	17235.00	4.76	53.02	57.78	68.20	-10.42	Peak	100	315	P

Note: Level=Reading+Factor
 Margin=Level-Limit
 Factor=Antenna Factor + cable loss - Amplifier Factor



Power	: AC 120V / 60Hz	Pol/Phase	: HORIZONTAL
Test Mode	: Mode 1, Band 4, CH149		:

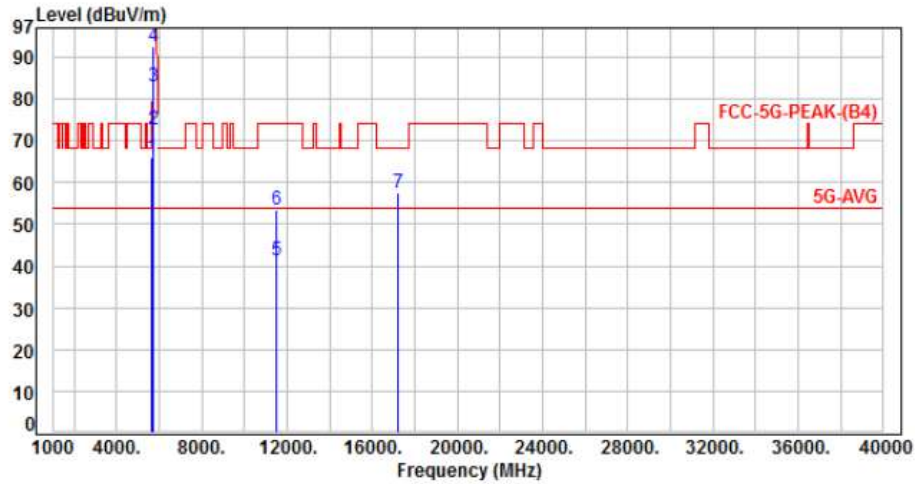

No.	Frequency (MHz)	Factor (dB)	Reading (dBuV)	Level (dBuV/m)	Limit (dBuV/m)	Margin (dB)	Detector	Height (cm)	Azimuth (deg)	P/F
1	5650.00	-11.01	76.93	65.92	68.20	-2.28	Peak	100	0	P
2	5700.00	-11.12	83.68	72.56	105.20	-32.64	Peak	100	0	P
3	5720.00	-11.13	94.24	83.11	110.80	-27.69	Peak	100	0	P
4	5725.00	-11.13	103.88	92.75	122.20	-29.45	Peak	100	0	P
5	11490.00	-4.06	45.45	41.39	54.00	-12.61	Average	100	269	P
6	11490.00	-4.06	57.68	53.62	74.00	-20.38	Peak	100	269	P
7	17235.00	4.76	52.73	57.49	68.20	-10.71	Peak	146	25	P

Note: Level=Reading+Factor
Margin=Level-Limit
Factor=Antenna Factor + cable loss - Amplifier Factor



Power	: AC 120V / 60Hz	Pol/Phase	: VERTICAL
Test Mode	: Mode 1, Band 4, CH157		

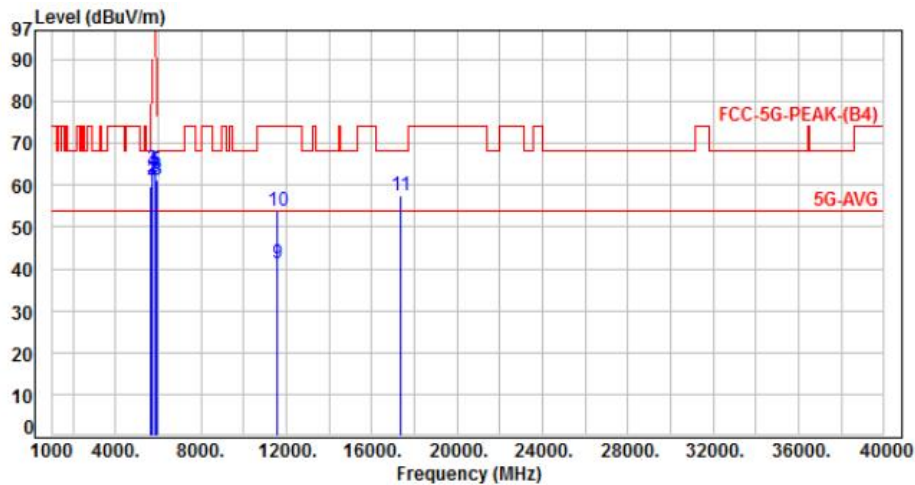

No.	Frequency (MHz)	Factor (dB)	Reading (dBuV)	Level (dBuV/m)	Limit (dBuV/m)	Margin (dB)	Detector	Height (cm)	Azimuth (deg)	P/F
1	5650.00	-11.01	70.67	59.66	68.20	-8.54	Peak	130	260	P
2	5700.00	-11.12	72.23	61.11	105.20	-44.09	Peak	130	260	P
3	5720.00	-11.13	74.84	63.71	110.80	-47.09	Peak	130	260	P
4	5725.00	-11.13	74.69	63.56	122.20	-58.64	Peak	130	260	P
5	5850.00	-11.05	74.31	63.26	122.20	-58.94	Peak	130	260	P
6	5855.00	-11.03	73.05	62.02	110.80	-48.78	Peak	130	260	P
7	5875.00	-10.96	72.83	61.87	105.20	-43.33	Peak	130	260	P
8	5925.00	-10.87	71.92	61.05	68.20	-7.15	Peak	130	260	P
9	11570.00	-3.75	45.13	41.38	54.00	-12.62	Average	100	137	P
10	11570.00	-3.75	57.76	54.01	74.00	-19.99	Peak	100	137	P
11	17355.00	5.45	52.08	57.53	68.20	-10.67	Peak	100	360	P

Note: Level=Reading+Factor
 Margin=Level-Limit
 Factor=Antenna Factor + cable loss - Amplifier Factor



Power	: AC 120V / 60Hz	Pol/Phase	: HORIZONTAL
Test Mode	: Mode 1, Band 4, CH157		:

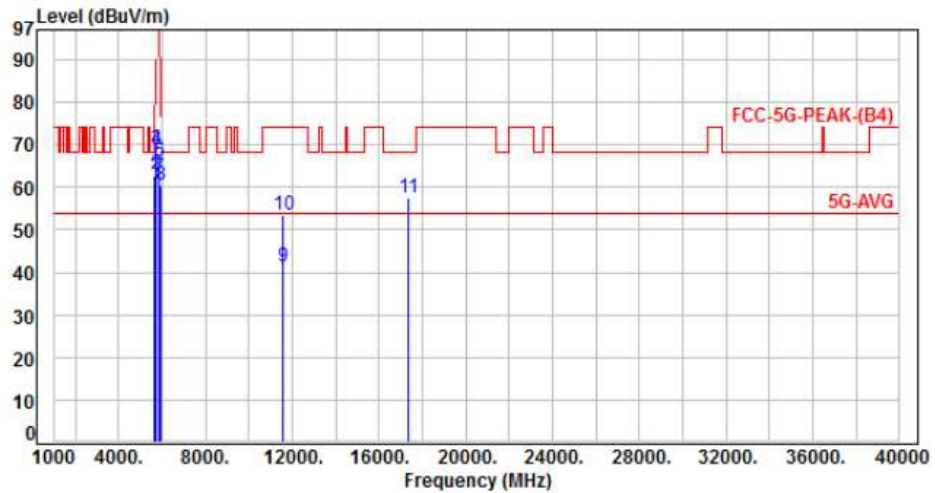

No.	Frequency (MHz)	Factor (dB)	Reading (dBuV)	Level (dBuV/m)	Limit (dBuV/m)	Margin (dB)	Detector	Height (cm)	Azimuth (deg)	P/F
1	5650.00	-11.01	73.65	62.64	68.20	-5.56	Peak	190	0	P
2	5700.00	-11.12	74.11	62.99	105.20	-42.21	Peak	190	0	P
3	5720.00	-11.13	79.99	68.86	110.80	-41.94	Peak	190	0	P
4	5725.00	-11.13	80.18	69.05	122.20	-53.15	Peak	190	0	P
5	5850.00	-11.05	77.12	66.07	122.20	-56.13	Peak	190	0	P
6	5855.00	-11.03	76.91	65.88	110.80	-44.92	Peak	190	0	P
7	5875.00	-10.96	73.11	62.15	105.20	-43.05	Peak	190	0	P
8	5925.00	-10.87	71.30	60.43	68.20	-7.77	Peak	190	0	P
9	11570.00	-3.75	44.97	41.22	54.00	-12.78	Average	100	245	P
10	11570.00	-3.75	57.22	53.47	74.00	-20.53	Peak	100	245	P
11	17355.00	5.45	52.16	57.61	68.20	-10.59	Peak	165	0	P

Note: Level=Reading+Factor
 Margin=Level-Limit
 Factor=Antenna Factor + cable loss - Amplifier Factor



Power	: AC 120V / 60Hz	Pol/Phase	: VERTICAL
Test Mode	: Mode 1, Band 4, CH165		:

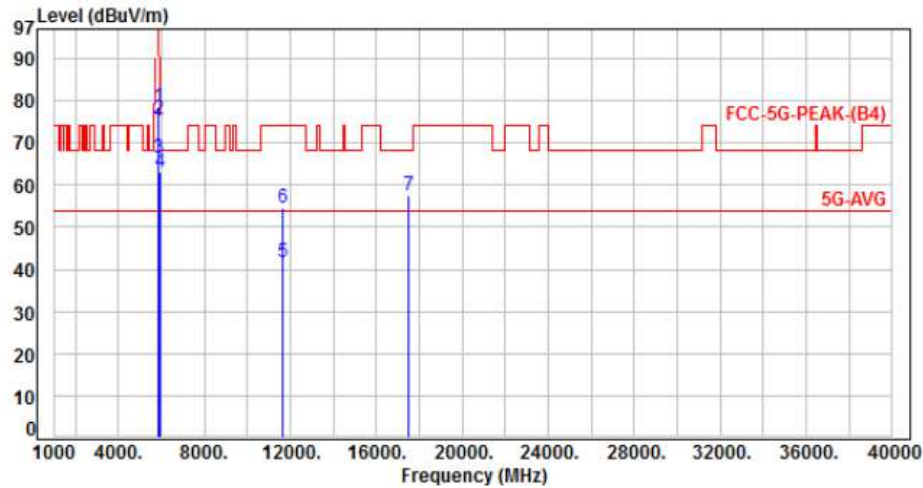

No.	Frequency (MHz)	Factor (dB)	Reading (dBuV)	Level (dBuV/m)	Limit (dBuV/m)	Margin (dB)	Detector	Height (cm)	Azimuth (deg)	P/F
1	5850.00	-11.05	89.52	78.47	122.20	-43.73	Peak	100	265	P
2	5855.00	-11.03	86.75	75.72	110.80	-35.08	Peak	100	265	P
3	5875.00	-10.96	77.18	66.22	105.20	-38.98	Peak	100	265	P
4	5925.00	-10.87	74.10	63.23	68.20	-4.97	Peak	100	265	P
5	11650.00	-3.57	45.23	41.66	54.00	-12.34	Average	100	171	P
6	11650.00	-3.57	58.16	54.59	74.00	-19.41	Peak	100	171	P
7	17475.00	6.36	51.29	57.65	68.20	-10.55	Peak	100	339	P

Note: Level=Reading+Factor
 Margin=Level-Limit
 Factor=Antenna Factor + cable loss - Amplifier Factor



Power	: AC 120V / 60Hz	Pol/Phase	: HORIZONTAL
Test Mode	: Mode 1, Band 4, CH165		:

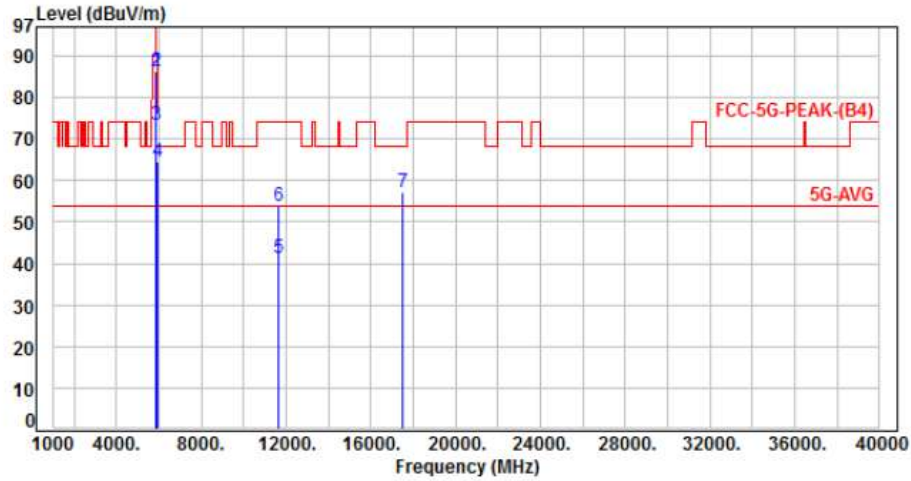

No.	Frequency (MHz)	Factor (dB)	Reading (dBuV)	Level (dBuV/m)	Limit (dBuV/m)	Margin (dB)	Detector	Height (cm)	Azimuth (deg)	P/F
1	5850.00	-11.05	97.54	86.49	122.20	-35.71	Peak	100	5	P
2	5855.00	-11.03	97.22	86.19	110.80	-24.61	Peak	100	5	P
3	5875.00	-10.96	84.47	73.51	105.20	-31.69	Peak	100	5	P
4	5925.00	-10.87	75.55	64.68	68.20	-3.52	Peak	100	5	P
5	11650.00	-3.57	44.85	41.28	54.00	-12.72	Average	100	258	P
6	11650.00	-3.57	57.34	53.77	74.00	-20.23	Peak	100	258	P
7	17475.00	6.36	50.93	57.29	68.20	-10.91	Peak	138	18	P

Note: Level=Reading+Factor
 Margin=Level-Limit
 Factor=Antenna Factor + cable loss - Amplifier Factor



Power	: AC 120V / 60Hz	Pol/Phase	: VERTICAL
Test Mode	: Mode 2, Band 4, CH149		:

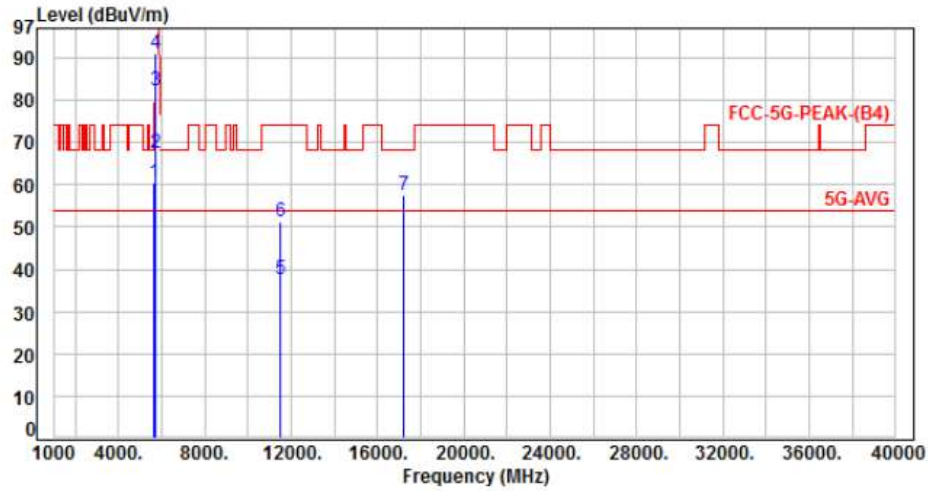

No.	Frequency (MHz)	Factor (dB)	Reading (dBuV)	Level (dBuV/m)	Limit (dBuV/m)	Margin (dB)	Detector	Height (cm)	Azimuth (deg)	P/F
1	5650.00	-11.01	71.51	60.50	68.20	-7.70	Peak	100	95	P
2	5700.00	-11.12	78.53	67.41	105.20	-37.79	Peak	100	95	P
3	5720.00	-11.13	93.42	82.29	110.80	-28.51	Peak	100	95	P
4	5725.00	-11.13	102.18	91.05	122.20	-31.15	Peak	100	95	P
5	11490.00	-4.06	41.61	37.55	54.00	-16.45	Average	100	157	P
6	11490.00	-4.06	55.43	51.37	74.00	-22.63	Peak	100	157	P
7	17235.00	4.76	52.87	57.63	68.20	-10.57	Peak	100	120	P

Note: Level=Reading+Factor
Margin=Level-Limit
Factor=Antenna Factor + cable loss - Amplifier Factor



Power	: AC 120V / 60Hz	Pol/Phase	: HORIZONTAL
Test Mode	: Mode 2, Band 4, CH149		:

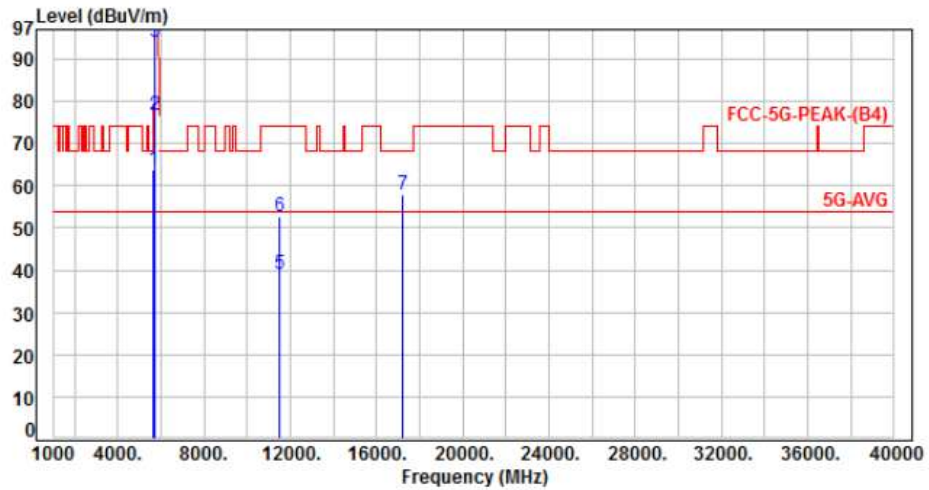

No.	Frequency (MHz)	Factor (dB)	Reading (dBuV)	Level (dBuV/m)	Limit (dBuV/m)	Margin (dB)	Detector	Height (cm)	Azimuth (deg)	P/F
1	5650.00	-11.01	74.91	63.90	68.20	-4.30	Peak	100	0	P
2	5700.00	-11.12	87.93	76.81	105.20	-28.39	Peak	100	0	P
3	5720.00	-11.13	105.03	93.90	110.80	-16.90	Peak	100	0	P
4	5725.00	-11.13	110.14	99.01	122.20	-23.19	Peak	100	0	P
5	11490.00	-4.06	43.25	39.19	54.00	-14.81	Average	100	250	P
6	11490.00	-4.06	56.84	52.78	74.00	-21.22	Peak	100	250	P
7	17235.00	4.76	53.13	57.89	68.20	-10.31	Peak	100	30	P

Note: Level=Reading+Factor
 Margin=Level-Limit
 Factor=Antenna Factor + cable loss - Amplifier Factor



Power	: AC 120V / 60Hz	Pol/Phase	: VERTICAL
Test Mode	: Mode 2, Band 4, CH157		:

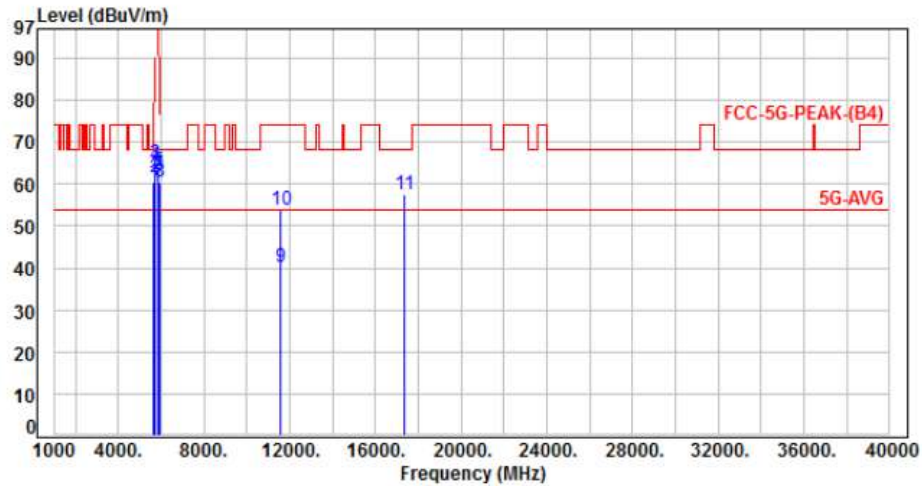

No.	Frequency (MHz)	Factor (dB)	Reading (dBuV)	Level (dBuV/m)	Limit (dBuV/m)	Margin (dB)	Detector	Height (cm)	Azimuth (deg)	P/F
1	5650.00	-11.01	71.61	60.60	68.20	-7.60	Peak	100	295	P
2	5700.00	-11.12	72.87	61.75	105.20	-43.45	Peak	100	295	P
3	5720.00	-11.13	75.94	64.81	110.80	-45.99	Peak	100	295	P
4	5725.00	-11.13	75.71	64.58	122.20	-57.62	Peak	100	295	P
5	5850.00	-11.05	74.10	63.05	122.20	-59.15	Peak	100	295	P
6	5855.00	-11.03	73.42	62.39	110.80	-48.41	Peak	100	295	P
7	5875.00	-10.96	73.19	62.23	105.20	-42.97	Peak	100	295	P
8	5925.00	-10.87	71.34	60.47	68.20	-7.73	Peak	100	295	P
9	11570.00	-3.75	44.00	40.25	54.00	-13.75	Average	100	292	P
10	11570.00	-3.75	57.55	53.80	74.00	-20.20	Peak	100	292	P
11	17355.00	5.45	52.06	57.51	68.20	-10.69	Peak	100	150	P

Note: Level=Reading+Factor
 Margin=Level-Limit
 Factor=Antenna Factor + cable loss - Amplifier Factor



Power	: AC 120V / 60Hz	Pol/Phase	: HORIZONTAL
Test Mode	: Mode 2, Band 4, CH157		:

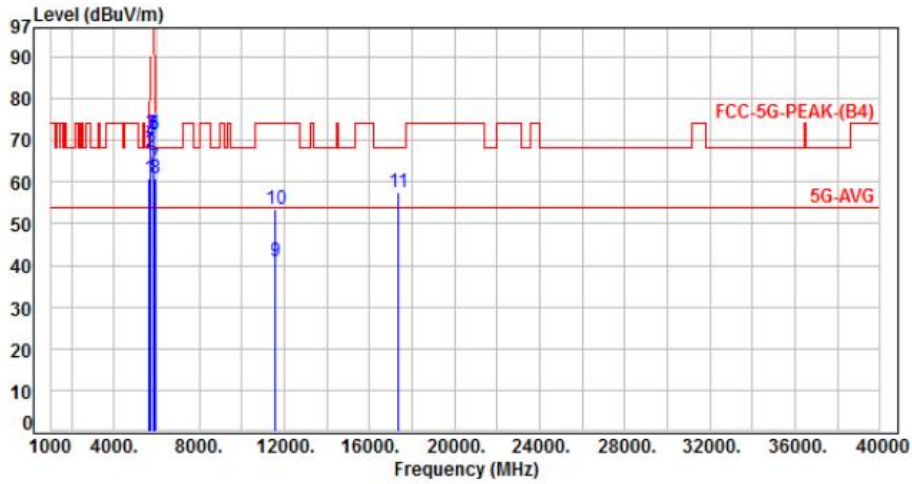

No.	Frequency (MHz)	Factor (dB)	Reading (dBUV)	Level (dBUV/m)	Limit (dBUV/m)	Margin (dB)	Detector	Height (cm)	Azimuth (deg)	P/F
1	5650.00	-11.01	71.71	60.70	68.20	-7.50	Peak	100	0	P
2	5700.00	-11.12	78.07	66.95	105.20	-38.25	Peak	100	0	P
3	5720.00	-11.13	82.65	71.52	110.80	-39.28	Peak	100	0	P
4	5725.00	-11.13	80.97	69.84	122.20	-52.36	Peak	100	0	P
5	5850.00	-11.05	82.77	71.72	122.20	-50.48	Peak	100	0	P
6	5855.00	-11.03	82.36	71.33	110.80	-39.47	Peak	100	0	P
7	5875.00	-10.96	74.41	63.45	105.20	-41.75	Peak	100	0	P
8	5925.00	-10.87	71.75	60.88	68.20	-7.32	Peak	100	0	P
9	11570.00	-3.75	44.54	40.79	54.00	-13.21	Average	100	247	P
10	11570.00	-3.75	57.38	53.63	74.00	-20.37	Peak	100	247	P
11	17355.00	5.45	52.27	57.72	68.20	-10.48	Peak	100	339	P

Note: Level=Reading+Factor
 Margin=Level-Limit
 Factor=Antenna Factor + cable loss - Amplifier Factor



Power	: AC 120V / 60Hz	Pol/Phase	: VERTICAL
Test Mode	: Mode 2, Band 4, CH165		:

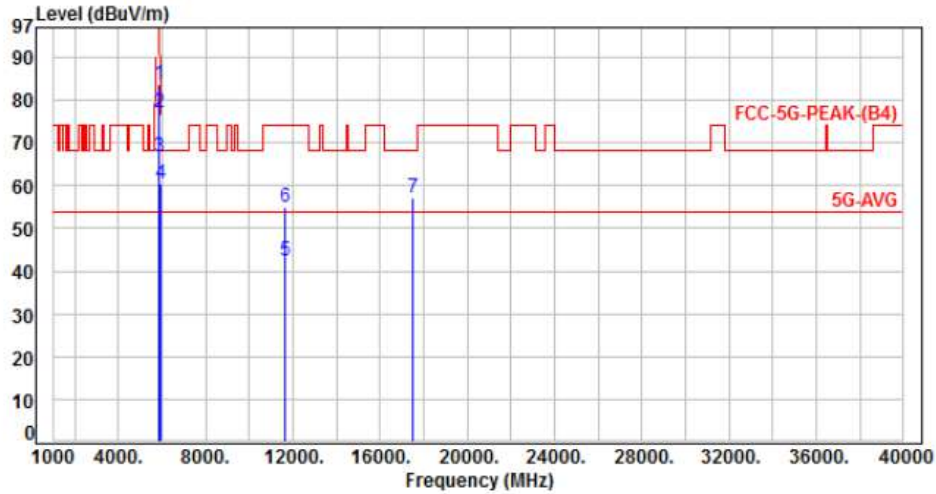

No.	Frequency (MHz)	Factor (dB)	Reading (dBuV)	Level (dBuV/m)	Limit (dBuV/m)	Margin (dB)	Detector	Height (cm)	Azimuth (deg)	P/F
1	5850.00	-11.05	94.60	83.55	122.20	-38.65	Peak	100	50	P
2	5855.00	-11.03	88.00	76.97	110.80	-33.83	Peak	100	50	P
3	5875.00	-10.96	77.76	66.80	105.20	-38.40	Peak	100	50	P
4	5925.00	-10.87	71.38	60.51	68.20	-7.69	Peak	100	50	P
5	11650.00	-3.57	46.02	42.45	54.00	-11.55	Average	100	355	P
6	11650.00	-3.57	58.44	54.87	74.00	-19.13	Peak	100	355	P
7	17475.00	6.36	50.84	57.20	68.20	-11.00	Peak	100	270	P

Note: Level=Reading+Factor
 Margin=Level-Limit
 Factor=Antenna Factor + cable loss - Amplifier Factor



Power	: AC 120V / 60Hz	Pol/Phase	: HORIZONTAL
Test Mode	: Mode 2, Band 4, CH165		:

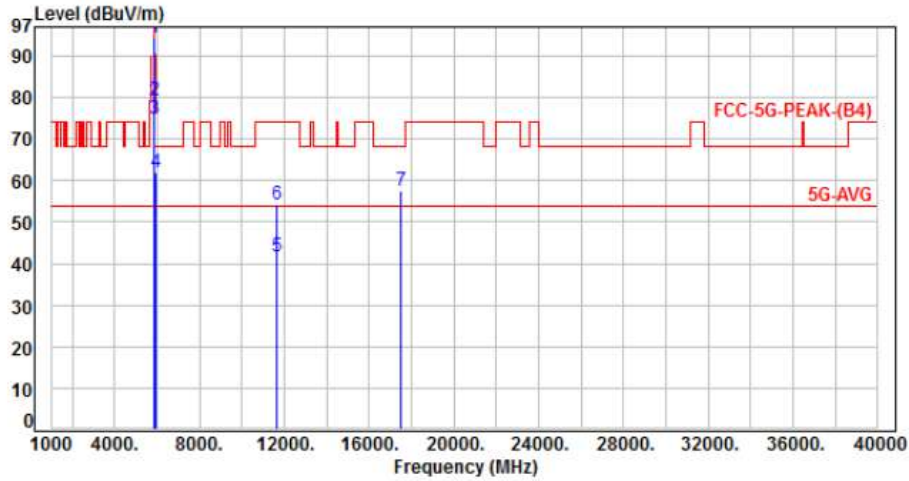

No.	Frequency (MHz)	Factor (dB)	Reading (dBuV)	Level (dBuV/m)	Limit (dBuV/m)	Margin (dB)	Detector	Height (cm)	Azimuth (deg)	P/F
1	5850.00	-11.05	105.38	94.33	122.20	-27.87	Peak	205	0	P
2	5855.00	-11.03	90.39	79.36	110.80	-31.44	Peak	205	0	P
3	5875.00	-10.96	85.77	74.81	105.20	-30.39	Peak	205	0	P
4	5925.00	-10.87	72.73	61.86	68.20	-6.34	Peak	205	0	P
5	11650.00	-3.57	45.41	41.84	54.00	-12.16	Average	100	245	P
6	11650.00	-3.57	57.83	54.26	74.00	-19.74	Peak	100	245	P
7	17475.00	6.36	51.31	57.67	68.20	-10.53	Peak	100	360	P

Note: Level=Reading+Factor
 Margin=Level-Limit
 Factor=Antenna Factor + cable loss - Amplifier Factor



Power	: AC 120V / 60Hz	Pol/Phase	: VERTICAL
Test Mode	: Mode 3, Band 4, CH151		:

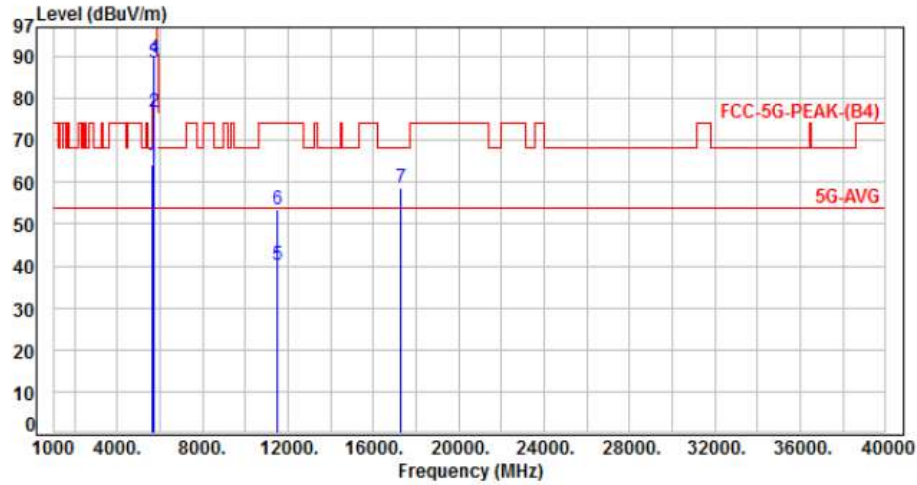

No.	Frequency (MHz)	Factor (dB)	Reading (dBuV)	Level (dBuV/m)	Limit (dBuV/m)	Margin (dB)	Detector	Height (cm)	Azimuth (deg)	P/F
1	5650.00	-11.01	75.19	64.18	68.20	-4.02	Peak	100	265	P
2	5700.00	-11.12	87.83	76.71	105.20	-28.49	Peak	100	265	P
3	5720.00	-11.13	99.51	88.38	110.80	-22.42	Peak	100	265	P
4	5725.00	-11.13	100.62	89.49	122.20	-32.71	Peak	100	265	P
5	11510.00	-4.01	44.16	40.15	54.00	-13.85	Average	100	142	P
6	11510.00	-4.01	57.47	53.46	74.00	-20.54	Peak	100	142	P
7	17265.00	4.91	53.59	58.50	68.20	-9.70	Peak	100	305	P

Note: Level=Reading+Factor
Margin=Level-Limit
Factor=Antenna Factor + cable loss - Amplifier Factor



Power	: AC 120V / 60Hz	Pol/Phase	: HORIZONTAL
Test Mode	: Mode 3, Band 4, CH151		:

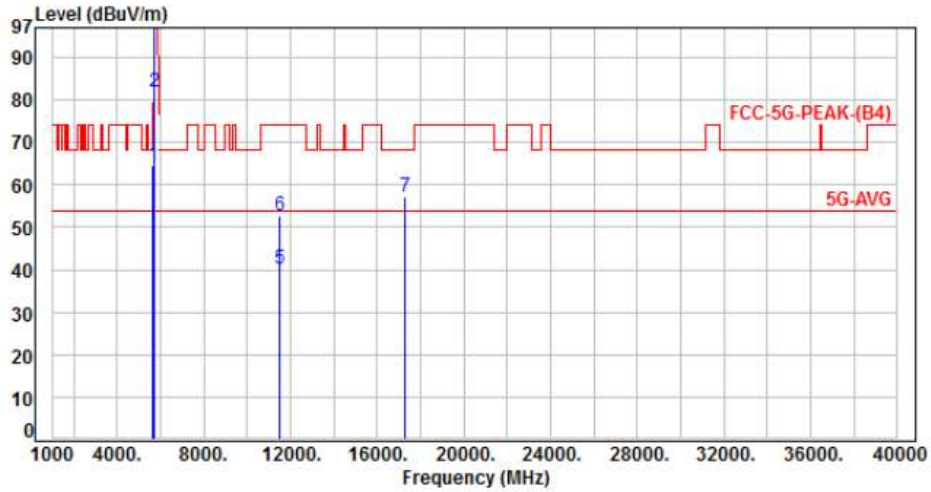

No.	Frequency (MHz)	Factor (dB)	Reading (dBuV)	Level (dBuV/m)	Limit (dBuV/m)	Margin (dB)	Detector	Height (cm)	Azimuth (deg)	P/F
1	5650.00	-11.01	75.73	64.72	68.20	-3.48	Peak	100	360	P
2	5700.00	-11.12	92.96	81.84	105.20	-23.36	Peak	100	360	P
3	5720.00	-11.13	107.09	95.96	110.80	-14.84	Peak	100	360	P
4	5725.00	-11.13	110.38	99.25	122.20	-22.95	Peak	100	360	P
5	11510.00	-4.01	44.30	40.29	54.00	-13.71	Average	100	275	P
6	11510.00	-4.01	56.64	52.63	74.00	-21.37	Peak	100	275	P
7	17265.00	4.91	52.22	57.13	68.20	-11.07	Peak	145	12	P

Note: Level=Reading+Factor
Margin=Level-Limit
Factor=Antenna Factor + cable loss - Amplifier Factor



Power	: AC 120V / 60Hz	Pol/Phase	: VERTICAL
Test Mode	: Mode 3, Band 4, CH159		:

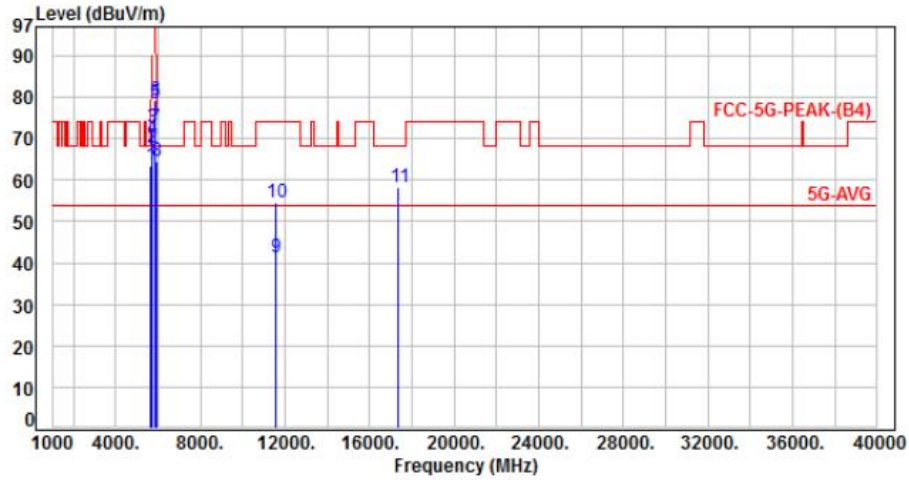

No.	Frequency (MHz)	Factor (dB)	Reading (dBuV)	Level (dBuV/m)	Limit (dBuV/m)	Margin (dB)	Detector	Height (cm)	Azimuth (deg)	P/F
1	5650.00	-11.01	74.32	63.31	68.20	-4.89	Peak	100	300	P
2	5700.00	-11.12	78.94	67.82	105.20	-37.38	Peak	100	300	P
3	5720.00	-11.13	83.75	72.62	110.80	-38.18	Peak	100	300	P
4	5725.00	-11.13	81.21	70.08	122.20	-52.12	Peak	100	300	P
5	5850.00	-11.05	89.44	78.39	122.20	-43.81	Peak	100	270	P
6	5855.00	-11.03	90.34	79.31	110.80	-31.49	Peak	100	270	P
7	5875.00	-10.96	83.44	72.48	105.20	-32.72	Peak	100	270	P
8	5925.00	-10.87	75.27	64.40	68.20	-3.80	Peak	100	270	P
9	11590.00	-3.67	45.03	41.36	54.00	-12.64	Average	100	251	P
10	11590.00	-3.67	58.35	54.68	74.00	-19.32	Peak	100	251	P
11	17385.00	5.66	52.75	58.41	68.20	-9.79	Peak	100	345	P

Note: Level=Reading+Factor
Margin=Level-Limit
Factor=Antenna Factor + cable loss - Amplifier Factor



Power	: AC 120V / 60Hz	Pol/Phase	: HORIZONTAL
Test Mode	: Mode 3, Band 4, CH159		:

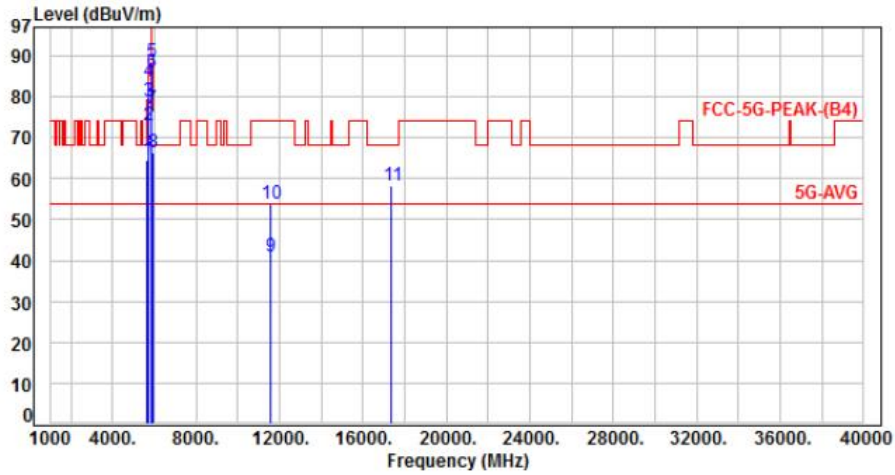

No.	Frequency (MHz)	Factor (dB)	Reading (dBuV)	Level (dBuV/m)	Limit (dBuV/m)	Margin (dB)	Detector	Height (cm)	Azimuth (deg)	P/F
1	5650.00	-11.01	75.49	64.48	68.20	-3.72	Peak	100	350	P
2	5700.00	-11.12	84.04	72.92	105.20	-32.28	Peak	100	350	P
3	5720.00	-11.13	90.04	78.91	110.80	-31.89	Peak	100	350	P
4	5725.00	-11.13	94.79	83.66	122.20	-38.54	Peak	100	350	P
5	5850.00	-11.05	99.40	88.35	122.20	-33.85	Peak	100	360	P
6	5855.00	-11.03	97.09	86.06	110.80	-24.74	Peak	100	360	P
7	5875.00	-10.96	88.19	77.23	105.20	-27.97	Peak	100	360	P
8	5925.00	-10.87	77.12	66.25	68.20	-1.95	Peak	100	360	P
9	11590.00	-3.67	44.79	41.12	54.00	-12.88	Average	100	261	P
10	11590.00	-3.67	57.55	53.88	74.00	-20.12	Peak	100	261	P
11	17385.00	5.66	52.64	58.30	68.20	-9.90	Peak	133	42	P

Note: Level=Reading+Factor
 Margin=Level-Limit
 Factor=Antenna Factor + cable loss - Amplifier Factor



Power	: AC 120V / 60Hz	Pol/Phase	: VERTICAL
Test Mode	: Mode 4, Band 4, CH155		:

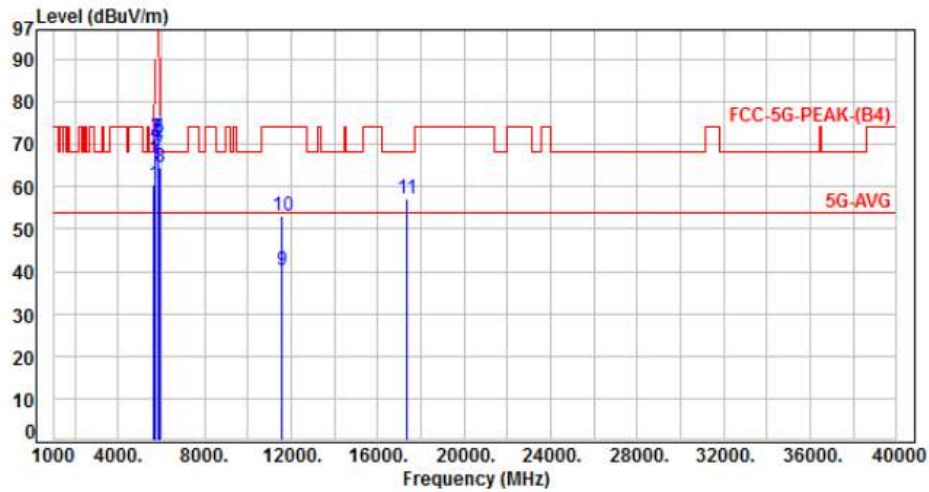

No.	Frequency (MHz)	Factor (dB)	Reading (dBuV)	Level (dBuV/m)	Limit (dBuV/m)	Margin (dB)	Detector	Height (cm)	Azimuth (deg)	P/F
1	5650.00	-11.01	71.50	60.49	68.20	-7.71	Peak	100	295	P
2	5700.00	-11.12	79.85	68.73	105.20	-36.47	Peak	100	295	P
3	5720.00	-11.13	82.64	71.51	110.80	-39.29	Peak	100	295	P
4	5725.00	-11.13	81.13	70.00	122.20	-52.20	Peak	100	295	P
5	5850.00	-11.05	82.77	71.72	122.20	-50.48	Peak	100	295	P
6	5855.00	-11.03	82.32	71.29	110.80	-39.51	Peak	100	295	P
7	5875.00	-10.96	78.40	67.44	105.20	-37.76	Peak	100	295	P
8	5925.00	-10.87	75.27	64.40	68.20	-3.80	Peak	100	295	P
9	11550.00	-3.84	44.10	40.26	54.00	-13.74	Average	100	206	P
10	11550.00	-3.84	57.00	53.16	74.00	-20.84	Peak	100	206	P
11	17325.00	5.25	52.10	57.35	68.20	-10.85	Peak	100	296	P

Note: Level=Reading+Factor
 Margin=Level-Limit
 Factor=Antenna Factor + cable loss - Amplifier Factor



Power	: AC 120V / 60Hz	Pol/Phase	: HORIZONTAL
Test Mode	: Mode 4, Band 4, CH155		:

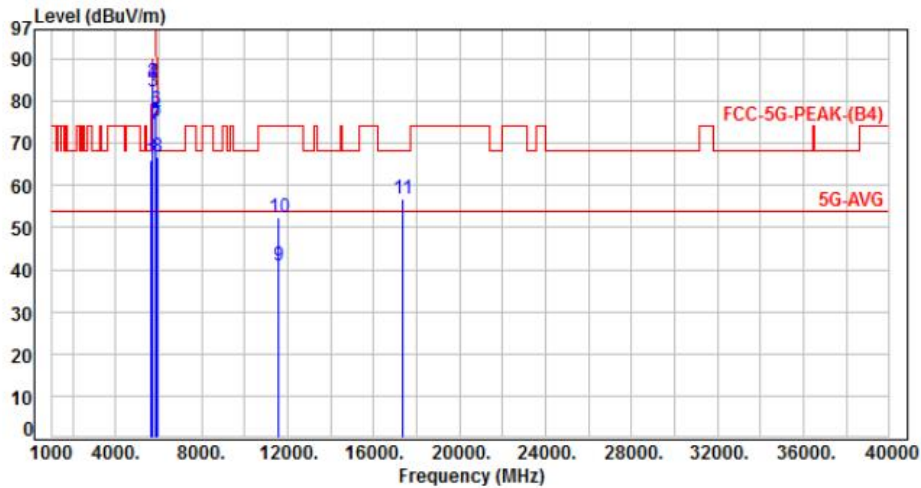

No.	Frequency (MHz)	Factor (dB)	Reading (dBuV)	Level (dBuV/m)	Limit (dBuV/m)	Margin (dB)	Detector	Height (cm)	Azimuth (deg)	P/F
1	5650.00	-11.01	76.85	65.84	68.20	-2.36	Peak	100	360	P
2	5700.00	-11.12	95.58	84.46	105.20	-20.74	Peak	100	360	P
3	5720.00	-11.13	93.36	82.23	110.80	-28.57	Peak	100	360	P
4	5725.00	-11.13	95.56	84.43	122.20	-37.77	Peak	100	360	P
5	5850.00	-11.05	86.12	75.07	122.20	-47.13	Peak	100	360	P
6	5855.00	-11.03	88.70	77.67	110.80	-33.13	Peak	100	360	P
7	5875.00	-10.96	85.33	74.37	105.20	-30.83	Peak	100	360	P
8	5925.00	-10.87	77.49	66.62	68.20	-1.58	Peak	100	360	P
9	11550.00	-3.84	44.63	40.79	54.00	-13.21	Average	100	296	P
10	11550.00	-3.84	56.10	52.26	74.00	-21.74	Peak	100	296	P
11	17325.00	5.25	51.62	56.87	68.20	-11.33	Peak	129	8	P

Note: Level=Reading+Factor
 Margin=Level-Limit
 Factor=Antenna Factor + cable loss - Amplifier Factor



Power	: AC 120V / 60Hz	Pol/Phase	: VERTICAL
Test Mode	: Mode 5, Band 1, CH36		

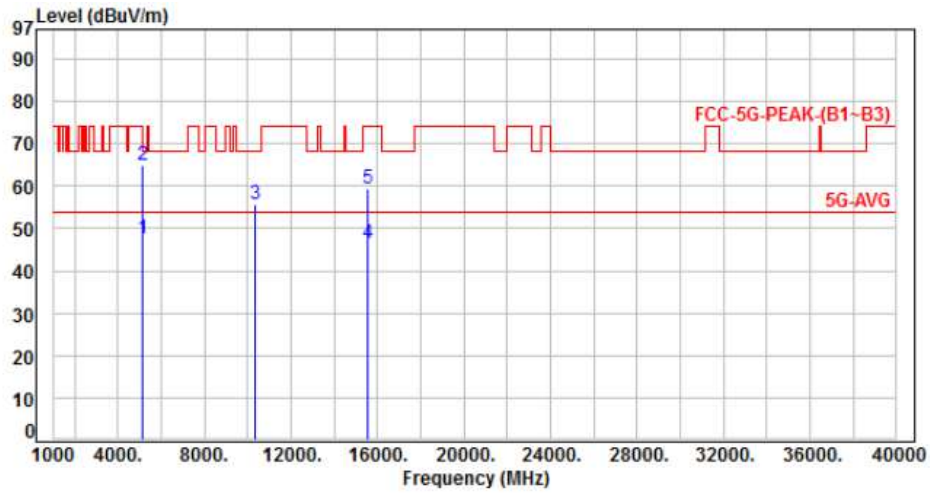

No.	Frequency (MHz)	Factor (dB)	Reading (dBuV)	Level (dBuV/m)	Limit (dBuV/m)	Margin (dB)	Detector	Height (cm)	Azimuth (deg)	P/F
1	5150.00	4.73	42.90	47.63	54.00	-6.37	Average	160	294	P
2	5150.00	4.73	60.31	65.04	74.00	-8.96	Peak	160	294	P
3	10360.00	11.43	44.14	55.57	68.20	-12.63	Peak	100	315	P
4	15540.00	14.27	32.39	46.66	54.00	-7.34	Average	135	122	P
5	15540.00	14.27	45.21	59.48	74.00	-14.52	Peak	135	122	P

Note: Level=Reading+Factor
Margin=Level-Limit
Factor=Antenna Factor + cable loss - Amplifier Factor



Power	: AC 120V / 60Hz	Pol/Phase	: HORIZONTAL
Test Mode	: Mode 5, Band 1, CH36		:

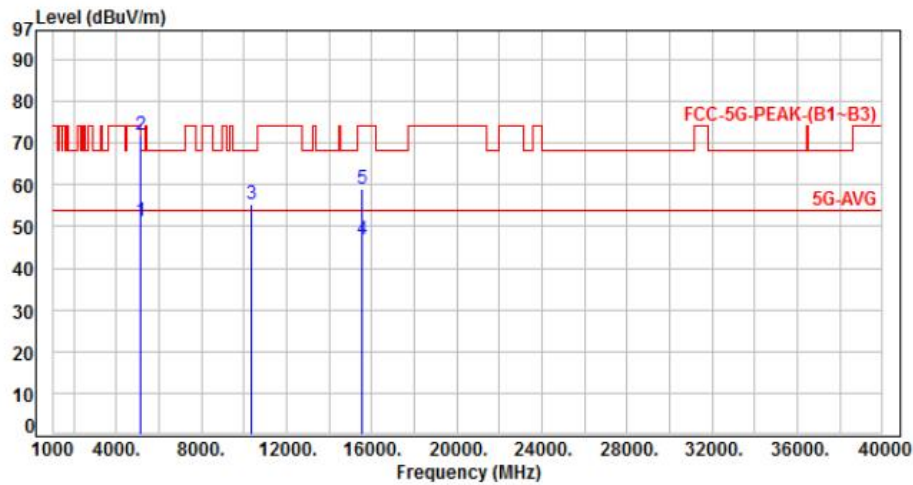

No.	Frequency (MHz)	Factor (dB)	Reading (dBuV)	Level (dBuV/m)	Limit (dBuV/m)	Margin (dB)	Detector	Height (cm)	Azimuth (deg)	P/F
1	5150.00	4.73	46.46	51.19	54.00	-2.81	Average	157	0	P
2	5150.00	4.73	67.05	71.78	74.00	-2.22	Peak	157	0	P
3	10360.00	11.43	43.82	55.25	68.20	-12.95	Peak	100	215	P
4	15540.00	14.27	32.72	46.99	54.00	-7.01	Average	100	119	P
5	15540.00	14.27	44.67	58.94	74.00	-15.06	Peak	100	119	P

Note: Level=Reading+Factor
 Margin=Level-Limit
 Factor=Antenna Factor + cable loss - Amplifier Factor



Power	: AC 120V / 60Hz	Pol/Phase	: VERTICAL
Test Mode	: Mode 5, Band 1, CH44		:

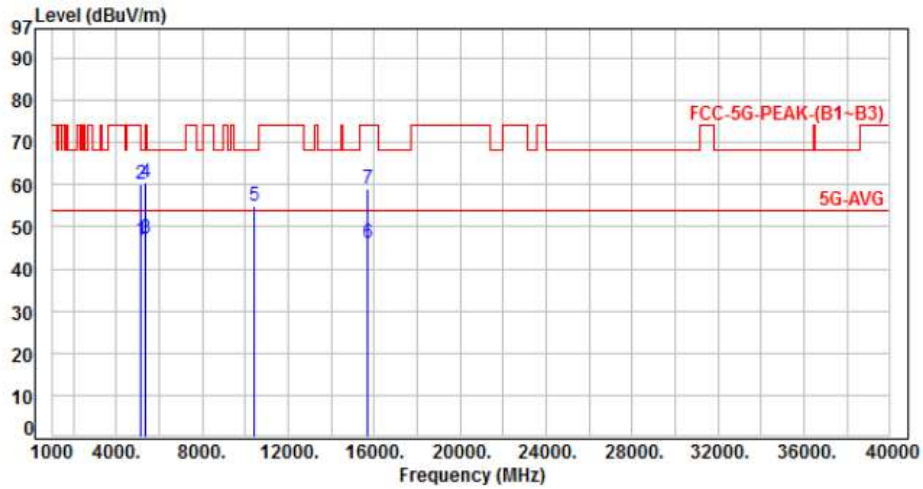

No.	Frequency (MHz)	Factor (dB)	Reading (dBuV)	Level (dBuV/m)	Limit (dBuV/m)	Margin (dB)	Detector	Height (cm)	Azimuth (deg)	P/F
1	5150.00	4.73	41.96	46.69	54.00	-7.31	Average	168	311	P
2	5150.00	4.73	55.41	60.14	74.00	-13.86	Peak	168	311	P
3	5350.00	5.07	42.30	47.37	54.00	-6.63	Average	168	311	P
4	5350.00	5.07	55.26	60.33	74.00	-13.67	Peak	168	311	P
5	10440.00	11.55	43.33	54.88	68.20	-13.32	Peak	100	331	P
6	15660.00	13.72	32.44	46.16	54.00	-7.84	Average	128	106	P
7	15660.00	13.72	45.16	58.88	74.00	-15.12	Peak	128	106	P

Note: Level=Reading+Factor
 Margin=Level-Limit
 Factor=Antenna Factor + cable loss - Amplifier Factor



Power	: AC 120V / 60Hz	Pol/Phase	: HORIZONTAL
Test Mode	: Mode 5, Band 1, CH44		:

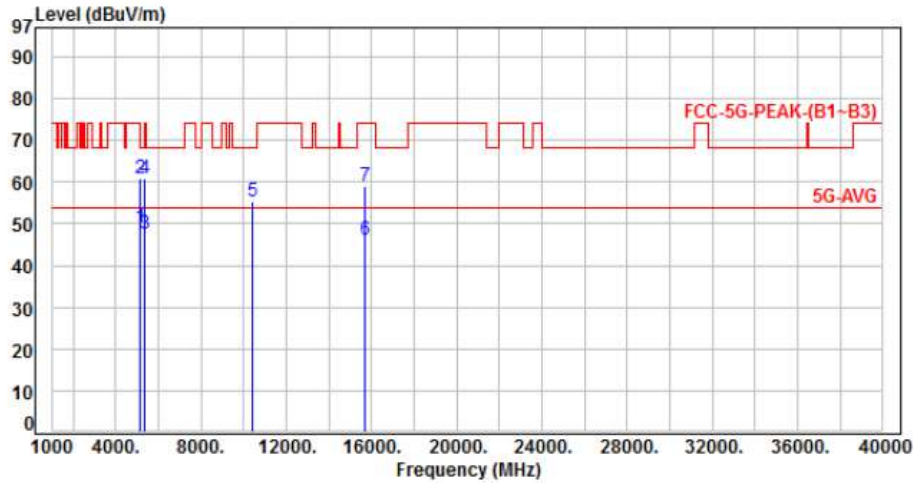

No.	Frequency (MHz)	Factor (dB)	Reading (dBuV)	Level (dBuV/m)	Limit (dBuV/m)	Margin (dB)	Detector	Height (cm)	Azimuth (deg)	P/F
1	5150.00	4.73	44.14	48.87	54.00	-5.13	Average	232	0	P
2	5150.00	4.73	56.16	60.89	74.00	-13.11	Peak	232	0	P
3	5350.00	5.07	42.45	47.52	54.00	-6.48	Average	232	0	P
4	5350.00	5.07	55.61	60.68	74.00	-13.32	Peak	232	0	P
5	10440.00	11.55	43.86	55.41	68.20	-12.79	Peak	100	223	P
6	15660.00	13.72	32.55	46.27	54.00	-7.73	Average	131	162	P
7	15660.00	13.72	45.32	59.04	74.00	-14.96	Peak	131	162	P

Note: Level=Reading+Factor
 Margin=Level-Limit
 Factor=Antenna Factor + cable loss - Amplifier Factor



Power	: AC 120V / 60Hz	Pol/Phase	: VERTICAL
Test Mode	: Mode 5, Band 1, CH48		:

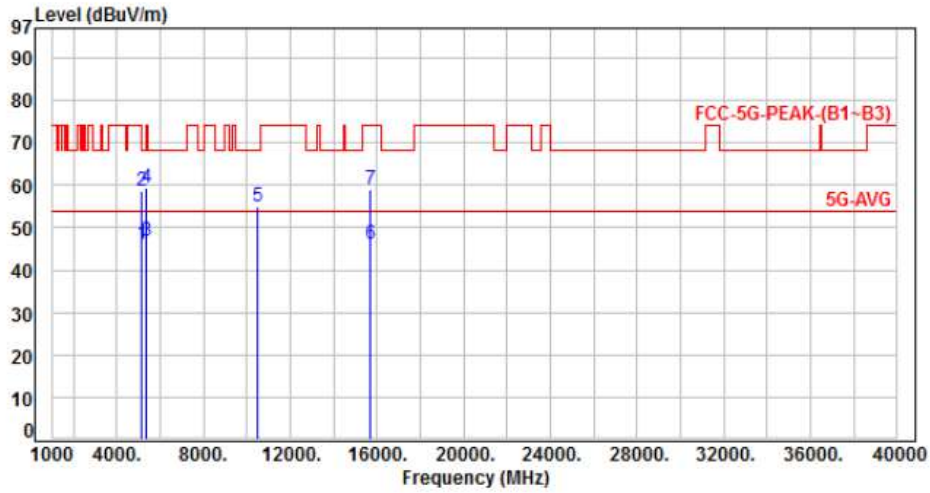

No.	Frequency (MHz)	Factor (dB)	Reading (dBuV)	Level (dBuV/m)	Limit (dBuV/m)	Margin (dB)	Detector	Height (cm)	Azimuth (deg)	P/F
1	5150.00	4.73	41.36	46.09	54.00	-7.91	Average	100	135	P
2	5150.00	4.73	54.01	58.74	74.00	-15.26	Peak	100	135	P
3	5350.00	5.07	41.73	46.80	54.00	-7.20	Average	100	135	P
4	5350.00	5.07	54.41	59.48	74.00	-14.52	Peak	100	135	P
5	10480.00	11.65	43.21	54.86	68.20	-13.34	Peak	100	326	P
6	15720.00	13.60	32.59	46.19	54.00	-7.81	Average	118	98	P
7	15720.00	13.60	45.39	58.99	74.00	-15.01	Peak	118	98	P

Note: Level=Reading+Factor
 Margin=Level-Limit
 Factor=Antenna Factor + cable loss - Amplifier Factor



Power	: AC 120V / 60Hz	Pol/Phase	: HORIZONTAL
Test Mode	: Mode 5, Band 1, CH48		:

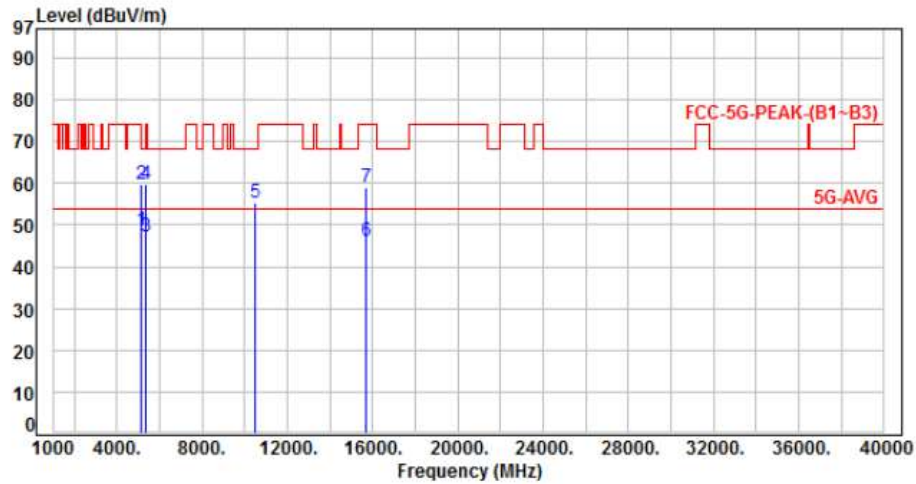

No.	Frequency (MHz)	Factor (dB)	Reading (dBuV)	Level (dBuV/m)	Limit (dBuV/m)	Margin (dB)	Detector	Height (cm)	Azimuth (deg)	P/F
1	5150.00	4.73	43.89	48.62	54.00	-5.38	Average	100	164	P
2	5150.00	4.73	55.16	59.89	74.00	-14.11	Peak	100	164	P
3	5350.00	5.07	42.11	47.18	54.00	-6.82	Average	100	164	P
4	5350.00	5.07	54.80	59.87	74.00	-14.13	Peak	100	164	P
5	10480.00	11.65	43.69	55.34	68.20	-12.86	Peak	100	241	P
6	15720.00	13.60	32.63	46.23	54.00	-7.77	Average	100	164	P
7	15720.00	13.60	45.47	59.07	74.00	-14.93	Peak	100	164	P

Note: Level=Reading+Factor
Margin=Level-Limit
Factor=Antenna Factor + cable loss - Amplifier Factor



Power	: AC 120V / 60Hz	Pol/Phase	: VERTICAL
Test Mode	: Mode 6, Band 1, CH38		:

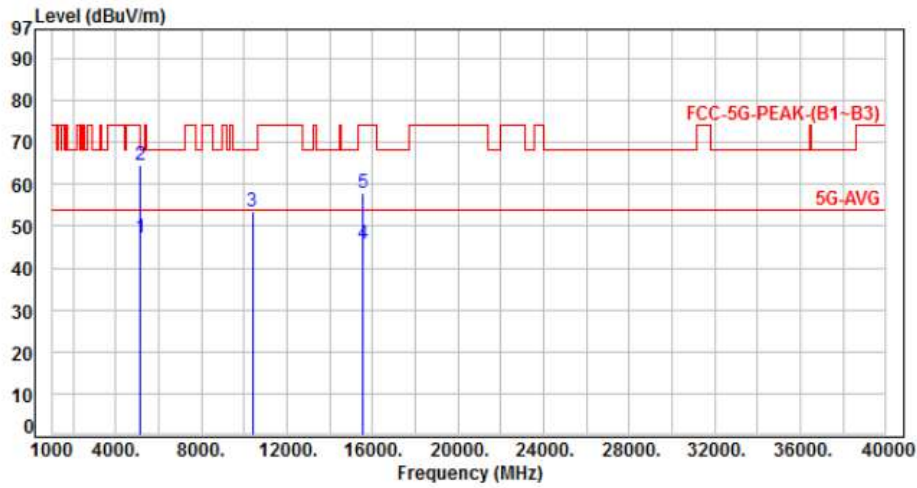

No.	Frequency (MHz)	Factor (dB)	Reading (dBuV)	Level (dBuV/m)	Limit (dBuV/m)	Margin (dB)	Detector	Height (cm)	Azimuth (deg)	P/F
1	5150.00	4.73	42.59	47.32	54.00	-6.68	Average	100	244	P
2	5150.00	4.73	59.90	64.63	74.00	-9.37	Peak	100	244	P
3	10380.00	11.44	41.92	53.36	68.20	-14.84	Peak	118	141	P
4	15570.00	14.07	31.49	45.56	54.00	-8.44	Average	121	132	P
5	15570.00	14.07	43.86	57.93	74.00	-16.07	Peak	121	132	P

Note: Level=Reading+Factor
Margin=Level-Limit
Factor=Antenna Factor + cable loss - Amplifier Factor



Power	: AC 120V / 60Hz	Pol/Phase	: HORIZONTAL
Test Mode	: Mode 6, Band 1, CH38		:

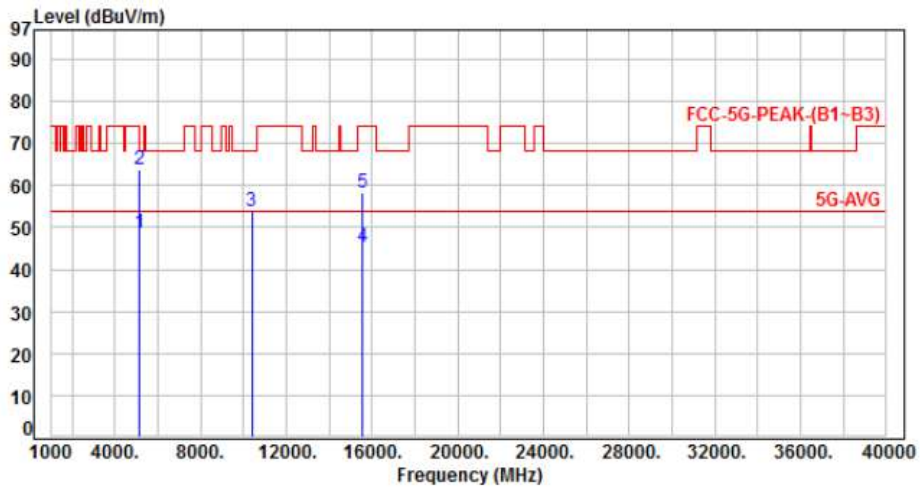

No.	Frequency (MHz)	Factor (dB)	Reading (dBuV)	Level (dBuV/m)	Limit (dBuV/m)	Margin (dB)	Detector	Height (cm)	Azimuth (deg)	P/F
1	5150.00	4.73	43.95	48.68	54.00	-5.32	Average	160	2	P
2	5150.00	4.73	59.21	63.94	74.00	-10.06	Peak	160	2	P
3	10380.00	11.44	42.42	53.86	68.20	-14.34	Peak	100	211	P
4	15570.00	14.07	31.27	45.34	54.00	-8.66	Average	125	181	P
5	15570.00	14.07	44.30	58.37	74.00	-15.63	Peak	125	181	P

Note: Level=Reading+Factor
 Margin=Level-Limit
 Factor=Antenna Factor + cable loss - Amplifier Factor



Power	: AC 120V / 60Hz	Pol/Phase	: VERTICAL
Test Mode	: Mode 6, Band 1, CH46		

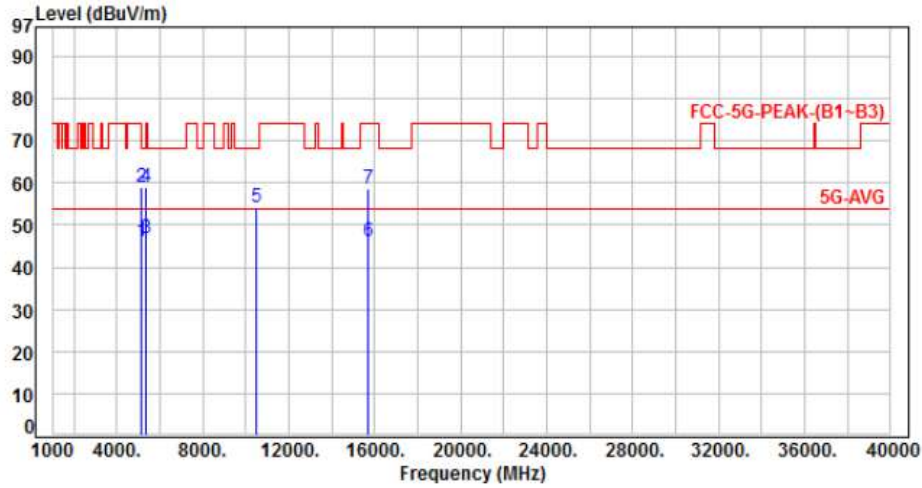

No.	Frequency (MHz)	Factor (dB)	Reading (dBuV)	Level (dBuV/m)	Limit (dBuV/m)	Margin (dB)	Detector	Height (cm)	Azimuth (deg)	P/F
1	5150.00	4.73	41.40	46.13	54.00	-7.87	Average	100	265	P
2	5150.00	4.73	54.34	59.07	74.00	-14.93	Peak	100	265	P
3	5350.00	5.07	41.79	46.86	54.00	-7.14	Average	100	265	P
4	5350.00	5.07	53.88	58.95	74.00	-15.05	Peak	100	265	P
5	10460.00	11.60	42.66	54.26	68.20	-13.94	Peak	124	163	P
6	15690.00	13.64	32.39	46.03	54.00	-7.97	Average	106	116	P
7	15690.00	13.64	44.92	58.56	74.00	-15.44	Peak	106	116	P

Note: Level=Reading+Factor
 Margin=Level-Limit
 Factor=Antenna Factor + cable loss - Amplifier Factor



Power	: AC 120V / 60Hz	Pol/Phase	: HORIZONTAL
Test Mode	: Mode 6, Band 1, CH46		:

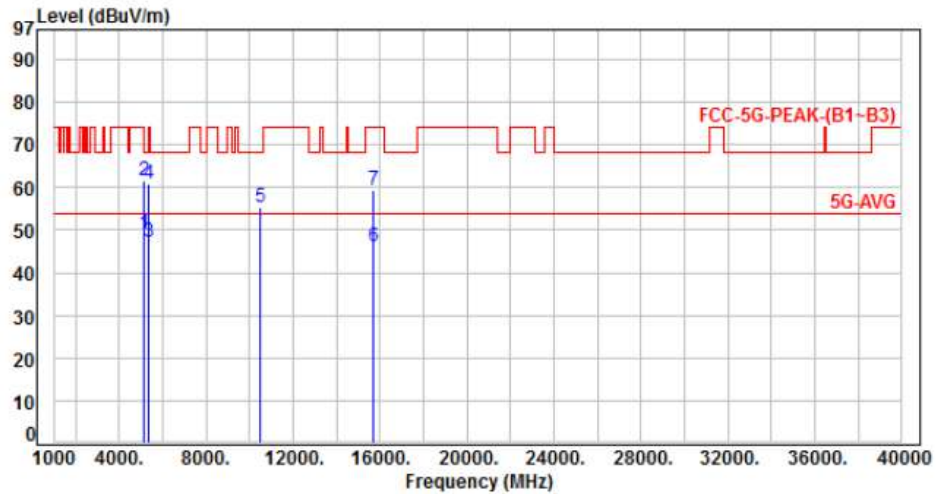

No.	Frequency (MHz)	Factor (dB)	Reading (dBuV)	Level (dBuV/m)	Limit (dBuV/m)	Margin (dB)	Detector	Height (cm)	Azimuth (deg)	P/F
1	5150.00	4.73	44.21	48.94	54.00	-5.06	Average	120	0	P
2	5150.00	4.73	56.75	61.48	74.00	-12.52	Peak	120	0	P
3	5350.00	5.07	42.31	47.38	54.00	-6.62	Average	120	0	P
4	5350.00	5.07	55.65	60.72	74.00	-13.28	Peak	120	0	P
5	10460.00	11.60	43.59	55.19	68.20	-13.01	Peak	100	265	P
6	15690.00	13.64	32.41	46.05	54.00	-7.95	Average	116	202	P
7	15690.00	13.64	45.58	59.22	74.00	-14.78	Peak	116	202	P

Note: Level=Reading+Factor
 Margin=Level-Limit
 Factor=Antenna Factor + cable loss - Amplifier Factor



Power	: AC 120V / 60Hz	Pol/Phase	: VERTICAL
Test Mode	: Mode 7, Band 1, CH42		

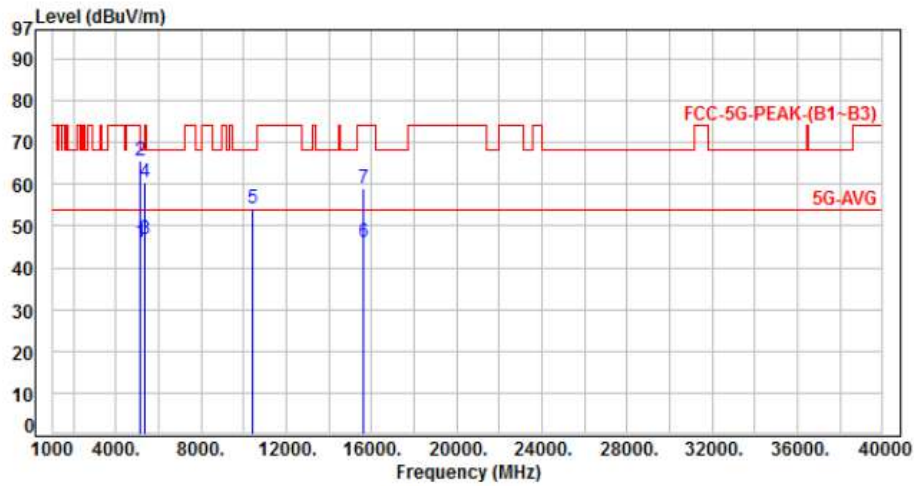

No.	Frequency (MHz)	Factor (dB)	Reading (dBuV)	Level (dBuV/m)	Limit (dBuV/m)	Margin (dB)	Detector	Height (cm)	Azimuth (deg)	P/F
1	5150.00	4.73	41.47	46.20	54.00	-7.80	Average	110	311	P
2	5150.00	4.73	60.80	65.53	74.00	-8.47	Peak	110	311	P
3	5350.00	5.07	41.85	46.92	54.00	-7.08	Average	110	311	P
4	5350.00	5.07	55.32	60.39	74.00	-13.61	Peak	110	311	P
5	10420.00	11.49	42.71	54.20	68.20	-14.00	Peak	100	184	P
6	15630.00	13.80	32.28	46.08	54.00	-7.92	Average	100	108	P
7	15630.00	13.80	45.06	58.86	74.00	-15.14	Peak	100	108	P

Note: Level=Reading+Factor
 Margin=Level-Limit
 Factor=Antenna Factor + cable loss - Amplifier Factor



Power	: AC 120V / 60Hz	Pol/Phase	: HORIZONTAL
Test Mode	: Mode 7, Band 1, CH42		:

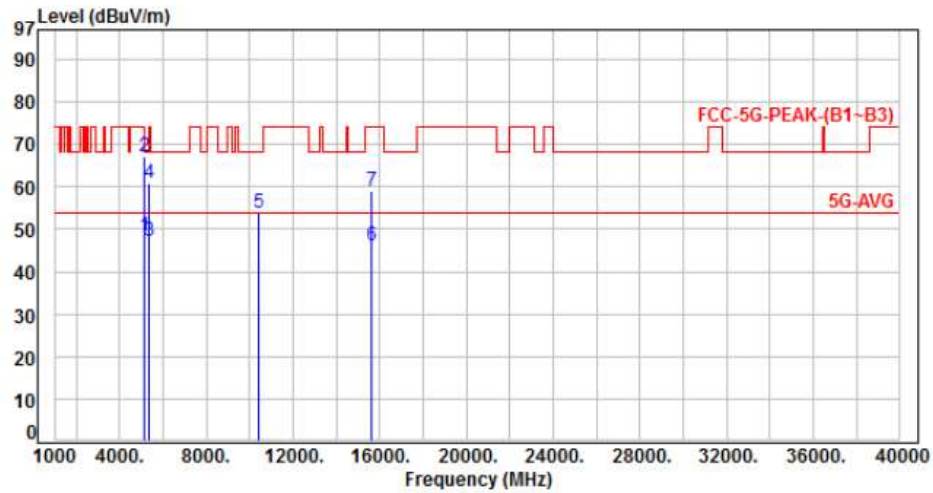

No.	Frequency (MHz)	Factor (dB)	Reading (dBuV)	Level (dBuV/m)	Limit (dBuV/m)	Margin (dB)	Detector	Height (cm)	Azimuth (deg)	P/F
1	5150.00	4.73	43.62	48.35	54.00	-5.65	Average	158	0	P
2	5150.00	4.73	62.26	66.99	74.00	-7.01	Peak	158	0	P
3	5350.00	5.07	41.96	47.03	54.00	-6.97	Average	158	0	P
4	5350.00	5.07	55.79	60.86	74.00	-13.14	Peak	158	0	P
5	10420.00	11.49	42.44	53.93	68.20	-14.27	Peak	100	306	P
6	15630.00	13.80	32.36	46.16	54.00	-7.84	Average	112	216	P
7	15630.00	13.80	45.18	58.98	74.00	-15.02	Peak	112	216	P

Note: Level=Reading+Factor
Margin=Level-Limit
Factor=Antenna Factor + cable loss - Amplifier Factor



Power	: AC 120V / 60Hz	Pol/Phase	: VERTICAL
Test Mode	: Mode 5, Band 4, CH149		:

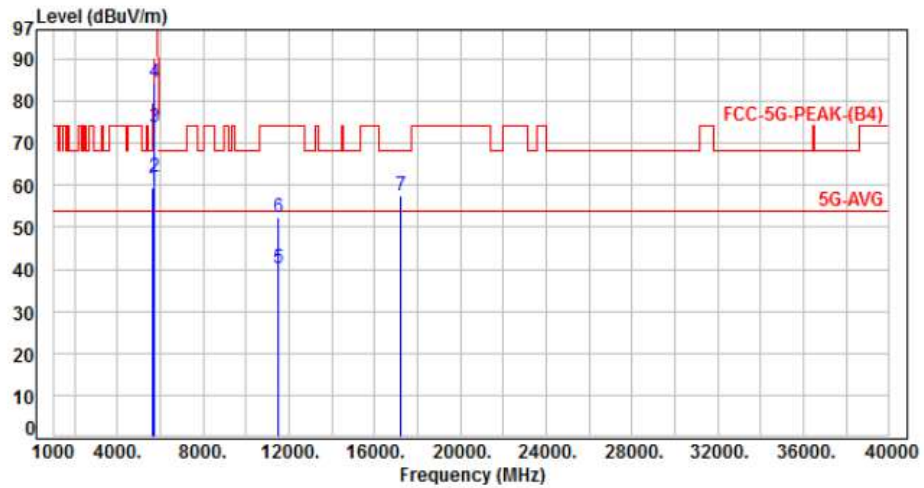

No.	Frequency (MHz)	Factor (dB)	Reading (dBuV)	Level (dBuV/m)	Limit (dBuV/m)	Margin (dB)	Detector	Height (cm)	Azimuth (deg)	P/F
1	5650.00	-11.38	70.68	59.30	68.20	-8.90	Peak	382	145	P
2	5700.00	-11.48	73.36	61.88	105.20	-43.32	Peak	382	145	P
3	5720.00	-11.48	85.42	73.94	110.80	-36.86	Peak	382	145	P
4	5725.00	-11.48	95.97	84.49	122.20	-37.71	Peak	382	145	P
5	11490.00	-4.36	44.71	40.35	54.00	-13.65	Average	100	202	P
6	11490.00	-4.36	56.79	52.43	74.00	-21.57	Peak	100	202	P
7	17235.00	4.27	53.35	57.62	68.20	-10.58	Peak	100	36	P

Note: Level=Reading+Factor
 Margin=Level-Limit
 Factor=Antenna Factor + cable loss - Amplifier Factor



Power	: AC 120V / 60Hz	Pol/Phase	: HORIZONTAL
Test Mode	: Mode 5, Band 4, CH149		:

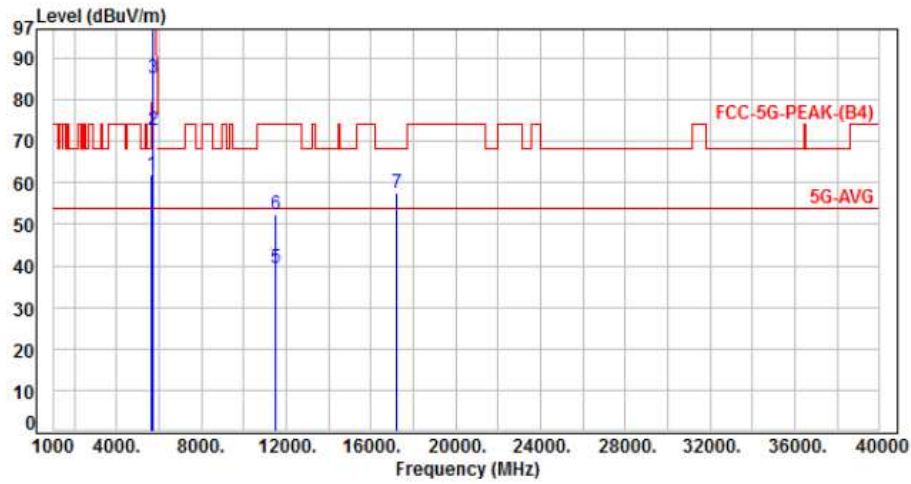

No.	Frequency (MHz)	Factor (dB)	Reading (dBuV)	Level (dBuV/m)	Limit (dBuV/m)	Margin (dB)	Detector	Height (cm)	Azimuth (deg)	P/F
1	5650.00	-11.38	73.41	62.03	68.20	-6.17	Peak	100	36	P
2	5700.00	-11.48	84.01	72.53	105.20	-32.67	Peak	100	36	P
3	5720.00	-11.48	96.53	85.05	110.80	-25.75	Peak	100	36	P
4	5725.00	-11.48	108.35	96.87	122.20	-25.33	Peak	100	36	P
5	11490.00	-4.36	43.96	39.60	54.00	-14.40	Average	148	80	P
6	11490.00	-4.36	56.75	52.39	74.00	-21.61	Peak	148	80	P
7	17235.00	4.27	53.44	57.71	68.20	-10.49	Peak	100	68	P

Note: Level=Reading+Factor
 Margin=Level-Limit
 Factor=Antenna Factor + cable loss - Amplifier Factor



Power	: AC 120V / 60Hz	Pol/Phase	: VERTICAL
Test Mode	: Mode 5, Band 4, CH157		:

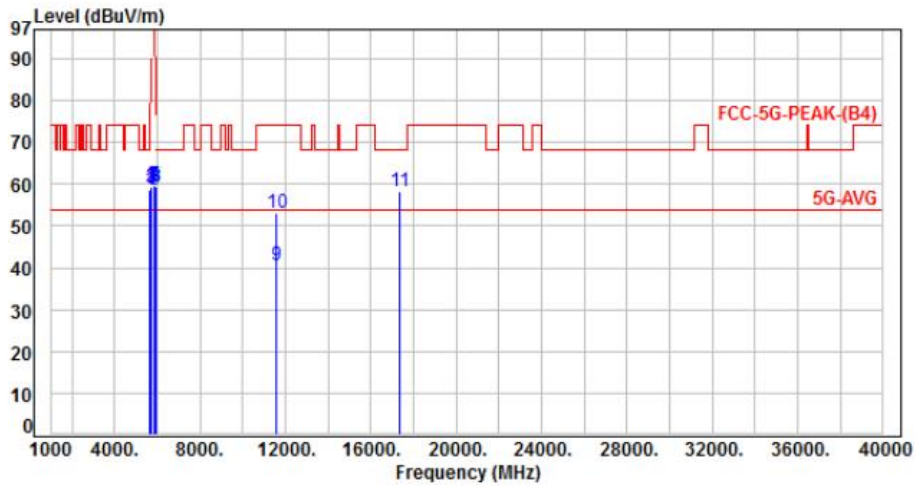

No.	Frequency (MHz)	Factor (dB)	Reading (dBuV)	Level (dBuV/m)	Limit (dBuV/m)	Margin (dB)	Detector	Height (cm)	Azimuth (deg)	P/F
1	5650.00	-11.38	70.05	58.67	68.20	-9.53	Peak	400	295	P
2	5700.00	-11.48	70.78	59.30	105.20	-45.90	Peak	400	295	P
3	5720.00	-11.48	70.52	59.04	110.80	-51.76	Peak	400	295	P
4	5725.00	-11.48	70.13	58.65	122.20	-63.55	Peak	400	295	P
5	5850.00	-11.38	70.14	58.76	122.20	-63.44	Peak	400	295	P
6	5855.00	-11.36	70.95	59.59	110.80	-51.21	Peak	400	295	P
7	5875.00	-11.28	71.08	59.80	105.20	-45.40	Peak	400	295	P
8	5925.00	-11.19	70.60	59.41	68.20	-8.79	Peak	400	295	P
9	11570.00	-4.05	44.78	40.73	54.00	-13.27	Average	100	224	P
10	11570.00	-4.05	57.18	53.13	74.00	-20.87	Peak	100	224	P
11	17355.00	4.87	53.59	58.46	68.20	-9.74	Peak	100	51	P

Note: Level=Reading+Factor
 Margin=Level-Limit
 Factor=Antenna Factor + cable loss - Amplifier Factor



Power	: AC 120V / 60Hz	Pol/Phase	: HORIZONTAL
Test Mode	: Mode 5, Band 4, CH157		:

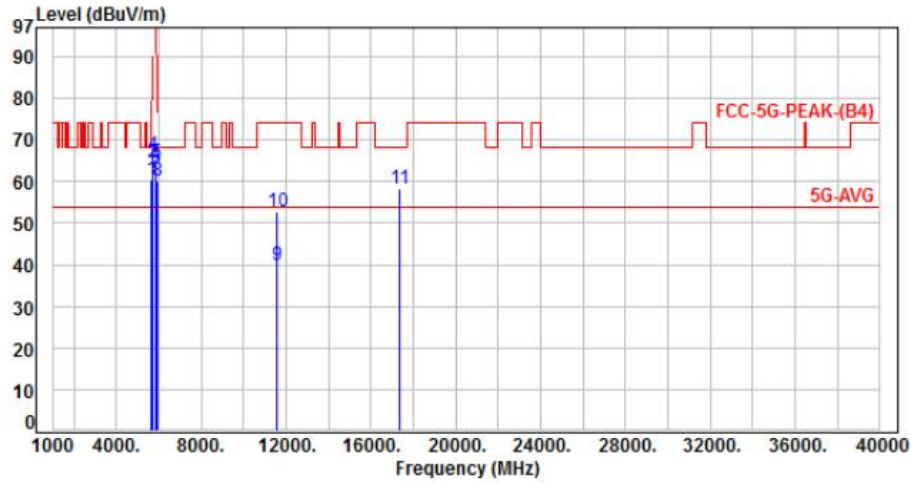

No.	Frequency (MHz)	Factor (dB)	Reading (dBuV)	Level (dBuV/m)	Limit (dBuV/m)	Margin (dB)	Detector	Height (cm)	Azimuth (deg)	P/F
1	5650.00	-11.38	72.03	60.65	68.20	-7.55	Peak	100	2	P
2	5700.00	-11.48	75.84	64.36	105.20	-40.84	Peak	100	2	P
3	5720.00	-11.48	76.12	64.64	110.80	-46.16	Peak	100	2	P
4	5725.00	-11.48	77.93	66.45	122.20	-55.75	Peak	100	2	P
5	5850.00	-11.38	75.83	64.45	122.20	-57.75	Peak	100	2	P
6	5855.00	-11.36	74.56	63.20	110.80	-47.60	Peak	100	2	P
7	5875.00	-11.28	73.21	61.93	105.20	-43.27	Peak	100	2	P
8	5925.00	-11.19	71.22	60.03	68.20	-8.17	Peak	100	2	P
9	11570.00	-4.05	44.04	39.99	54.00	-14.01	Average	145	126	P
10	11570.00	-4.05	56.85	52.80	74.00	-21.20	Peak	145	126	P
11	17355.00	4.87	53.38	58.25	68.20	-9.95	Peak	100	96	P

Note: Level=Reading+Factor
 Margin=Level-Limit
 Factor=Antenna Factor + cable loss - Amplifier Factor



Power	: AC 120V / 60Hz	Pol/Phase	: VERTICAL
Test Mode	: Mode 5, Band 4, CH165		:

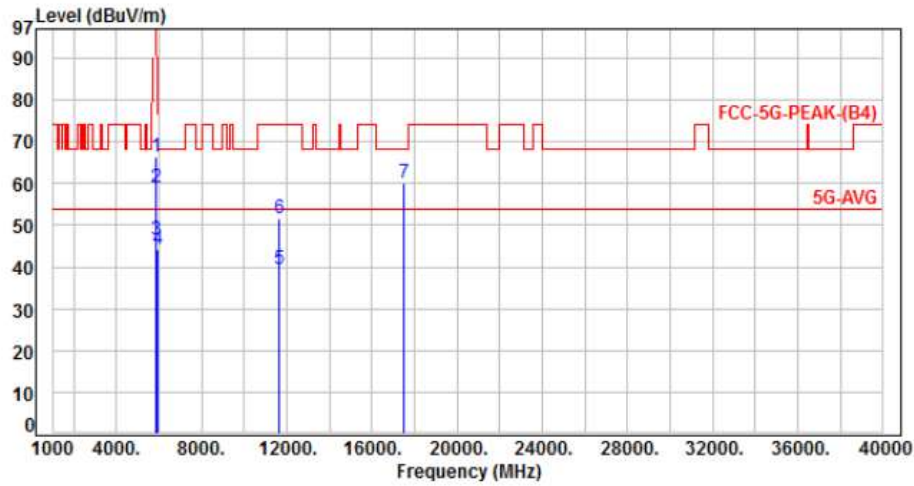

No.	Frequency (MHz)	Factor (dB)	Reading (dBuV)	Level (dBuV/m)	Limit (dBuV/m)	Margin (dB)	Detector	Height (cm)	Azimuth (deg)	P/F
1	5850.00	-11.38	77.74	66.36	122.20	-55.84	Peak	372	12	P
2	5855.00	-11.36	70.45	59.09	110.80	-51.71	Peak	372	12	P
3	5875.00	-11.28	57.93	46.65	105.20	-58.55	Peak	372	12	P
4	5925.00	-11.19	55.49	44.30	68.20	-23.90	Peak	372	12	P
5	11650.00	-3.87	43.41	39.54	54.00	-14.46	Average	100	247	P
6	11650.00	-3.87	55.62	51.75	74.00	-22.25	Peak	100	247	P
7	17475.00	5.68	54.52	60.20	68.20	-8.00	Peak	100	247	P

Note: Level=Reading+Factor
 Margin=Level-Limit
 Factor=Antenna Factor + cable loss - Amplifier Factor



Power	: AC 120V / 60Hz	Pol/Phase	: HORIZONTAL
Test Mode	: Mode 5, Band 4, CH165		:

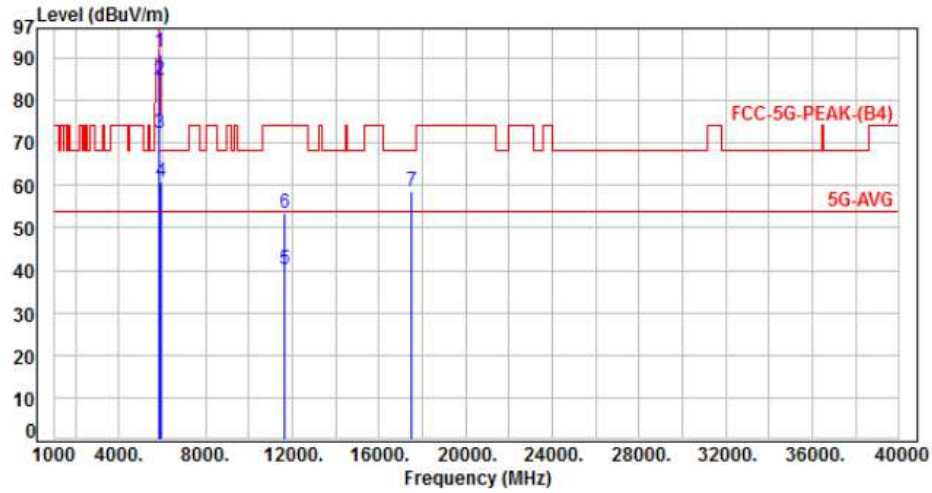

No.	Frequency (MHz)	Factor (dB)	Reading (dBuV)	Level (dBuV/m)	Limit (dBuV/m)	Margin (dB)	Detector	Height (cm)	Azimuth (deg)	P/F
1	5850.00	-11.38	102.82	91.44	122.20	-30.76	Peak	206	3	P
2	5855.00	-11.36	96.29	84.93	110.80	-25.87	Peak	206	3	P
3	5875.00	-11.28	83.58	72.30	105.20	-32.90	Peak	206	3	P
4	5925.00	-11.19	72.04	60.85	68.20	-7.35	Peak	206	3	P
5	11650.00	-3.87	44.06	40.19	54.00	-13.81	Average	139	85	P
6	11650.00	-3.87	57.25	53.38	74.00	-20.62	Peak	139	85	P
7	17475.00	5.68	52.82	58.50	68.20	-9.70	Peak	100	54	P

Note: Level=Reading+Factor
 Margin=Level-Limit
 Factor=Antenna Factor + cable loss - Amplifier Factor



Power	: AC 120V / 60Hz	Pol/Phase	: VERTICAL
Test Mode	: Mode 6, Band 4, CH151		

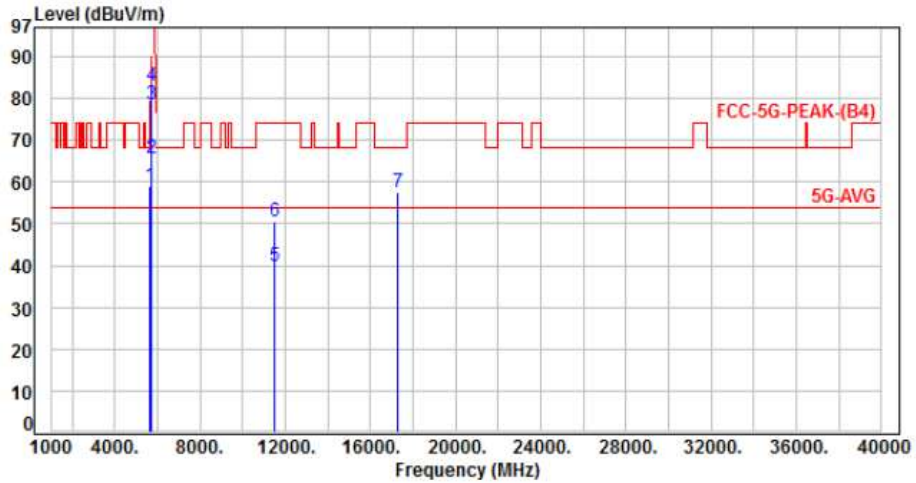

No.	Frequency (MHz)	Factor (dB)	Reading (dBuV)	Level (dBuV/m)	Limit (dBuV/m)	Margin (dB)	Detector	Height (cm)	Azimuth (deg)	P/F
1	5650.00	-11.38	70.48	59.10	68.20	-9.10	Peak	385	12	P
2	5700.00	-11.48	77.16	65.68	105.20	-39.52	Peak	385	12	P
3	5720.00	-11.48	90.18	78.70	110.80	-32.10	Peak	385	12	P
4	5725.00	-11.48	94.41	82.93	122.20	-39.27	Peak	385	12	P
5	11510.00	-4.31	44.21	39.90	54.00	-14.10	Average	100	330	P
6	11510.00	-4.31	54.86	50.55	74.00	-23.45	Peak	100	330	P
7	17265.00	4.40	53.13	57.53	68.20	-10.67	Peak	100	238	P

Note: Level=Reading+Factor
 Margin=Level-Limit
 Factor=Antenna Factor + cable loss - Amplifier Factor



Power	: AC 120V / 60Hz	Pol/Phase	: HORIZONTAL
Test Mode	: Mode 6, Band 4, CH151		

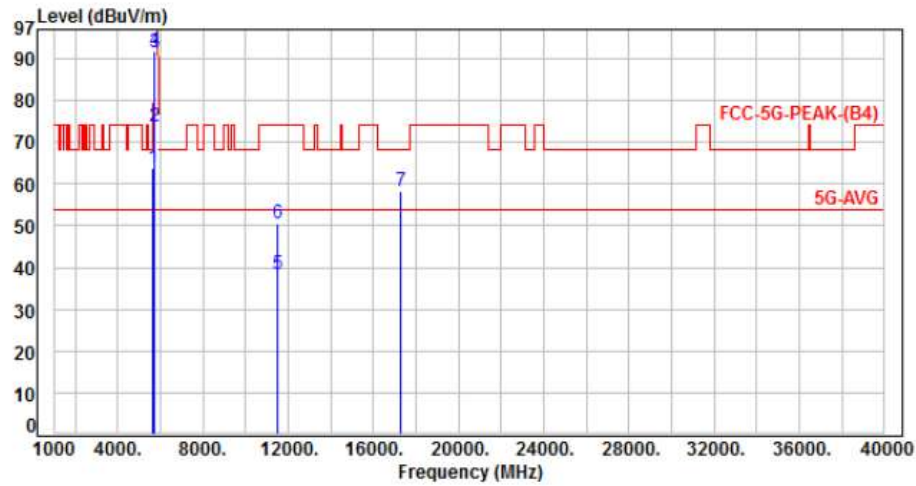

No.	Frequency (MHz)	Factor (dB)	Reading (dBUV)	Level (dBUV/m)	Limit (dBUV/m)	Margin (dB)	Detector	Height (cm)	Azimuth (deg)	P/F
1	5650.00	-11.38	75.13	63.75	68.20	-4.45	Peak	100	0	P
2	5700.00	-11.48	85.33	73.85	105.20	-31.35	Peak	100	0	P
3	5720.00	-11.48	103.02	91.54	110.80	-19.26	Peak	100	0	P
4	5725.00	-11.48	103.33	91.85	122.20	-30.35	Peak	100	0	P
5	11510.00	-4.31	42.56	38.25	54.00	-15.75	Average	100	200	P
6	11510.00	-4.31	54.90	50.59	74.00	-23.41	Peak	100	200	P
7	17265.00	4.40	53.83	58.23	68.20	-9.97	Peak	100	117	P

Note: Level=Reading+Factor
 Margin=Level-Limit
 Factor=Antenna Factor + cable loss - Amplifier Factor



Power	: AC 120V / 60Hz	Pol/Phase	: VERTICAL
Test Mode	: Mode 6, Band 4, CH159		:

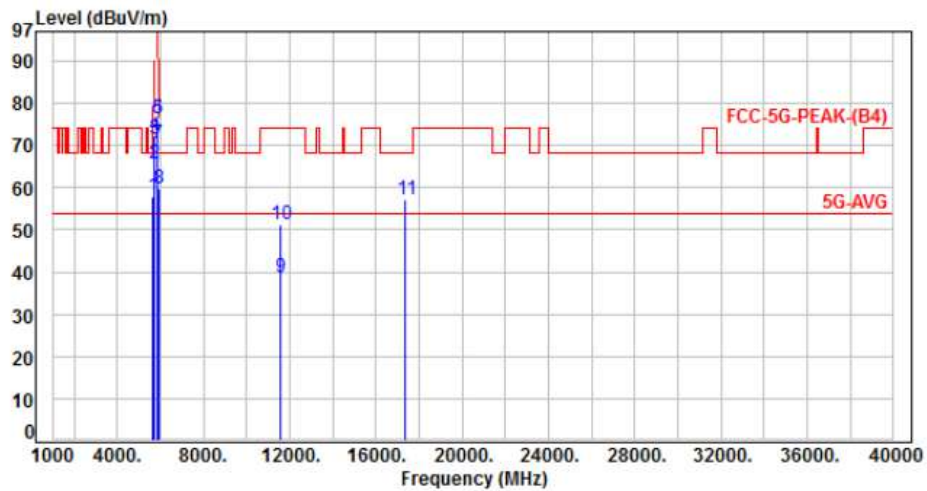

No.	Frequency (MHz)	Factor (dB)	Reading (dBuV)	Level (dBuV/m)	Limit (dBuV/m)	Margin (dB)	Detector	Height (cm)	Azimuth (deg)	P/F
1	5650.00	-11.38	69.34	57.96	68.20	-10.24	Peak	150	328	P
2	5700.00	-11.48	77.20	65.72	105.20	-39.48	Peak	150	328	P
3	5720.00	-11.48	83.12	71.64	110.80	-39.16	Peak	150	328	P
4	5725.00	-11.48	83.87	72.39	122.20	-49.81	Peak	150	328	P
5	5850.00	-11.38	87.62	76.24	122.20	-45.96	Peak	127	330	P
6	5855.00	-11.36	87.54	76.18	110.80	-34.62	Peak	127	330	P
7	5875.00	-11.28	81.87	70.59	105.20	-34.61	Peak	127	330	P
8	5925.00	-11.19	71.05	59.86	68.20	-8.34	Peak	127	330	P
9	11590.00	-3.97	42.76	38.79	54.00	-15.21	Average	100	275	P
10	11590.00	-3.97	55.12	51.15	74.00	-22.85	Peak	100	275	P
11	17385.00	5.05	52.26	57.31	68.20	-10.89	Peak	100	171	P

Note: Level=Reading+Factor
 Margin=Level-Limit
 Factor=Antenna Factor + cable loss - Amplifier Factor



Power	: AC 120V / 60Hz	Pol/Phase	: HORIZONTAL
Test Mode	: Mode 6, Band 4, CH159		:

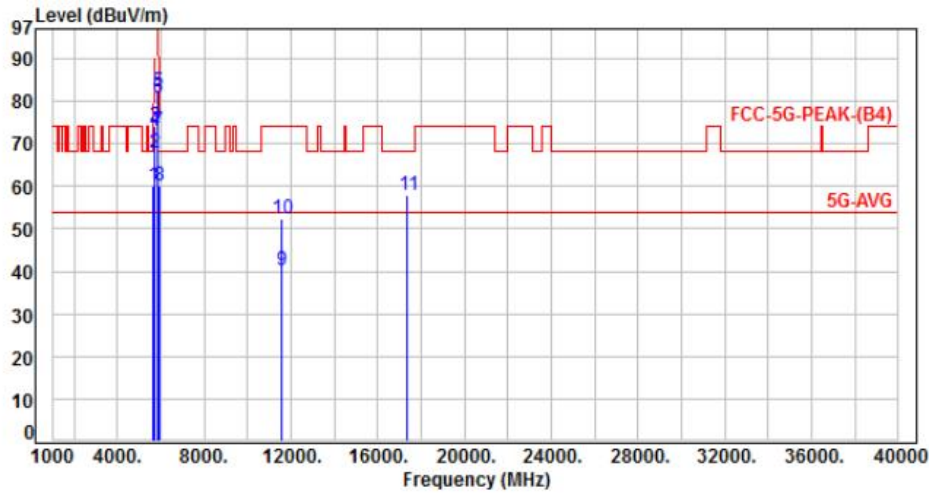

No.	Frequency (MHz)	Factor (dB)	Reading (dBuV)	Level (dBuV/m)	Limit (dBuV/m)	Margin (dB)	Detector	Height (cm)	Azimuth (deg)	P/F
1	5650.00	-11.38	71.32	59.94	68.20	-8.26	Peak	122	311	P
2	5700.00	-11.48	79.35	67.87	105.20	-37.33	Peak	122	311	P
3	5720.00	-11.48	85.48	74.00	110.80	-36.80	Peak	122	311	P
4	5725.00	-11.48	84.65	73.17	122.20	-49.03	Peak	122	311	P
5	5850.00	-11.38	93.56	82.18	122.20	-40.02	Peak	145	350	P
6	5855.00	-11.36	91.95	80.59	110.80	-30.21	Peak	145	350	P
7	5875.00	-11.28	84.24	72.96	105.20	-32.24	Peak	145	350	P
8	5925.00	-11.19	71.46	60.27	68.20	-7.93	Peak	145	350	P
9	11590.00	-3.97	44.03	40.06	54.00	-13.94	Average	100	192	P
10	11590.00	-3.97	56.27	52.30	74.00	-21.70	Peak	100	192	P
11	17385.00	5.05	52.89	57.94	68.20	-10.26	Peak	100	235	P

Note: Level=Reading+Factor
Margin=Level-Limit
Factor=Antenna Factor + cable loss - Amplifier Factor



Power	: AC 120V / 60Hz	Pol/Phase	: VERTICAL
Test Mode	: Mode 7, Band 4, CH155		:

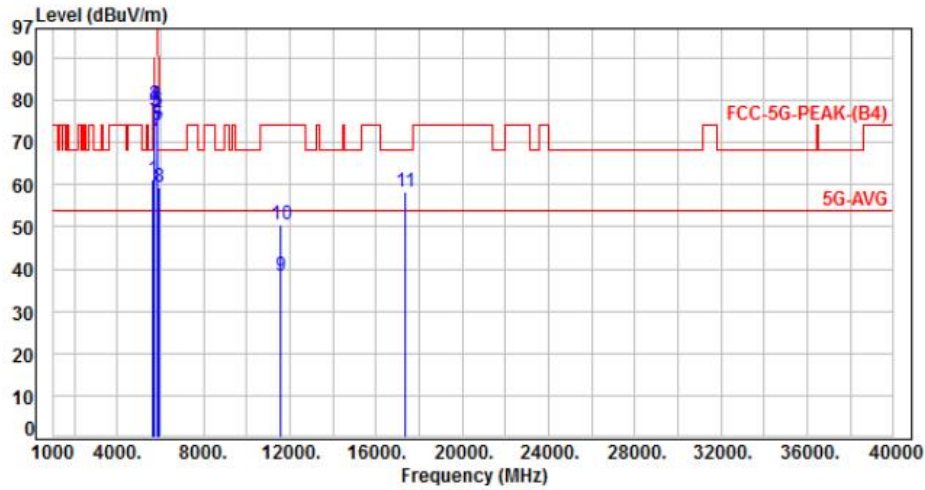

No.	Frequency (MHz)	Factor (dB)	Reading (dBUV)	Level (dBUV/m)	Limit (dBUV/m)	Margin (dB)	Detector	Height (cm)	Azimuth (deg)	P/F
1	5650.00	-11.38	72.67	61.29	68.20	-6.91	Peak	100	330	P
2	5700.00	-11.48	90.26	78.78	105.20	-26.42	Peak	100	330	P
3	5720.00	-11.48	88.90	77.42	110.80	-33.38	Peak	100	330	P
4	5725.00	-11.48	90.57	79.09	122.20	-43.11	Peak	100	330	P
5	5850.00	-11.38	85.55	74.17	122.20	-48.03	Peak	110	303	P
6	5855.00	-11.36	88.66	77.30	110.80	-33.50	Peak	110	303	P
7	5875.00	-11.28	83.76	72.48	105.20	-32.72	Peak	110	303	P
8	5925.00	-11.19	70.55	59.36	68.20	-8.84	Peak	110	303	P
9	11550.00	-4.14	42.34	38.20	54.00	-15.80	Average	100	308	P
10	11550.00	-4.14	54.57	50.43	74.00	-23.57	Peak	100	308	P
11	17325.00	4.68	53.68	58.36	68.20	-9.84	Peak	100	265	P

Note: Level=Reading+Factor
 Margin=Level-Limit
 Factor=Antenna Factor + cable loss - Amplifier Factor



Power	: AC 120V / 60Hz	Pol/Phase	: HORIZONTAL
Test Mode	: Mode 7, Band 4, CH155		:

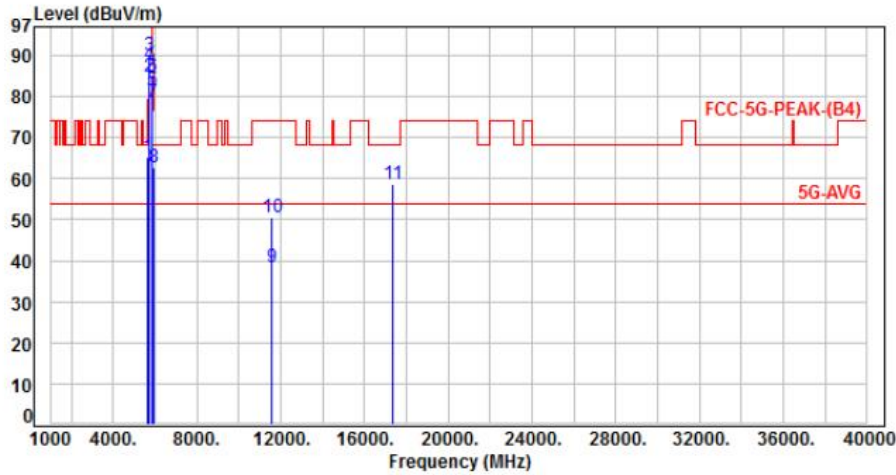

No.	Frequency (MHz)	Factor (dB)	Reading (dBuV)	Level (dBuV/m)	Limit (dBuV/m)	Margin (dB)	Detector	Height (cm)	Azimuth (deg)	P/F
1	5650.00	-11.38	76.58	65.20	68.20	-3.00	Peak	130	321	P
2	5700.00	-11.48	96.28	84.80	105.20	-20.40	Peak	130	321	P
3	5720.00	-11.48	101.40	89.92	110.80	-20.88	Peak	130	321	P
4	5725.00	-11.48	99.43	87.95	122.20	-34.25	Peak	130	321	P
5	5850.00	-11.38	93.06	81.68	122.20	-40.52	Peak	154	340	P
6	5855.00	-11.36	96.17	84.81	110.80	-25.99	Peak	154	340	P
7	5875.00	-11.28	89.92	78.64	105.20	-26.56	Peak	154	340	P
8	5925.00	-11.19	73.71	62.52	68.20	-5.68	Peak	154	340	P
9	11550.00	-4.14	42.63	38.49	54.00	-15.51	Average	100	268	P
10	11550.00	-4.14	54.62	50.48	74.00	-23.52	Peak	100	268	P
11	17325.00	4.68	53.79	58.47	68.20	-9.73	Peak	100	268	P

Note: Level=Reading+Factor
 Margin=Level-Limit
 Factor=Antenna Factor + cable loss - Amplifier Factor



6.7. Restricted Bands of Operation

Only spurious emissions are permitted in any of the frequency bands listed below:

MHz	MHz	MHz	GHz
0.09000 – 0.11000	16.42000 – 16.42300	399.9 – 410.0	4.500 – 5.150
0.49500 – 0.505**	16.69475 – 16.69525	608.0 – 614.0	5.350 – 5.460
2.17350 – 2.19050	16.80425 – 16.80475	960.0 – 1240.0	7.250 – 7.750
4.12500 – 4.12800	25.50000 – 25.67000	1300.0 – 1427.0	8.025 – 8.500
4.17725 – 4.17775	37.50000 – 38.25000	1435.0 – 1626.5	9.000 – 9.200
4.20725 – 4.20775	73.00000 – 74.60000	1645.5 – 1646.5	9.300 – 9.500
6.21500 – 6.21800	74.80000 – 75.20000	1660.0 – 1710.0	10.600 – 12.700
6.26775 – 6.26825	108.00000 – 121.94000	1718.8 – 1722.2	13.250 – 13.400
6.31175 – 6.31225	123.00000 – 138.00000	2200.0 – 2300.0	14.470 – 14.500
8.29100 – 8.29400	149.90000 – 150.05000	2310.0 – 2390.0	15.350 – 16.200
8.36200 – 8.36600	156.52475 – 156.52525	2483.5 – 2500.0	17.700 – 21.400
8.37625 – 8.38675	156.70000 – 156.90000	2655.0 – 2900.0	22.010 – 23.120
8.41425 – 8.41475	162.01250 – 167.17000	3260.0 – 3267.0	23.600 – 24.000
12.29000 – 12.29300	167.72000 – 173.20000	3332.0 – 3339.0	31.200 – 31.800
12.51975 – 12.52025	240.00000 – 285.00000	3345.8 – 3358.0	36.430 – 36.500
12.57675 – 12.57725	322.00000 – 335.40000	3600.0 – 4400.0	Above 38.6
13.36000 – 13.41000			

** : Until February 1, 1999, this restricted band shall be 0.490-0.510 MHz



7. On Time, Duty Cycle and Measurement methods

7.1. Test Limit

None; for reporting purposes only.

7.2. Test Procedure

KDB 789033 Zero-Span Spectrum Analyzer Method.

7.3. Test Setup Layout

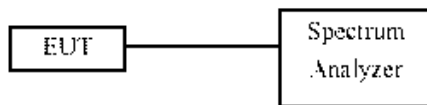

7.4. Test Result and Data (Non-Beamforming)

Modulation Type	On Time (msec)	Period Time (msec)	Duty Cycle (%)
802.11a,6M	2.07	2.14	96.64%
802.11ac VHT20	5.07	5.10	99.41%
802.11ac VHT40	2.48	2.53	98.10%
802.11ac VHT80	1.16	1.22	94.93%

(Beamforming)

Modulation Type	On Time (msec)	Period Time (msec)	Duty Cycle (%)
802.11ac VHT20	1.86	2.20	84.29%
802.11ac VHT40	1.73	1.99	86.65%
802.11ac VHT80	1.58	1.74	91.24%

7.5. Measurement Methods

26 dB and 6dB Emission BW	KDB 789033 D02 v02r01, Section C
99% Occupied BW	KDB 789033 D02 v02r01, Section D
Conducted Output Power	KDB 789033 D02 v02r01, Section E.2.d and E.3.b (Method PM-G)
Power Spectral Density	KDB 789033 D02 v02r01, Section F
Unwanted emissions in restricted bands	KDB 789033 D02 v02r01, Sections G and H
Unwanted emissions in non-restricted bands	KDB 789033 D02 v02r01, Sections G and H



(Non-Beamforming)

Modulation Type: 802.11a (6Mbps)

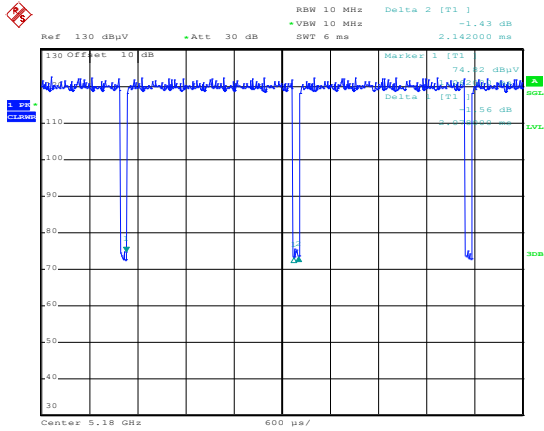

Modulation Type: 802.11ac VHT20 (6.5Mbps)

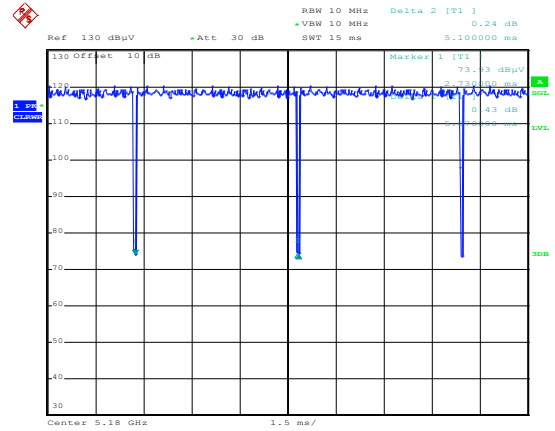

Modulation Type: 802.11ac VHT40 (13.5Mbps)

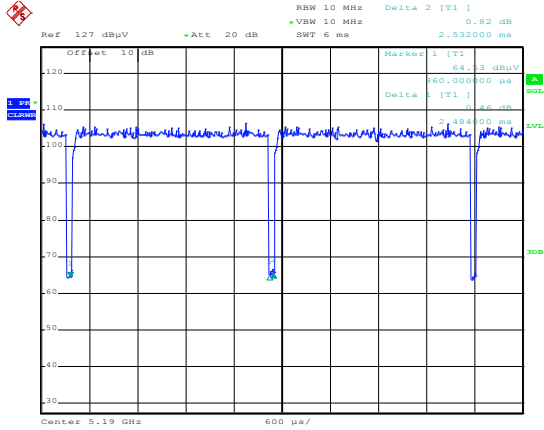

Modulation Type: 802.11ac VHT80 (29.3Mbps)

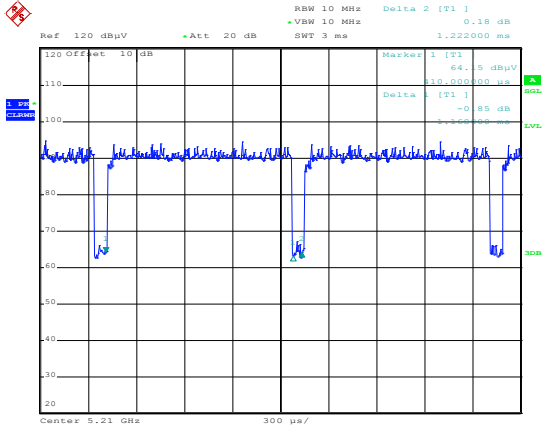



(Beamforming)

Modulation Type: 802.11ac VHT20 (6.5Mbps)

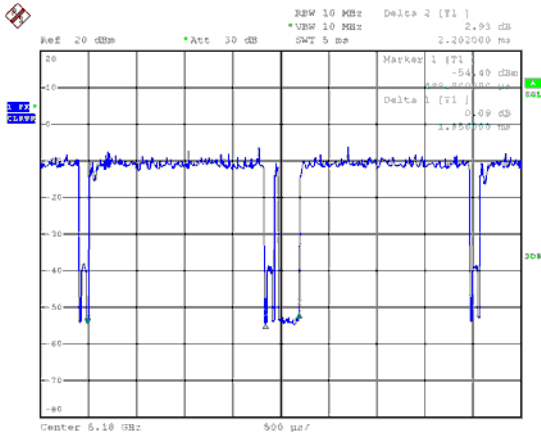

Modulation Type: 802.11ac VHT40 (13.5Mbps)

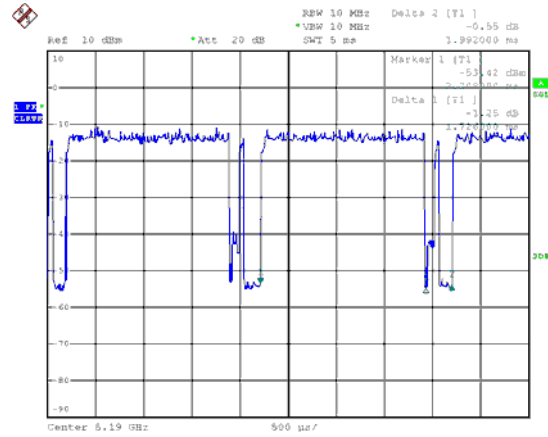

Modulation Type: 802.11ac VHT80 (29.3Mbps)

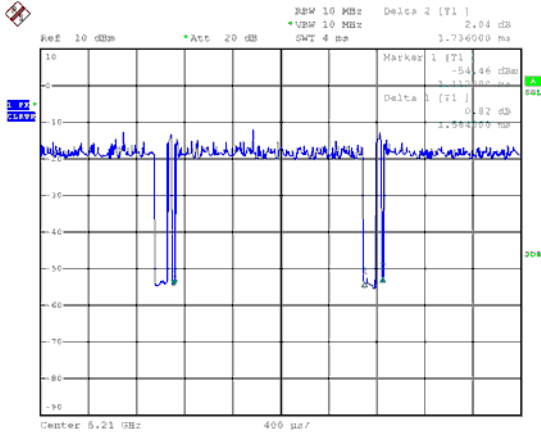



8. 6dB Bandwidth & 99% Occupied Bandwidth

8.1. Test Limit

FCC §15.407

The minimum 6 dB bandwidth shall be at least 500 kHz.

8.2. Test Procedure

Reference to 789033 D02 General UNII Test Procedures New Rules v01: The transmitter output is connected to a spectrum analyzer with the RBW set to 100KHz, the VBW $\geq 3 \times$ RBW, peak detector and max hold.

8.3. Test Setup Layout

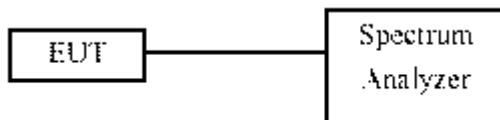

**8.4. Test Result and Data (6dB Bandwidth)****In the 5.8G Band****(Non-Beamforming)**

Modulation Type	Channel	Frequency (MHz)	6dB Bandwidth (MHz)		Minimum Limit (MHz)
			ANT A	ANT B	
802.11a	149	5745	16.30	16.30	0.50
	157	5785	16.30	16.35	0.50
	165	5825	16.25	16.30	0.50
802.11ac VHT20	149	5745	17.55	17.55	0.50
	157	5785	17.65	17.60	0.50
	165	5825	17.60	17.55	0.50
802.11ac VHT40	151	5755	36.40	35.90	0.50
	159	5795	36.40	36.40	0.50
802.11ac VHT80	155	5775	76.32	76.48	0.50

(Beamforming)

Modulation Type	Channel	Frequency (MHz)	6dB Bandwidth (MHz)		Minimum Limit (MHz)
			ANT A	ANT B	
802.11ac VHT20	149	5745	17.55	17.55	0.50
	157	5785	17.65	17.60	0.50
	165	5825	17.60	17.55	0.50
802.11ac VHT40	151	5755	36.40	36.30	0.50
	159	5795	36.40	36.40	0.50
802.11ac VHT80	155	5775	76.00	76.32	0.50