





## TEST REPORT

<b>Report No.:</b>	<b>E201512317298-1</b>	<b>Application No.:</b>	<b>E201512317298</b>
<b>Client:</b>	Cleer Limited		
<b>Address:</b>	Unit518, Lakeside 1, Science Park West Ave. HK Science Park, HK. N.T. Hong Kong		
<b>Sample Description:</b>	Bluetooth headphone		
<b>Model:</b>	DU wireless		
<b>Adding Model:</b>	/		
<b>FCC ID</b>	2AETW-BT201601		
<b>Test Specification:</b>	FCC Part 15.247,Subpart C:2014		
<b>Test Date:</b>	2016-01-06 to 2016-03-01		
<b>Issue Date:</b>	2016-03-03		
<b>Test Result:</b>	PASS		
<b>Prepared By:</b>	<b>Reviewed By:</b>	<b>Approved By:</b>	
Bruce Li / Test Engineer	Lynn Xiao /Technical Manager	Yong Dai /Technical Manager	
			
Date:2016-03-03	Date:2016-03-03	Date:2016-03-03	
<b>Other Aspects:</b>			
/			
<b>Abbreviations:</b> ok / P = passed; fail / F = failed; n.a. / N = not applicable			
The test result in this test report refers exclusively to the presented test sample. This report shall not be reproduced except in full, without the written approval of GRGT.			

## **DIRECTIONS OF TEST**

1. This station carries out test task according to the national regulation of verifications which can be traced to National Primary Standards and BIPM.
2. The test report merely corresponds to the test sample. It is not permitted to copy extracts of these test result without the written permission of the test laboratory.
3. If there is any objection concerning the test, the client should inform the laboratory within 15 days from the date of receiving the test report.

## Table of Contents

- 1. TEST RESULT SUMMARY .....4**
- 2. GENERAL DESCRIPTION OF EUT.....5**
  - 2.1 APPLICANT .....5
  - 2.2 MANUFACTURER .....5
  - 2.3 BASIC DESCRIPTION OF EQUIPMENT UNDER TEST .....5
- 3. LABORATORY AND ACCREDITATIONS .....6**
  - 3.1 LABORATORY .....6
  - 3.2 ACCREDITATIONS.....6
  - 3.3 MEASUREMENT UNCERTAINTY .....6
  - 3.4 LIST OF USED TEST EQUIPMENT AT GRGT .....7
- 4. TEST RESULTS .....8**
  - 4.1 E.U.T. TEST CONDITIONS .....8
  - 4.2 ANTENNA REQUIREMENT.....12
  - 4.3 OCCUPIED BANDWIDTH .....13
    - 4.3.1 LIMITS.....13
    - 4.3.2 TEST PROCEDURES.....13
    - 4.3.3 TEST SETUP .....13
    - 4.3.4 TEST RESULTS .....13
  - 4.4 CARRIER FREQUENCIES SEPARATED .....17
    - 4.4.1 LIMITS.....17
    - 4.4.2 TEST PROCEDURES.....17
    - 4.4.3 TEST SETUP .....17
    - 4.4.4 TEST RESULTS .....17
  - 4.5 HOPPING CHANNEL NUMBER .....21
    - 4.5.1 LIMITS.....21
    - 4.5.2 TEST PROCEDURES.....21
    - 4.5.3 TEST SETUP .....21
    - 4.5.4 TEST RESULTS .....21
  - 4.6 DWELL TIME.....23
    - 4.6.1 LIMITS.....23
    - 4.6.2 TEST PROCEDURES.....23
    - 4.6.3 TEST SETUP .....24
    - 4.6.4 TEST RESULTS .....24
  - 4.7 CONDUCTED EMISSION MEASUREMENT .....28
    - 4.7.1 LIMITS.....28
    - 4.7.2 TEST PROCEDURES.....28
    - 4.7.3 TEST SETUP .....29
    - 4.7.4 TEST RESULTS .....30
  - 4.8 MAXIMUM PEAK OUTPUT POWER .....32
    - 4.8.1 LIMITS.....32
    - 4.8.2 TEST PROCEDURES.....32
    - 4.8.3 TEST SETUP .....32
    - 4.8.4 TEST RESULTS .....32
  - 4.9 RADIATED SPURIOUS EMISSIONS .....36
    - 4.9.1 LIMITS.....36
    - 4.9.2 TEST PROCEDURES.....36
    - 4.9.3 TEST SETUP .....37
    - 4.9.4 TEST RESULTS .....39
  - 4.10 BAND EDGES REQUIREMENT .....43
    - 4.10.1 LIMITS.....43
    - 4.10.2 TEST PROCEDURES.....43
    - 4.10.3 TEST SETUP .....43
    - 4.10.4 TEST RESULTS .....43
    - 4.10.5 RADIATED EMISSIONS WHICH FALL IN THE RESTRICTED BANDS .....47
- APPENDIX A: PHOTOGRAPH OF THE TEST ARRANGEMENT .....49**

**1. TEST RESULT SUMMARY**

<b>FCC Part 15.247:2014</b>			
<b>Standard</b>	<b>Item</b>	<b>Limit / Severity</b>	<b>Result</b>
FCC Part 15,Subpart C (15.247)	Antenna Requirement	Section 15.247 (c)	PASS
	Occupied Bandwidth	Section 15.247 (a1)	PASS
	Carrier Frequencies Separated	Section 15.247(a)(1)	PASS
	Hopping Channel Number	Section 15.247(a)(1)(iii)	PASS
	Dwell Time	Section 15.247(a)(1)(iii)	PASS
	Maximum Peak Output Power	Section 15.247(b)(1)	PASS
	Conducted Emission	Section 15.207	PASS
	Radiated Spurious Emission (30MHz to 25GHz)	Section 15.209 &15.247(d)	PASS
	Band Edges Measurement	Section 15.247 (d) &15.205	PASS

## 2. GENERAL DESCRIPTION OF EUT

### 2.1 APPLICANT

Name: Cleer Limited  
 Address: Unit518, Lakeside 1, Science Park West Ave. HK Science Park, HK.  
 N.T. Hong Kong

### 2.2 MANUFACTURER

Name: Shenzhen Grandsun Electronic Co., Ltd.  
 Address: Gaoqiao Industrial Park, Pingdi Town, Longgang Dist.,ShenzhenCity,  
 Guangdong,518116,China.

### 2.3 BASIC DESCRIPTION OF EQUIPMENT UNDER TEST

Equipment: Bluetooth headphone  
 Model: DU wireless  
 Adding Model: /  
 Trade Name: Cleer  
 Power supply DC USB 5V  
 Battery: Model: JHY852030  
 3.7V/450mAh  
 Frequency Range 2402MHz~2480MHz  
 Type of Modulation GFSK, 8DPSK, Pi/4 QPSK  
 Channels: Channels with 1MHz step  
 Antenna Gain: 3.89dBi  
 Antenna Type Printed Antenna  
 EUT connection description:  
 1. EUT connect with CSR chip controller board to work in a fixed frequency and FHSS mode. The Bluetooth chip of EUT has six pins (VCC, SPI\_CS, SPI\_CLK, SPI\_MOSI, SPI\_MISO and GND) to connect with same pins in controller board.  
 2. The CSR chip controller board connects with computer from a USB port. The computer has installed CSR test software (Blue suite) to control the board.

### 2.1 LOCAL SUPPORTIVE INSTRUMENTS

Name of Equipment	Manufacturer	Model	Serial Number
Notbook <sup>(4)</sup>	Lenovo	E46A	EB24320428
CSR chip Controller board	SUNITEC	/	/

	ENTERPRISE CO.,LTD		
USB cable	/	/	Unshielded,1m

Note :The notebook is just used to produce fixed frequency transmitting.

### 3. LABORATORY AND ACCREDITATIONS

#### 3.1 LABORATORY

The tests and measurements refer to this report were performed by Guangzhou GRG Metrology and Test CO., LTD.

Add. : 163 Pingyun Rd, West of Huangpu Ave, Guangzhou, 510656, P. R. China

Telephone: +86-20-38699959, 38699960, 38699961

Fax : +86-20-38695185

#### 3.2 ACCREDITATIONS

Our laboratories are accredited and approved by the following approval agencies.

<b>USA</b>	FCC Listed Lab (No. 688188)
<b>Canada</b>	Registration No.:8355A-1

#### 3.3 MEASUREMENT UNCERTAINTY

Where relevant, the following measurement uncertainty levels have been estimated for tests performed on the EUT as specified in CISPR 16-4-2:

Measurement		Frequency	Uncertainty
Radiated Emission	Horizontal	30MHz~1000MHz	4.2dB
		1GHz~26.5GHz	4.2dB
	Vertical	30MHz~1000MHz	4.4dB
		1GHz~26.5GHz	4.4dB
Conducted Emission		9kHz~30MHz	3.1 dB

This uncertainty represents an expanded uncertainty factor of  $k=2$ .

**3.4 LIST OF USED TEST EQUIPMENT AT GRGT**

<b>Name of Equipment</b>	<b>Manufacturer</b>	<b>Model</b>	<b>Serial Number</b>	<b>Calibration Due</b>
<b>Conducted Emissions</b>				
EMI Receiver	R&S	ESCI	100529	2017-02-15
L.I.S.N	SCHWARZBECK	NSLK 8127	8127450	2016-07-20
<b>Spurious Emissions/Restricted Bands</b>				
Receiver	R&S	ESU26	100526	2017-02-16
Loop antenna	R&S	HFH2-Z2	881058/28	2016-04-17
Bi-Log Antenna	ETS-LINDGREN	3142C	00075971	2016-04-18
Signal generator	Agilent	N5183A-540	MY50142096	2016-08-29
Horn antenna	SCHWARZBECK	BBHA9120D	752	2016-04-17
Horn antenna	ETS.LINDGREN	3117C	00075824	2016-05-05
Per-Amplifier	SCHWARZBECK	bbv9718	9718-276	2017-01-12
Semi-anechoic chamber	ETS	966(RFD-F/A-100)	3730	2016-12-31
<b>Carrier Frequency/ Hopping Channel Number/Maximum Peak Output Power/100kHz Bandwidth of Frequency Band Edge/ Occupied Bandwidth/ Dwell Time</b>				
Signal Analyzer	R&S	FSV30	103246	2017-02-15

## 4. TEST RESULTS

### 4.1 E.U.T. TEST CONDITIONS

**Type of antenna:** Internal pcb antenna

**Temperature:** 21.0 °C

**Humidity:** 56% RH

**Atmospheric Pressure:** 1011 mbar

**Test frequencies:** According to the 15.31(m) Measurements on intentional radiators or receivers, other than TV broadcast receivers, shall be performed and, if required, reported for each band in which the device can be operated with the device operating at the number of frequencies in each band specified in the following table:

Frequency range over which device operates	Number of frequencies	Location in the range of operation
1 MHz or less	1	Middle
1 to 10 MHz	2	1 near top and 1 near bottom
More than 10 MHz	3	1 near top, 1 near middle and 1 near bottom

#### EUT channels and frequencies list:

Channel	Frequency (MHz)	Channel	Frequency (MHz)	Channel	Frequency (MHz)
0	2402	14	2416	28	2430
1	2403	15	2417	29	2431
2	2404	16	2418	30	2432
3	2405	17	2419	31	2433
4	2406	18	2420	32	2434
5	2407	19	2421	33	2435
6	2408	20	2422	34	2436
7	2409	21	2423	35	2437
8	2410	22	2424	36	2438
9	2411	23	2425	37	2439
10	2412	24	2426	38	2440
11	2413	25	2427	39	2441
12	2414	26	2428	40	2442
13	2415	27	2429	41	2443



<b>Channel</b>	<b>Frequency (MHz)</b>	<b>Channel</b>	<b>Frequency (MHz)</b>	<b>Channel</b>	<b>Frequency (MHz)</b>
42	2444	55	2457	68	2470
43	2445	56	2458	69	2471
44	2446	57	2459	70	2472
45	2447	58	2460	71	2473
46	2448	59	2461	72	2474
47	2449	60	2462	73	2475
48	2450	61	2463	74	2476
49	2451	62	2464	75	2477
50	2452	63	2465	76	2478
51	2453	64	2466	77	2479
52	2454	65	2467	78	2480
53	2455	66	2468		
54	2456	67	2469		

Test frequency is the lowest channel: 0 channel(2402MHz), middle channel: 39 channel(2441MHz) and highest channel: 78 channel(2480MHz)

## Frequency Hopping System Requirement

### Test Requirement: Section 15.247 (a)(1), (g), (h) requirement:

The system shall hop to channel frequencies that are selected at the system hopping rate from a Pseudorandom ordered list of hopping frequencies. Each frequency must be used equally on the average by each transmitter. The system receivers shall have input bandwidths that match the hopping channel bandwidths of their corresponding transmitters and shall shift frequencies in synchronization with the transmitted signals.

Frequency hopping spread spectrum systems are not required to employ all available hopping channels during each transmission. However, the system, consisting of both the transmitter and the receiver, must be designed to comply with all of the regulations in this section should the transmitter be presented with a continuous data (or information) stream. In addition, a system employing short transmission bursts must comply with the definition of a frequency hopping system and must distribute its transmissions over the minimum number of hopping channels specified in this section.

The incorporation of intelligence within a frequency hopping spread spectrum system that permits the system to recognize other users within the spectrum band so that it individually and independently chooses and adapts its hop sets to avoid hopping on occupied channels is permitted. The coordination of frequency hopping systems in any other manner for the express purpose of avoiding the simultaneous occupancy of individual hopping frequencies by multiple transmitters is not permitted.

### Compliance for section 15.247(a) (1)

According to Bluetooth Core Specification, the pseudorandom sequence may be generated in a nine-stage shift register whose 5th and 9th stage outputs are added in a modulo-two addition stage. And the result is fed back to the input of the first stage. The sequence begins with the first ONE of 9 consecutive ONES; i.e. the shift register is initialized with nine ones.

- Number of shift registers stages: 9
- Length of pseudo-random sequence:  $2^9 - 1 = 511$  bits
- Longest sequence of zeros: 8 (non-inverted signal)

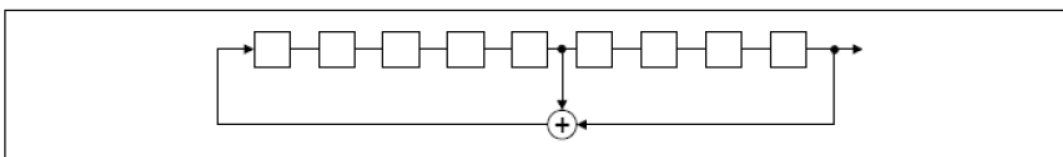

*Linear Feedback Shift Register for Generation of the PRBS sequence*

An example of Pseudorandom Frequency Hopping Sequence as follow:

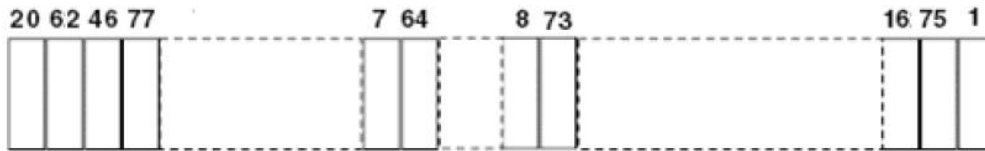

Each frequency used equally on the average by each transmitter.

According to Bluetooth Core Specification, Bluetooth receivers are designed to have input and IF bandwidths that match the hopping channel bandwidths of any Bluetooth transmitters and shift frequencies in synchronization with the transmitted signals.

**Compliance for section 15.247(g)**

According to Bluetooth Core Specification, the Bluetooth system transmits the packet with the pseudorandom hopping frequency with a continuous data and the short burst transmission from the Bluetooth system is also transmitted under the frequency hopping system with the pseudorandom hopping frequency system.

**Compliance for section 15.247(h)**

According to Bluetooth Core specification, the Bluetooth system incorporates with an adaptive system to detect other user within the spectrum band so that it individually and independently to avoid hopping on the occupied channels.

According to the Bluetooth Core specification, the Bluetooth system is designed not have the ability to coordinate with other FHSS System in an effort to avoid the simultaneous occupancy of individual hopping frequencies by multiple transmitter.

Reference document: BlueMod+B20-The Official Bluetooth SIG Member Website.

### 4.2 ANTENNA REQUIREMENT

The EUT antenna is internal antenna. Antenna gain is 3.89dBi .which accordance 15.203.is considered sufficient to comply with the provisions of this section.

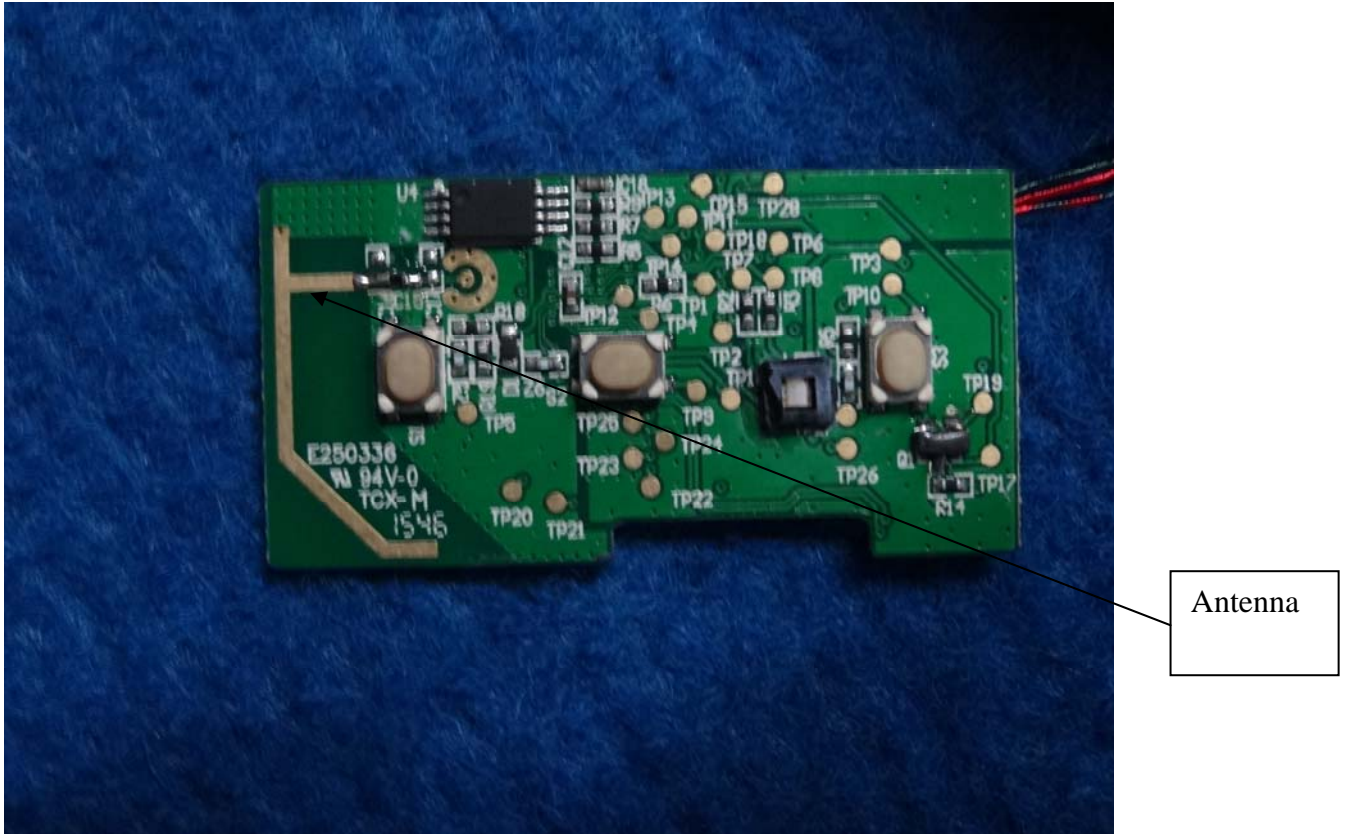

### 4.3 OCCUPIED BANDWIDTH

#### 4.3.1 LIMITS

Frequency hopping systems operating in the 2400-2483.5 MHz band may have hopping channel carrier frequencies that are separated by 25 kHz or two-thirds of the 20 dB bandwidth of the hopping channel, whichever is greater, provided the systems operate with an output power no greater than 125 mW.

#### 4.3.2 TEST PROCEDURES

Test procedures follow ANSI C63.10:2013.

1. Remove the antenna from the EUT and then connect a low RF cable from the antenna port to the spectrum;
2. Set the spectrum analyzer: Span = approximately 2 to 3 times the 20dB bandwidth, centre on a hopping channel;
3. Set the spectrum analyzer: RBW  $\geq$  1% of the 20dB bandwidth (set 100 kHz). VBW  $\geq$  RBW. Sweep = auto; Detector Function = Peak. Trace = Max Hold.
4. Mark the peak frequency and -20dB bandwidth.
5. Bandwidth value is OBW value.

**Remark:**

Pre-test the 3 modulation to find GFSK and 8DPSK is worse case, so only record GFSK and 8DPSK test data.

#### 4.3.3 TEST SETUP

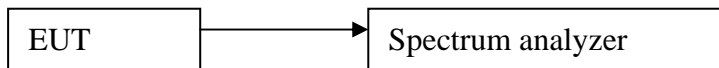

#### 4.3.4 TEST RESULTS

**For GFSK**

Frequency (GHz)	Test Channel	bandwidth
2.402	Lowest	0.929MHz
2.441	Middle	0.920MHz
2.480	Highest	0.929MHz

**For 8DPSK**

Frequency (GHz)	Test Channel	bandwidth
2.402	Lowest	1.255MHz
2.441	Middle	1.250MHz
2.480	Highest	1.259MHz

Result plot as follows:

**GFSK Lowest Channel:**

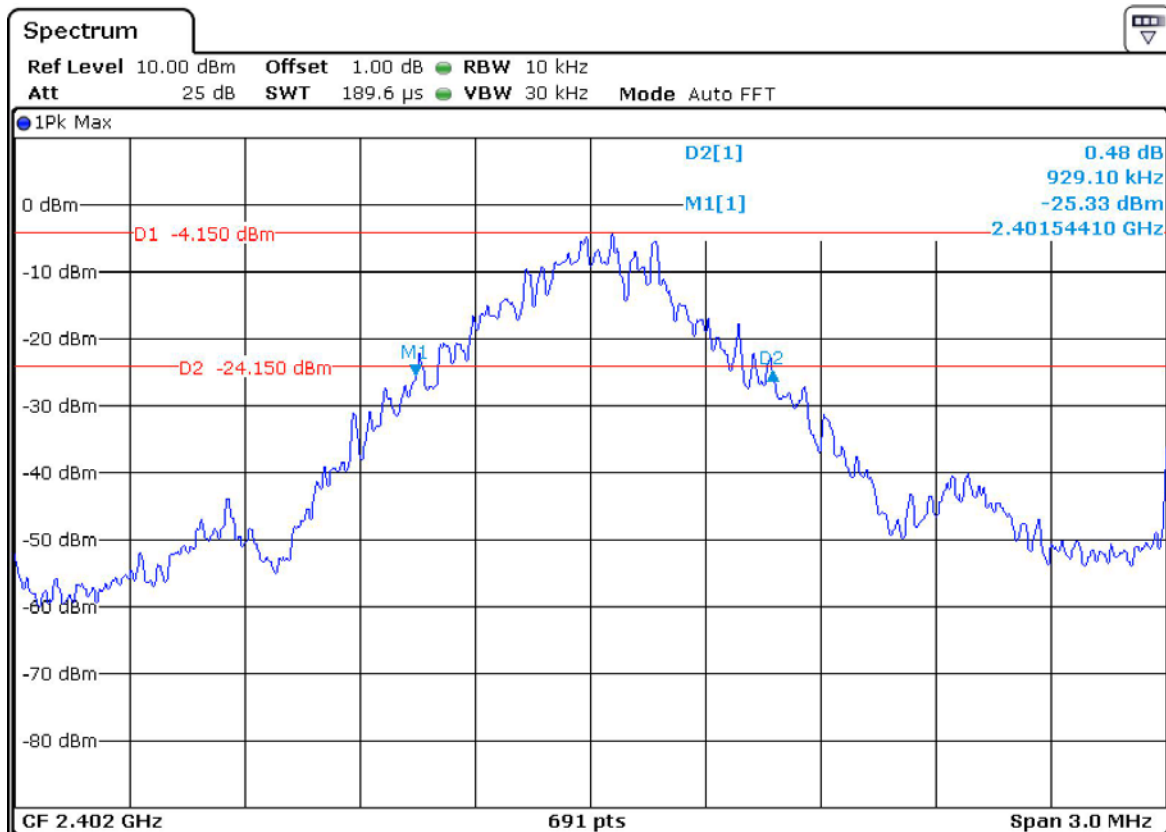

**GFSK Middle Channel:**

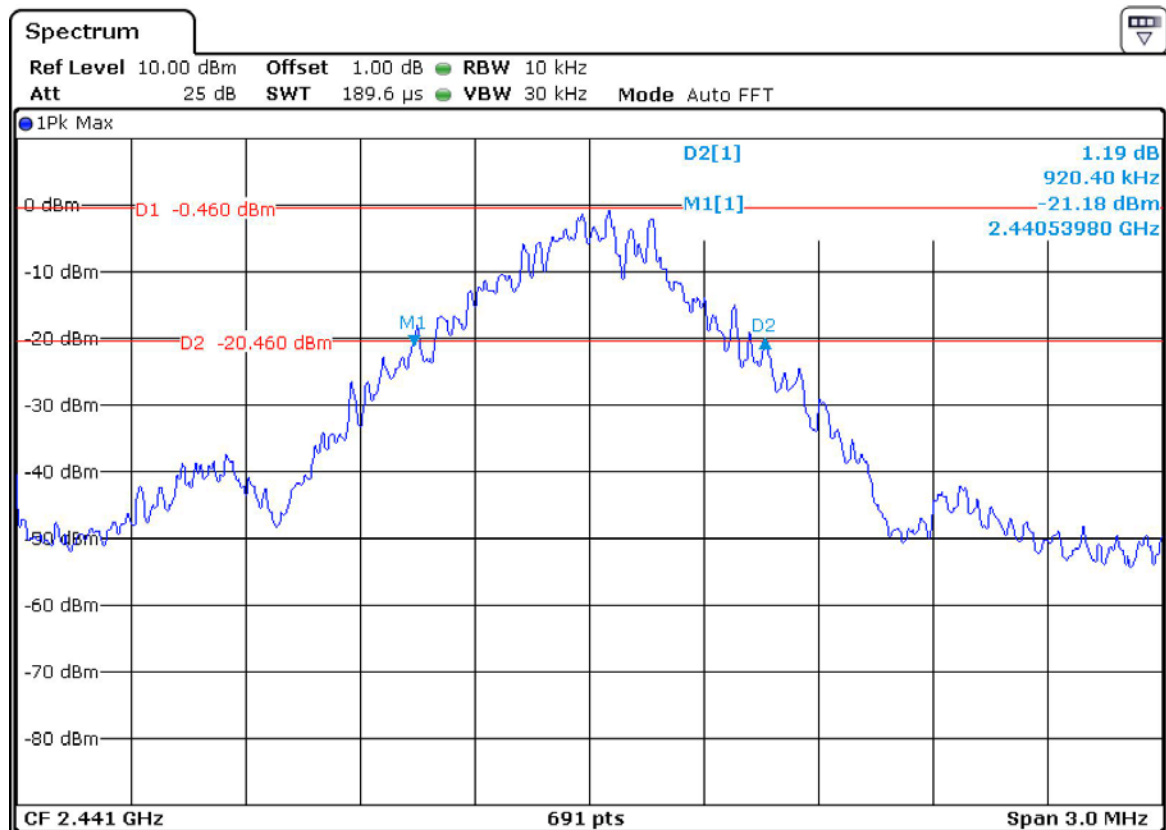

**GFSK Highest Channel:**

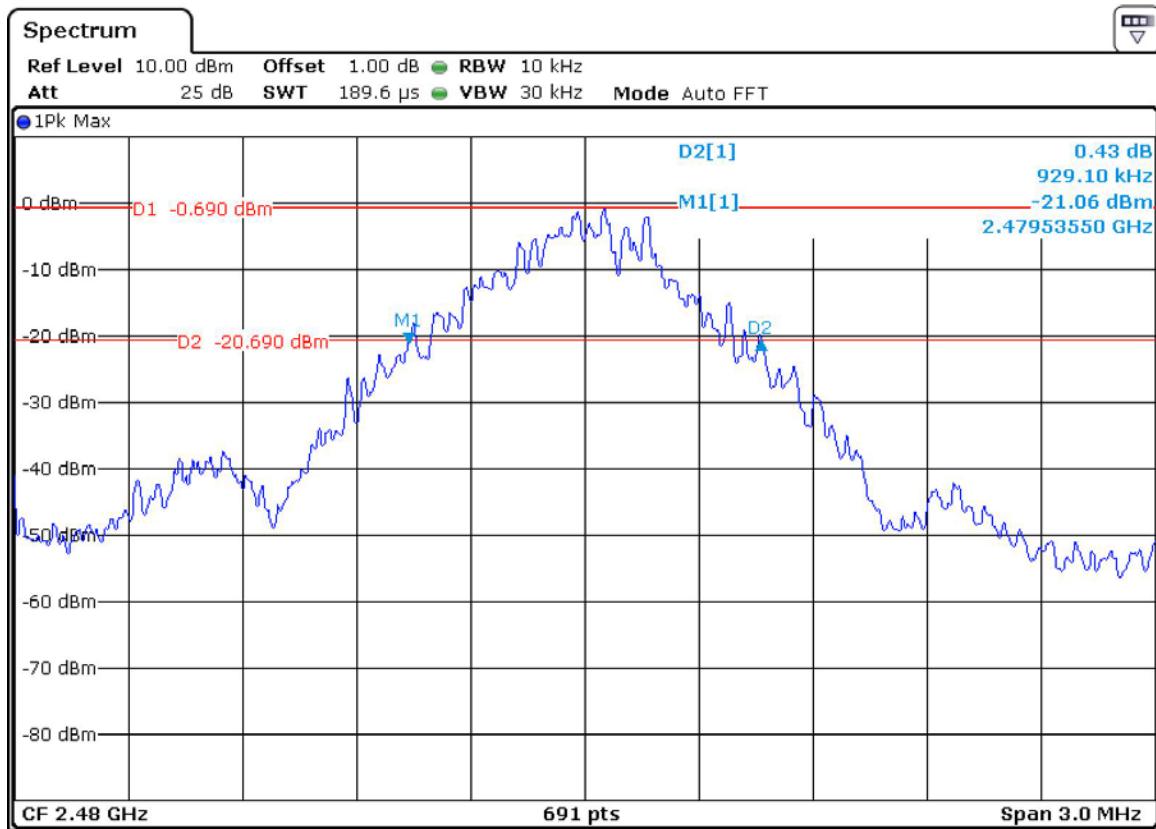

**8DPSK Lowest Channel:**

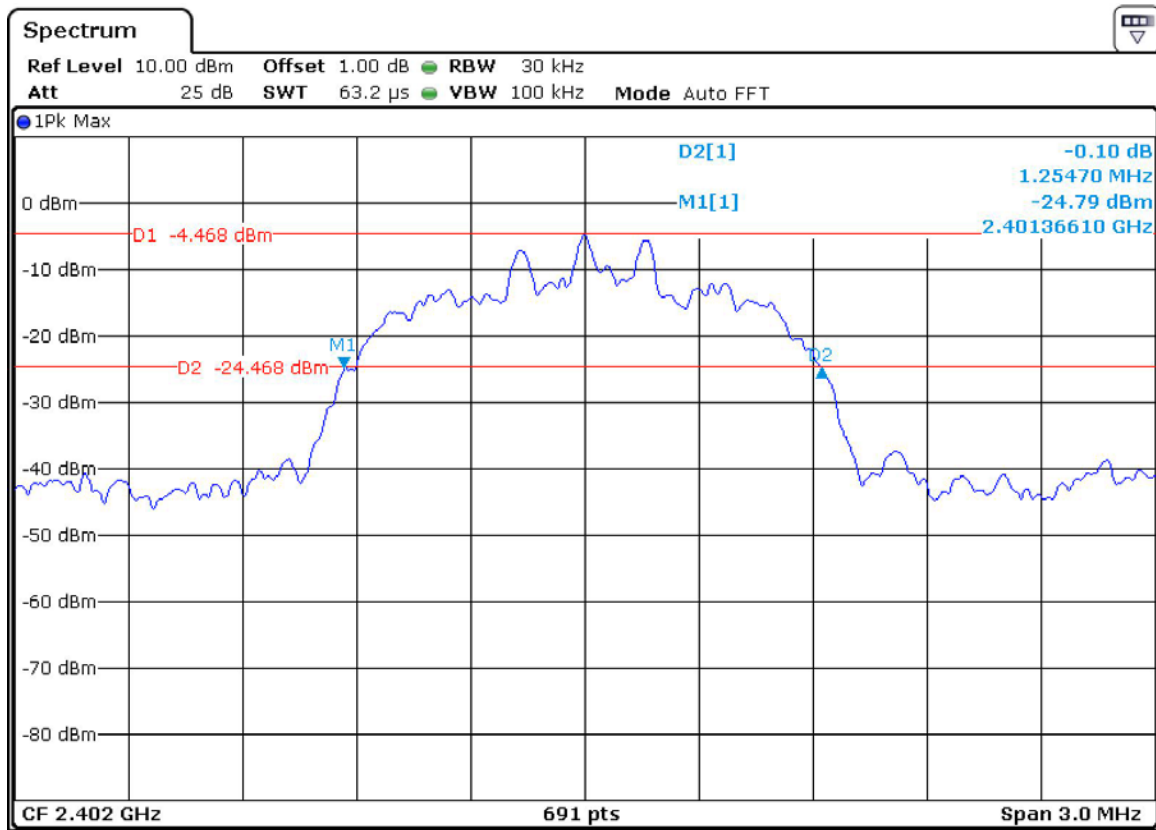

### 8DPSK Middle Channel:

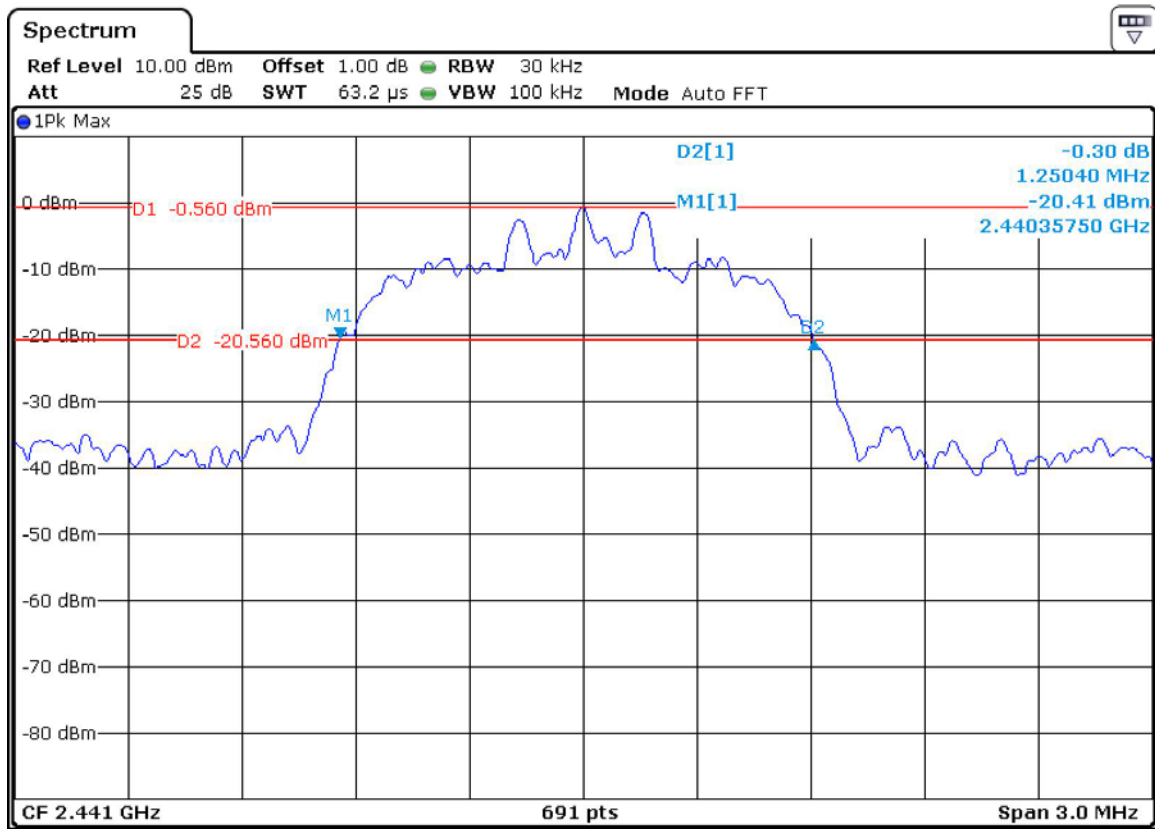

### 8DPSK Highest Channel:

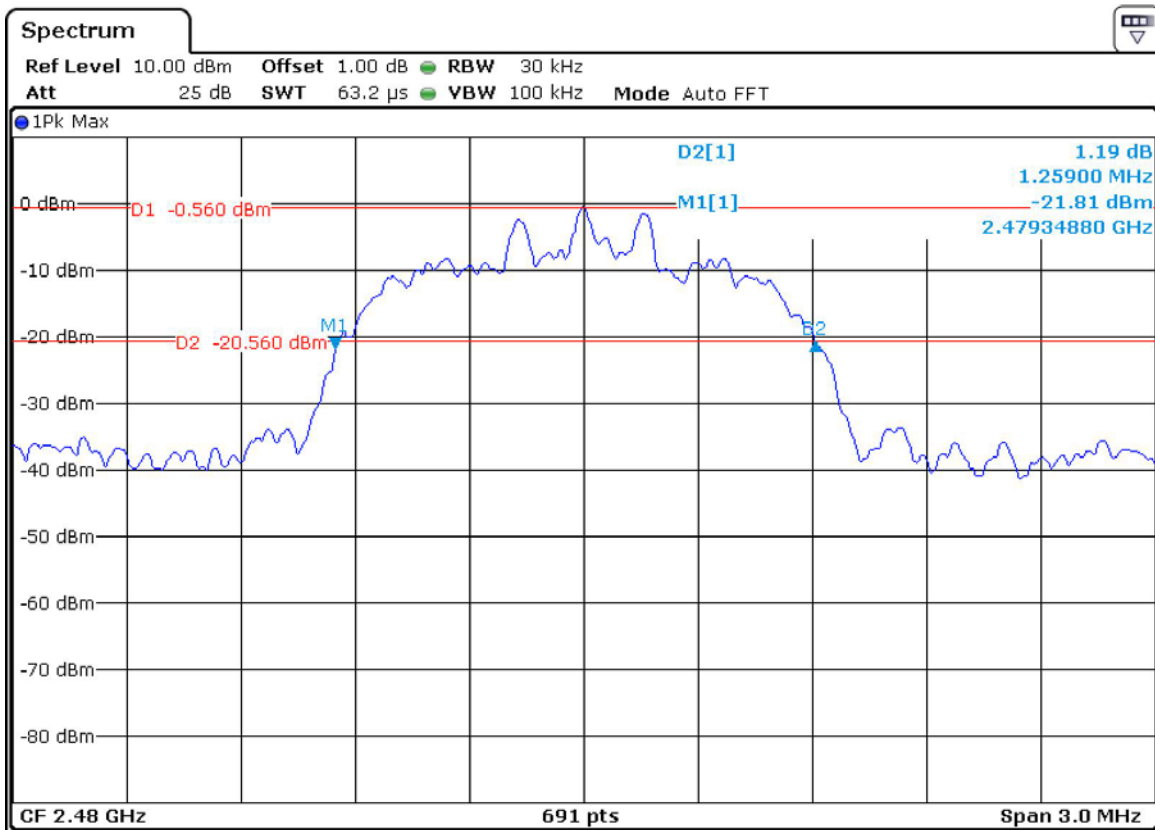



## 4.4 CARRIER FREQUENCIES SEPARATED

### 4.4.1 LIMITS

Frequency hopping systems operating in the 2400-2483.5 MHz band may have hopping channel carrier frequencies that are separated by 25 kHz or two-thirds of the 20 dB bandwidth of the hopping channel, whichever is greater, provided the systems operate with an output power no greater than 125 mW.

### 4.4.2 TEST PROCEDURES

Test procedures follow ANSI C63.10:2013.

1. Remove the antenna from the EUT and then connect a low RF cable from the antenna port to the spectrum.
2. Set the spectrum analyzer: RBW  $\geq$  1% of the span (set 100 kHz). VBW  $\geq$  RBW, Span = 3MHz. Sweep = auto; Detector Function = Peak. Trace = Max, hold.
3. Allow the trace to stabilize. Use the marker-delta function to determine the separation between the peaks of the adjacent channels. The limit is specified in one of the subparagraphs of this Section. Submit this plot.

**Remark :**

Pre-test the 3 modulation to find GFSK and 8DPSK is worse case, so only record GFSK and 8DPSK test data.

### 4.4.3 TEST SETUP

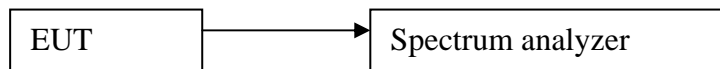

### 4.4.4 TEST RESULTS

Mode	Test Channel	Carrier Frequencies Separated	2/3 20 dB bandwidth	PASS/FAIL
GFSK	Lower Channels (channel 0 and channel 1)	1.003MHz	0.619 MHz	Pass
	Middle Channels (channel 39 and channel 40)	1.003MHz	0.613 MHz	Pass
	Upper Channels (channel 77 and channel 78)	0.999MHz	0.619 MHz	Pass
8DPSK	Lower Channels (channel 0 and channel 1)	0.999MHz	0.837 MHz	Pass
	Middle Channels (channel 39 and channel 40)	0.999MHz	0.833 MHz	Pass
	Upper Channels (channel 77 and channel 78)	1.003MHz	0.839 MHz	Pass

Note: The two-thirds of the 20 dB bandwidth is greater than 25 kHz, so the limit for the two-thirds of the 20 dB bandwidth is applied.

Result plot as follows:

GFSK Lowest Channels:

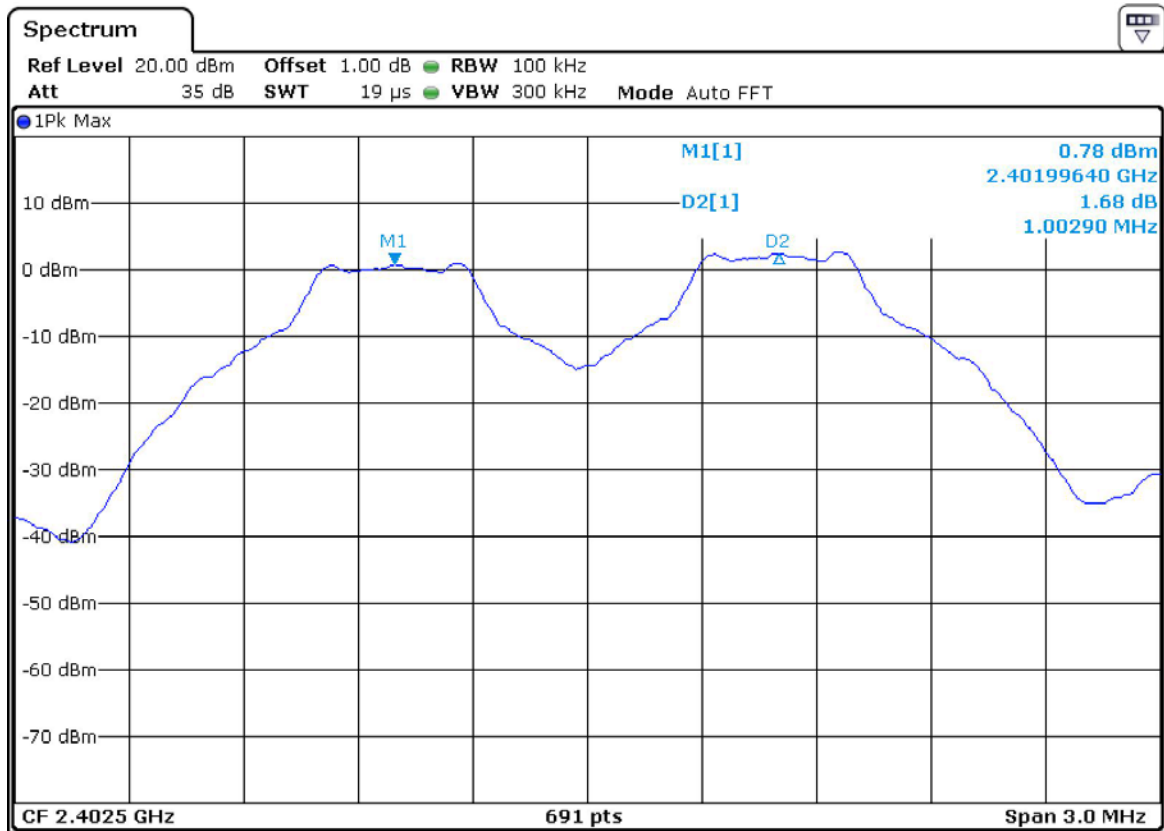

GFSK Middle Channels:

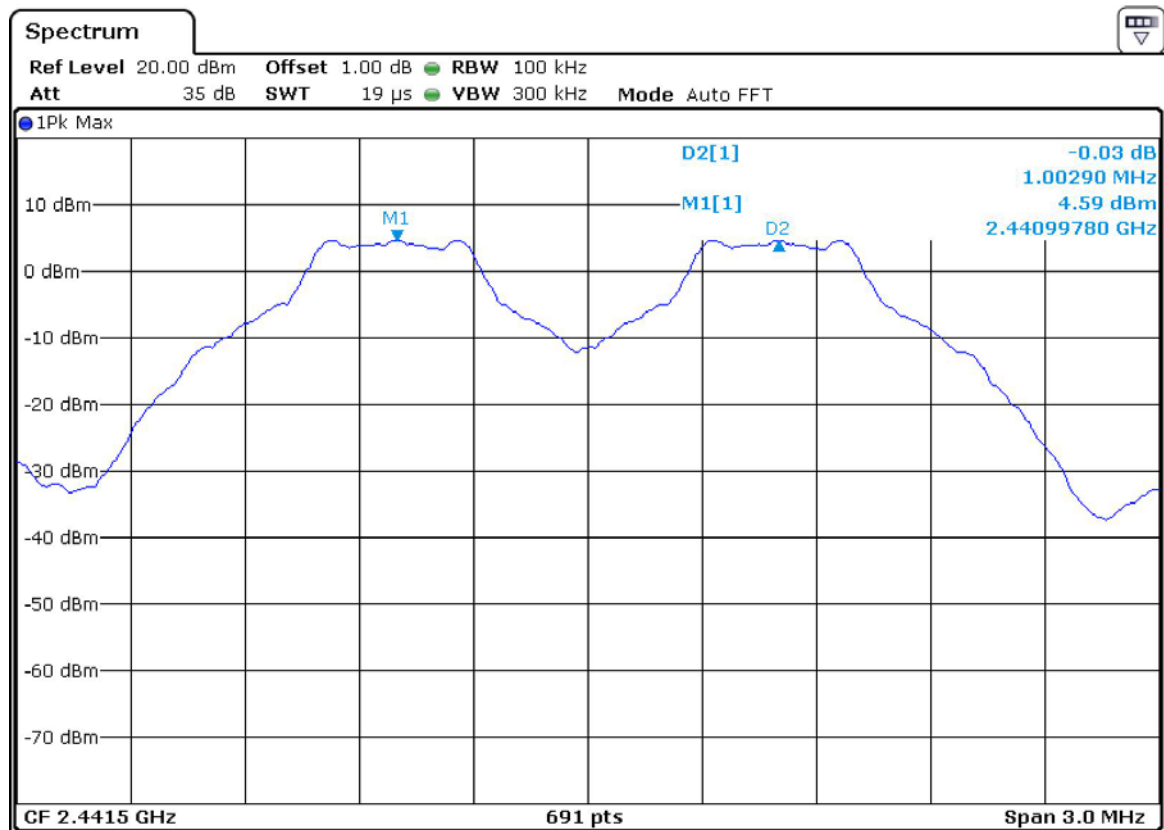

GFSK Highest Channels:

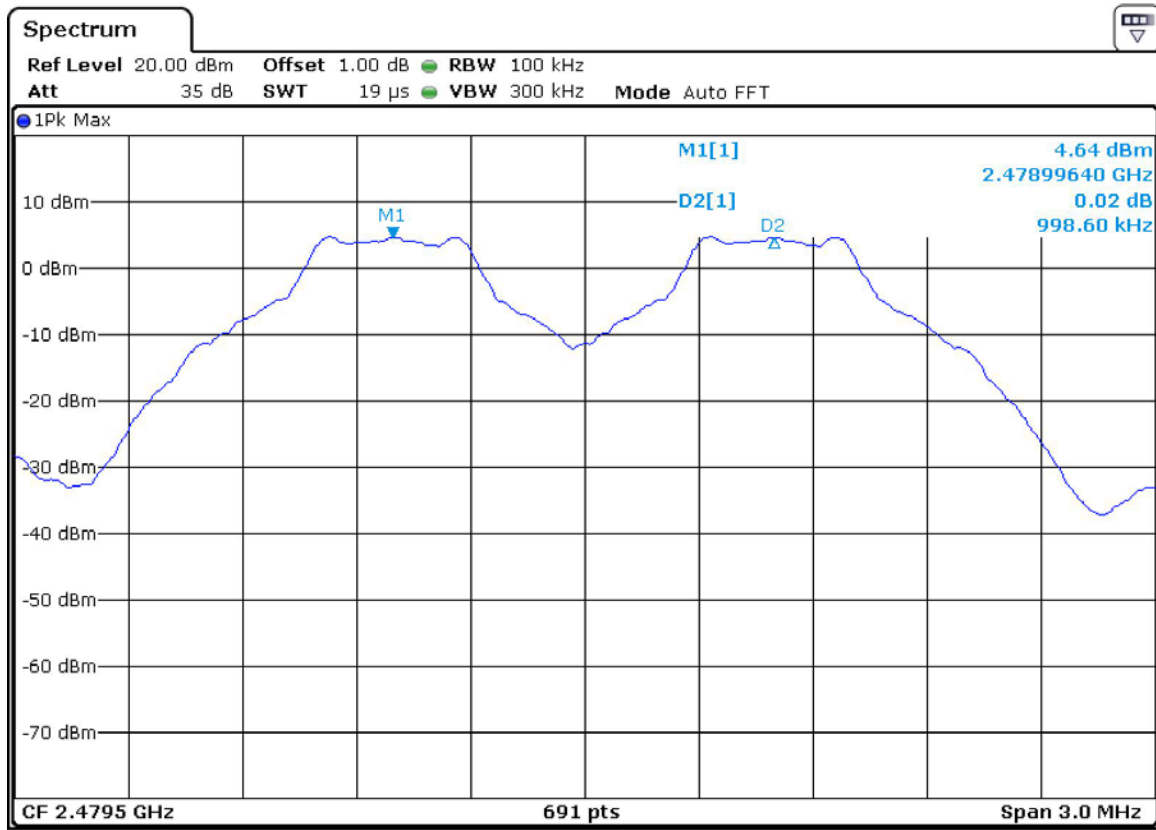

8DPSK Lowest Channels:

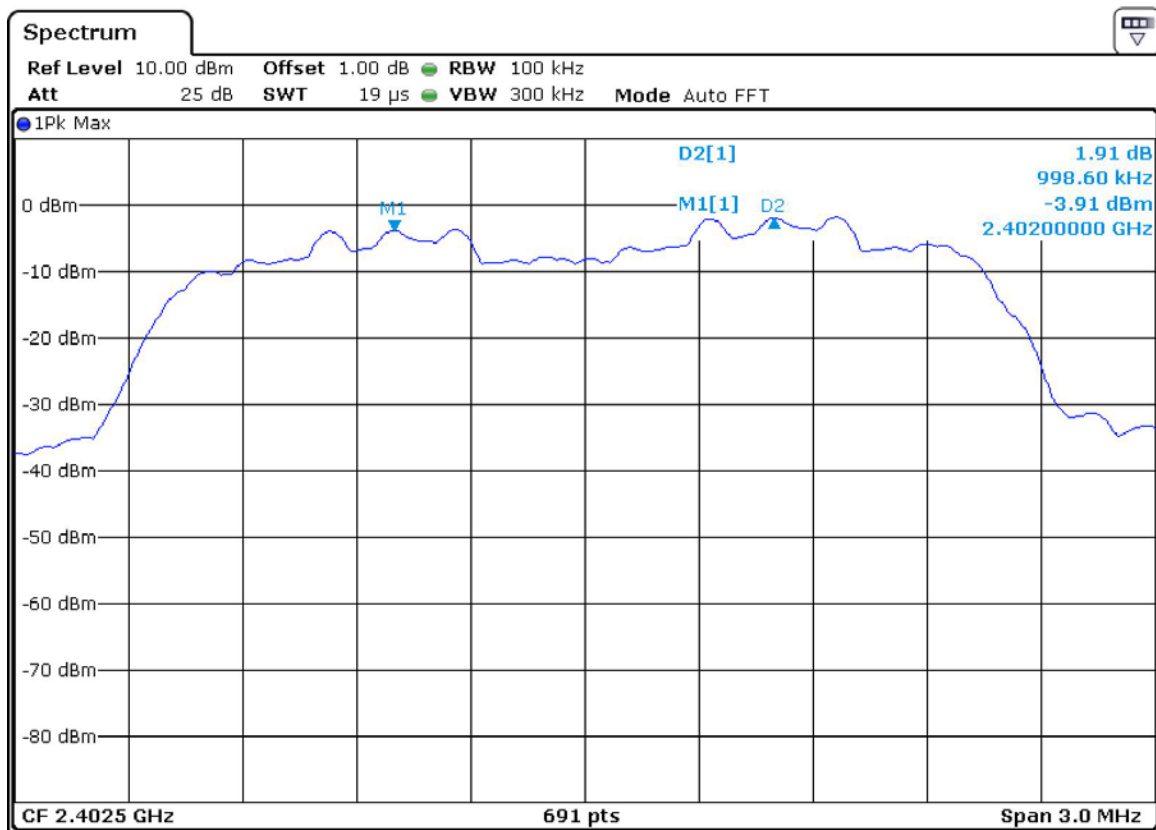

8DPSK Middle Channels:



8DPSK Highest Channels:



Test result: The unit does meet the FCC requirements.

## 4.5 HOPPING CHANNEL NUMBER

### 4.5.1 LIMITS

Regulation 15.247 (a) (1)(iii) Frequency hopping systems in the 2400-2483.5 MHz band shall use at least 15 channels.

### 4.5.2 TEST PROCEDURES

Test procedures follow ANSI C63.10:2013.

1. Remove the antenna from the EUT and then connect a low RF cable from the antenna port to the spectrum.
2. Set the spectrum analyzer: RBW = 100 kHz. VBW = 100 kHz. Sweep = auto; Detector Function = Peak. Trace = Max hold.
3. Allow the trace to stabilize. It may prove necessary to break the span up to sections. in order to clearly show all of the hopping frequencies. The limit is specified in one of the subparagraphs of this Section.
4. Set the spectrum analyzer: start frequency = 2400MHz. stop frequency = 2483.5MHz. Submit the test result graph.

### 4.5.3 TEST SETUP

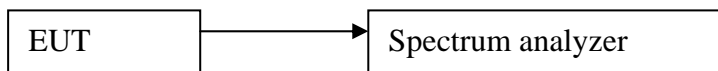

### 4.5.4 TEST RESULTS

**Test result:** Total channels are 79 channels.

Result plot as follows:

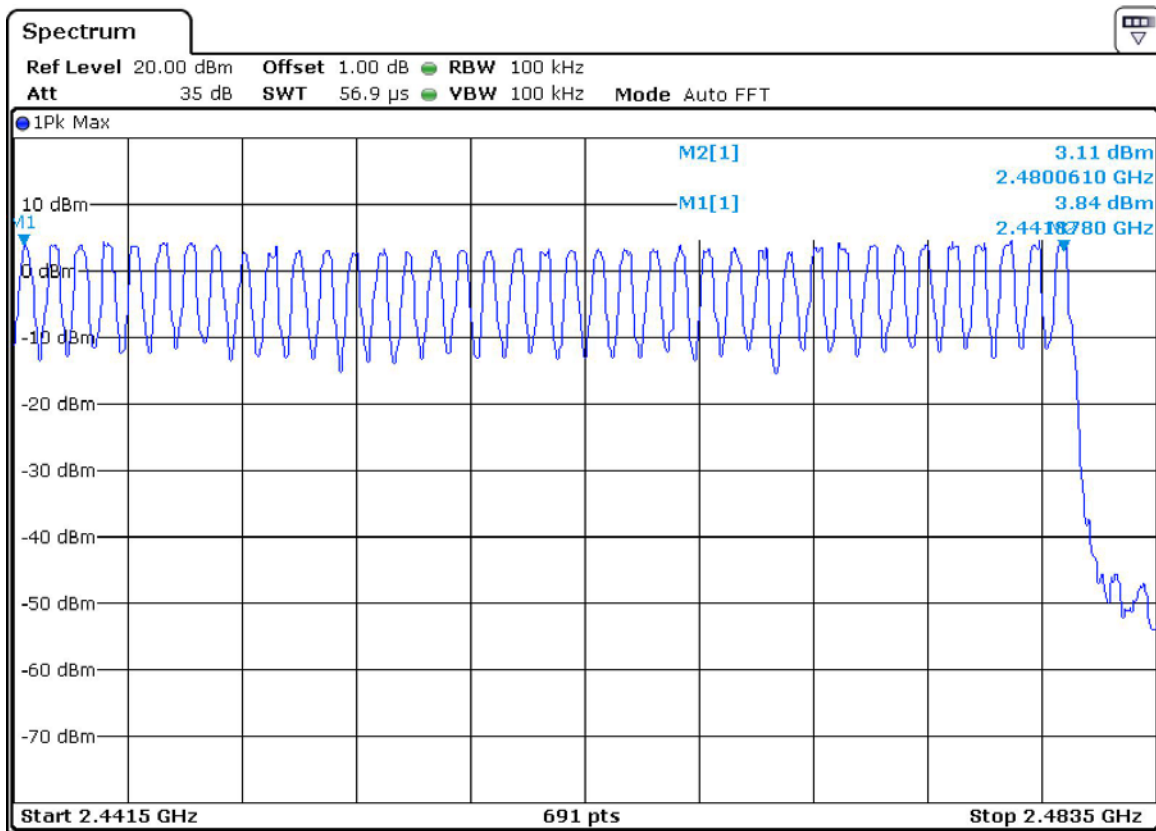
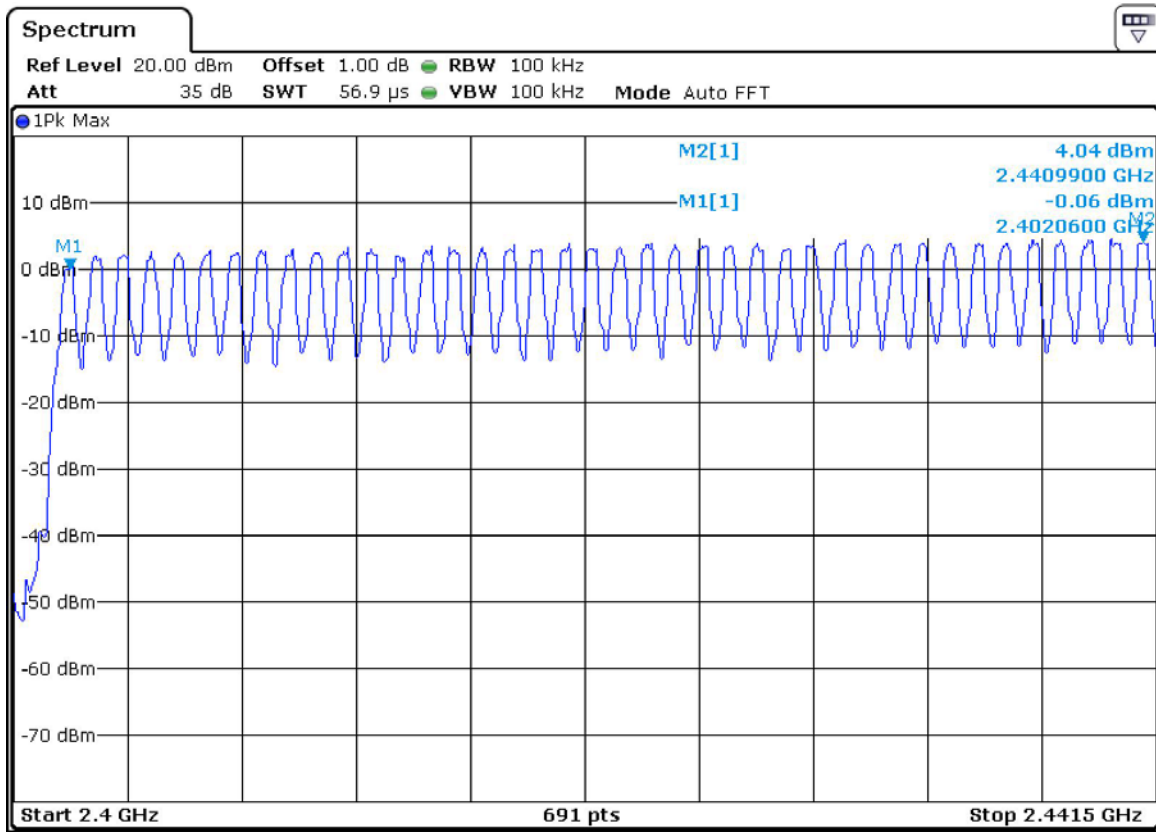

**Test result: The unit does meet the FCC requirements.**

## 4.6 DWELL TIME

### 4.6.1 LIMITS

Regulation 15.247(a)(1)(iii) Frequency hopping systems in the 2400-2483.5 MHz band shall use at least 15 channels. The average time of occupancy on any channel shall not be greater than 0.4 seconds within a period of 0.4 seconds multiplied by the number of hopping channels employed. Frequency hopping systems may avoid or suppress transmissions on a particular hopping frequency provided that a minimum of 15 channels are used.

### 4.6.2 TEST PROCEDURES

Test procedures follow ANSI C63.10:2013.

1. Remove the antenna from the EUT and then connect a low attenuation cable from the antenna port to the spectrum.

The analyzer shall be set as follows:

Centre Frequency: Equal to the hopping frequency being investigated

Frequency Span: 0 Hz

RBW: ~ 50 % of the Occupied Channel Bandwidth

VBW:  $\geq$  RBW

Detector Mode: RMS

Sweep time: Equal to the Dwell Time  $\times$  Minimum number of hopping frequencies (N)

Number of sweep points: 30 000

Trace mode: Clear / Write

Trigger: Free Run

2. Save the trace data to a file for further analysis by a computing device using an appropriate software application or program.

3. Identify the data points related to the frequency being investigated by applying a threshold. The data points resulting from transmissions on the hopping frequency being investigated are assumed to have much higher levels compared to data points resulting from transmissions on adjacent hopping frequencies. If a clear determination between these transmissions is not possible, the RBW in step 1 shall be further reduced. In addition, a channel filter may be used. Count the number of data points identified as resulting from transmissions on the frequency being investigated and multiply this number by the time difference between two consecutive data points.

4. The result in step 3 is the accumulated Dwell Time which shall comply with the limit and which shall be recorded in the test report.

5. Make the following changes on the analyzer and repeat steps 2 and 3. Sweep time:  $4 \times$  Dwell Time  $\times$  Actual numbers of hopping frequencies in use

6. The hopping frequencies occupied by the system without having transmissions during the dwell time (blacklisted frequencies) should be taken into account in the actual number of hopping frequencies in use. If this number cannot be determined (number of blacklisted frequencies unknown) it shall be assumed that the equipment uses the minimum number of hopping frequencies. The result shall be compared to the limit for the Minimum Frequency Occupation Time. This value shall be recorded in the test report.

7. Make the following changes on the analyzer:

Start Frequency: 2 400 MHz

Stop Frequency: 2 483,5 MHz

RBW: ~ 50 % of the Occupied Channel Bandwidth (single hop)

VBW: ≥ RBW

Detector Mode: RMS

Sweep time: Auto

Trace Mode: Max Hold

Trigger: Free Run

When the trace has completed, identify the number of hopping frequencies used by the hopping sequence. The result shall be compared to the limit (value N). This value shall be recorded in the test report. For equipment with blacklisted frequencies, it might not be possible to verify the number of hopping frequencies in use. However they shall comply with the requirement for accumulated Dwell time and Minimum Frequency Occupation Time assuming the minimum number of hopping frequencies is in use.

8. For adaptive systems, using the lowest and highest -20 dB points from the total spectrum envelope obtained in step 6, it shall be verified whether the system uses 70 % of the band specified in clause 1. The result shall be recorded in the test report.

9. Use the marker-delta function to determine the dwell time. If this value varies with different modes of operation (e.g.. data rate. modulation format. etc.). Repeat this test for each variation. The limit is specified in one of the subparagraphs of this Section. Submit this plot(s). An oscilloscope may be used instead of a spectrum analyzer.

### 4.6.3 TEST SETUP

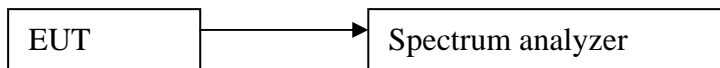

### 4.6.4 TEST RESULTS

Frequency (MHz)	Modulation	Packet	Accumulated Transmit Time Per Hop(ms)	Number of Hopping Channel in 31.6s	Maximum Accumulated Transmit Time (s)	Limit (s)	Result
2441	8DPSK	3DH1	0.406	320	0.130	0.4	Pass
		3DH3	1.652	160	0.264	0.4	Pass
		3DH5	2.891	110	0.318	0.4	Pass

**Remark:** The average time of occupancy in the specified 31.6 second period is equal to pulse width\*(time of pulse in observation period)\*(test period / observation period)

**The results are not greater than 0.4 seconds.  
The unit does meet the requirements.**

Please refer the graph as below:



**For 3DH1:  
Pulse Width:**

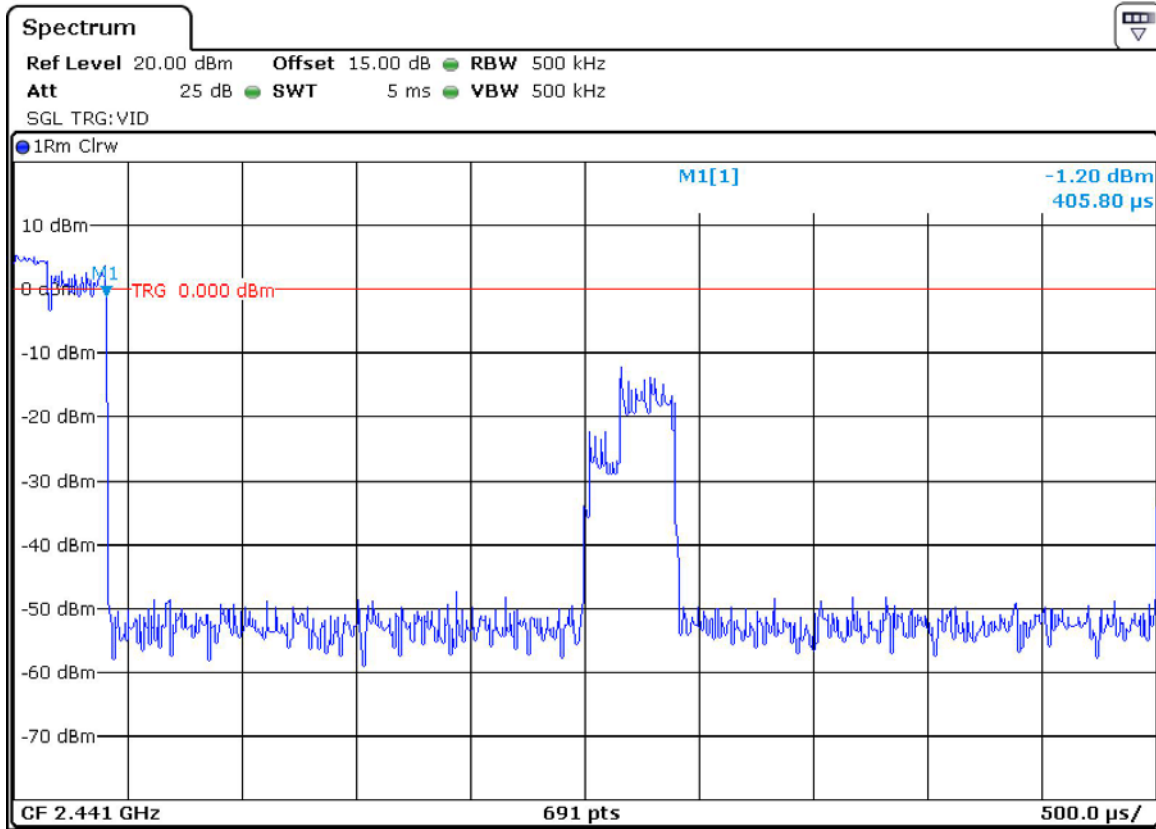

**Number of Pulses in 3.16 S observation periods:**

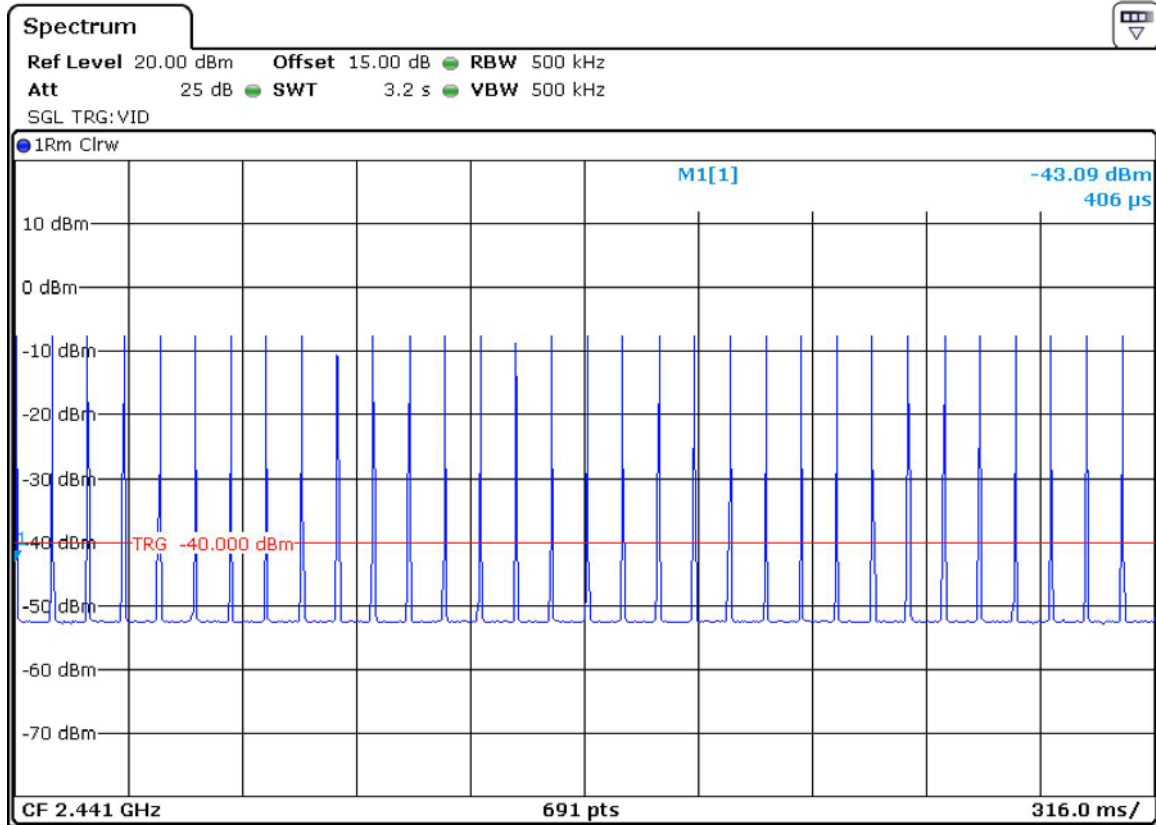

**For 3DH3:  
Pulse Width:**

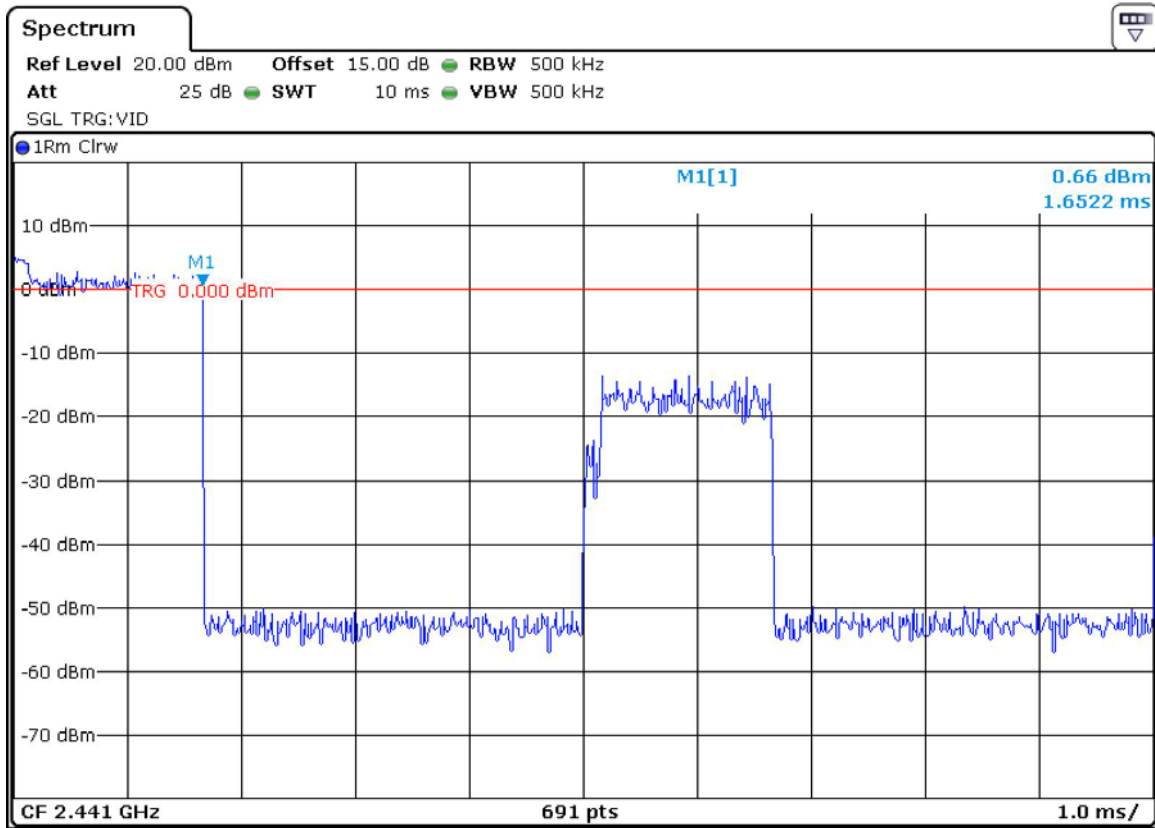

**Number of Pulses in 3.16 S observation periods:**

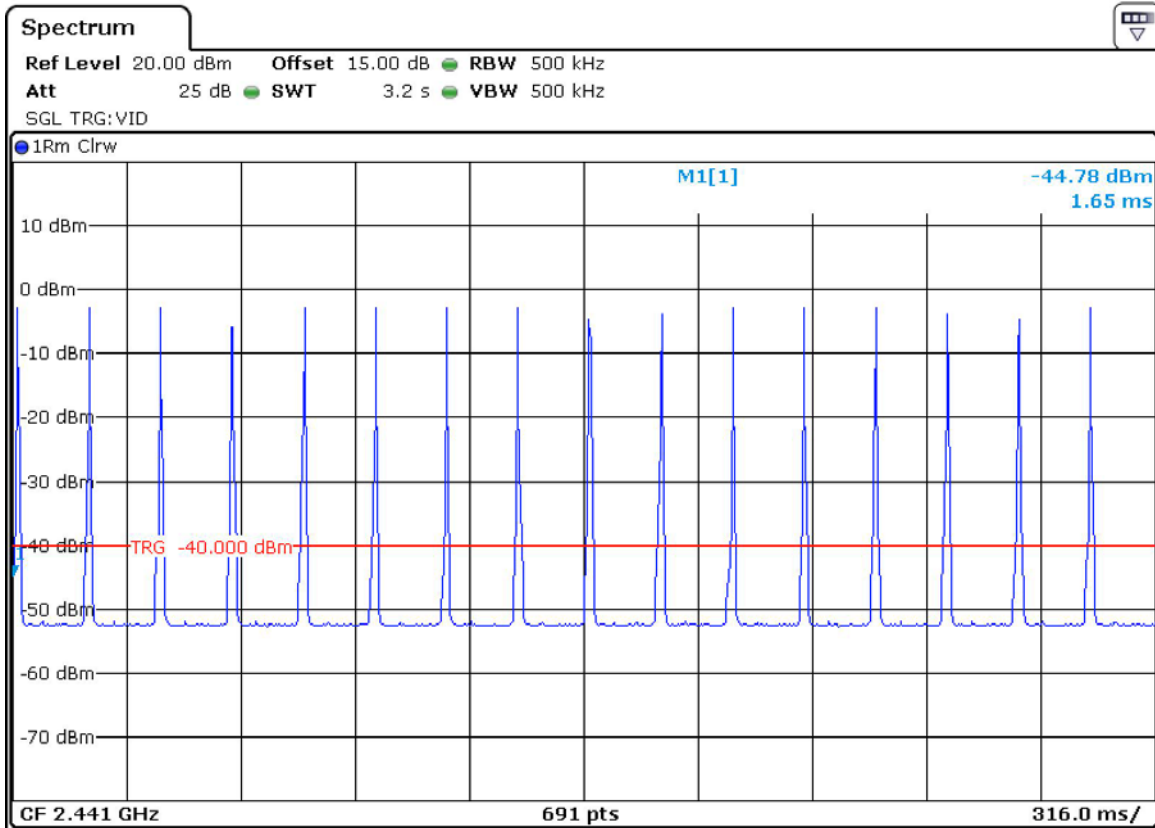

**For 3DH5:  
Pulse Width:**

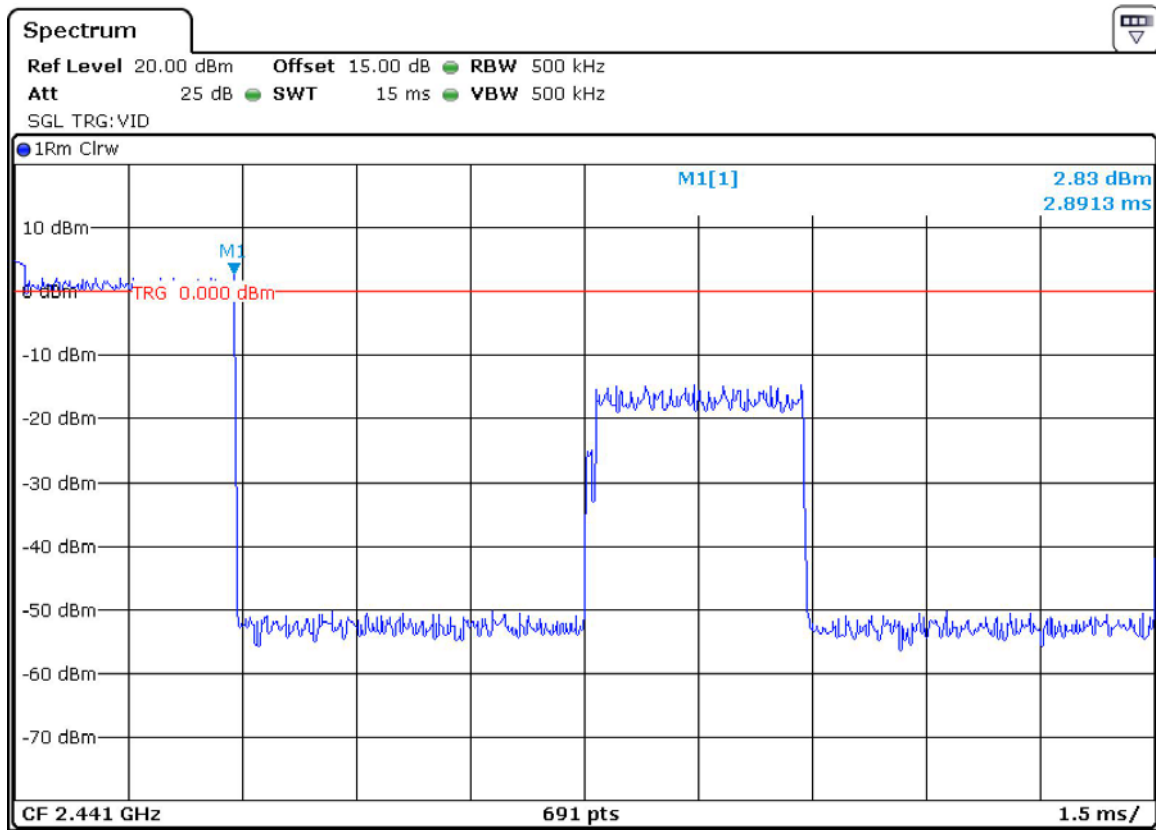

**Number of Pulses in 3.16 S observation periods:**

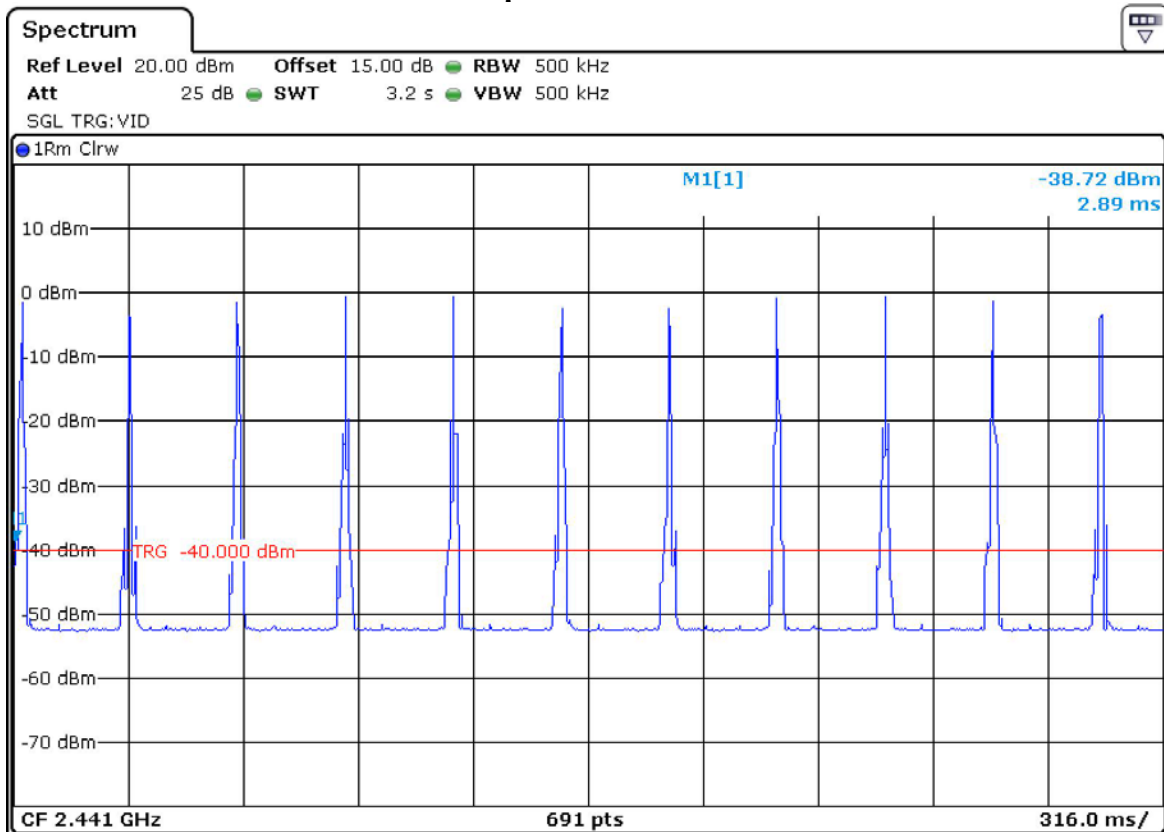

## 4.7 CONDUCTED EMISSION MEASUREMENT

### 4.7.1 LIMITS

Frequency range	Limits (dB $\mu$ V)	
	Quasi-peak	Average
150kHz ~ 0.5MHz	66~56	56~46
0.5 MHz ~ 5 MHz	56	46
5 MHz ~ 30 MHz	60	50

### 4.7.2 TEST PROCEDURES

#### Procedure of Preliminary Test

Test procedures follow ANSI C63.10:2013.

For measurement of the disturbance voltage the equipment under test (EUT) is connected to the power supply mains and any other extended network via one or more artificial network(s). An EUT, whether intended to be grounded or not, and which is to be used on a table is configured as follows:

- Either the bottom or the rear of the EUT shall be at a controlled distance of 40 cm from a reference ground plane. This ground plane is normally the wall or floor of a shielded room. It may also be a grounded metal plane of at least 2 m by 2 m. This is physically accomplished as follows:
  - 1) Place the EUT on a table of non-conducting material which is at least 80 cm high. Place the EUT so that it is 40 cm from the wall of the shielded room, or
  - 2) place the EUT on a table of non-conducting material which is 40 cm high so that the bottom of the EUT is 40 cm above the ground plane;
- All other conductive surfaces of the EUT shall be at least 80 cm from the reference ground plane;
- The EUT are placed on the floor that one side of the housings is 40 cm from the vertical reference ground plane and other metallic parts;
- Interconnecting cables that hang closer than 40 cm to the ground plane shall be folded back and forth forming a bundle 30 cm to 40 cm long, hanging approximately in the middle between the ground plane and the table.
- I/O cables that are connected to a peripheral shall be bundled in the centre. The end of the cable may be terminated if required using correct terminating impedance. The total length shall not exceed 1 m.

The test mode(s) described in Item 2.4 were scanned during the preliminary test. After the preliminary scan, we found the test mode described in Item 2.4 producing the highest emission level. The EUT configuration and cable configuration of the above highest emission levels were recorded for reference of the final test.

#### Procedure of Final Test

EUT and support equipment were set up on the test bench as per the configuration with highest emission level in the preliminary test. A scan was taken on both power lines, recording at least the six highest emissions. Emission frequency and amplitude were recorded into a computer in which correction factors were used to calculate the emission level and compare reading to the applicable limit. The test data of the worst-case condition(s) was recorded.

### 4.7.3 TEST SETUP

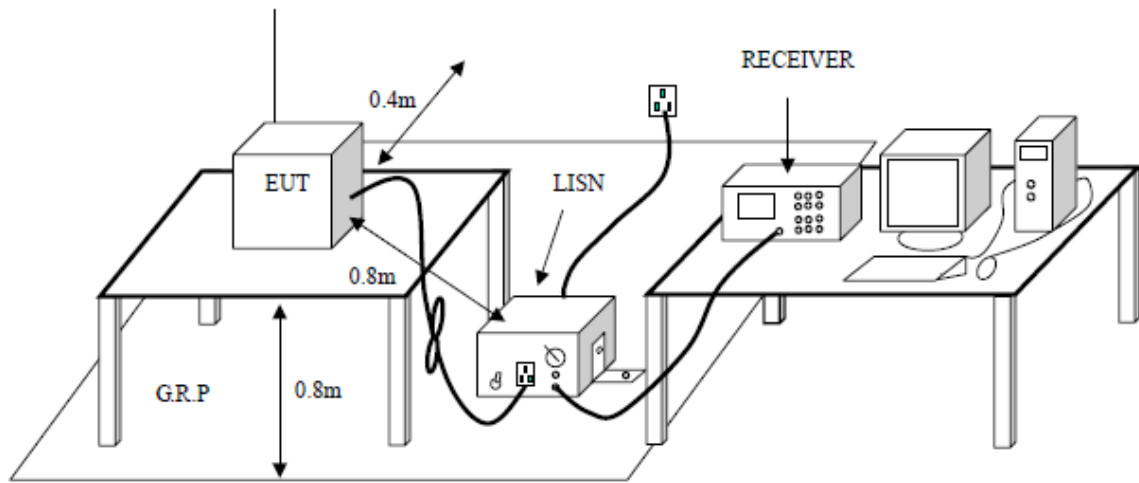

### 4.7.4 TEST RESULTS

<b>Project No.:</b>	E201512317298	<b>Probe:</b>	L1
<b>Standard:</b>	(CE)FCC PART 15 class B_QP	<b>Power Source:</b>	AC 120V/60Hz
<b>Test item:</b>	Conduction Test	<b>Date:</b>	2016-1-8
<b>Temp./Hum.(%RH):</b>	21.2/56%RH	<b>Time:</b>	10:49:05
<b>EUT:</b>	Bluetooth headphone	<b>Test Result:</b>	Pass
<b>Model:</b>	DU wireless		
<b>Note:</b>			

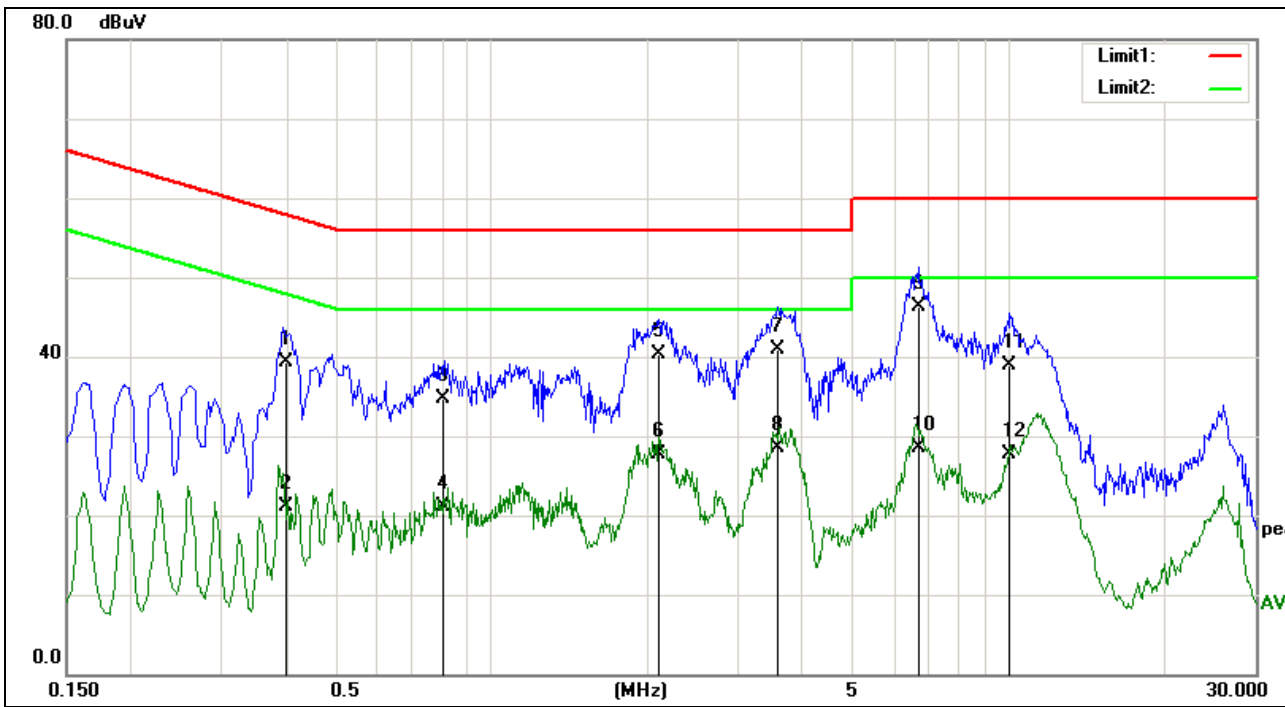

No.	Frequency (MHz)	Reading (dBuV)	Correct Factor(dB)	Result (dBuV)	Limit (dBuV)	Margin (dB)	Remark
1	0.3981	32.75	6.51	39.26	57.89	-18.63	QP
2	0.3981	14.51	6.51	21.02	47.89	-26.87	AVG
3	0.8017	28.25	6.47	34.72	56.00	-21.28	QP
4	0.8017	14.61	6.47	21.08	46.00	-24.92	AVG
5	2.1004	33.64	6.59	40.23	56.00	-15.77	QP
6	2.1004	21.15	6.59	27.74	46.00	-18.26	AVG
7	3.5710	34.23	6.63	40.86	56.00	-15.14	QP
8	3.5710	21.78	6.63	28.41	46.00	-17.59	AVG
9	6.6926	39.44	6.78	46.22	60.00	-13.78	QP
10	6.6926	21.77	6.78	28.55	50.00	-21.45	AVG
11	10.0358	32.25	6.75	39.00	60.00	-21.00	QP
12	10.0358	20.99	6.75	27.74	50.00	-22.26	AVG

<b>Project No.:</b>	<b>E201512317298</b>	<b>Probe:</b>	<b>N</b>
<b>Standard:</b>	<b>(CE)FCC PART 15 class B_QP</b>	<b>Power Source:</b>	<b>AC 120V/60Hz</b>
<b>Test item:</b>	<b>Conduction Test</b>	<b>Date:</b>	<b>2016-1-8</b>
<b>Temp./Hum.(%RH):</b>	<b>21.2/56%RH</b>	<b>Time:</b>	<b>10:06:16</b>
<b>EUT:</b>	<b>Bluetooth headphone</b>	<b>Test Result:</b>	<b>Pass</b>
<b>Model:</b>	<b>DU wireless</b>		
<b>Note:</b>			

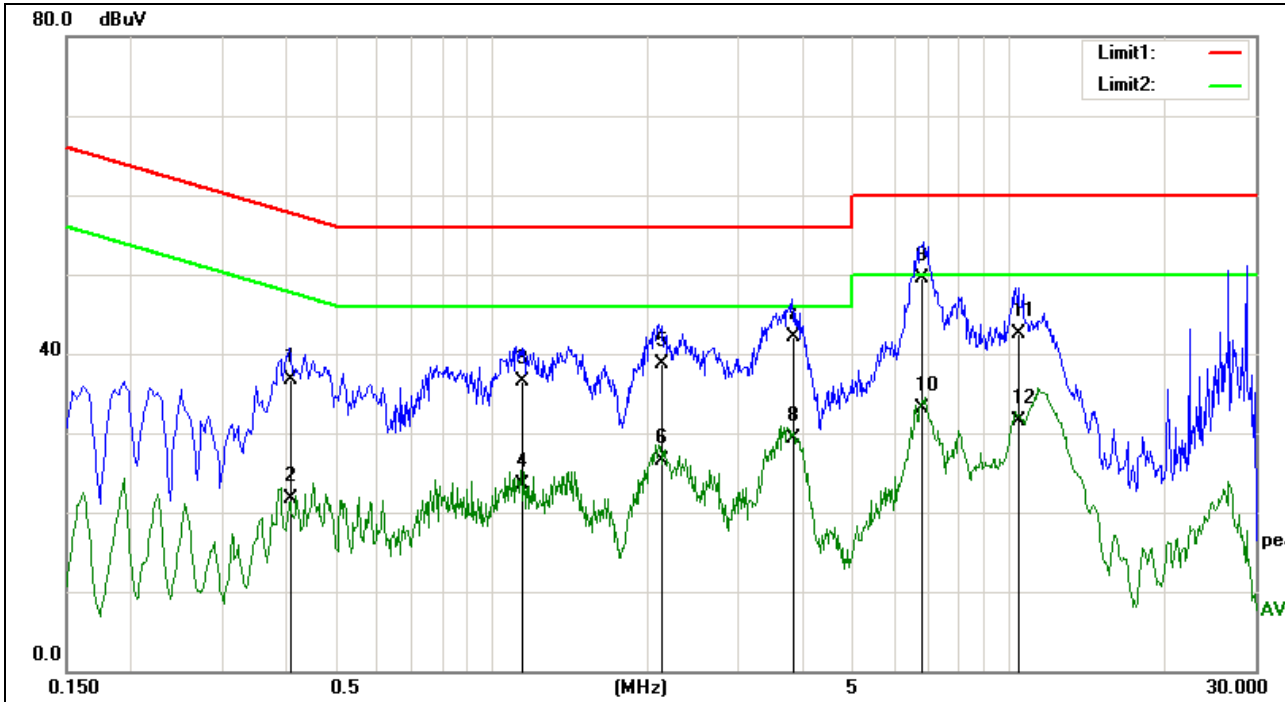

No.	Frequency (MHz)	Reading (dBuV)	Correct Factor(dB)	Result (dBuV)	Limit (dBuV)	Margin (dB)	Remark
1	0.4073	30.29	6.51	36.80	57.70	-20.90	QP
2	0.4073	15.19	6.51	21.70	47.70	-26.00	AVG
3	1.1407	30.04	6.56	36.60	56.00	-19.40	QP
4	1.1407	17.04	6.56	23.60	46.00	-22.40	AVG
5	2.1277	32.11	6.59	38.70	56.00	-17.30	QP
6	2.1277	20.01	6.59	26.60	46.00	-19.40	AVG
7	3.8447	35.58	6.62	42.20	56.00	-13.80	QP
8	3.8447	22.68	6.62	29.30	46.00	-16.70	AVG
9	6.7934	42.69	6.81	49.50	60.00	-10.50	QP
10	6.7934	26.39	6.81	33.20	50.00	-16.80	AVG
11	10.3522	35.76	6.74	42.50	60.00	-17.50	QP
12	10.3522	24.86	6.74	31.60	50.00	-18.40	AVG

## 4.8 MAXIMUM PEAK OUTPUT POWER

### 4.8.1 LIMITS

Regulation 15.247 (b)(1) For frequency hopping systems operating in the 2400-2483.5 MHz band employing at least 75 non-overlapping hopping channels, and all frequency hopping systems in the 5725-5850 MHz band: 1 watt. For all other frequency hopping systems in the 2400-2483.5 MHz band: 0.125 watts. Refer to the result "Hopping channel number" of this document.

Frequency hopping systems operating in the 2400-2483.5 MHz band may have hopping channel carrier frequencies that are separated by 25 kHz or two-thirds of the 20 dB bandwidth of the hopping channel, whichever is greater, provided the systems operate with an output power no greater than 125 mW.

The 125 mW limit applies.

### 4.8.2 TEST PROCEDURES

Test procedures follow ANSI C63.10:2013.

1. Remove the antenna from the EUT and then connect a low RF cable from the antenna port to the spectrum.
2. Set the spectrum analyzer: RBW = 3 MHz. VBW = 3 MHz. Sweep = auto; Detector Function = Peak.
3. Keep the EUT in transmitting at lowest, medium and highest channel individually. Record the max value.

#### Remark:

1. Pre-test the 3 modulation to find GFSK and 8DPSK is worse case, so only record GFSK and 8DPSK test data.
2. Cable loss = 2dB, the receiver offset loss 2dB.

### 4.8.3 TEST SETUP

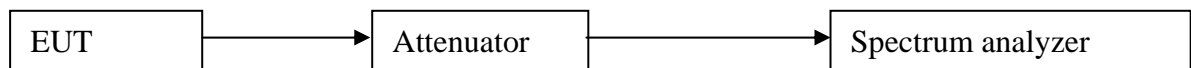

### 4.8.4 TEST RESULTS

For GFSK:

Test Channel	Fundamental Frequency (GHz)	Max Output Power(dBm)	Limit (dBm)	Pass/Fail
Lowest	2.402	1.29	20.97	Pass
Middle	2.441	5.00	20.97	Pass
Highest	2.480	5.09	20.97	Pass

For 8DPSK:

Test Channel	Fundamental Frequency (GHz)	Max Output Power(dBm)	Limit (dBm)	Pass/Fail
Lowest	2.402	-1.78	20.97	Pass
Middle	2.441	2.36	20.97	Pass



Highest	2.480	2.54	20.97	Pass
---------	-------	------	-------	------

Test result: The unit does meet the FCC requirements.

Test result plot as follows:

GFSK Lowest Channel:

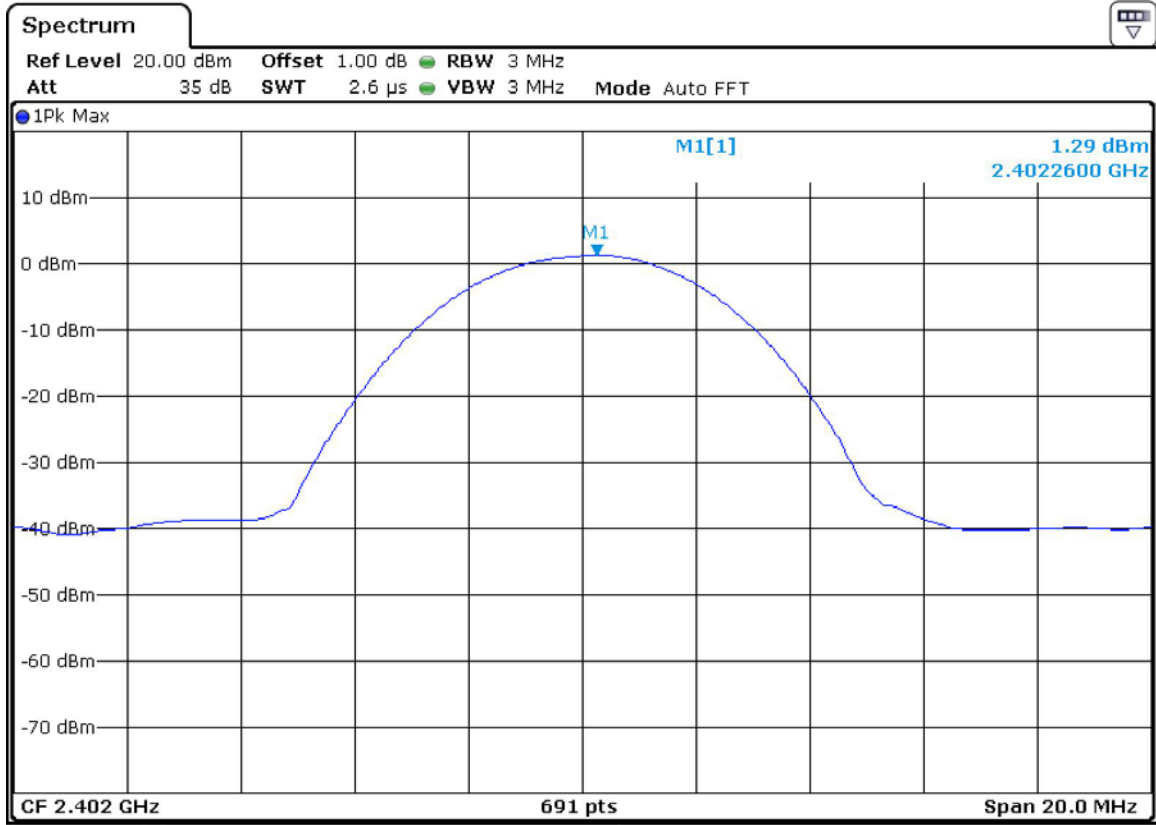

GFSK Middle Channel:

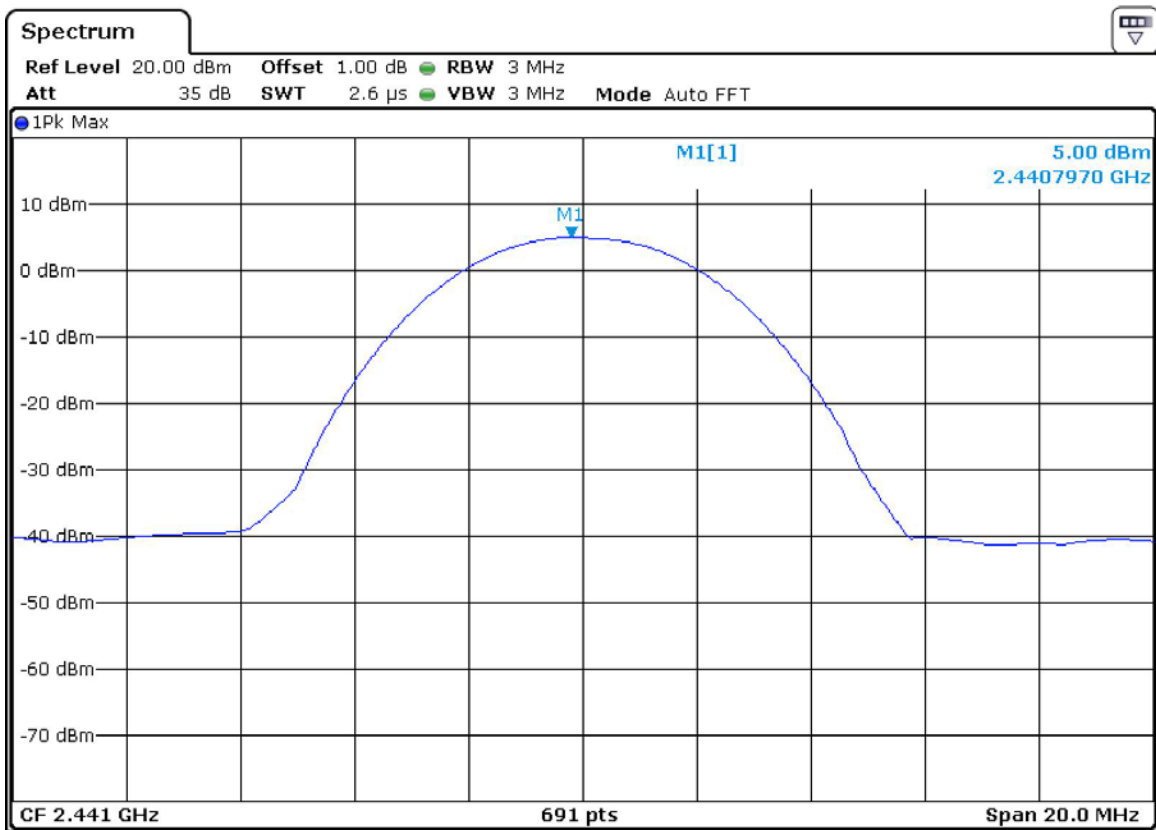

GFSK Highest Channel:

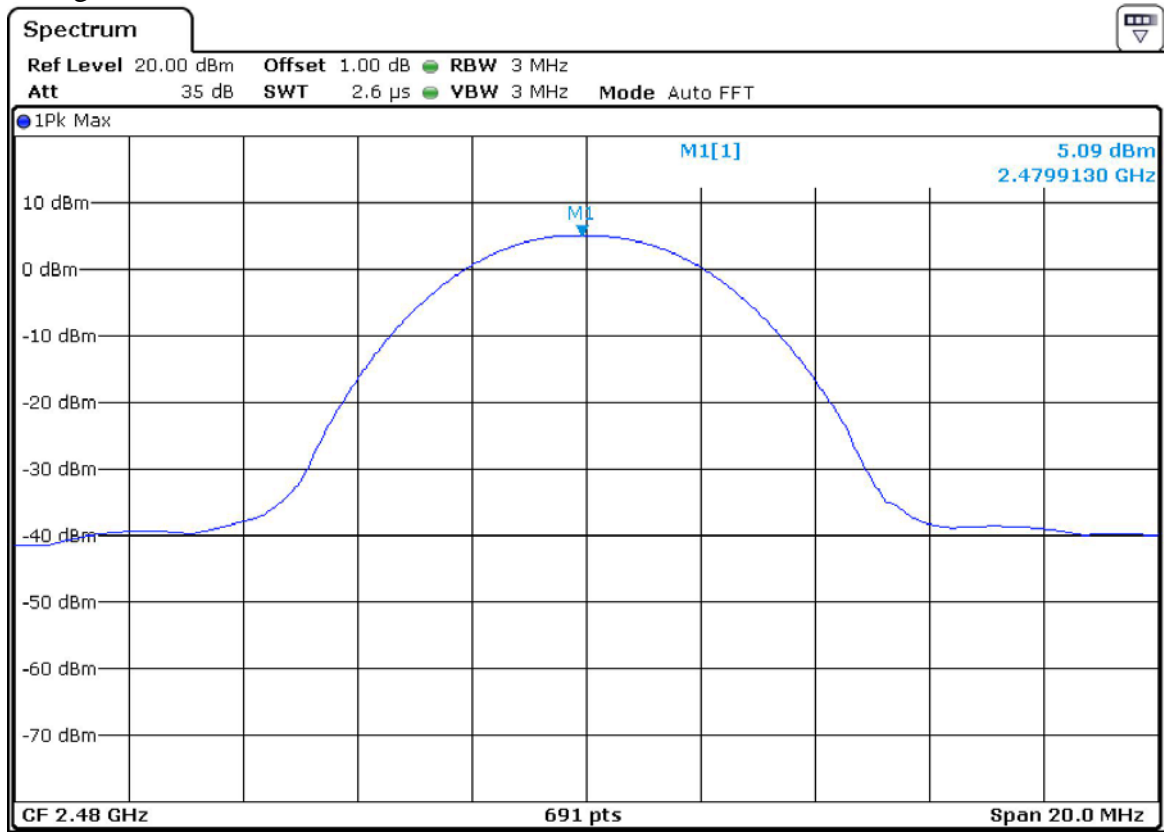

8DPSK Lowest Channel:

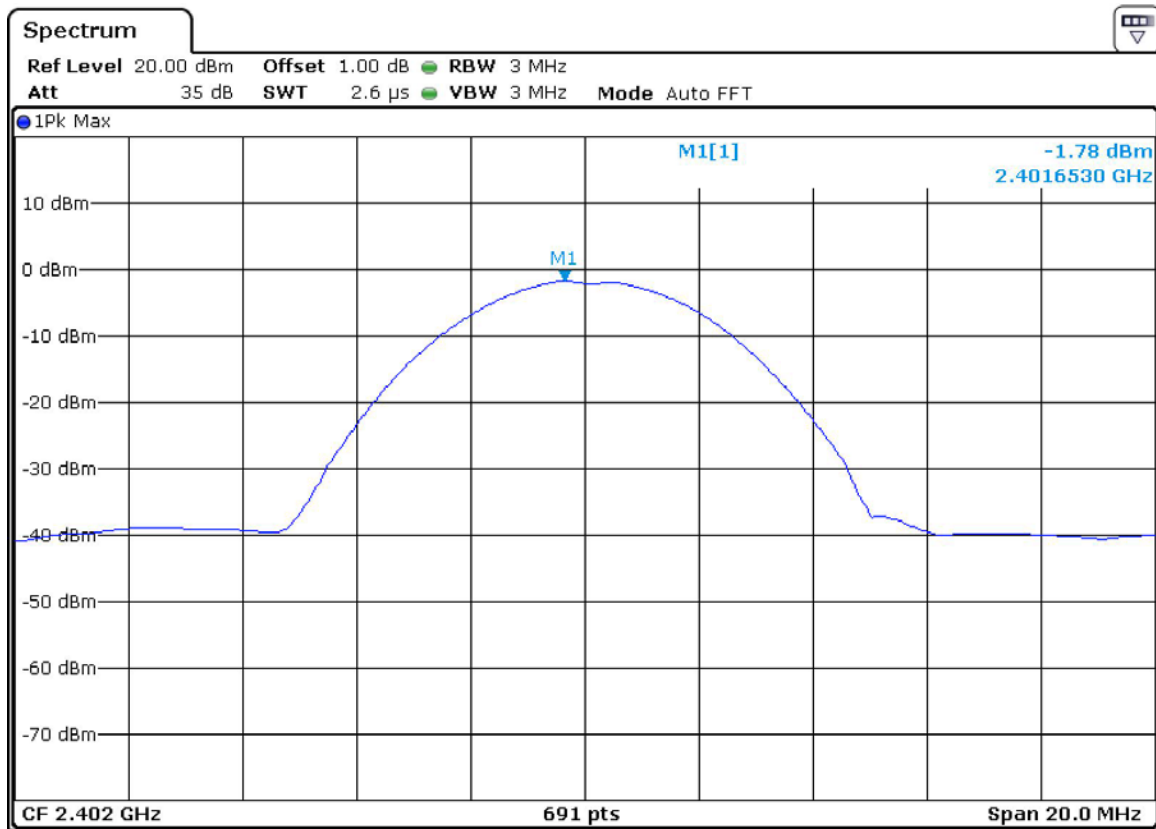

8DPSK Middle Channel:



8DPSK Highest Channel:

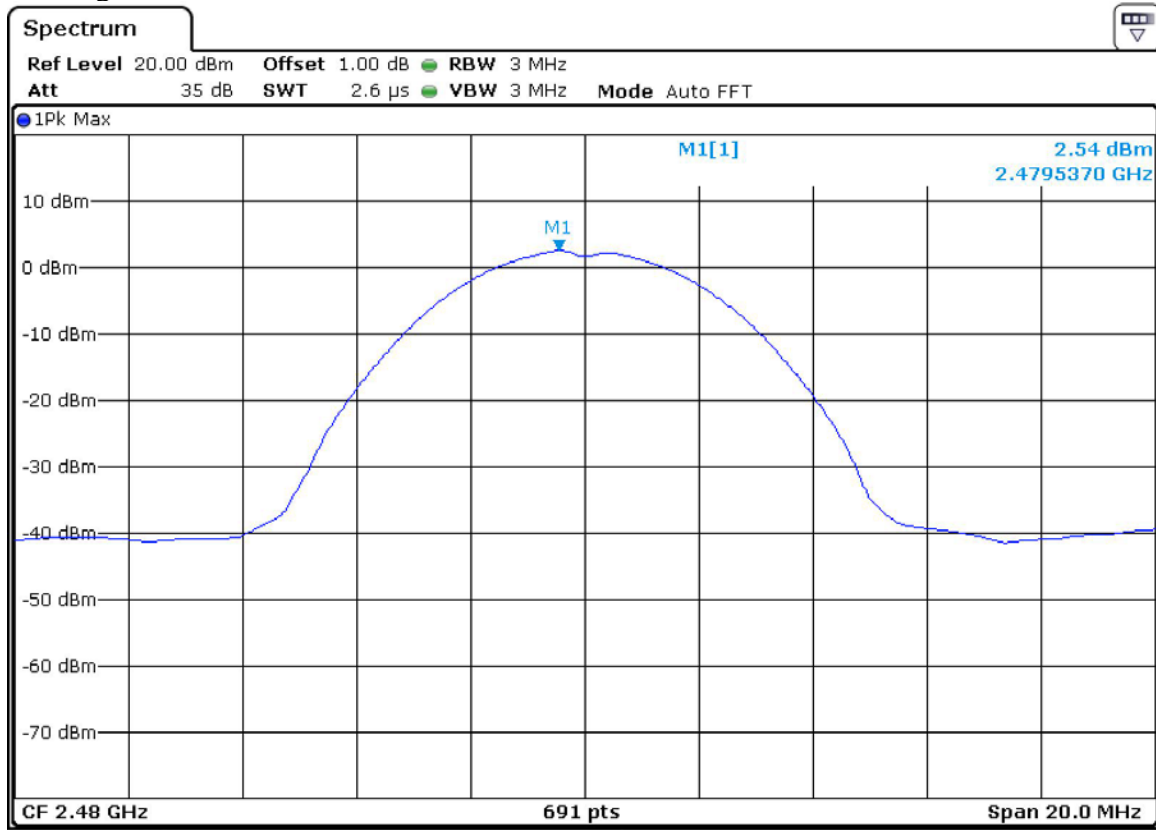

## 4.9 RADIATED SPURIOUS EMISSIONS

### 4.9.1 LIMITS

Frequency (MHz)	Quasi-peak( $\mu\text{V}/\text{m}$ )	Measurement distance(m)	Quasi-peak( $\text{dB}\mu\text{V}/\text{m}$ )@distance 3m
0.009-0.490	2400/F(kHz)	300	53.8~88.5
0.490-1.705	24000/F(kHz)	30	43~53.8
1.705-30.0	30	30	49.5
30 ~ 88	100	3	40
88~216	150	3	43.5
216 ~ 960	200	3	46
Above 960	500	3	54

NOTE: (1) The lower limit shall apply at the transition frequencies.

Frequency (GHz)	Quasi-peak( $\text{dB}\mu\text{V}/\text{m}$ )
1 ~ 26.5	74
1~ 26.5	54

### 4.9.2 TEST PROCEDURES

#### Procedure of Preliminary Test

According to ANSI C63.10:2013, a calibrated, linearly polarized antenna shall be positioned at the specified distance from the periphery of the EUT. The specified distance is the distance between the horizontal projection onto the ground plane of the closest periphery of the EUT and the projection onto the ground plane of the center of the axis of the elements of the receiving antenna.

Measurements shall be made with the antenna positioned in both the horizontal and vertical planes of polarization. The measurement antenna shall be varied in height above the reference ground plane to obtain the maximum signal strength. Unless otherwise specified, the measurement distance shall be 3 m. The EUT put on a 0.8m table below 1GHz, on 1.5m table above 1GHz. At any measurement distance, the antenna height shall be varied from 1 m to 4 m. These height scans apply for both horizontal and vertical polarizations, except that for vertical polarization, the minimum height of the center of the antenna shall be increased so that the lowest point of the bottom of the lowest antenna element clears the site reference ground plane by at least 25 cm. For a tuned dipole, the minimum heights as measured from the center of the antenna are those specified in the NSA measurement requirements.

For tabletop systems, cables or wires should be manipulated within the range of likely arrangements. For floor-standing equipment, the cables or wires should be located in the same manner as the user would install them and no further manipulation is made. For combination EUTs, the tabletop and floor-standing portions of the EUT shall follow the procedures for their respective setups and cable manipulation.

Table-top equipment is placed on a non-conductive set-up table with height  $0, 8/1.5 \text{ m} \pm 0, 01 \text{ m}$ , ANSI C63.10:2013 specifies the method to determine the impact of the non-conductive set-up table on test results. If the manner of cable installation is not known, or if it changes with each installation, cables or wires for floor-standing equipment shall be manipulated to the extent possible to produce the maximum level of emissions. For each mode of operation required to be tested, the frequency spectrum shall be monitored. Variations in antenna height between 1 m and 4 m, antenna polarization, EUT azimuth, and cable or wire placement shall be explored to produce the emission

that has the highest amplitude relative to the limit.

**Procedure of Final Test**

EUT and support equipment were set up on the turntable as per the configuration with highest emission level in the preliminary test. The Analyzer / Receiver scanned from 30MHz to 1000MHz. Emissions were scanned and measured rotating the EUT to 360 degrees, varying cable placement and positioning the antenna 1 to 4 meters above the ground plane, in both the vertical and the horizontal polarization, to maximize the emission reading level. Record at least six highest emissions. Emission frequency, amplitude, antenna position, polarization and turntable position were recorded into a computer in which correction factors were used to calculate the emission level and compare reading to the applicable limit and only QP reading is presented. The test data of the worst-case condition(s) was recorded.

**Procedure of Final Test**

EUT and support equipment were set up on the test bench as per the configuration with highest emission level in the preliminary test. A scan was taken on both power lines, recording at least the six highest emissions. Emission frequency and amplitude were recorded into a computer in which correction factors were used to calculate the emission level and compare reading to the applicable limit. The test data of the worst-case condition(s) was recorded.

Below 1GHz Set the spectrum analyzer: RBW =100KHz VBW >= RBW , Span = enough to catch the trace. Sweep = auto; Detector Function = Peak. Trace = Max,hold.

Above 1GHz Set the spectrum analyzer: RBW =1MHz VBW >= RBW , Span = enough to catch the trace. Sweep = auto; Detector Function = Peak. Trace = Max,hold.

Pre-test for normal mode and EDR mode, to find the packet type DH5 for the normal mode is the worst case.

Pre-test the EUT in X,Y,Z axis, found the X axis it the worst case.

The worst case emissions were reported.

**4.9.3 TEST SETUP**

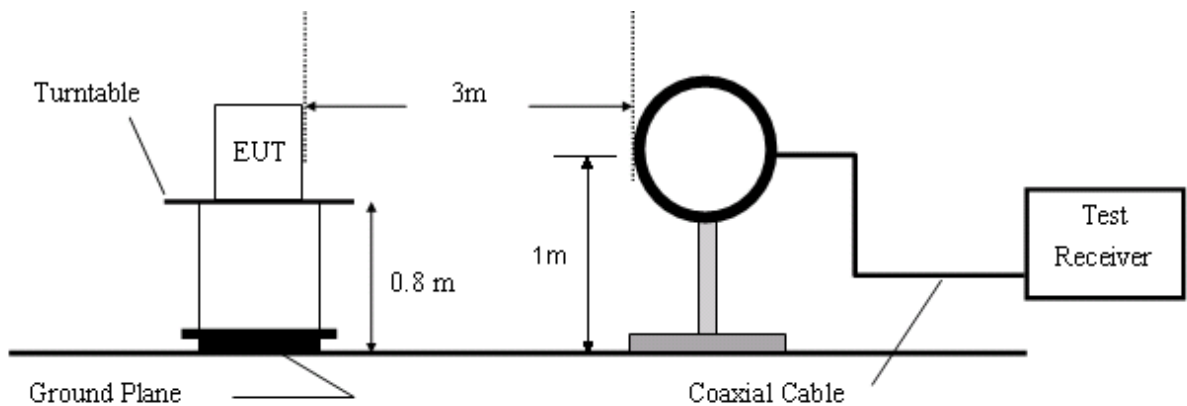

**Figure 1. 9 KHz to 30MHz radiated emissions test configuration**

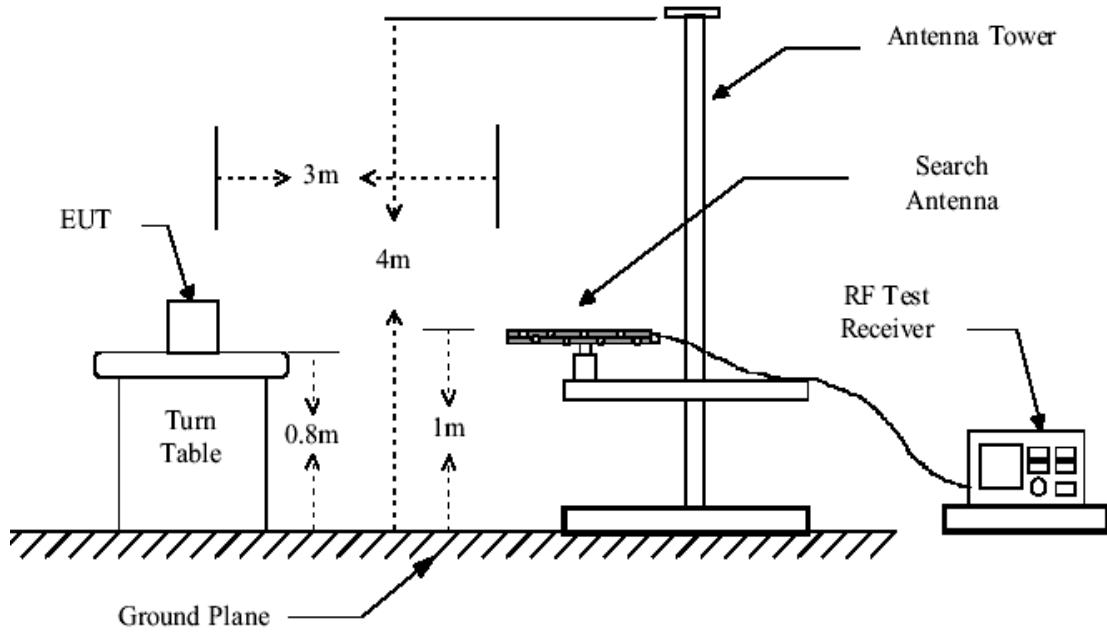

Figure 2. 30MHz to 1GHz radiated emissions test configuration

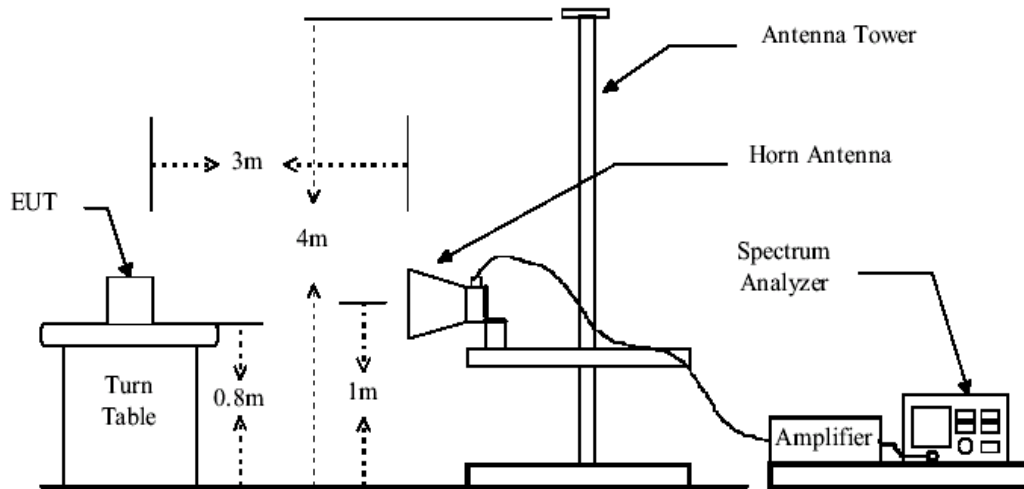

Figure 3. Above 1GHz radiated emissions test configuration

## 4.9.4 TEST RESULTS

### 1. Low Frequency 2402MHz

#### 30MHz~1GHz Spurious Emissions .Quasi-Peak Measurement

No.	Frequency (MHz)	Reading (dBuV/m)	Correct Factor(dB/m)	Result (dBuV/m)	Limit (dBuV/m)	Over Limit (dB)	Antenna polarization
1	44.2096	10.03	13.47	23.50	40.00	-16.50	Vertical
2	50.0274	9.56	11.14	20.70	40.00	-19.30	Vertical
3	60.5599	6.61	9.29	15.90	40.00	-24.10	Vertical
4	105.0401	9.20	11.40	20.60	43.50	-22.90	Vertical
5	152.2050	18.18	11.72	29.90	43.50	-13.60	Vertical
6	197.1026	13.28	11.42	24.70	43.50	-18.80	Vertical
7	45.2146	0.25	13.05	13.30	40.00	-26.70	Horizontal
8	111.7380	10.11	12.19	22.30	40.00	-17.70	Horizontal
9	143.8877	20.65	12.25	32.90	40.00	-7.10	Horizontal
10	184.2495	18.60	10.60	29.20	40.00	-10.80	Horizontal
11	200.4536	18.18	11.52	29.70	40.00	-10.30	Horizontal
12	367.7808	12.42	16.48	28.90	47.00	-18.10	Horizontal

#### 1~25 GHz Harmonics & Spurious Emissions. Peak & Average Measurement

##### Peak Measurement:

No.	Frequency (MHz)	Reading (dBuV/m)	Correct Factor(dB/m)	Result (dBuV/m)	Limit (dBuV/m)	Over Limit (dB)	Antenna polarization
1	4126.352	31.19	10.50	41.69	74.00	-32.31	Vertical
2	5473.653	30.80	12.59	43.39	74.00	-30.61	Vertical
3	6377.667	30.18	13.18	43.36	74.00	-30.64	Vertical
4	9995.220	29.61	15.46	45.07	74.00	-28.93	Vertical
5	11067.480	28.92	17.01	45.93	74.00	-28.07	Vertical
6	12895.357	30.99	19.37	50.36	74.00	-23.64	Vertical
7	2502.117	32.38	7.96	40.34	74.00	-33.66	Horizontal
8	3994.705	30.59	10.57	41.16	74.00	-32.84	Horizontal
9	5627.911	30.51	12.71	43.22	74.00	-30.78	Horizontal
10	7227.308	32.42	13.58	46.00	74.00	-28.00	Horizontal
11	9949.029	28.99	15.38	44.37	74.00	-29.63	Horizontal
12	13382.172	29.30	20.18	49.48	74.00	-24.52	Horizontal

#### NOTE:

Above 1GHz, the tested values of Peak are lower than the correspondingly limited values of AVG. So don't read the values of AVG.

The field strength is calculated by adding the Antenna Factor. Correct Factor.

The basic equation with a sample calculation is as follows:

Final Test Level = Receiver Reading + Correct Factor

## 2. Middle Frequency 2441MHz

## 30MHz~1GHz Spurious Emissions .Quasi-Peak Measurement

No.	Frequency (MHz)	Reading (dBuV/m)	Correct Factor(dB/m)	Result (dBuV/m)	Limit (dBuV/m)	Over Limit (dB)	Antenna polarization
1	42.0293	2.96	13.84	16.80	40.00	-23.20	Vertical
2	43.9619	4.34	13.56	17.90	40.00	-22.10	Vertical
3	79.7572	13.13	7.37	20.50	40.00	-19.50	Vertical
4	96.5489	9.02	9.78	18.80	40.00	-21.20	Vertical
5	153.9253	17.68	11.62	29.30	40.00	-10.70	Vertical
6	208.4958	14.63	11.97	26.60	40.00	-13.40	Vertical
7	43.9618	9.64	13.56	23.20	40.00	-16.80	Horizontal
8	105.0400	2.20	11.40	13.60	40.00	-26.40	Horizontal
9	143.8876	19.45	12.25	31.70	40.00	-8.30	Horizontal
10	186.3318	21.39	10.71	32.10	40.00	-7.90	Horizontal
11	343.7977	14.90	15.60	30.50	47.00	-16.50	Horizontal
12	432.8763	10.70	17.60	28.30	47.00	-18.70	Horizontal

## 1~25 GHz Harmonics &amp; Spurious Emissions. Peak &amp; Average Measurement

## Peak Measurement:

No.	Frequency (MHz)	Reading (dBuV/m)	Correct Factor(dB/m)	Result (dBuV/m)	Limit (dBuV/m)	Over Limit (dB)	Antenna polarization
1	2334.172	29.37	7.08	36.45	74.00	-37.55	Vertical
2	4242.641	30.38	10.42	40.80	74.00	-33.20	Vertical
3	5348.340	30.35	12.22	42.57	74.00	-31.43	Vertical
4	7569.951	28.45	14.18	42.63	74.00	-31.37	Vertical
5	9995.220	29.56	15.46	45.02	74.00	-28.98	Vertical
6	13632.428	30.02	19.73	49.75	74.00	-24.25	Vertical
7	2137.526	28.38	5.96	34.34	74.00	-39.66	Horizontal
8	4145.510	30.29	10.48	40.77	74.00	-33.23	Horizontal
9	5680.290	30.35	12.72	43.07	74.00	-30.93	Horizontal
10	7328.439	37.64	13.82	51.46	74.00	-22.54	Horizontal
11	9766.391	33.27	15.04	48.31	74.00	-25.69	Horizontal
12	13015.375	30.04	19.78	49.82	74.00	-24.18	Horizontal

## NOTE:

Above 1GHz, the tested values of Peak are lower than the correspondingly limited values of AV. So don't read the values of AVG.

The field strength is calculated by adding the Antenna Factor. Correct Factor.

The basic equation with a sample calculation is as follows:

Final Test Level =Receiver Reading + Correct Factor



## 3. High Frequency 2480MHz

## 30MHz~1GHz Spurious Emissions .Quasi-Peak Measurement

No.	Frequency (MHz)	Reading (dBuV/m)	Correct Factor(dB/m)	Result (dBuV/m)	Limit (dBuV/m)	Over Limit (dB)	Antenna polarization
1	44.2096	19.73	13.47	33.20	40.00	-6.80	Vertical
2	64.7845	19.22	8.28	27.50	40.00	-12.50	Vertical
3	100.9884	21.76	10.64	32.40	40.00	-7.60	Vertical
4	153.9253	15.88	11.62	27.50	40.00	-12.50	Vertical
5	205.0104	14.89	11.81	26.70	40.00	-13.30	Vertical
6	319.5776	11.13	15.57	26.70	47.00	-20.30	Vertical
7	41.7938	14.45	13.85	28.30	40.00	-11.70	Horizontal
8	106.8259	16.94	11.66	28.60	43.50	-14.90	Horizontal
9	111.7380	19.31	12.19	31.50	43.50	-12.00	Horizontal
10	152.2050	19.78	11.72	31.50	43.50	-12.00	Horizontal
11	182.1903	19.02	10.48	29.50	43.50	-14.00	Horizontal
12	343.7977	16.10	15.60	31.70	46.00	-14.30	Horizontal

## 1~25 GHz Harmonics &amp; Spurious Emissions. Peak &amp; Average Measurement

## Peak Measurement:

No.	Frequency (MHz)	Reading (dBuV/m)	Correct Factor(dB/m)	Result (dBuV/m)	Limit (dBuV/m)	Over Limit (dB)	Antenna polarization
1	2177.499	27.95	6.20	34.15	74.00	-39.85	Vertical
2	4107.283	30.24	10.51	40.75	74.00	-33.25	Vertical
3	5654.039	30.57	12.72	43.29	74.00	-30.71	Vertical
4	6804.951	29.76	13.16	42.92	74.00	-31.08	Vertical
5	9995.220	29.19	15.46	44.65	74.00	-29.35	Vertical
6	13382.172	30.21	20.18	50.39	74.00	-23.61	Vertical
7	2098.286	28.89	5.74	34.63	74.00	-39.37	Horizontal
8	3154.208	29.97	7.31	37.28	74.00	-36.72	Horizontal
9	4203.518	30.64	10.44	41.08	74.00	-32.92	Horizontal
10	7430.986	35.44	14.06	49.50	74.00	-24.50	Horizontal
11	9949.029	32.10	15.38	47.48	74.00	-26.52	Horizontal
12	13320.329	29.93	20.11	50.04	74.00	-23.96	Horizontal

## NOTE:

Above 1GHz, the tested values of Peak are lower than the correspondingly limited values of AVG. So don't read the values of AVG.

The field strength is calculated by adding the Antenna Factor. Correct Factor.

The basic equation with a sample calculation is as follows:

Final Test Level = Receiver Reading + Correct Factor

**Remark:**

- 1). No any other emissions level which are attenuated less than 20dB below the limit.  
According to 15.31(o), The amplitude of spurious emissions from intentional radiators and emissions from unintentional radiators which are attenuated more than 20 dB below the permissible value need not be reported unless specifically required elsewhere in this Part.  
Hence there no other emissions have been reported.
- 2). As shown in Section, for frequencies above 1000 MHz. the above field strength limits are based on average limits. However, the peak field strength of any emission shall not exceed the maximum permitted average limits specified above by more than 20 dB under any condition of modulation.
- 3). The test only perform the EUT in transmitting status since the test frequencies were over 1GHz only required transmitting status.

**Test result: The unit does meet the requirements.**

## 4.10 BAND EDGES REQUIREMENT

### 4.10.1 LIMITS

Section 15.247 (d) In any 100 kHz bandwidth outside the frequency band in which the spread spectrum or digitally modulated intentional radiator is operating, the radio frequency power that is produced by the intentional radiator shall be at least 20 dB below that in the 100 kHz bandwidth within the band that contains the highest level of the desired power, based on either an RF conducted or a radiated measurement, provided the transmitter demonstrates compliance with the peak conducted power limits. If the transmitter complies with the conducted power limits based on the use of RMS averaging over a time interval, as permitted under paragraph (b)(3) of this section, the attenuation required under this paragraph shall be 30 dB instead of 20 dB. Attenuation below the general limits specified in Section 15.209(a) is not required.

### 4.10.2 TEST PROCEDURES

Test procedures follow ANSI C63.10:2013.

1. Check the calibration of the measuring instrument using either an internal calibrator or a known signal from an external generator.
2. Position the EUT without connection to measurement instrument. Turn on the EUT and connect its antenna terminal to measurement instrument via a low loss cable. Then set it to any one measured frequency within its operating range, and make sure the instrument is operated in its linear range.
3. Fixing frequency mode:
4. Set RBW to 100 kHz and VBW of spectrum analyzer to 300 kHz with a convenient frequency span including 100 kHz bandwidth from band edge. Measure the highest amplitude appearing on spectral display and set it as a reference level. Plot the graph with marking the highest point and edge frequency. Repeat above procedures until all measured frequencies were complete.
5. Frequency Hopping mode:
6. Span = wide enough to capture the peak level of the emission operating on the channel closest to the band edge, as well as any modulation products which fall outside of the authorized band of operation.
7.  $RBW \geq 1\%$  of spectrum analyzer display span(set 100kHz),  $VBW \geq RBW$ (set 100kHz), Sweep = auto, Detector function = peak, Trace = max hold.

Allow the trace to stabilize. Set the marker on the emission at the band edge, or on the highest modulation product outside of the band, if this level is greater than that at the band edge.

### 4.10.3 TEST SETUP

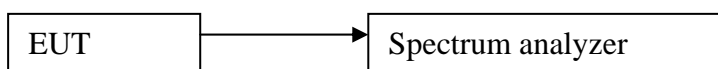

### 4.10.4 TEST RESULTS

**The unit does meet the FCC requirements.**

Test result plot as follows:

**Fixing frequency mode:**

For GFSK

Lowest Channel



Highest Channel

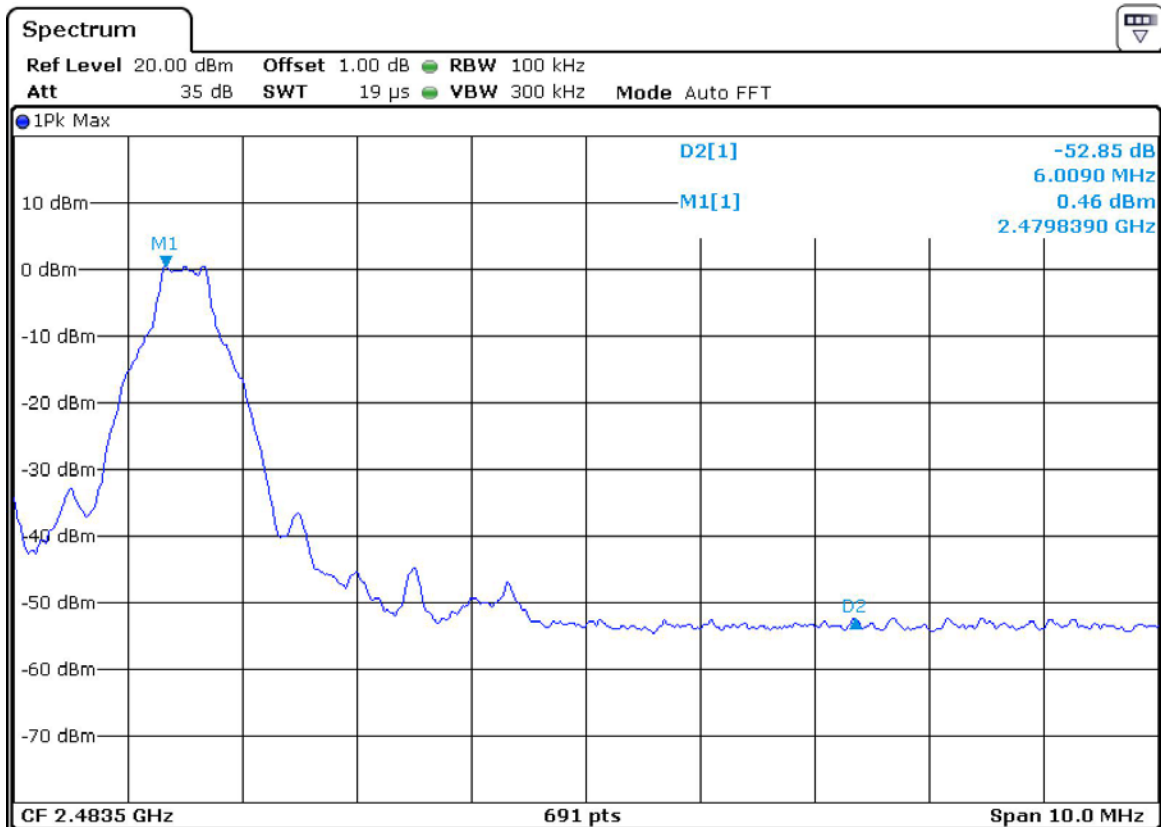

For 8DPSK

Lowest Channel

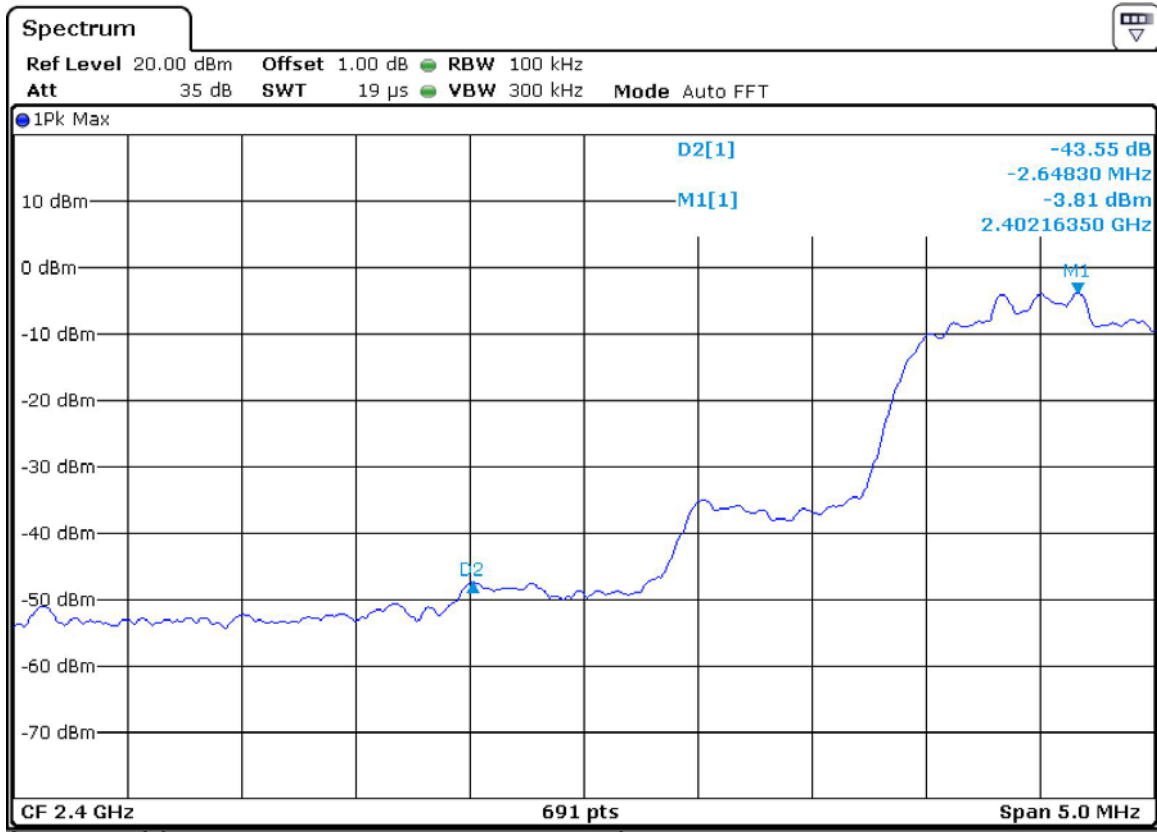

Highest Channel

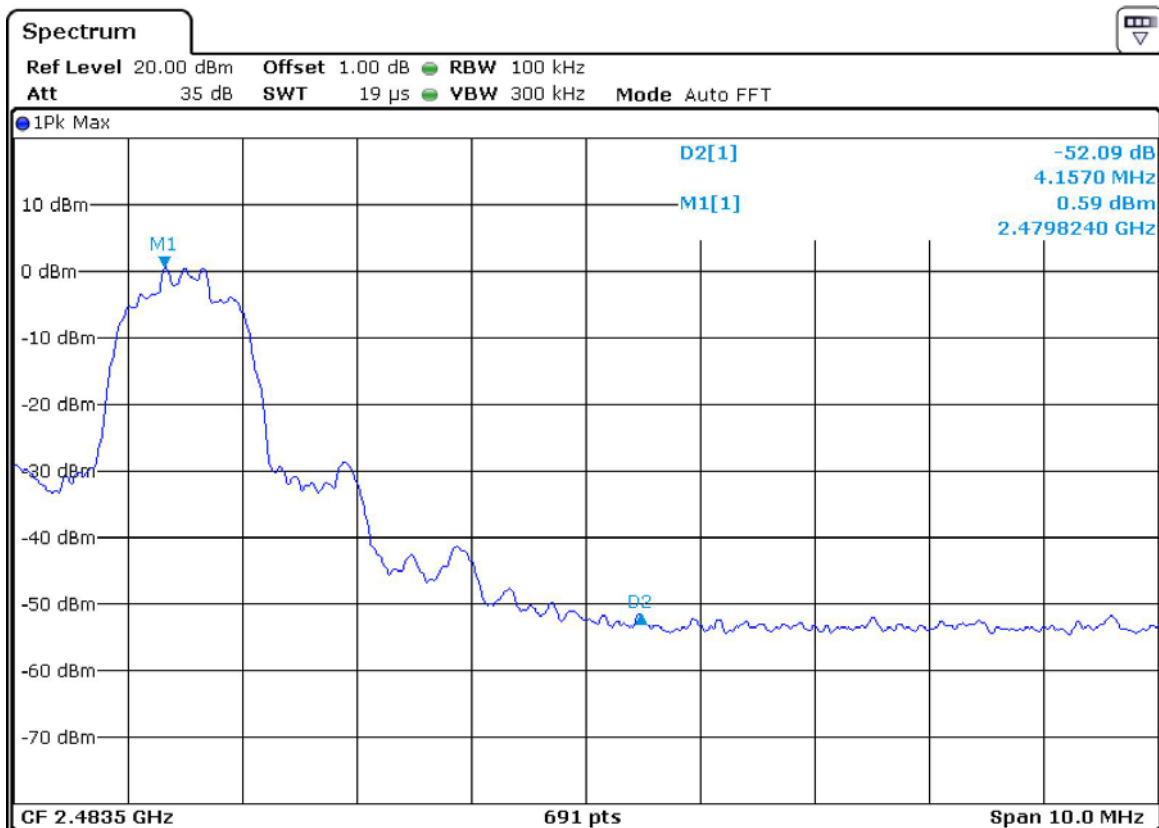

**Frequency Hopping mode:**

FOR GFSK:

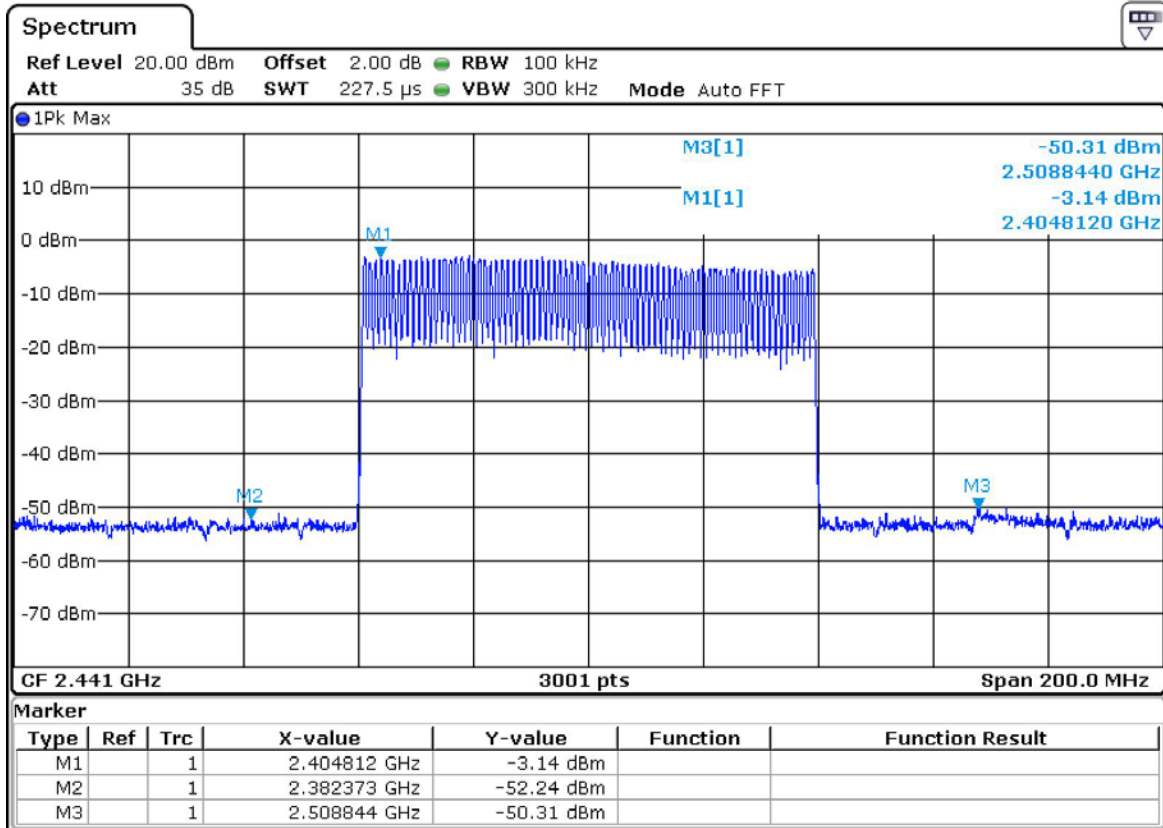

FOR 8DPSK

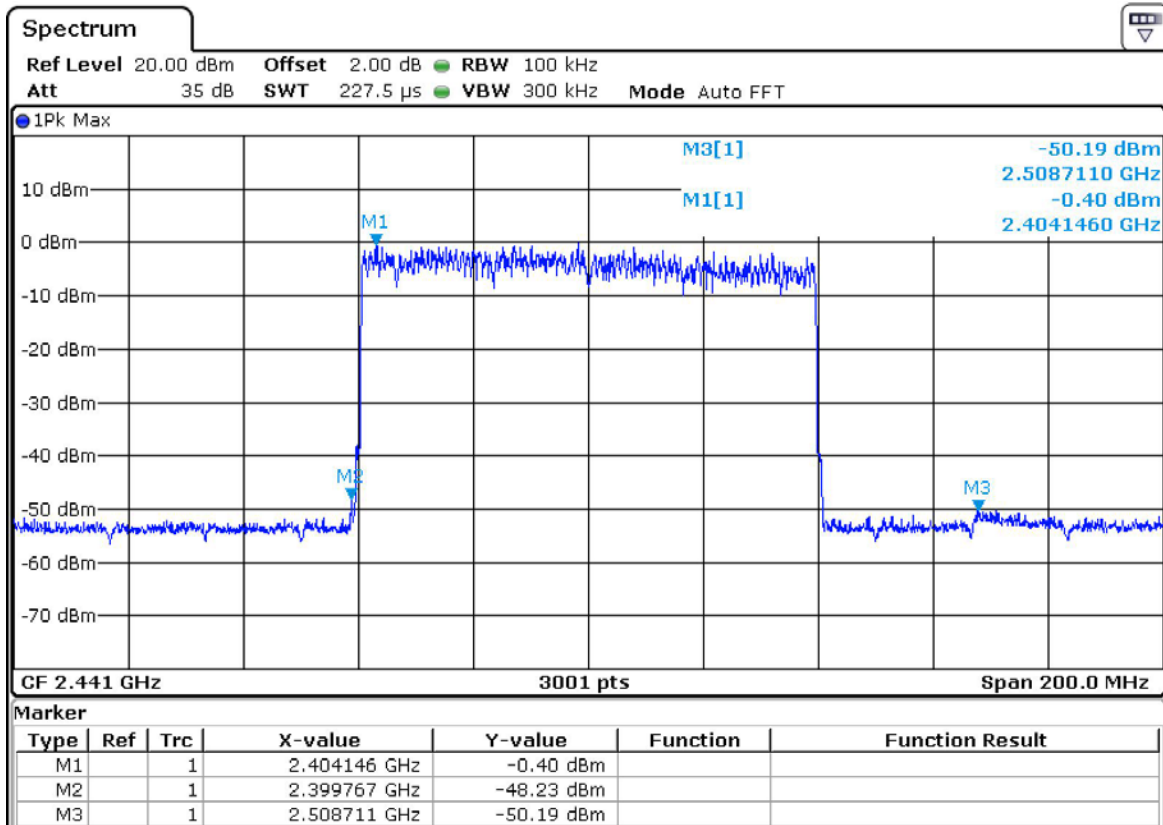

#### 4.10.5 RADIATED EMISSIONS WHICH FALL IN THE RESTRICTED BANDS

Section 15.247(d) In addition, radiated emissions which fall in the restricted bands, as defined in Section 15.205(a), must also comply with the radiated emission limits specified in Section 15.209(a) (see Section 15.205(c)).

Test Requirement:

Section 15.205 Restricted bands of operation.

(a) Except as shown in paragraph (d) of this section. Only spurious emissions are permitted in any of the frequency bands listed below:

MHz	MHz	MHz	GHz
0.090 - 0.110	16.42 - 16.423	399.9 - 410	4.5 - 5.15
<sup>1</sup> 0.495 - 0.505	16.69475 -	608 - 614	5.35 - 5.46
2.1735 - 2.1905	16.69525	960 - 1240	7.25 - 7.75
4.125 - 4.128	16.80425 -	1300 - 1427	8.025 - 8.5
4.17725 - 4.17775	16.80475	1435 - 1626.5	9.0 - 9.2
4.20725 - 4.20775	25.5 - 25.67	1645.5 - 1646.5	9.3 - 9.5
6.215 - 6.218	37.5 - 38.25	1660 - 1710	10.6 - 12.7
6.26775 - 6.26825	73 - 74.6	1718.8 - 1722.2	13.25 - 13.4
6.31175 - 6.31225	74.8 - 75.2	2200 - 2300	14.47 - 14.5
8.291 - 8.294	108 - 121.94	2310 - 2390	15.35 - 16.2
8.362 - 8.366	123 - 138	2483.5 - 2500	17.7 - 21.4
8.37625 - 8.38675	149.9 - 150.05	2655 - 2900	22.01 - 23.12
8.41425 - 8.41475	156.52475 -	3260 - 3267	23.6 - 24.0
12.29 - 12.293	156.52525	3332 - 3339	31.2 - 31.8
12.51975 -	156.7 - 156.9	3345.8 - 3358	36.43 - 36.5
12.52025	162.0125 - 167.17	3600 - 4400	
12.57675 -	167.72 - 173.2		
12.57725	240 - 285		
13.36 - 13.41	322 - 335.4		

Pretest the Bluetooth normal mode and EDR mode, to find the packet type 3DH5 for the EDR mode is the worst case,so only record the worst case.

The field strength was measured with an EMI measuring receiver and 1 MHz RBW / VBW for peak and with 1MHz RBW / 10Hz VBW for average at a distance of 3m.

**Test Result:****Channel Low**

No.	Freq MHz	Reading dBuV	Factor dB	Level dBuV/m	Limit dBuV/m	Over Limit dB	Remark	Pol V/H
1	2310.000	26.69	6.94	33.63	74.00	-40.37	peak	VERTICAL
2	2390.000	26.94	7.41	34.35	74.00	-39.65	peak	VERTICAL
1	2310.000	27.01	6.94	33.95	74.00	-40.05	peak	HORIZONTAL
2	2390.000	27.97	7.41	35.38	74.00	-38.62	peak	HORIZONTAL

**Channel High**

No.	Freq MHz	Reading dBuV	Factor dB	Level dBuV/m	Limit dBuV/m	Over Limit dB	Remark	Pol V/H
1	2483.500	34.38	7.87	42.25	74.00	-31.75	peak	VERTICAL
2	2500.000	28.14	7.95	36.09	74.00	-37.91	peak	VERTICAL
1	2483.500	37.63	7.87	45.50	74.00	-28.50	peak	HORIZONTAL
2	2500.000	28.17	7.95	36.12	74.00	-37.88	peak	HORIZONTAL

Remark: Max field strength in 3m distance. No any other emission which falls in restricted bands can be detected and be reported.

The tested values of Peak are lower than the correspondingly limited values of AVG. So don't read the values of AVG.



### APPENDIX A: PHOTOGRAPH OF THE TEST ARRANGEMENT

RSE (Below 1GHz)



RSE (Above 1GHz)



CE

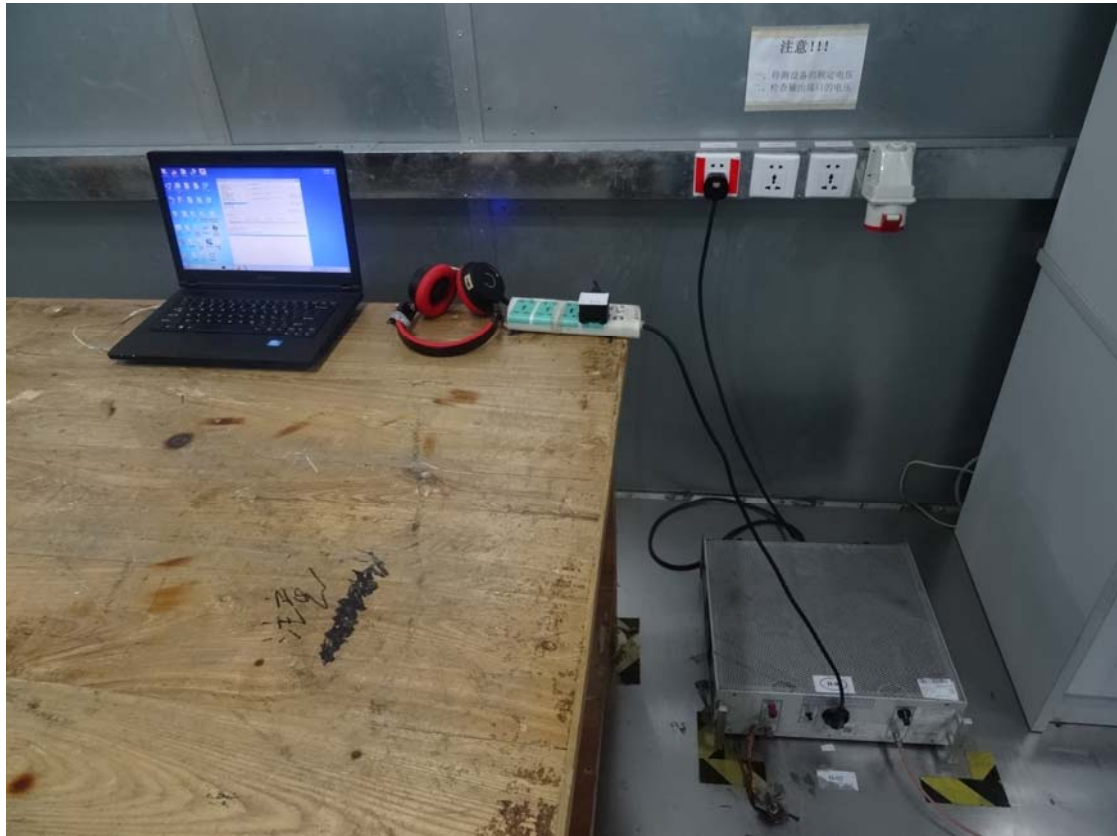

-----This is the last page of the report. -----