



TAOGLAS®



Datasheet

2.4GHz Miniature Screw Terminal Mount Monopole Antenna

Part No:
GW.26.0111

Description

2.4GHz Miniature Screw Terminal Mount Monopole Antenna

Features:

SMA(M) Straight Connector, 50 Ohm
30mm Long

1.	Introduction	2
2.	Specification	3
3.	Antenna Characteristics	4
4.	Radiation Patterns	8
5.	Mechanical Drawing	15
6.	Packaging	16
<hr/>		
	Changelog	17

Taoglas makes no warranties based on the accuracy or completeness of the contents of this document and reserves the right to make changes to specifications and product descriptions at any time without notice. Taoglas reserves all rights to this document and the information contained herein. Reproduction, use or disclosure to third parties without express permission is strictly prohibited.



1. Introduction



The GW.26 2.4GHz Monopole SMA(M) terminal mount antenna is ideal for 2.4GHz wireless applications such as Bluetooth and Wireless LAN.

Many module manufacturers specify peak gain limits for any antennas that are to be connected to that module. Those peak gain limits are based on free-space conditions. In practice, the peak gain of an antenna tested in free-space can degrade by at least 1 or 2dBi when put inside a device. So ideally you should go for a slightly higher peak gain antenna than mentioned on the module specification to compensate for this effect, giving you better performance.

Upon testing of any of our antennas with your device and a selection of appropriate layout, integration technique, or cable, Taoglas can make sure any of our antennas' peak gain will be below the peak gain limits. Taoglas can then issue a specification and/or report for the selected antenna in your device that will clearly show it complying with the peak gain limits, so you can be assured you are meeting regulatory requirements for that module.

For example, a module manufacturer may state that the antenna must have less than 2dBi peak gain, but you don't need to select an embedded antenna that has a peak gain of less than 2dBi in free-space. This will give you a less optimized solution. It is better to go for a slightly higher free-space peak gain of 3dBi or more if available. Once that antenna gets integrated into your device, performance will degrade below this 2dBi peak gain due to the effects of GND plane, surrounding components, and device housing. If you want to be absolutely sure, contact Taoglas and we will test. Choosing a Taoglas antenna with a higher peak gain than what is specified by the module manufacturer and enlisting our help will ensure you are getting the best performance possible without exceeding the peak gain limits.

Connector mount is fully customizable.

2. Specification

Wi-Fi Electrical								
Band	Frequency (MHz)	Efficiency (%)	Average Gain (dB)	Peak Gain (dBi)	Impedance	Polarization	Radiation Pattern	Power consumption
Wi-Fi 2.4 GHz	2400-2500	48.7	-3.12	2.24	50 Ω	Linear	Omni	10W

Mechanical	
Dimensions	30mm x ø7.9mm
Material	TPU
Connector	SMA(M)

Environmental	
Operating Temperature	-40°C ~ +85°C
Storage Temperature	-40°C ~ +85°C

3. Antenna Characteristics

3.1 Test Setup

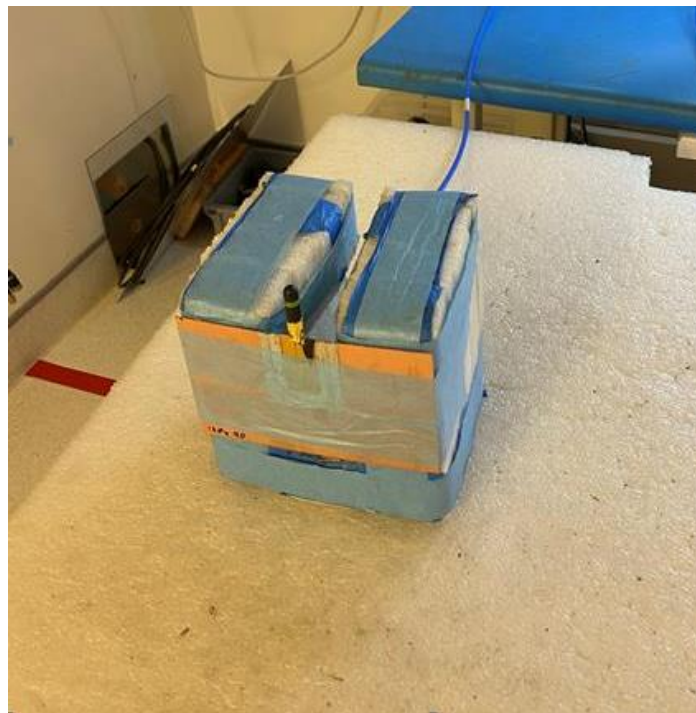
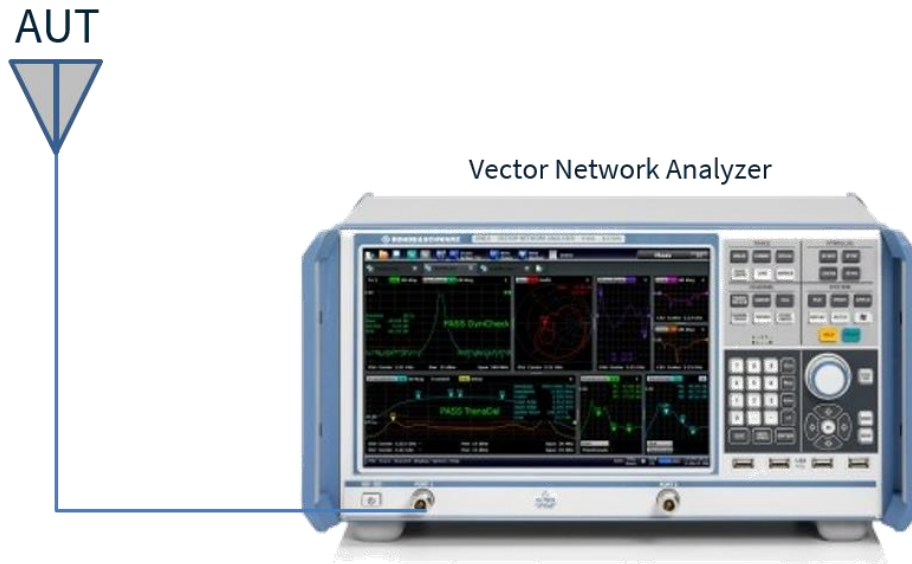

Tested on 150x90mm Ground Plane

3.2 Return Loss

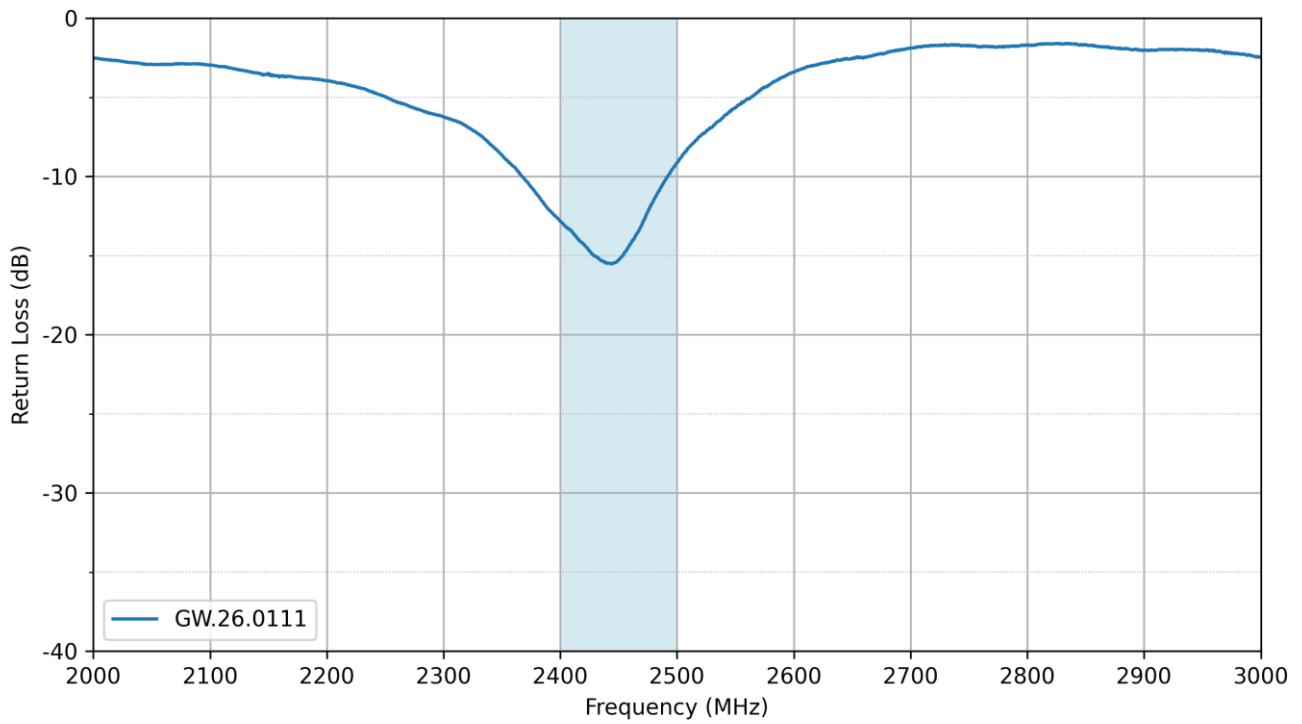

3.3 VSWR

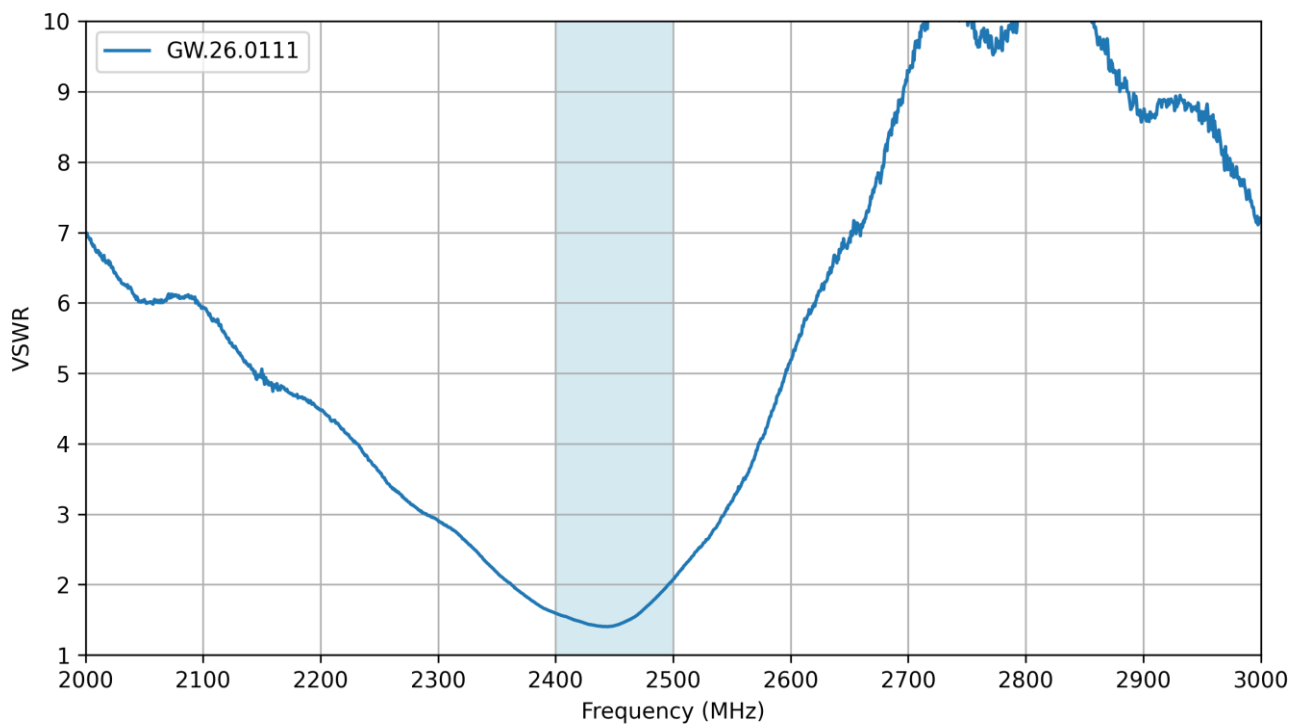

3.4 Efficiency

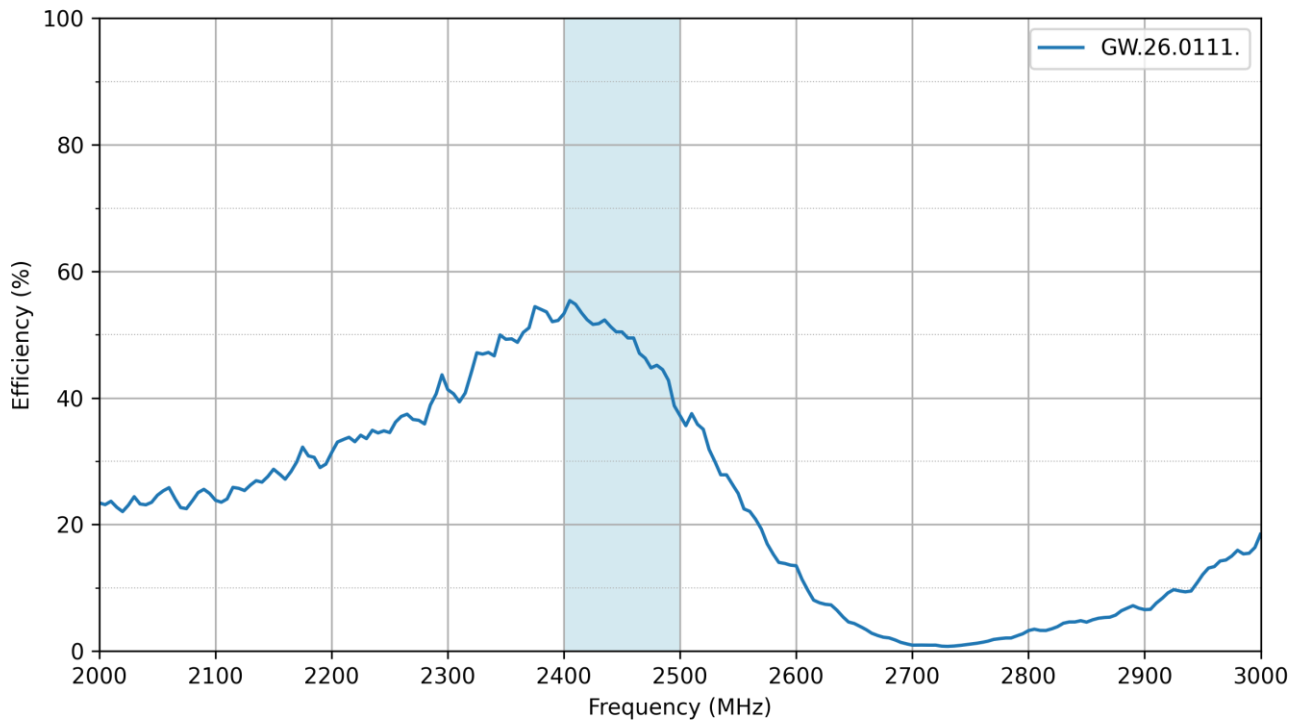

3.5 Average Gain

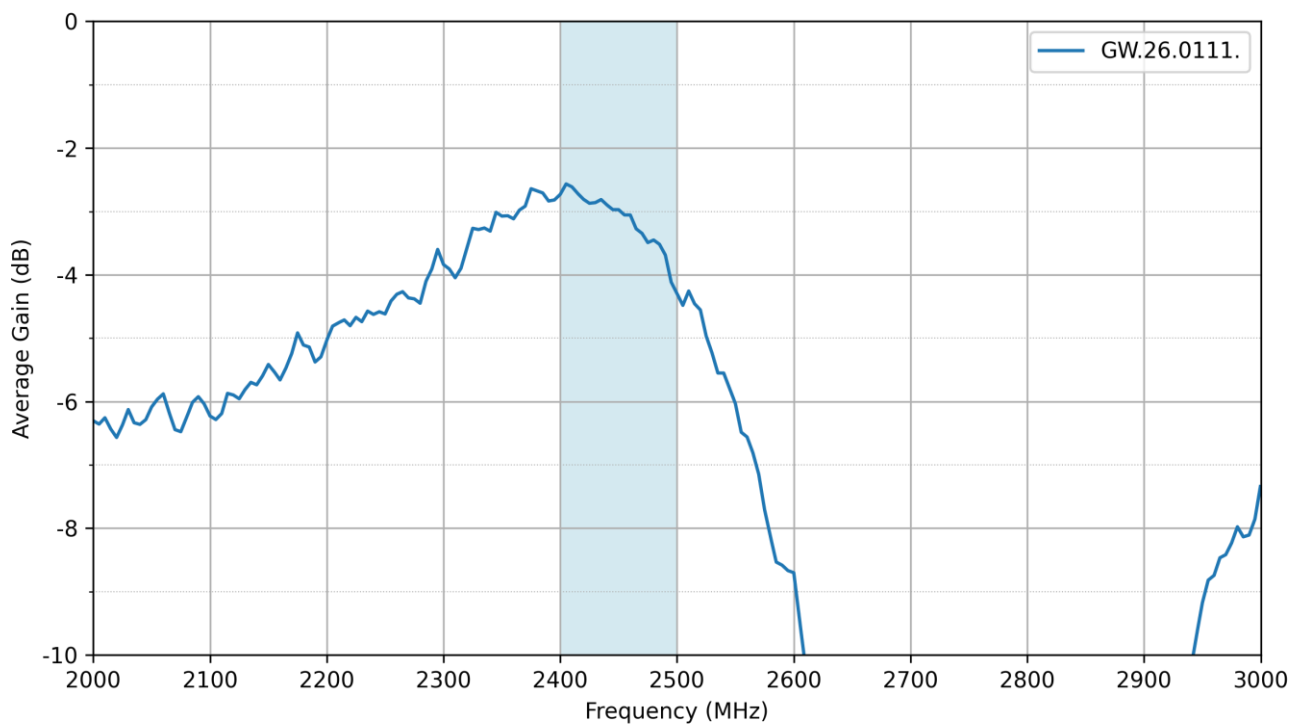

3.6 Peak Gain

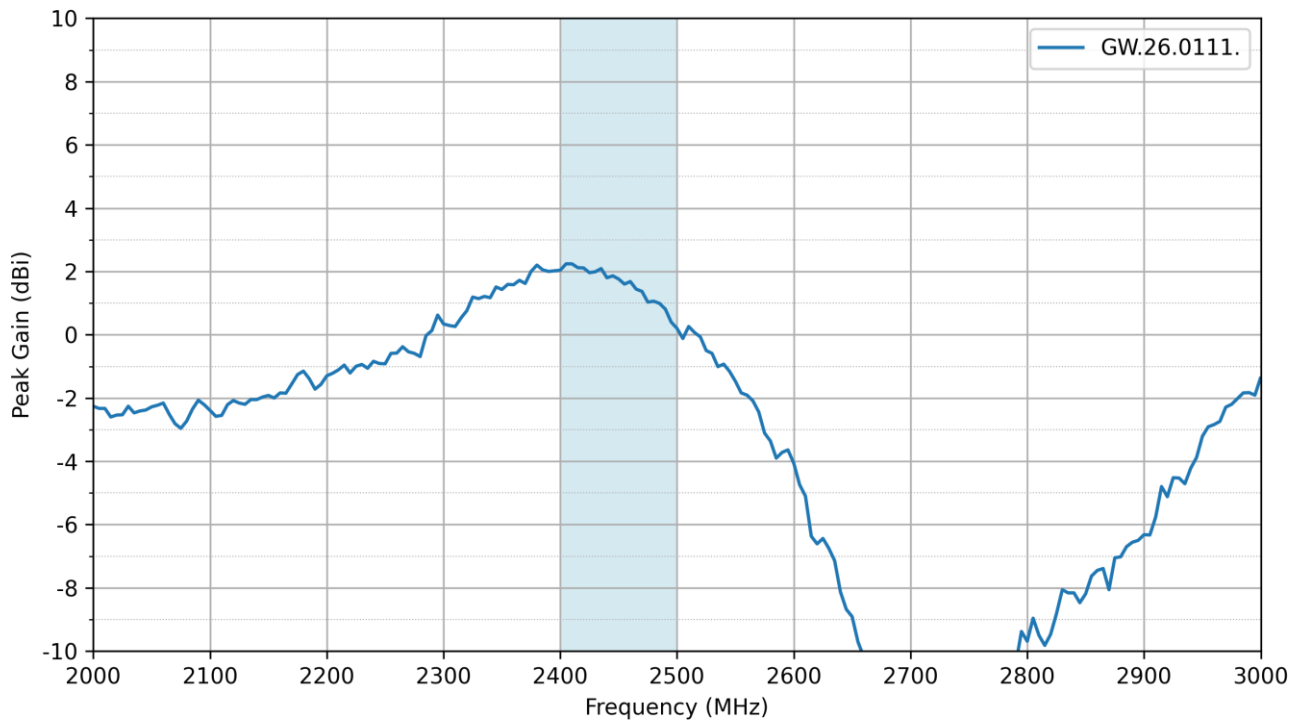

4. Radiation Patterns

4.1 Test Setup

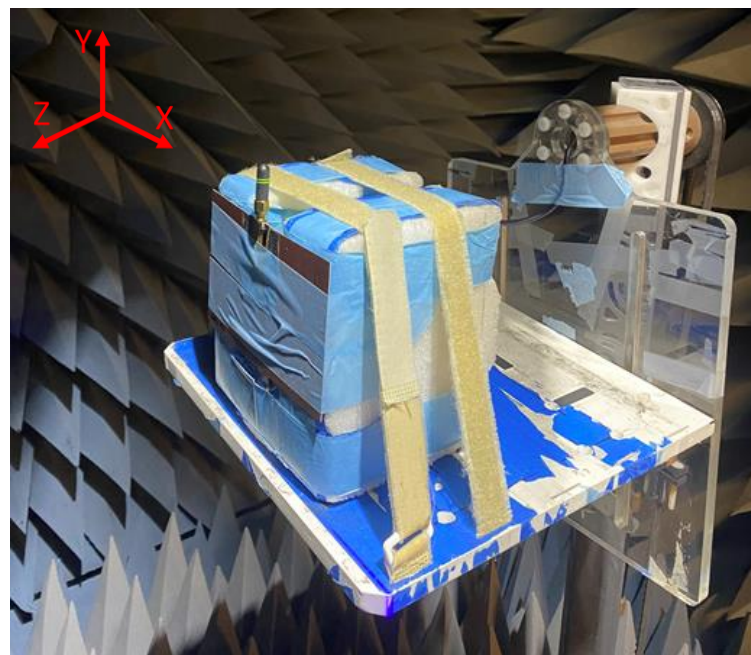
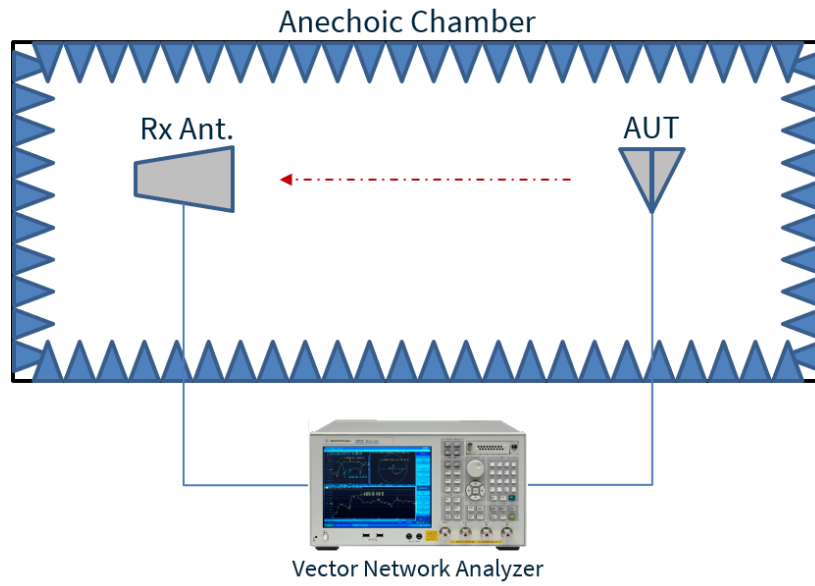

Tested on 150x90mm Ground Plane

4.2 GW.26.0111 - Patterns at 2400 MHz

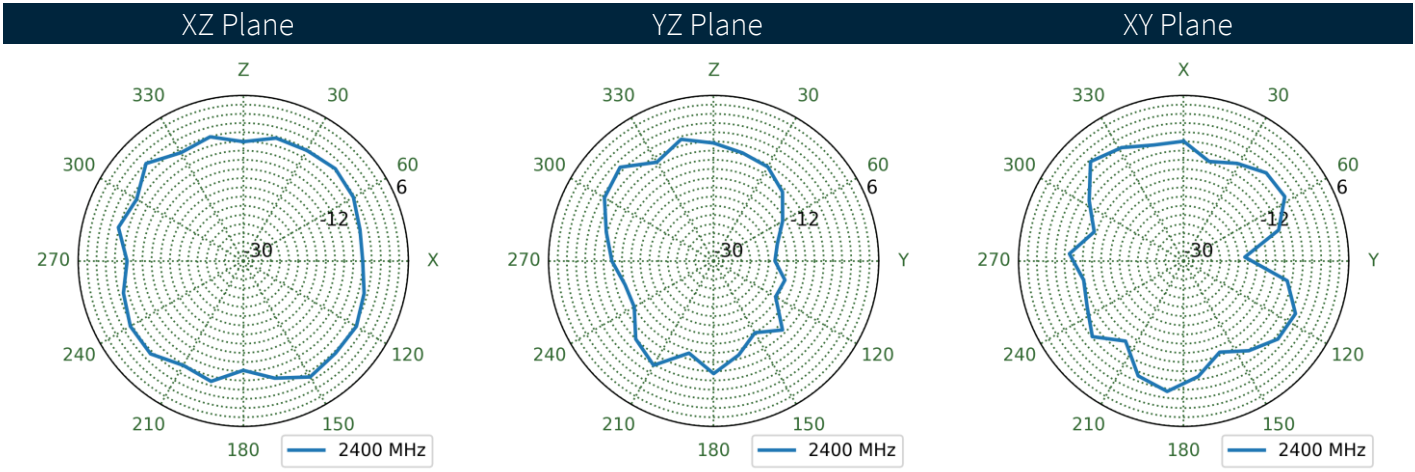
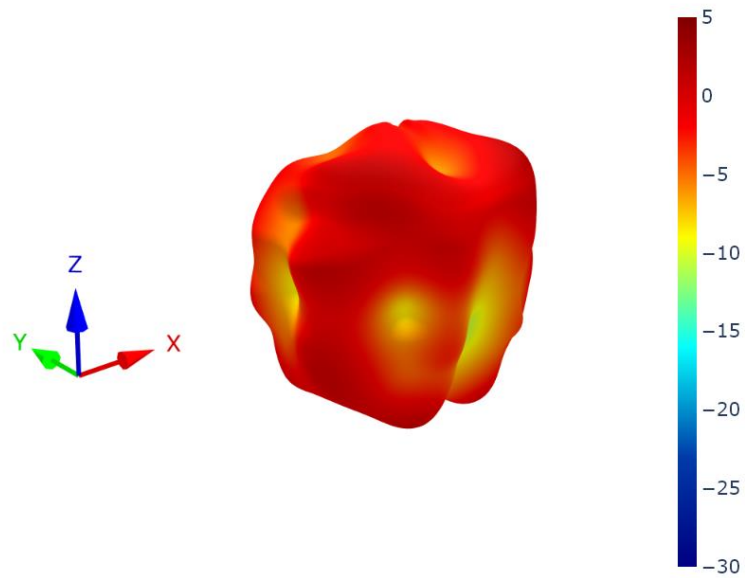

4.3 GW.26.0111 - Patterns at 2420 MHz

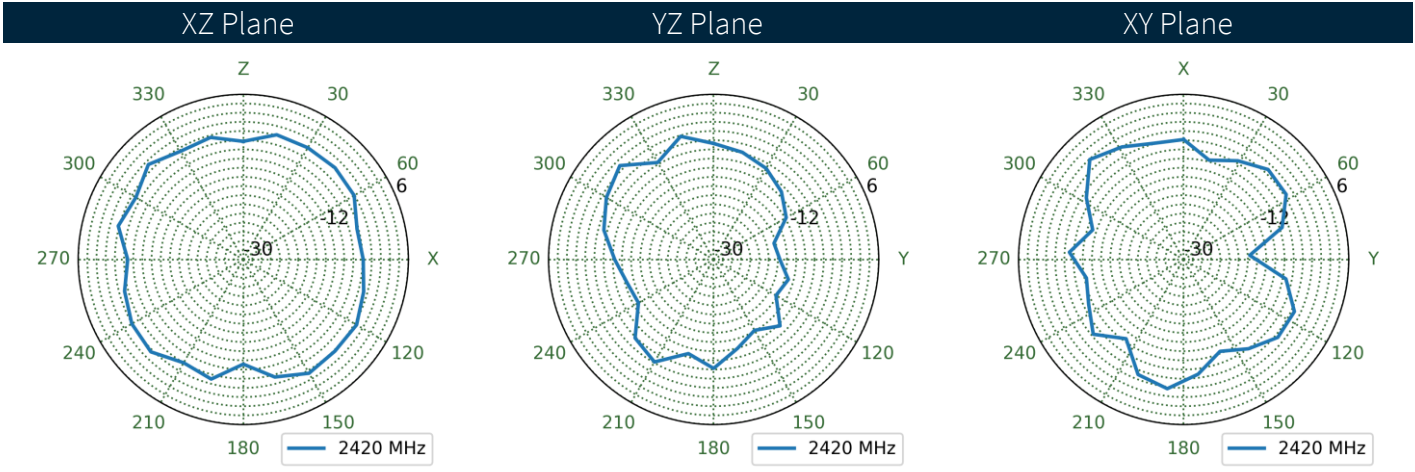
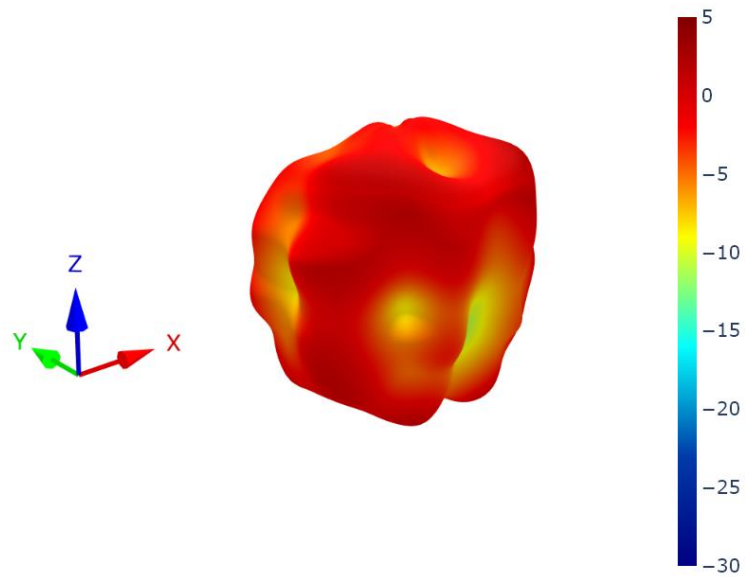

4.4 GW.26.0111 - Patterns at 2440 MHz

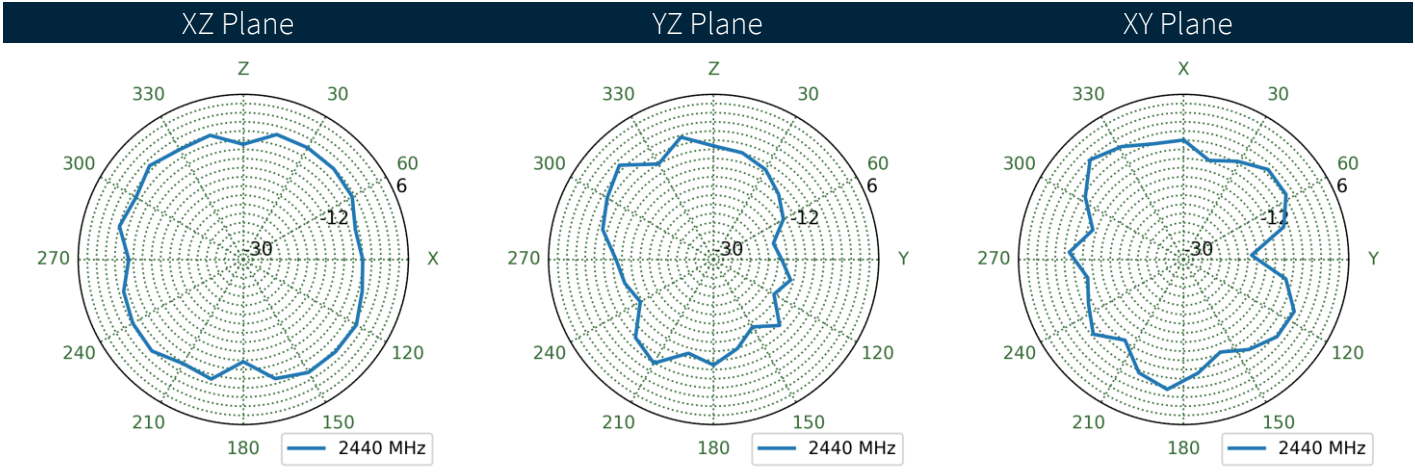
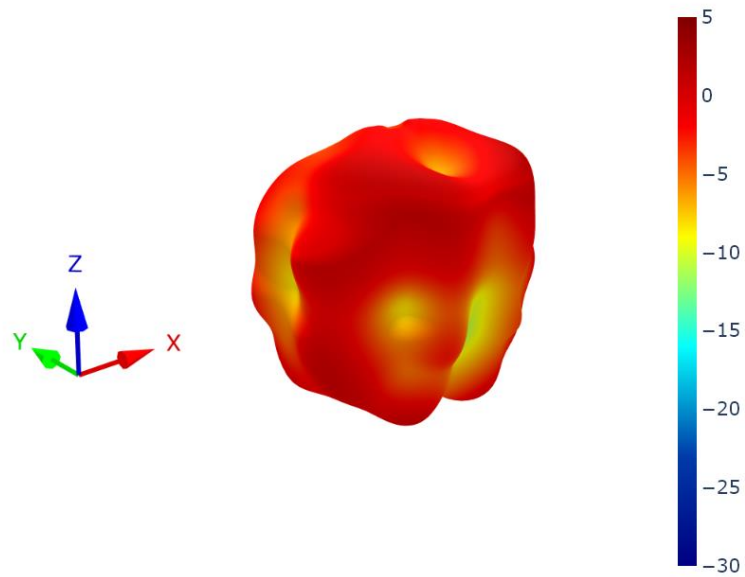

4.5 GW.26.0111 - Patterns at 2460 MHz

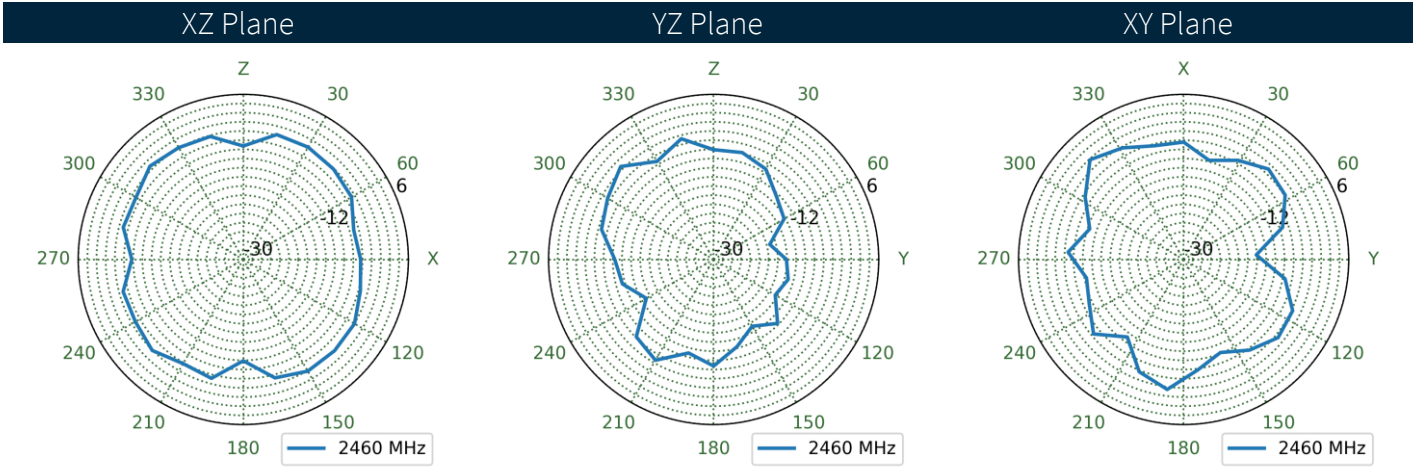
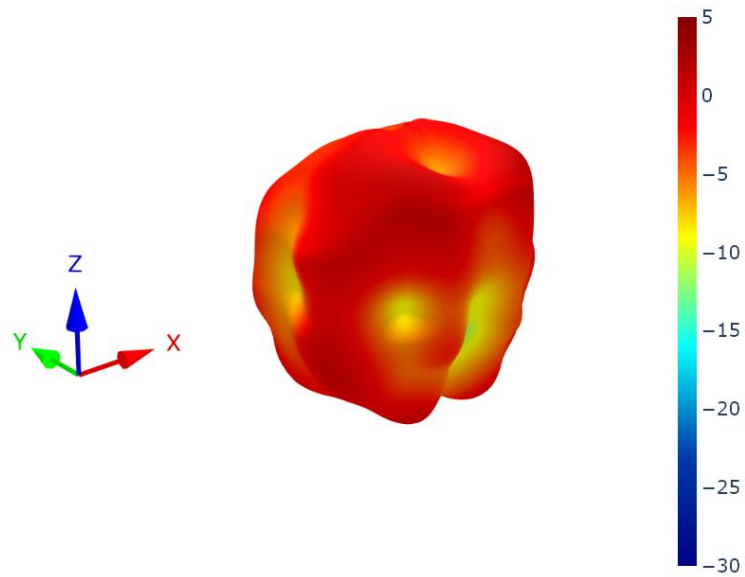

4.6 GW.26.0111 - Patterns at 2480 MHz

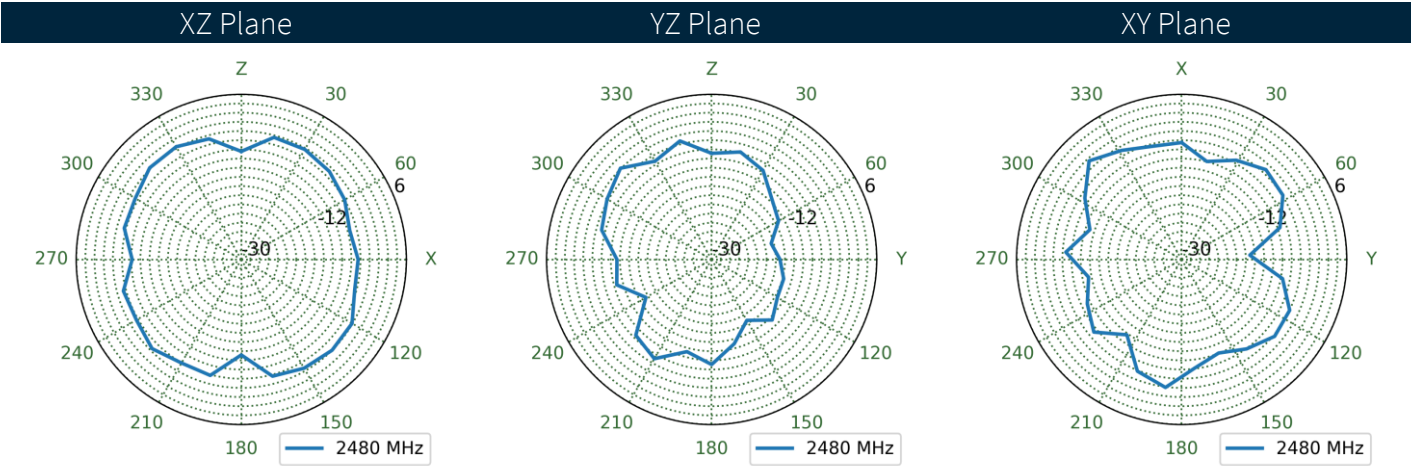
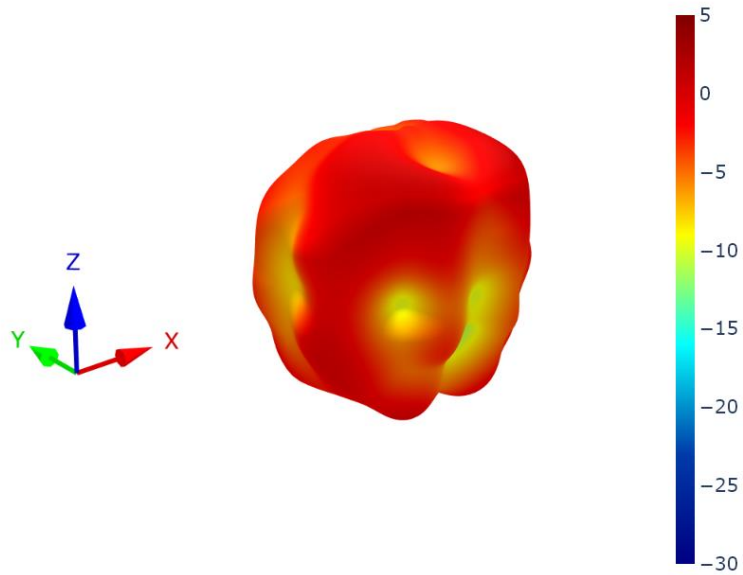

4.7 GW.26.0111 - Patterns at 2500 MHz

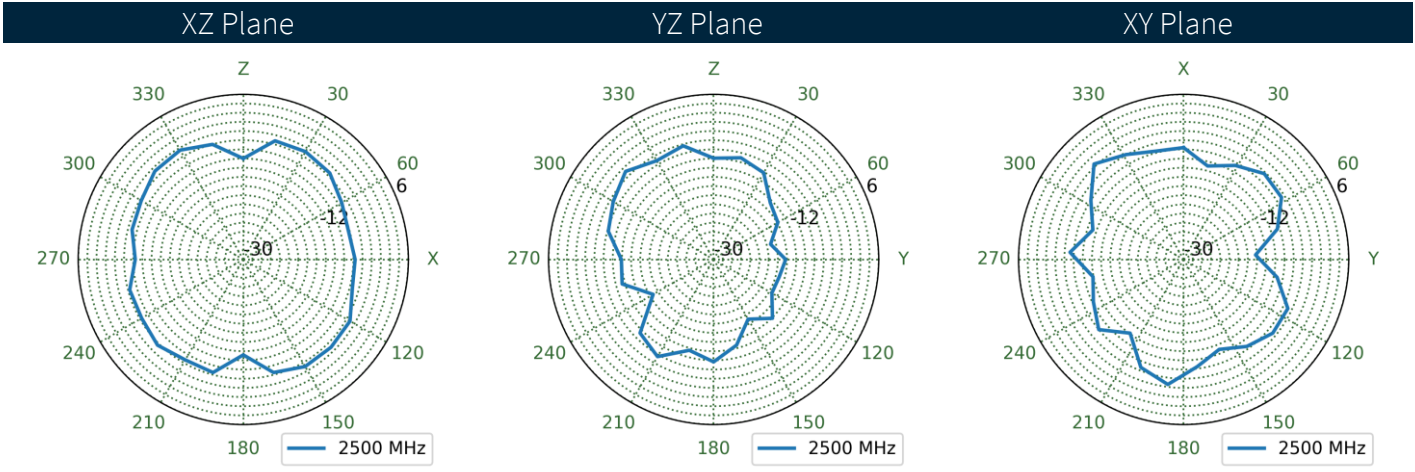
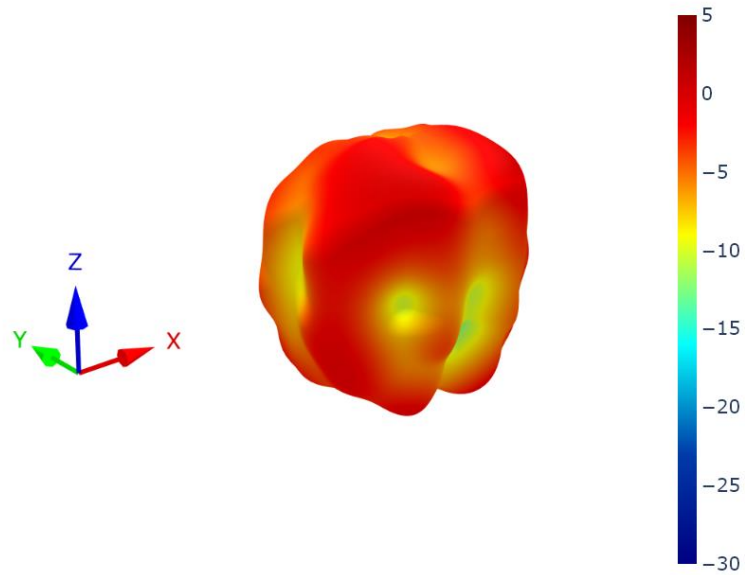

5. Mechanical Drawing

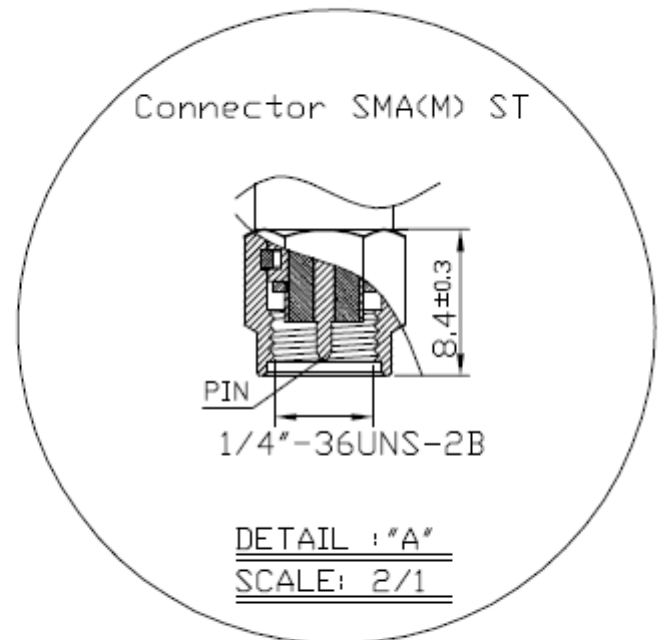
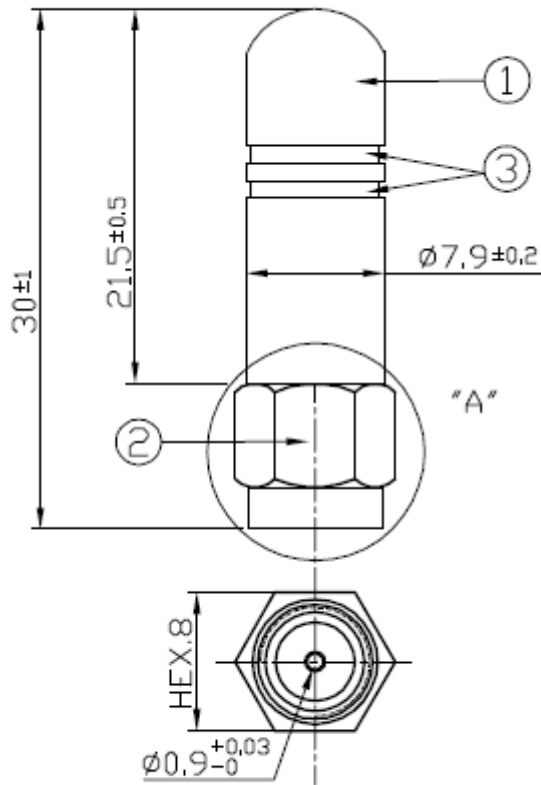

1	Connector	SMA(M)ST Brass
2	Antenna Cover	TPEE (Black)
3	Colour Stripes	Apple Green – Acrylic Paint

6. Packaging

1 pcs GW.26.0111 per PE Bag
 Bag Dimensions - 74 x 42 mm
 Weight - 4g

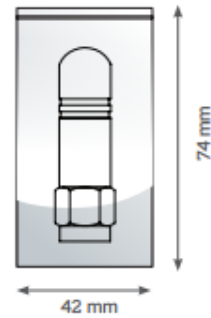

100 pcs GW.26.0111 per PE Large Bag
 Bag Dimensions - 280x 180mm
 Weight - 400kg

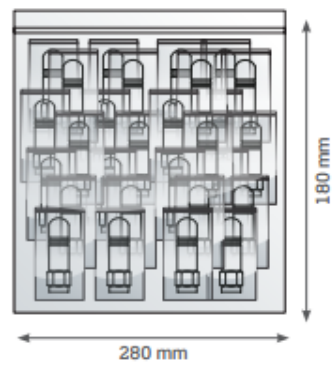

1500 pcs GW.26.0111 per carton
 Carton - 360x 310 x 160mm
 Weight - 6.5Kg

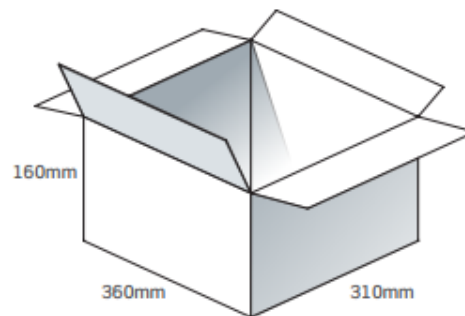

Pallet Dimensions 120x 100 x 143cm
 72 Cartons per Pallet
 12 Cartons per layer
 6 Layers

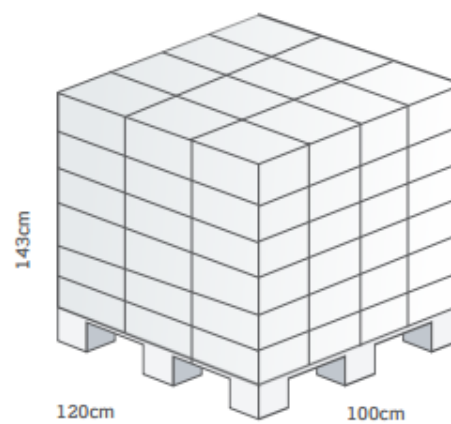

Changelog for the datasheet

SPE-11-8-035 – GW.26.0111

Revision: K (Current Version)

Date:	2023-08-31
Notes:	Updated Format
Author:	Thomas Doyle

Previous Revisions

Revision: J

Date:	2017-02-13
Notes:	Made changes to intro as per doc issued by DC.
Author:	Andy Mahoney

Revision: E

Date:	2013-09-16
Notes:	Amended table heading o Page 2 - general formatting
Author:	Aine Doyle

Revision: I

Date:	2017-01-05
Notes:	Updated with Packaging and disclaimer info
Author:	Andy Mahoney

Revision: D

Date:	2012-03-26
Notes:	
Author:	Unknown

Revision: H

Date:	2016-05-18
Notes:	Amended Peak Gain
Author:	Aine Doyle

Revision: C

Date:	2011-05-08
Notes:	
Author:	Unknown

Revision: G

Date:	2015-08-24
Notes:	Added Note on Gain
Author:	Aine Doyle

Revision: B

Date:	2011-07-20
Notes:	
Author:	Unknown

Revision: F

Date:	2014-03-12
Notes:	Amended Bandwidth to 100MHz
Author:	Aine Doyle

Revision: A (First Release)

Date:	2011-07-14
Notes:	
Author:	Unknown



www.taoglas.com

