

2570MHz

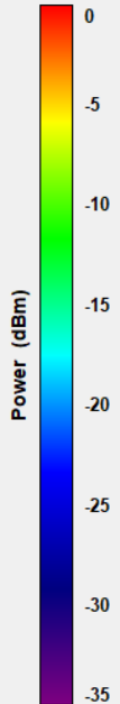
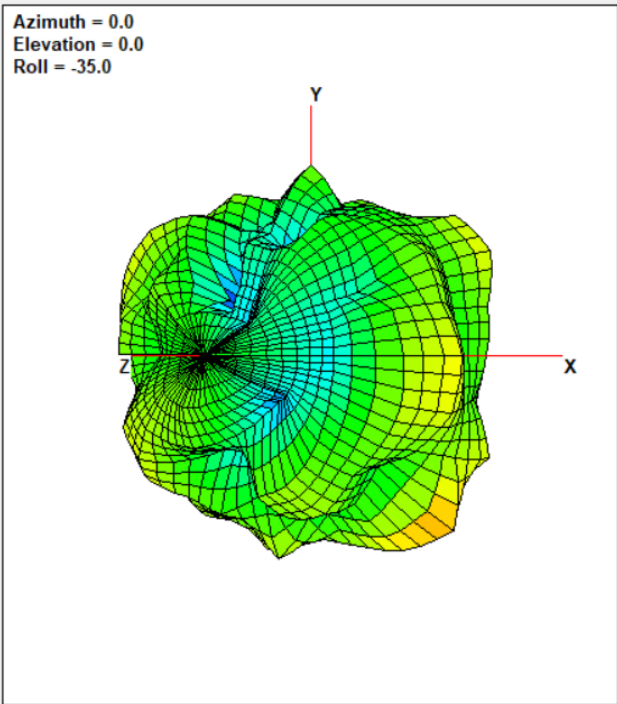

XY Plane

XZ Plane

YZ Plane

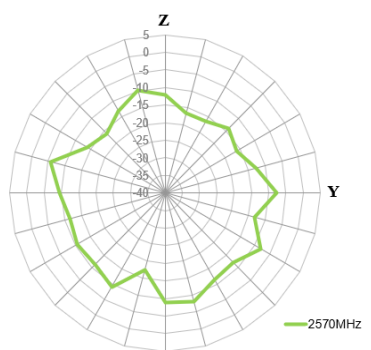
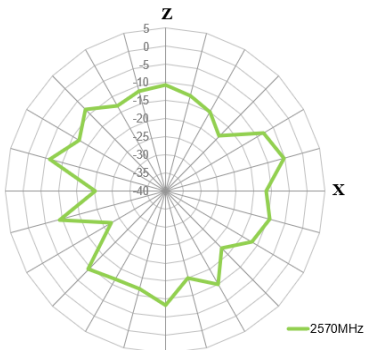
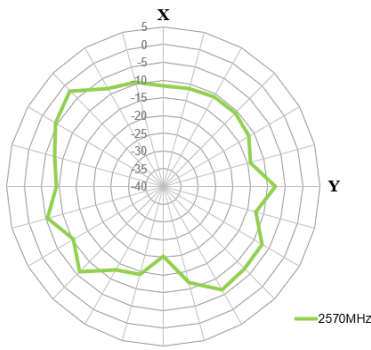

2690MHz

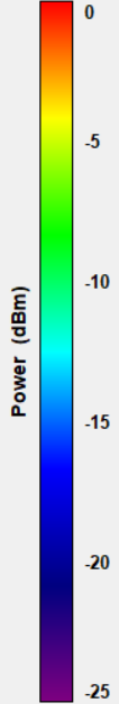
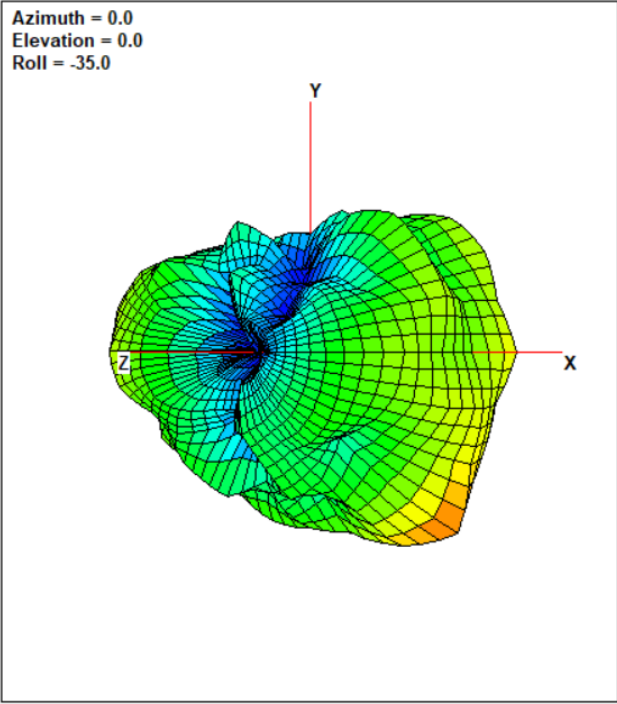

XY Plane

XZ Plane

YZ Plane

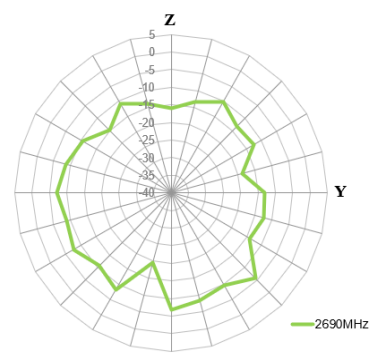
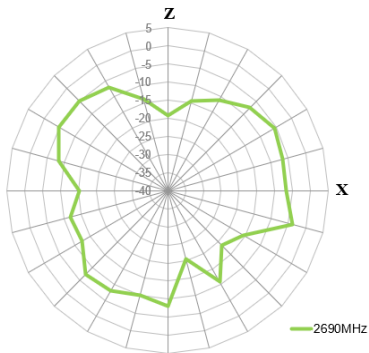
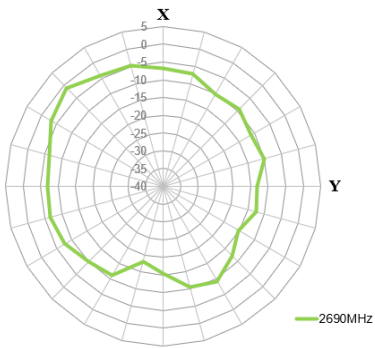

6. Radiation Patterns - GNSS

6.1 Test Setup

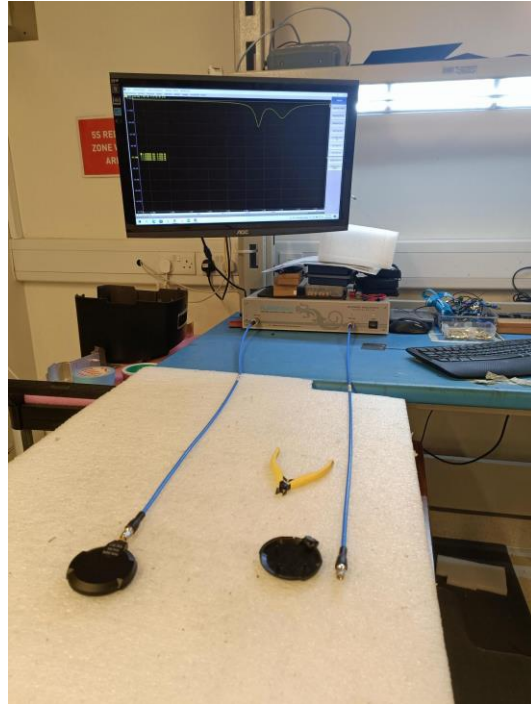

Free space

6.1 1575MHz – GNSS Freespace2D & 3D Radiation Patterns

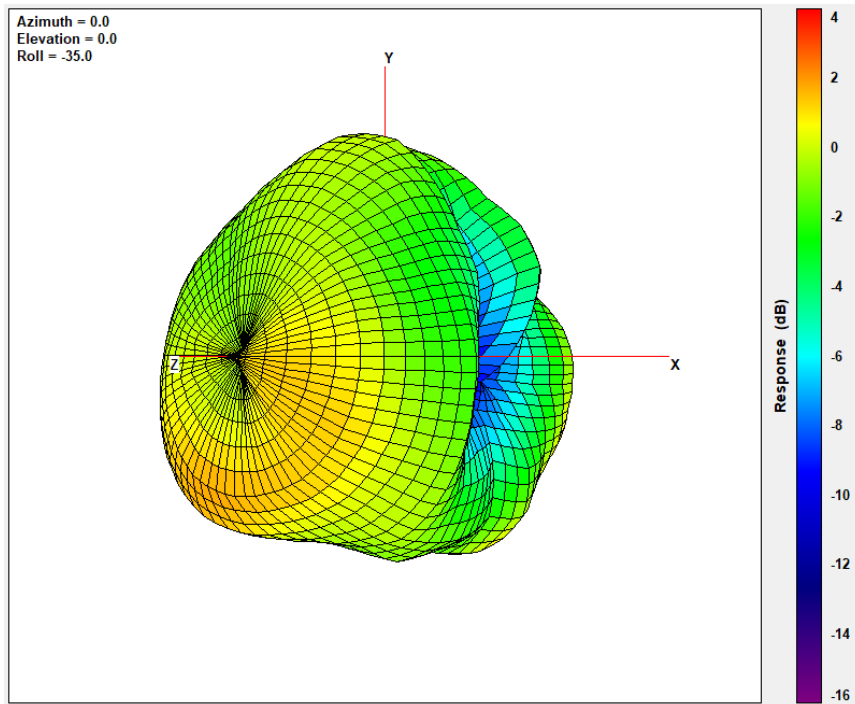

XY Plane

XZ Plane

YZ Plane

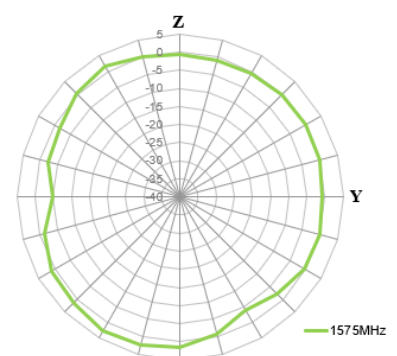
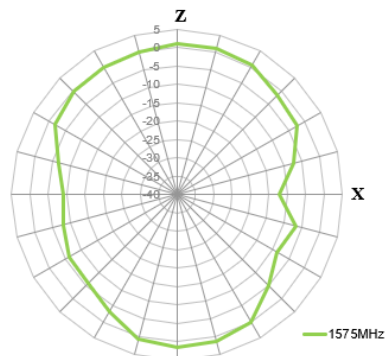
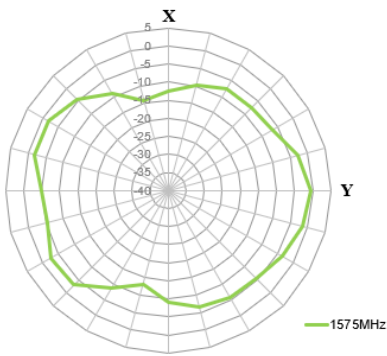

1602MHz

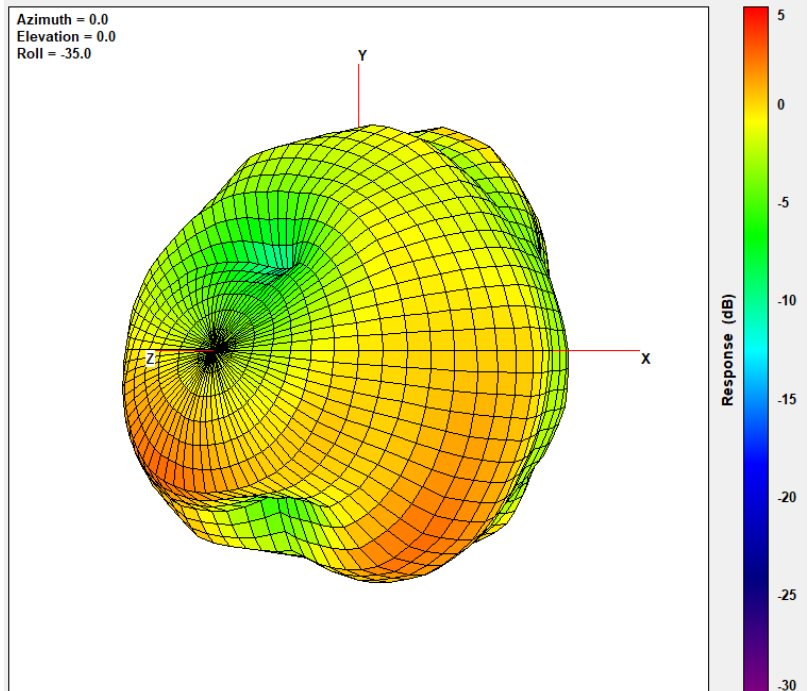

XY Plane

XZ Plane

YZ Plane

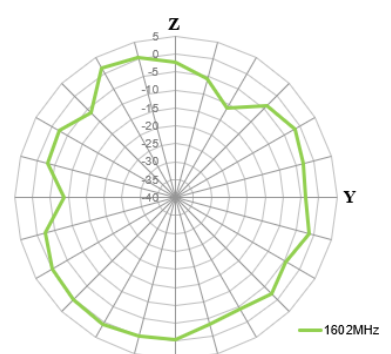
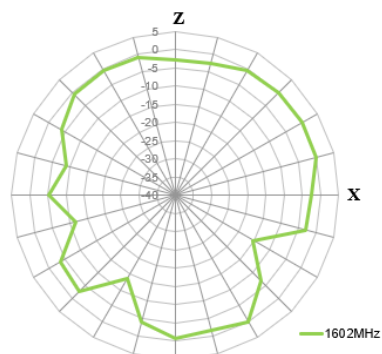
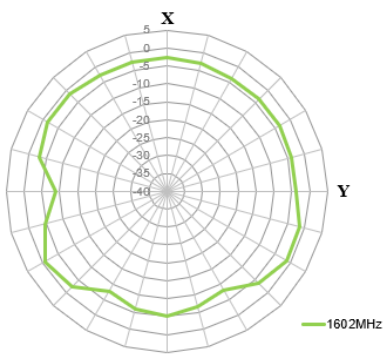

7. Mechanical Drawing (Units: mm)

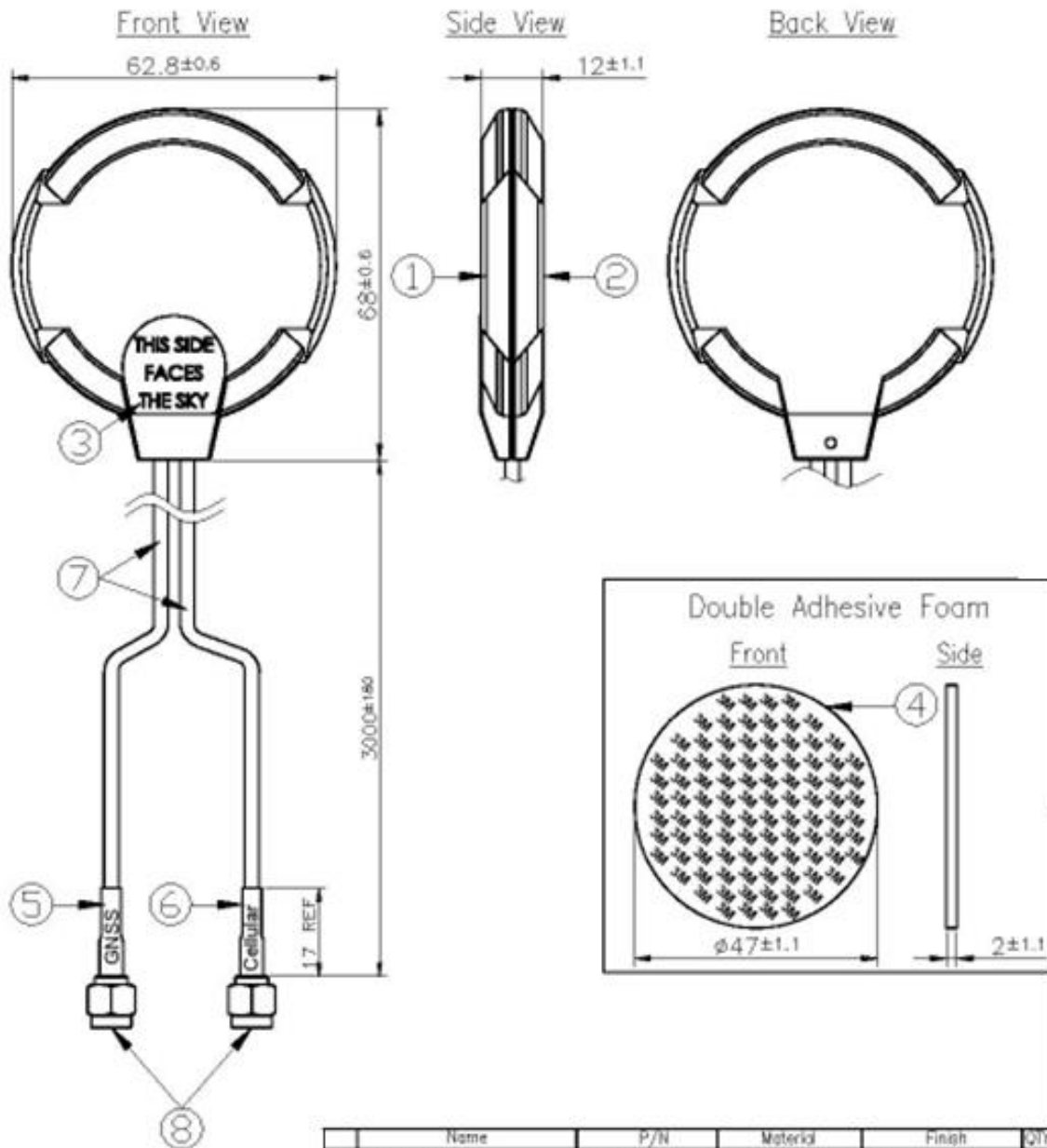

| | Name | P/N | Material | Finish | QTY |
|---|-----------------------------|----------------|------------------|----------------------|-----|
| 1 | Housing Top | 000113ED00066A | PC+ABS | Black | 1 |
| 2 | Housing Bottom | 000113ED10066A | PC+ABS | Black | 1 |
| 3 | Clear Label | 001013ED00051A | PET | White | 1 |
| 4 | Double Adhesive Black Foam | 001013ED00039A | 3M 9448HK+CR4305 | White Liner | 1 |
| 5 | Heat Shrink Tube (GNSS) | 001316C000000A | PE | Blue Tube/White Text | 1 |
| 6 | Heat Shrink Tube (Cellular) | 001316D100000A | PE | Blue Tube/White Text | 1 |
| 7 | RG174 Coaxial Cable | 301315C000000A | PVC | Black | 2 |
| 8 | SMA/MST | 200216D000098A | Brass | Au Plated | 2 |

Download Drawing

Download 3D Model

8. Packaging

1 pcs MA220.LB.001 per PE Bag
 Bag Dimensions - 600 x 450 mm
 Weight - 1200g

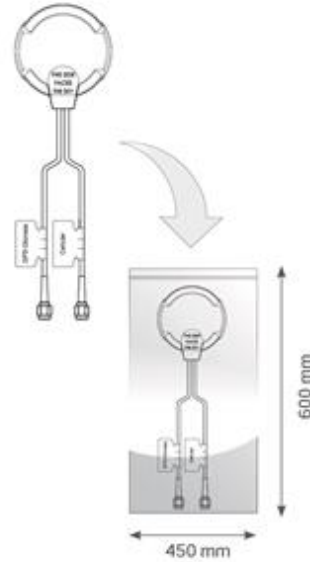

100 pcs MA220.LB.001 per carton
 Carton - 730 x 390 x 250mm
 Weight - 13.7Kg

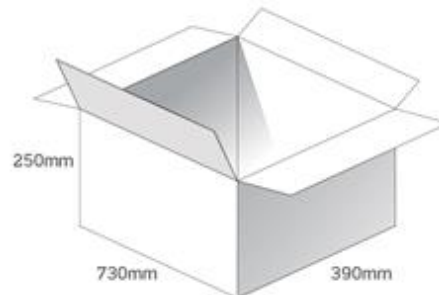

Pallet Dimensions 1200 x 1000 x 1450mm
 12 Cartons per Pallet
 4 Cartons per layer
 5 Layers

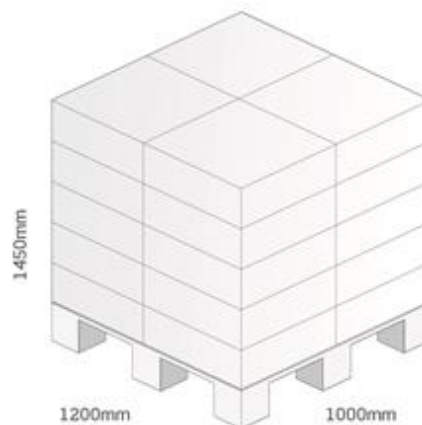

Changelog for the datasheet

SPE-14-8-016-G – MA220.LB.001

Revision: G (Current Version)

| | |
|------------------|-----------------------|
| Date: | 2022-07-28 |
| Changes: | Full Datasheet update |
| Changes Made by: | Evan Murphy |

Previous Revisions

Revision: F

| | |
|------------------|-------------|
| Date: | 2019-02-05 |
| Changes: | |
| Changes Made by: | Jack Conroy |

Revision: A (Original First Release)

| | |
|---------|------------------|
| Date: | 2014-02-27 |
| Notes: | |
| Author: | Technical Writer |

Revision: E

| | |
|------------------|------------------|
| Date: | 2018-11-29 |
| Changes: | |
| Changes Made by: | Technical Writer |

Revision: D

| | |
|------------------|------------------|
| Date: | 2017-06-19 |
| Changes: | |
| Changes Made by: | Technical Writer |

Revision: C

| | |
|------------------|------------------|
| Date: | 2017-06-19 |
| Changes: | |
| Changes Made by: | Technical Writer |

Revision: B

| | |
|------------------|------------------|
| Date: | 2014-08-19 |
| Changes: | |
| Changes Made by: | Technical Writer |

Previous Revisions (Continued)

| | |
|--|--|
| | |
| | |
| | |
| | |
| | |
| | |
| | |



TAOGLAS®

www.taoglas.com

