

960MHz

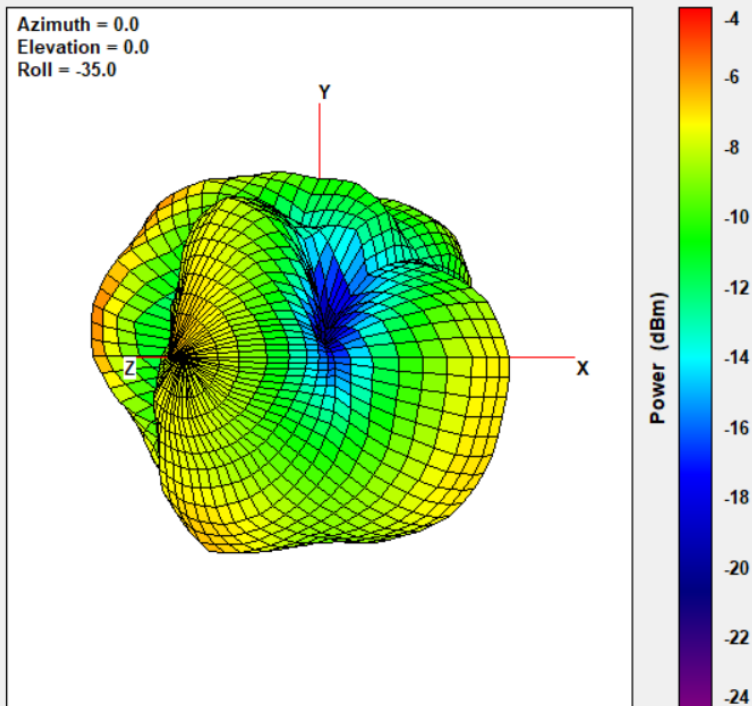

XY Plane

XZ Plane

YZ Plane

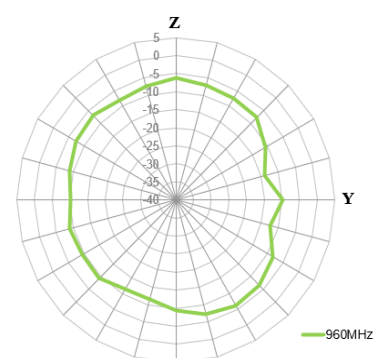
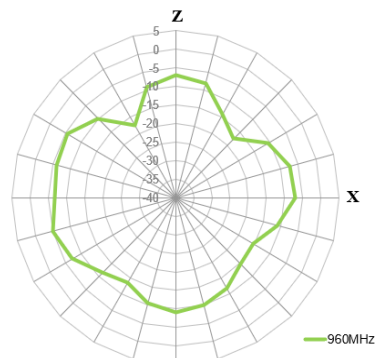
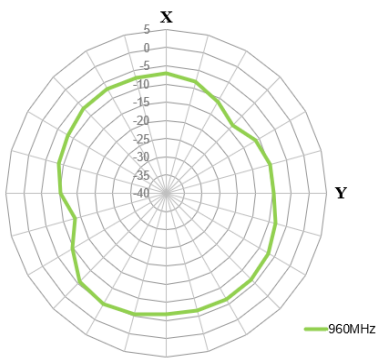

1710MHz

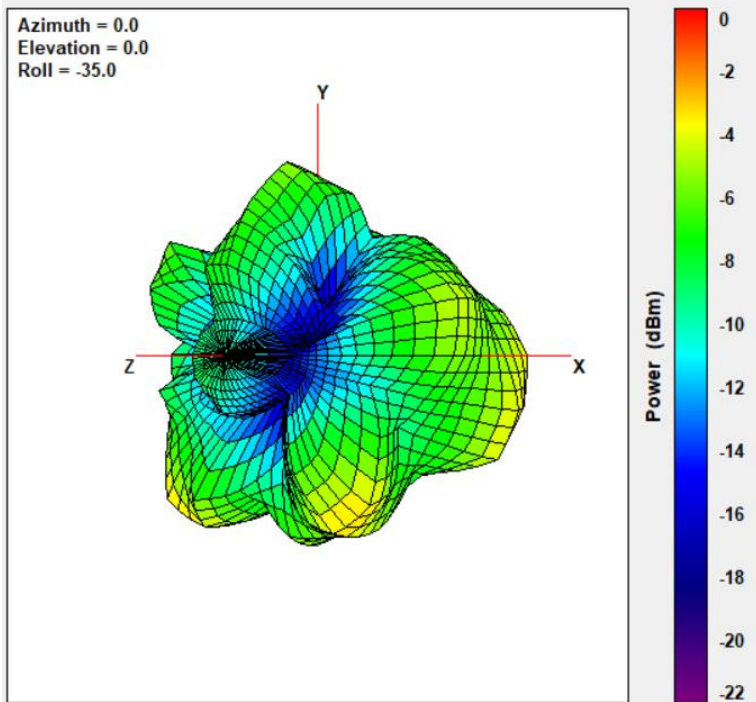

XY Plane

XZ Plane

YZ Plane

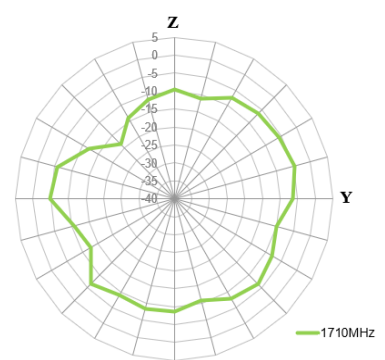
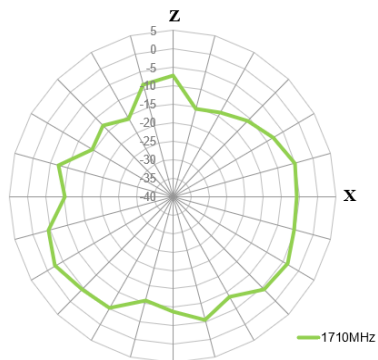
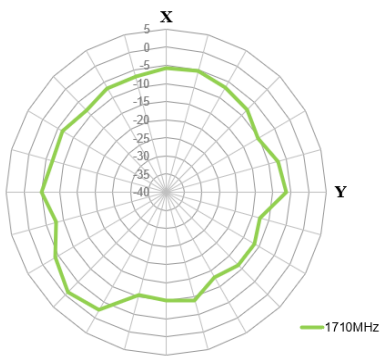

1800MHz

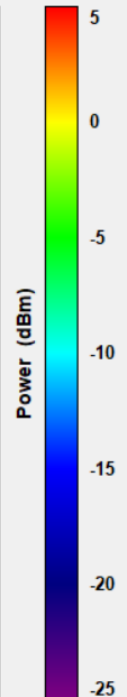
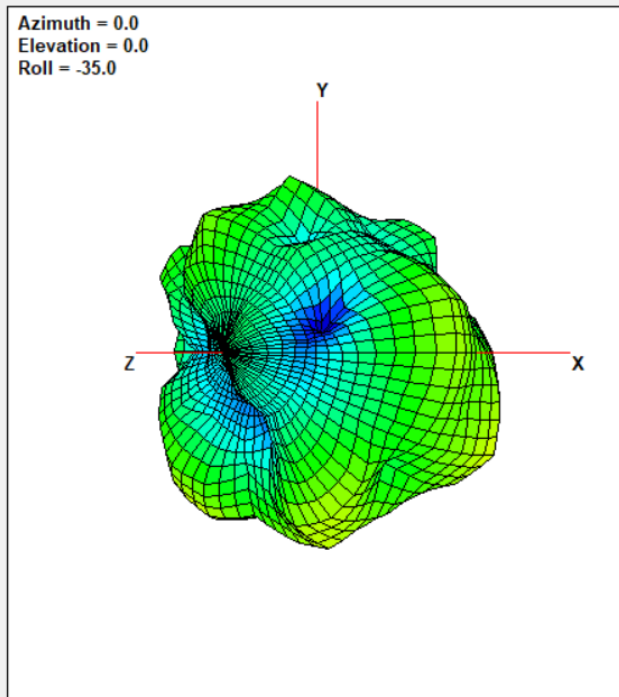

XY Plane

XZ Plane

YZ Plane

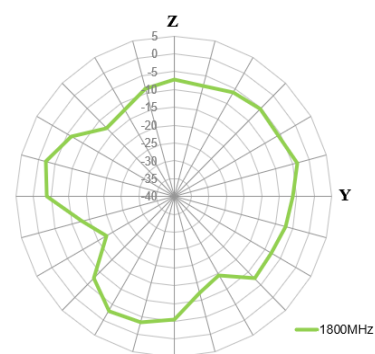
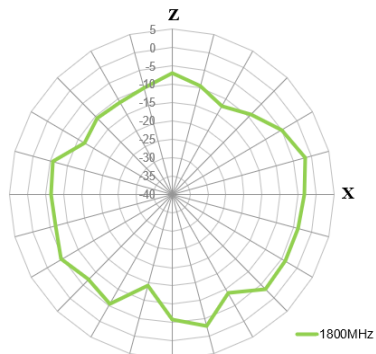
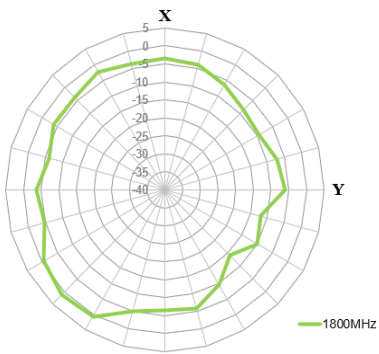

1990MHz

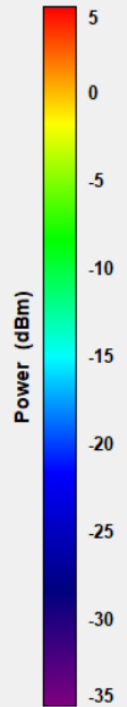
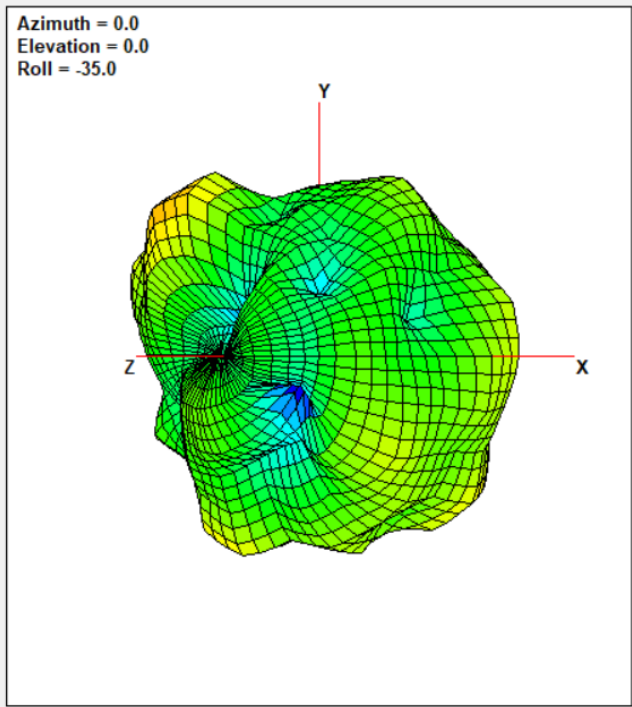

XY Plane

XZ Plane

YZ Plane

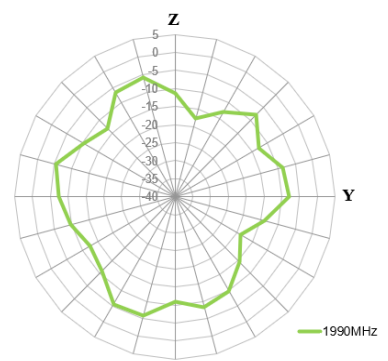
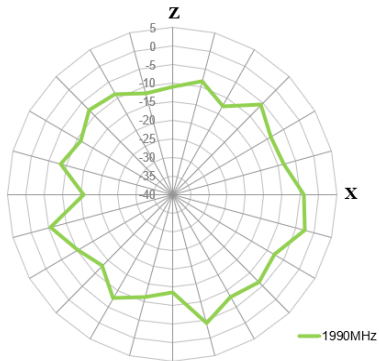
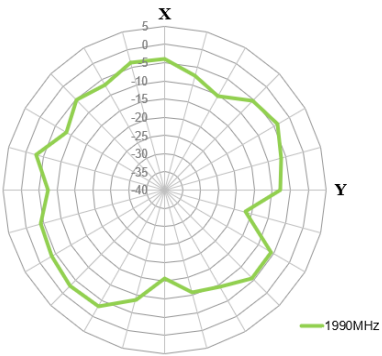

2170MHz

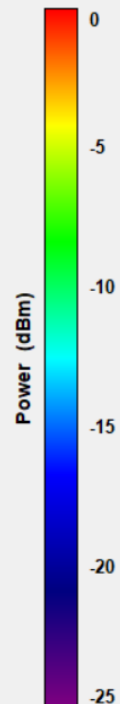
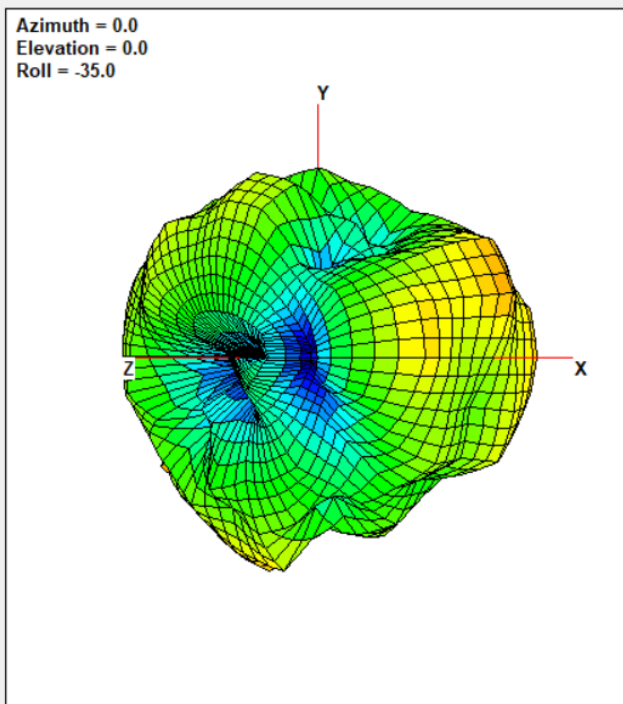

XY Plane

XZ Plane

YZ Plane

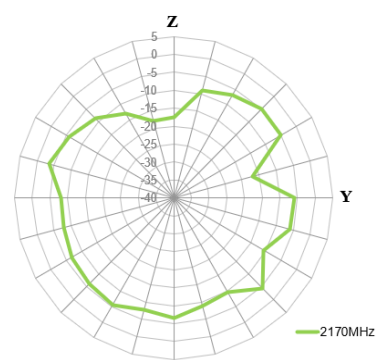
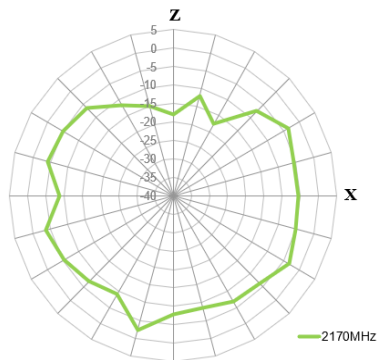
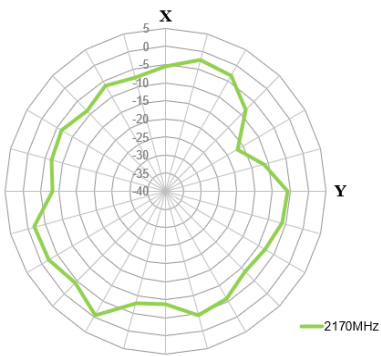

2400MHz

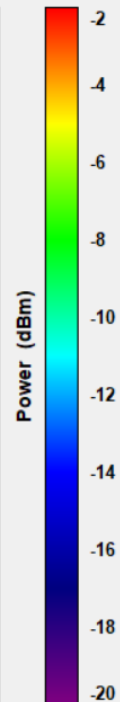
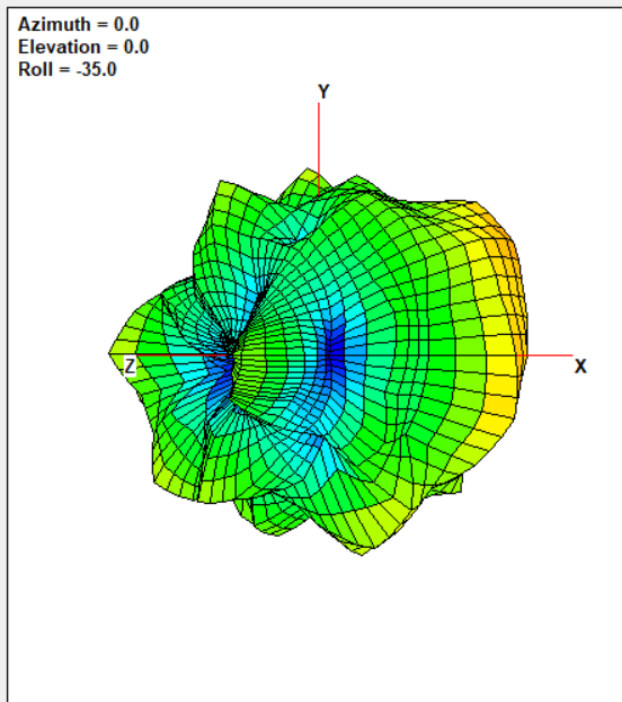

XY Plane

XZ Plane

YZ Plane

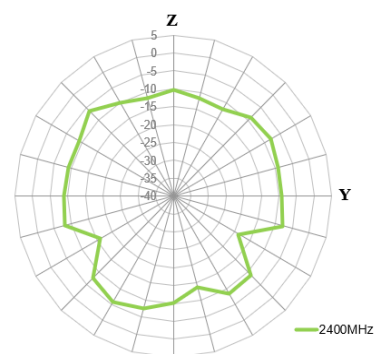
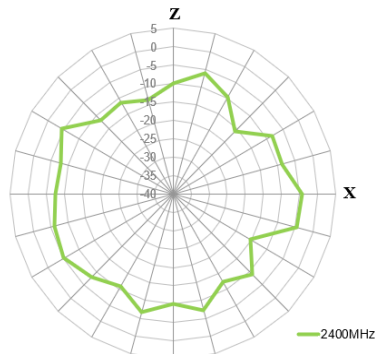
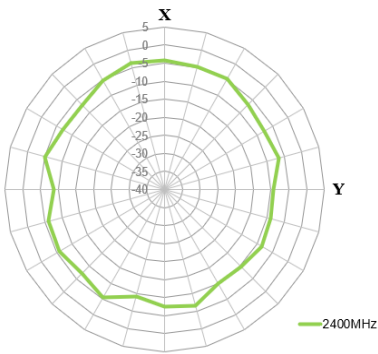

2500MHz

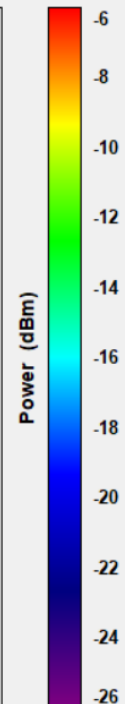
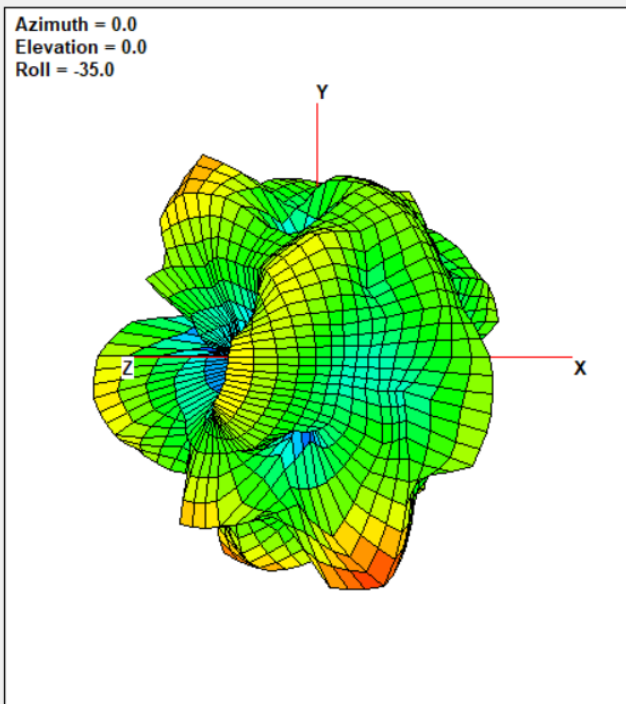

XY Plane

XZ Plane

YZ Plane

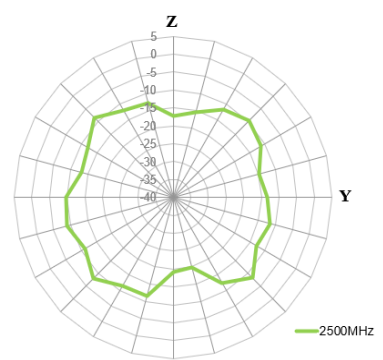
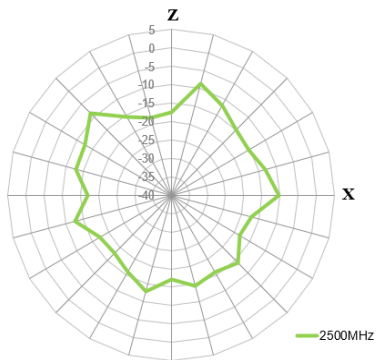
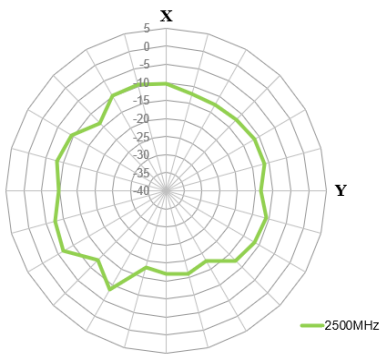

2570MHz

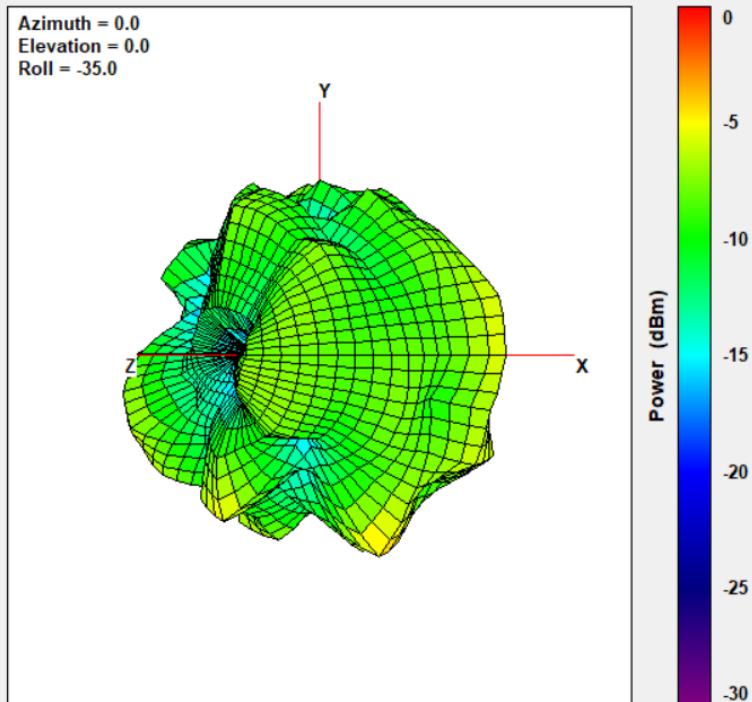

XY Plane

XZ Plane

YZ Plane

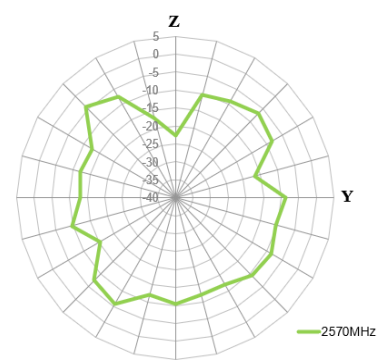
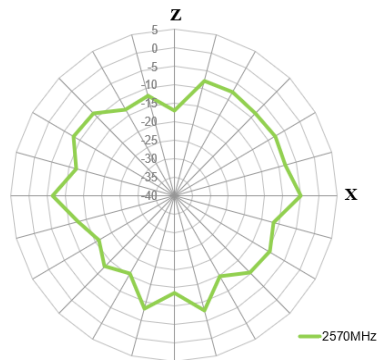
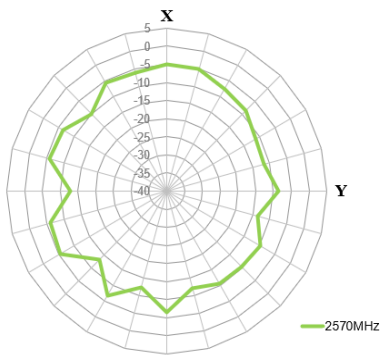

2690MHz

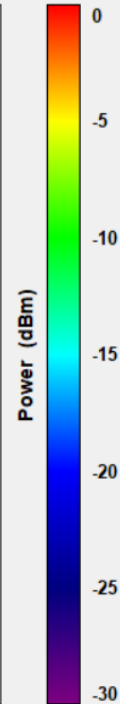
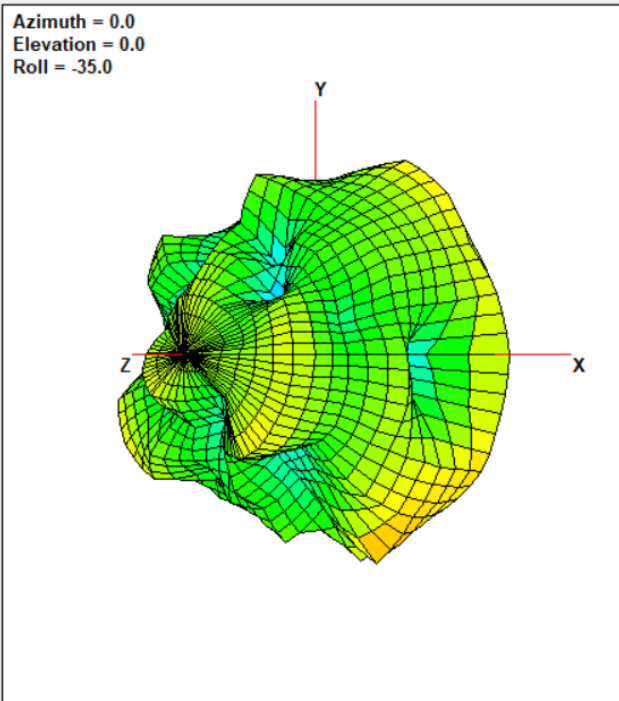

XY Plane

XZ Plane

YZ Plane

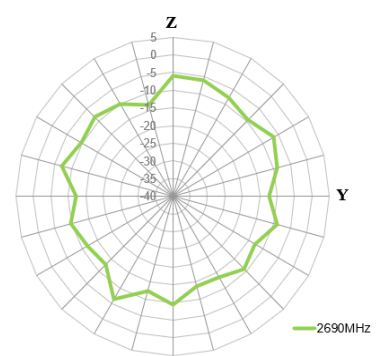
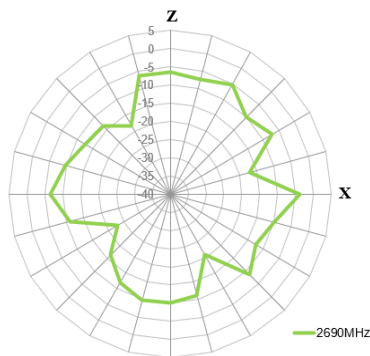
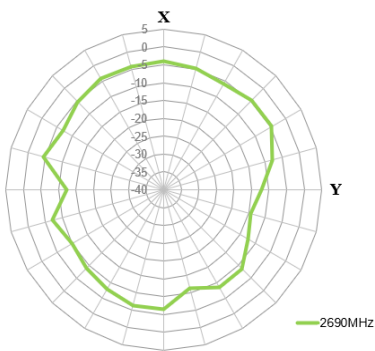

5.4 705MHz – LTE 12x12cm Glass Groundplane 2D & 3D Radiation Patterns

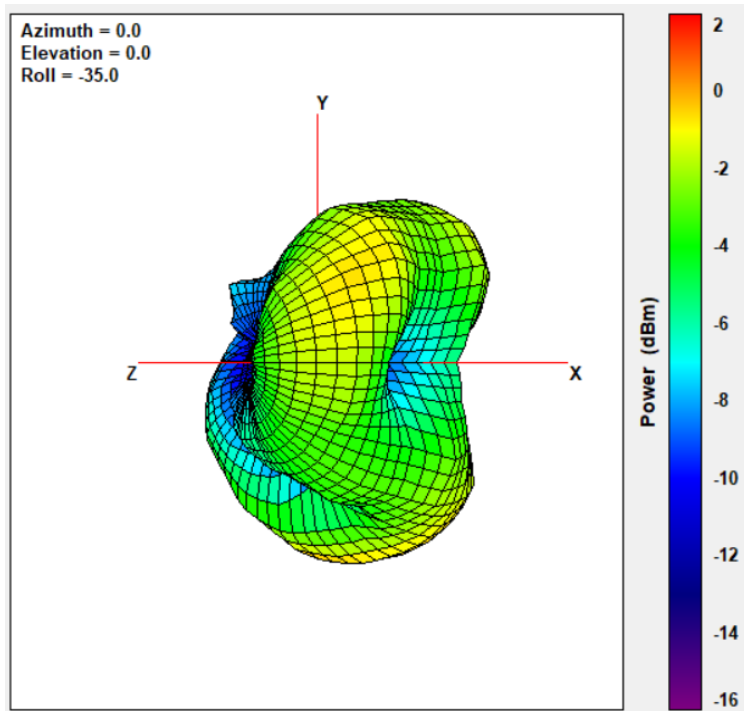

XY Plane

XZ Plane

YZ Plane

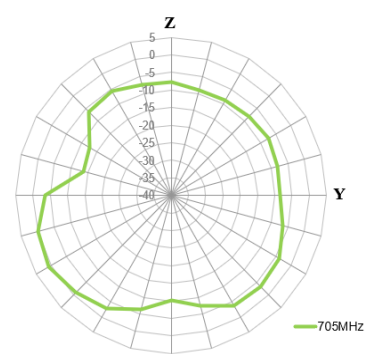
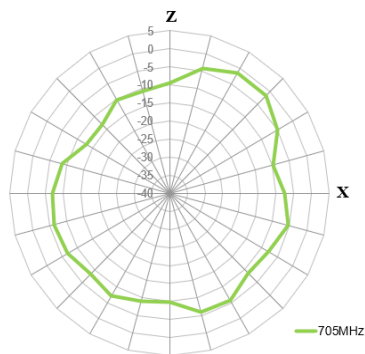
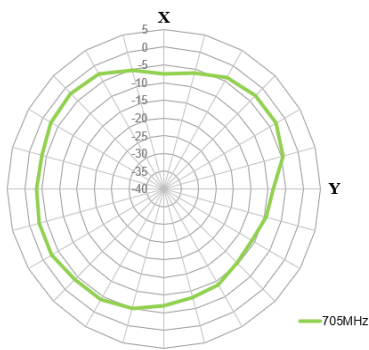

750MHz

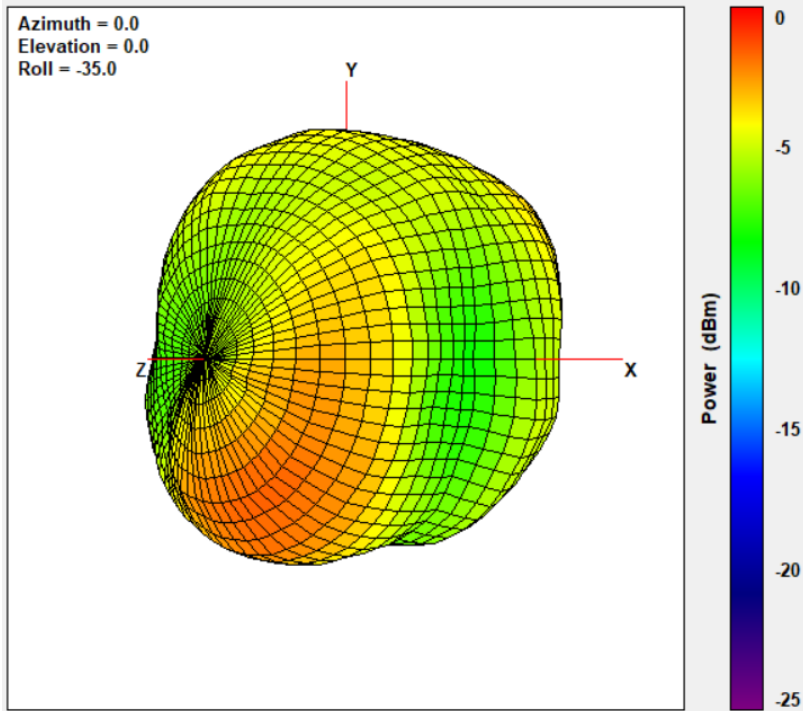

XY Plane

XZ Plane

YZ Plane

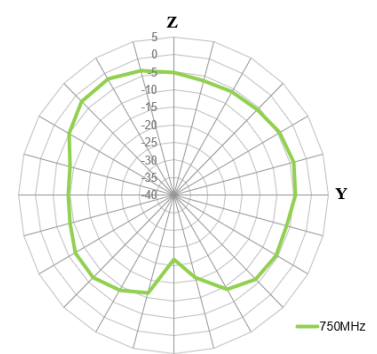
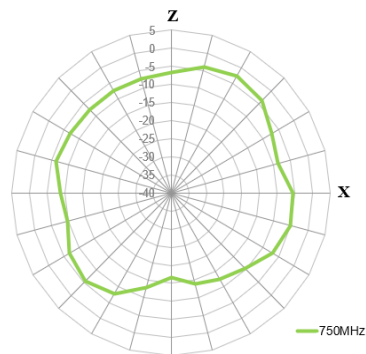
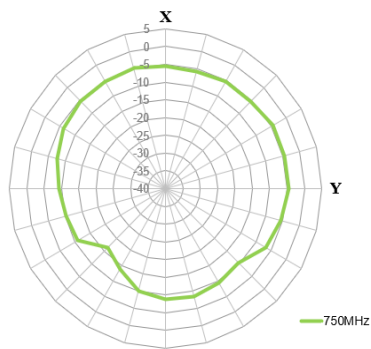

825MHz

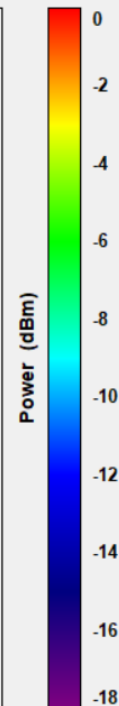
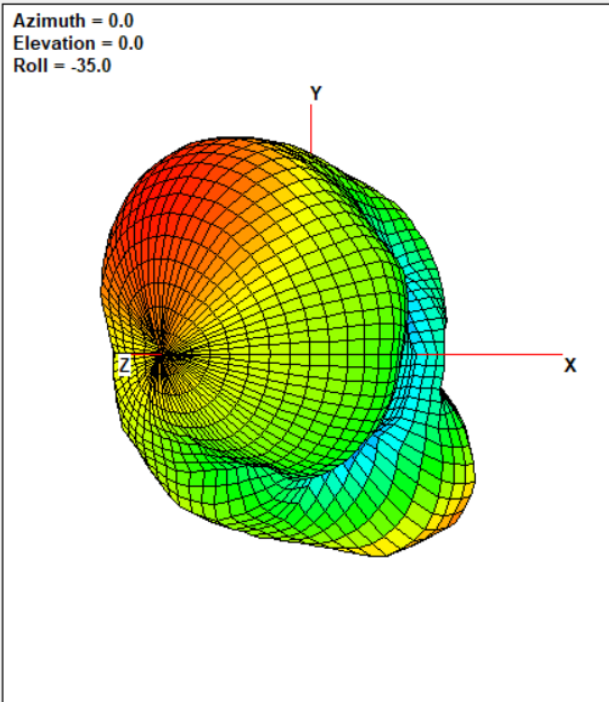

XY Plane

XZ Plane

YZ Plane

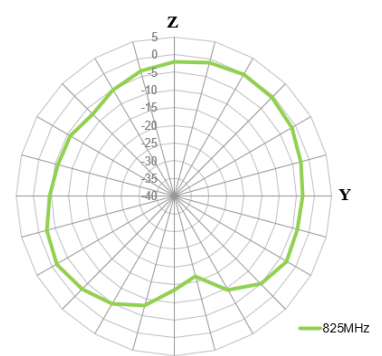
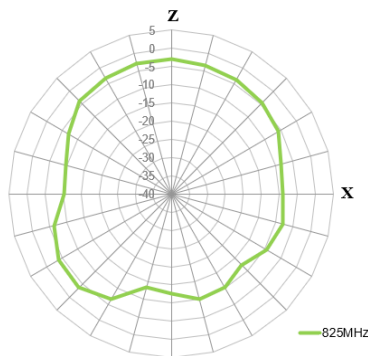
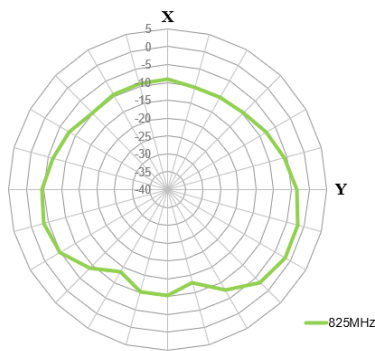

880MHz

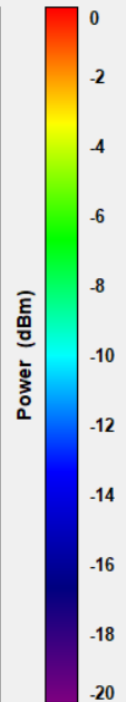
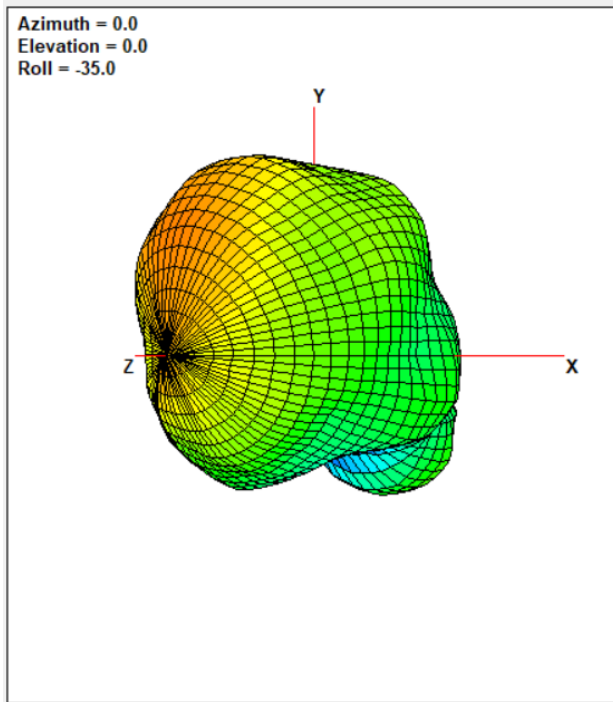

XY Plane

XZ Plane

YZ Plane

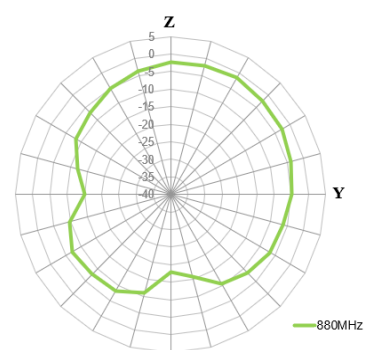
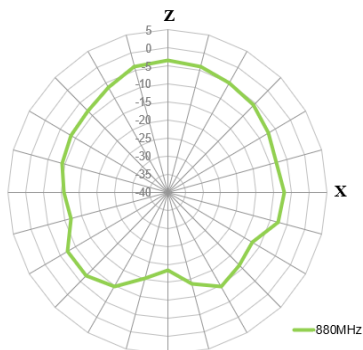
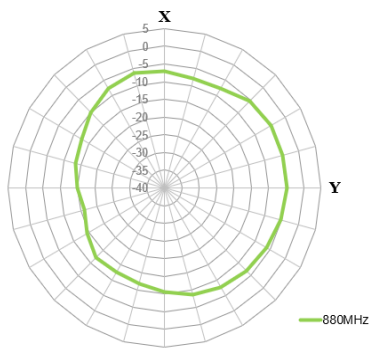

960MHz

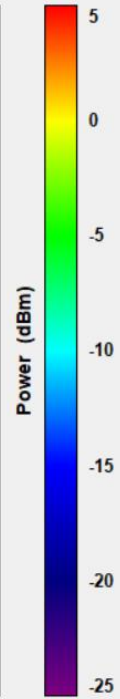
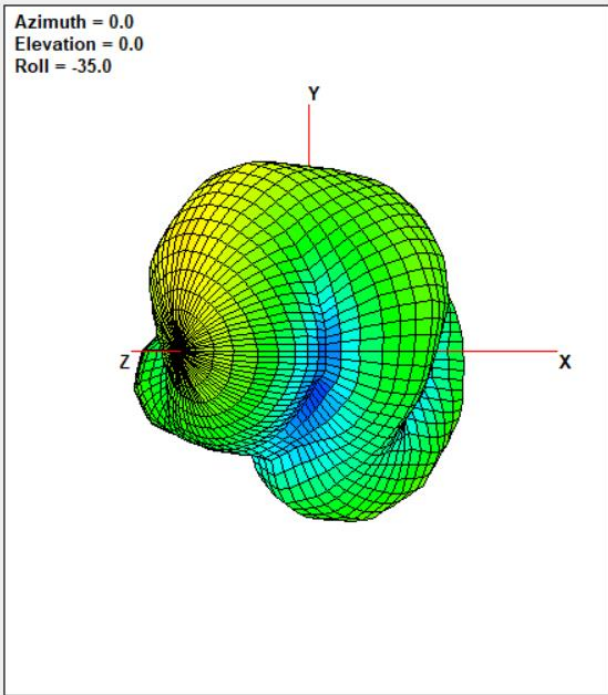

XY Plane

XZ Plane

YZ Plane

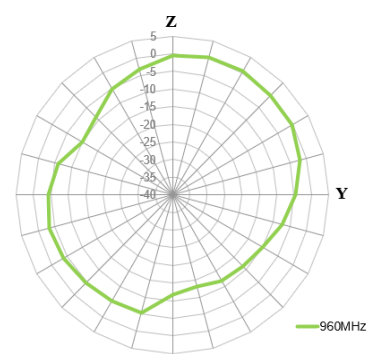
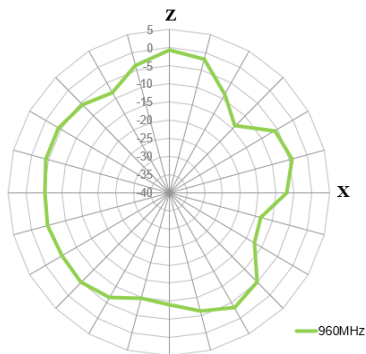
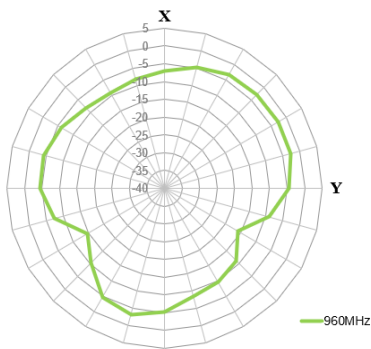

1710MHz

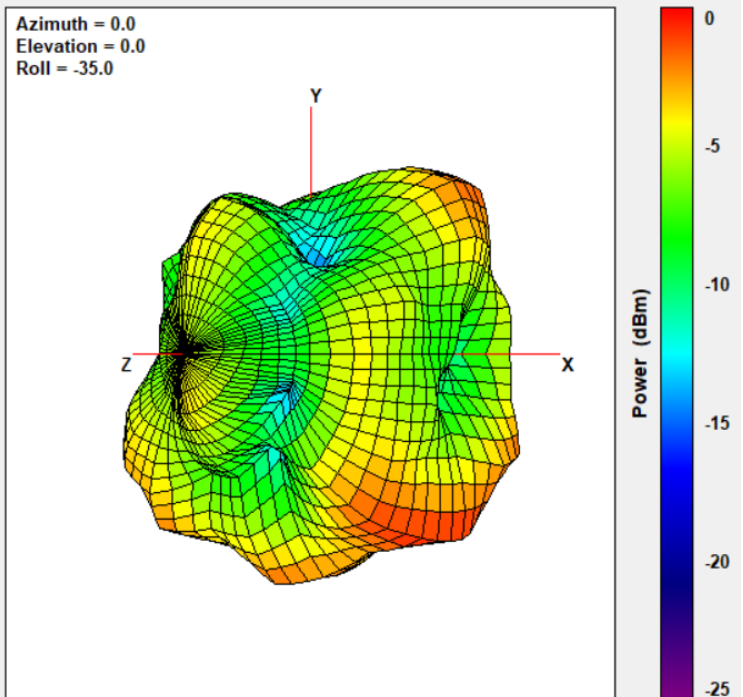

XY Plane

XZ Plane

YZ Plane

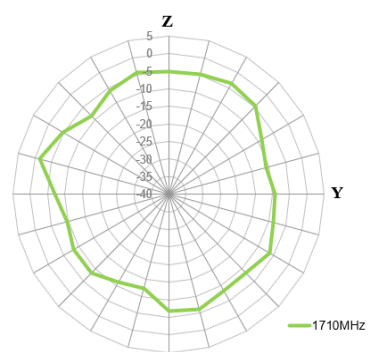
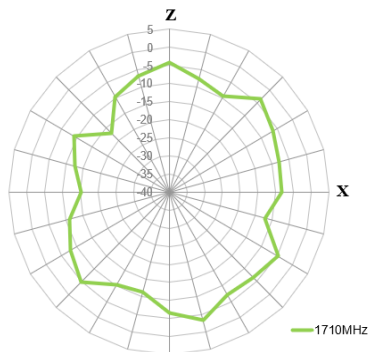
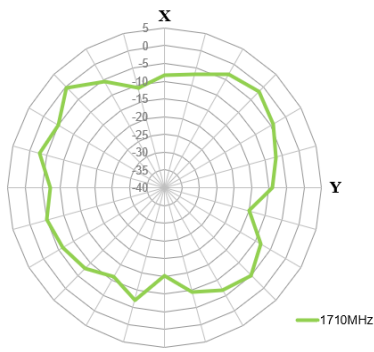

1800MHz

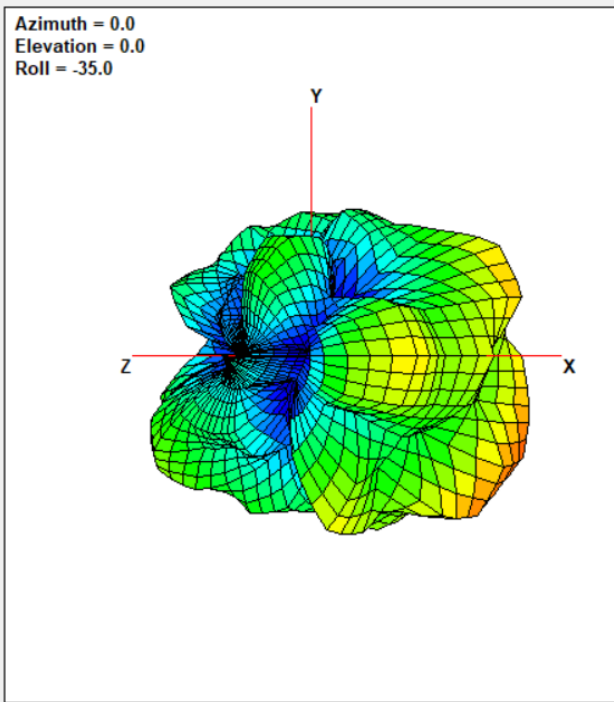

XY Plane

XZ Plane

YZ Plane

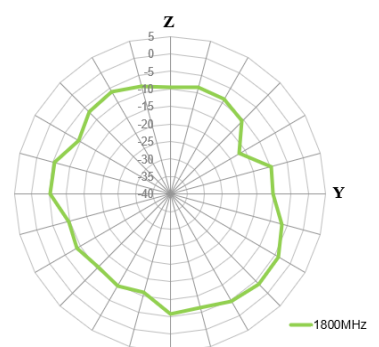
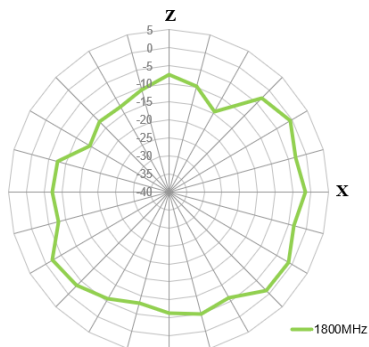
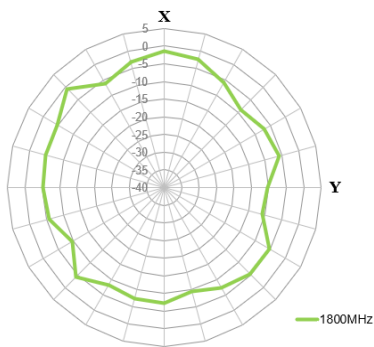

1990MHz

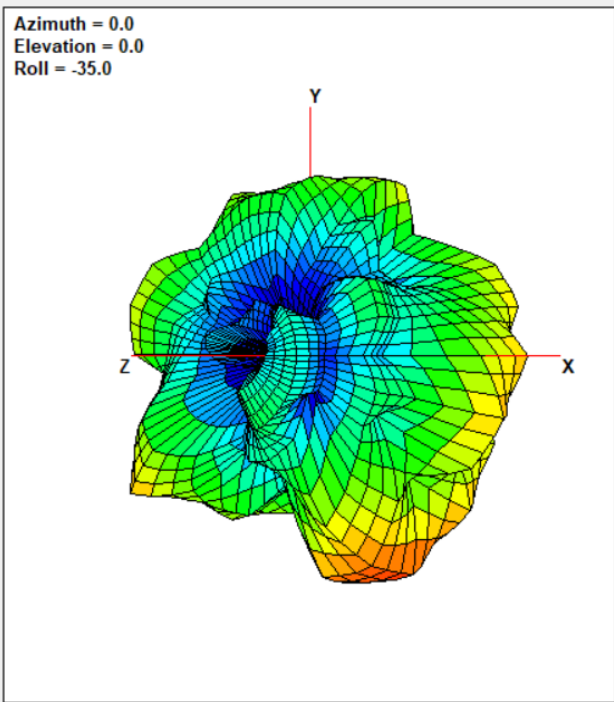

XY Plane

XZ Plane

YZ Plane

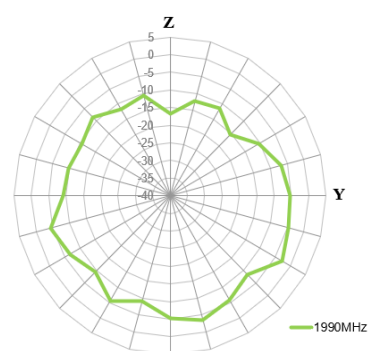
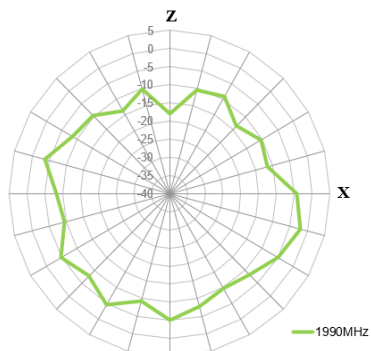
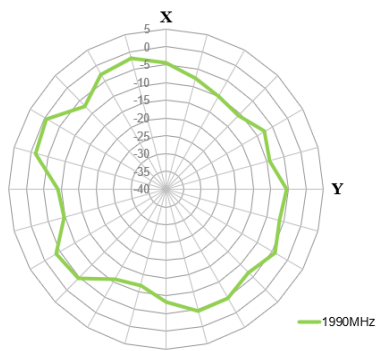

2170MHz

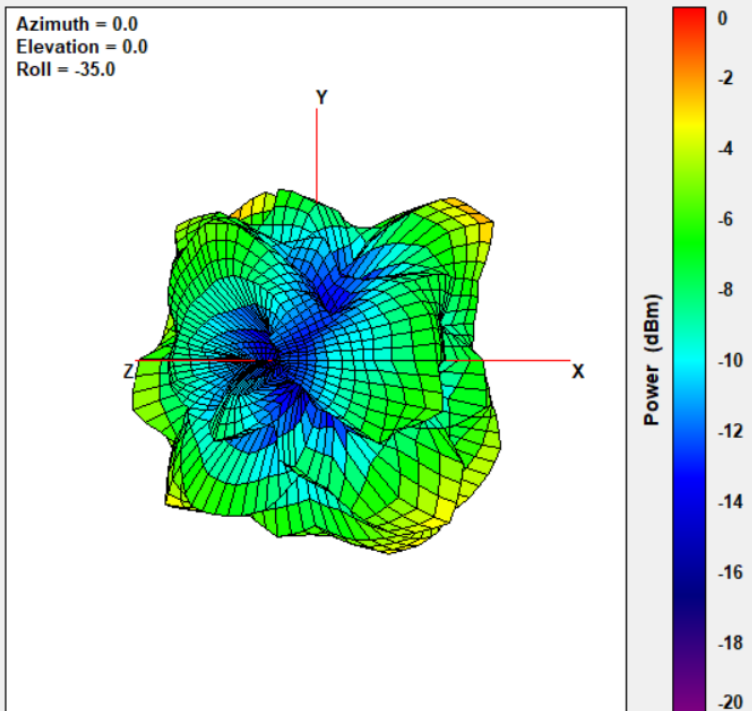

XY Plane

XZ Plane

YZ Plane

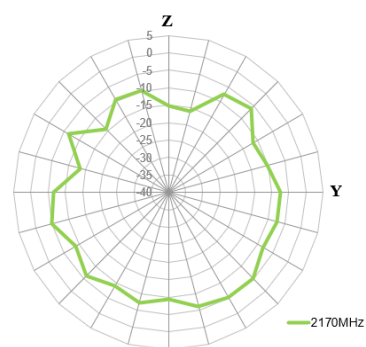
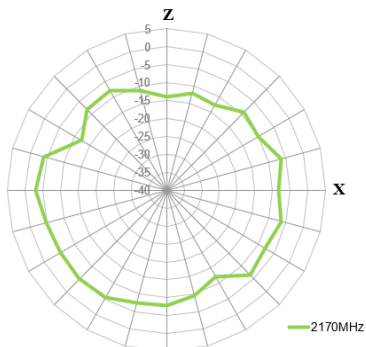
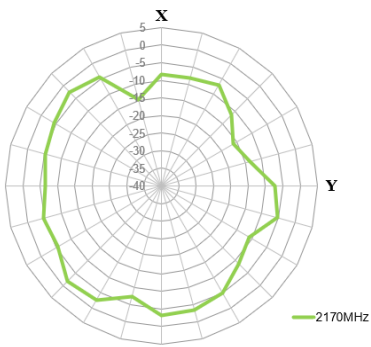

2400MHz

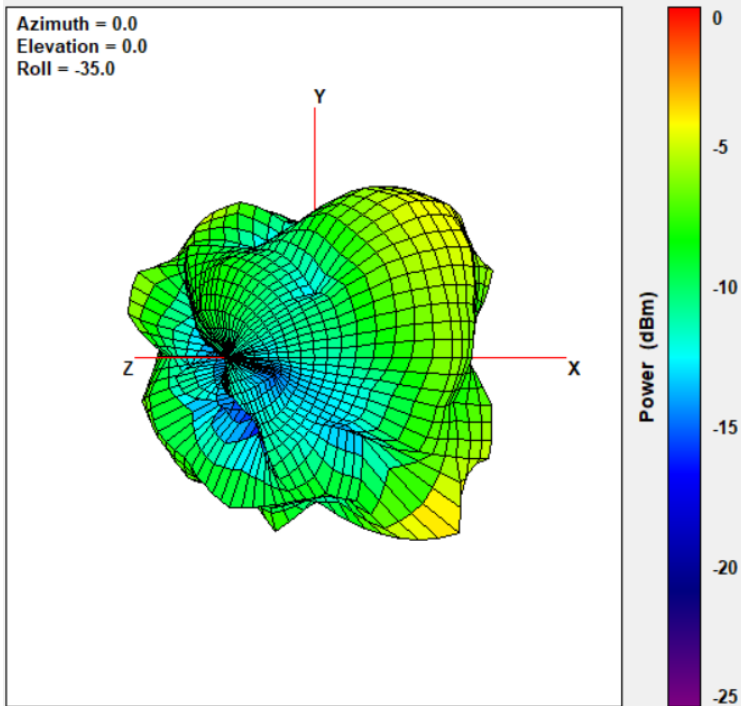

XY Plane

XZ Plane

YZ Plane

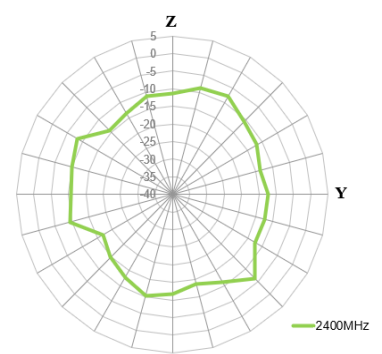
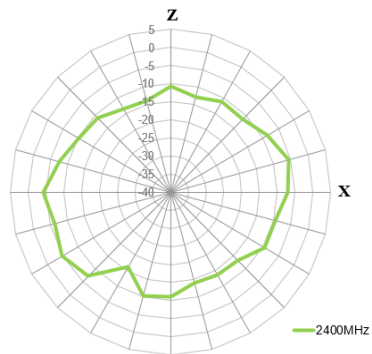
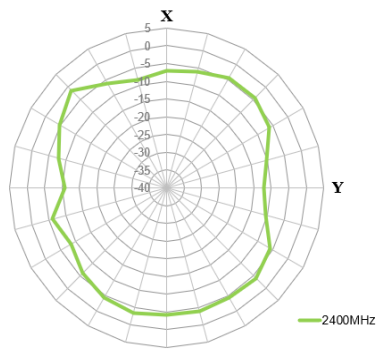

2500MHz

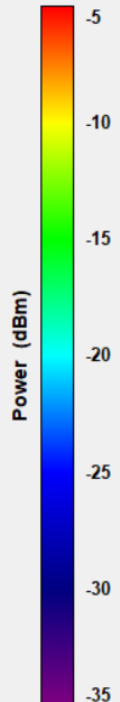
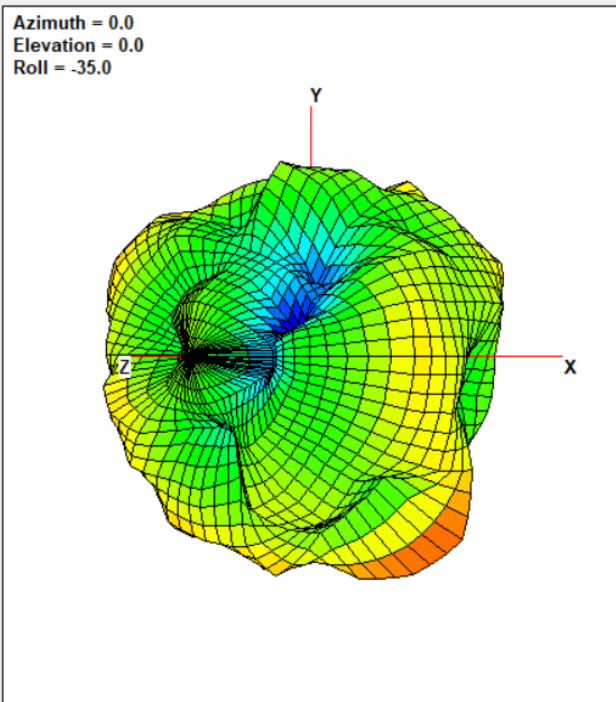

XY Plane

XZ Plane

YZ Plane

