

2570MHz

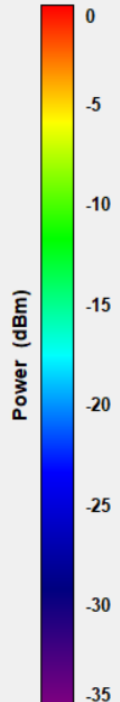
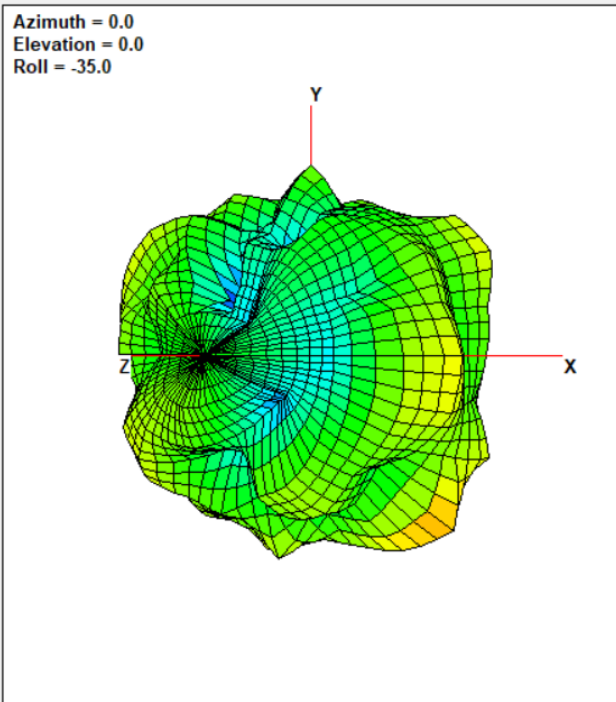

XY Plane

XZ Plane

YZ Plane

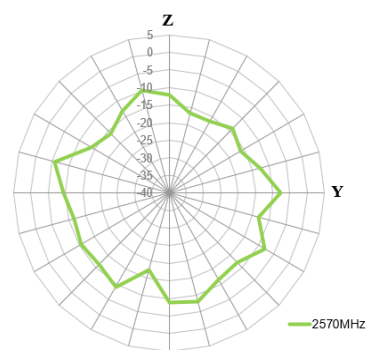
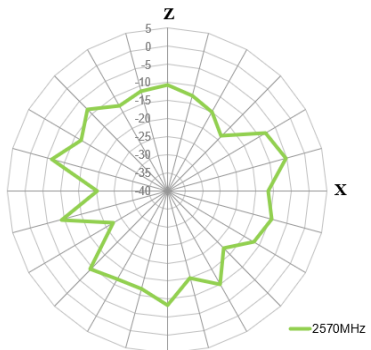
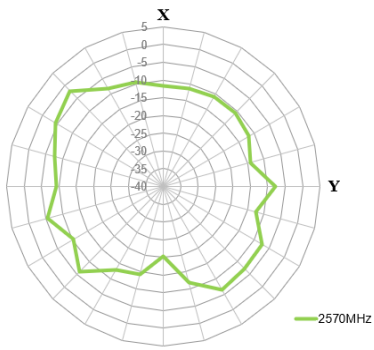

2690MHz

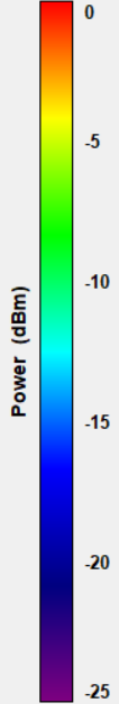
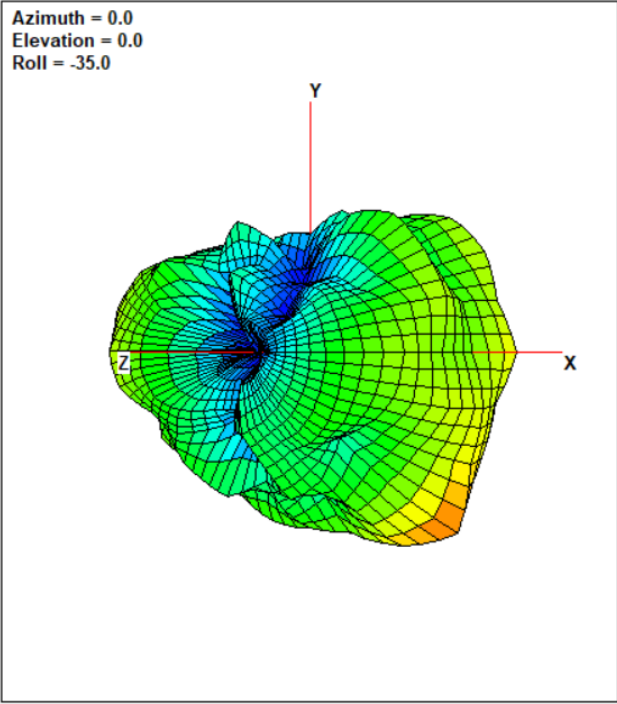

XY Plane

XZ Plane

YZ Plane

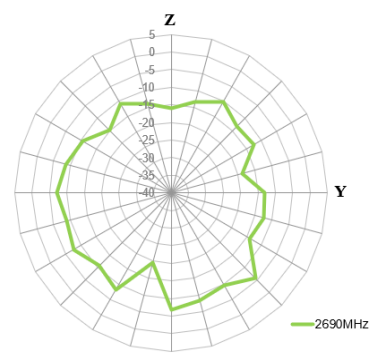
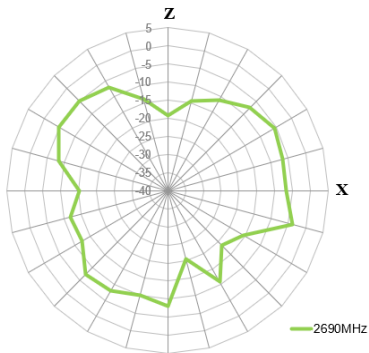
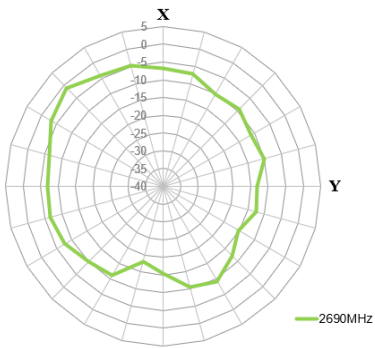

6. Radiation Patterns - GNSS

6.1 Test Setup

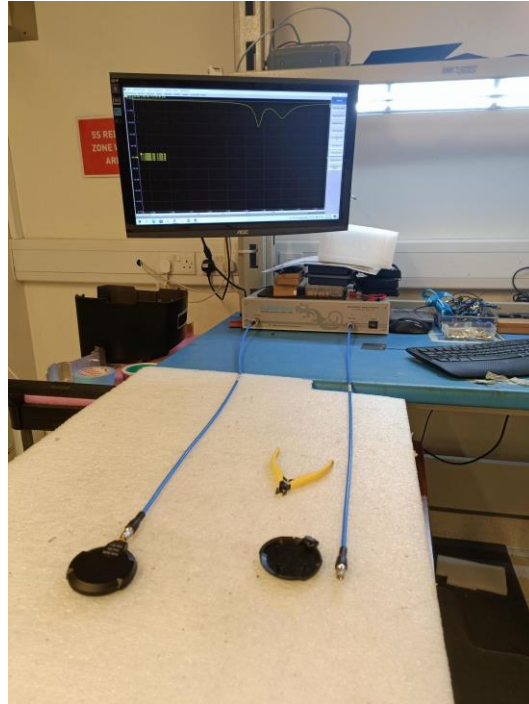

Free space

6.1 1575MHz – GNSS Freespace2D & 3D Radiation Patterns

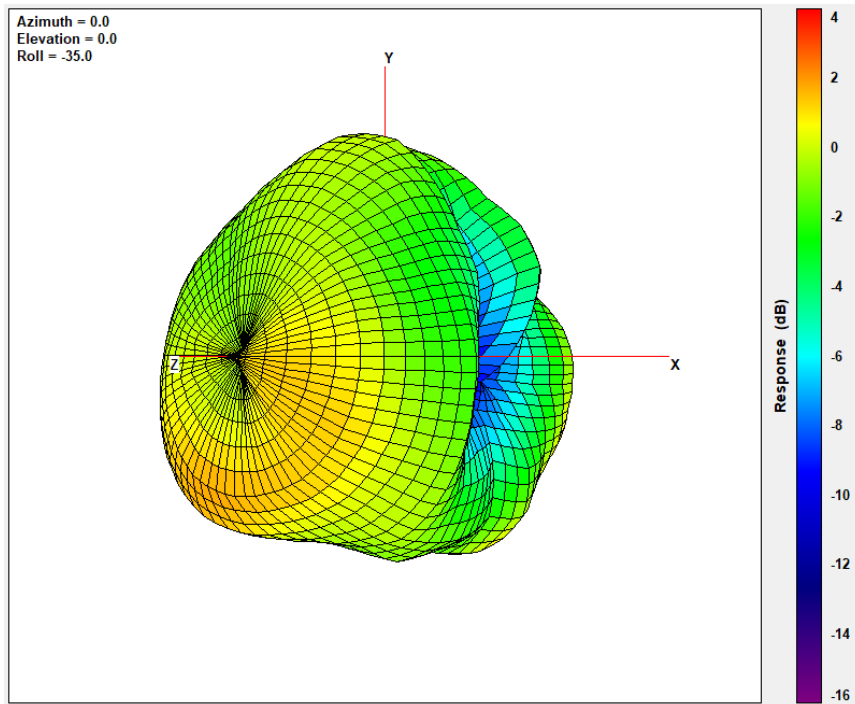

XY Plane

XZ Plane

YZ Plane

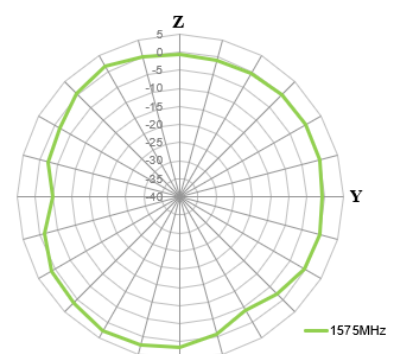
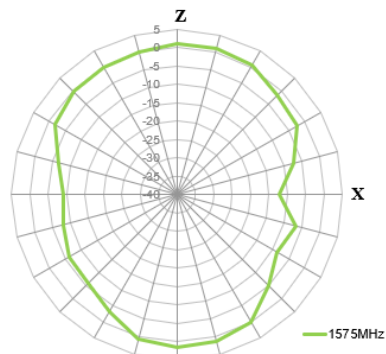
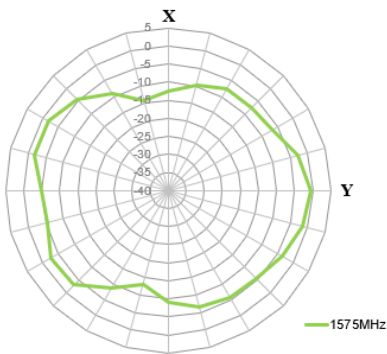

1602MHz

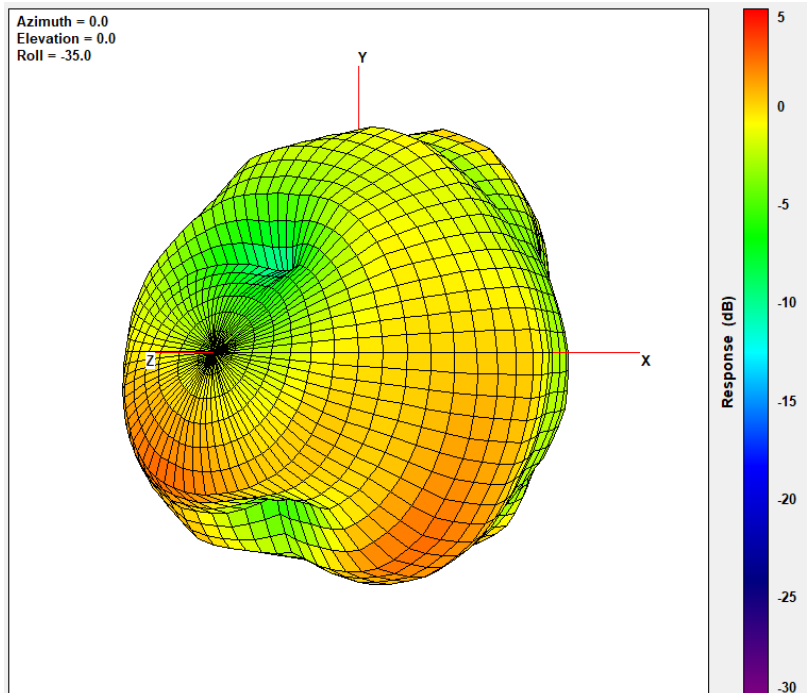

XY Plane

XZ Plane

YZ Plane

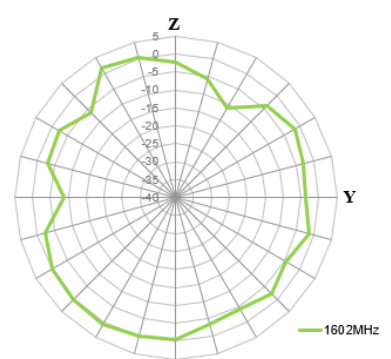
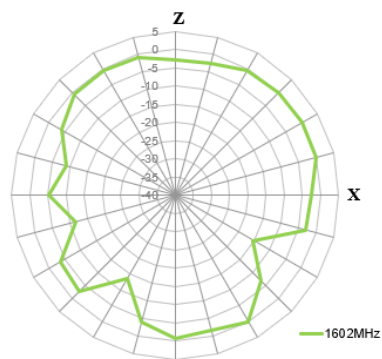
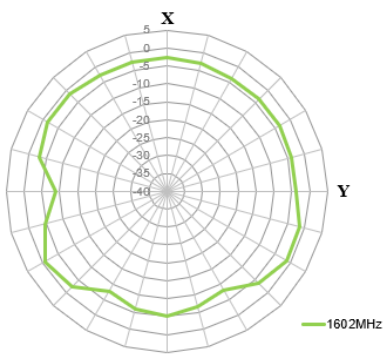

7. Mechanical Drawing (Units: mm)

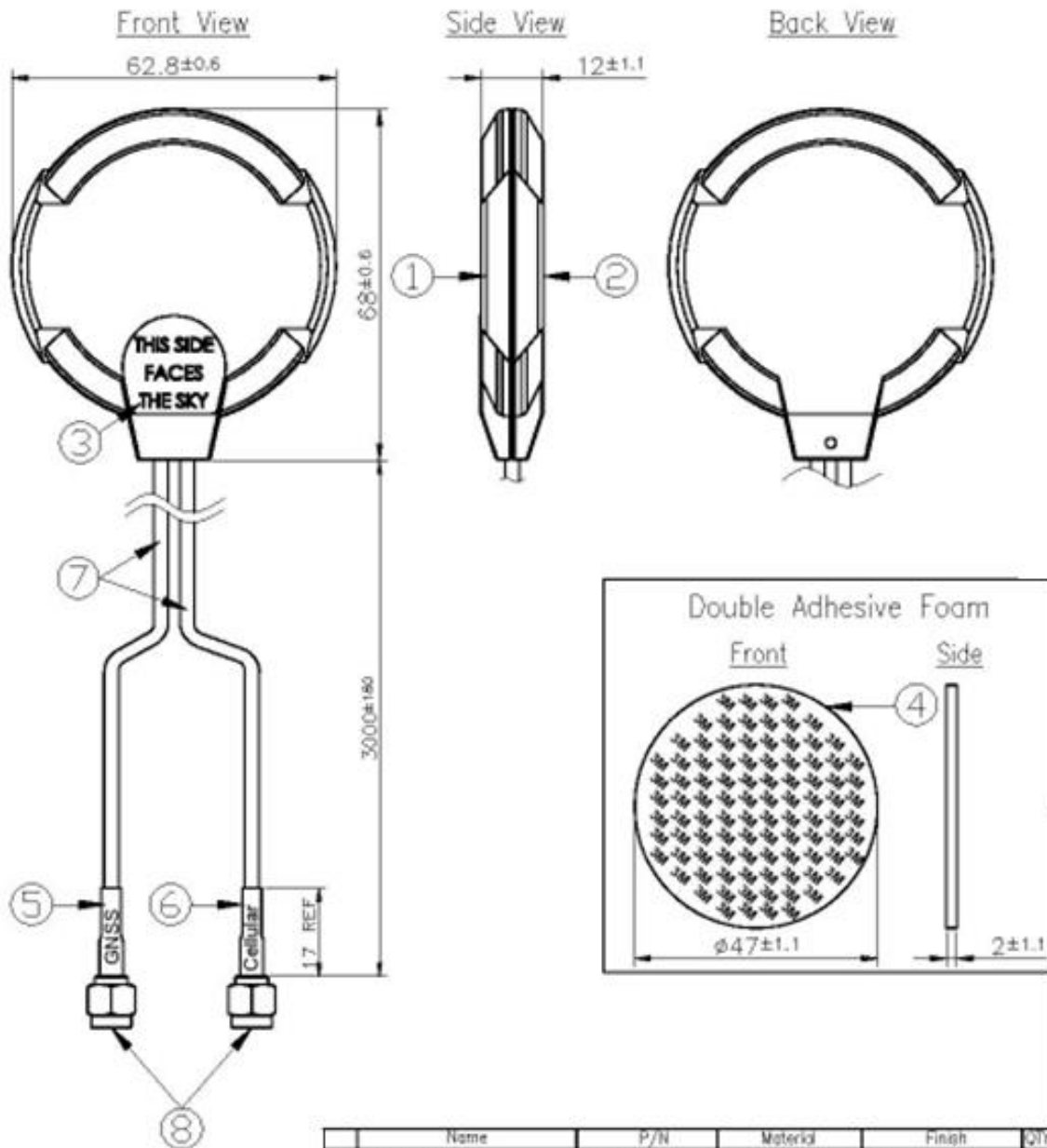

	Name	P/N	Material	Finish	QTY
1	Housing Top	000113ED00066A	PC+ABS	Black	1
2	Housing Bottom	000113ED10066A	PC+ABS	Black	1
3	Clear Label	001013ED00051A	PET	White	1
4	Double Adhesive Black Foam	001013ED00039A	3M 9448HK+CR4305	White Liner	1
5	Heat Shrink Tube (GNSS)	001316C000000A	PE	Blue Tube/White Text	1
6	Heat Shrink Tube (Cellular)	001316D100000A	PE	Blue Tube/White Text	1
7	RG174 Coaxial Cable	301315C000000A	PVC	Black	2
8	SMA/MIST	200216D000098A	Brass	Au Plated	2

Download Drawing

Download 3D Model

8. Packaging

1 pcs MA220.LB.001 per PE Bag
 Bag Dimensions - 600 x 450 mm
 Weight - 1200g

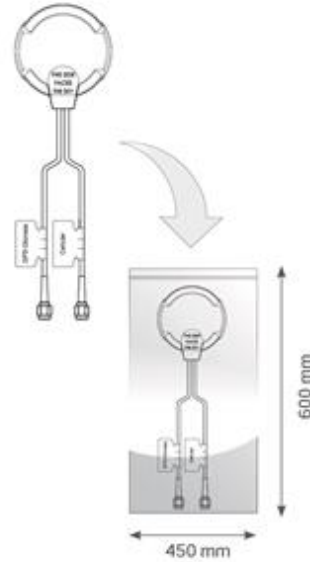

100 pcs MA220.LB.001 per carton
 Carton - 730 x 390 x 250mm
 Weight - 13.7Kg

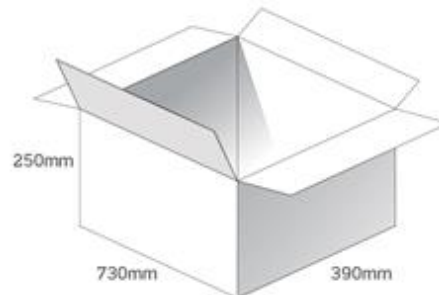

Pallet Dimensions 1200 x 1000 x 1450mm
 12 Cartons per Pallet
 4 Cartons per layer
 5 Layers

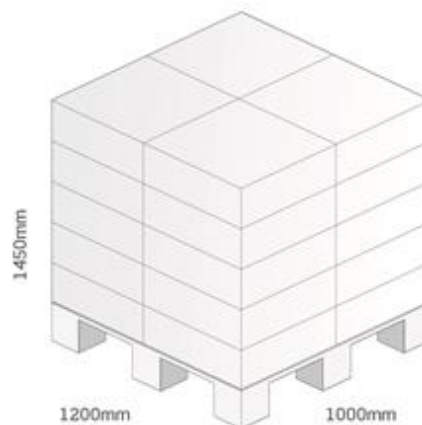

Changelog for the datasheet

SPE-14-8-016-G – MA220.LB.001

Revision: G (Current Version)

Date:	2022-07-28
Changes:	Full Datasheet update
Changes Made by:	Evan Murphy

Previous Revisions

Revision: F

Date:	2019-02-05
Changes:	
Changes Made by:	Jack Conroy

Revision: A (Original First Release)

Date:	2014-02-27
Notes:	
Author:	Technical Writer

Revision: E

Date:	2018-11-29
Changes:	
Changes Made by:	Technical Writer

Revision: D

Date:	2017-06-19
Changes:	
Changes Made by:	Technical Writer

Revision: C

Date:	2017-06-19
Changes:	
Changes Made by:	Technical Writer

Revision: B

Date:	2014-08-19
Changes:	
Changes Made by:	Technical Writer

Previous Revisions (Continued)



TAOGLAS®

www.taoglas.com

