

# RF Exposure Lab

802 N. Twin Oaks Valley Road, Suite 105 • San Marcos, CA 92069 • U.S.A.

TEL (760) 471-2100 • FAX (760) 471-2121

<http://www.rfexposurelab.com>

## CERTIFICATE OF COMPLIANCE SAR EVALUATION

Appareo Systems  
1830 NDSU Research Circle  
Fargo, ND 58102

Dates of Test: Apr. 14-15 & Sept. 27-Oct. 4, 2023  
Test Report Number: SAR.20231002

Lab Designation Number: US1195(FCC); US0194(ISED)

FCC ID:	2AETC-AEG21G
Contains FCC ID:	2AETC-AFC20 & 2AETC-ABG772AGL
IC Certificate:	12021A-AEG21G
Contains IC Certificate:	12021A-AFC20 & 12021A-ABG772AGL
HVIN/Model(s):	TCU-GLOBAL,V1
Brand Name:	Polaris
Test Sample:	Engineering Unit Same as Production
Serial Number:	042
Equipment Type:	Wireless Terminal Communication Unit
Classification:	Portable Transmitter Next to Body
TX Frequency Range:	699 – 716 MHz, 777 – 787 MHz, 814 – 849 MHz, 1710 – 1755 MHz, 1850 – 1915 MHz, 2496 – 2690 MHz, 2412 – 2462 MHz, 5150 MHz – 5350 MHz, 5500 – 5700 MHz, 5745 – 5825 MHz, 2402 – 2480 MHz
Frequency Tolerance:	± 2.5 ppm
Maximum RF Output:	750 MHz (LTE) – 25.7 dBm, 850 MHz (GPRS) – 35.0 dBm, 850 MHz (WCDMA) – 25.0 dBm, 850 MHz (LTE) – 25.7 dBm, 1750 MHz (WCDMA) – 25.0 dBm, 1750 MHz (LTE) – 25.7 dBm, 1900 MHz (GPRS) – 32.0 dBm, 1900 MHz (WCDMA) – 25.0 dBm, 1900 MHz (LTE) – 25.7 dBm, 2550 MHz (LTE) – 25.0 dBm, 2450 MHz (b) – 19.5 dBm, 2450 MHz (g) – 17.5 dBm, 2450 MHz (n) – 17.0 dBm, 5 GHz (a) – 15.0 dBm, 5 GHz (n) – 17.0 dBm, 5 GHz (ac) – 16.0 dBm, 2450 MHz (BT) – 6.8 dBm Conducted
Signal Modulation:	GMSK, WCDMA, QPSK, 16QAM, DSSS, OFDM
Antenna Type:	Internal
Application Type:	Certification
KDB Test Methodology:	KDB 447498 D01 v06, KDB 941225 D01 v03r01, D02 v02r01 & D05 v02r05
Industry Canada:	RSS-102 Issue 5, Safety Code 6
Max. Stand Alone SAR Value:	0.22 W/kg Reported
Max. Simultaneous SAR Value:	0.58 W/kg Reported
Separation Distance:	50 mm

This wireless mobile and/or portable device has been shown to be compliant for localized specific absorption rate (SAR) for uncontrolled environment/general exposure limits specified in ANSI/IEEE Std. C95.1-1992 and had been tested in accordance with the measurement procedures specified in IEEE 1528-2013 and IEC 62209-1528:2020 (See test report).

I attest to the accuracy of the data. All measurements were performed by myself or were made under my supervision and are correct to the best of my knowledge and belief. I assume full responsibility for the completeness of these measurements and vouch for the qualifications of all persons taking them.

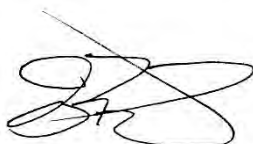

Jay M. Moulton  
Vice President



Testing Cert. # 2387.01

# Table of Contents

1. Introduction .....	4
SAR Definition [5] .....	5
2. SAR Measurement Setup .....	6
Robotic System .....	6
System Hardware .....	6
System Electronics .....	7
Probe Measurement System .....	7
3. Probe and Dipole Calibration .....	14
4. Phantom & Simulating Tissue Specifications .....	15
Head & Body Simulating Mixture Characterization .....	15
5. ANSI/IEEE C95.1 – 1992 RF Exposure Limits [2] .....	16
Uncontrolled Environment .....	16
Controlled Environment .....	16
6. Measurement Uncertainty .....	17
7. System Validation .....	18
Tissue Verification .....	18
Test System Verification .....	18
8. LTE Document Checklist .....	19
9. SAR Test Data Summary .....	24
Procedures Used To Establish Test Signal .....	24
Device Test Condition .....	24
GPRS Conducted Power .....	26
WCDMA Conducted Power .....	27
<TDD LTE SAR Measurement> .....	32
10. SAR Test Results .....	64
11. Simultaneous Transmission Analysis .....	68
12. Test Equipment List .....	69
13. Conclusion .....	70
14. References .....	71
Appendix A – System Validation Plots and Data .....	72
Appendix B – SAR Test Data Plots .....	88
Appendix C – SAR Test Setup Photos .....	107
Appendix D – Probe Calibration Data Sheets .....	111
Appendix E – Dipole Calibration Data Sheets .....	121
Appendix F – DAE Calibration Data Sheets .....	152
Appendix G – Phantom Calibration Data Sheets .....	163

Comment/Revision	Date
Original Release	October 12, 2023

**Note: The latest version supersedes all previous versions listed in the above table. The latest version shall be used.**

# 1. Introduction

This measurement report shows compliance of the Appareo Systems Model TCU-GLOBAL,V1 with FCC ID: 2AETC-AEG21G and contains 2AETC-AFC20 & 2AETC-ABG772AGL for mobile and portable devices and IC Certificate: 12021A-AEG21G and contains 12021A-AFC20 & 12021A-ABG772AGL with RSS102 Issue 5 & Safety Code 6. The FCC/ISED have adopted the guidelines for evaluating the environmental effects of radio frequency radiation to protect the public and workers from the potential hazards of RF emissions due to FCC/ISED regulated portable devices. [1], [6]

The test results recorded herein are based on a single type test of Appareo Model TCU-GLOBAL,V1 and therefore apply only to the tested sample.

The test procedures and limits, as described in ANSI C95.1 – 1999 Standard for Safety Levels with Respect to Human Exposure to Radio Frequency Electromagnetic Fields, 3 kHz to 300 GHz [2], ANSI C95.3 – 2002 Recommended Practice for the Measurement of Potentially Hazardous Electromagnetic Fields [3], IEEE Std.1528 – 2013 Recommended Practice [4], and Industry Canada Safety Code 6 Limits of Human Exposure to Radiofrequency Electromagnetic Fields in the Frequency Range from 3kHz to 300 GHz were employed.

The following table indicates all the wireless technologies operating in the TCU-GLOBAL,V1 Wireless Terminal Communication Unit. The table also shows the tolerance for the power level for each mode.

Module	Band	Technology	Class	3GPP Nominal Power dBm	Setpoint Nominal Power dBm	Tolerance dBm	Lower Tolerance dBm	Upper Tolerance dBm
Quectel EG21-G	Band 2	GPRS	N/A	30.0	30.0	± 2.0	28.0	32.0
	Band 5	GPRS	N/A	33.0	33.0	± 2.0	31.0	35.0
	Band 2	WCDMA	3	24.0	24.0	+1.0/-3.0	21.0	25.0
	Band 4	WCDMA	3	24.0	24.0	+1.0/-3.0	21.0	25.0
	Band 5	WCDMA	3	24.0	24.0	+1.0/-3.0	21.0	25.0
	Band 2	LTE-FDD	3	23.0	23.0	± 2.0	21.0	25.0
	Band 4	LTE-FDD	3	23.0	23.0	± 2.0	21.0	25.0
	Band 5	LTE-FDD	3	23.0	23.0	± 2.0	21.0	25.0
	Band 7	LTE-FDD	3	23.0	23.0	± 2.0	21.0	25.0
	Band 12	LTE-FDD	3	23.0	23.0	± 2.0	21.0	25.0
	Band 13	LTE-FDD	3	23.0	23.0	± 2.0	21.0	25.0
	Band 25	LTE-FDD	3	23.0	23.0	± 2.0	21.0	25.0
	Band 26	LTE-FDD	3	23.0	23.0	± 2.0	21.0	25.0
Quectel BG772	Band 2	LTE-FDD	3	N/A	N/A	N/A	N/A	25.7
	Band 4	LTE-FDD	3	N/A	N/A	N/A	N/A	25.7
	Band 5	LTE-FDD	3	N/A	N/A	N/A	N/A	25.7
	Band 12	LTE-FDD	3	N/A	N/A	N/A	N/A	25.7
	Band 13	LTE-FDD	3	N/A	N/A	N/A	N/A	25.7
	Band 25	LTE-FDD	3	N/A	N/A	N/A	N/A	25.7
	Band 26	LTE-FDD	3	N/A	N/A	N/A	N/A	25.7
	Band 27	LTE-FDD	3	N/A	N/A	N/A	N/A	25.7
Quectel FC20	2.4 GHz	802.11b	N/A	N/A	17.0	± 2.5	14.5	19.5
	2.4 GHz	802.11g	N/A	N/A	15.0	± 2.5	12.5	17.5
	2.4 GHz	802.11n	N/A	N/A	14.5	± 2.5	12.0	17.0
	2.4 GHz	802.11ac	N/A	N/A	13.5	± 2.5	11.0	16.0
	5 GHz	802.11a	N/A	N/A	12.5	± 2.5	10.0	15.0
	5 GHz	802.11n	N/A	N/A	14.5	± 2.5	12.0	17.0
	5 GHz	802.11ac	N/A	N/A	13.5	± 2.5	11.0	16.0
2.4 GHz	Bluetooth	N/A	N/A	5.8	± 1.0	4.8	6.8	

**SAR Definition [5]**

Specific Absorption Rate is defined as the time derivative (rate) of the incremental energy ( $dW$ ) absorbed by (dissipated in) an incremental mass ( $dm$ ) contained in a volume element ( $dV$ ) of a given density ( $\rho$ ).

$$SAR = \frac{d}{dt} \left( \frac{dW}{dm} \right) = \frac{d}{dt} \left( \frac{dW}{\rho dV} \right)$$

SAR is expressed in units of watts per kilogram (W/kg). SAR can be related to the electric field at a point by

$$SAR = \frac{\sigma |E|^2}{\rho}$$

where:

$\sigma$  = conductivity of the tissue (S/m)

$\rho$  = mass density of the tissue (kg/m<sup>3</sup>)

$E$  = rms electric field strength (V/m)

## 2. SAR Measurement Setup

### Robotic System

These measurements are performed using the DASY52 automated dosimetric assessment system. The DASY52 is made by Schmid & Partner Engineering AG (SPEAG) in Zurich, Switzerland and consists of high precision robotics system (Staubli), robot controller, Intel Core2 computer, near-field probe, probe alignment sensor, and the generic twin phantom containing the brain equivalent material. The robot is a six-axis industrial robot performing precise movements to position the probe to the location (points) of maximum electromagnetic field (EMF) (see Fig. 2.1).

### System Hardware

A cell controller system contains the power supply, robot controller teach pendant (Joystick), and a remote control used to drive the robot motors. The PC consists of the HP Intel Core2 computer with Windows XP system and SAR Measurement Software DASY52, A/D interface card, monitor, mouse, and keyboard. The Staubli Robot is connected to the cell controller to allow software manipulation of the robot. A data acquisition electronic (DAE) circuit that performs the signal amplification, signal multiplexing, AD-conversion, offset measurements, mechanical surface detection, collision detection, etc. is connected to the Electro-optical coupler (EOC). The EOC performs the conversion from the optical into digital electric signal of the DAE and transfers data to the PC plug-in card.

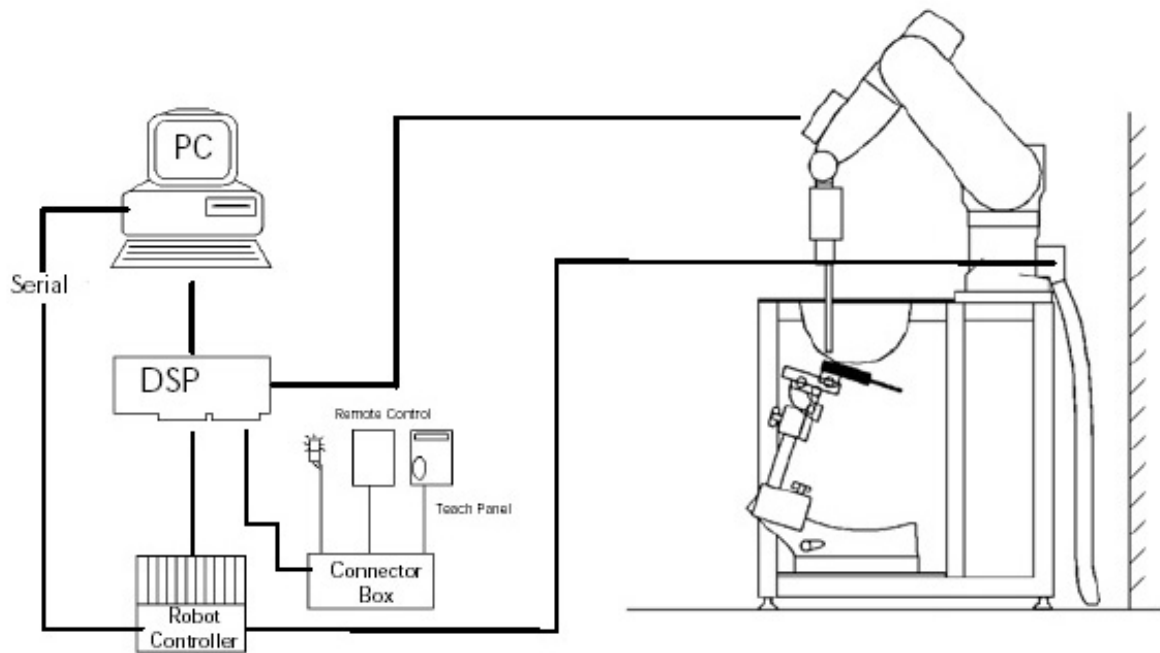

**Figure 2.1 SAR Measurement System Setup**

## System Electronics

The DAE4 consists of a highly sensitive electrometer-grade preamplifier with auto-zeroing, a channel and gain-switching multiplexer, a fast 16 bit AD-converter and a command decoder and control logic unit. Transmission to the PC-card is accomplished through an optical downlink for data and status information and an optical uplink for commands and clock lines. The mechanical probe mounting device includes two different sensor systems for frontal and sidewise probe contacts. They are also used for mechanical surface detection and probe collision detection. The robot uses its own controller with a built in VME-bus computer. The system is described in detail in.

## Probe Measurement System

The SAR measurements were conducted with the dosimetric probe EX3DV4, designed in the classical triangular configuration (see Fig. 2.2) and optimized for dosimetric evaluation. The probe is constructed using the thick film technique; with printed resistive lines on ceramic substrates. The probe is equipped with an optical multi fiber line ending at the front of the probe tip. (see Fig. 2.3) It is connected to the EOC box on the robot arm and provides an automatic detection of the phantom surface. Half of the fibers are connected to a pulsed infrared transmitter, the other half to a synchronized receiver. As the probe approaches the surface, the reflection from the surface produces a coupling from the transmitting to the receiving fibers. This reflection increases first during the approach, reaches maximum and then decreases. If the probe is flatly touching the surface, the coupling is zero. The distance of the coupling maximum to the surface is independent of the surface reflectivity and largely independent of the surface to probe angle. The DASY52 software reads the reflection during a software approach and looks for the maximum using a 2nd order fitting. The approach is stopped at reaching the maximum.



**DAE System**

## Probe Specifications

**Calibration:** In air from 10 MHz to 6.0 GHz  
In brain and muscle simulating tissue at Frequencies of 450 MHz, 835 MHz, 1750 MHz, 1900 MHz, 2450 MHz, 2600 MHz, 3500 MHz, 5200 MHz, 5300 MHz, 5600 MHz, 5800 MHz

**Frequency:** 10 MHz to 6 GHz

**Linearity:**  $\pm 0.2$ dB (30 MHz to 6 GHz)

**Dynamic:** 10 mW/kg to 100 W/kg

**Range:** Linearity:  $\pm 0.2$ dB

**Dimensions:** Overall length: 330 mm

**Tip length:** 20 mm

**Body diameter:** 12 mm

**Tip diameter:** 2.5 mm

**Distance from probe tip to sensor center:** 1 mm

**Application:** SAR Dosimetry Testing  
Compliance tests of wireless device

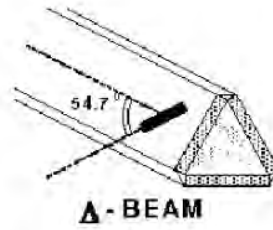

Figure 2.2 Triangular Probe Configurations



Figure 2.3 Probe Thick-Film Technique



**Probe Calibration Process**

**Dosimetric Assessment Procedure**

Each probe is calibrated according to a dosimetric assessment procedure described in with accuracy better than +/- 10%. The spherical isotropy was evaluated with the procedure described in and found to be better than +/-0.25dB. The sensitivity parameters (Norm X, Norm Y, Norm Z), the diode compression parameter (DCP) and the conversion factor (Conv F) of the probe is tested.

**Free Space Assessment**

The free space E-field from amplified probe outputs is determined in a test chamber. This is performed in a TEM cell for frequencies below 1 GHz, and in a waveguide above 1GHz for free space. For the free space calibration, the probe is placed in the volumetric center of the cavity at the proper orientation with the field. The probe is then rotated 360 degrees until the three channels show the maximum reading. The power density readings equates to 1 mW/cm<sup>2</sup>.

**Temperature Assessment \***

E-field temperature correlation calibration is performed in a flat phantom filled with the appropriate simulated brain tissue. The measured free space E-field in the medium, correlates to temperature rise in a dielectric medium. For temperature correlation calibration a RF transparent thermistor based temperature probe is used in conjunction with the E-field probe

$$SAR = C \frac{\Delta T}{\Delta t}$$

$$SAR = \frac{|E|^2 \cdot \sigma}{\rho}$$

where:

where:

$\Delta t$  = exposure time (30 seconds),

$\sigma$  = simulated tissue conductivity,

C = heat capacity of tissue (brain or muscle),

$\rho$  = Tissue density (1.25 g/cm<sup>3</sup> for brain tissue)

$\Delta T$  = temperature increase due to RF exposure.

SAR is proportional to  $\Delta T / \Delta t$ , the initial rate of tissue heating, before thermal diffusion takes place.

Now it's possible to quantify the electric field in the simulated tissue by equating the thermally derived SAR to the E- field;

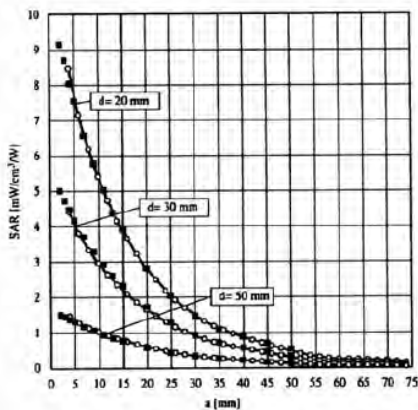

**Figure 2.4 E-Field and Temperature Measurements at 900MHz**

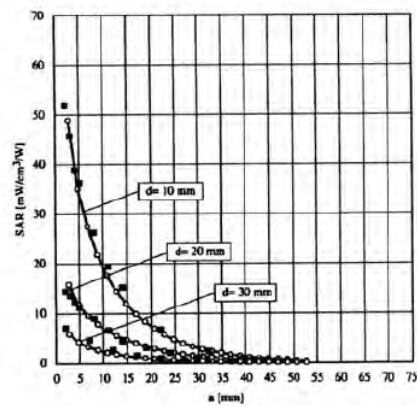

**Figure 2.5 E-Field and Temperature Measurements at 1800MHz**

## Data Extrapolation

The DASY52 software automatically executes the following procedures to calculate the field units from the microvolt readings at the probe connector. The first step of the evaluation is a linearization of the filtered input signal to account for the compression characteristics of the detector diode. The compensation depends on the input signal, the diode type and the DC-transmission factor from the diode to the evaluation electronics. If the exciting field is pulsed, the crest factor of the signal must be known to correctly compensate for peak power. The formula for each channel can be given like below;

$$V_i = U_i + U_i^2 \cdot \frac{cf}{dcp_i}$$

with  $V_i$  = compensated signal of channel i (i=x,y,z)  
 $U_i$  = input signal of channel i (i=x,y,z)  
 $cf$  = crest factor of exciting field (DASY parameter)  
 $dcp_i$  = diode compression point (DASY parameter)

From the compensated input signals the primary field data for each channel can be evaluated:

E-field probes:

$$E_i = \sqrt{\frac{V_i}{Norm_i \cdot ConvF}}$$

with  $V_i$  = compensated signal of channel i (i = x,y,z)  
 $Norm_i$  = sensor sensitivity of channel i (i = x,y,z)  
 $\mu V/(V/m)^2$  for E-field probes  
 $ConvF$  = sensitivity of enhancement in solution  
 $E_i$  = electric field strength of channel i in V/m

The RSS value of the field components gives the total field strength (Hermetian magnitude):

$$E_{tot} = \sqrt{E_x^2 + E_y^2 + E_z^2}$$

The primary field data are used to calculate the derived field units.

$$SAR = E_{tot}^2 \cdot \frac{\sigma}{\rho \cdot 1000}$$

with  $SAR$  = local specific absorption rate in W/g  
 $E_{tot}$  = total field strength in V/m  
 $\sigma$  = conductivity in [mho/m] or [Siemens/m]  
 $\rho$  = equivalent tissue density in g/cm<sup>3</sup>

The power flow density is calculated assuming the excitation field to be a free space field.

$$P_{free} = \frac{E_{tot}^2}{3770}$$

with  $P_{pwe}$  = equivalent power density of a plane wave in W/cm<sup>2</sup>  
 $E_{tot}$  = total electric field strength in V/m

**Scanning procedure**

- The DASy installation includes predefined files with recommended procedures for measurements and system check. They are read-only document files and destined as fully defined but unmeasured masks. All test positions (head or body-worn) are tested with the same configuration of test steps differing only in the grid definition for the different test positions.
- The „reference“ and „drift“ measurements are located at the beginning and end of the batch process. They measure the field drift at one single point in the liquid over the complete procedure. The indicated drift is mainly the variation of the DUT’s output power and should vary max. +/- 5 %.
- The highest integrated SAR value is the main concern in compliance test applications. These values can mostly be found at the inner surface of the phantom and cannot be measured directly due to the sensor offset in the probe. To extrapolate the surface values, the measurement distances to the surface must be known accurately. A distance error of 0.5mm could produce SAR errors of 6% at 1800 MHz. Using predefined locations for measurements is not accurate enough. Any shift of the phantom (e.g., slight deformations after filling it with liquid) would produce high uncertainties. For an automatic and accurate detection of the phantom surface, the DASy5 system uses the mechanical surface detection. The detection is always at touch, but the probe will move backward from the surface the indicated distance before starting the measurement.
- The „area scan“ measures the SAR above the DUT or verification dipole on a parallel plane to the surface. It is used to locate the approximate location of the peak SAR with 2D spline interpolation. The robot performs a stepped movement along one grid axis while the local electrical field strength is measured by the probe. The probe is touching the surface of the SAM during acquisition of measurement values. The scan uses different grid spacings for different frequency measurements. Standard grid spacing for head measurements in frequency ranges ≤ 2GHz is 15 mm in x - and y- dimension. For higher frequencies a finer resolution is needed, thus for the grid spacing is reduced according the following table:

<b>Area scan grid spacing for different frequency ranges</b>	
Frequency range	Grid spacing
≤ 2 GHz	≤ 15 mm
2 – 4 GHz	≤ 12 mm
4 – 6 GHz	≤ 10 mm

Grid spacing and orientation have no influence on the SAR result. For special applications where the standard scan method does not find the peak SAR within the grid, e.g. mobile phones with flip cover, the grid can be adapted in orientation. Results of this coarse scan are shown in annex B.

- A „zoom scan“ measures the field in a volume around the 2D peak SAR value acquired in the previous „coarse“ scan. It uses a fine meshed grid where the robot moves the probe in steps along all the 3 axis (x,y and z-axis) starting at the bottom of the Phantom. The grid spacing for the cube measurement is varied according to the measured frequency range, the dimensions are given in the following table:

<b>Zoom scan grid spacing and volume for different frequency ranges</b>			
Frequency range	Grid spacing for x, y axis	Grid spacing for z axis	Minimum zoom scan volume
≤ 2 GHz	≤ 8 mm	≤ 5 mm	≥ 30 mm
2 – 3 GHz	≤ 5 mm	≤ 5 mm	≥ 28 mm
3 – 4 GHz	≤ 5 mm	≤ 4 mm	≥ 28 mm
4 – 5 GHz	≤ 4 mm	≤ 3 mm	≥ 25 mm
5 – 6 GHz	≤ 4 mm	≤ 2 mm	≥ 22 mm

DASy is also able to perform repeated zoom scans if more than 1 peak is found during area scan. In this document, the evaluated peak 1g and 10g averaged SAR values are shown in the 2D-graphics in annex B. Test results relevant for the specified standard (see section 3) are shown in table form in section 7.

## Spatial Peak SAR Evaluation

The spatial peak SAR - value for 1 and 10 g is evaluated after the Cube measurements have been done. The basis of the evaluation are the SAR values measured at the points of the fine cube grid consisting of all points in the three directions x, y and z. The algorithm that finds the maximal averaged volume is separated into three different stages.

- The data between the dipole center of the probe and the surface of the phantom are extrapolated. This data cannot be measured since the center of the dipole is 1 to 2.7 mm away from the tip of the probe and the distance between the surface and the lowest measuring point is about 1 mm (see probe calibration sheet). The extrapolated data from a cube measurement can be visualized by selecting 'Graph Evaluated'.
- The maximum interpolated value is searched with a straight-forward algorithm. Around this maximum the SAR - values averaged over the spatial volumes (1g or 10 g) are computed using the 3d-spline interpolation algorithm. If the volume cannot be evaluated (i.e., if a part of the grid was cut off by the boundary of the measurement area) the evaluation will be started on the corners of the bottom plane of the cube.
- All neighbouring volumes are evaluated until no neighbouring volume with a higher average value is found.

## Extrapolation

The extrapolation is based on a least square algorithm [W. Gander, Computermathematik, p.168-180]. Through the points in the first 3 cm along the z-axis, polynomials of order four are calculated. These polynomials are then used to evaluate the points between the surface and the probe tip. The points, calculated from the surface, have a distance of 1 mm from each other.

## Interpolation

The interpolation of the points is done with a 3d-Spline. The 3d-Spline is composed of three one-dimensional splines with the "Not a knot"-condition [W. Gander, Computermathematik, p.141-150] (x, y and z -direction) [Numerical Recipes in C, Second Edition, p.123ff ].

## Volume Averaging

At First the size of the cube is calculated. Then the volume is integrated with the trapezoidal algorithm. 8000 points (20x20x20) are interpolated to calculate the average.

## Advanced Extrapolation

DASY uses the advanced extrapolation option which is able to compensate boundary effects on E-field probes.

**SAM PHANTOM**

The SAM Twin Phantom V4.0 is constructed of a fiberglass shell integrated in a wooden table. The shape of the shell is based on data from an anatomical study designed to determine the maximum exposure in at least 90% of all users. It enables the dosimetric evaluation of left and right hand phone usage as well as body mounted usage at the flat phantom region. A cover prevents the evaporation of the liquid. Reference markings on the Phantom allow the complete setup of all predefined phantom positions and measurement grids by manually teaching three points in the robot. (see Fig. 2.6)

**Phantom Specification**

**Phantom:** SAM Twin Phantom (V4.0)  
**Shell Material:** Vivac Composite  
**Thickness:**  $2.0 \pm 0.2$  mm

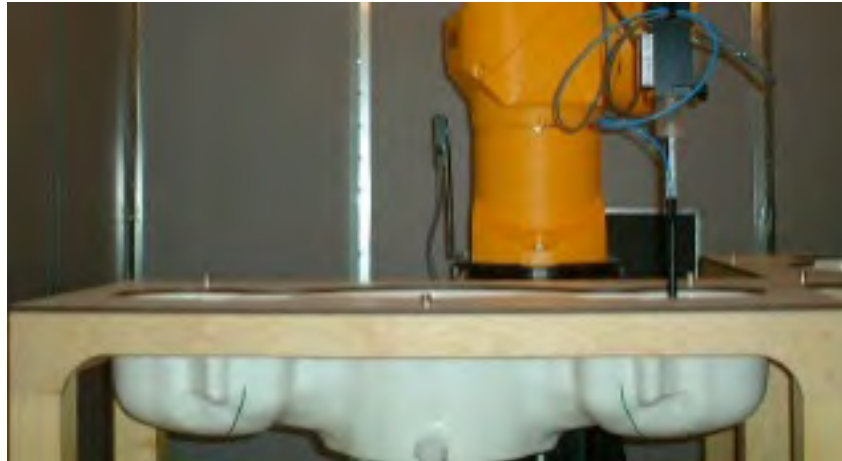

**Figure 2.6 SAM Twin Phantom**

**Device Holder for Transmitters**

In combination with the SAM Twin Phantom V4.0 the Mounting Device (see Fig. 2.7), enables the rotation of the mounted transmitter in spherical coordinates whereby the rotation point is the ear opening. The devices can be easily, accurately, and repeat ably be positioned according to the FCC, CENELEC, IEC and IEEE specifications. The device holder can be locked at different phantom locations (left head, right head, flat phantom).



**Figure 2.7 Mounting Device**

Note: A simulating human hand is not used due to the complex anatomical and geometrical structure of the hand that may produce infinite number of configurations. To produce the worst-case condition (the hand absorbs antenna output power), the hand is omitted during the tests.

### **3. Probe and Dipole Calibration**

See Appendix D and E.

## 4. Phantom & Simulating Tissue Specifications

### Head & Body Simulating Mixture Characterization

The head mixture consists of the material based on the table listed below. The mixture is calibrated to obtain proper dielectric constant (permittivity) and conductivity of the desired tissue.

**Table 4.1 Typical Composition of Ingredients for Tissue**

Ingredients		Simulating Tissue				
		750 MHz Head	900 MHz Head	1750 MHz Head	1900 MHz Head	2550 MHz Head
Mixing Percentage						
Water		Proprietary Purchased From Speag				
Sugar						
Salt						
HEC						
Bactericide						
DGBE						
Dielectric Constant	Target	41.94	41.50	40.08	40.00	39.08
Conductivity (S/m)	Target	0.89	0.97	1.37	1.40	1.91

## 5. ANSI/IEEE C95.1 – 1992 RF Exposure Limits [2]

### Uncontrolled Environment

Uncontrolled Environments are defined as locations where there is the exposure of individuals who have no knowledge or control of their exposure. The general population/uncontrolled exposure limits are applicable to situations in which the general public may be exposed or in which persons who are exposed as a consequence of their employment may not be made fully aware of the potential for exposure or cannot exercise control over their exposure. Members of the general public would come under this category when exposure is not employment-related; for example, in the case of a wireless transmitter that exposes persons in its vicinity.

### Controlled Environment

Controlled Environments are defined as locations where there is exposure that may be incurred by persons who are aware of the potential for exposure, (i.e. as a result of employment or occupation). In general, occupational/controlled exposure limits are applicable to situations in which persons are exposed as a consequence of their employment, who have been made fully aware of the potential for exposure and can exercise control over their exposure. This exposure category is also applicable when the exposure is of a transient nature due to incidental passage through a location where the exposure levels may be higher than the general population/uncontrolled limits, but the exposed person is fully aware of the potential for exposure and can exercise control over his or her exposure by leaving the area or by some other appropriate means.

**Table 5.1 Human Exposure Limits**

	UNCONTROLLED ENVIRONMENT General Population (W/kg) or (mW/g)	CONTROLLED ENVIROMENT Professional Population (W/kg) or (mW/g)
SPATIAL PEAK SAR <sup>1</sup> Head	1.60	8.00
SPATIAL AVERAGE SAR <sup>2</sup> Whole Body	0.08	0.40
SPATIAL PEAK SAR <sup>3</sup> Hands, Feet, Ankles, Wrists	4.00	20.00

<sup>1</sup> The Spatial Peak value of the SAR averaged over any 1 gram of tissue (defined as a tissue volume in the shape of a cube) and over the appropriate averaging time.

<sup>2</sup> The Spatial Average value of the SAR averaged over the whole body.

<sup>3</sup> The Spatial Peak value of the SAR averaged over any 10 grams of tissue (defined as a tissue volume in the shape of a cube) and over the appropriate averaging time.



## 6. Measurement Uncertainty

Measurement uncertainty table is not required per KDB 865664 D01 v01 section 2.8.2 page 12. SAR measurement uncertainty analysis is required in the SAR report only when the highest measured SAR in a frequency band is  $\geq 1.5$  W/kg for 1-g SAR. The equivalent ratio (1.5/1.6) should be applied to extremity and occupational exposure conditions. The highest reported value is less than 1.5 W/kg. Therefore, the measurement uncertainty table is not required.

## 7. System Validation

### Tissue Verification

**Table 7.1 Measured Tissue Parameters**

		750 MHz Head		900 MHz Head		1750 MHz Head	
Date(s)		Apr. 14, 2023		Apr. 14, 2023		Apr. 15, 2023	
Liquid Temperature (°C)	20.0	Target	Measured	Target	Measured	Target	Measured
Dielectric Constant: $\epsilon$		41.94	41.46	41.50	41.34	40.08	39.24
Conductivity: $\sigma$		0.89	0.90	0.97	0.98	1.37	1.40
		1900 MHz Head		2550 MHz Head			
Date(s)		Apr. 15, 2023					
Liquid Temperature (°C)	20.0	Target	Measured				
Dielectric Constant: $\epsilon$		40.00	39.87				
Conductivity: $\sigma$		1.40	1.39				

		750 MHz Head		900 MHz Head		1750 MHz Head	
Date(s)		Sep. 27, 2023		Oct. 2, 2023		Sep. 27, 2023	
Liquid Temperature (°C)	20.0	Target	Measured	Target	Measured	Target	Measured
Dielectric Constant: $\epsilon$		41.94	40.89	41.50	40.86	40.08	39.39
Conductivity: $\sigma$		0.89	0.92	0.97	1.00	1.37	1.39
		1900 MHz Head		2550 MHz Head			
Date(s)		Sep. 28, 2023		Oct. 4, 2023			
Liquid Temperature (°C)	20.0	Target	Measured	Target	Measured		
Dielectric Constant: $\epsilon$		40.00	39.65	39.08	38.69		
Conductivity: $\sigma$		1.40	1.42	1.91	1.93		

See Appendix A for data printout.

### Test System Verification

Prior to assessment, the system is verified to the  $\pm 10\%$  of the specifications at the test frequency by using the system kit. Power is normalized to 1 watt. (Graphic Plots Attached)

**Table 7.2 System Dipole Validation Target & Measured**

	Test Frequency	Targeted SAR <sub>1g</sub> (W/kg)	Measure SAR <sub>1g</sub> (W/kg)	Tissue Used for Verification	Deviation (%)	Plot Number
14-Apr-2023	750 MHz	8.57	8.58	Head	+ 0.12	1
14-Apr-2023	900 MHz	11.20	11.50	Head	+ 2.68	2
15-Apr-2023	1750 MHz	37.70	37.80	Head	+ 0.27	3
15-Apr-2023	1900 MHz	40.40	41.50	Head	+ 2.72	4
27-Sep-2023	750 MHz	8.57	8.56	Head	- 0.12	5
02-Oct-2023	900 MHz	11.20	11.70	Head	+ 4.46	6
27-Sep-2023	1750 MHz	37.70	37.70	Head	+ 0.00	7
28-Sep-2023	1900 MHz	40.40	41.70	Head	+ 3.22	8
04-Oct-2023	2550 MHz	55.30	56.60	Head	+ 2.35	9

See Appendix A for data plots.

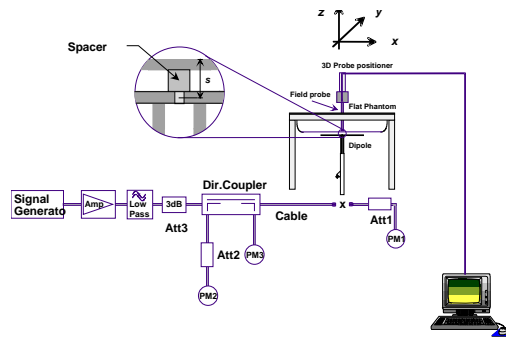

**Figure 7.1 Dipole Validation Test Setup**

## 8. LTE Document Checklist

- 1) Identify the operating frequency range of each LTE transmission band used by the device

LTE Operating Band	Uplink (transmit)	Downlink (Receive)	Duplex mode (FDD/TDD)
	Low - high	Low - high	
2	1850-1910	1930-1990	FDD
4	1710-1755	2110-2155	FDD
5	824-849	869-894	FDD
7	2500-2570	2620-2690	FDD
12	699-716	729-746	FDD
13	777-787	746-756	FDD
25	1850-1915	1930-1995	FDD
26	814-849	859-894	FDD
27	807-824	852-869	FDD
66	1710-1780	2110-2200	FDD
38	2570-2620	2570-2620	TDD
41	2496-2690	2496-2690	TDD

- 2) Identify the channel bandwidths used in each frequency band; 1.4, 3, 5, 10, 15, 20 MHz etc

### Module EG21-G

LTE Band Class	Bandwidth (MHz)	Frequency or Freq. Band (MHz)
2	1.4, 3, 5, 10, 15, 20	1850-1910 MHz
4	1.4, 3, 5, 10, 15, 20	1710-1755 MHz
5	1.4, 3, 5, 10	824-849 MHz
7	5, 10, 15, 20	2500-2570 MHz
12	1.4, 3, 5, 10	699-716 MHz
13	5, 10	777-787 MHz
25	1.4, 3, 5, 10, 15, 20	1850-1915 MHz
26	1.4, 3, 5, 10, 15	814-849 MHz
38	5, 10, 15, 20	2570-2620 MHz
41	5, 10, 15, 20	2496-2690 MHz

### Module BG772A

LTE Band Class	Bandwidth (MHz)	Frequency or Freq. Band (MHz)
2	1.4	1850-1910 MHz
4	1.4	1710-1755 MHz
5	1.4	824-849 MHz
12	1.4	699-716 MHz
13	1.4	777-787 MHz
25	1.4	1850-1915 MHz
26	1.4	814-849 MHz
27	1.4	807-824 MHz
66	1.4	1710-1780 MHz

3) Identify the high, middle and low (H, M, L) channel numbers and frequencies in each LTE frequency band

Module EG21-G

LTE Band Class	Bandwidth (MHz)	Frequency (MHz)/Channel #					
		Low		Mid		High	
2	1.4	1850.7	18607	1880.0	18900	1909.3	19193
2	3	1851.5	18615	1880.0	18900	1908.5	19185
2	5	1852.5	18625	1880.0	18900	1907.5	19175
2	10	1855.0	18650	1880.0	18900	1905.0	19150
2	15	1857.5	18675	1880.0	18900	1902.5	19125
2	20	1860.0	18700	1880.0	18900	1900.0	19100
4	1.4	1710.7	19957	1732.5	20175	1754.3	20393
4	3	1711.5	19965	1732.5	20175	1753.5	20385
4	5	1712.5	19975	1732.5	20175	1752.5	20375
4	10	1715.0	20000	1732.5	20175	1750.0	20350
4	15	1717.5	20025	1732.5	20175	1747.5	20325
4	20	1720.0	20050	1732.5	20175	1745.0	20300
5	1.4	824.7	20407	836.5	20525	848.3	20643
5	3	825.5	20415	836.5	20525	847.5	20635
5	5	826.5	20425	836.5	20525	846.5	20625
5	10	829.0	20450	836.5	20525	844.0	20600
7	5	2502.5	20775	2535.0	21100	2567.5	21425
7	10	2505.0	20800	2535.0	21100	2565.0	21400
7	15	2507.5	20825	2535.0	21100	2562.5	21375
7	20	2510.0	20850	2535.0	21100	2560.0	21350
12	1.4	699.7	23017	707.5	23095	715.3	23173
12	3	700.5	23025	707.5	23095	714.5	23165
12	5	701.5	23035	707.5	23095	713.5	23155
12	10	704.0	23060	707.5	23095	711.0	23130
13	5	779.5	23205	782.0	23230	784.5	23225
13	10	-----	-----	782.0	23230	-----	-----
25	1.4	1850.7	26047	1882.5	26365	1914.3	26683
25	3	1851.5	26055	1882.5	26365	1913.5	26675
25	5	1852.5	26065	1882.5	26365	1912.5	26665
25	10	1855.0	26090	1882.5	26365	1910.0	26640
25	15	1857.5	26115	1882.5	26365	1907.5	26615
25	20	1860.0	26140	1882.5	26365	1905.0	26590
26	1.4	814.7	26697	831.5	26865	848.3	27033
26	3	815.5	26705	831.5	26865	847.5	27025
26	5	816.5	26715	831.5	26865	846.5	27015
26	10	819.0	26740	831.5	26865	844.0	26990
26	15	821.5	26765	831.5	26865	841.5	26995
38	5	2572.5	37775	2595.0	38000	2602.5	38075
38	10	2575.0	37800	2595.0	38000	2605.0	38100
38	15	2577.5	37825	2595.0	38000	2607.5	38125
38	20	2580.0	37850	2595.0	38000	2610.0	38150
41	5	2498.5	39675	2593	40620	2687.5	41565
41	10	2501.0	39700	2593	40620	2685.0	41540
41	15	2503.5	39725	2593	40620	2682.5	41515
41	20	2506.0	39750	2593	40620	2680.0	41490

Module BG772A

LTE Band Class	Bandwidth (MHz)	Frequency (MHz)/Channel #					
		Low		Mid		High	
2	1.4	1850.7	18607	1880.0	18900	1909.3	19193
4	1.4	1710.7	19957	1732.5	20175	1754.3	20393
5	1.4	824.7	20407	836.5	20525	848.3	20643
12	1.4	699.7	23017	707.5	23095	715.3	23173
13	1.7	777.7	23187	782.0	23230	786.3	23273
25	1.4	1850.7	26047	1882.5	26365	1914.3	26683
26	1.4	814.7	26697	831.5	26865	848.3	27033
27	1.4	807.7	27047	815.5	27125	823.3	27203
66	1.4	1710.7	131979	1755.0	132422	1779.3	132665

- 4) Specify the UE category and uplink modulations used:
- UE Category: 3
  - Uplink modulations: QPSK and 16QAM
- 5) Include descriptions of the LTE transmitter and antenna implementation; and also identify whether it is a standalone transmitter operating independently of other wireless transmitters in the device or sharing hardware components and/or antenna(s) with other transmitters etc

The device has 3 antennas:

- 1 – WWAN (Transmit and Receive) Antenna
- 1 – WWAN (Receive Only) Antenna
- 1 – WiFi (Transmit and Receive) Antenna

- 6) Identify the LTE voice/data requirements in each operating mode and exposure condition with respect to head and body test configurations, antenna locations, handset flip-cover or slide positions, antenna diversity conditions etc

The device is a data only. Data mode was tested in each operating mode and exposure condition in the body configuration. See test setup photos to see all configurations tested.

- 7) Identify if Maximum Power Reduction (MPR) is optional or mandatory, i.e. built-in by design:
- a) Only mandatory MPR may be considered during SAR testing, when the maximum output power is permanently limited by the MPR implemented within the UE; and only for the applicable RB (resource block) configurations specified in LTE standards

MPR is mandatory, built-in by design on all production units. It was enabled during testing.

Modulation	Channel Bandwidth/transmission Bandwidth Configuration (RB)						MPR (dB)
	1.4 MHz	3.0 MHz	5 MHz	10 MHz	15 MHz	20 MHz	
QPSK	> 5	> 4	> 8	> 12	> 16	> 18	≤ 1
16QAM	≤ 5	≤ 4	≤ 8	≤ 12	≤ 16	≤ 18	≤ 1
16QAM	> 5	> 4	> 8	> 12	> 16	> 18	≤ 2

- b) A-MPR (additional MPR) must be disabled
- c) A-MPR was disabled during testing.

- 8) Include the maximum average conducted output power measured on the required test channels for each channel bandwidth and UL modulation used in each frequency band:

The maximum average conducted output power measured for the testing is listed on pages 34-63 of this report. The below table shows the factory set point with the allowable tolerance.

Module	Band	Technology	Class	3GPP Nominal Power dBm	Setpoint Nominal Power dBm	Tolerance dBm	Lower Tolerance dBm	Upper Tolerance dBm
Quectel EG21-G	Band 2	LTE-FDD	3	23.0	23.0	± 2.0	21.0	25.0
	Band 4	LTE-FDD	3	23.0	23.0	± 2.0	21.0	25.0
	Band 5	LTE-FDD	3	23.0	23.0	± 2.0	21.0	25.0
	Band 7	LTE-FDD	3	23.0	23.0	± 2.0	21.0	25.0
	Band 12	LTE-FDD	3	23.0	23.0	± 2.0	21.0	25.0
	Band 13	LTE-FDD	3	23.0	23.0	± 2.0	21.0	25.0
	Band 25	LTE-FDD	3	23.0	23.0	± 2.0	21.0	25.0
	Band 26	LTE-FDD	3	23.0	23.0	± 2.0	21.0	25.0
	Band 38	LTE-TDD	3	23.0	23.0	± 2.0	21.0	25.0
Band 41	LTE-TDD	3	23.0	23.0	± 2.0	21.0	25.0	
Quectel BG772	Band 2	LTE-FDD	3	N/A	N/A	N/A	N/A	25.7
	Band 4	LTE-FDD	3	N/A	N/A	N/A	N/A	25.7
	Band 5	LTE-FDD	3	N/A	N/A	N/A	N/A	25.7
	Band 12	LTE-FDD	3	N/A	N/A	N/A	N/A	25.7
	Band 13	LTE-FDD	3	N/A	N/A	N/A	N/A	25.7
	Band 25	LTE-FDD	3	N/A	N/A	N/A	N/A	25.7
	Band 26	LTE-FDD	3	N/A	N/A	N/A	N/A	25.7
	Band 27	LTE-FDD	3	N/A	N/A	N/A	N/A	25.7
Band 66	LTE-FDD	3	N/A	N/A	N/A	N/A	25.7	

- 9) Identify all other U.S. wireless operating modes (3G, Wi-Fi, WiMax, Bluetooth etc), device/exposure configurations (head and body, antenna and handset flip-cover or slide positions, antenna diversity conditions etc.) and frequency bands used for these modes

Other wireless modes:

Module	Band	Technology	Class	3GPP Nominal Power dBm	Setpoint Nominal Power dBm	Tolerance dBm	Lower Tolerance dBm	Upper Tolerance dBm
Quectel EG21-G	Band 2	GPRS	N/A	30.0	30.0	± 2.0	28.0	32.0
	Band 5	GPRS	N/A	33.0	33.0	± 2.0	31.0	35.0
	Band 2	WCDMA	3	24.0	24.0	+1.0/-3.0	21.0	25.0
	Band 4	WCDMA	3	24.0	24.0	+1.0/-3.0	21.0	25.0
	Band 5	WCDMA	3	24.0	24.0	+1.0/-3.0	21.0	25.0
Quectel FC20	2.4 GHz	802.11b	N/A	N/A	17.0	± 2.5	14.5	19.5
	2.4 GHz	802.11g	N/A	N/A	15.0	± 2.5	12.5	17.5
	2.4 GHz	802.11n	N/A	N/A	14.5	± 2.5	12.0	17.0
	2.4 GHz	802.11ac	N/A	N/A	13.5	± 2.5	11.0	16.0
	5 GHz	802.11a	N/A	N/A	12.5	± 2.5	10.0	15.0
	5 GHz	802.11n	N/A	N/A	14.5	± 2.5	12.0	17.0
	5 GHz	802.11ac	N/A	N/A	13.5	± 2.5	11.0	16.0
2.4 GHz	Bluetooth	N/A	N/A	N/A	5.8	± 1.0	4.8	6.8

- 10) Include the maximum average conducted output power measured for the other wireless modes and frequency bands.

The WiFi bands were excluded from SAR testing. Therefore, no conducted power measurements were performed. The GPRS and WCDMA measurements are on pages 26 & 30. The table in item 9 shows the factory set point with the allowable tolerance.

- 11) When power reduction is applied to certain wireless modes to satisfy SAR compliance for simultaneous transmission conditions, other equipment certification or operating requirements, include the maximum average conducted output power measured in each power reduction mode applicable to the simultaneous voice/data transmission configurations for such wireless configurations and frequency bands; and also include details of the power reduction implementation and measurement setup

Power reduction is not required to satisfy SAR compliance.

- 12) Include descriptions of the test equipment, test software, built-in test firmware etc. required to support testing the device when power reduction is applied to one or more transmitters/antennas for simultaneous voice/data transmission

Not applicable.

- 13) When appropriate, include a SAR test plan proposal with respect to the above

Not applicable.

- 14) If applicable, include preliminary SAR test data and/or supporting information in laboratory testing inquiries to address specific issues and concerns or for requesting further test reduction considerations appropriate for the device; for example, simultaneous transmission configurations.

Not applicable.

## 9. SAR Test Data Summary

### See Measurement Result Data Pages

See Appendix B for SAR Test Data Plots.  
See Appendix C for SAR Test Setup Photos.

### Procedures Used To Establish Test Signal

The device was either placed into simulated transmit mode using the manufacturer’s test codes or the actual transmission is activated through a base station simulator or similar equipment. See data pages for actual procedure used in measurement.

### Device Test Condition

In order to verify that the device was tested at full power, conducted output power measurements were performed before and after each SAR measurement to confirm the output power unless otherwise noted. If a conducted power deviation of more than 5% occurred, the test was repeated. The power drift of each test is measured at the start of the test and again at the end of the test. The drift percentage is calculated by the formula  $((end/start)-1)*100$  and rounded to three decimal places. The drift percentage is calculated into the resultant SAR value on the data sheet for each test.

The EUT was tested on the front of the antenna for the cellular bands. The WiFi bands are excluded due to the distance from the user once installed on a utility vehicle. The installation of the antenna is located behind the fuel tank. The minimum distance from the user is 156 mm as shown in the diagram below. Due to RSS-102 requirement, the transmitters cannot be excluded due to the power and the maximum distanced allowed for exclusion is 50 mm. The testing was conducted at 50 mm which is a more conservative distance than would be used in the final configuration. All remaining sides were excluded due to the installation and use of the device. The WiFi transmitter is excluded at 50 mm. See the calculations below. See Appendix C for photos of the setup. All measurements were conducted with the side of the device 50 mm from the phantom.

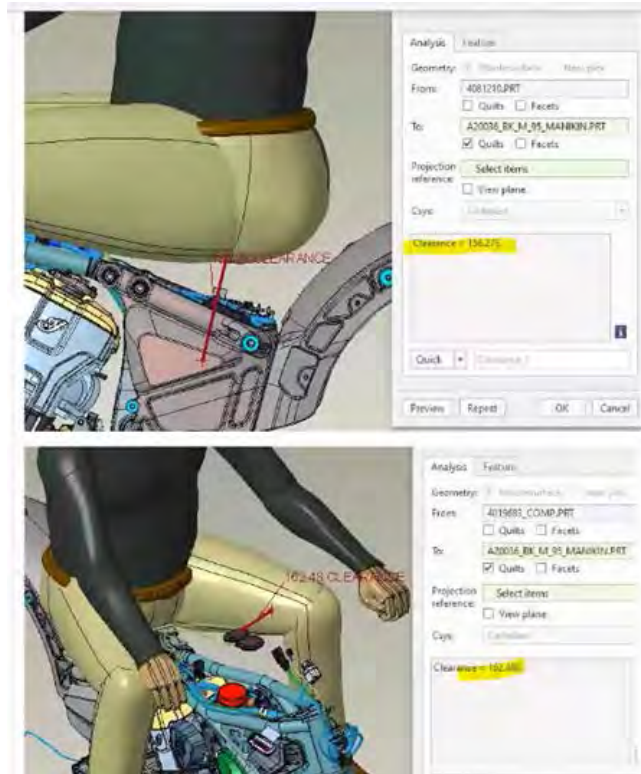



The tolerance for the Quectel modem (FC20) is 17 dBm ± 2.5 dBm for 2.4 GHz bands and 14.5 dBm ± 2.5 dBm for 5 GHz bands. Therefore, the upper end of the conducted tolerance is 19.5 dBm (89.1 mW) for 2.4 GHz and 17.0 dBm (50.1 mW) for 5 GHz. The antenna gain for each band is a negative gain. The table below shows the gain for each band.

Modem	Band	Technology	Gain
Quectel FC20	2.4 GHz	WiFi	-1.2 dBi
	5 GHz	WiFi	-0.6 dBi
	2.4 GHz	Bluetooth	-1.2 dBi

Therefore, the conducted power level is used to calculate the exclusion.

Quectel Model FC20

2.4 GHz WiFi Band = 19.5 dBm = 89.1 mW

5 GHz WiFi Band = 17.0 dBm = 50.1 mW

2.4 GHz BT Band = 6.8 dBm = 4.8 mW

Quectel Model FC20 Exclusion Power Limits

2.4 GHz Bands – 309 mW

5 GHz Bands – 106 mW

Therefore, the WiFi transmitter is excluded from standalone SAR evaluations.

(maximum power level including tune-up tolerance / minimum separation distance) \*  $\sqrt{\text{freq}} / 18.75 =$  W/kg

For 2.4 GHz WiFi band, the equation is  $(89.1/50)*0.2=0.36$  W/kg.

For 2.4 GHz BT band, the equation is  $(4.8/50)*0.2=0.02$  W/kg.

For 5 GHz WiFi band, the equation is  $(50.1/50)*0.32=0.32$  W/kg.

**GPRS Conducted Power**

1. The following tests were conducted according to the test requirements outlines in KDB 941225 D01 v03r01 guidance.
2. The procedures in KDB 941225 D01v03r01 are applied to configure the device in the required mode(s) to determine SAR test exclusion.
3. The MT8820C was configured for GMSK. The time slot was set to 1 through 4 slots. The power was measured for both modulations and all time slots.

GPRS-GMSK/1 slot			
Band	Channel	Peak Power	Frame Average
Cellular	128	33.4	24.37
	190	33.3	24.27
	251	33.6	24.57
PCS	512	30.6	21.57
	661	30.4	21.37
	810	30.5	21.47

GPRS-GMSK/2 slot			
Band	Channel	Peak Power	Frame Average
Cellular	128	33.5	27.48
	190	33.7	27.68
	251	33.2	27.18
PCS	512	30.2	24.18
	661	30.7	24.68
	810	30.4	24.38

GPRS-GMSK/3 slot			
Band	Channel	Peak Power	Frame Average
Cellular	128	33.3	29.04
	190	33.6	29.34
	251	33.4	29.14
PCS	512	30.3	26.04
	661	30.1	25.84
	810	30.5	26.24

GPRS-GMSK/4 slot			
Band	Channel	Peak Power	Frame Average
Cellular	128	30.5	27.49
	190	30.4	27.39
	251	30.3	27.29
PCS	512	27.6	24.59
	661	27.5	24.49
	810	27.5	24.49

**WCDMA Conducted Power**

1. The following tests were conducted according to the test requirements outlines in 3GPP TS 34.121 specification.
2. The procedures in KDB 941225 D01v03r01 are applied for 3GPP Rel. 6 HSPA to configure the device in the required sub-test mode(s) to determine SAR test exclusion.
3. For DC-HSDPA, the device was configured according to the H-Set 12, Fixed Reference Channel (FRC) configuration in Table C.8.1.12 of 3GPP TS 34.121-1, with the primary and the secondary serving HS-DSCH Cell enabled during the power measurement.

A summary of these settings are illustrated below:

**HSDPA SETUP CONFIGURATION:**

- a. The EUT was connected to Base Station Agilent E5515C referred to the Setup Configuration.
- b. The RF path losses were compensated into the measurements.
- c. A call was established between EUT and Base Station with following setting:
  - i. Set Gain Factors ( $\beta_c$  and  $\beta_d$ ) and parameters were set according to each
  - ii. Specific sub-test in the following table, C10.1.4, quoted from the TS 34.121
  - iii. Set RMC 12.2Kbps + HSDPA mode.
  - iv. Set Cell Power = -86 dBm
  - v. Set HS-DSCH Configuration Type to FRC (H-set 1, QPSK)
  - vi. Select HSDPA Uplink Parameters
  - vii. Set Delta ACK, Delta NACK and Delta CQI = 8
  - viii. Set Ack-Nack Repetition Factor to 3
  - ix. Set CQI Feedback Cycle (k) to 4 ms
  - x. Set CQI Repetition Factor to 2
  - xi. Power Ctrl Mode = All Up bits
- d. The transmitted maximum output power was recorded.

**Table C.10.1.4:  $\beta$  values for transmitter characteristics tests with HS-DPCCH**

Sub-test	$\beta_c$	$\beta_d$	$\beta_d$ (SF)	$\beta_c/\beta_d$	$\beta_{HS}$ (Note 1, Note 2)	CM (dB) (Note 3)	MPR (dB) (Note 3)
1	2/15	15/15	64	2/15	4/15	0.0	0.0
2	12/15 (Note 4)	15/15 (Note 4)	64	12/15 (Note 4)	24/15	1.0	0.0
3	15/15	8/15	64	15/8	30/15	1.5	0.5
4	15/15	4/15	64	15/4	30/15	1.5	0.5

Note 1:  $\Delta_{ACK}, \Delta_{NACK}$  and  $\Delta_{CQI} = 30/15$  with  $\beta_{HS} = 30/15 * \beta_c$ .

Note 2: For the HS-DPCCH power mask requirement test in clause 5.2C, 5.7A, and the Error Vector Magnitude (EVM) with HS-DPCCH test in clause 5.13.1A, and HSDPA EVM with phase discontinuity in clause 5.13.1AA,  $\Delta_{ACK}$  and  $\Delta_{NACK} = 30/15$  with  $\beta_{HS} = 30/15 * \beta_c$ , and  $\Delta_{CQI} = 24/15$  with  $\beta_{HS} = 24/15 * \beta_c$ .

Note 3: CM = 1 for  $\beta_c/\beta_d = 12/15, \beta_{HS}/\beta_c = 24/15$ . For all other combinations of DPDCH, DPCCH and HS-DPCCH the MPR is based on the relative CM difference. This is applicable for only UEs that support HSDPA in release 6 and later releases.

Note 4: For subtest 2 the  $\beta_c/\beta_d$  ratio of 12/15 for the TFC during the measurement period (TF1, TF0) is achieved by setting the signalled gain factors for the reference TFC (TF1, TF1) to  $\beta_c = 11/15$  and  $\beta_d = 15/15$ .

**SETUP CONFIGURATION**

**HSUPA SETUP CONFIGURATION:**

- a. The EUT was connected to Base Station Agilent E5515C referred to the Setup Configuration.
- b. The RF path losses were compensated into the measurements.
- c. A call was established between EUT and Base Station with following setting \* :
  - i. Call Configs = 5.2B, 5.9B, 5.10B, and 5.13.2B with QPSK
  - ii. Set the Gain Factors ( $\beta_c$  and  $\beta_d$ ) and parameters (AG Index) were set according to each specific sub-test in the following table, C11.1.3, quoted from the TS 34.121
  - iii. Set Cell Power = -86 dBm
  - iv. Set Channel Type = 12.2k + HSPA
  - v. Set UE Target Power
  - vi. Power Ctrl Mode= Alternating bits
  - vii. Set and observe the E-TFCl
  - viii. Confirm that E-TFCl is equal to the target E-TFCl of 75 for sub-test 1, and other subtest's E-TFCl
- d. The transmitted maximum output power was recorded.

**Table C.11.1.3:  $\beta$  values for transmitter characteristics tests with HS-DPCCH and E-DCH**

Sub-test	$\beta_c$	$\beta_d$	$\beta_d$ (SF)	$\beta_c/\beta_d$	$\beta_{HS}$ (Note 1)	$\beta_{ec}$	$\beta_{ed}$ (Note 4) (Note 5)	$\beta_{ed}$ (SF)	$\beta_{ed}$ (Codes)	CM (dB) (Note 2)	MPR (dB) (Note 2) (Note 6)	AG Index (Note 5)	E-TFCl
1	11/15 (Note 3)	15/15 (Note 3)	64	11/15 (Note 3)	22/15	209/25	1309/225	4	1	1.0	0.0	20	75
2	6/15	15/15	64	6/15	12/15	12/15	94/75	4	1	3.0	2.0	12	67
3	15/15	9/15	64	15/9	30/15	30/15	$\beta_{ed1}$ : 47/15 $\beta_{ed2}$ : 47/15	4 4	2	2.0	1.0	15	92
4	2/15	15/15	64	2/15	4/15	2/15	56/75	4	1	3.0	2.0	17	71
5	15/15	0	-	-	5/15	5/15	47/15	4	1	1.0	0.0	12	67

Note 1: For sub-test 1 to 4,  $\Delta_{ACK}$ ,  $\Delta_{NACK}$  and  $\Delta_{COI} = 30/15$  with  $\beta_{hs} = 30/15 * \beta_c$ . For sub-test 5,  $\Delta_{ACK}$ ,  $\Delta_{NACK}$  and  $\Delta_{COI} = 5/15$  with  $\beta_{hs} = 5/15 * \beta_c$ .

Note 2: CM = 1 for  $\beta_c/\beta_d = 12/15$ ,  $\beta_{hs}/\beta_c = 24/15$ . For all other combinations of DPDCH, DPCCH, HS-DPCCH, E-DPDCH and E-DPCCH the MPR is based on the relative CM difference.

Note 3: For subtest 1 the  $\beta_c/\beta_d$  ratio of 11/15 for the TFC during the measurement period (TF1, TF0) is achieved by setting the signalled gain factors for the reference TFC (TF1, TF1) to  $\beta_c = 10/15$  and  $\beta_d = 15/15$ .

Note 4: In case of testing by UE using E-DPDCH Physical Layer category 1, Sub-test 3 is omitted according to TS25.306 Table 5.1g.

Note 5:  $\beta_{ed}$  can not be set directly; it is set by Absolute Grant Value.

Note 6: For subtests 2, 3 and 4, UE may perform E-DPDCH power scaling at max power which could results in slightly smaller MPR values.

**SETUP CONFIGURATION**

**DC-HSDPA 3GPP RELEASE 8 SETUP CONFIGURATION:**

- a. The EUT was connected to Base Station Agilent E5515C referred to the Setup Configuration below
- b. The RF path losses were compensated into the measurements.
- c. A call was established between EUT and Base Station with following setting:
  - i. Set RMC 12.2Kbps + HSDPA mode.
  - ii. Set Cell Power = -25 dBm
  - iii. Set HS-DSCH Configuration Type to FRC (H-set 12, QPSK)
  - iv. Select HSDPA Uplink Parameters
  - v. Set Gain Factors ( $\beta_c$  and  $\beta_d$ ) and parameters were set according to each Specific sub-test in the following table,  
C10.1.4, quoted from the TS  
34.121 a). Subtest 1:  
 $\beta_c/\beta_d=2/15$   
b). Subtest 2:  
 $\beta_c/\beta_d=12/15$  c).  
Subtest 3:  $\beta_c/\beta_d=15/8$   
d). Subtest 4:  
 $\beta_c/\beta_d=15/4$
  - vi. Set Delta ACK, Delta NACK and Delta CQI = 8
  - vii. Set Ack-Nack Repetition Factor to 3
  - viii. Set CQI Feedback Cycle (k) to 4 ms
  - ix. Set CQI Repetition Factor to 2
  - x. Power Ctrl Mode = All Up bits
- d. The transmitted maximum output power was recorded.

The following tests were conducted according to the test requirements outlines in 3GPP TS 34.121 specification. A summary of these settings are illustrated below:

C.8.1.12 Fixed Reference Channel Definition H-Set 12

Table C.8.1.12: Fixed Reference Channel H-Set 12

Parameter	Unit	Value
Nominal Avg. Inf. Bit Rate	kbps	60
Inter-TTI Distance	TTI's	1
Number of HARQ Processes	Processes	6
Information Bit Payload ( $N_{inf}$ )	Bits	120
Number Code Blocks	Blocks	1
Binary Channel Bits Per TTI	Bits	960
Total Available SML's in UE	SML's	19200
Number of SML's per HARQ Proc.	SML's	3200
Coding Rate		0.15
Number of Physical Channel Codes	Codes	1
Modulation		QPSK
Note 1: The RMC is intended to be used for DC-HSDPA mode and both cells shall transmit with identical parameters as listed in the table. Note 2: Maximum number of transmission is limited to 1, i.e., retransmission is not allowed. The redundancy and constellation version 0 shall be used.		

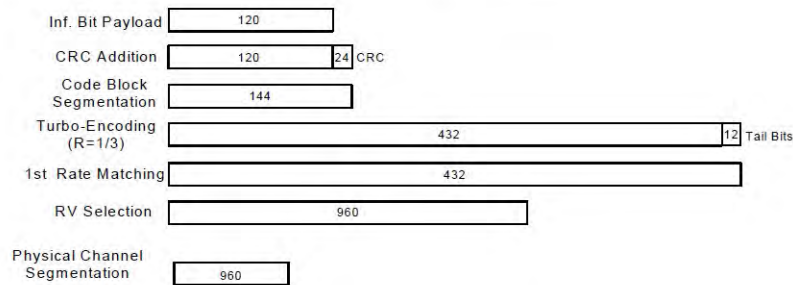

Figure C.8.19: Coding rate for Fixed reference Channel H-Set 12 (QPSK)

**SETUP CONFIGURATION**

<WCDMA Conducted Power>

**GENERAL NOTE:**

- Per KDB 941225 D01v03r01, for SAR testing is measured using a 12.2 kbps RMC with TPC bits configured to all "1's".
- Per KDB 941225 D01v03r01, RMC 12.2kbps setting is used to evaluate SAR. The maximum output power and tune-up tolerance specified for production units in HSDPA / HSUPA / DC-HSDPA is  $\leq \frac{1}{4}$  dB higher than RMC 12.2Kbps or when the highest reported SAR of the RMC12.2Kbps is scaled by the ratio of specified maximum output power and tune-up tolerance of HSDPA / HSUPA / DC-HSDPA to RMC12.2Kbps and the adjusted SAR is  $\leq 1.2$  W/kg, SAR measurement is not required for HSDPA / HSUPA / DC-HSDPA, and according to the following RF output power, the output power results of the secondary modes (HSUPA, HSDPA, DC-HSDPA) are less than  $\frac{1}{4}$  dB higher than the primary modes; therefore, SAR measurement is not required for HSDPA / HSUPA / DC-HSDPA.

**Power Measurements**

Band		WCDMA II			Tune-up Limit (dBm)	WCDMA IV			Tune-up Limit (dBm)	WCDMA V			Tune-up Limit (dBm)
TX Channel		9262	9400	9538		1312	1413	1513		4132	4182	4233	
Rx Channel		9662	9800	9938	1537	1638	1738	4357	4407	4458			
Frequency (MHz)		1852.4	1880	1907.6	1712.4	1732.6	1752.6	826.4	836.4	846.6			
3GPP Rel 99	AMR 12.2Kbps	24.59	24.78	24.61	25.00	24.85	24.80	24.77	25.00	24.58	24.89	24.50	25.00
3GPP Rel 99	RMC 12.2Kbps	24.83	24.79	24.95	25.00	24.61	24.76	24.51	25.00	24.63	24.88	24.79	25.00
3GPP Rel 6	HSDPA Subtest-1	23.53	23.53	23.93	24.00	23.75	23.98	23.90	24.00	23.89	23.55	23.75	24.00
3GPP Rel 6	HSDPA Subtest-2	23.71	23.89	23.76	24.00	23.83	23.89	23.79	24.00	23.72	23.96	23.92	24.00
3GPP Rel 6	HSDPA Subtest-3	24.44	24.08	24.50	24.50	24.46	24.03	24.21	24.50	24.42	24.42	24.16	24.50
3GPP Rel 6	HSDPA Subtest-4	24.18	24.29	24.04	24.50	24.35	24.20	24.39	24.50	24.22	24.47	24.31	24.50
3GPP Rel 8	DC-HSDPA Subtest-1	23.92	23.95	23.63	24.00	23.57	23.76	23.55	24.00	23.96	23.60	23.80	24.00
3GPP Rel 8	DC-HSDPA Subtest-2	23.82	23.68	23.89	24.00	23.92	23.82	23.77	24.00	23.70	23.68	23.85	24.00
3GPP Rel 8	DC-HSDPA Subtest-3	24.49	24.35	24.44	24.50	24.12	24.00	24.15	24.50	24.37	24.01	24.29	24.50
3GPP Rel 8	DC-HSDPA Subtest-4	24.26	24.36	24.31	24.50	24.37	24.43	24.25	24.50	24.43	24.04	24.33	24.50
3GPP Rel 6	HSUPA Subtest-1	23.59	23.73	23.69	24.00	23.98	23.93	23.54	24.00	23.60	23.79	23.79	24.00
3GPP Rel 6	HSUPA Subtest-2	21.64	21.80	21.79	22.00	21.51	21.57	21.83	22.00	21.78	21.54	21.99	22.00
3GPP Rel 6	HSUPA Subtest-3	22.99	22.81	22.91	23.00	22.83	22.57	22.97	23.00	22.58	22.69	22.52	23.00
3GPP Rel 6	HSUPA Subtest-4	21.68	21.63	21.90	22.00	21.98	21.87	21.87	22.00	22.00	21.88	21.73	22.00
3GPP Rel 6	HSUPA Subtest-5	23.93	23.64	23.60	24.00	23.79	23.95	23.53	24.00	23.52	23.93	23.94	24.00

## LTE Conducted Power

### General Note:

1. Anritsu MT8820C base station simulator was used to setup the connection with EUT; the frequency band, channel bandwidth, RB allocation configuration, modulation type are set in the base station simulator to configure EUT transmitting at maximum power and at different configurations which are requested to be reported to FCC, for conducted power measurement and SAR testing.
2. Per KDB 941225 D05v02r05, when a properly configured base station simulator is used for the SAR and power measurements, spectrum plots for each RB allocation and offset configuration is not required.
3. Per KDB 941225 D05v02r05, start with the largest channel bandwidth and measure SAR for QPSK with 1 RB allocation, using the RB offset and required test channel combination with the highest maximum output power for RB offsets at the upper edge, middle and lower edge of each required test channel.
4. Per KDB 941225 D05v02r05, 50% RB allocation for QPSK SAR testing follows 1RB QPSK allocation procedure.
5. Per KDB 941225 D05v02r05, For QPSK with 100% RB allocation, SAR is not required when the highest maximum output power for 100 % RB allocation is less than the highest maximum output power in 50% and 1 RB allocations and the highest reported SAR for 1 RB and 50% RB allocation are  $\leq 0.8$  W/kg. Otherwise, SAR is measured for the highest output power channel; and if the reported SAR is  $> 1.45$  W/kg, the remaining required test channels must also be tested.
6. Per KDB 941225 D05v02r05, 16QAM output power for each RB allocation configuration is  $>$  not  $\frac{1}{2}$  dB higher than the same configuration in QPSK and the reported SAR for the QPSK configuration is  $\leq 1.45$  W/kg; Per KDB 941225 D05v02r05, 16QAM SAR testing is not required.
7. Per KDB 941225 D05v02r05, Smaller bandwidth output power for each RB allocation configuration is  $>$  not  $\frac{1}{2}$  dB higher than the same configuration in the largest supported bandwidth, and the reported SAR for the largest supported bandwidth is  $\leq 1.45$  W/kg; Per KDB 941225 D05v02r05, smaller bandwidth SAR testing is not required.
8. LTE band 2/5 SAR test was covered by Band 25/26 for EG95NA and band 2/4/5 SAR test was covered by Band 25/26/66 for BG772; according to April 2015 TCB workshop, SAR test for overlapping LTE bands can be reduced if
  - a. the maximum output power, including tolerance, for the smaller band is  $\leq$  the larger band to qualify for the SAR test exclusion
  - b. the channel bandwidth and other operating parameters for the smaller band are fully supported by the larger band
9. According to 2017 TCB workshop, for 64 QAM and 16 QAM should be verified by checking the signal constellation with a call box to avoid incorrect maximum power levels due to MPR and other requirements associated with signal modulation, and the following figure is taken from the "Fundamental Measurement >> Modulation Analysis >> constellation" mode of the device connect to the MT8821C base station, therefore, the device 64QAM and 16QAM signal modulation are correct.

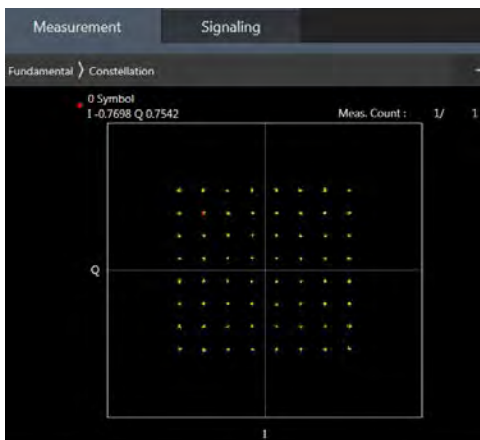

64QAM

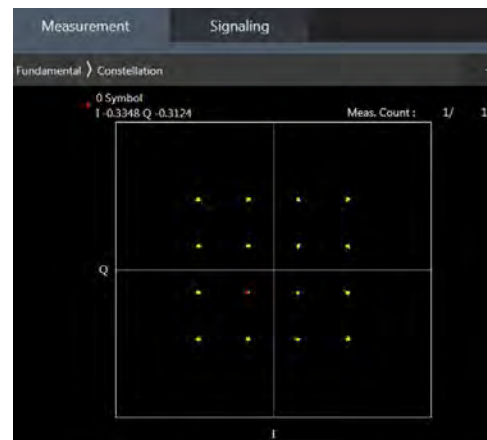

16QAM

## <TDD LTE SAR Measurement>

TDD LTE configuration setup for SAR measurement

SAR was tested with a fixed periodic duty factor according to the highest transmission duty factor implemented for the device and supported by 3GPP.

- 3GPP TS 36.211 section 4.2 for Type 2 Frame Structure and Table 4.2-2 for uplink-downlink configurations
- “special subframe S” contains both uplink and downlink transmissions, it has been taken into consideration to determine the transmission duty factor according to the worst case uplink and downlink cyclic prefix requirements for UpPTS
- Establishing connections with base station simulators ensure a consistent means for testing SAR and recommended for evaluating SAR. The Anritsu MT8820C (firmware: #22.52#004) was used for LTE output power measurements and SAR testing.

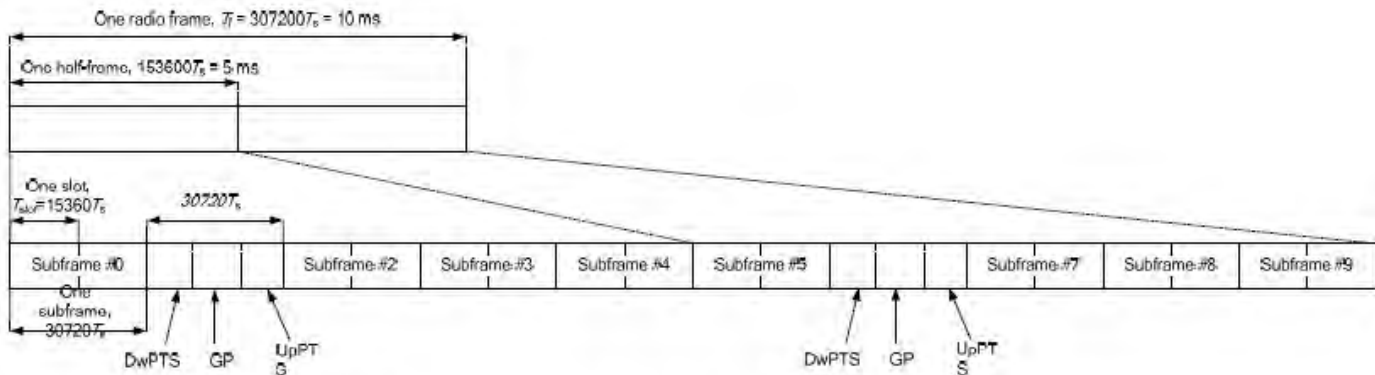

Figure 4.2-1: Frame structure type 2 (for 5 ms switch-point periodicity).

Table 4.2-2: Uplink-downlink configurations.

Uplink-downlink configuration	Downlink-to-Uplink Switch-point periodicity	Subframe number									
		0	1	2	3	4	5	6	7	8	9
0	5 ms	D	S	U	U	U	D	S	U	U	U
1	5 ms	D	S	U	U	D	D	S	U	U	D
2	5 ms	D	S	U	D	D	D	S	U	D	D
3	10 ms	D	S	U	U	U	D	D	D	D	D
4	10 ms	D	S	U	U	D	D	D	D	D	D
5	10 ms	D	S	U	D	D	D	D	D	D	D
6	5 ms	D	S	U	U	U	D	S	U	U	D

Table 4.2-1: Configuration of special subframe (lengths of DwPTS/GP/UpPTS).

Special subframe configuration	Normal cyclic prefix in downlink			Extended cyclic prefix in downlink		
	DwPTS	UpPTS		DwPTS	UpPTS	
		Normal cyclic prefix in uplink	Extended cyclic prefix in uplink		Normal cyclic prefix in uplink	Extended cyclic prefix in uplink
0	$6592 \cdot T_s$	$2192 \cdot T_s$	$2560 \cdot T_s$	$7680 \cdot T_s$	$2192 \cdot T_s$	$2560 \cdot T_s$
1	$19760 \cdot T_s$			$20480 \cdot T_s$		
2	$21952 \cdot T_s$			$23040 \cdot T_s$		
3	$24144 \cdot T_s$			$25600 \cdot T_s$		
4	$26336 \cdot T_s$	$4384 \cdot T_s$	$5120 \cdot T_s$	$7680 \cdot T_s$	$4384 \cdot T_s$	$5120 \cdot T_s$
5	$6592 \cdot T_s$			$20480 \cdot T_s$		
6	$19760 \cdot T_s$			$23040 \cdot T_s$		
7	$21952 \cdot T_s$			$12800 \cdot T_s$		
8	$24144 \cdot T_s$			-		
9	$13168 \cdot T_s$	-	-	-	-	



Special subframe (30720-T <sub>s</sub> ): Normal cyclic prefix in downlink (UpPTS)			
	Special subframe configuration	Normal cyclic prefix in uplink	Extended cyclic prefix in uplink
Uplink duty factor in one special subframe	0~4	7.13%	8.33%
	5~9	14.3%	16.7%

Special subframe(30720-T <sub>s</sub> ): Extended cyclic prefix in downlink (UpPTS)			
	Special subframe configuration	Normal cyclic prefix in uplink	Extended cyclic prefix in uplink
Uplink duty factor in one special subframe	0~3	7.13%	8.33%
	4~7	14.3%	16.7%

The highest duty factor is resulted from:

- i. Uplink-downlink configuration: 0. In a half-frame consisted of 5 subframes, uplink operation is in 3 uplink subframes and 1 special subframe.
- ii. special subframe configuration: 5-9 for normal cyclic prefix in downlink, 4-7 for extended cyclic prefix in downlink
- iii. for special subframe with extended cyclic prefix in uplink, the total uplink duty factor in one half-frame is:  $(3+0.167)/5 = 63.3\%$
- iv. for special subframe with normal cyclic prefix in uplink, the total uplink duty factor in one half-frame is:  $(3+0.143)/5 = 62.9\%$
- v. For TDD LTE SAR measurement, the duty cycle 1:1.59 (62.9 %) was used perform testing and considering the theoretical duty cycle of 63.3% for extended cyclic prefix in the uplink, and the theoretical duty cycle of 62.9% for normal cyclic prefix in uplink, a scaling factor of extended cyclic prefix  $63.3\%/62.9\% = 1.006$  is applied to scale-up the measured SAR result. The scaled TDD LTE SAR = measured SAR (W/kg)\* Tune-up Scaling Factor\* scaling factor for extended cyclic prefix.
- vi. The device supports Power Class 3 uplink-downlink configurations 0 and 6, and Power Class 2 uplink-downlink configurations 1 to 5 operations for LTE Band 41.
- vii. The highest available duty cycle for Power Class 2 operation is 43.3% using UL-DL configuration 1, for Power Class 3 operation is 63.3% using UL-DL configuration 0. Per FCC Guidance, all SAR tests were performed using Power Class 3. SAR with Power Class 2 at the available duty factor was additionally performed for the Power Class 3 configuration with the highest SAR among all exposure condition.

**Table 9.1 LTE Power Measurements EG21-G**

Band	Bandwidth	RB Size	RB Offset	Channel	Frequency	QPSK	16QAM	
2	1.4 MHz	1	0	18607	1850.7	24.6	23.2	
				18900	1880.0	24.2	23.6	
				19193	1909.3	24.5	23.4	
			3	18607	1850.7	24.5	23.5	
				18900	1880.0	24.3	23.3	
				19193	1909.3	24.2	23.6	
			5	18607	1850.7	24.5	23.3	
				18900	1880.0	24.2	23.3	
				19193	1909.3	24.6	23.1	
		3	0	18607	1850.7	24.7	23.2	
				18900	1880.0	24.2	23.2	
				19193	1909.3	24.5	23.5	
			1	18607	1850.7	24.3	23.1	
				18900	1880.0	24.2	23.2	
				19193	1909.3	24.2	23.0	
			3	18607	1850.7	24.5	23.7	
				18900	1880.0	24.5	23.7	
				19193	1909.3	24.0	23.1	
		6	0	18607	1850.7	23.2	22.2	
				18900	1880.0	23.3	22.5	
				19193	1909.3	23.0	22.1	
		3 MHz	1	0	18615	1851.5	24.5	23.0
					18900	1880.0	24.7	23.6
					19185	1908.5	24.3	23.6
	7			18615	1851.5	24.5	23.6	
				18900	1880.0	24.2	23.4	
				19185	1908.5	24.6	23.6	
	14			18615	1851.5	24.0	23.5	
				18900	1880.0	24.3	23.3	
				19185	1908.5	24.2	23.6	
	8			0	18615	1851.5	23.6	22.2
					18900	1880.0	23.3	22.4
					19185	1908.5	23.2	22.6
				7	18615	1851.5	23.7	22.5
					18900	1880.0	23.5	22.5
					19185	1908.5	23.5	22.3
			14	18615	1851.5	23.2	22.6	
				18900	1880.0	23.1	22.2	
				19185	1908.5	23.4	22.1	
	15		0	18615	1851.5	23.5	22.2	
				18900	1880.0	23.5	22.1	
				19185	1908.5	23.0	22.4	

Band	Bandwidth	RB Size	RB Offset	Channel	Frequency	QPSK	16QAM		
2	5 MHz	1	0	18625	1852.5	24.2	23.4		
				18900	1880.0	24.5	23.4		
				19175	1907.5	24.3	23.3		
			12	12	18625	1852.5	24.5	23.5	
					18900	1880.0	24.3	23.5	
					19175	1907.5	24.5	23.6	
				24	18625	1852.5	24.3	23.6	
					18900	1880.0	24.2	23.1	
					19175	1907.5	24.5	23.2	
		12	0	18625	1852.5	23.2	22.1		
				18900	1880.0	23.6	22.3		
				19175	1907.5	23.2	22.3		
			6	18625	1852.5	23.2	22.1		
				18900	1880.0	23.7	22.4		
				19175	1907.5	23.5	22.3		
				13	18625	1852.5	23.3	22.1	
					18900	1880.0	23.5	22.4	
					19175	1907.5	23.3	22.0	
			25	0	18625	1852.5	23.3	22.1	
					18900	1880.0	23.1	22.6	
					19175	1907.5	23.0	22.6	
			10 MHz	1	0	18650	1855.0	24.2	23.3
						18900	1880.0	24.5	23.5
						19150	1905.0	24.3	23.7
	24	18650				1855.0	24.1	23.3	
		18900				1880.0	24.3	23.6	
		19150				1905.0	24.1	23.2	
	49	18650			1855.0	24.5	23.3		
		18900			1880.0	24.3	23.4		
		19150			1905.0	24.1	23.4		
		25			0	18650	1855.0	23.2	22.4
						18900	1880.0	23.7	22.1
						19150	1905.0	23.5	22.1
	13				18650	1855.0	23.1	22.6	
					18900	1880.0	23.5	22.2	
					19150	1905.0	23.5	22.4	
					25	18650	1855.0	23.6	22.5
						18900	1880.0	23.6	22.6
						19150	1905.0	23.3	22.2
	50	0		18650	1855.0	23.6	22.4		
				18900	1880.0	23.2	22.3		
				19150	1905.0	23.2	22.0		

Band	Bandwidth	RB Size	RB Offset	Channel	Frequency	QPSK	16QAM	
2	15 MHz	1	0	18675	1857.5	24.7	23.5	
				18900	1880.0	24.4	23.7	
				19125	1902.5	24.1	23.7	
			37	18675	1857.5	24.6	23.6	
				18900	1880.0	24.5	23.6	
				19125	1902.5	24.0	23.1	
			74	18675	1857.5	24.3	23.6	
				18900	1880.0	24.6	23.2	
				19125	1902.5	24.7	23.2	
		36	0	18675	1857.5	23.2	22.6	
				18900	1880.0	23.5	22.6	
				19125	1902.5	23.2	22.6	
			19	18675	1857.5	23.4	22.7	
				18900	1880.0	23.4	22.6	
				19125	1902.5	23.6	22.6	
			39	18675	1857.5	23.0	22.2	
				18900	1880.0	23.5	22.3	
				19125	1902.5	23.5	22.5	
		75	0	18675	1857.5	23.6	22.7	
				18900	1880.0	23.7	22.6	
				19125	1902.5	23.2	22.2	
		20 MHz	1	0	18700	1860.0	24.4	23.1
					18900	1880.0	24.1	23.5
					19100	1900.0	24.0	23.4
	49			18700	1860.0	24.1	23.5	
				18900	1880.0	24.0	23.4	
				19100	1900.0	24.5	23.3	
	99			18700	1860.0	24.6	23.6	
				18900	1880.0	24.4	23.2	
				19100	1900.0	24.0	23.2	
	50			0	18700	1860.0	23.4	22.2
					18900	1880.0	23.1	22.0
					19100	1900.0	23.6	22.2
			24	18700	1860.0	23.3	22.2	
				18900	1880.0	23.3	22.0	
				19100	1900.0	23.1	22.2	
			50	18700	1860.0	23.6	22.2	
				18900	1880.0	23.1	22.6	
				19100	1900.0	23.4	22.2	
	100		0	18700	1860.0	23.4	22.5	
				18900	1880.0	23.0	22.0	
				19100	1900.0	23.4	22.5	

Band	Bandwidth	RB Size	RB Offset	Channel	Frequency	QPSK	16QAM	
4	1.4 MHz	1	0	19957	1710.7	24.7	23.0	
				20175	1732.5	24.3	23.5	
				20393	1754.3	24.2	23.6	
			3	19957	1710.7	24.3	23.5	
				20175	1732.5	24.4	23.7	
				20393	1754.3	24.5	23.4	
			5	19957	1710.7	24.2	23.2	
				20175	1732.5	24.1	23.7	
				20393	1754.3	24.5	23.5	
		3	0	19957	1710.7	24.4	23.3	
				20175	1732.5	24.6	23.2	
				20393	1754.3	24.4	23.2	
			1	19957	1710.7	24.6	23.5	
				20175	1732.5	24.4	23.3	
				20393	1754.3	24.3	23.0	
			3	19957	1710.7	24.1	23.6	
				20175	1732.5	24.7	23.3	
				20393	1754.3	24.2	23.0	
		6	0	19957	1710.7	23.4	22.5	
				20175	1732.5	23.2	22.2	
				20393	1754.3	23.3	22.5	
		3 MHz	1	0	19965	1711.5	24.2	23.2
					20175	1732.5	24.6	23.2
					20385	1753.5	24.3	23.7
	7			19965	1711.5	24.2	23.3	
				20175	1732.5	24.6	23.6	
				20385	1753.5	24.4	23.2	
	14			19965	1711.5	24.7	23.5	
				20175	1732.5	24.4	23.2	
				20385	1753.5	24.0	23.2	
	8			0	19965	1711.5	23.1	22.6
					20175	1732.5	23.1	22.2
					20385	1753.5	23.0	22.6
			7	19965	1711.5	23.1	22.3	
				20175	1732.5	23.4	22.2	
				20385	1753.5	23.3	22.4	
			14	19965	1711.5	23.5	22.2	
				20175	1732.5	23.3	22.4	
				20385	1753.5	23.2	22.5	
	15		0	19965	1711.5	23.2	22.1	
				20175	1732.5	23.4	22.3	
				20385	1753.5	23.7	22.6	

Band	Bandwidth	RB Size	RB Offset	Channel	Frequency	QPSK	16QAM	
4	5 MHz	1	0	19975	1712.5	24.1	23.4	
				20175	1732.5	24.3	23.5	
				20375	1752.5	24.2	23.2	
			12	19975	1712.5	24.2	23.6	
				20175	1732.5	24.7	23.5	
				20375	1752.5	24.0	23.3	
			24	19975	1712.5	24.7	23.3	
				20175	1732.5	24.2	23.1	
				20375	1752.5	24.4	23.7	
		12	0	19975	1712.5	23.4	22.3	
				20175	1732.5	23.1	22.6	
				20375	1752.5	23.3	22.6	
			6	19975	1712.5	23.2	22.6	
				20175	1732.5	23.3	22.6	
				20375	1752.5	23.2	22.5	
			13	19975	1712.5	23.5	22.7	
				20175	1732.5	23.4	22.7	
				20375	1752.5	23.1	22.0	
			25	0	19975	1712.5	23.6	22.5
					20175	1732.5	23.5	22.2
					20375	1752.5	23.1	22.2
		10 MHz	1	0	20000	1715.0	24.2	23.3
					20175	1732.5	24.6	23.1
					20350	1750.0	24.0	23.1
	24			20000	1715.0	24.7	23.6	
				20175	1732.5	24.2	23.4	
				20350	1750.0	24.5	23.4	
	49			20000	1715.0	24.3	23.1	
				20175	1732.5	24.6	23.5	
				20350	1750.0	24.2	23.4	
	25			0	20000	1715.0	23.4	22.5
					20175	1732.5	23.2	22.6
					20350	1750.0	23.7	22.3
			13	20000	1715.0	23.6	22.2	
				20175	1732.5	23.6	22.3	
				20350	1750.0	23.3	22.2	
			25	20000	1715.0	23.6	22.3	
				20175	1732.5	23.3	22.4	
				20350	1750.0	23.1	22.4	
	50		0	20000	1715.0	23.3	22.2	
				20175	1732.5	23.1	22.7	
				20350	1750.0	23.4	22.1	

Band	Bandwidth	RB Size	RB Offset	Channel	Frequency	QPSK	16QAM	
4	15 MHz	1	0	20025	1717.5	24.1	23.3	
				20175	1732.5	24.7	23.4	
				20325	1747.5	24.1	23.2	
			37	20025	1717.5	24.3	23.5	
				20175	1732.5	24.1	23.6	
				20325	1747.5	24.0	23.3	
			74	20025	1717.5	24.0	23.1	
				20175	1732.5	24.5	23.5	
				20325	1747.5	24.3	23.6	
		36	0	20025	1717.5	23.2	22.5	
				20175	1732.5	23.0	22.7	
				20325	1747.5	23.5	22.3	
			19	20025	1717.5	23.6	22.1	
				20175	1732.5	23.4	22.0	
				20325	1747.5	23.5	22.6	
			39	20025	1717.5	23.4	22.6	
				20175	1732.5	23.5	22.6	
				20325	1747.5	23.4	22.6	
			75	0	20025	1717.5	23.1	22.1
					20175	1732.5	23.7	22.1
					20325	1747.5	23.1	22.4
		20 MHz	1	0	20050	1720.0	24.2	23.1
					20175	1732.5	24.6	23.0
					20300	1745.0	24.3	23.3
	49			20050	1720.0	24.4	23.4	
				20175	1732.5	24.5	23.7	
				20300	1745.0	24.6	23.6	
	99			20050	1720.0	24.3	23.6	
				20175	1732.5	24.0	23.2	
				20300	1745.0	24.3	23.2	
	50			0	20050	1720.0	23.3	22.1
					20175	1732.5	23.2	22.3
					20300	1745.0	23.2	22.7
			24	20050	1720.0	23.3	22.6	
				20175	1732.5	23.4	22.0	
				20300	1745.0	23.2	22.6	
			50	20050	1720.0	23.5	22.5	
				20175	1732.5	23.5	22.1	
				20300	1745.0	23.2	22.4	
	100		0	20050	1720.0	23.7	22.2	
				20175	1732.5	23.1	22.6	
				20300	1745.0	23.1	22.2	

Band	Bandwidth	RB Size	RB Offset	Channel	Frequency	QPSK	16QAM	
5	1.4 MHz	1	0	20407	824.7	24.1	23.4	
				20525	836.5	24.4	23.1	
				20643	848.3	24.3	23.6	
			3	20407	824.7	24.1	23.1	
				20525	836.5	24.4	23.1	
				20643	848.3	24.4	23.2	
			5	20407	824.7	24.7	23.3	
				20525	836.5	24.2	23.1	
				20643	848.3	24.6	23.6	
		3	0	20407	824.7	24.4	23.6	
				20525	836.5	24.1	23.7	
				20643	848.3	24.3	23.2	
			1	20407	824.7	24.0	23.1	
				20525	836.5	24.1	23.0	
				20643	848.3	24.3	23.5	
			3	20407	824.7	24.4	23.6	
				20525	836.5	24.6	23.0	
				20643	848.3	24.5	23.0	
	6	0	20407	824.7	23.5	22.7		
			20525	836.5	23.3	22.5		
			20643	848.3	23.6	22.2		
	3 MHz	1	0	20415	825.5	24.6	23.6	
				20525	836.5	24.5	23.7	
				20635	847.5	24.0	23.1	
			7	20415	825.5	24.6	23.7	
				20525	836.5	24.7	23.5	
				20635	847.5	24.3	23.5	
			14	20415	825.5	24.2	23.0	
				20525	836.5	24.2	23.1	
				20635	847.5	24.6	23.1	
			8	0	20415	825.5	23.3	22.6
					20525	836.5	23.2	22.2
					20635	847.5	23.0	22.5
				7	20415	825.5	23.1	22.2
					20525	836.5	23.1	22.3
					20635	847.5	23.7	22.2
		14		20415	825.5	23.6	22.7	
				20525	836.5	23.0	22.1	
				20635	847.5	23.4	22.7	
		15	0	20415	825.5	23.6	22.2	
				20525	836.5	23.5	22.4	
				20635	847.5	23.4	22.6	



Band	Bandwidth	RB Size	RB Offset	Channel	Frequency	QPSK	16QAM	
5	5 MHz	1	0	20425	826.5	24.2	23.2	
				20525	836.5	24.6	23.1	
				20625	846.5	24.4	23.4	
			12	20425	826.5	24.1	23.3	
				20525	836.5	24.2	23.0	
				20625	846.5	24.1	23.0	
			24	20425	826.5	24.1	23.2	
				20525	836.5	24.2	23.3	
				20625	846.5	24.5	23.1	
		12	0	20425	826.5	23.1	22.0	
				20525	836.5	23.6	22.2	
				20625	846.5	23.5	22.7	
			6	20425	826.5	23.2	22.4	
				20525	836.5	23.1	22.4	
				20625	846.5	23.3	22.6	
			13	20425	826.5	23.4	22.6	
				20525	836.5	23.5	22.6	
				20625	846.5	23.6	22.6	
			25	0	20425	826.5	23.6	22.2
					20525	836.5	23.5	22.0
					20625	846.5	23.1	22.3
		10 MHz	1	0	20450	829.0	24.6	23.5
					20525	836.5	24.6	23.3
					20600	844.0	24.2	23.5
	24			20450	829.0	24.5	23.6	
				20525	836.5	24.5	23.3	
				20600	844.0	24.6	23.0	
	49			20450	829.0	24.6	23.7	
				20525	836.5	24.1	23.3	
				20600	844.0	24.7	23.5	
	25			0	20450	829.0	23.2	22.6
					20525	836.5	23.7	22.2
					20600	844.0	23.1	22.5
			13	20450	829.0	23.2	22.2	
				20525	836.5	23.6	22.1	
				20600	844.0	23.0	22.5	
			25	20450	829.0	23.1	22.6	
				20525	836.5	23.1	22.3	
				20600	844.0	23.3	22.5	
	50		0	20450	829.0	23.6	22.1	
				20525	836.5	23.3	22.2	
				20600	844.0	23.3	22.4	

Band	Bandwidth	RB Size	RB Offset	Channel	Frequency	QPSK	16QAM		
7	5 MHz	1	0	20775	2502.5	24.2	23.4		
				21100	2535.0	24.3	23.2		
				21425	2567.5	24.5	23.1		
			12	12	20775	2502.5	24.3	23.0	
					21100	2535.0	24.2	23.1	
					21425	2567.5	24.2	23.1	
				24	20775	2502.5	24.2	23.2	
					21100	2535.0	24.5	23.3	
					21425	2567.5	24.0	23.1	
		12	0	20775	2502.5	23.2	22.5		
				21100	2535.0	23.4	22.5		
				21425	2567.5	23.1	22.1		
			6	20775	2502.5	23.6	22.7		
				21100	2535.0	23.5	22.5		
				21425	2567.5	23.7	22.6		
				13	20775	2502.5	23.2	22.1	
					21100	2535.0	23.2	22.7	
					21425	2567.5	23.1	22.4	
			25	0	20775	2502.5	23.6	22.4	
					21100	2535.0	23.7	22.5	
					21425	2567.5	23.2	22.4	
		10 MHz	1	0	20800	2505.0	24.3	23.2	
					21100	2535.0	24.6	23.3	
					21400	2565.0	24.4	23.3	
					24	20800	2505.0	24.1	23.5
						21100	2535.0	24.7	23.2
						21400	2565.0	24.3	23.3
	49			20800	2505.0	24.5	23.1		
				21100	2535.0	24.5	23.3		
				21400	2565.0	24.4	23.6		
				25	0	20800	2505.0	23.0	22.5
						21100	2535.0	23.4	22.7
						21400	2565.0	23.2	22.5
	13				20800	2505.0	23.3	22.1	
					21100	2535.0	23.5	22.2	
					21400	2565.0	23.3	22.3	
					25	20800	2505.0	23.0	22.1
						21100	2535.0	23.0	22.4
						21400	2565.0	23.3	22.6
	50		0	20800	2505.0	23.2	22.4		
				21100	2535.0	23.6	22.7		
				21400	2565.0	23.4	22.4		

Band	Bandwidth	RB Size	RB Offset	Channel	Frequency	QPSK	16QAM	
7	15 MHz	1	0	20825	2507.5	24.4	23.5	
				21100	2535.0	24.1	23.5	
				21375	2562.5	24.4	23.2	
			37	20825	2507.5	24.0	23.1	
				21100	2535.0	24.1	23.4	
				21375	2562.5	24.3	23.4	
			74	20825	2507.5	24.4	23.7	
				21100	2535.0	24.5	23.0	
				21375	2562.5	24.5	23.2	
		36	0	20825	2507.5	23.6	22.2	
				21100	2535.0	23.2	22.0	
				21375	2562.5	23.6	22.2	
			19	20825	2507.5	23.3	22.2	
				21100	2535.0	23.0	22.7	
				21375	2562.5	23.3	22.3	
			39	20825	2507.5	23.6	22.2	
				21100	2535.0	23.0	22.6	
				21375	2562.5	23.0	22.3	
			75	0	20825	2507.5	23.5	22.4
					21100	2535.0	23.4	22.7
					21375	2562.5	23.4	22.6
		20 MHz	1	0	20850	2510.0	24.6	23.5
					21100	2535.0	24.3	23.3
					21350	2560.0	24.2	23.5
				49	20850	2510.0	24.6	23.0
					21100	2535.0	24.5	23.4
					21350	2560.0	24.3	23.7
	99			20850	2510.0	24.1	23.7	
				21100	2535.0	24.5	23.7	
				21350	2560.0	24.0	23.7	
	50			0	20850	2510.0	23.4	22.5
					21100	2535.0	23.2	22.1
					21350	2560.0	23.6	22.2
				24	20850	2510.0	23.4	22.5
					21100	2535.0	23.5	22.1
					21350	2560.0	23.6	22.5
				50	20850	2510.0	23.1	22.0
					21100	2535.0	23.1	22.1
					21350	2560.0	23.1	22.3
	100		0	20850	2510.0	23.1	22.4	
				21100	2535.0	23.2	22.1	
				21350	2560.0	23.0	22.3	

Band	Bandwidth	RB Size	RB Offset	Channel	Frequency	QPSK	16QAM	
12	1.4 MHz	1	0	23017	699.7	24.6	23.0	
				23095	707.5	24.0	23.1	
				23173	715.3	24.2	23.4	
			3	23017	699.7	24.1	23.2	
				23095	707.5	24.2	23.2	
				23173	715.3	24.3	23.4	
		5	23017	699.7	24.2	23.4		
			23095	707.5	24.3	23.7		
			23173	715.3	24.3	23.2		
		3	0	23017	699.7	24.4	23.0	
				23095	707.5	24.2	23.5	
				23173	715.3	24.6	23.1	
			1	23017	699.7	24.3	23.4	
				23095	707.5	24.1	23.6	
				23173	715.3	24.5	23.6	
			3	23017	699.7	24.7	23.7	
				23095	707.5	24.1	23.7	
				23173	715.3	24.3	23.2	
	6	0	23017	699.7	23.5	22.3		
			23095	707.5	23.0	22.4		
			23173	715.3	23.6	22.6		
	3 MHz	1	0	23025	700.5	24.1	23.2	
				23095	707.5	24.1	23.4	
				23165	714.5	24.0	23.5	
			7	23025	700.5	24.6	23.2	
				23095	707.5	24.3	23.5	
				23165	714.5	24.2	23.6	
			14	23025	700.5	24.6	23.0	
				23095	707.5	24.1	23.1	
				23165	714.5	24.4	23.6	
			8	0	23025	700.5	23.0	22.1
					23095	707.5	23.0	22.6
					23165	714.5	23.3	22.4
		7		23025	700.5	23.4	22.2	
				23095	707.5	23.5	22.3	
				23165	714.5	23.2	22.4	
		14		23025	700.5	23.5	22.7	
				23095	707.5	23.7	22.3	
				23165	714.5	23.3	22.1	
		15	0	23025	700.5	23.3	22.5	
				23095	707.5	23.2	22.4	
				23165	714.5	23.3	22.1	

Band	Bandwidth	RB Size	RB Offset	Channel	Frequency	QPSK	16QAM		
12	5 MHz	1	0	23035	701.5	24.1	23.3		
				23095	707.5	24.1	23.7		
				23155	713.5	24.3	23.1		
			12	23035	701.5	24.3	23.1		
					23095	707.5	24.0	23.0	
					23155	713.5	24.3	23.0	
			24	23035	701.5	24.3	23.3		
					23095	707.5	24.7	23.1	
					23155	713.5	24.0	23.2	
		12	0	23035	701.5	23.1	22.3		
					23095	707.5	23.2	22.5	
					23155	713.5	23.4	22.1	
				6	23035	701.5	23.4	22.5	
						23095	707.5	23.3	22.7
						23155	713.5	23.6	22.5
			13	23035	701.5	23.3	22.2		
					23095	707.5	23.1	22.5	
					23155	713.5	23.6	22.4	
			25	0	23035	701.5	23.3	22.6	
						23095	707.5	23.2	22.6
						23155	713.5	23.5	22.4
		10 MHz	1	0	23060	704.0	24.5	23.4	
					23095	707.5	24.6	23.6	
					23130	711.0	24.3	23.3	
	24			23060	704.0	24.4	23.4		
					23095	707.5	24.3	23.4	
					23130	711.0	24.6	23.6	
	49			23060	704.0	24.3	23.6		
					23095	707.5	24.0	23.5	
					23130	711.0	24.0	23.4	
	25			0	23060	704.0	23.4	22.6	
						23095	707.5	23.2	22.6
						23130	711.0	23.2	22.4
			13	23060	704.0	23.5	22.5		
					23095	707.5	23.7	22.2	
					23130	711.0	23.6	22.3	
			25	23060	704.0	23.1	22.6		
					23095	707.5	23.7	22.4	
					23130	711.0	23.2	22.4	
	50		0	23060	704.0	23.2	22.4		
					23095	707.5	23.4	22.3	
					23130	711.0	23.6	22.6	

Band	Bandwidth	RB Size	RB Offset	Channel	Frequency	QPSK	16QAM		
13	5 MHz	1	0	23205	779.5	24.1	23.0		
				23230	782.0	24.3	23.1		
				23129	784.5	24.2	23.4		
			12	12	23205	779.5	24.5	23.6	
					23230	782.0	24.3	23.4	
					23129	784.5	24.1	23.1	
			24	24	23205	779.5	24.4	23.5	
					23230	782.0	24.5	23.1	
					23129	784.5	24.1	23.6	
		12	12	0	23205	779.5	23.7	22.3	
					23230	782.0	23.4	22.1	
					23129	784.5	23.4	22.6	
				6	6	23205	779.5	23.5	22.2
						23230	782.0	23.5	22.4
						23129	784.5	23.3	22.7
				13	13	23205	779.5	23.7	22.2
						23230	782.0	23.1	22.1
						23129	784.5	23.2	22.7
	25	25	0	23205	779.5	23.4	22.5		
				23230	782.0	23.5	22.3		
				23129	784.5	23.3	22.5		
	10 MHz	1	0	23230	782.0	24.1	23.3		
				24	23230	782.0	24.4	23.5	
				49	23230	782.0	24.4	23.5	
			25	25	0	23230	782.0	23.4	22.6
					13	23230	782.0	23.3	22.5
					25	23230	782.0	23.1	22.1
		50	0	23230	782.0	23.5	22.7		

Band	Bandwidth	RB Size	RB Offset	Channel	Frequency	QPSK	16QAM
25	1.4 MHz	1	0	26047	1850.7	24.1	23.0
				26365	1882.5	24.6	23.4
				26683	1914.3	24.7	23.4
			3	26047	1850.7	24.4	23.1
				26365	1882.5	24.6	23.5
				26683	1914.3	24.4	23.5
		5	26047	1850.7	24.1	23.1	
			26365	1882.5	24.7	23.6	
			26683	1914.3	24.3	23.6	
		3	0	26047	1850.7	24.3	23.4
				26365	1882.5	24.5	23.1
				26683	1914.3	24.6	23.6
			1	26047	1850.7	24.3	23.7
				26365	1882.5	24.7	23.4
				26683	1914.3	24.6	23.5
			3	26047	1850.7	24.3	23.6
				26365	1882.5	24.5	23.3
				26683	1914.3	24.2	23.6
	6	0	26047	1850.7	23.7	22.0	
			26365	1882.5	23.6	22.1	
			26683	1914.3	23.3	22.7	
	3 MHz	1	0	26055	1851.5	24.5	23.2
				26365	1882.5	24.4	23.0
				26675	1913.5	24.1	23.2
			7	26055	1851.5	24.6	23.4
				26365	1882.5	24.3	23.0
				26675	1913.5	24.0	23.3
			14	26055	1851.5	24.4	23.6
				26365	1882.5	24.2	23.5
				26675	1913.5	24.3	23.3
		8	0	26055	1851.5	23.0	22.6
				26365	1882.5	23.5	22.4
				26675	1913.5	23.3	22.4
			7	26055	1851.5	23.3	22.2
				26365	1882.5	23.1	22.7
				26675	1913.5	23.6	22.6
		14	26055	1851.5	23.1	22.7	
			26365	1882.5	23.2	22.1	
			26675	1913.5	23.5	22.0	
		15	0	26055	1851.5	23.6	22.4
				26365	1882.5	23.3	22.4
				26675	1913.5	23.3	22.6

Band	Bandwidth	RB Size	RB Offset	Channel	Frequency	QPSK	16QAM		
25	5 MHz	1	0	26065	1852.5	24.5	23.1		
				26365	1882.5	24.7	23.5		
				26665	1912.5	24.1	23.2		
			12	12	26065	1852.5	24.3	23.6	
					26365	1882.5	24.2	23.1	
					26665	1912.5	24.4	23.3	
				24	26065	1852.5	24.5	23.3	
					26365	1882.5	24.1	23.1	
					26665	1912.5	24.4	23.5	
		12	0	26065	1852.5	23.6	22.1		
				26365	1882.5	23.7	22.0		
				26665	1912.5	23.5	22.3		
			6	26065	1852.5	23.2	22.0		
				26365	1882.5	23.5	22.1		
				26665	1912.5	23.0	22.1		
				13	26065	1852.5	23.2	22.5	
					26365	1882.5	23.3	22.1	
					26665	1912.5	23.3	22.7	
			25	0	26065	1852.5	23.4	22.5	
					26365	1882.5	23.7	22.6	
					26665	1912.5	23.6	22.2	
			10 MHz	1	0	26090	1855.0	24.7	23.5
						26365	1882.5	24.0	23.1
						26640	1910.0	24.6	23.3
	24	26090			1855.0	24.4	23.1		
		26365			1882.5	24.3	23.3		
		26640			1910.0	24.7	23.3		
		49			26090	1855.0	24.6	23.0	
					26365	1882.5	24.2	23.7	
					26640	1910.0	24.2	23.4	
	25	0			26090	1855.0	23.1	22.1	
					26365	1882.5	23.4	22.5	
					26640	1910.0	23.4	22.2	
		13			26090	1855.0	23.1	22.6	
					26365	1882.5	23.5	22.2	
					26640	1910.0	23.3	22.2	
				25	26090	1855.0	23.1	22.2	
					26365	1882.5	23.6	22.6	
					26640	1910.0	23.3	22.5	
	50	0		26090	1855.0	23.0	22.3		
				26365	1882.5	23.0	22.6		
				26640	1910.0	23.6	22.6		



Band	Bandwidth	RB Size	RB Offset	Channel	Frequency	QPSK	16QAM	
25	15 MHz	1	0	26115	1857.5	24.6	23.4	
				26365	1882.5	24.6	23.5	
				26615	1907.5	24.6	23.4	
			37	26115	1857.5	24.1	23.3	
				26365	1882.5	24.4	23.7	
				26615	1907.5	24.3	23.4	
			74	26115	1857.5	24.3	23.7	
				26365	1882.5	24.2	23.6	
				26615	1907.5	24.1	23.4	
		36	0	26115	1857.5	23.5	22.5	
				26365	1882.5	23.1	22.6	
				26615	1907.5	23.3	22.2	
			19	26115	1857.5	23.3	22.2	
				26365	1882.5	23.4	22.2	
				26615	1907.5	23.6	22.4	
			39	26115	1857.5	23.2	22.1	
				26365	1882.5	23.4	22.2	
				26615	1907.5	23.1	22.2	
		75	0	26115	1857.5	23.6	22.3	
				26365	1882.5	23.7	22.2	
				26615	1907.5	23.4	22.4	
		20 MHz	1	0	26140	1860.0	24.4	23.3
					26365	1882.5	24.3	23.5
					26590	1905.0	24.2	23.4
	49			26140	1860.0	24.5	23.5	
				26365	1882.5	24.7	23.1	
				26590	1905.0	24.4	23.1	
	99			26140	1860.0	24.1	23.4	
				26365	1882.5	24.4	23.6	
				26590	1905.0	24.3	23.1	
	50			0	26140	1860.0	23.6	22.1
					26365	1882.5	23.5	22.6
					26590	1905.0	23.3	22.1
				24	26140	1860.0	23.4	22.1
					26365	1882.5	23.5	22.1
					26590	1905.0	23.0	22.1
			50	26140	1860.0	23.6	22.1	
				26365	1882.5	23.4	22.1	
				26590	1905.0	23.1	22.4	
	100		0	26140	1860.0	23.5	22.5	
				26365	1882.5	23.1	22.6	
				26590	1905.0	23.6	22.2	

Band	Bandwidth	RB Size	RB Offset	Channel	Frequency	QPSK	16QAM		
26	1.4 MHz	1	0	26697	814.7	24.6	23.2		
				26865	831.5	24.2	23.6		
				27033	848.3	24.3	23.5		
			3	26697	814.7	24.5	23.6		
				26865	831.5	24.5	23.3		
				27033	848.3	24.2	23.5		
			5	26697	814.7	24.0	23.5		
				26865	831.5	24.4	23.7		
				27033	848.3	24.6	23.2		
		3	0	26697	814.7	24.5	23.5		
				26865	831.5	24.2	23.6		
				27033	848.3	24.4	23.6		
			1	26697	814.7	24.6	23.7		
				26865	831.5	24.4	23.6		
				27033	848.3	24.1	23.1		
			3	26697	814.7	24.2	23.5		
				26865	831.5	24.7	23.3		
				27033	848.3	24.6	23.2		
	6	0	26697	814.7	23.3	22.2			
			26865	831.5	23.5	22.3			
			27033	848.3	23.0	22.1			
	3 MHz	1	0	26705	815.5	24.2	23.2		
				26865	831.5	24.2	23.7		
				27025	847.5	24.5	23.1		
				7	26705	815.5	24.0	23.6	
					26865	831.5	24.6	23.2	
					27025	847.5	24.5	23.6	
			14	26705	815.5	24.2	23.3		
				26865	831.5	24.6	23.6		
				27025	847.5	24.7	23.6		
				8	0	26705	815.5	23.1	22.4
						26865	831.5	23.3	22.2
						27025	847.5	23.3	22.6
			7		26705	815.5	23.3	22.6	
					26865	831.5	23.6	22.0	
					27025	847.5	23.1	22.2	
			14	26705	815.5	23.6	22.4		
				26865	831.5	23.5	22.5		
				27025	847.5	23.3	22.3		
		15		0	26705	815.5	23.4	22.4	
					26865	831.5	23.2	22.5	
					27025	847.5	23.1	22.5	

Band	Bandwidth	RB Size	RB Offset	Channel	Frequency	QPSK	16QAM		
26	5 MHz	1	0	26715	816.5	24.4	23.6		
				26865	831.5	24.1	23.5		
				27015	846.5	24.3	23.7		
			12	12	26715	816.5	24.2	23.3	
					26865	831.5	24.5	23.2	
					27015	846.5	24.6	23.5	
				24	26715	816.5	24.7	23.5	
					26865	831.5	24.1	23.2	
					27015	846.5	24.6	23.6	
		12	0	26715	816.5	23.6	22.5		
				26865	831.5	23.1	22.5		
				27015	846.5	23.5	22.2		
			6	26715	816.5	23.4	22.1		
				26865	831.5	23.4	22.6		
				27015	846.5	23.6	22.6		
				13	26715	816.5	23.7	22.6	
					26865	831.5	23.2	22.6	
					27015	846.5	23.0	22.3	
			25	0	26715	816.5	23.1	22.6	
					26865	831.5	23.1	22.6	
					27015	846.5	23.0	22.4	
		10 MHz	1	0	26740	819.0	24.6	23.5	
					26865	831.5	24.4	23.4	
					26990	844.0	24.4	23.5	
	24				26740	819.0	24.2	23.6	
					26865	831.5	24.7	23.3	
					26990	844.0	24.3	23.1	
	49			26740	819.0	24.4	23.6		
				26865	831.5	24.1	23.7		
				26990	844.0	24.5	23.3		
				25	0	26740	819.0	23.6	22.4
						26865	831.5	23.5	22.4
						26990	844.0	23.6	22.6
	13					26740	819.0	23.6	22.6
						26865	831.5	23.5	22.3
						26990	844.0	23.2	22.5
	25				26740	819.0	23.4	22.1	
					26865	831.5	23.2	22.5	
					26990	844.0	23.1	22.0	
			50		0	26740	819.0	23.2	22.5
						26865	831.5	23.2	22.1
						26990	844.0	23.7	22.1

Band	Bandwidth	RB Size	RB Offset	Channel	Frequency	QPSK	16QAM
26	15 MHz	1	0	26765	821.5	24.3	23.6
				26865	831.5	24.2	23.5
				26965	841.5	24.5	23.0
			37	26765	821.5	24.6	23.2
				26865	831.5	24.5	23.2
				26965	841.5	24.6	23.6
			74	26765	821.5	24.2	23.1
				26865	831.5	24.4	23.2
				26965	841.5	24.4	23.5
		36	0	26765	821.5	23.2	22.2
				26865	831.5	23.3	22.4
				26965	841.5	23.5	22.6
			19	26765	821.5	23.3	22.1
				26865	831.5	23.0	22.5
				26965	841.5	23.3	22.4
			39	26765	821.5	23.2	22.1
				26865	831.5	23.3	22.0
				26965	841.5	23.6	22.1
		75	0	26765	821.5	23.1	22.4
				26865	831.5	23.1	22.3
				26965	841.5	23.7	22.4

Band	Bandwidth	RB Size	RB Offset	Channel	Frequency	QPSK	16QAM		
38	5 MHz	1	0	37775	2572.5	24.2	23.0		
				38000	2595.0	24.5	23.4		
				38225	2617.5	24.7	23.1		
			12	12	37775	2572.5	24.6	23.4	
					38000	2595.0	24.3	23.6	
					38225	2617.5	24.6	23.2	
				24	37775	2572.5	24.2	23.2	
					38000	2595.0	24.5	23.2	
					38225	2617.5	24.1	23.4	
		12	0	37775	2572.5	23.2	22.1		
				38000	2595.0	23.5	22.6		
				38225	2617.5	23.4	22.0		
			6	37775	2572.5	23.7	22.3		
					38000	2595.0	23.2	22.4	
					38225	2617.5	23.7	22.4	
				13	37775	2572.5	23.7	22.0	
					38000	2595.0	23.3	22.5	
					38225	2617.5	23.4	22.0	
			25	0	37775	2572.5	23.1	22.5	
					38000	2595.0	23.6	22.4	
					38225	2617.5	23.1	22.3	
		10 MHz	1	0	37800	2575.0	24.4	23.7	
					38000	2595.0	24.0	23.4	
					38200	2615.0	24.4	23.1	
				24	37800	2575.0	24.1	23.4	
						38000	2595.0	24.2	23.3
						38200	2615.0	24.1	23.5
	49				37800	2575.0	24.5	23.2	
					38000	2595.0	24.3	23.6	
					38200	2615.0	24.6	23.6	
	25			0	37800	2575.0	23.2	22.4	
					38000	2595.0	23.2	22.6	
					38200	2615.0	23.1	22.4	
				13	37800	2575.0	23.2	22.6	
						38000	2595.0	23.4	22.6
						38200	2615.0	23.3	22.3
			25		37800	2575.0	23.4	22.1	
					38000	2595.0	23.1	22.3	
					38200	2615.0	23.0	22.2	
	50		0	37800	2575.0	23.2	22.3		
				38000	2595.0	23.2	22.2		
				38200	2615.0	23.3	22.4		

Band	Bandwidth	RB Size	RB Offset	Channel	Frequency	QPSK	16QAM	
38	15 MHz	1	0	37825	2577.5	24.4	23.6	
				38000	2595.0	24.1	23.3	
				38175	2612.5	24.0	23.6	
			37	37825	2577.5	24.3	23.6	
				38000	2595.0	24.2	23.2	
				38175	2612.5	24.2	23.2	
				74	37825	2577.5	24.2	23.1
					38000	2595.0	24.4	23.6
					38175	2612.5	24.3	23.1
		36	0	37825	2577.5	23.4	22.2	
				38000	2595.0	23.0	22.5	
				38175	2612.5	23.1	22.2	
			19	37825	2577.5	23.4	22.6	
				38000	2595.0	23.2	22.2	
				38175	2612.5	23.2	22.3	
				39	37825	2577.5	23.4	22.1
					38000	2595.0	23.3	22.2
					38175	2612.5	23.7	22.7
			75	0	37825	2577.5	23.3	22.6
					38000	2595.0	23.2	22.2
					38175	2612.5	23.3	22.5
		20 MHz	1	0	37850	2580.0	24.4	23.5
					38000	2595.0	24.4	23.5
					38150	2610.0	24.5	23.1
	49			37850	2580.0	24.4	23.2	
				38000	2595.0	24.3	23.4	
				38150	2610.0	24.2	23.1	
				99	37850	2580.0	24.2	23.0
					38000	2595.0	24.0	23.5
					38150	2610.0	24.3	23.1
	50			0	37850	2580.0	23.5	22.3
					38000	2595.0	23.2	22.7
					38150	2610.0	23.6	22.4
				24	37850	2580.0	23.5	22.4
					38000	2595.0	23.4	22.5
					38150	2610.0	23.2	22.2
			50		37850	2580.0	23.5	22.4
					38000	2595.0	23.4	22.2
					38150	2610.0	23.3	22.5
	100		0	37850	2580.0	23.4	22.5	
				38000	2595.0	23.6	22.4	
				38150	2610.0	23.4	22.6	

Band	Bandwidth	RB Size	RB Offset	Channel	Frequency	QPSK	16QAM
41	5 MHz	1	0	39675	2498.5	24.1	23.2
				40148	2545.8	24.6	23.6
				40620	2593.0	24.6	23.3
				41093	2640.3	24.7	23.4
				41565	2687.5	24.1	23.3
			12	39675	2498.5	24.4	23.5
				40148	2545.8	24.3	23.6
				40620	2593.0	24.1	23.5
				41093	2640.3	24.5	23.6
				41565	2687.5	24.3	23.5
			24	39675	2498.5	24.2	23.4
				40148	2545.8	24.6	23.3
		40620		2593.0	24.2	23.5	
		41093		2640.3	24.1	23.1	
		41565		2687.5	24.4	23.4	
		12	0	39675	2498.5	23.1	22.0
				40148	2545.8	23.4	22.7
				40620	2593.0	23.6	22.1
				41093	2640.3	23.6	22.6
				41565	2687.5	23.2	22.5
			6	39675	2498.5	23.4	22.1
				40148	2545.8	23.2	22.7
				40620	2593.0	23.5	22.6
				41093	2640.3	23.6	22.2
			13	41565	2687.5	23.1	22.3
				39675	2498.5	23.3	22.6
				40148	2545.8	23.1	22.1
		40620		2593.0	23.4	22.1	
		25	0	41093	2640.3	23.6	22.1
				41565	2687.5	23.2	22.2
				39675	2498.5	23.7	22.1
				40148	2545.8	23.5	22.3
				40620	2593.0	23.3	22.5
		0	41093	2640.3	23.0	22.1	
			41565	2687.5	23.4	22.5	

Band	Bandwidth	RB Size	RB Offset	Channel	Frequency	QPSK	16QAM
41	10 MHz	1	0	39700	2501.0	24.1	23.4
				40160	2547.0	24.6	23.3
				40620	2593.0	24.3	23.1
				41080	2639.0	24.4	23.1
				41540	2685.0	24.3	23.1
			24	39700	2501.0	24.0	23.0
				40160	2547.0	24.0	23.6
				40620	2593.0	24.3	23.6
				41080	2639.0	24.2	23.4
				41540	2685.0	24.2	23.3
			49	39700	2501.0	24.0	23.1
				40160	2547.0	24.1	23.1
		40620		2593.0	24.2	23.7	
		41080		2639.0	24.6	23.5	
		41540		2685.0	24.2	23.7	
		25	0	39700	2501.0	23.2	22.3
				40160	2547.0	23.5	22.3
				40620	2593.0	23.3	22.2
				41080	2639.0	23.4	22.1
				41540	2685.0	23.5	22.5
			13	39700	2501.0	23.4	22.7
				40160	2547.0	23.2	22.5
				40620	2593.0	23.4	22.2
				41080	2639.0	23.3	22.1
			25	41540	2685.0	23.1	22.2
				39700	2501.0	23.2	22.0
				40160	2547.0	23.6	22.7
		40620		2593.0	23.5	22.7	
		41080		2639.0	23.0	22.5	
		50	0	41540	2685.0	23.1	22.5
				39700	2501.0	23.1	22.3
				40160	2547.0	23.6	22.3
40620	2593.0			23.7	22.0		
41080	2639.0			23.3	22.3		
				41540	2685.0	23.5	22.2



Band	Bandwidth	RB Size	RB Offset	Channel	Frequency	QPSK	16QAM
41	15 MHz	1	0	39725	2503.5	24.7	23.7
				40173	2548.3	24.0	23.7
				40620	2593.0	24.4	23.1
				41068	2637.8	24.6	23.1
				41515	2682.5	24.6	23.6
			37	39725	2503.5	24.5	23.6
				40173	2548.3	24.2	23.3
				40620	2593.0	24.1	23.4
				41068	2637.8	24.0	23.5
				41515	2682.5	24.1	23.3
			74	39725	2503.5	24.7	23.2
				40173	2548.3	24.6	23.6
		40620		2593.0	24.3	23.4	
		41068		2637.8	24.0	23.5	
		41515		2682.5	24.5	23.5	
		36	0	39725	2503.5	23.0	22.5
				40173	2548.3	23.6	22.4
				40620	2593.0	23.1	22.3
				41068	2637.8	23.7	22.6
				41515	2682.5	23.6	22.4
			19	39725	2503.5	23.6	22.4
				40173	2548.3	23.2	22.1
				40620	2593.0	23.0	22.1
				41068	2637.8	23.5	22.4
			39	41515	2682.5	23.1	22.1
				39725	2503.5	23.4	22.5
				40173	2548.3	23.4	22.5
		40620		2593.0	23.4	22.2	
		41068		2637.8	23.3	22.2	
		75	0	41515	2682.5	23.1	22.0
				39725	2503.5	23.4	22.5
				40173	2548.3	23.5	22.2
40620	2593.0			23.6	22.6		
41068	2637.8			23.1	22.6		

Band	Bandwidth	RB Size	RB Offset	Channel	Frequency	QPSK	16QAM
41	20 MHz	1	0	39750	2506.0	24.3	23.6
				40185	2549.5	24.6	23.0
				40620	2593.0	24.3	23.3
				41055	2636.5	24.2	23.1
				41490	2680.0	24.6	23.4
			49	39750	2506.0	24.5	23.7
				40185	2549.5	24.1	23.5
				40620	2593.0	24.1	23.6
				41055	2636.5	24.6	23.1
				41490	2680.0	24.3	23.5
			99	39750	2506.0	24.1	23.4
				40185	2549.5	24.2	23.5
		40620		2593.0	24.6	23.4	
		41055		2636.5	24.6	23.5	
		41490		2680.0	24.1	23.4	
		50	0	39750	2506.0	23.4	22.1
				40185	2549.5	23.5	22.1
				40620	2593.0	23.6	22.4
				41055	2636.5	23.3	22.5
				41490	2680.0	23.6	22.6
			24	39750	2506.0	23.1	22.5
				40185	2549.5	23.2	22.7
				40620	2593.0	23.4	22.2
				41055	2636.5	23.1	22.3
				41490	2680.0	23.2	22.6
			50	39750	2506.0	23.3	22.2
				40185	2549.5	23.2	22.1
		40620		2593.0	23.6	22.3	
		41055		2636.5	23.1	22.4	
		41490		2680.0	23.1	22.6	
		100	0	39750	2506.0	23.5	22.6
				40185	2549.5	23.1	22.4
40620	2593.0			23.4	22.5		
41055	2636.5			23.5	22.2		
41490	2680.0			23.5	22.2		

**Table 9.2 LTE Power Measurements BG772**

Band	Bandwidth	RB Size	RB Offset	Channel	Frequency	QPSK	16QAM
2	1.4 MHz	1	0	18607	1850.7	24.1	23.6
				18900	1880.0	24.5	23.6
				19193	1909.3	24.3	23.1
			3	18607	1850.7	24.3	23.5
				18900	1880.0	24.1	23.4
				19193	1909.3	24.5	23.3
			5	18607	1850.7	24.2	23.7
				18900	1880.0	24.6	23.5
				19193	1909.3	24.2	23.7
		3	0	18607	1850.7	24.4	23.6
				18900	1880.0	24.6	23.6
				19193	1909.3	24.0	23.0
			1	18607	1850.7	24.1	23.1
				18900	1880.0	24.4	23.3
				19193	1909.3	24.2	23.2
			3	18607	1850.7	24.3	23.2
				18900	1880.0	24.3	23.2
				19193	1909.3	24.5	23.1
		6	0	18607	1850.7	23.0	22.6
				18900	1880.0	23.5	22.7
				19193	1909.3	23.4	22.4
4	1.4 MHz	1	0	19957	1710.7	24.0	23.7
				20175	1732.5	24.5	23.3
				20393	1754.3	24.5	23.1
			3	19957	1710.7	24.2	23.1
				20175	1732.5	24.5	23.0
				20393	1754.3	24.1	23.7
			5	19957	1710.7	24.4	23.2
				20175	1732.5	24.0	23.3
				20393	1754.3	24.5	23.2
		3	0	19957	1710.7	24.0	23.5
				20175	1732.5	24.6	23.7
				20393	1754.3	24.5	23.5
			1	19957	1710.7	24.3	23.2
				20175	1732.5	24.0	23.2
				20393	1754.3	24.4	23.5
			3	19957	1710.7	24.1	23.2
				20175	1732.5	24.0	23.1
				20393	1754.3	24.2	23.2
		6	0	19957	1710.7	23.6	22.3
				20175	1732.5	23.3	22.5
				20393	1754.3	23.0	22.6

Band	Bandwidth	RB Size	RB Offset	Channel	Frequency	QPSK	16QAM		
5	1.4 MHz	1	0	20407	824.7	24.2	23.7		
				20525	836.5	24.1	23.3		
				20643	848.3	24.1	23.3		
			3	20407	824.7	24.1	23.2		
				20525	836.5	24.0	23.3		
				20643	848.3	24.1	23.3		
			5	20407	824.7	24.5	23.6		
				20525	836.5	24.4	23.3		
				20643	848.3	24.5	23.1		
		3	0	20407	824.7	24.6	23.2		
				20525	836.5	24.5	23.4		
				20643	848.3	24.3	23.1		
			1	20407	824.7	24.3	23.2		
				20525	836.5	24.4	23.4		
				20643	848.3	24.3	23.1		
			3	20407	824.7	24.3	23.5		
				20525	836.5	24.5	23.4		
				20643	848.3	24.5	23.3		
		6	0	20407	824.7	23.3	22.1		
				20525	836.5	23.3	22.1		
				20643	848.3	23.6	22.5		
		12	1.4 MHz	1	0	23017	699.7	24.3	23.3
						23095	707.5	24.3	23.3
						23173	715.3	24.6	23.4
3	23017				699.7	24.2	23.3		
	23095				707.5	24.0	23.3		
	23173				715.3	24.5	23.2		
5	23017				699.7	24.4	23.5		
	23095				707.5	24.6	23.5		
	23173				715.3	24.6	23.2		
3	0			23017	699.7	24.7	23.3		
				23095	707.5	24.4	23.3		
				23173	715.3	24.2	23.2		
	1			23017	699.7	24.2	23.5		
				23095	707.5	24.5	23.2		
				23173	715.3	24.7	23.6		
	3			23017	699.7	24.4	23.3		
				23095	707.5	24.3	23.4		
				23173	715.3	24.7	23.5		
6	0			23017	699.7	23.6	22.1		
				23095	707.5	23.7	22.3		
				23173	715.3	23.1	22.2		

Band	Bandwidth	RB Size	RB Offset	Channel	Frequency	QPSK	16QAM		
13	1.4 MHz	1	0	23187	777.7	24.1	23.5		
				23230	782.0	24.5	23.1		
				23273	786.3	24.4	23.2		
			3	23187	777.7	24.5	23.6		
				23230	782.0	24.5	23.3		
				23273	786.3	24.6	23.3		
			5	23187	777.7	24.4	23.5		
				23230	782.0	24.5	23.4		
				23273	786.3	24.1	23.3		
		3	0	23187	777.7	24.6	23.5		
				23230	782.0	24.5	23.4		
				23273	786.3	24.3	23.2		
			1	23187	777.7	24.4	23.5		
				23230	782.0	24.2	23.6		
				23273	786.3	24.5	23.0		
			3	23187	777.7	24.2	23.6		
				23230	782.0	24.1	23.7		
				23273	786.3	24.6	23.3		
		6	0	23187	777.7	23.7	22.4		
				23230	782.0	23.3	22.2		
				23273	786.3	23.1	22.4		
		25	1.4 MHz	1	0	26047	1850.7	24.4	23.5
						26365	1882.5	24.6	23.2
						26683	1914.3	24.5	23.1
3	26047				1850.7	24.3	23.1		
	26365				1882.5	24.3	23.3		
	26683				1914.3	24.4	23.7		
5	26047				1850.7	24.4	23.5		
	26365				1882.5	24.6	23.7		
	26683				1914.3	24.5	23.1		
3	0			26047	1850.7	24.4	23.4		
				26365	1882.5	24.3	23.2		
				26683	1914.3	24.6	23.6		
	1			26047	1850.7	24.4	23.3		
				26365	1882.5	24.7	23.3		
				26683	1914.3	24.3	23.0		
	3			26047	1850.7	24.7	23.4		
				26365	1882.5	24.4	23.3		
				26683	1914.3	24.4	23.6		
6	0			26047	1850.7	23.7	22.4		
				26365	1882.5	23.0	22.4		
				26683	1914.3	23.4	22.2		

Band	Bandwidth	RB Size	RB Offset	Channel	Frequency	QPSK	16QAM
26	1.4 MHz	1	0	26697	814.7	24.6	23.3
				26865	831.5	24.5	23.7
				27033	848.3	24.4	23.7
			3	26697	814.7	24.4	23.2
				26865	831.5	24.4	23.6
				27033	848.3	24.3	23.5
			5	26697	814.7	24.4	23.3
				26865	831.5	24.5	23.0
				27033	848.3	24.1	23.0
		3	0	26697	814.7	24.2	23.1
				26865	831.5	24.5	23.4
				27033	848.3	24.1	23.6
			1	26697	814.7	24.4	23.6
				26865	831.5	24.4	23.0
				27033	848.3	24.6	23.2
			3	26697	814.7	24.2	23.0
				26865	831.5	24.3	23.3
				27033	848.3	24.3	23.6
		6	0	26697	814.7	23.2	22.1
				26865	831.5	23.3	22.4
				27033	848.3	23.5	22.1
27	1.4 MHz	1	0	27047	807.7	24.4	23.4
				27125	815.5	24.4	23.4
				27203	823.3	24.4	23.6
			3	27047	807.7	24.2	23.4
				27125	815.5	24.1	23.2
				27203	823.3	24.4	23.1
			5	27047	807.7	24.4	23.4
				27125	815.5	24.3	23.1
				27203	823.3	24.4	23.3
		3	0	27047	807.7	24.5	23.7
				27125	815.5	24.6	23.0
				27203	823.3	24.1	23.3
			1	27047	807.7	24.2	23.1
				27125	815.5	24.1	23.2
				27203	823.3	24.5	23.0
			3	27047	807.7	24.5	23.1
				27125	815.5	24.3	23.0
				27203	823.3	24.0	23.2
6	0	27047	807.7	23.3	22.0		
		27125	815.5	23.5	22.2		
		27203	823.3	23.3	22.2		

Band	Bandwidth	RB Size	RB Offset	Channel	Frequency	QPSK	16QAM
66	1.4 MHz	1	0	131979	1710.7	24.7	23.0
				132322	1745.0	24.3	23.7
				132665	1779.3	24.5	23.2
			3	131979	1710.7	24.1	23.3
				132322	1745.0	24.5	23.1
				132665	1779.3	24.5	23.6
			5	131979	1710.7	24.3	23.1
				132322	1745.0	24.4	23.1
				132665	1779.3	24.6	23.1
		3	0	131979	1710.7	24.1	23.6
				132322	1745.0	24.6	23.7
				132665	1779.3	24.5	23.5
			1	131979	1710.7	24.2	23.4
				132322	1745.0	24.3	23.6
				132665	1779.3	24.7	23.7
			3	131979	1710.7	24.4	23.3
				132322	1745.0	24.4	23.1
				132665	1779.3	24.7	23.3
		6	0	131979	1710.7	23.1	22.7
				132322	1745.0	23.4	22.3
				132665	1779.3	23.5	22.4

## 10. SAR Test Results

### General Note:

1. Per KDB 447498 D01v06, the reported SAR is the measured SAR value adjusted for maximum tune-up tolerance.
  - a. Tune-up scaling Factor = tune-up limit power (mW) / EUT RF power (mW), where tune-up limit is the maximum rated power among all production units.
  - b. For SAR testing of WLAN signal with non-100% duty cycle, the measured SAR is scaled-up by the duty cycle scaling factor which is equal to "1/(duty cycle)"
  - c. For WWAN: Reported SAR(W/kg)= Measured SAR(W/kg)\*Tune-up Scaling Factor
  - d. For TDD LTE SAR measurement, the duty cycle 1:1.59 (62.9 %) was used perform testing and considering the theoretical duty cycle of 63.3% for extended cyclic prefix in the uplink, and the theoretical duty cycle of 62.9% for normal cyclic prefix in uplink, a scaling factor of extended cyclic prefix  $63.3\%/62.9\% = 1.006$  is applied to scale-up the measured SAR result. The Reported TDD LTE SAR = measured SAR (W/kg)\* Tune-up Scaling Factor\* scaling factor for extended cyclic prefix.
2. Per KDB 447498 D01v06, for each exposure position, testing of other required channels within the operating mode of a frequency band is not required when the reported 1-g or 10-g SAR for the mid-band or highest output power channel is:
  - $\leq 0.8$  W/kg or 2.0 W/kg, for 1-g or 10-g respectively, when the transmission band is  $\leq 100$  MHz
  - $\leq 0.6$  W/kg or 1.5 W/kg, for 1-g or 10-g respectively, when the transmission band is between 100 MHz and 200 MHz
  - $\leq 0.4$  W/kg or 1.0 W/kg, for 1-g or 10-g respectively, when the transmission band is  $\geq 200$  MHz
3. Per KDB 865664 D01v01r04, for each frequency band, repeated SAR measurement is required only when the measured SAR is  $\geq 0.8$ W/kg.

### UMTS Note:

1. Per KDB 941225 D01v03r01, for SAR testing is measured using a 12.2 kbps RMC with TPC bits configured to all "1's".
2. Per KDB 941225 D01v03r01, RMC 12.2kbps setting is used to evaluate SAR. The maximum output power and tune-up tolerance specified for production units in HSDPA / HSUPA / DC-HSDPA is  $\leq \frac{1}{4}$  dB higher than RMC 12.2Kbps or when the highest reported SAR of the RMC12.2Kbps is scaled by the ratio of specified maximum output power and tune-up tolerance of HSDPA / HSUPA / DC-HSDPA to RMC12.2Kbps and the adjusted SAR is  $\leq 1.2$  W/kg, SAR measurement is not required for HSDPA / HSUPA / DC-HSDPA, and according to the following RF output power, the output power results of the secondary modes (HSUPA, HSDPA, DC-HSDPA) are less than  $\frac{1}{4}$  dB higher than the primary modes; therefore, SAR measurement is not required for HSDPA / HSUPA / DC-HSDPA.

### LTE Note:

1. Per KDB 941225 D05v02r05, start with the largest channel bandwidth and measure SAR for QPSK with 1 RB allocation, using the RB offset and required test channel combination with the highest maximum output power for RB offsets at the upper edge, middle and lower edge of each required test channel.
2. Per KDB 941225 D05v02r05, 50% RB allocation for QPSK SAR testing follows 1RB QPSK allocation procedure.
3. Per KDB 941225 D05v02r05, For QPSK with 100% RB allocation, SAR is not required when the highest maximum output power for 100 % RB allocation is less than the highest maximum output power in 50% and 1 RB allocations and the highest reported SAR for 1 RB and 50% RB allocation are  $\leq 0.8$  W/kg. Otherwise, SAR is measured for the highest output power channel; and if the reported SAR is  $> 1.45$  W/kg, the remaining required test channels must also be tested.
4. Per KDB 941225 D05v02r05, 16QAM output power for each RB allocation configuration is  $> \text{not } \frac{1}{2}$  dB higher than the same configuration in QPSK and the reported SAR for the QPSK configuration is  $\leq 1.45$  W/kg; Per KDB 941225 D05v02r05, 16QAM SAR testing is not required.
5. Per KDB 941225 D05v02r05, Smaller bandwidth output power for each RB allocation configuration is  $> \text{not } \frac{1}{2}$  dB higher than the same configuration in the largest supported bandwidth, and the reported SAR for the largest supported bandwidth is  $\leq 1.45$  W/kg; Per KDB 941225 D05v02r05, smaller bandwidth SAR testing is not required.
6. LTE band 2/5/38 SAR test was covered by Band 25/26/41 for EG21-G and LTE band 2/4/5 SAR test was covered by band 25/26/66 for BG77 according to TCB workshop, SAR test for overlapping LTE bands can be reduced if
  - a. The maximum output power, including tolerance, for the smaller band is  $\leq$  the larger band to qualify for the SAR test exclusion.
  - b. The channel bandwidth and other operating parameters for the smaller band are fully supported by the larger band.
7. For LTE B13 the maximum bandwidth does not support three non-overlapping channels, per KDB 941225 D05v02r05, when a device supports overlapping channel assignment in a channel bandwidth configuration, the middle channel of the group of overlapping channels should be selected for testing.



Plot No.	Band	Mode	Test Position	Gap (mm)	Ch.	Freq. (MHz)	Average Power (dBm)	Tune-Up Limit (dBm)	Measured 1g SAR (W/kg)	Reported 1g SAR (W/kg)
1	WCDMA II	RMC 12.2Kbps	Front	50mm	9262	1852.4	24.83	25.00	0.0865	0.09
	WCDMA II	RMC 12.2Kbps		50mm	9400	1880	24.79	25.00	0.104	0.11
	WCDMA II	RMC 12.2Kbps		50mm	9538	1907.6	24.95	25.00	0.0916	0.09
2	WCDMA IV	RMC 12.2Kbps	Front	50mm	1312	1712.4	24.61	25.00	0.0269	0.03
	WCDMA IV	RMC 12.2Kbps		50mm	1413	1732.6	24.76	25.00	0.0487	0.05
	WCDMA IV	RMC 12.2Kbps		50mm	1513	1752.6	24.51	25.00	0.0358	0.04
3	WCDMA V	RMC 12.2Kbps	Front	50mm	4132	826.4	24.63	25.00	0.0985	0.11
	WCDMA V	RMC 12.2Kbps		50mm	4183	836.6	24.88	25.00	0.130	0.13
	WCDMA V	RMC 12.2Kbps		50mm	4233	846.6	24.79	25.00	0.101	0.11
4	GPRS II	3 Slot	Front	50mm	512	1850.2	24.04	27.47	0.0421	0.09
	GPRS II	3 Slot		50mm	661	1880	25.84	27.47	0.0557	0.08
	GPRS II	3 Slot		50mm	810	1909.8	26.24	27.47	0.0469	0.06
5	GPRS V	3 Slot	Front	50mm	128	824.2	29.04	30.74	0.0000952	<0.01
	GPRS V	3 Slot		50mm	190	836.6	29.34	30.74	0.000109	<0.01
	GPRS V	3 Slot		50mm	251	848.8	29.14	30.74	0.0000865	<0.01

**Module EG21-G**

Plot No.	Band	BW (MHz)	Modulation	RB Size	RB offset	Test Position	Gap (mm)	Ch.	Freq. (MHz)	Average Power (dBm)	Tune-Up Limit (dBm)	Measured 1g SAR (W/kg)	Reported 1g SAR (W/kg)
	LTE Band 4	20M	QPSK	1	49	Front	50mm	20050	1720	24.2	25.00	0.0367	0.04
	LTE Band 4	20M	QPSK	50	24		50mm	20050	1720	23.3	24.00	0.0287	0.03
6	LTE Band 4	20M	QPSK	1	49		50mm	20175	1732.5	24.5	25.00	0.0439	0.05
	LTE Band 4	20M	QPSK	50	24		50mm	20175	1732.5	23.4	24.00	0.0315	0.04
	LTE Band 4	20M	QPSK	1	49		50mm	20300	1745	24.6	25.00	0.0358	0.04
	LTE Band 4	20M	QPSK	50	24		50mm	20300	1745	23.2	24.00	0.0269	0.03
	LTE Band 7	20M	QPSK	1	49	Front	50mm	20850	2510	24.6	25.00	0.0587	0.06
	LTE Band 7	20M	QPSK	50	24		50mm	20850	2510	23.4	24.00	0.0467	0.05
7	LTE Band 7	20M	QPSK	1	49		50mm	21100	2535	24.5	25.00	0.0641	0.07
	LTE Band 7	20M	QPSK	50	24		50mm	21100	2535	23.5	24.00	0.0502	0.06
	LTE Band 7	20M	QPSK	1	49		50mm	21350	2560	24.3	25.00	0.0564	0.07
	LTE Band 7	20M	QPSK	50	24		50mm	21350	2560	23.6	24.00	0.0438	0.05
	LTE Band 12	10M	QPSK	1	24	Front	50mm	23060	704	24.4	25.00	0.165	0.19
	LTE Band 12	10M	QPSK	25	12		50mm	23060	704	23.5	24.00	0.0921	0.10
8	LTE Band 12	10M	QPSK	1	24		50mm	23095	707.5	24.3	25.00	0.189	0.22
	LTE Band 12	10M	QPSK	25	12		50mm	23095	707.5	23.7	24.00	0.0956	0.10
	LTE Band 12	10M	QPSK	1	24		50mm	23129	711	24.6	25.00	0.170	0.19
	LTE Band 12	10M	QPSK	25	12		50mm	23129	711	23.6	24.00	0.0896	0.10
	LTE Band 13	10M	QPSK	1	24	Front	50mm	23230	782	24.4	25.00	0.0712	0.08
	LTE Band 13	10M	QPSK	25	12		50mm	23230	782	23.3	24.00	0.0603	0.07
	LTE Band 25	20M	QPSK	1	49	Front	50mm	26140	1860	24.5	25.00	0.0826	0.09
	LTE Band 25	20M	QPSK	50	24		50mm	26140	1860	23.4	24.00	0.0785	0.09
10	LTE Band 25	20M	QPSK	1	49		50mm	26365	1882.5	24.7	25.00	0.0944	0.10
	LTE Band 25	20M	QPSK	50	24		50mm	26365	1882.5	23.5	24.00	0.0811	0.09
	LTE Band 25	20M	QPSK	1	49		50mm	26590	1905	24.4	25.00	0.0832	0.10
	LTE Band 25	20M	QPSK	50	24		50mm	26590	1905	23.0	24.00	0.0763	0.10
	LTE Band 26	15M	QPSK	1	37	Front	50mm	26765	821.5	24.6	25.00	0.101	0.11
	LTE Band 26	15M	QPSK	36	19		50mm	26765	821.5	23.3	24.00	0.0903	0.11
11	LTE Band 26	15M	QPSK	1	37		50mm	26865	831.5	24.5	25.00	0.147	0.16
	LTE Band 26	15M	QPSK	36	19		50mm	26865	831.5	23.0	24.00	0.0952	0.12
	LTE Band 26	15M	QPSK	1	37		50mm	26965	841.5	24.6	25.00	0.0965	0.11
	LTE Band 26	15M	QPSK	36	19		50mm	26965	841.5	23.3	24.00	0.0911	0.11
	LTE Band 41	20M	QPSK	1	49	Front	50mm	39750	2506	24.5	25.00	0.0185	0.02
	LTE Band 41	20M	QPSK	50	24		50mm	39750	2506	23.1	24.00	0.0121	0.01
12	LTE Band 41	20M	QPSK	1	49		50mm	40620	2593	24.1	25.00	0.0261	0.03
	LTE Band 41	20M	QPSK	50	24		50mm	40620	2593	23.4	24.00	0.0159	0.02
	LTE Band 41	20M	QPSK	1	49		50mm	41490	2680	24.3	25.00	0.0169	0.02
	LTE Band 41	20M	QPSK	50	24		50mm	41490	2680	23.2	24.00	0.0106	0.01

**Module EG21-G**

Plot No.	Band	BW (MHz)	Modulation	RB Size	RB offset	Test Position	Gap (mm)	Ch.	Freq. (MHz)	Average Power (dBm)	Tune-Up Limit (dBm)	Measured 1g SAR (W/kg)	Reported 1g SAR (W/kg)
	LTE Band 12	1.4M	QPSK	1	3	Front	50mm	23017	699.7	24.1	25.7	0.00258	<0.01
	LTE Band 12	1.4M	QPSK	3	1		50mm	23017	699.7	24.2	25.7	0.00224	<0.01
13	LTE Band 12	1.4M	QPSK	1	3		50mm	23095	707.5	24.0	25.7	0.00328	0.01
	LTE Band 12	1.4M	QPSK	3	1		50mm	23095	707.5	24.5	25.7	0.00302	<0.01
	LTE Band 12	1.4M	QPSK	1	3		50mm	23173	715.3	24.1	25.7	0.00291	<0.01
	LTE Band 12	1.4M	QPSK	3	1		50mm	23173	715.3	24.7	25.7	0.00293	<0.01
	LTE Band 13	1.4M	QPSK	1	3		Front	50mm	23187	777.7	24.5	25.7	0.00468
	LTE Band 13	1.4M	QPSK	3	1	50mm		23187	777.7	24.4	25.7	0.00421	0.01
14	LTE Band 13	1.4M	QPSK	1	3	50mm		23230	782	24.5	25.7	0.00525	0.01
	LTE Band 13	1.4M	QPSK	3	1	50mm		23230	782	24.2	25.7	0.00506	0.01
	LTE Band 13	1.4M	QPSK	1	3	50mm		23273	786.3	24.6	25.7	0.00488	0.01
	LTE Band 13	1.4M	QPSK	3	1	50mm		23273	786.3	24.5	25.7	0.00462	0.01
	LTE Band 25	1.4M	QPSK	1	3	Front		50mm	26047	1850.7	24.3	25.7	0.0105
	LTE Band 25	1.4M	QPSK	3	1		50mm	26047	1850.7	24.4	25.7	0.00994	0.01
15	LTE Band 25	1.4M	QPSK	1	3		50mm	26365	1882.5	24.3	25.7	0.0168	0.02
	LTE Band 25	1.4M	QPSK	3	1		50mm	26365	1882.5	24.7	25.7	0.0155	0.02
	LTE Band 25	1.4M	QPSK	1	3		50mm	26683	1914.3	24.4	25.7	0.0129	0.02
	LTE Band 25	1.4M	QPSK	3	1		50mm	26683	1914.3	24.3	25.7	0.0117	0.02
	LTE Band 26	1.4M	QPSK	1	3		Front	50mm	26697	814.7	24.4	25.7	0.00317
	LTE Band 26	1.4M	QPSK	3	1	50mm		26697	814.7	24.4	25.7	0.00287	<0.01
16	LTE Band 26	1.4M	QPSK	1	3	50mm		26865	831.5	24.4	25.7	0.00370	0.01
	LTE Band 26	1.4M	QPSK	3	1	50mm		26865	831.5	24.4	25.7	0.00296	<0.01
	LTE Band 26	1.4M	QPSK	1	3	50mm		27033	848.3	24.3	25.7	0.00354	0.01
	LTE Band 26	1.4M	QPSK	3	1	50mm		27033	848.3	24.6	25.7	0.00339	<0.01
	LTE Band 27	1.4M	QPSK	1	3	Front		50mm	27047	807.7	24.2	25.7	0.00211
	LTE Band 27	1.4M	QPSK	3	1		50mm	27047	807.7	24.2	25.7	0.00195	<0.01
17	LTE Band 27	1.4M	QPSK	1	3		50mm	27125	815.5	24.1	25.7	0.00268	<0.01
	LTE Band 27	1.4M	QPSK	3	1		50mm	27125	815.5	24.1	25.7	0.00233	<0.01
	LTE Band 27	1.4M	QPSK	1	3		50mm	27203	823.3	24.4	25.7	0.00203	<0.01
	LTE Band 27	1.4M	QPSK	3	1		50mm	27203	823.3	24.5	25.7	0.00187	<0.01
	LTE Band 66	1.4M	QPSK	1	3		Front	50mm	131979	1710.7	24.1	25.7	0.00102
	LTE Band 66	1.4M	QPSK	3	1	50mm		131979	1710.7	24.2	25.7	0.000954	<0.01
18	LTE Band 66	1.4M	QPSK	1	3	50mm		132322	1745	24.5	25.7	0.00126	<0.01
	LTE Band 66	1.4M	QPSK	3	1	50mm		132322	1745	24.3	25.7	0.00115	<0.01
	LTE Band 66	1.4M	QPSK	1	3	50mm		132665	1779.3	24.5	25.7	0.00111	<0.01
	LTE Band 66	1.4M	QPSK	3	1	50mm		132665	1779.3	24.7	25.7	0.00101	<0.01

**Module BG772**

# 11. Simultaneous Transmission Analysis

Sim-Tx configuration

No.	Simultaneous Transmission Configuration	Exposure Positions
		Body
1	EG21-G UMTS + 2.4 GHz Wifi 0	Yes
2	EG21-G UMTS + 5 GHz Wifi 0	Yes
3	EG21-G LTE + 2.4 GHz Wifi 0	Yes
4	EG21-G LTE + 5 GHz Wifi 0	Yes
5	BG772 LTE + 2.4 GHz Wifi 0	Yes
6	BG772 LTE + 5 GHz Wifi 0	Yes

**General Note:**

1. The WLAN SAR calculated value was used for SAR summation due to the WiFi being excluded. See page 25 for the calculated value for each band..
2. The two cellular modules cannot transmit simultaneously.

**Body Exposure Conditions**

WWAN Band	Exposure Position	1	2	3	1+2 Summed 1g SAR (W/kg)	1+3 Summed 1g SAR (W/kg)
		WWAN	2.4GHz Wi-Fi 0	5GHz Wi-Fi 0		
		1g SAR (W/kg)	1g SAR (W/kg)	1g SAR (W/kg)		
GRPS II – EG21-G	Front	0.08	0.36	0.32	0.44	0.40
GPRS V – EG21-G	Front	0.01	0.36	0.32	0.37	0.33
WCDMA II – EG21-G	Front	0.11	0.36	0.32	0.47	0.43
WCDMA IV– EG21-G	Front	0.05	0.36	0.32	0.41	0.37
WCDMA V – EG21-G	Front	0.13	0.36	0.32	0.49	0.45
LTE Band 4 – EG21-G	Front	0.05	0.36	0.32	0.41	0.37
LTE Band 7 – EG21-G	Front	0.07	0.36	0.32	0.43	0.39
LTE Band 12 – EG21-G	Front	0.22	0.36	0.32	0.58	0.54
LTE Band 13 – EG21-G	Front	0.08	0.36	0.32	0.44	0.40
LTE Band 25 – EG21-G	Front	0.10	0.36	0.32	0.46	0.42
LTE Band 26 – EG21-G	Front	0.16	0.36	0.32	0.52	0.48
LTE Band 41 – EG21-G	Front	0.03	0.36	0.32	0.39	0.35
LTE Band 12 – BG772	Front	0.01	0.36	0.32	0.37	0.33
LTE Band 13 – BG772	Front	0.01	0.36	0.32	0.37	0.33
LTE Band 25 – BG772	Front	0.02	0.36	0.32	0.38	0.34
LTE Band 26 – BG772	Front	0.01	0.36	0.32	0.37	0.33
LTE Band 27 – BG772	Front	0.01	0.36	0.32	0.37	0.33
LTE Band 66 – BG772	Front	0.01	0.36	0.32	0.37	0.33

## 12. Test Equipment List

**Table 12.1 Equipment Specifications**

Type	Calibration Due Date	Calibration Done Date	Serial Number
Staubli Robot TX60L	N/A	N/A	F07/55M6A1/A/01
Measurement Controller CS8c	N/A	N/A	1012
ELI5 Flat Phantom	N/A	N/A	2037
Device Holder	N/A	N/A	N/A
Data Acquisition Electronics 4	02/14/2024	02/14/2023	1217
Data Acquisition Electronics 4	04/19/2024	04/19/2023	1416
SPEAG E-Field Probe EX3DV4	02/10/2024	02/10/2023	3662
Speag Validation Dipole D750V2	06/04/2024	06/04/2021	1053
Speag Validation Dipole D900V2	06/04/2024	06/04/2021	1d128
Speag Validation Dipole D1750V2	06/03/2024	06/03/2021	1061
Speag Validation Dipole D1900V2	06/04/2024	06/04/2021	5d147
Speag Validation Dipole D2550V2	06/03/2024	06/03/2021	1003
Agilent N1911A Power Meter	03/14/2024	03/14/2023	GB45100254
Agilent N1922A Power Sensor	03/13/2024	03/13/2023	MY45240464
Agilent (HP) 8596E Spectrum Analyzer	03/13/2024	03/13/2023	3826A01468
Agilent (HP) 83752A Synthesized Sweeper	03/14/2024	03/14/2023	3610A01048
Agilent (HP) 8753C Vector Network Analyzer	03/14/2024	03/14/2023	3135A01724
Agilent (HP) 85047A S-Parameter Test Set	03/14/2024	03/14/2023	2904A00595
Copper Mountain R140 Vector Reflectometer	03/13/2024	03/13/2023	21390004
Anritsu MT8821C	N/A	N/A	6201381721
Aprel Dielectric Probe Assembly	N/A	N/A	0011
Head Equivalent Matter (750 MHz)	N/A	N/A	N/A
Head Equivalent Matter (900 MHz)	N/A	N/A	N/A
Head Equivalent Matter (1750 MHz)	N/A	N/A	N/A
Head Equivalent Matter (1900 MHz)	N/A	N/A	N/A
Head Equivalent Matter (2550 MHz)	N/A	N/A	N/A

### **13. Conclusion**

The SAR measurement indicates that the EUT complies with the RF radiation exposure limits of the IC. These measurements are taken to simulate the RF effects exposure under worst-case conditions. Precise laboratory measures were taken to assure repeatability of the tests. The tested device complies with the requirements in respect to all parameters subject to the test. The test results and statements relate only to the item(s) tested.

Please note that the absorption and distribution of electromagnetic energy in the body is a very complex phenomena that depends on the mass, shape, and size of the body; the orientation of the body with respect to the field vectors; and, the electrical properties of both the body and the environment. Other variables that may play a substantial role in possible biological effects are those that characterize the environment (e.g. ambient temperature, air velocity, relative humidity, and body insulation) and those that characterize the individual (e.g. age, gender, activity level, debilitation, or disease). Because innumerable factors may interact to determine the specific biological outcome of an exposure to electromagnetic fields, any protection guide shall consider maximal amplification of biological effects as a result of field-body interactions, environmental conditions, and physiological variables.

## 14. References

- [1] Federal Communications Commission, ET Docket 93-62, Guidelines for Evaluating the Environmental Effects of Radio Frequency Radiation, August 1996
- [2] ANSI/IEEE C95.1 – 1992, American National Standard Safety Levels with respect to Human Exposure to Radio Frequency Electromagnetic Fields, 300kHz to 100GHz, New York: IEEE, 1992.
- [3] ANSI/IEEE C95.3 – 1992, IEEE Recommended Practice for the Measurement of Potentially Hazardous Electromagnetic Fields – RF and Microwave, New York: IEEE, 1992.
- [4] International Electrotechnical Commission, IEC 62209-2 (Edition 1.0), Human Exposure to radio frequency fields from hand-held and body mounted wireless communication devices – Human models, instrumentation, and procedures – Part 2: Procedure to determine the specific absorption rate (SAR) for wireless communication devices used in close proximity to the human body (frequency range of 30 MHz to 6 GHz), March 2010.
- [5] IEEE Standard 1528 – 2013, IEEE Recommended Practice for Determining the Peak-Spatial Average Specific Absorption Rate (SAR) in the Human Head from Wireless Communication Devices: Measurement Techniques, June 2013.
- [6] Industry Canada, RSS – 102 Issue 5, Radio Frequency Exposure Compliance of Radiocommunication Apparatus (All Frequency Bands), March 2015.
- [7] Health Canada, Safety Code 6, Limits of Human Exposure to Radiofrequency Electromagnetic Fields in the Frequency Range from 3kHz to 300 GHz, 2009.

# Appendix A – System Validation Plots and Data

\*\*\*\*\*  
Test Result for UIM Dielectric Parameter  
Fri 14/Apr/2023  
Freq Frequency(GHz)  
FCC\_eH Limits for Head Epsilon  
FCC\_sH Limits for Head Sigma  
Test\_e Epsilon of UIM  
Test\_s Sigma of UIM  
\*\*\*\*\*

Freq	FCC_eH	FCC_sH	Test_e	Test_s
0.6900	42.25	0.89	41.81	0.86
0.6997	42.202	0.89	41.762	0.86*
0.7000	42.20	0.89	41.76	0.86
0.7040	42.18	0.89	41.732	0.864*
0.7075	42.163	0.89	41.708	0.868*
0.7100	42.15	0.89	41.69	0.87
0.7110	42.145	0.89	41.685	0.871*
0.7153	42.124	0.89	41.664	0.875*
0.7200	42.10	0.89	41.64	0.88
0.7300	42.05	0.89	41.57	0.89
0.7400	41.99	0.89	41.51	0.89
0.7500	41.94	0.89	41.46	0.90
0.7600	41.89	0.89	41.40	0.91
0.7700	41.84	0.89	41.34	0.92
0.7777	41.802	0.898	41.294	0.92*
0.7800	41.79	0.90	41.28	0.92
0.7820	41.778	0.90	41.268	0.922*
0.7863	41.752	0.90	41.242	0.926*
0.7900	41.73	0.90	41.22	0.93
0.8000	41.68	0.90	41.18	0.93

\* value interpolated



\*\*\*\*\*

Test Result for UIM Dielectric Parameter

Fri 14/Apr/2023

Freq Frequency(GHz)

eH Limits for Head Epsilon

sH Limits for Head Sigma

Test\_e Epsilon of UIM

Test\_s Sigma of UIM

\*\*\*\*\*

Freq	eH	sH	Test_e	Test_s
0.8000	41.68	0.90	41.52	0.89
0.8100	41.63	0.90	41.47	0.90
0.8120	41.62	0.90	41.458	0.902*
0.8155	41.603	0.90	41.437	0.906*
0.8190	41.585	0.90	41.416	0.909*
0.8200	41.58	0.90	41.41	0.91
0.8215	41.573	0.90	41.418	0.91*
0.8264	41.548	0.90	41.442	0.91*
0.8300	41.53	0.90	41.46	0.91
0.8315	41.526	0.902	41.456	0.912*
0.8366	41.51	0.907	41.44	0.917*
0.8400	41.50	0.91	41.43	0.92
0.8415	41.50	0.912	41.427	0.922*
0.8466	41.50	0.917	41.417	0.927*
0.8500	41.50	0.92	41.41	0.93
0.8600	41.50	0.93	41.39	0.94
0.8700	41.50	0.94	41.37	0.95
0.8800	41.50	0.95	41.36	0.96
0.8900	41.50	0.96	41.35	0.97
0.9000	41.50	0.97	41.34	0.98
0.9100	41.50	0.98	41.33	0.99
0.9200	41.49	0.98	41.32	0.99

\* value interpolated

\*\*\*\*\*

Test Result for UIM Dielectric Parameter

Sat 15/Apr/2023

Freq Frequency(GHz)

eH Limits for Head Epsilon

sH Limits for Head Sigma

Test\_e Epsilon of UIM

Test\_s Sigma of UIM

\*\*\*\*\*

Freq	eH	sH	Test_e	Test_s
1.7000	40.16	1.34	39.34	1.36
1.7100	40.14	1.35	39.32	1.37
1.7107	40.139	1.35	39.319	1.371*
1.7124	40.138	1.35	39.315	1.372*
1.7200	40.13	1.35	39.30	1.38
1.7300	40.11	1.36	39.28	1.38
1.7325	40.105	1.363	39.275	1.383*
1.7326	40.105	1.363	39.275	1.383*
1.7400	40.09	1.37	39.26	1.39
1.7450	40.085	1.37	39.25	1.395*
1.7500	40.08	1.37	39.24	1.40
1.7526	40.075	1.373	39.235	1.403*
1.7543	40.071	1.374	39.231	1.404*
1.7600	40.06	1.38	39.22	1.41
1.7700	40.05	1.38	39.20	1.42
1.7800	40.03	1.39	39.18	1.42
1.7900	40.02	1.39	39.16	1.43

\* value interpolated

\*\*\*\*\*

Test Result for UIM Dielectric Parameter  
Sat 15/Apr/2023  
Freq Frequency(GHz)  
eH Limits for Head Epsilon  
sH Limits for Head Sigma  
Test\_e Epsilon of UIM  
Test\_s Sigma of UIM

\*\*\*\*\*

Freq	eH	sH	Test_e	Test_s
1.8500	40.00	1.40	39.97	1.37
1.8507	40.00	1.40	39.969	1.371*
1.8524	40.00	1.40	39.65	1.372*
1.8600	40.00	1.40	39.95	1.38
1.8700	40.00	1.40	39.93	1.38
1.8800	40.00	1.40	39.91	1.39
1.8825	40.00	1.40	39.905	1.39*
1.8900	40.00	1.40	39.89	1.39
1.9000	40.00	1.40	39.87	1.39
1.9050	40.00	1.40	39.86	1.395*
1.9076	40.00	1.40	39.855	1.398*
1.9093	40.00	1.40	39.851	1.399*
1.9100	40.00	1.40	39.85	1.40
1.9200	40.00	1.40	39.84	1.41

\* value interpolated

\*\*\*\*\*

Test Result for UIM Dielectric Parameter  
Wed 27/Sep/2023  
Freq Frequency(GHz)  
FCC\_eH Limits for Head Epsilon  
FCC\_sH Limits for Head Sigma  
Test\_e Epsilon of UIM  
Test\_s Sigma of UIM

\*\*\*\*\*

Freq	FCC_eH	FCC_sH	Test_e	Test_s
0.7000	42.20	0.89	41.19	0.88
0.7037	42.182	0.89	41.164	0.884*
0.7040	42.18	0.89	41.162	0.884*
0.7075	42.163	0.89	41.138	0.888*
0.7100	42.15	0.89	41.12	0.89
0.7110	42.145	0.89	41.115	0.891*
0.7130	42.135	0.89	41.105	0.893*
0.7200	42.10	0.89	41.07	0.90
0.7255	42.073	0.89	41.032	0.906*
0.7300	42.05	0.89	41.00	0.91
0.7380	42.002	0.89	40.952	0.91*
0.7400	41.99	0.89	40.94	0.91
0.7473	41.954	0.89	40.904	0.917*
0.7500	41.94	0.89	40.89	0.92
0.7600	41.89	0.89	40.83	0.93
0.7700	41.84	0.89	40.77	0.94
0.7800	41.79	0.90	40.71	0.94
0.7820	41.778	0.90	40.698	0.942*
0.7900	41.73	0.90	40.65	0.95
0.8000	41.68	0.90	40.61	0.95

\* value interpolated

\*\*\*\*\*

Test Result for UIM Dielectric Parameter

Mon 02/Oct/2023

Freq Frequency(GHz)

eH Limits for Head Epsilon

sH Limits for Head Sigma

Test\_e Epsilon of UIM

Test\_s Sigma of UIM

\*\*\*\*\*

Freq	eH	sH	Test_e	Test_s
0.8000	41.68	0.90	41.04	0.91
0.8100	41.63	0.90	40.99	0.92
0.8157	41.602	0.90	40.956	0.926*
0.8200	41.58	0.90	40.93	0.93
0.8215	41.573	0.90	40.938	0.93*
0.8225	41.568	0.90	40.943	0.93*
0.8242	41.559	0.90	40.951	0.93*
0.8264	41.548	0.90	40.962	0.93*
0.8293	41.534	0.90	40.977	0.93*
0.8300	41.53	0.90	40.98	0.93
0.8302	41.529	0.90	40.979	0.93*
0.8315	41.526	0.902	40.976	0.932*
0.8324	41.523	0.902	40.973	0.932*
0.8327	41.522	0.903	40.972	0.933*
0.8366	41.510	0.907	40.960	0.937*
0.8375	41.508	0.908	40.958	0.938*
0.8400	41.50	0.91	40.95	0.94
0.8415	41.50	0.912	40.947	0.942*
0.8420	41.50	0.912	40.946	0.942*
0.8426	41.50	0.913	40.945	0.943*
0.8443	41.50	0.914	40.941	0.944*
0.8466	41.50	0.917	40.937	0.947*
0.8470	41.50	0.917	40.936	0.947*
0.8488	41.50	0.919	40.932	0.949*
0.8500	41.50	0.92	40.93	0.95
0.8520	41.50	0.922	40.926	0.952*
0.8600	41.50	0.93	40.91	0.96
0.8613	41.50	0.931	40.907	0.961*
0.8700	41.50	0.94	40.89	0.97
0.8800	41.50	0.95	40.88	0.98
0.8802	41.50	0.95	40.88	0.98*
0.8807	41.50	0.951	40.879	0.981*
0.8824	41.50	0.952	40.878	0.982*
0.8850	41.50	0.955	40.875	0.985*
0.8900	41.50	0.96	40.87	0.99
0.8975	41.50	0.968	40.863	0.998*
0.8976	41.50	0.968	40.862	0.998*
0.9000	41.50	0.97	40.86	1.00
0.9100	41.50	0.98	40.85	1.01
0.9126	41.497	0.98	40.847	1.01*
0.9143	41.496	0.98	40.846	1.01*
0.9148	41.495	0.98	40.845	1.01*
0.9200	41.49	0.98	40.84	1.01

\* value interpolated

\*\*\*\*\*

Test Result for UIM Dielectric Parameter

Wed 27/Sep/2023

Freq Frequency(GHz)

eH Limits for Head Epsilon

sH Limits for Head Sigma

Test\_e Epsilon of UIM

Test\_s Sigma of UIM

\*\*\*\*\*

Freq	eH	sH	Test_e	Test_s
1.7000	40.16	1.34	39.49	1.35
1.7100	40.14	1.35	39.47	1.36
1.7102	40.14	1.35	39.47	1.36*
1.7107	40.139	1.35	39.469	1.361*
1.7124	40.138	1.35	39.465	1.362*
1.7200	40.13	1.35	39.45	1.37
1.7300	40.11	1.36	39.43	1.37
1.7325	40.105	1.363	39.425	1.373*
1.7326	40.105	1.363	39.425	1.373*
1.7400	40.09	1.37	39.41	1.38
1.7450	40.085	1.37	39.40	1.385*
1.7475	40.083	1.37	39.395	1.388*
1.7480	40.082	1.370	39.394	1.388*
1.7500	40.08	1.37	39.39	1.39
1.7526	40.075	1.373	39.385	1.393*
1.7543	40.071	1.374	39.381	1.394*
1.7600	40.06	1.38	39.37	1.40
1.7700	40.05	1.38	39.35	1.41
1.7750	40.04	1.385	39.340	1.41*
1.7800	40.03	1.39	39.33	1.41
1.7848	40.025	1.39	39.32	1.415*
1.7900	40.02	1.39	39.31	1.42

\* value interpolated

\*\*\*\*\*

Test Result for UIM Dielectric Parameter  
Thu 28/Sep/2023  
Freq Frequency(GHz)  
eH Limits for Head Epsilon  
sH Limits for Head Sigma  
Test\_e Epsilon of UIM  
Test\_s Sigma of UIM

\*\*\*\*\*

Freq	eH	sH	Test_e	Test_s
1.8500	40.00	1.40	39.75	1.40
1.8502	40.00	1.40	39.75	1.40*
1.8524	40.00	1.40	39.745	1.402*
1.8600	40.00	1.40	39.73	1.41
1.8700	40.00	1.40	39.71	1.41
1.8800	40.00	1.40	39.69	1.42
1.8825	40.00	1.40	39.685	1.42*
1.8900	40.00	1.40	39.67	1.42
1.9000	40.00	1.40	39.65	1.42
1.9050	40.00	1.40	39.64	1.425*
1.9076	40.00	1.40	39.635	1.428*
1.9098	40.00	1.40	39.63	1.43*
1.9100	40.00	1.40	39.63	1.43
1.9200	40.00	1.40	39.62	1.44
1.9207	40.00	1.40	39.619	1.44*
1.9224	40.00	1.40	39.615	1.44*
1.9300	40.00	1.40	39.60	1.44
1.9400	40.00	1.40	39.59	1.44
1.9500	40.00	1.40	39.58	1.44
1.9600	40.00	1.40	39.57	1.45
1.9700	40.00	1.40	39.55	1.45
1.9776	40.00	1.40	39.542	1.45*
1.9793	40.00	1.40	39.541	1.45*
1.9800	40.00	1.40	39.54	1.45
1.9900	40.00	1.40	39.53	1.46

\* value interpolated

\*\*\*\*\*

Test Result for UIM Dielectric Parameter

Wed 04/Oct/2023

Freq Frequency(GHz)

FCC\_eH Limits for Head Epsilon

FCC\_sH Limits for Head Sigma

Test\_e Epsilon of UIM

Test\_s Sigma of UIM

\*\*\*\*\*

Freq	FCC_eH	FCC_sH	Test_e	Test_s
2.4900	39.15	1.84	38.83	1.85
2.5000	39.14	1.85	38.81	1.86
2.5060	39.128	1.862	38.792	1.866*
2.5100	39.12	1.87	38.78	1.87
2.5200	39.11	1.88	38.76	1.89
2.5300	39.10	1.89	38.74	1.90
2.5350	39.095	1.895	38.725	1.905*
2.5400	39.09	1.90	38.71	1.91
2.5500	39.075	1.91	38.69	1.925*
2.5600	39.06	1.92	38.67	1.94
2.5700	39.05	1.93	38.64	1.95
2.5800	39.03	1.94	38.62	1.97
2.5900	39.02	1.95	38.59	1.98
2.5930	39.017	1.953	38.593	1.98*
2.6000	39.01	1.96	38.60	1.98
2.6100	39.00	1.97	38.58	1.99
2.6200	38.98	1.99	38.57	2.00
2.6300	38.97	2.00	38.55	2.01
2.6400	38.96	2.01	38.53	2.02
2.6500	38.95	2.02	38.51	2.03
2.6600	38.93	2.03	38.50	2.04
2.6700	38.92	2.04	38.48	2.05
2.6800	38.91	2.05	38.46	2.06
2.6900	38.89	2.06	38.44	2.07
2.7000	38.88	2.07	38.43	2.08

\* value interpolated

# RF Exposure Lab

## Plot 1

**DUT: Dipole 750 MHz D750V3; Type: D750V3; Serial: D750V3 - SN 1053**

Communication System: CW; Frequency: 750 MHz; Duty Cycle: 1:1  
Medium: HSL750; Medium parameters used (interpolated):  $f = 750$  MHz;  $\sigma = 0.9$  S/m;  $\epsilon_r = 41.46$ ;  $\rho = 1000$  kg/m<sup>3</sup>  
Phantom section: Flat Section

Test Date: Date: 4/14/2023; Ambient Temp: 23 °C; Tissue Temp: 21 °C  
Probe: EX3DV4 – SN3662; ConvF(9.28, 9.28, 9.28); Calibrated: 2/10/2023;  
Sensor-Surface: 2mm (Mechanical Surface Detection)  
Electronics: DAE4 Sn1217; Calibrated: 2/14/2023  
Phantom: ELI v5.0; Type: QDOVA002AA; Serial: 2037  
Measurement SW: DASY52, Version 52.10 (0); SEMCAD X Version 14.6.10 (7417)

### Procedure Notes:

**750 MHz Head/Verification/Area Scan (41x121x1):** Interpolated grid: dx=1.500 mm, dy=1.500 mm  
Maximum value of SAR (interpolated) = 0.883 W/kg

**750 MHz Head/Verification /Zoom Scan (5x5x7)/Cube 0:** Measurement grid: dx=8mm, dy=8mm, dz=5mm  
Reference Value = 31.949 V/m; Power Drift = -0.03 dB  
Peak SAR (extrapolated) = 1.691 mW/g  
 $P_{in} = 100$  mW  
**SAR(1 g) = 0.858 mW/g; SAR(10 g) = 0.552 mW/g**  
Maximum value of SAR (measured) = 0.888 W/kg

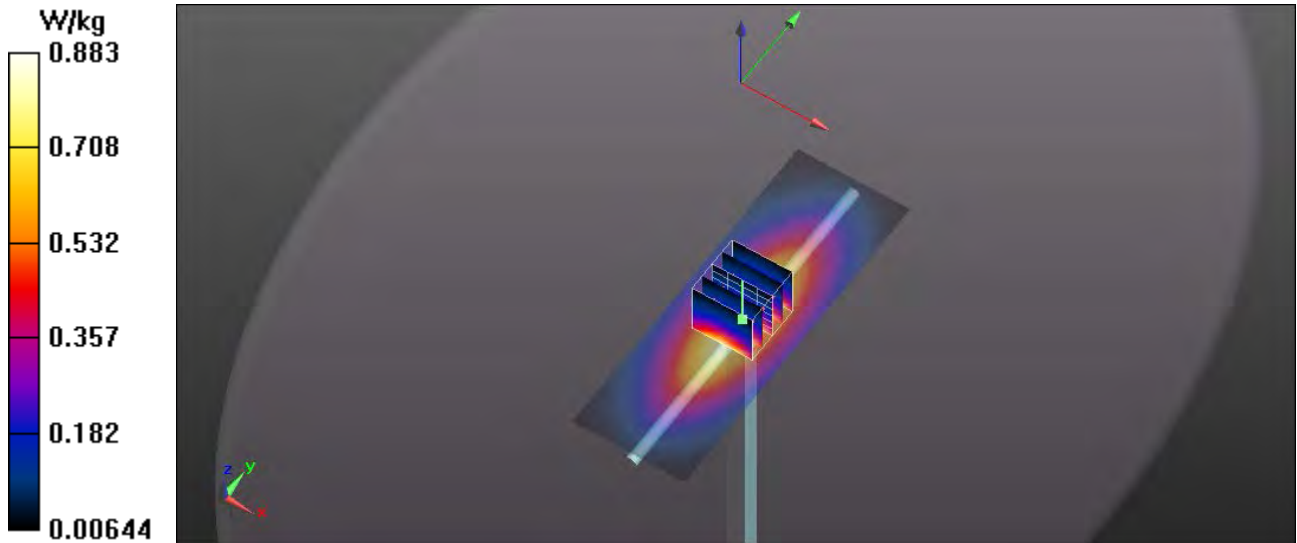

# RF Exposure Lab

## Plot 2

**DUT: Dipole 900 MHz D900V2; Type: D900V2; Serial: D900V2 - SN:1d128**

Communication System: CW; Frequency: 900 MHz; Duty Cycle: 1:1  
Medium: HSL900; Medium parameters used:  $f = 900$  MHz;  $\sigma = 0.98$  S/m;  $\epsilon_r = 41.34$ ;  $\rho = 1000$  kg/m<sup>3</sup>  
Phantom section: Flat Section

Test Date: Date: 4/14/2023; Ambient Temp: 23 °C; Tissue Temp: 21 °C  
Probe: EX3DV4 – SN3662; ConvF(8.8, 8.8, 8.8); Calibrated: 2/10/2023;  
Sensor-Surface: 2mm (Mechanical Surface Detection)  
Electronics: DAE4 Sn1217; Calibrated: 2/14/2023  
Phantom: ELI v5.0; Type: QDOVA002AA; Serial: 2037  
Measurement SW: DASY52, Version 52.10 (0); SEMCAD X Version 14.6.10 (7417)

### Procedure Notes:

**900 MHz Head/Verification/Area Scan (5x11x1):** Measurement grid: dx=15mm, dy=15mm  
Maximum value of SAR (measured) = 1.19 W/kg

**900 MHz Head/Verification/Zoom Scan (5x5x7)/Cube 0:** Measurement grid: dx=8mm, dy=8mm, dz=5mm  
Reference Value = 31.568 V/m; Power Drift = -0.02 dB  
Peak SAR (extrapolated) = 1.43 W/kg  
 $P_{in} = 100$  mW  
**SAR(1 g) = 1.15 W/kg; SAR(10 g) = 0.712 W/kg**  
Maximum value of SAR (measured) = 1.2 W/kg

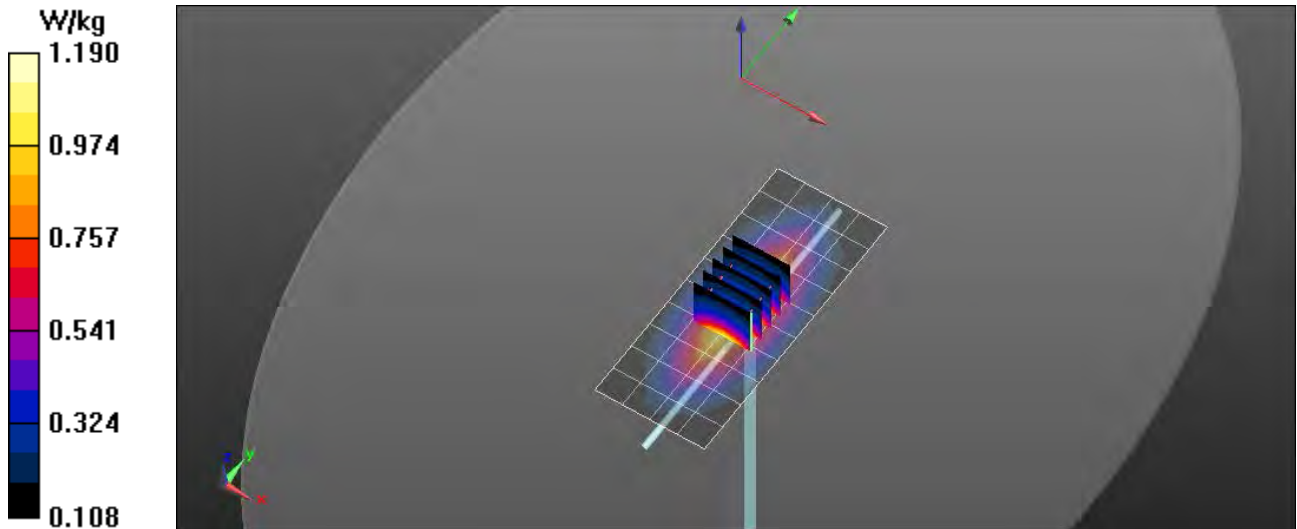



# RF Exposure Lab

## Plot 3

**DUT: Dipole 1750 MHz D1750V2; Type: D1750V2; Serial: D1750V2 - SN:1061**

Communication System: CW; Frequency: 1750 MHz; Duty Cycle: 1:1  
Medium: HSL1750; Medium parameters used:  $f = 1750$  MHz;  $\sigma = 1.4$  S/m;  $\epsilon_r = 39.24$ ;  $\rho = 1000$  kg/m<sup>3</sup>  
Phantom section: Flat Section

Test Date: Date: 4/15/2023; Ambient Temp: 23 °C; Tissue Temp: 21 °C  
Probe: EX3DV4 – SN3662; ConvF(7.91, 7.91, 7.91); Calibrated: 2/10/2023;  
Sensor-Surface: 2mm (Mechanical Surface Detection)  
Electronics: DAE4 Sn1217; Calibrated: 2/14/2023  
Phantom: ELI v5.0; Type: QDOVA002AA; Serial: 2037  
Measurement SW: DASY52, Version 52.10 (0); SEMCAD X Version 14.6.10 (7417)

### Procedure Notes:

**1750 MHz Head/Verification/Area Scan (5x7x1):** Measurement grid: dx=15mm, dy=15mm  
Maximum value of SAR (measured) = 5.38 W/kg

**1750 MHz Head/Verification/Zoom Scan (5x5x7)/Cube 0:** Measurement grid: dx=8mm, dy=8mm, dz=5mm  
Reference Value = 33.639 V/m; Power Drift = -0.02 dB  
Peak SAR (extrapolated) = 6.87 W/kg  
 $P_{in} = 100$  mW  
**SAR(1 g) = 3.78 W/kg; SAR(10 g) = 1.97 W/kg**  
Maximum value of SAR (measured) = 5.47 W/kg

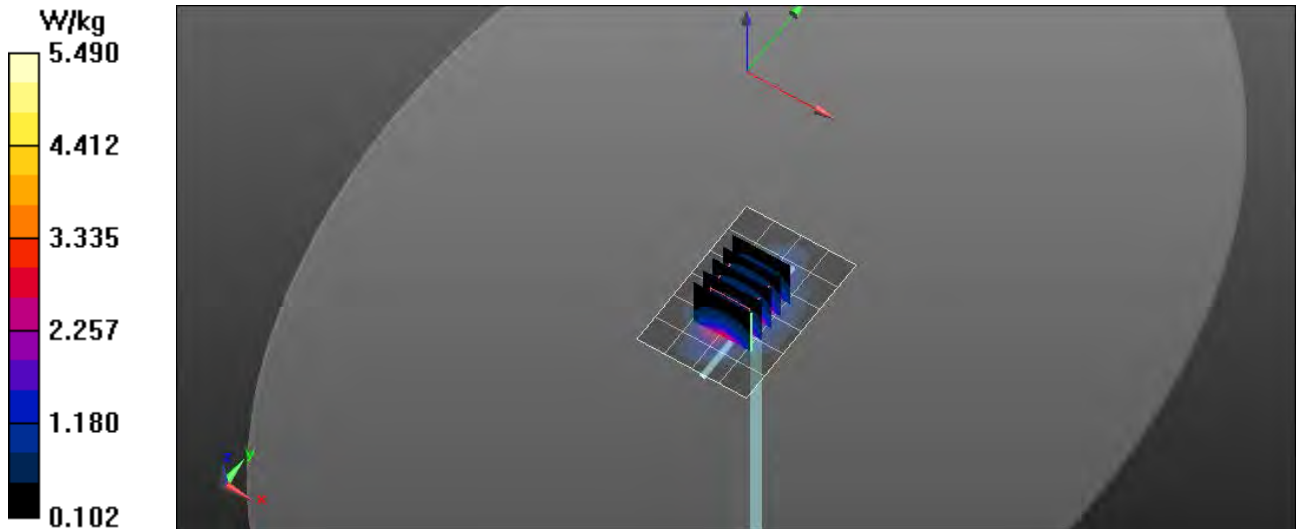

# RF Exposure Lab

## Plot 4

**DUT: Dipole 1900 MHz D1900V2; Type: D1900V2; Serial: D1900V2 - SN: 5d147**

Communication System: CW; Frequency: 1900 MHz; Duty Cycle: 1:1  
Medium: HSL1900; Medium parameters used:  $f = 1900$  MHz;  $\sigma = 1.39$  S/m;  $\epsilon_r = 39.87$ ;  $\rho = 1000$  kg/m<sup>3</sup>  
Phantom section: Flat Section

Test Date: Date: 4/15/2023; Ambient Temp: 23 °C; Tissue Temp: 21 °C  
Probe: EX3DV4 – SN3662; ConvF(7.67, 7.67, 7.67); Calibrated: 2/10/2023;  
Sensor-Surface: 2mm (Mechanical Surface Detection)  
Electronics: DAE4 Sn1217; Calibrated: 2/14/2023  
Phantom: ELI v5.0; Type: QDOVA002AA; Serial: 2037  
Measurement SW: DASY52, Version 52.10 (0); SEMCAD X Version 14.6.10 (7417)

### Procedure Notes:

**1900 MHz Head/Verification/Area Scan (5x7x1):** Measurement grid: dx=15mm, dy=15mm  
Maximum value of SAR (measured) = 5.52 W/kg

**1900 MHz Head/Verification/Zoom Scan (5x5x7)/Cube 0:** Measurement grid: dx=8mm, dy=8mm, dz=5mm  
Reference Value = 32.186 V/m; Power Drift = -0.03 dB  
Peak SAR (extrapolated) = 7.25 W/kg  
 $P_{in} = 100$  mW  
**SAR(1 g) = 4.15 W/kg; SAR(10 g) = 2.16 W/kg**  
Maximum value of SAR (measured) = 5.79 W/kg

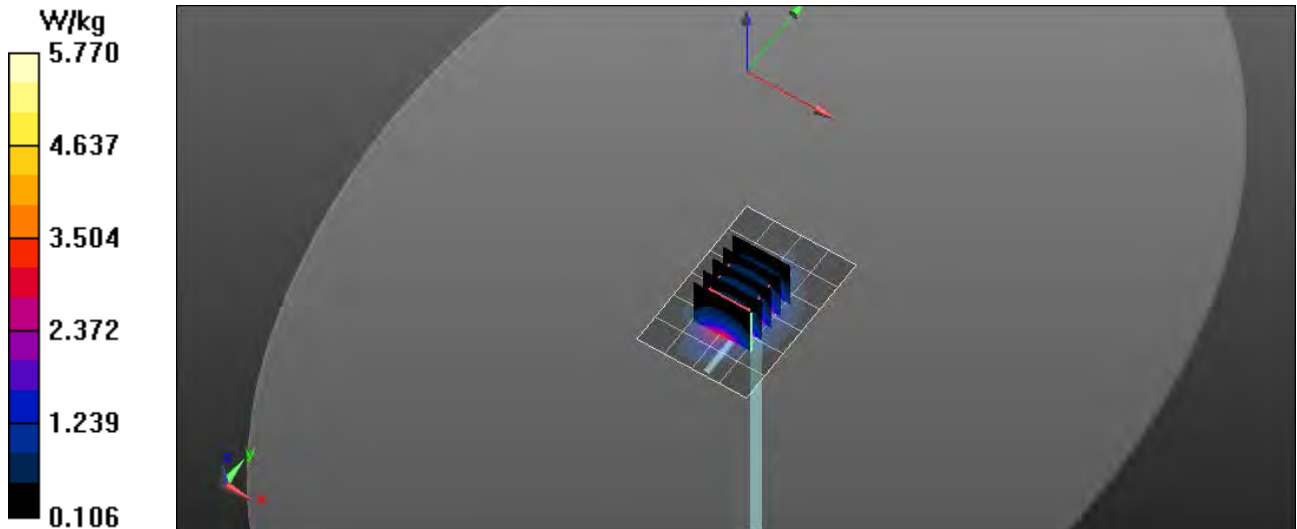

# RF Exposure Lab

## Plot 5

**DUT: Dipole 750 MHz D750V3; Type: D750V3; Serial: D750V3 - SN 1053**

Communication System: CW; Frequency: 750 MHz; Duty Cycle: 1:1  
Medium: HSL750; Medium parameters used (interpolated):  $f = 750 \text{ MHz}$ ;  $\sigma = 0.92 \text{ S/m}$ ;  $\epsilon_r = 40.89$ ;  $\rho = 1000 \text{ kg/m}^3$   
Phantom section: Flat Section

Test Date: Date: 9/27/2023; Ambient Temp: 23 °C; Tissue Temp: 21 °C  
Probe: EX3DV4 – SN3662; ConvF(9.28, 9.28, 9.28); Calibrated: 2/10/2023;  
Sensor-Surface: 2mm (Mechanical Surface Detection)  
Electronics: DAE4 Sn1416; Calibrated: 4/19/2023  
Phantom: ELI v5.0; Type: QDOVA002AA; Serial: 2037  
Measurement SW: DASY52, Version 52.10 (0); SEMCAD X Version 14.6.10 (7417)

### Procedure Notes:

**750 MHz Head/Verification/Area Scan (41x121x1):** Interpolated grid:  $dx=1.500 \text{ mm}$ ,  $dy=1.500 \text{ mm}$   
Maximum value of SAR (interpolated) = 0.889 W/kg

**750 MHz Head/Verification /Zoom Scan (5x5x7)/Cube 0:** Measurement grid:  $dx=8\text{mm}$ ,  $dy=8\text{mm}$ ,  $dz=5\text{mm}$   
Reference Value = 31.369 V/m; Power Drift = -0.01 dB  
Peak SAR (extrapolated) = 1.562 mW/g  
 $P_{in} = 100 \text{ mW}$   
**SAR(1 g) = 0.856 mW/g; SAR(10 g) = 0.559 mW/g**  
Maximum value of SAR (measured) = 0.884 W/kg

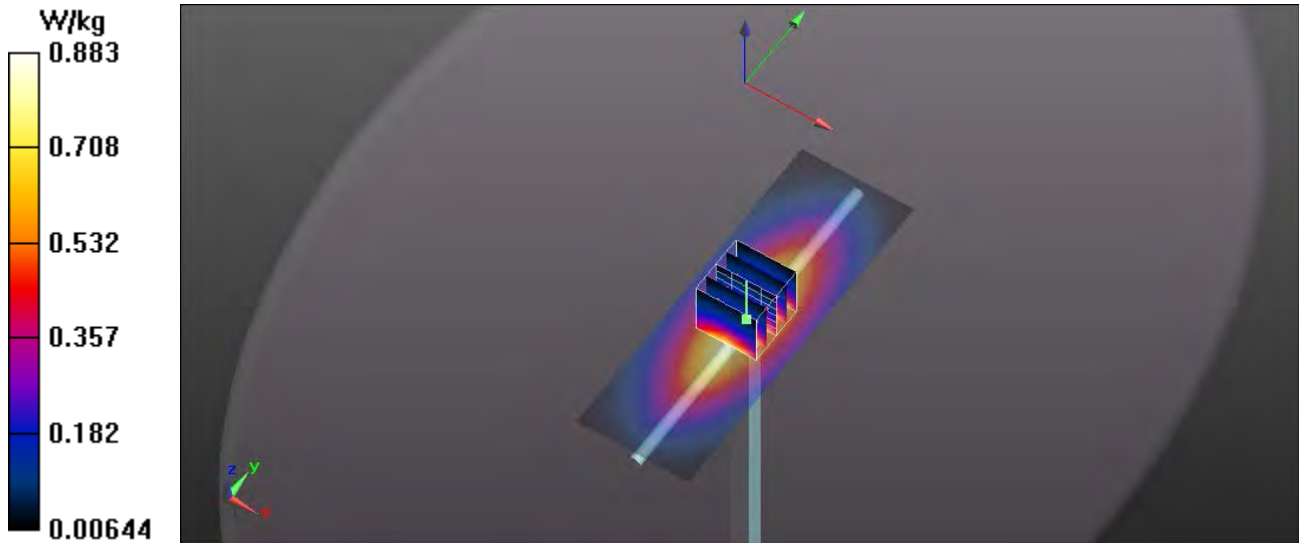

# RF Exposure Lab

## Plot 6

**DUT: Dipole 900 MHz D900V2; Type: D900V2; Serial: D900V2 - SN:1d128**

Communication System: CW; Frequency: 900 MHz; Duty Cycle: 1:1  
Medium: HSL900; Medium parameters used:  $f = 900 \text{ MHz}$ ;  $\sigma = 1 \text{ S/m}$ ;  $\epsilon_r = 40.86$ ;  $\rho = 1000 \text{ kg/m}^3$   
Phantom section: Flat Section

Test Date: Date: 10/2/2023; Ambient Temp: 23 °C; Tissue Temp: 21 °C  
Probe: EX3DV4 – SN3662; ConvF(8.8, 8.8, 8.8); Calibrated: 2/10/2023;  
Sensor-Surface: 2mm (Mechanical Surface Detection)  
Electronics: DAE4 Sn1416; Calibrated: 4/19/2023  
Phantom: ELI v5.0; Type: QDOVA002AA; Serial: 2037  
Measurement SW: DASY52, Version 52.10 (0); SEMCAD X Version 14.6.10 (7417)

### Procedure Notes:

**900 MHz Head/Verification/Area Scan (5x11x1):** Measurement grid: dx=15mm, dy=15mm  
Maximum value of SAR (measured) = 1.22 W/kg

**900 MHz Head/Verification/Zoom Scan (5x5x7)/Cube 0:** Measurement grid: dx=8mm, dy=8mm, dz=5mm  
Reference Value = 31.897 V/m; Power Drift = -0.04 dB  
Peak SAR (extrapolated) = 1.46 W/kg  
 $P_{in} = 100 \text{ mW}$

**SAR(1 g) = 1.17 W/kg; SAR(10 g) = 0.715 W/kg**  
Maximum value of SAR (measured) = 1.19 W/kg

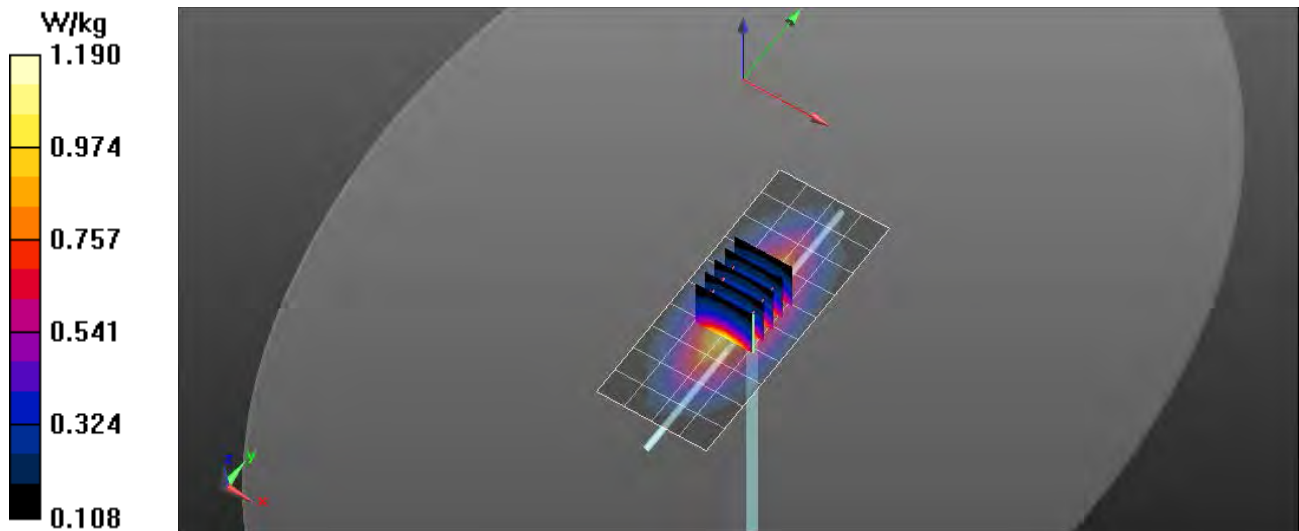

# RF Exposure Lab

## Plot 7

**DUT: Dipole 1750 MHz D1750V2; Type: D1750V2; Serial: D1750V2 - SN:1061**

Communication System: CW; Frequency: 1750 MHz; Duty Cycle: 1:1  
Medium: HSL1750; Medium parameters used:  $f = 1750$  MHz;  $\sigma = 1.39$  S/m;  $\epsilon_r = 39.39$ ;  $\rho = 1000$  kg/m<sup>3</sup>  
Phantom section: Flat Section

Test Date: Date: 9/27/2023; Ambient Temp: 23 °C; Tissue Temp: 21 °C  
Probe: EX3DV4 – SN3662; ConvF(7.91, 7.91, 7.91); Calibrated: 2/10/2023;  
Sensor-Surface: 2mm (Mechanical Surface Detection)  
Electronics: DAE4 Sn1416; Calibrated: 4/19/2023  
Phantom: ELI v5.0; Type: QDOVA002AA; Serial: 2037  
Measurement SW: DASY52, Version 52.10 (0); SEMCAD X Version 14.6.10 (7417)

### Procedure Notes:

**1750 MHz Head/Verification/Area Scan (5x7x1):** Measurement grid: dx=15mm, dy=15mm  
Maximum value of SAR (measured) = 5.22 W/kg

**1750 MHz Head/Verification/Zoom Scan (5x5x7)/Cube 0:** Measurement grid: dx=8mm, dy=8mm, dz=5mm  
Reference Value = 33.387 V/m; Power Drift = -0.03 dB  
Peak SAR (extrapolated) = 6.84 W/kg  
 $P_{in} = 100$  mW  
**SAR(1 g) = 3.77 W/kg; SAR(10 g) = 1.96 W/kg**  
Maximum value of SAR (measured) = 5.49 W/kg

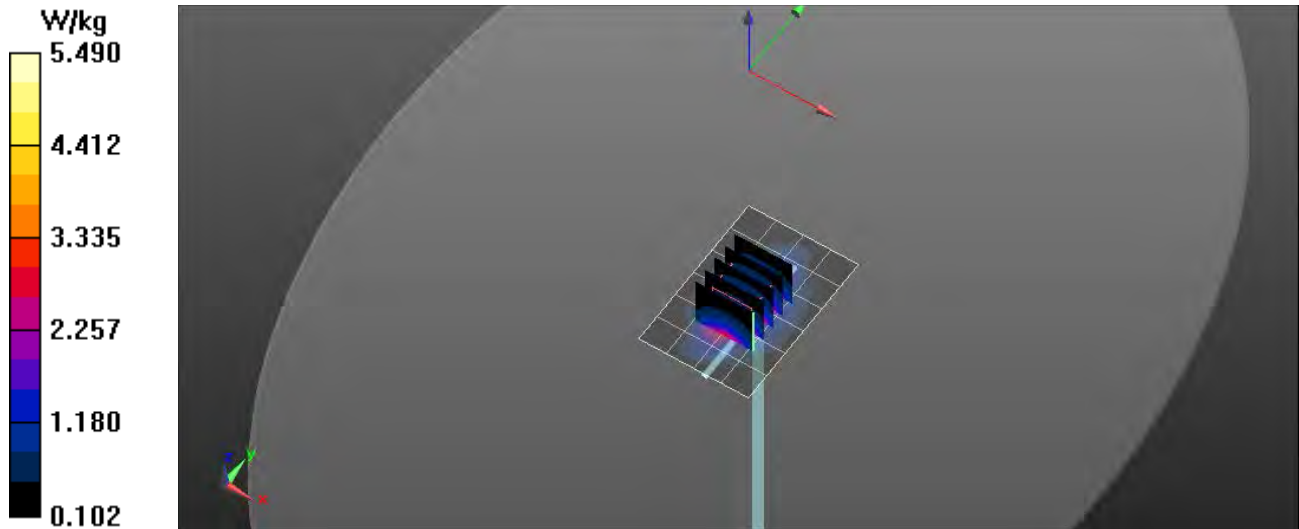

# RF Exposure Lab

## Plot 8

**DUT: Dipole 1900 MHz D1900V2; Type: D1900V2; Serial: D1900V2 - SN: 5d147**

Communication System: CW; Frequency: 1900 MHz; Duty Cycle: 1:1  
Medium: HSL1900; Medium parameters used:  $f = 1900$  MHz;  $\sigma = 1.42$  S/m;  $\epsilon_r = 39.65$ ;  $\rho = 1000$  kg/m<sup>3</sup>  
Phantom section: Flat Section

Test Date: Date: 9/28/2023; Ambient Temp: 23 °C; Tissue Temp: 21 °C  
Probe: EX3DV4 – SN3662; ConvF(7.67, 7.67, 7.67); Calibrated: 2/10/2023;  
Sensor-Surface: 2mm (Mechanical Surface Detection)  
Electronics: DAE4 Sn1416; Calibrated: 4/19/2023  
Phantom: ELI v5.0; Type: QDOVA002AA; Serial: 2037  
Measurement SW: DASY52, Version 52.10 (0); SEMCAD X Version 14.6.10 (7417)

### Procedure Notes:

**1900 MHz Head/Verification/Area Scan (5x7x1):** Measurement grid: dx=15mm, dy=15mm  
Maximum value of SAR (measured) = 5.55 W/kg

**1900 MHz Head/Verification/Zoom Scan (5x5x7)/Cube 0:** Measurement grid: dx=8mm, dy=8mm, dz=5mm  
Reference Value = 32.965 V/m; Power Drift = -0.01 dB  
Peak SAR (extrapolated) = 7.22 W/kg  
 $P_{in} = 100$  mW  
**SAR(1 g) = 4.17 W/kg; SAR(10 g) = 2.17 W/kg**  
Maximum value of SAR (measured) = 5.77 W/kg

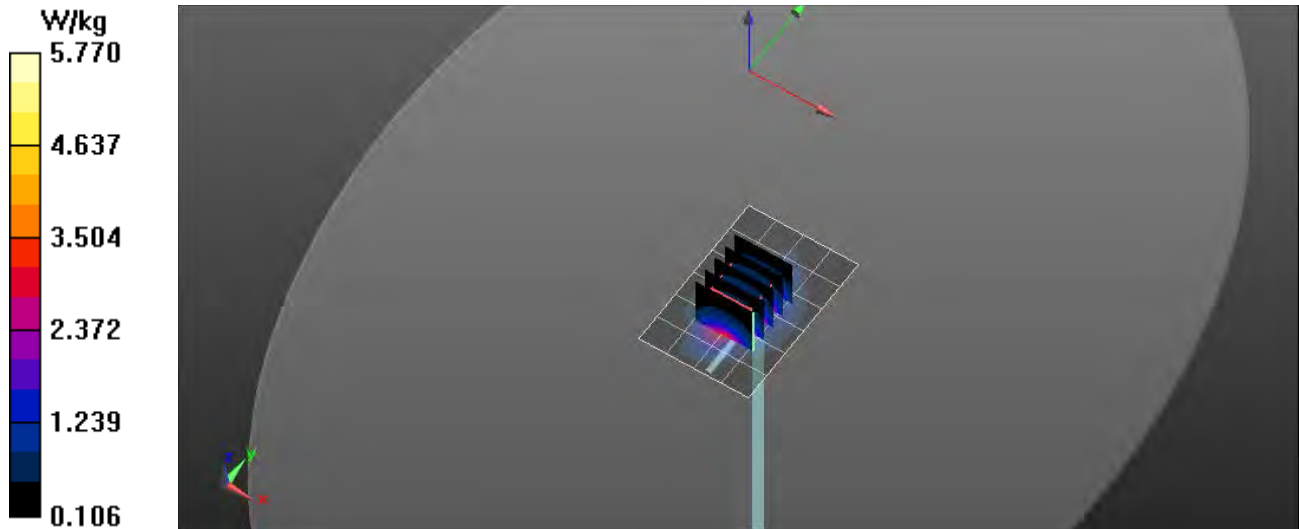

# RF Exposure Lab

## Plot 9

**DUT: Dipole 2550 MHz D2550V2; Type: D2550V2; Serial: D2550V2 - SN:1003**

Communication System: CW; Frequency: 2550 MHz; Duty Cycle: 1:1  
Medium: HSL2550; Medium parameters used (interpolated):  $f = 2550$  MHz;  $\sigma = 1.925$  S/m;  $\epsilon_r = 38.69$ ;  $\rho = 1000$  kg/m<sup>3</sup>  
Phantom section: Flat Section

Test Date: Date: 10/4/2023; Ambient Temp: 23 °C; Tissue Temp: 21 °C  
Probe: EX3DV4 – SN3662; ConvF(7.54, 7.33, 7.61); Calibrated: 2/10/2023;  
Sensor-Surface: 2mm (Mechanical Surface Detection)  
Electronics: DAE4 Sn1416; Calibrated: 4/19/2023  
Phantom: ELI v5.0; Type: QDOVA002AA; Serial: 2037  
Measurement SW: DASY52, Version 52.10 (0); SEMCAD X Version 14.6.10 (7417)

### Procedure Notes:

**2550 MHz Head/Verification/Area Scan (61x81x1):** Interpolated grid: dx=1.000 mm, dy=1.000 mm

[Info: Interpolated medium parameters used for SAR evaluation.](#)  
Maximum value of SAR (interpolated) = 9.21 W/kg

**2550 MHz Head/Verification/Zoom Scan (7x7x7)/Cube 0:** Measurement grid: dx=5mm, dy=5mm, dz=5mm  
Reference Value = 54.694 V/m; Power Drift = -0.03 dB  
Peak SAR (extrapolated) = 11.6 W/kg  
 $P_{in} = 100$  mW  
**SAR(1 g) = 5.66 W/kg; SAR(10 g) = 2.49 W/kg**

[Info: Interpolated medium parameters used for SAR evaluation.](#)  
Maximum value of SAR (measured) = 9.15 W/kg

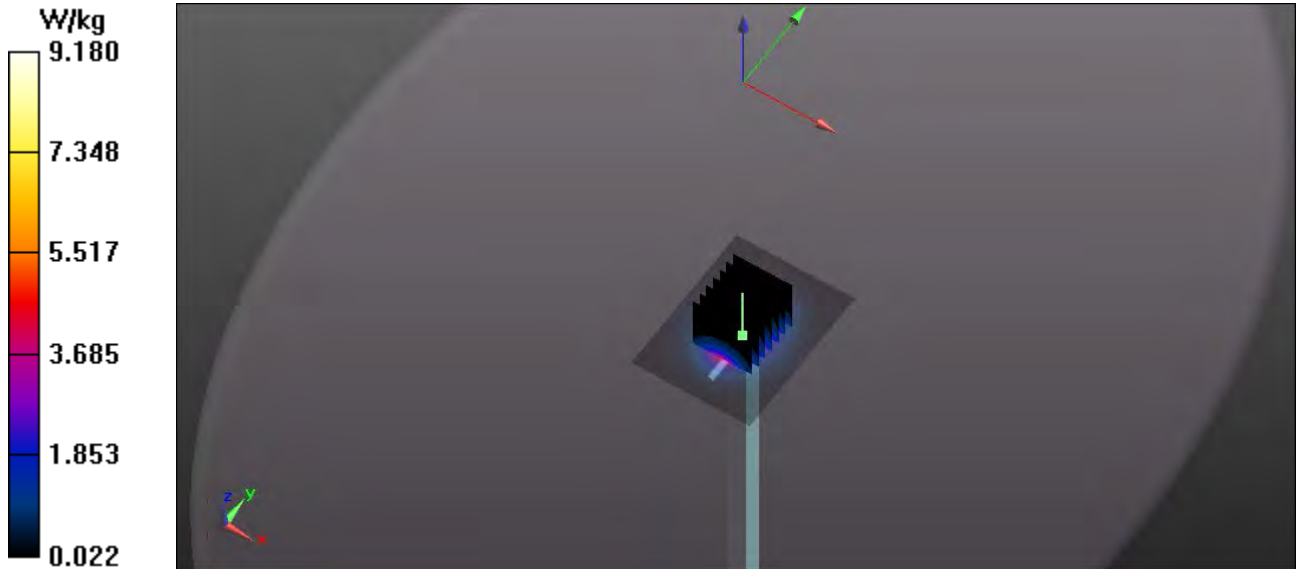

## Appendix B – SAR Test Data Plots



# RF Exposure Lab

## Plot 1

**DUT: EG21-G; Type: Comm Unit; Serial: 042**

Communication System: UMTS (WCDMA); Frequency: 1880 MHz; Duty Cycle: 1:1  
Medium: HSL1900; Medium parameters used:  $f = 1880$  MHz;  $\sigma = 1.42$  S/m;  $\epsilon_r = 39.69$ ;  $\rho = 1000$  kg/m<sup>3</sup>  
Phantom section: Flat Section

Test Date: Date: 9/28/2023; Ambient Temp: 23 °C; Tissue Temp: 21 °C

Probe: EX3DV4 - SN3662; ConvF(7.67, 7.67, 7.67); Calibrated: 2/10/2023  
Sensor-Surface: 2mm (Mechanical Surface Detection)  
Electronics: DAE4 Sn1416; Calibrated: 4/19/2023  
Phantom: ELI v5.0; Type: QDOVA002AA; Serial: 2037  
Measurement SW: DASY52, Version 52.10 (0); SEMCAD X Version 14.6.10 (7417)

### Procedure Notes:

**EG21 B2 WCDMA/Front Mid/Area Scan (7x7x1):** Measurement grid: dx=15mm, dy=15mm  
Maximum value of SAR (measured) = 0.127 W/kg

**EG21 B2 WCDMA/Front Mid/Zoom Scan (6x5x7)/Cube 0:** Measurement grid: dx=8mm, dy=8mm, dz=5mm  
Reference Value = 8.615 V/m; Power Drift = 0.06 dB  
Peak SAR (extrapolated) = 0.160 W/kg  
**SAR(1 g) = 0.104 W/kg; SAR(10 g) = 0.067 W/kg**  
Maximum value of SAR (measured) = 0.132 W/kg

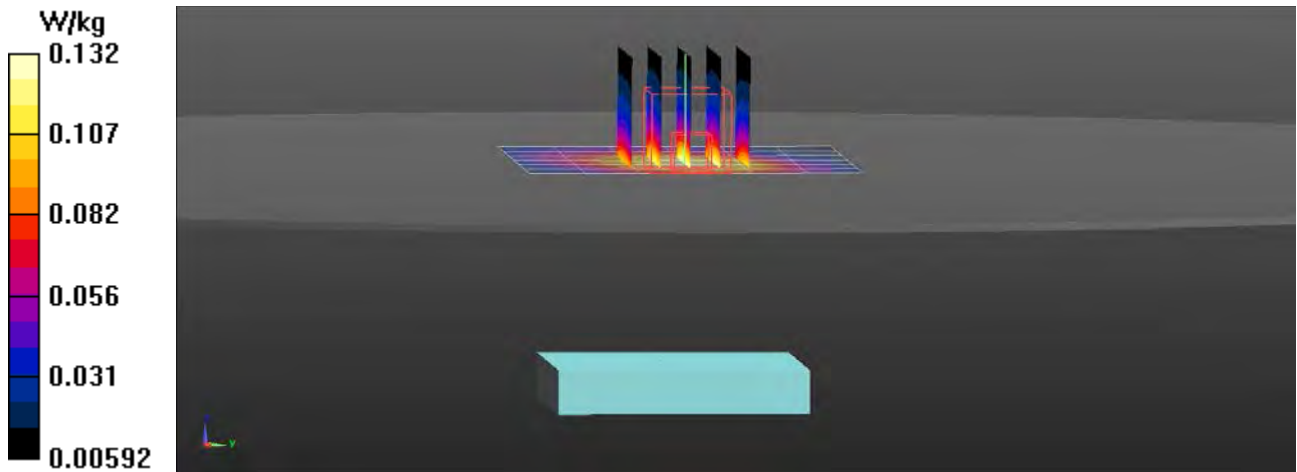

# RF Exposure Lab

## Plot 2

**DUT: EG21-G; Type: Comm Unit; Serial: 042**

Communication System: UMTS (WCDMA); Frequency: 1732.6 MHz; Duty Cycle: 1:1  
Medium: HSL1750; Medium parameters used (interpolated):  $f = 1732.6$  MHz;  $\sigma = 1.373$  S/m;  $\epsilon_r = 39.425$ ;  $\rho = 1000$  kg/m<sup>3</sup>  
Phantom section: Flat Section

Test Date: Date: 9/27/2023; Ambient Temp: 23 °C; Tissue Temp: 21 °C

Probe: EX3DV4 - SN3662; ConvF(7.91, 7.91, 7.91); Calibrated: 2/10/2023  
Sensor-Surface: 2mm (Mechanical Surface Detection)  
Electronics: DAE4 Sn1416; Calibrated: 4/19/2023  
Phantom: ELI v5.0; Type: QDOVA002AA; Serial: 2037  
Measurement SW: DASY52, Version 52.10 (0); SEMCAD X Version 14.6.10 (7417)

### Procedure Notes:

**EG21 B4 WCDMA/Front Mid/Area Scan (7x7x1):** Measurement grid: dx=15mm, dy=15mm

[Info: Interpolated medium parameters used for SAR evaluation.](#)  
Maximum value of SAR (measured) = 0.0583 W/kg

**EG21 B4 WCDMA/Front Mid/Zoom Scan (5x5x7)/Cube 0:** Measurement grid: dx=8mm, dy=8mm, dz=5mm  
Reference Value = 5.645 V/m; Power Drift = 0.07 dB  
Peak SAR (extrapolated) = 0.0730 W/kg  
**SAR(1 g) = 0.049 W/kg; SAR(10 g) = 0.032 W/kg**

[Info: Interpolated medium parameters used for SAR evaluation.](#)  
Maximum value of SAR (measured) = 0.0618 W/kg

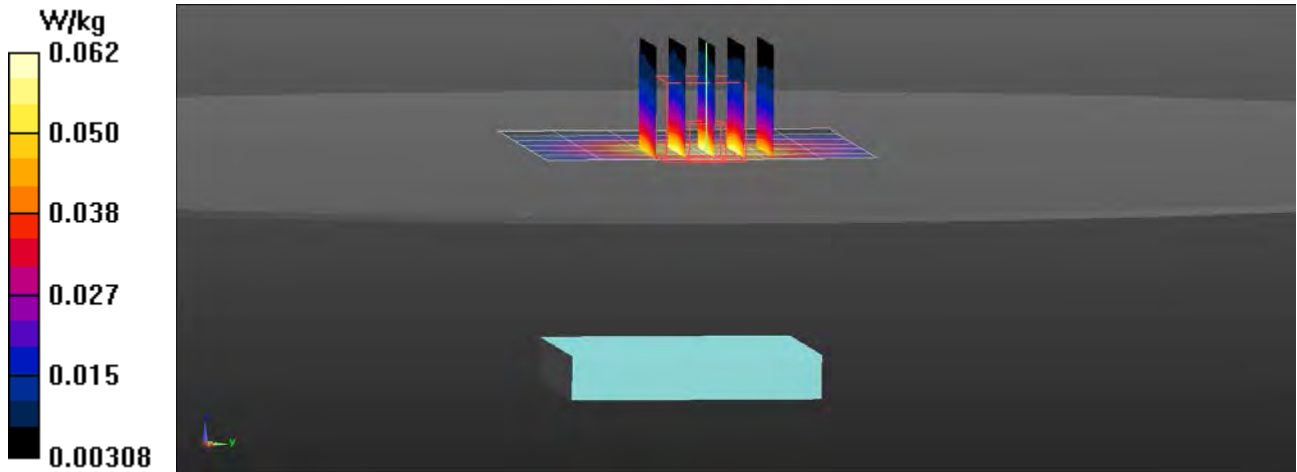

# RF Exposure Lab

## Plot 3

**DUT: EG21-G; Type: Comm Unit; Serial: 042**

Communication System: UMTS (WCDMA); Frequency: 836.6 MHz; Duty Cycle: 1:1  
Medium: HSL900; Medium parameters used (interpolated):  $f = 836.6$  MHz;  $\sigma = 0.937$  S/m;  $\epsilon_r = 40.96$ ;  $\rho = 1000$  kg/m<sup>3</sup>  
Phantom section: Flat Section

Test Date: Date: 10/2/2023; Ambient Temp: 23 °C; Tissue Temp: 21 °C

Probe: EX3DV4 - SN3662; ConvF(8.8, 8.8, 8.8); Calibrated: 2/10/2023  
Sensor-Surface: 2mm (Mechanical Surface Detection)  
Electronics: DAE4 Sn1416; Calibrated: 4/19/2023  
Phantom: ELI v5.0; Type: QDOVA002AA; Serial: 2037  
Measurement SW: DASY52, Version 52.10 (0); SEMCAD X Version 14.6.10 (7417)

### Procedure Notes:

**EG21 B5 WCDMA/Front Mid/Area Scan (7x7x1):** Measurement grid: dx=15mm, dy=15mm

[Info: Interpolated medium parameters used for SAR evaluation.](#)  
Maximum value of SAR (measured) = 0.146 W/kg

**EG21 B5 WCDMA/Front Mid/Zoom Scan (5x5x7)/Cube 0:** Measurement grid: dx=8mm, dy=8mm, dz=5mm  
Reference Value = 9.813 V/m; Power Drift = -0.02 dB  
Peak SAR (extrapolated) = 0.181 W/kg  
**SAR(1 g) = 0.130 W/kg; SAR(10 g) = 0.091 W/kg**

[Info: Interpolated medium parameters used for SAR evaluation.](#)  
Maximum value of SAR (measured) = 0.158 W/kg

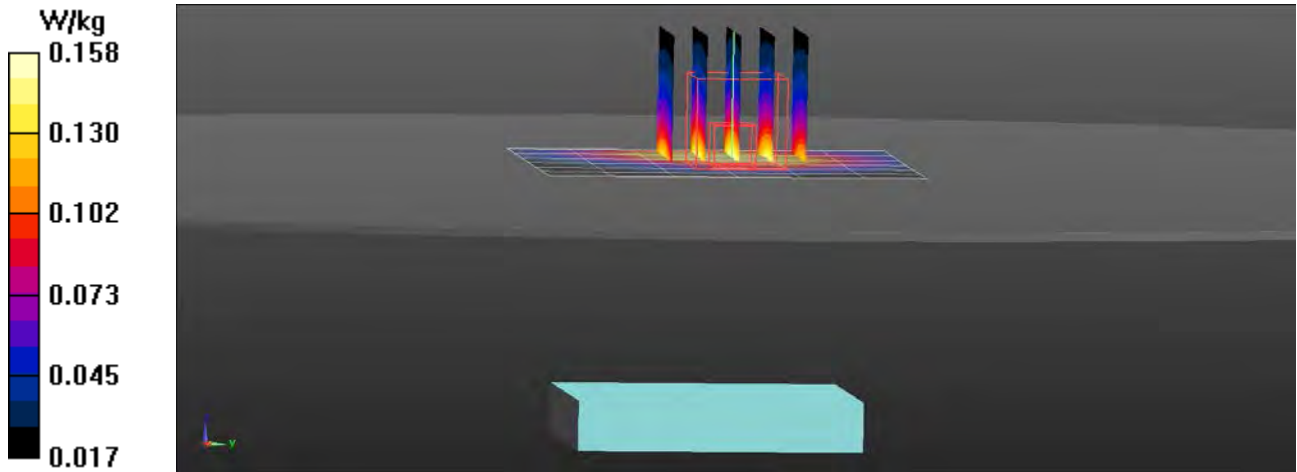

# RF Exposure Lab

## Plot 4

**DUT: EG21-G; Type: Comm Unit; Serial: 042**

Communication System: GPRS 3-Slot (GMSK); Frequency: 1880 MHz; Duty Cycle: 1:6.00037  
Medium: HSL1900; Medium parameters used:  $f = 1880$  MHz;  $\sigma = 1.42$  S/m;  $\epsilon_r = 39.69$ ;  $\rho = 1000$  kg/m<sup>3</sup>  
Phantom section: Flat Section

Test Date: Date: 9/28/2023; Ambient Temp: 23 °C; Tissue Temp: 21 °C

Probe: EX3DV4 - SN3662; ConvF(7.67, 7.67, 7.67); Calibrated: 2/10/2023  
Sensor-Surface: 2mm (Mechanical Surface Detection)  
Electronics: DAE4 Sn1416; Calibrated: 4/19/2023  
Phantom: ELI v5.0; Type: QDOVA002AA; Serial: 2037  
Measurement SW: DASY52, Version 52.10 (0); SEMCAD X Version 14.6.10 (7417)

### Procedure Notes:

**EG21 B2 GSM/Front Mid/Area Scan (7x7x1):** Measurement grid: dx=15mm, dy=15mm  
Maximum value of SAR (measured) = 0.0698 W/kg

**EG21 B2 GSM/Front Mid/Zoom Scan (5x5x7)/Cube 0:** Measurement grid: dx=8mm, dy=8mm, dz=5mm  
Reference Value = 6.367 V/m; Power Drift = -0.06 dB  
Peak SAR (extrapolated) = 0.0870 W/kg  
**SAR(1 g) = 0.056 W/kg; SAR(10 g) = 0.036 W/kg**  
Maximum value of SAR (measured) = 0.0715 W/kg

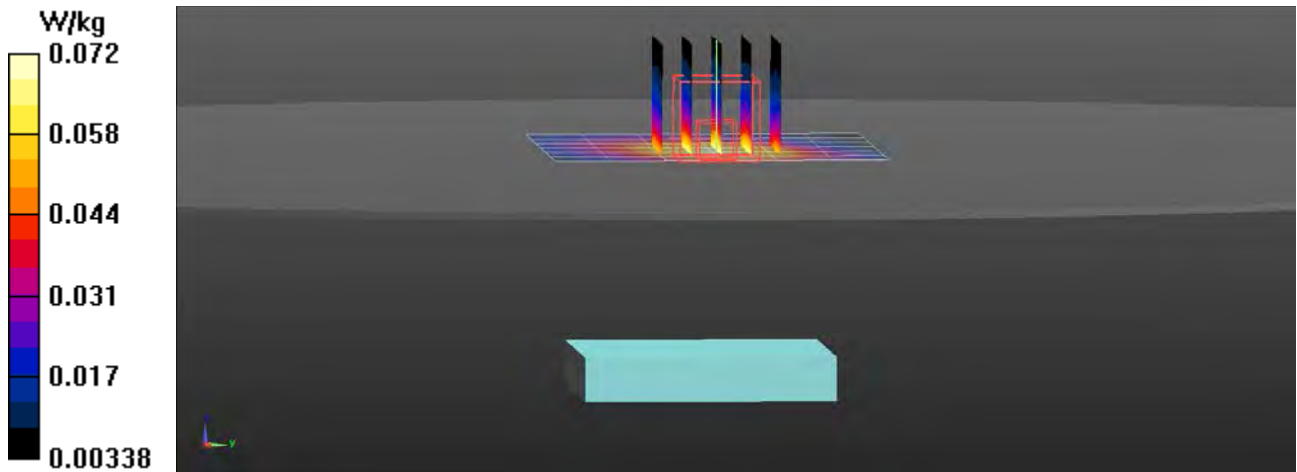

# RF Exposure Lab

## Plot 5

**DUT: EG21-G; Type: Comm Unit; Serial: 042**

Communication System: GPRS 3-Slot (GMSK); Frequency: 836.6 MHz; Duty Cycle: 1:6.00037  
Medium: HSL900; Medium parameters used (interpolated):  $f = 836.6$  MHz;  $\sigma = 0.937$  S/m;  $\epsilon_r = 40.96$ ;  $\rho = 1000$  kg/m<sup>3</sup>  
Phantom section: Flat Section

Test Date: Date: 10/2/2023; Ambient Temp: 23 °C; Tissue Temp: 21 °C

Probe: EX3DV4 - SN3662; ConvF(8.8, 8.8, 8.8); Calibrated: 2/10/2023  
Sensor-Surface: 2mm (Mechanical Surface Detection)  
Electronics: DAE4 Sn1416; Calibrated: 4/19/2023  
Phantom: ELI v5.0; Type: QDOVA002AA; Serial: 2037  
Measurement SW: DASY52, Version 52.10 (0); SEMCAD X Version 14.6.10 (7417)

### Procedure Notes:

**EG21 B5 GSM/Front Mid/Area Scan (7x8x1):** Measurement grid: dx=15mm, dy=15mm

[Info: Interpolated medium parameters used for SAR evaluation.](#)  
Maximum value of SAR (measured) = 0.000620 W/kg

**EG21 B5 GSM/Front Mid/Zoom Scan (6x7x7)/Cube 0:** Measurement grid: dx=8mm, dy=8mm, dz=5mm  
Reference Value = 0.2370 V/m; Power Drift = 0.09 dB  
Peak SAR (extrapolated) = 0.0110 W/kg  
**SAR(1 g) = 0.000109 W/kg; SAR(10 g) = 1.17e-005 W/kg**

[Info: Interpolated medium parameters used for SAR evaluation.](#)  
Maximum value of SAR (measured) = 0.0148 W/kg

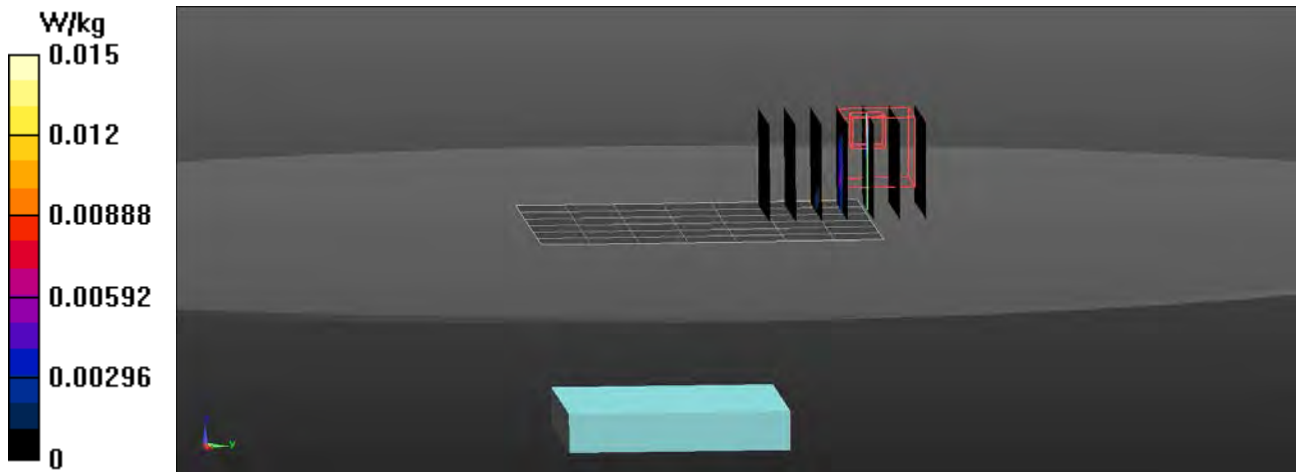

# RF Exposure Lab

## Plot 6

**DUT: EG21-G; Type: Comm Unit; Serial: 042**

Communication System: LTE (SC-FDMA, 1 RB, 20 MHz, QPSK); Frequency: 1732.5 MHz; Duty Cycle: 1:1  
Medium: HSL1750; Medium parameters used (interpolated):  $f = 1732.5$  MHz;  $\sigma = 1.373$  S/m;  $\epsilon_r = 39.425$ ;  $\rho = 1000$  kg/m<sup>3</sup>  
Phantom section: Flat Section

Test Date: Date: 9/27/2023; Ambient Temp: 23 °C; Tissue Temp: 21 °C

Probe: EX3DV4 - SN3662; ConvF(7.91, 7.91, 7.91); Calibrated: 2/10/2023  
Sensor-Surface: 2mm (Mechanical Surface Detection)  
Electronics: DAE4 Sn1416; Calibrated: 4/19/2023  
Phantom: ELI v5.0; Type: QDOVA002AA; Serial: 2037  
Measurement SW: DASY52, Version 52.10 (0); SEMCAD X Version 14.6.10 (7417)

### Procedure Notes:

**EG21 B4 LTE/Front Mid 1 RB 49 Offset/Area Scan (7x7x1):** Measurement grid: dx=15mm, dy=15mm

[Info: Interpolated medium parameters used for SAR evaluation.](#)  
Maximum value of SAR (measured) = 0.0540 W/kg

**EG21 B4 LTE/Front Mid 1 RB 49 Offset/Zoom Scan (5x5x7)/Cube 0:** Measurement grid: dx=8mm, dy=8mm, dz=5mm  
Reference Value = 5.489 V/m; Power Drift = 0.01 dB  
Peak SAR (extrapolated) = 0.0670 W/kg  
**SAR(1 g) = 0.044 W/kg; SAR(10 g) = 0.029 W/kg**

[Info: Interpolated medium parameters used for SAR evaluation.](#)  
Maximum value of SAR (measured) = 0.0562 W/kg

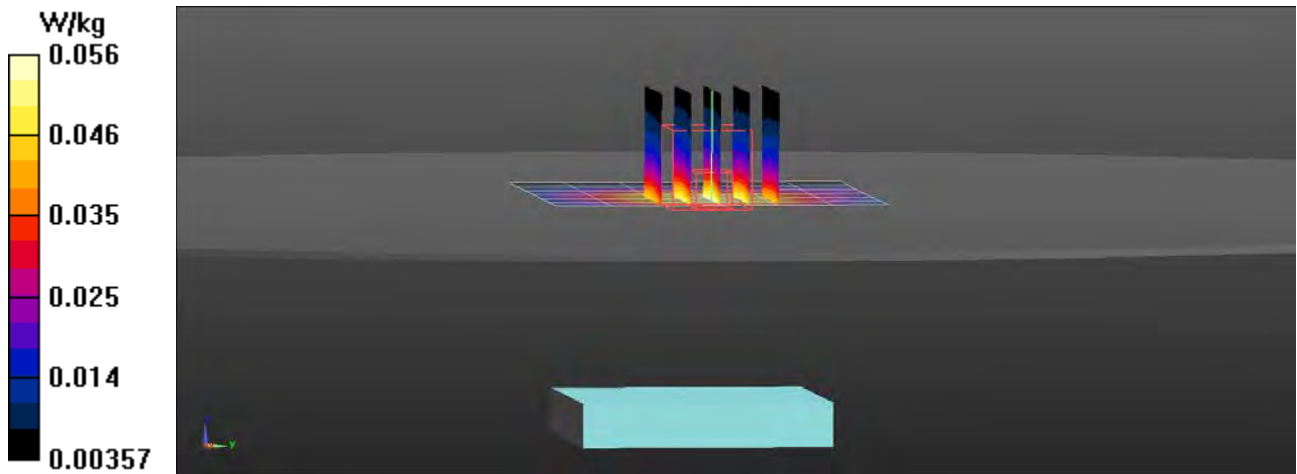

# RF Exposure Lab

## Plot 7

**DUT: EG21-G; Type: Comm Unit; Serial: 042**

Communication System: LTE (SC-FDMA, 1 RB, 20 MHz, QPSK); Frequency: 2535 MHz; Duty Cycle: 1:1  
Medium: HSL2550; Medium parameters used (interpolated):  $f = 2535$  MHz;  $\sigma = 1.905$  S/m;  $\epsilon_r = 38.725$ ;  $\rho = 1000$  kg/m<sup>3</sup>  
Phantom section: Flat Section

Test Date: Date: 10/4/2023; Ambient Temp: 23 °C; Tissue Temp: 21 °C

Probe: EX3DV4 - SN3662; ConvF(7.11, 7.11, 7.11); Calibrated: 2/10/2023  
Sensor-Surface: 2mm (Mechanical Surface Detection)  
Electronics: DAE4 Sn1416; Calibrated: 4/19/2023  
Phantom: ELI v5.0; Type: QDOVA002AA; Serial: 2037  
Measurement SW: DASY52, Version 52.10 (0); SEMCAD X Version 14.6.10 (7417)

### Procedure Notes:

**EG21 B7 LTE/Front Mid 1 RB 49 Offset/Area Scan (10x11x1):** Measurement grid: dx=10mm, dy=10mm

[Info: Interpolated medium parameters used for SAR evaluation.](#)  
Maximum value of SAR (measured) = 0.0852 W/kg

**EG21 B7 LTE/Front Mid 1 RB 49 Offset/Zoom Scan (7x7x7)/Cube 0:** Measurement grid: dx=5mm, dy=5mm, dz=5mm  
Reference Value = 4.942 V/m; Power Drift = 0.06 dB  
Peak SAR (extrapolated) = 0.113 W/kg  
**SAR(1 g) = 0.064 W/kg; SAR(10 g) = 0.037 W/kg**

[Info: Interpolated medium parameters used for SAR evaluation.](#)  
Maximum value of SAR (measured) = 0.0880 W/kg

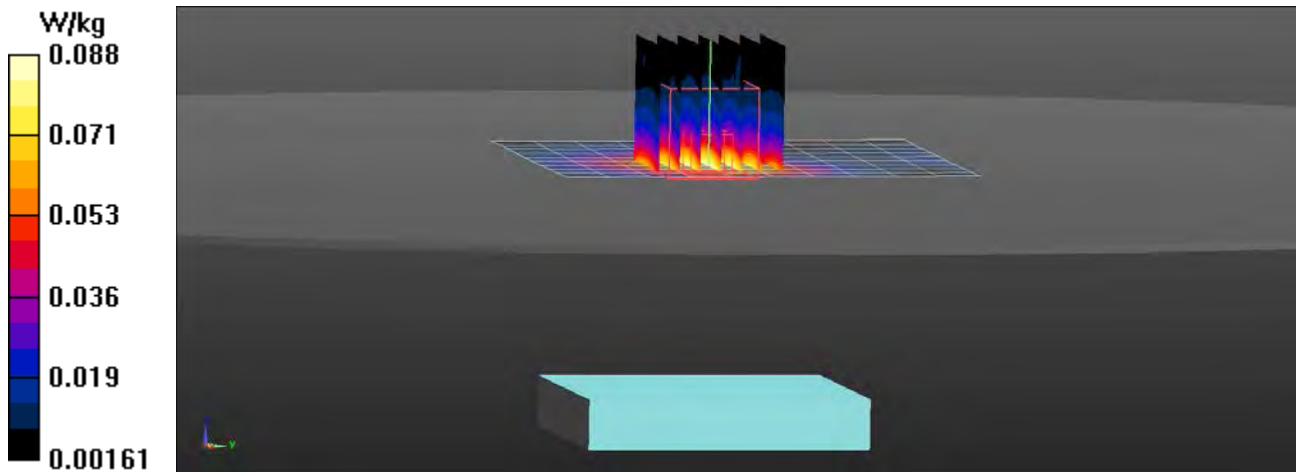

# RF Exposure Lab

## Plot 8

**DUT: EG21-G; Type: Comm Unit; Serial: 042**

Communication System: LTE (SC-FDMA, 1 RB, 10 MHz, QPSK); Frequency: 707.5 MHz; Duty Cycle: 1:1  
Medium: HSL750; Medium parameters used (interpolated):  $f = 707.5$  MHz;  $\sigma = 0.888$  S/m;  $\epsilon_r = 41.138$ ;  $\rho = 1000$  kg/m<sup>3</sup>  
Phantom section: Flat Section

Test Date: Date: 9/27/2023; Ambient Temp: 23 °C; Tissue Temp: 21 °C

Probe: EX3DV4 - SN3662; ConvF(9.28, 9.28, 9.28); Calibrated: 2/10/2023  
Sensor-Surface: 2mm (Mechanical Surface Detection)  
Electronics: DAE4 Sn1416; Calibrated: 4/19/2023  
Phantom: ELI v5.0; Type: QDOVA002AA; Serial: 2037  
Measurement SW: DASY52, Version 52.10 (0); SEMCAD X Version 14.6.10 (7417)

### Procedure Notes:

**EG21 B12 LTE/Front Mid 1 RB 24 Offset/Area Scan (7x7x1):** Measurement grid: dx=15mm, dy=15mm

[Info: Interpolated medium parameters used for SAR evaluation.](#)  
Maximum value of SAR (measured) = 0.214 W/kg

**EG21 B12 LTE/Front Mid 1 RB 24 Offset/Zoom Scan (5x5x7)/Cube 0:** Measurement grid: dx=8mm, dy=8mm, dz=5mm  
Reference Value = 11.75 V/m; Power Drift = -0.08 dB  
Peak SAR (extrapolated) = 0.253 W/kg  
**SAR(1 g) = 0.189 W/kg; SAR(10 g) = 0.139 W/kg**

[Info: Interpolated medium parameters used for SAR evaluation.](#)  
Maximum value of SAR (measured) = 0.226 W/kg

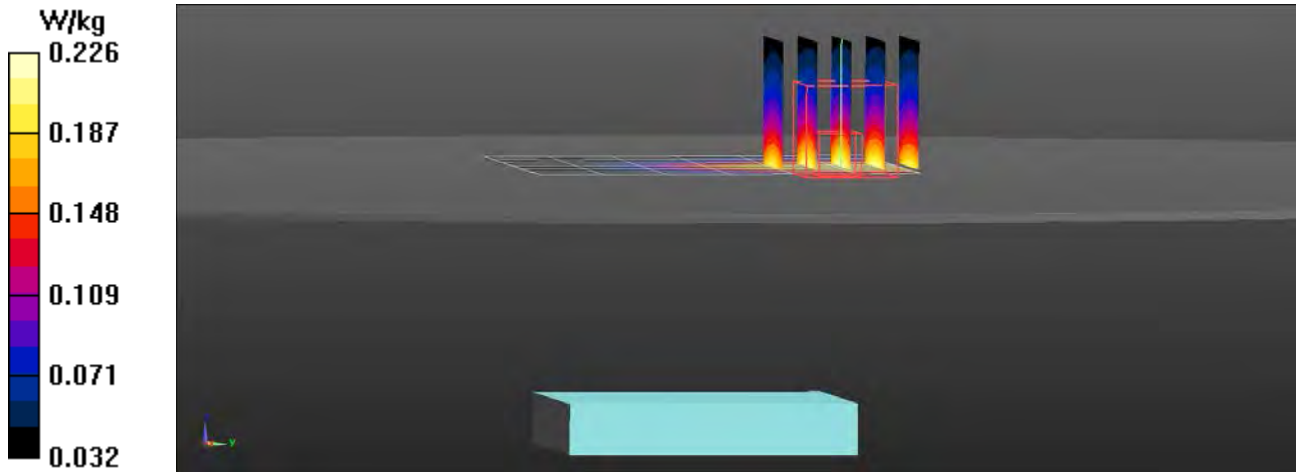



# RF Exposure Lab

## Plot 9

**DUT: EG21-G; Type: Comm Unit; Serial: 042**

Communication System: LTE (SC-FDMA, 1 RB, 10 MHz, QPSK); Frequency: 782 MHz; Duty Cycle: 1:1  
Medium: HSL750; Medium parameters used (interpolated):  $f = 782 \text{ MHz}$ ;  $\sigma = 0.942 \text{ S/m}$ ;  $\epsilon_r = 40.698$ ;  $\rho = 1000 \text{ kg/m}^3$   
Phantom section: Flat Section

Test Date: Date: 9/27/2023; Ambient Temp: 23 °C; Tissue Temp: 21 °C

Probe: EX3DV4 - SN3662; ConvF(9.28, 9.28, 9.28); Calibrated: 2/10/2023  
Sensor-Surface: 2mm (Mechanical Surface Detection)  
Electronics: DAE4 Sn1416; Calibrated: 4/19/2023  
Phantom: ELI v5.0; Type: QDOVA002AA; Serial: 2037  
Measurement SW: DASY52, Version 52.10 (0); SEMCAD X Version 14.6.10 (7417)

### Procedure Notes:

**EG21 B13 LTE/Front Mid 1 RB 24 Offset/Area Scan (7x7x1):** Measurement grid: dx=15mm, dy=15mm

[Info: Interpolated medium parameters used for SAR evaluation.](#)  
Maximum value of SAR (measured) = 0.0849 W/kg

**EG21 B13 LTE/Front Mid 1 RB 24 Offset/Zoom Scan (5x5x7)/Cube 0:** Measurement grid: dx=8mm, dy=8mm, dz=5mm  
Reference Value = 7.789 V/m; Power Drift = 0.01 dB  
Peak SAR (extrapolated) = 0.0950 W/kg  
**SAR(1 g) = 0.071 W/kg; SAR(10 g) = 0.051 W/kg**

[Info: Interpolated medium parameters used for SAR evaluation.](#)  
Maximum value of SAR (measured) = 0.0848 W/kg

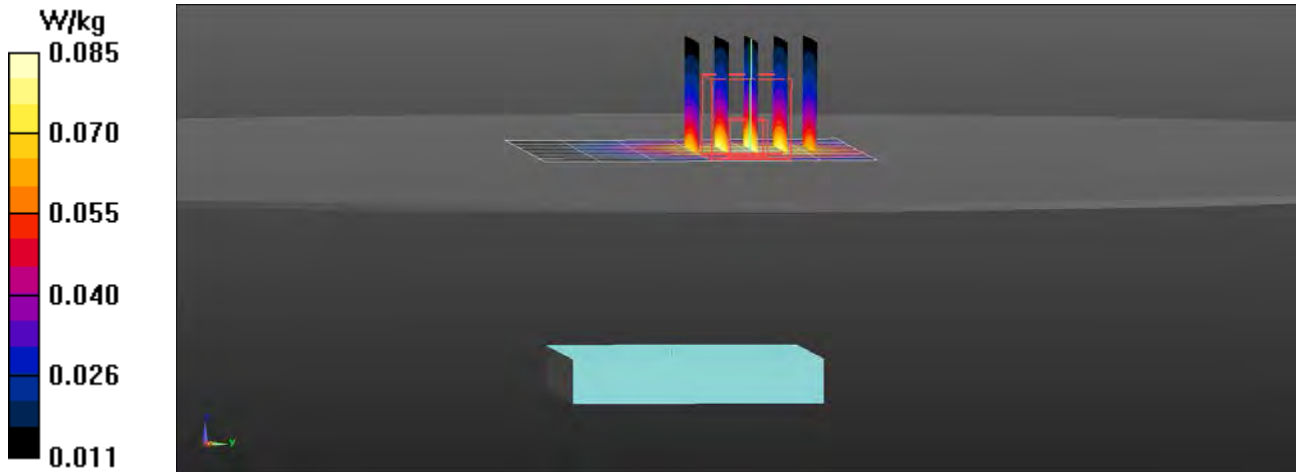

# RF Exposure Lab

## Plot 10

**DUT: EG21-G; Type: Comm Unit; Serial: 042**

Communication System: LTE (SC-FDMA, 1 RB, 20 MHz, QPSK); Frequency: 1882.5 MHz; Duty Cycle: 1:1  
Medium: HSL1900; Medium parameters used (interpolated):  $f = 1882.5$  MHz;  $\sigma = 1.42$  S/m;  $\epsilon_r = 39.685$ ;  $\rho = 1000$  kg/m<sup>3</sup>  
Phantom section: Flat Section

Test Date: Date: 9/28/2023; Ambient Temp: 23 °C; Tissue Temp: 21 °C

Probe: EX3DV4 - SN3662; ConvF(7.67, 7.67, 7.67); Calibrated: 2/10/2023  
Sensor-Surface: 2mm (Mechanical Surface Detection)  
Electronics: DAE4 Sn1416; Calibrated: 4/19/2023  
Phantom: ELI v5.0; Type: QDOVA002AA; Serial: 2037  
Measurement SW: DASY52, Version 52.10 (0); SEMCAD X Version 14.6.10 (7417)

### Procedure Notes:

**EG21 B25 LTE/Front Mid 1 RB 49 Offset/Area Scan (7x7x1):** Measurement grid: dx=15mm, dy=15mm

[Info: Interpolated medium parameters used for SAR evaluation.](#)  
Maximum value of SAR (measured) = 0.118 W/kg

**EG21 B25 LTE/Front Mid 1 RB 49 Offset/Zoom Scan (5x5x7)/Cube 0:** Measurement grid: dx=8mm, dy=8mm, dz=5mm  
Reference Value = 8.078 V/m; Power Drift = 0.05 dB  
Peak SAR (extrapolated) = 0.146 W/kg  
**SAR(1 g) = 0.094 W/kg; SAR(10 g) = 0.061 W/kg**

[Info: Interpolated medium parameters used for SAR evaluation.](#)  
Maximum value of SAR (measured) = 0.120 W/kg

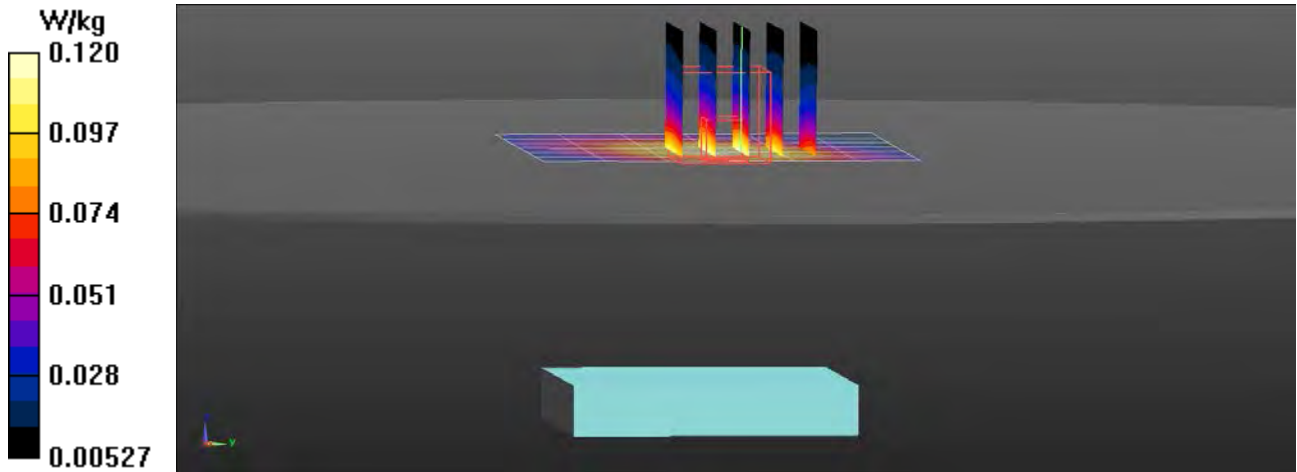

# RF Exposure Lab

## Plot 11

**DUT: EG21-G; Type: Comm Unit; Serial: 042**

Communication System: LTE (SC-FDMA, 1 RB, 10 MHz, QPSK); Frequency: 831.5 MHz; Duty Cycle: 1:1  
Medium: HSL900; Medium parameters used (interpolated):  $f = 831.5$  MHz;  $\sigma = 0.932$  S/m;  $\epsilon_r = 40.976$ ;  $\rho = 1000$  kg/m<sup>3</sup>  
Phantom section: Flat Section

Test Date: Date: 10/3/2023; Ambient Temp: 23 °C; Tissue Temp: 21 °C

Probe: EX3DV4 - SN3662; ConvF(8.8, 8.8, 8.8); Calibrated: 2/10/2023  
Sensor-Surface: 2mm (Mechanical Surface Detection)  
Electronics: DAE4 Sn1416; Calibrated: 4/19/2023  
Phantom: ELI v5.0; Type: QDOVA002AA; Serial: 2037  
Measurement SW: DASY52, Version 52.10 (0); SEMCAD X Version 14.6.10 (7417)

### Procedure Notes:

**EG21 B26 LTE/Front Mid 1 RB 24 Offset/Area Scan (7x7x1):** Measurement grid: dx=15mm, dy=15mm

[Info: Interpolated medium parameters used for SAR evaluation.](#)  
Maximum value of SAR (measured) = 0.164 W/kg

**EG21 B26 LTE/Front Mid 1 RB 24 Offset/Zoom Scan (5x5x7)/Cube 0:** Measurement grid: dx=8mm, dy=8mm, dz=5mm  
Reference Value = 10.62 V/m; Power Drift = -0.04 dB  
Peak SAR (extrapolated) = 0.204 W/kg  
**SAR(1 g) = 0.147 W/kg; SAR(10 g) = 0.103 W/kg**

[Info: Interpolated medium parameters used for SAR evaluation.](#)  
Maximum value of SAR (measured) = 0.178 W/kg

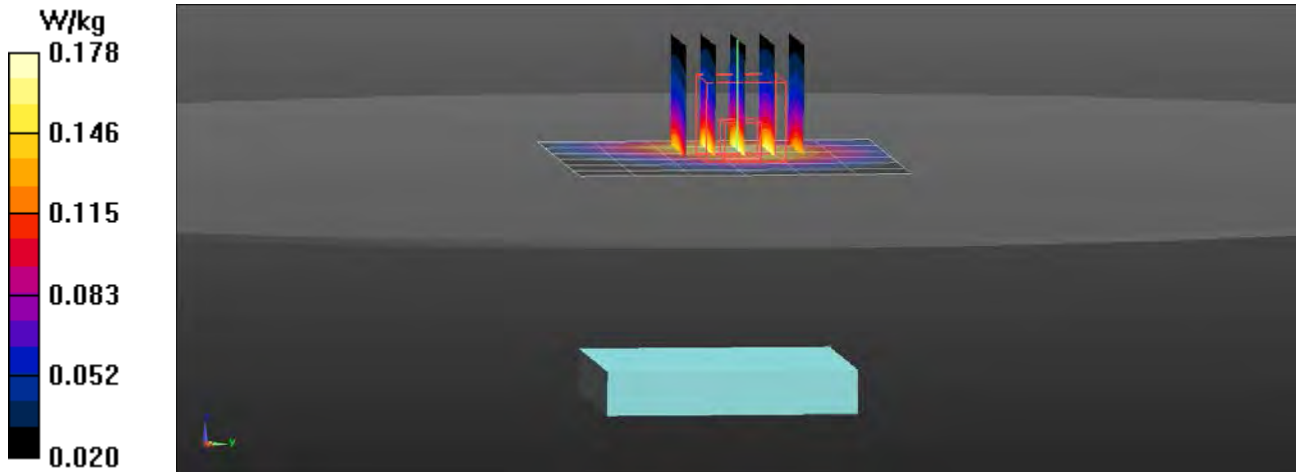

# RF Exposure Lab

## Plot 12

**DUT: EG21-G; Type: Comm Unit; Serial: 042**

Communication System: LTE (SC-FDMA, 1 RB, 20 MHz, QPSK); Frequency: 2593 MHz; Duty Cycle: 1:1  
Medium: HSL2550; Medium parameters used (interpolated):  $f = 2593$  MHz;  $\sigma = 1.98$  S/m;  $\epsilon_r = 38.593$ ;  $\rho = 1000$  kg/m<sup>3</sup>  
Phantom section: Flat Section

Test Date: Date: 10/4/2023; Ambient Temp: 23 °C; Tissue Temp: 21 °C

Probe: EX3DV4 - SN3662; ConvF(7.11, 7.11, 7.11); Calibrated: 2/10/2023  
Sensor-Surface: 2mm (Mechanical Surface Detection)  
Electronics: DAE4 Sn1416; Calibrated: 4/19/2023  
Phantom: ELI v5.0; Type: QDOVA002AA; Serial: 2037  
Measurement SW: DASY52, Version 52.10 (0); SEMCAD X Version 14.6.10 (7417)

### Procedure Notes:

**EG21 B41 LTE/Front Mid 1 RB 49 Offset/Area Scan (10x11x1):** Measurement grid: dx=10mm, dy=10mm

[Info: Interpolated medium parameters used for SAR evaluation.](#)  
Maximum value of SAR (measured) = 0.0358 W/kg

**EG21 B41 LTE/Front Mid 1 RB 49 Offset/Zoom Scan (7x7x7)/Cube 0:** Measurement grid: dx=5mm, dy=5mm, dz=5mm  
Reference Value = 2.197 V/m; Power Drift = 0.09 dB  
Peak SAR (extrapolated) = 0.0440 W/kg  
**SAR(1 g) = 0.026 W/kg; SAR(10 g) = 0.015 W/kg**

[Info: Interpolated medium parameters used for SAR evaluation.](#)  
Maximum value of SAR (measured) = 0.0353 W/kg

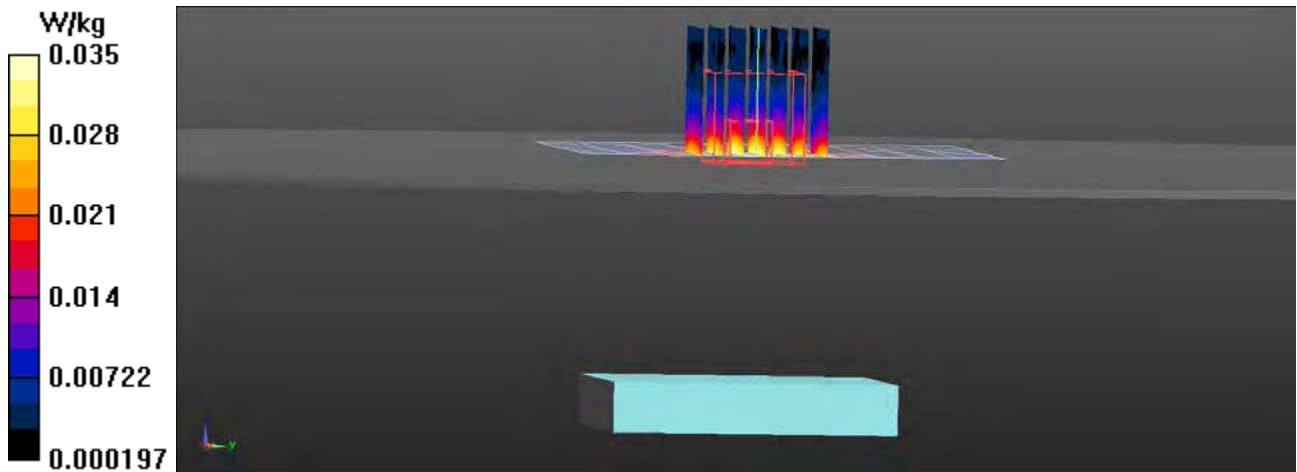

# RF Exposure Lab

## Plot 13

**DUT: BG77; Type: Comm Unit; Serial: 042**

Communication System: LTE (SC-FDMA, 1 RB, 1.4 MHz, QPSK); Frequency: 707.5 MHz; Duty Cycle: 1:5.00035  
Medium: HSL750; Medium parameters used (interpolated):  $f = 707.5$  MHz;  $\sigma = 0.868$  S/m;  $\epsilon_r = 41.708$ ;  $\rho = 1000$  kg/m<sup>3</sup>  
Phantom section: Flat Section

Test Date: Date: 4/14/2023; Ambient Temp: 23 °C; Tissue Temp: 21 °C

Probe: EX3DV4 - SN3662; ConvF(9.28, 9.28, 9.28); Calibrated: 2/10/2023  
Sensor-Surface: 2mm (Mechanical Surface Detection)  
Electronics: DAE4 Sn1217; Calibrated: 2/14/2023  
Phantom: ELI v5.0; Type: QDOVA002AA; Serial: 2037  
Measurement SW: DASY52, Version 52.10 (0); SEMCAD X Version 14.6.10 (7417)

### Procedure Notes:

**BG77 B12 LTE/Front Mid 1 RB 3 Offset/Area Scan (7x7x1):** Measurement grid: dx=15mm, dy=15mm

[Info: Interpolated medium parameters used for SAR evaluation.](#)  
Maximum value of SAR (measured) = 0.00575 W/kg

**BG77 B12 LTE/Front Mid 1 RB 3 Offset/Zoom Scan (6x6x7)/Cube 0:** Measurement grid: dx=8mm, dy=8mm, dz=5mm  
Reference Value = 2.207 V/m; Power Drift = 0.06 dB  
Peak SAR (extrapolated) = 0.00733 W/kg  
**SAR(1 g) = 0.00525 W/kg; SAR(10 g) = 0.00398 W/kg**

[Info: Interpolated medium parameters used for SAR evaluation.](#)  
Maximum value of SAR (measured) = 0.00628 W/kg

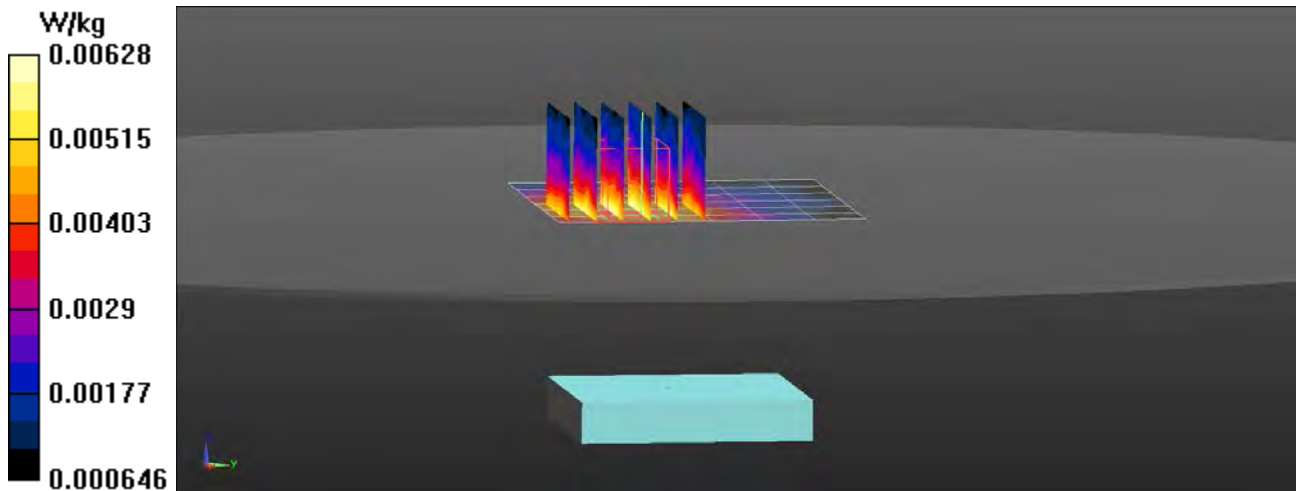

# RF Exposure Lab

## Plot 14

**DUT: BG77; Type: Comm Unit; Serial: 042**

Communication System: LTE (SC-FDMA, 1 RB, 1.4 MHz, QPSK); Frequency: 782 MHz; Duty Cycle: 1:5.00035  
Medium: HSL750; Medium parameters used (interpolated):  $f = 782 \text{ MHz}$ ;  $\sigma = 0.922 \text{ S/m}$ ;  $\epsilon_r = 41.268$ ;  $\rho = 1000 \text{ kg/m}^3$   
Phantom section: Flat Section

Test Date: Date: 4/14/2023; Ambient Temp: 23 °C; Tissue Temp: 21 °C

Probe: EX3DV4 - SN3662; ConvF(9.28, 9.28, 9.28); Calibrated: 2/10/2023  
Sensor-Surface: 2mm (Mechanical Surface Detection)  
Electronics: DAE4 Sn1217; Calibrated: 2/14/2023  
Phantom: ELI v5.0; Type: QDOVA002AA; Serial: 2037  
Measurement SW: DASY52, Version 52.10 (0); SEMCAD X Version 14.6.10 (7417)

### Procedure Notes:

**BG77 B13 LTE/Front Mid 1 RB 3 Offset/Area Scan (7x8x1):** Measurement grid: dx=15mm, dy=15mm

[Info: Interpolated medium parameters used for SAR evaluation.](#)  
Maximum value of SAR (measured) = 0.00389 W/kg

**BG77 B13 LTE/Front Mid 1 RB 3 Offset/Zoom Scan (7x8x7)/Cube 0:** Measurement grid: dx=8mm, dy=8mm, dz=5mm  
Reference Value = 1.792 V/m; Power Drift = -0.05 dB  
Peak SAR (extrapolated) = 0.00466 W/kg  
**SAR(1 g) = 0.00328 W/kg; SAR(10 g) = 0.0024 W/kg**

[Info: Interpolated medium parameters used for SAR evaluation.](#)  
Maximum value of SAR (measured) = 0.00397 W/kg

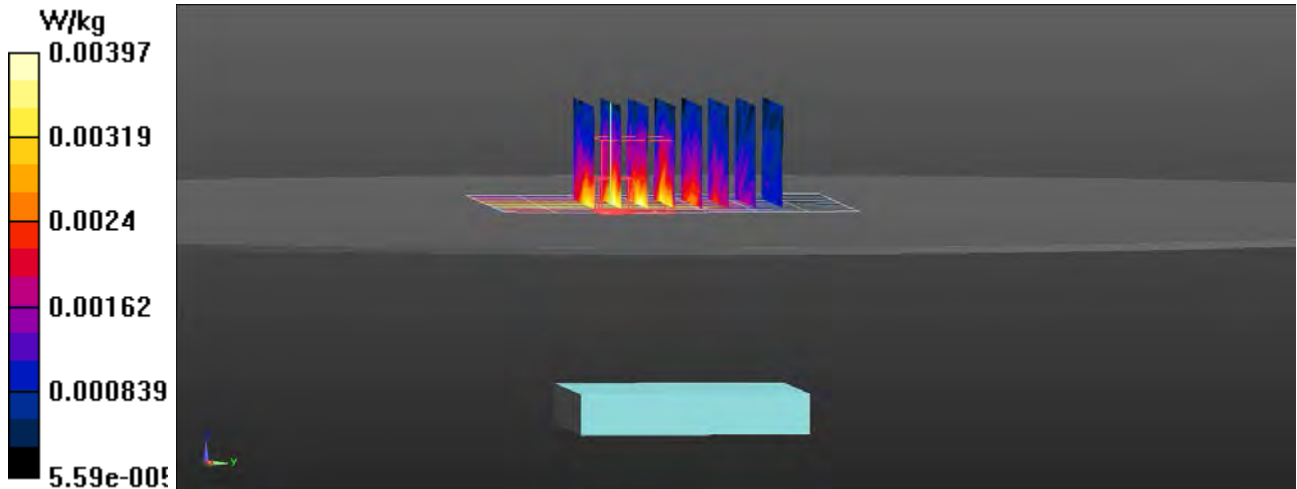

# RF Exposure Lab

## Plot 15

**DUT: BG77; Type: Comm Unit; Serial: 042**

Communication System: LTE (SC-FDMA, 1 RB, 1.4 MHz, QPSK); Frequency: 1882.5 MHz; Duty Cycle: 1:5.00035  
Medium: HSL1900; Medium parameters used (interpolated):  $f = 1882.5$  MHz;  $\sigma = 1.39$  S/m;  $\epsilon_r = 39.905$ ;  $\rho = 1000$  kg/m<sup>3</sup>  
Phantom section: Flat Section

Test Date: Date: 4/15/2023; Ambient Temp: 23 °C; Tissue Temp: 21 °C

Probe: EX3DV4 - SN3662; ConvF(7.67, 7.67, 7.67); Calibrated: 2/10/2023  
Sensor-Surface: 2mm (Mechanical Surface Detection)  
Electronics: DAE4 Sn1217; Calibrated: 2/14/2023  
Phantom: ELI v5.0; Type: QDOVA002AA; Serial: 2037  
Measurement SW: DASY52, Version 52.10 (0); SEMCAD X Version 14.6.10 (7417)

### Procedure Notes:

**BG77 B25 LTE/Front Mid 1 RB 3 Offset/Area Scan (7x7x1):** Measurement grid: dx=15mm, dy=15mm

[Info: Interpolated medium parameters used for SAR evaluation.](#)  
Maximum value of SAR (measured) = 0.0229 W/kg

**BG77 B25 LTE/Front Mid 1 RB 3 Offset/Zoom Scan (6x6x7)/Cube 0:** Measurement grid: dx=8mm, dy=8mm, dz=5mm  
Reference Value = 3.412 V/m; Power Drift = -0.01 dB  
Peak SAR (extrapolated) = 0.0250 W/kg  
**SAR(1 g) = 0.017 W/kg; SAR(10 g) = 0.011 W/kg**

[Info: Interpolated medium parameters used for SAR evaluation.](#)  
Maximum value of SAR (measured) = 0.0212 W/kg

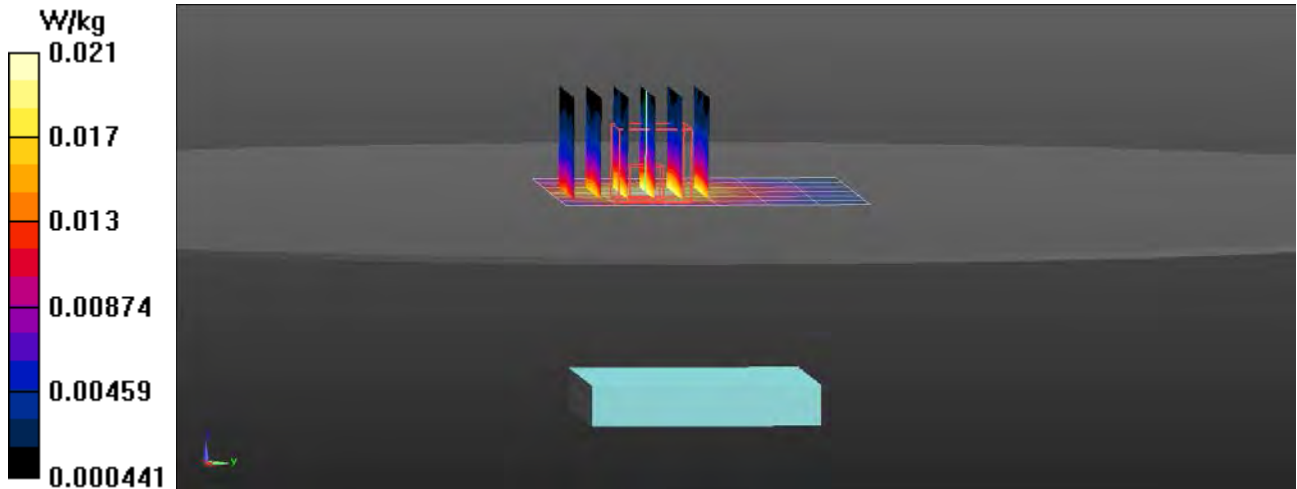

# RF Exposure Lab

## Plot 16

**DUT: BG77; Type: Comm Unit; Serial: 042**

Communication System: LTE (SC-FDMA, 1 RB, 1.4 MHz, QPSK); Frequency: 831.5 MHz; Duty Cycle: 1:5.00035  
Medium: HSL835; Medium parameters used (interpolated):  $f = 831.5$  MHz;  $\sigma = 0.912$  S/m;  $\epsilon_r = 41.456$ ;  $\rho = 1000$  kg/m<sup>3</sup>  
Phantom section: Flat Section

Test Date: Date: 4/14/2023; Ambient Temp: 23 °C; Tissue Temp: 21 °C

Probe: EX3DV4 - SN3662; ConvF(8.8, 8.8, 8.8); Calibrated: 2/10/2023  
Sensor-Surface: 2mm (Mechanical Surface Detection)  
Electronics: DAE4 Sn1217; Calibrated: 2/14/2023  
Phantom: ELI v5.0; Type: QDOVA002AA; Serial: 2037  
Measurement SW: DASY52, Version 52.10 (0); SEMCAD X Version 14.6.10 (7417)

### Procedure Notes:

**BG77 B26 LTE/Front Mid 1 RB 3 Offset/Area Scan (7x7x1):** Measurement grid: dx=15mm, dy=15mm

[Info: Interpolated medium parameters used for SAR evaluation.](#)  
Maximum value of SAR (measured) = 0.00450 W/kg

**BG77 B26 LTE/Front Mid 1 RB 3 Offset/Zoom Scan (5x5x7)/Cube 0:** Measurement grid: dx=8mm, dy=8mm, dz=5mm  
Reference Value = 1.641 V/m; Power Drift = -0.06 dB  
Peak SAR (extrapolated) = 0.00511 W/kg  
**SAR(1 g) = 0.0037 W/kg; SAR(10 g) = 0.00272 W/kg**

[Info: Interpolated medium parameters used for SAR evaluation.](#)  
Maximum value of SAR (measured) = 0.00442 W/kg

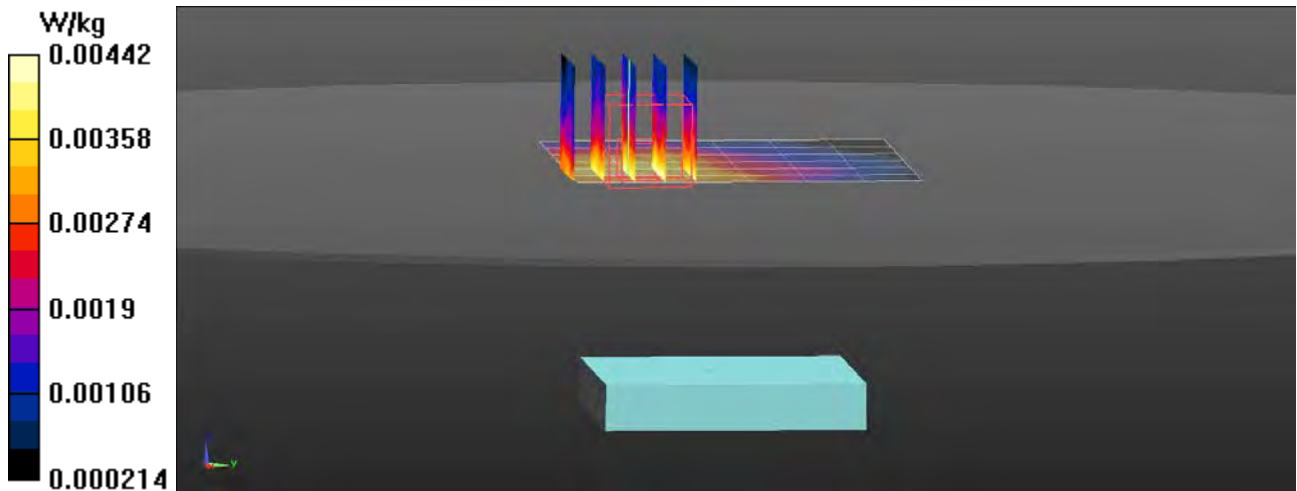



# RF Exposure Lab

## Plot 17

**DUT: BG77; Type: Comm Unit; Serial: 042**

Communication System: LTE (SC-FDMA, 1 RB, 1.4 MHz, QPSK); Frequency: 815.5 MHz; Duty Cycle: 1:5.00035  
Medium: HSL835; Medium parameters used (interpolated):  $f = 815.5$  MHz;  $\sigma = 0.906$  S/m;  $\epsilon_r = 41.437$ ;  $\rho = 1000$  kg/m<sup>3</sup>  
Phantom section: Flat Section

Test Date: Date: 4/14/2023; Ambient Temp: 23 °C; Tissue Temp: 21 °C

Probe: EX3DV4 - SN3662; ConvF(8.8, 8.8, 8.8); Calibrated: 2/10/2023  
Sensor-Surface: 2mm (Mechanical Surface Detection)  
Electronics: DAE4 Sn1217; Calibrated: 2/14/2023  
Phantom: ELI v5.0; Type: QDOVA002AA; Serial: 2037  
Measurement SW: DASY52, Version 52.10 (0); SEMCAD X Version 14.6.10 (7417)

### Procedure Notes:

**BG77 B27 LTE/Front Mid 1 RB 3 Offset/Area Scan (7x7x1):** Measurement grid: dx=15mm, dy=15mm

[Info: Interpolated medium parameters used for SAR evaluation.](#)  
Maximum value of SAR (measured) = 0.00294 W/kg

**BG77 B27 LTE/Front Mid 1 RB 3 Offset/Zoom Scan (8x8x7)/Cube 0:** Measurement grid: dx=8mm, dy=8mm, dz=5mm  
Reference Value = 1.421 V/m; Power Drift = 0.06 dB  
Peak SAR (extrapolated) = 0.00397 W/kg  
**SAR(1 g) = 0.00268 W/kg; SAR(10 g) = 0.002 W/kg**

[Info: Interpolated medium parameters used for SAR evaluation.](#)  
Maximum value of SAR (measured) = 0.00332 W/kg

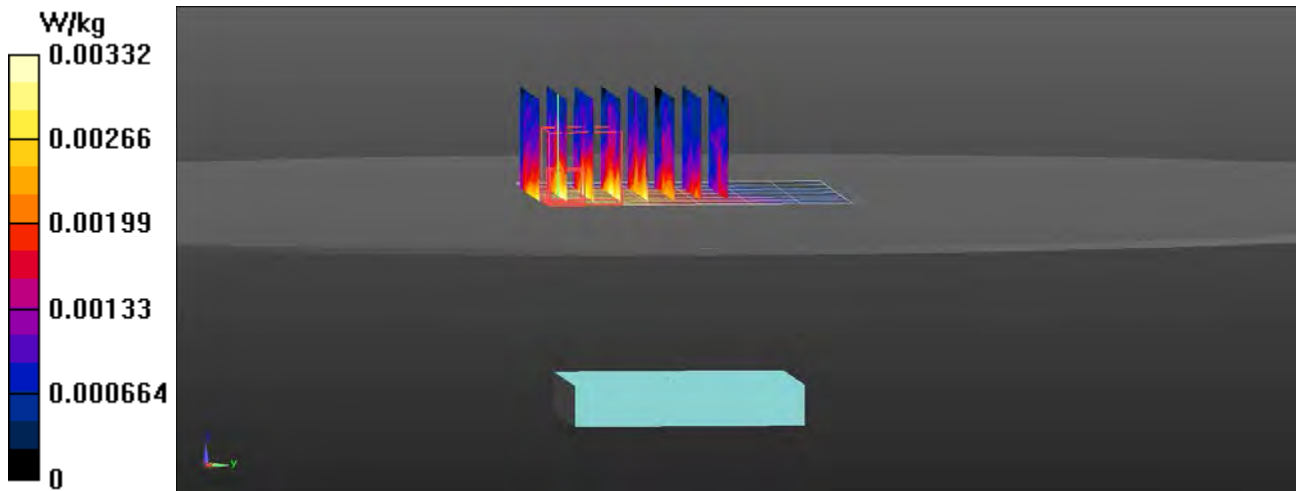

# RF Exposure Lab

## Plot 18

**DUT: BG77; Type: Comm Unit; Serial: 042**

Communication System: LTE (SC-FDMA, 1 RB, 1.4 MHz, QPSK); Frequency: 1745 MHz; Duty Cycle: 1:5.00035  
Medium: HSL1750; Medium parameters used (interpolated):  $f = 1745$  MHz;  $\sigma = 1.395$  S/m;  $\epsilon_r = 39.25$ ;  $\rho = 1000$  kg/m<sup>3</sup>  
Phantom section: Flat Section

Test Date: Date: 4/15/2023; Ambient Temp: 23 °C; Tissue Temp: 21 °C

Probe: EX3DV4 - SN3662; ConvF(7.91, 7.91, 7.91); Calibrated: 2/10/2023  
Sensor-Surface: 2mm (Mechanical Surface Detection)  
Electronics: DAE4 Sn1217; Calibrated: 2/14/2023  
Phantom: ELI v5.0; Type: QDOVA002AA; Serial: 2037  
Measurement SW: DASY52, Version 52.10 (0); SEMCAD X Version 14.6.10 (7417)

### Procedure Notes:

**BG77 B66 LTE/Front Mid 1 RB 3 Offset/Area Scan (9x7x1):** Measurement grid: dx=15mm, dy=15mm

[Info: Interpolated medium parameters used for SAR evaluation.](#)  
Maximum value of SAR (measured) = 0.00261 W/kg

**BG77 B66 LTE/Front Mid 1 RB 3 Offset/Zoom Scan (7x9x7)/Cube 0:** Measurement grid: dx=8mm, dy=8mm, dz=5mm  
Reference Value = 0.6760 V/m; Power Drift = -0.03 dB  
Peak SAR (extrapolated) = 0.00394 W/kg  
**SAR(1 g) = 0.00126 W/kg; SAR(10 g) = 0.000371 W/kg**

[Info: Interpolated medium parameters used for SAR evaluation.](#)  
Maximum value of SAR (measured) = 0.00276 W/kg

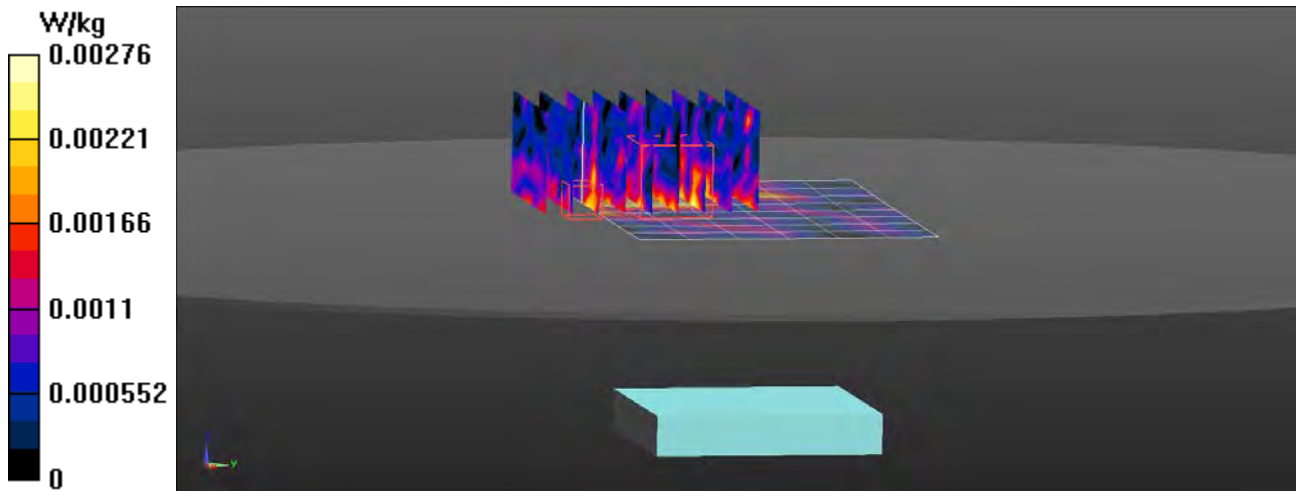

**Appendix C – SAR Test Setup Photos**



**Test Position Front 50 mm Gap**

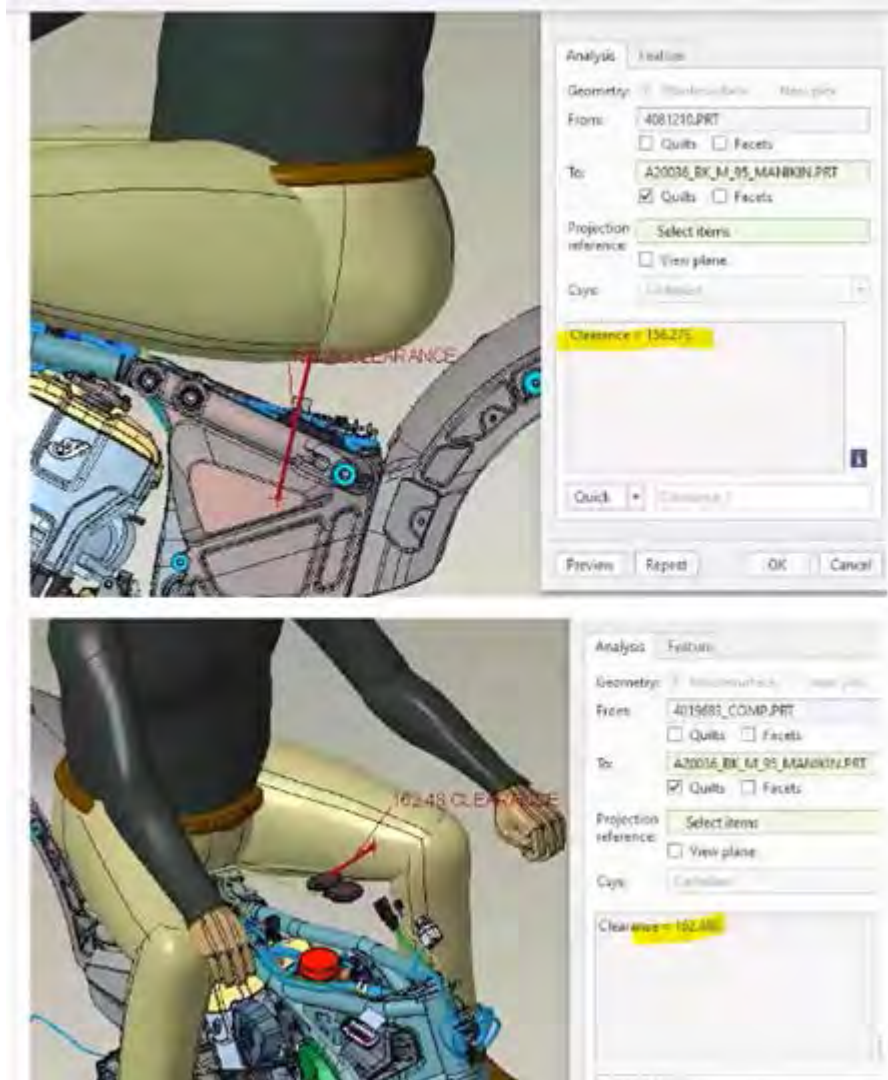

### Installation Drawing

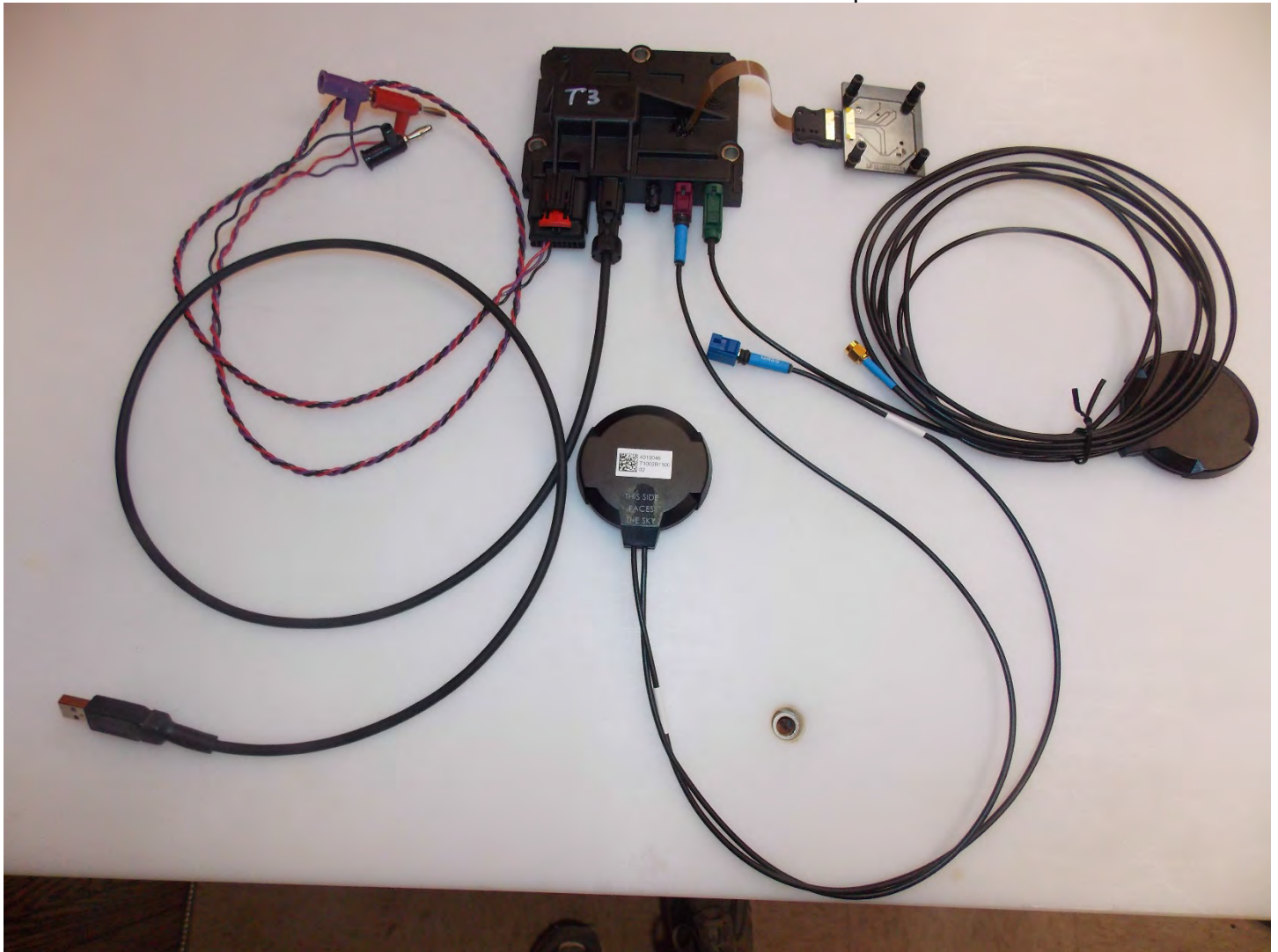

**Test System**



**Front of Transmit Antenna**

## Appendix D – Probe Calibration Data Sheets



Accredited by the Swiss Accreditation Service (SAS)  
The Swiss Accreditation Service is one of the signatories to the EA  
Multilateral Agreement for the recognition of calibration certificates

Accreditation No.: **SCS 0108**

Client **RF Exposure Lab**

Certificate No **EX-3662\_Feb23**

**CALIBRATION CERTIFICATE**

Object **EX3DV4 - SN:3662**

Calibration procedure(s) **QA CAL-01.v10, QA CAL-12.v10, QA CAL-14.v7, QA CAL-23.v6,  
QA CAL-25.v8  
Calibration procedure for dosimetric E-field probes**

Calibration date **February 10, 2023**

This calibration certificate documents the traceability to national standards, which realize the physical units of measurements (SI).  
The measurements and the uncertainties with confidence probability are given on the following pages and are part of the certificate.  
All calibrations have been conducted in the closed laboratory facility: environment temperature (22 ± 3) °C and humidity < 70%.  
Calibration Equipment used (M&TE critical for calibration)

Primary Standards	ID	Cal Date (Certificate No.)	Scheduled Calibration
Power meter NRP	SN: 104778	04-Apr-22 (No. 217-03525/03524)	Apr-23
Power sensor NRP-Z91	SN: 103244	04-Apr-22 (No. 217-03524)	Apr-23
OCP DAK-3.5 (weighted)	SN: 1249	20-Oct-22 (OCP-DAK3.5-1249_Oct22)	Oct-23
OCP DAK-12	SN: 1016	20-Oct-22 (OCP-DAK12-1016_Oct22)	Oct-23
Reference 20 dB Attenuator	SN: CC2552 (20x)	04-Apr-22 (No. 217-03527)	Apr-23
DAE4	SN: 660	10-Oct-22 (No. DAE4-660_Oct22)	Oct-23
Reference Probe ES3DV2	SN: 3013	06-Jan-23 (No. ES3-3013_Jan23)	Jan-24

Secondary Standards	ID	Check Date (in house)	Scheduled Check
Power meter E4419B	SN: GB41293874	06-Apr-16 (in house check Jun-22)	In house check: Jun-24
Power sensor E4412A	SN: MY41498087	06-Apr-16 (in house check Jun-22)	In house check: Jun-24
Power sensor E4412A	SN: 000110210	06-Apr-16 (in house check Jun-22)	In house check: Jun-24
RF generator HP 8648C	SN: US3642U01700	04-Aug-99 (in house check Jun-22)	In house check: Jun-24
Network Analyzer E8358A	SN: US41080477	31-Mar-14 (in house check Oct-22)	In house check: Oct-24

	Name	Function	Signature
Calibrated by	Michael Weber	Laboratory Technician	
Approved by	Sven Kühn	Technical Manager	

Issued: February 10, 2023

This calibration certificate shall not be reproduced except in full without written approval of the laboratory.





Accredited by the Swiss Accreditation Service (SAS)  
**The Swiss Accreditation Service is one of the signatories to the EA  
Multilateral Agreement for the recognition of calibration certificates**

**Accreditation No.: SCS 0108**

## Glossary

TSL	tissue simulating liquid
NORM <sub>x,y,z</sub>	sensitivity in free space
ConvF	sensitivity in TSL / NORM <sub>x,y,z</sub>
DCP	diode compression point
CF	crest factor (1/duty_cycle) of the RF signal
A, B, C, D	modulation dependent linearization parameters
Polarization $\varphi$	$\varphi$ rotation around probe axis
Polarization $\vartheta$	$\vartheta$ rotation around an axis that is in the plane normal to probe axis (at measurement center), i.e., $\vartheta = 0$ is normal to probe axis
Connector Angle	information used in DASY system to align probe sensor X to the robot coordinate system

## Calibration is Performed According to the Following Standards:

- IEC/IEEE 62209-1528, "Measurement Procedure For The Assessment Of Specific Absorption Rate Of Human Exposure To Radio Frequency Fields From Hand-Held And Body-Worn Wireless Communication Devices – Part 1528: Human Models, Instrumentation And Procedures (Frequency Range of 4 MHz to 10 GHz)", October 2020.
- KDB 865664, "SAR Measurement Requirements for 100 MHz to 6 GHz"

## Methods Applied and Interpretation of Parameters:

- NORM<sub>x,y,z</sub>**: Assessed for E-field polarization  $\vartheta = 0$  ( $f \leq 900$  MHz in TEM-cell;  $f > 1800$  MHz: R22 waveguide). NORM<sub>x,y,z</sub> are only intermediate values, i.e., the uncertainties of NORM<sub>x,y,z</sub> does not affect the E<sup>2</sup>-field uncertainty inside TSL (see below ConvF).
- NORM(f)<sub>x,y,z</sub>** = NORM<sub>x,y,z</sub> \* frequency\_response (see Frequency Response Chart). This linearization is implemented in DASY4 software versions later than 4.2. The uncertainty of the frequency response is included in the stated uncertainty of ConvF.
- DCP<sub>x,y,z</sub>**: DCP are numerical linearization parameters assessed based on the data of power sweep with CW signal. DCP does not depend on frequency nor media.
- PAR**: PAR is the Peak to Average Ratio that is not calibrated but determined based on the signal characteristics
- A<sub>x,y,z</sub>; B<sub>x,y,z</sub>; C<sub>x,y,z</sub>; D<sub>x,y,z</sub>; VR<sub>x,y,z</sub>**: A, B, C, D are numerical linearization parameters assessed based on the data of power sweep for specific modulation signal. The parameters do not depend on frequency nor media. VR is the maximum calibration range expressed in RMS voltage across the diode.
- ConvF and Boundary Effect Parameters**: Assessed in flat phantom using E-field (or Temperature Transfer Standard for  $f \leq 800$  MHz) and inside waveguide using analytical field distributions based on power measurements for  $f > 800$  MHz. The same setups are used for assessment of the parameters applied for boundary compensation (alpha, depth) of which typical uncertainty values are given. These parameters are used in DASY4 software to improve probe accuracy close to the boundary. The sensitivity in TSL corresponds to NORM<sub>x,y,z</sub> \* ConvF whereby the uncertainty corresponds to that given for ConvF. A frequency dependent ConvF is used in DASY version 4.4 and higher which allows extending the validity from  $\pm 50$  MHz to  $\pm 100$  MHz.
- Spherical isotropy (3D deviation from isotropy)**: in a field of low gradients realized using a flat phantom exposed by a patch antenna.
- Sensor Offset**: The sensor offset corresponds to the offset of virtual measurement center from the probe tip (on probe axis). No tolerance required.
- Connector Angle**: The angle is assessed using the information gained by determining the NORM<sub>x</sub> (no uncertainty required).

**Parameters of Probe: EX3DV4 - SN:3662****Basic Calibration Parameters**

	Sensor X	Sensor Y	Sensor Z	Unc (k = 2)
Norm ( $\mu\text{V}/(\text{V}/\text{m})^2$ ) <sup>A</sup>	0.41	0.49	0.48	±10.1%
DCP (mV) <sup>B</sup>	101.0	102.5	98.0	±4.7%

**Calibration Results for Modulation Response**

UID	Communication System Name		A dB	B dB $\sqrt{\mu\text{V}}$	C	D dB	VR mV	Max dev.	Max Unc <sup>E</sup> k = 2
0	CW	X	0.00	0.00	1.00	0.00	150.8	±3.0%	±4.7%
		Y	0.00	0.00	1.00		161.2		
		Z	0.00	0.00	1.00		147.6		

The reported uncertainty of measurement is stated as the standard uncertainty of measurement multiplied by the coverage factor k=2, which for a normal distribution corresponds to a coverage probability of approximately 95%.

<sup>A</sup> The uncertainties of Norm X,Y,Z do not affect the E<sup>2</sup>-field uncertainty inside TSL (see Page 5).

<sup>B</sup> Linearization parameter uncertainty for maximum specified field strength.

<sup>E</sup> Uncertainty is determined using the max. deviation from linear response applying rectangular distribution and is expressed for the square of the field value.

**Parameters of Probe: EX3DV4 - SN:3662****Other Probe Parameters**

Sensor Arrangement	Triangular
Connector Angle	-96.9°
Mechanical Surface Detection Mode	enabled
Optical Surface Detection Mode	disabled
Probe Overall Length	337 mm
Probe Body Diameter	10 mm
Tip Length	9 mm
Tip Diameter	2.5 mm
Probe Tip to Sensor X Calibration Point	1 mm
Probe Tip to Sensor Y Calibration Point	1 mm
Probe Tip to Sensor Z Calibration Point	1 mm
Recommended Measurement Distance from Surface	1.4 mm

**Note:** Measurement distance from surface can be increased to 3–4 mm for an *Area Scan* job.

**Parameters of Probe: EX3DV4 - SN:3662****Calibration Parameter Determined in Head Tissue Simulating Media**

f (MHz) <sup>C</sup>	Relative Permittivity <sup>F</sup>	Conductivity <sup>F</sup> (S/m)	ConvF X	ConvF Y	ConvF Z	Alpha <sup>G</sup>	Depth <sup>G</sup> (mm)	Unc (k = 2)
150	52.3	0.76	11.68	11.68	11.68	0.00	1.00	±13.3%
220	49.0	0.81	11.50	11.50	11.50	0.00	1.00	±13.3%
300	45.3	0.87	11.22	11.22	11.22	0.09	1.00	±13.3%
450	43.5	0.87	10.79	10.79	10.79	0.16	1.30	±13.3%
600	42.7	0.88	10.35	10.35	10.35	0.10	1.25	±13.3%
750	41.9	0.89	9.28	9.28	9.28	0.53	0.80	±12.0%
900	41.5	0.97	8.80	8.80	8.80	0.51	0.80	±12.0%
1450	40.5	1.20	8.26	8.26	8.26	0.33	0.80	±12.0%
1640	40.2	1.31	8.10	8.10	8.10	0.37	0.86	±12.0%
1750	40.1	1.37	7.91	7.91	7.91	0.31	0.86	±12.0%
1900	40.0	1.40	7.67	7.67	7.67	0.34	0.86	±12.0%
2300	39.5	1.67	7.60	7.60	7.60	0.33	0.90	±12.0%
2450	39.2	1.80	7.26	7.26	7.26	0.44	0.90	±12.0%
2600	39.0	1.96	7.11	7.11	7.11	0.45	0.90	±12.0%
5250	35.9	4.71	5.00	5.00	5.00	0.40	1.80	±14.0%
5600	35.5	5.07	4.70	4.70	4.70	0.40	1.80	±14.0%
5750	35.4	5.22	4.85	4.85	4.85	0.40	1.80	±14.0%

<sup>C</sup> Frequency validity above 300 MHz of ±100 MHz only applies for DASYS v4.4 and higher (see Page 2), else it is restricted to ±50 MHz. The uncertainty is the RSS of the ConvF uncertainty at calibration frequency and the uncertainty for the indicated frequency band. Frequency validity below 300 MHz is ±10, 25, 40, 50 and 70 MHz for ConvF assessments at 30, 64, 128, 150 and 220 MHz respectively. Validity of ConvF assessed at 6 MHz is 4–9 MHz, and ConvF assessed at 13 MHz is 9–19 MHz. Above 5 GHz frequency validity can be extended to ±110 MHz.

<sup>F</sup> The probes are calibrated using tissue simulating liquids (TSL) that deviate for  $\epsilon$  and  $\sigma$  by less than ±5% from the target values (typically better than ±3%) and are valid for TSL with deviations of up to ±10%. If TSL with deviations from the target of less than ±5% are used, the calibration uncertainties are 11.1% for 0.7 - 3 GHz and 13.1% for 3 - 6 GHz.

<sup>G</sup> Alpha/Depth are determined during calibration. SPEAG warrants that the remaining deviation due to the boundary effect after compensation is always less than ±1% for frequencies below 3 GHz and below ±2% for frequencies between 3–6 GHz at any distance larger than half the probe tip diameter from the boundary.

### Frequency Response of E-Field

(TEM-Cell:ifi110 EXX, Waveguide:R22)

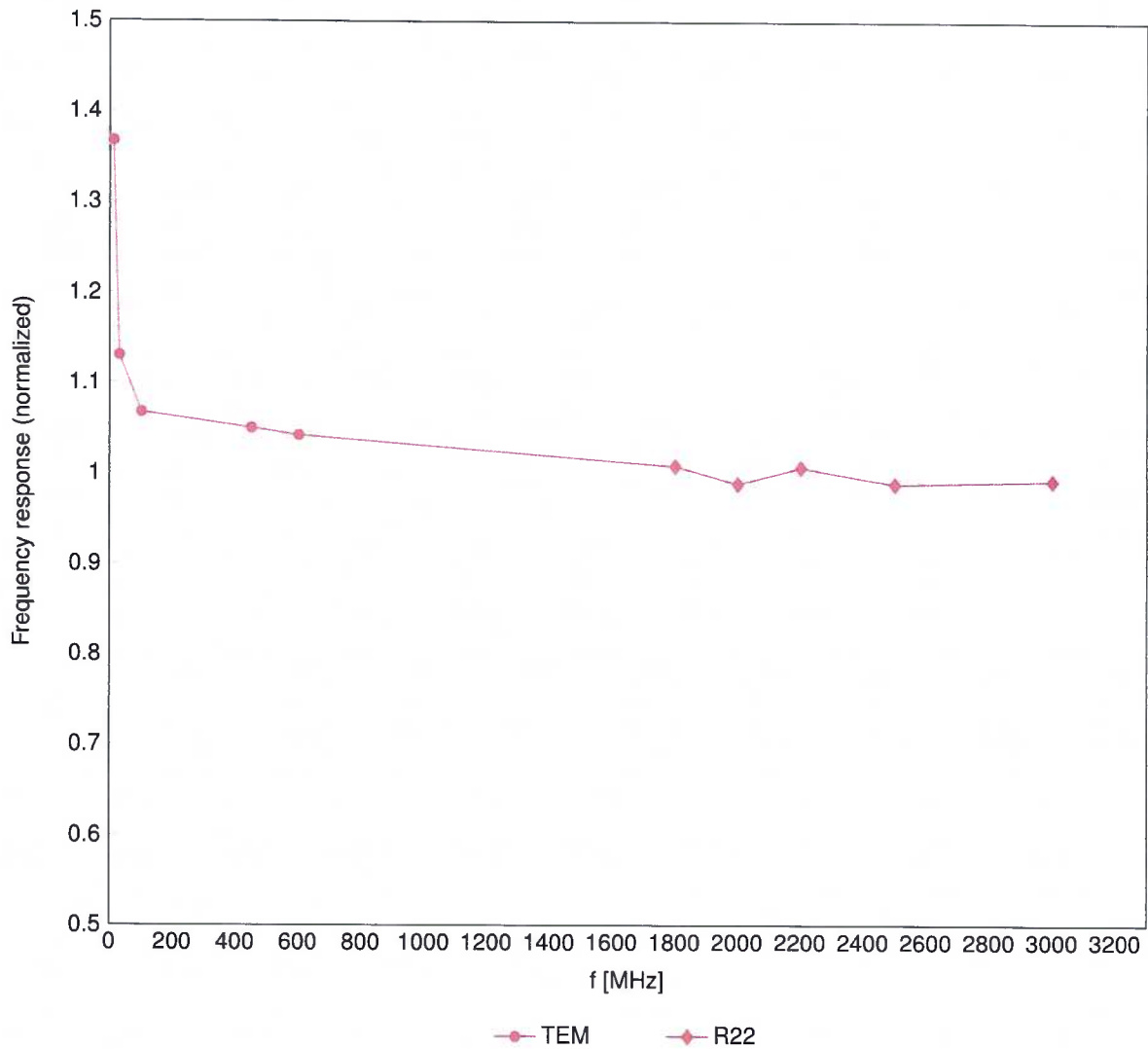

Uncertainty of Frequency Response of E-field:  $\pm 6.3\%$  (k=2)

### Receiving Pattern ( $\phi$ ), $\theta = 0^\circ$

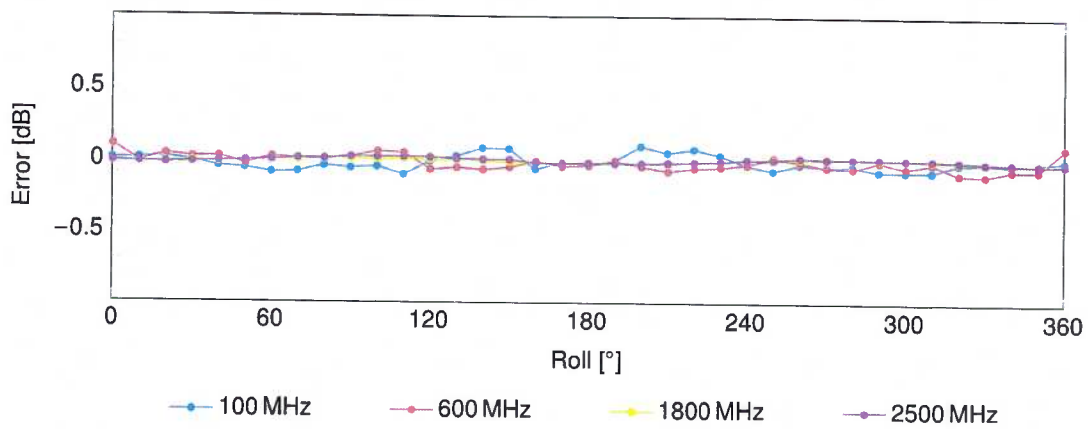
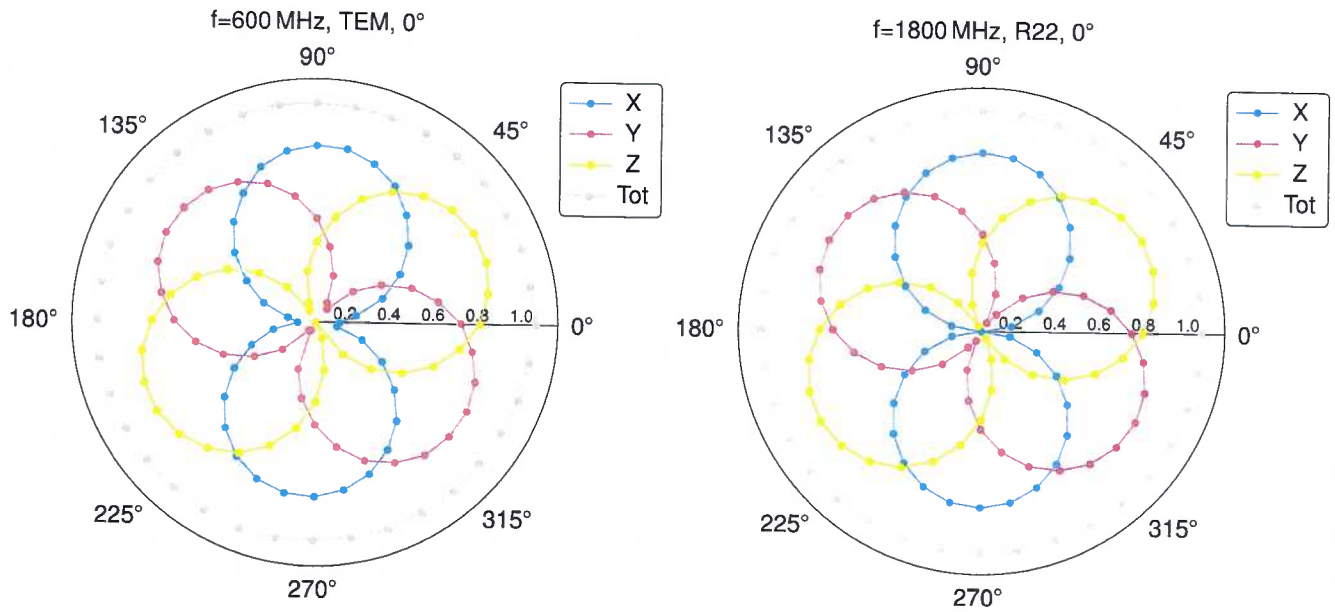

Uncertainty of Axial Isotropy Assessment:  $\pm 0.5\%$  ( $k=2$ )

### Dynamic Range f(SAR<sub>head</sub>)

(TEM cell, f<sub>eval</sub> = 1900 MHz)

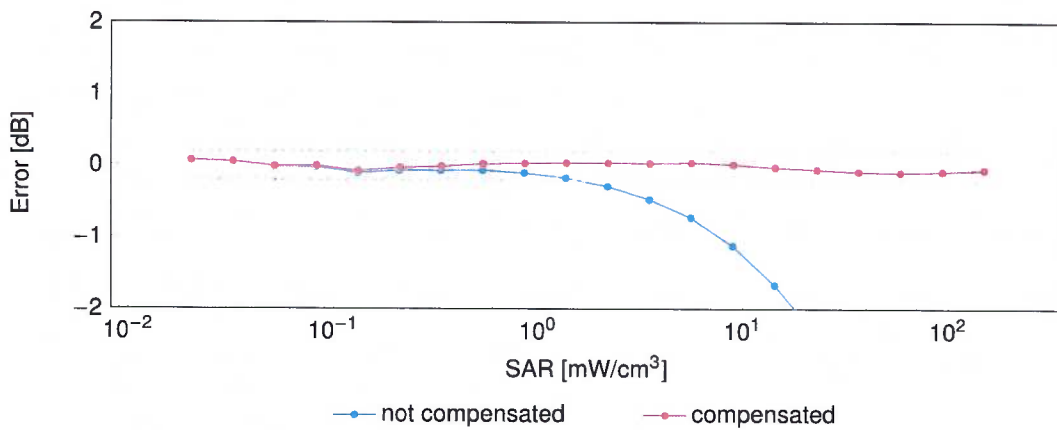
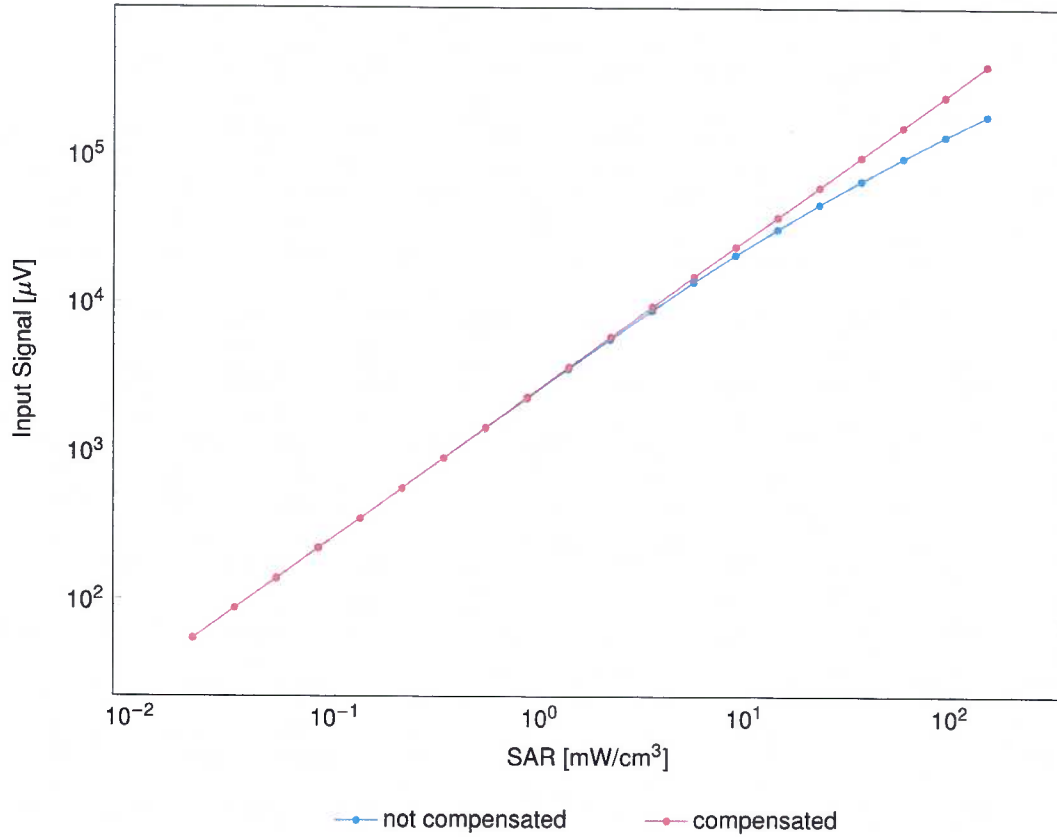

Uncertainty of Linearity Assessment: ±0.6% (k=2)

### Conversion Factor Assessment

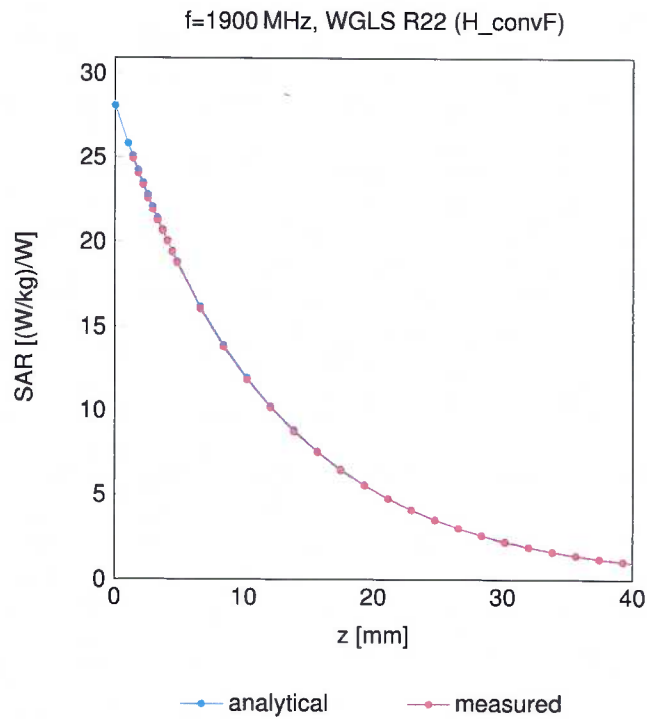

### Deviation from Isotropy in Liquid

Error ( $\phi, \theta$ ), f = 900 MHz

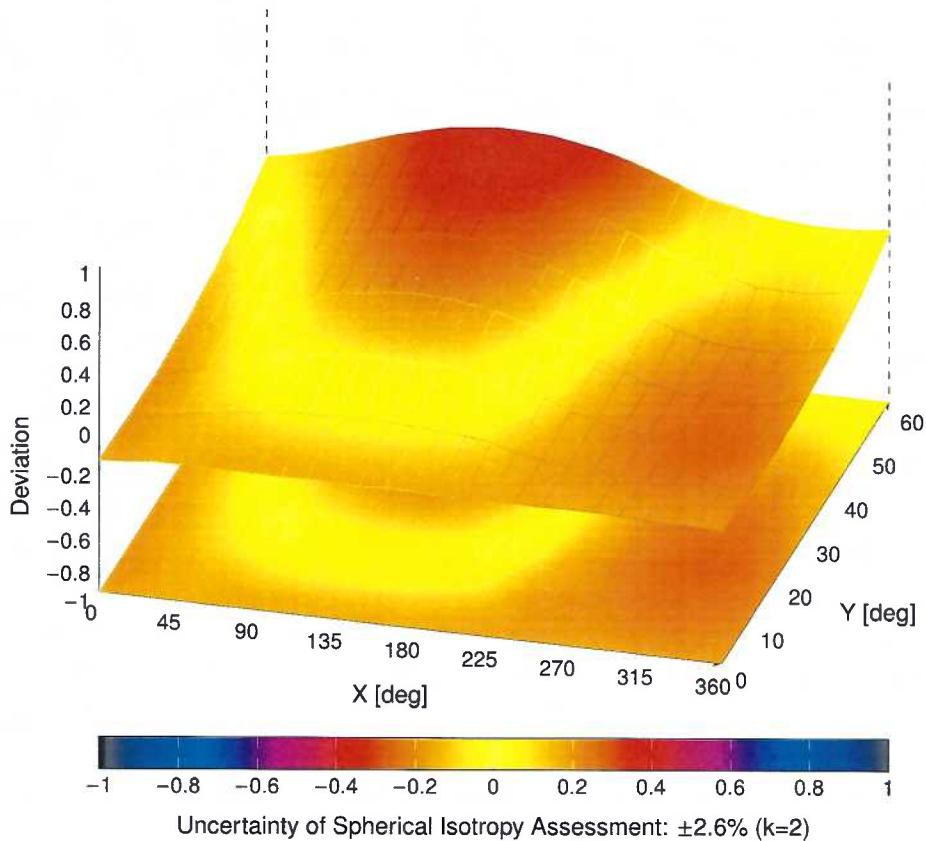



## Appendix E – Dipole Calibration Data Sheets

gm

**Calibration Laboratory of  
Schmid & Partner  
Engineering AG**  
Zeughausstrasse 43, 8004 Zurich, Switzerland



**S** Schweizerischer Kalibrierdienst  
**C** Service suisse d'étalonnage  
**S** Servizio svizzero di taratura  
**S** Swiss Calibration Service

Accredited by the Swiss Accreditation Service (SAS)  
The Swiss Accreditation Service is one of the signatories to the EA  
Multilateral Agreement for the recognition of calibration certificates

Accreditation No.: **SCS 0108**

Client **RF Exposure Lab**

Certificate No: **D750V3-1053\_Jun21**

## CALIBRATION CERTIFICATE

Object **D750V3 - SN:1053**

Calibration procedure(s) **QA CAL-05.v11  
Calibration Procedure for SAR Validation Sources between 0.7-3 GHz**

Calibration date: **June 04, 2021**

This calibration certificate documents the traceability to national standards, which realize the physical units of measurements (SI).  
The measurements and the uncertainties with confidence probability are given on the following pages and are part of the certificate.

All calibrations have been conducted in the closed laboratory facility: environment temperature (22 ± 3)°C and humidity < 70%.

Calibration Equipment used (M&TE critical for calibration)

Primary Standards	ID #	Cal Date (Certificate No.)	Scheduled Calibration
Power meter NRP	SN: 104778	09-Apr-21 (No. 217-03291/03292)	Apr-22
Power sensor NRP-Z91	SN: 103244	09-Apr-21 (No. 217-03291)	Apr-22
Power sensor NRP-Z91	SN: 103245	09-Apr-21 (No. 217-03292)	Apr-22
Reference 20 dB Attenuator	SN: BH9394 (20k)	09-Apr-21 (No. 217-03343)	Apr-22
Type-N mismatch combination	SN: 310982 / 06327	09-Apr-21 (No. 217-03344)	Apr-22
Reference Probe EX3DV4	SN: 7349	28-Dec-20 (No. EX3-7349_Dec20)	Dec-21
DAE4	SN: 601	02-Nov-20 (No. DAE4-601_Nov20)	Nov-21
Secondary Standards	ID #	Check Date (in house)	Scheduled Check
Power meter E4419B	SN: GB39512475	30-Oct-14 (in house check Oct-20)	In house check: Oct-22
Power sensor HP 8481A	SN: US37292783	07-Oct-15 (in house check Oct-20)	In house check: Oct-22
Power sensor HP 8481A	SN: MY41092317	07-Oct-15 (in house check Oct-20)	In house check: Oct-22
RF generator R&S SMT-06	SN: 100972	15-Jun-15 (in house check Oct-20)	In house check: Oct-22
Network Analyzer Agilent E8358A	SN: US41080477	31-Mar-14 (in house check Oct-20)	In house check: Oct-21

Calibrated by: **Michael Weber**      Name: Michael Weber      Function: Laboratory Technician

Signature:

Approved by: **Katja Pokovic**      Name: Katja Pokovic      Function: Technical Manager

Signature:

Issued: June 8, 2021

This calibration certificate shall not be reproduced except in full without written approval of the laboratory.



Accredited by the Swiss Accreditation Service (SAS)

The Swiss Accreditation Service is one of the signatories to the EA  
Multilateral Agreement for the recognition of calibration certificates

Accreditation No.: **SCS 0108**

### Glossary:

TSL	tissue simulating liquid
ConvF	sensitivity in TSL / NORM x,y,z
N/A	not applicable or not measured

### Calibration is Performed According to the Following Standards:

- IEEE Std 1528-2013, "IEEE Recommended Practice for Determining the Peak Spatial-Averaged Specific Absorption Rate (SAR) in the Human Head from Wireless Communications Devices: Measurement Techniques", June 2013
- IEC 62209-1, "Measurement procedure for the assessment of Specific Absorption Rate (SAR) from hand-held and body-mounted devices used next to the ear (frequency range of 300 MHz to 6 GHz)", July 2016
- IEC 62209-2, "Procedure to determine the Specific Absorption Rate (SAR) for wireless communication devices used in close proximity to the human body (frequency range of 30 MHz to 6 GHz)", March 2010
- KDB 865664, "SAR Measurement Requirements for 100 MHz to 6 GHz"

### Additional Documentation:

- DASY4/5 System Handbook

### Methods Applied and Interpretation of Parameters:

- Measurement Conditions:** Further details are available from the Validation Report at the end of the certificate. All figures stated in the certificate are valid at the frequency indicated.
- Antenna Parameters with TSL:** The dipole is mounted with the spacer to position its feed point exactly below the center marking of the flat phantom section, with the arms oriented parallel to the body axis.
- Feed Point Impedance and Return Loss:** These parameters are measured with the dipole positioned under the liquid filled phantom. The impedance stated is transformed from the measurement at the SMA connector to the feed point. The Return Loss ensures low reflected power. No uncertainty required.
- Electrical Delay:** One-way delay between the SMA connector and the antenna feed point. No uncertainty required.
- SAR measured:** SAR measured at the stated antenna input power.
- SAR normalized:** SAR as measured, normalized to an input power of 1 W at the antenna connector.
- SAR for nominal TSL parameters:** The measured TSL parameters are used to calculate the nominal SAR result.

The reported uncertainty of measurement is stated as the standard uncertainty of measurement multiplied by the coverage factor  $k=2$ , which for a normal distribution corresponds to a coverage probability of approximately 95%.

## Measurement Conditions

DASY system configuration, as far as not given on page 1.

<b>DASY Version</b>	DASY5	V52.10.4
<b>Extrapolation</b>	Advanced Extrapolation	
<b>Phantom</b>	Modular Flat Phantom	
<b>Distance Dipole Center - TSL</b>	15 mm	with Spacer
<b>Zoom Scan Resolution</b>	dx, dy, dz = 5 mm	
<b>Frequency</b>	750 MHz $\pm$ 1 MHz	

## Head TSL parameters

The following parameters and calculations were applied.

	Temperature	Permittivity	Conductivity
<b>Nominal Head TSL parameters</b>	22.0 °C	41.9	0.89 mho/m
<b>Measured Head TSL parameters</b>	(22.0 $\pm$ 0.2) °C	42.7 $\pm$ 6 %	0.91 mho/m $\pm$ 6 %
<b>Head TSL temperature change during test</b>	< 0.5 °C	----	----

## SAR result with Head TSL

<b>SAR averaged over 1 cm<sup>3</sup> (1 g) of Head TSL</b>	Condition	
SAR measured	250 mW input power	2.17 W/kg
SAR for nominal Head TSL parameters	normalized to 1W	<b>8.57 W/kg <math>\pm</math> 17.0 % (k=2)</b>

<b>SAR averaged over 10 cm<sup>3</sup> (10 g) of Head TSL</b>	condition	
SAR measured	250 mW input power	1.41 W/kg
SAR for nominal Head TSL parameters	normalized to 1W	<b>5.58 W/kg <math>\pm</math> 16.5 % (k=2)</b>

## Appendix (Additional assessments outside the scope of SCS 0108)

### Antenna Parameters with Head TSL

Impedance, transformed to feed point	56.5 $\Omega$ + 0.1 j $\Omega$
Return Loss	- 24.3 dB

### General Antenna Parameters and Design

Electrical Delay (one direction)	1.035 ns
----------------------------------	----------

After long term use with 100W radiated power, only a slight warming of the dipole near the feedpoint can be measured.

The dipole is made of standard semirigid coaxial cable. The center conductor of the feeding line is directly connected to the second arm of the dipole. The antenna is therefore short-circuited for DC-signals. On some of the dipoles, small end caps are added to the dipole arms in order to improve matching when loaded according to the position as explained in the "Measurement Conditions" paragraph. The SAR data are not affected by this change. The overall dipole length is still according to the Standard.

No excessive force must be applied to the dipole arms, because they might bend or the soldered connections near the feedpoint may be damaged.

### Additional EUT Data

Manufactured by	SPEAG
-----------------	-------

#### Extended Calibration

Usage of SAR dipoles calibrated less than 3 years ago but more than 1 year ago were confirmed in maintaining return loss (<-20 dB, within 20% of prior calibration) and impedance (within 5 ohm from prior calibration) requirements per extended calibrations in KDB Publication 865664 D01 v01r04.

D750V3 SN: 1053 - Head						
Date of Measurement	Return Loss (dB)	$\Delta\%$	Impedance Real ( $\Omega$ )	$\Delta\Omega$	Impedance Imaginary (j $\Omega$ )	$\Delta\Omega$
6/4/2021	-24.3		56.5		0.1	
6/4/2022	-26.2	7.8	57.9	1.4	0.3	0.2
6/6/2023	-25.6	5.3	55.2	-1.3	0.4	0.3

## DASY5 Validation Report for Head TSL

Date: 04.06.2021

Test Laboratory: SPEAG, Zurich, Switzerland

**DUT: Dipole 750 MHz; Type: D750V3; Serial: D750V3 - SN:1053**

Communication System: UID 0 - CW; Frequency: 750 MHz

Medium parameters used:  $f = 750$  MHz;  $\sigma = 0.91$  S/m;  $\epsilon_r = 42.7$ ;  $\rho = 1000$  kg/m<sup>3</sup>

Phantom section: Flat Section

Measurement Standard: DASY5 (IEEE/IEC/ANSI C63.19-2011)

DASY52 Configuration:

- Probe: EX3DV4 - SN7349; ConvF(10.11, 10.11, 10.11) @ 750 MHz; Calibrated: 28.12.2020
- Sensor-Surface: 1.4mm (Mechanical Surface Detection)
- Electronics: DAE4 Sn601; Calibrated: 02.11.2020
- Phantom: Flat Phantom 4.9 (front); Type: QD 00L P49 AA; Serial: 1001
- DASY52 52.10.4(1527); SEMCAD X 14.6.14(7483)

### Dipole Calibration for Head Tissue/Pin=250 mW, d=15mm/Zoom Scan (7x7x7)/Cube 0:

Measurement grid: dx=5mm, dy=5mm, dz=5mm

Reference Value = 59.74 V/m; Power Drift = 0.01 dB

Peak SAR (extrapolated) = 3.30 W/kg

**SAR(1 g) = 2.17 W/kg; SAR(10 g) = 1.41 W/kg**

Smallest distance from peaks to all points 3 dB below: Larger than measurement grid (> 30mm)

Ratio of SAR at M2 to SAR at M1 = 65.5%

Maximum value of SAR (measured) = 2.93 W/kg

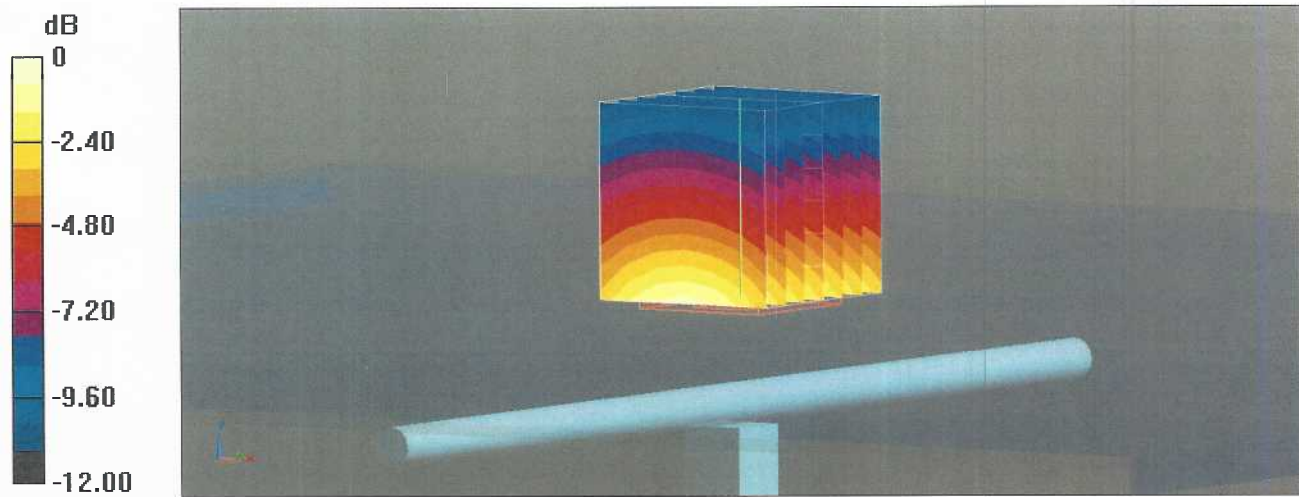

0 dB = 2.93 W/kg = 4.67 dBW/kg

# Impedance Measurement Plot for Head TSL

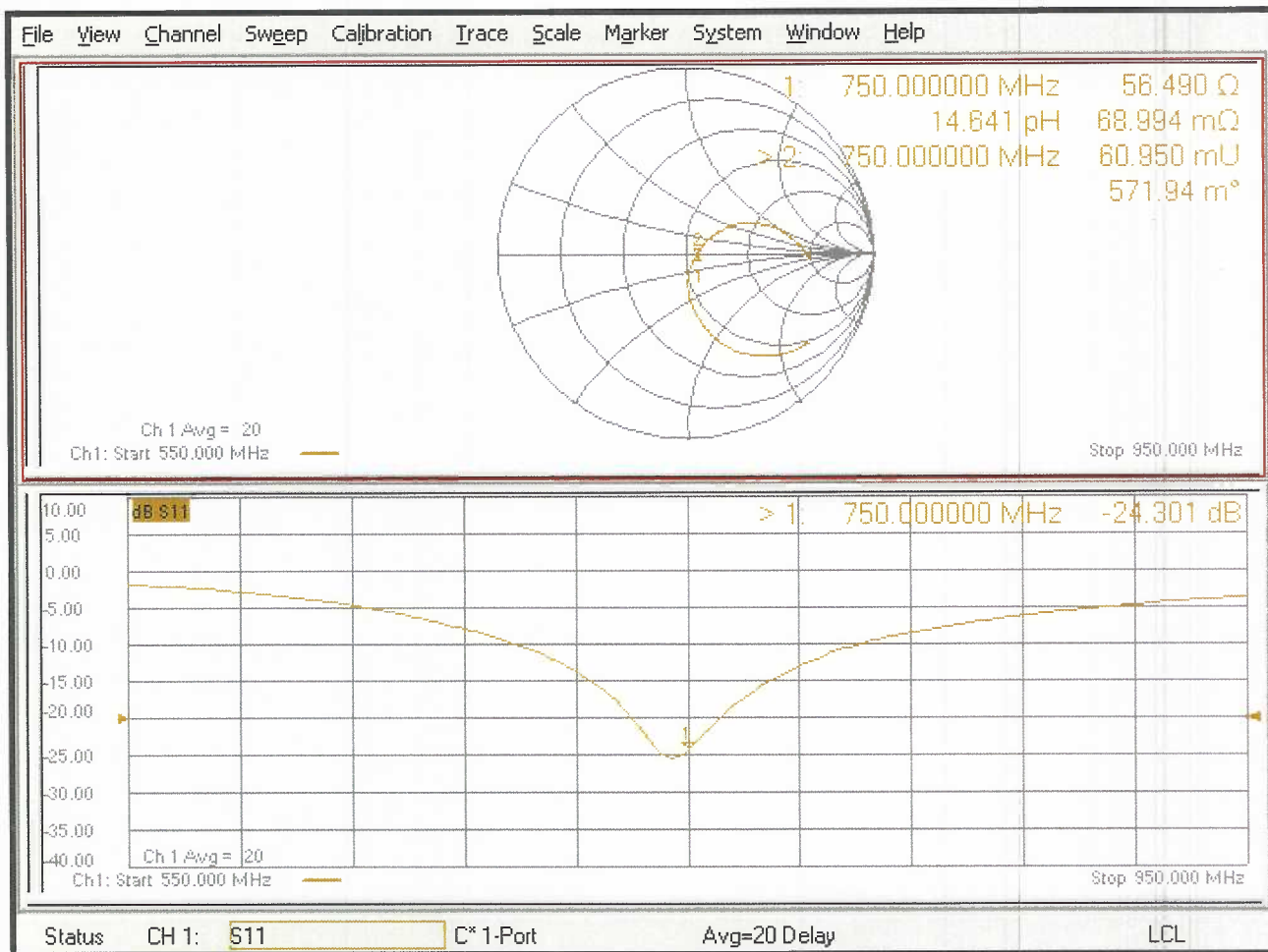

*Jm*

**Calibration Laboratory of  
Schmid & Partner  
Engineering AG**  
Zeughausstrasse 43, 8004 Zurich, Switzerland



**S** Schweizerischer Kalibrierdienst  
**C** Service suisse d'étalonnage  
**S** Servizio svizzero di taratura  
**S** Swiss Calibration Service

Accredited by the Swiss Accreditation Service (SAS)  
The Swiss Accreditation Service is one of the signatories to the EA  
Multilateral Agreement for the recognition of calibration certificates

Accreditation No.: **SCS 0108**

Client **RF Exposure Lab**

Certificate No: **D900V2-1d128\_Jun21**

## CALIBRATION CERTIFICATE

Object **D900V2 - SN:1d128**

Calibration procedure(s) **QA CAL-05.v11  
Calibration Procedure for SAR Validation Sources between 0.7-3 GHz**

Calibration date: **June 04, 2021**

This calibration certificate documents the traceability to national standards, which realize the physical units of measurements (SI).  
The measurements and the uncertainties with confidence probability are given on the following pages and are part of the certificate.

All calibrations have been conducted in the closed laboratory facility: environment temperature ( $22 \pm 3$ )°C and humidity < 70%.

Calibration Equipment used (M&TE critical for calibration)

Primary Standards	ID #	Cal Date (Certificate No.)	Scheduled Calibration
Power meter NRP	SN: 104778	09-Apr-21 (No. 217-03291/03292)	Apr-22
Power sensor NRP-Z91	SN: 103244	09-Apr-21 (No. 217-03291)	Apr-22
Power sensor NRP-Z91	SN: 103245	09-Apr-21 (No. 217-03292)	Apr-22
Reference 20 dB Attenuator	SN: BH9394 (20k)	09-Apr-21 (No. 217-03343)	Apr-22
Type-N mismatch combination	SN: 310982 / 06327	09-Apr-21 (No. 217-03344)	Apr-22
Reference Probe EX3DV4	SN: 7349	28-Dec-20 (No. EX3-7349_Dec20)	Dec-21
DAE4	SN: 601	02-Nov-20 (No. DAE4-601_Nov20)	Nov-21

Secondary Standards	ID #	Check Date (in house)	Scheduled Check
Power meter E4419B	SN: GB39512475	30-Oct-14 (in house check Oct-20)	In house check: Oct-22
Power sensor HP 8481A	SN: US37292783	07-Oct-15 (in house check Oct-20)	In house check: Oct-22
Power sensor HP 8481A	SN: MY41092317	07-Oct-15 (in house check Oct-20)	In house check: Oct-22
RF generator R&S SMT-06	SN: 100972	15-Jun-15 (in house check Oct-20)	In house check: Oct-22
Network Analyzer Agilent E8358A	SN: US41080477	31-Mar-14 (in house check Oct-20)	In house check: Oct-21

Calibrated by: **Michael Weber**      Name: **Michael Weber**      Function: **Laboratory Technician**

Signature: *M. Weber*

Approved by: **Katja Pokovic**      Name: **Katja Pokovic**      Function: **Technical Manager**

Signature: *Katja Pokovic*

Issued: June 8, 2021

This calibration certificate shall not be reproduced except in full without written approval of the laboratory.





Accredited by the Swiss Accreditation Service (SAS)

The Swiss Accreditation Service is one of the signatories to the EA  
Multilateral Agreement for the recognition of calibration certificates

Accreditation No.: **SCS 0108**

### Glossary:

TSL	tissue simulating liquid
ConvF	sensitivity in TSL / NORM x,y,z
N/A	not applicable or not measured

### Calibration is Performed According to the Following Standards:

- IEEE Std 1528-2013, "IEEE Recommended Practice for Determining the Peak Spatial-Averaged Specific Absorption Rate (SAR) in the Human Head from Wireless Communications Devices: Measurement Techniques", June 2013
- IEC 62209-1, "Measurement procedure for the assessment of Specific Absorption Rate (SAR) from hand-held and body-mounted devices used next to the ear (frequency range of 300 MHz to 6 GHz)", July 2016
- IEC 62209-2, "Procedure to determine the Specific Absorption Rate (SAR) for wireless communication devices used in close proximity to the human body (frequency range of 30 MHz to 6 GHz)", March 2010
- KDB 865664, "SAR Measurement Requirements for 100 MHz to 6 GHz"

### Additional Documentation:

- DASY4/5 System Handbook

### Methods Applied and Interpretation of Parameters:

- Measurement Conditions:** Further details are available from the Validation Report at the end of the certificate. All figures stated in the certificate are valid at the frequency indicated.
- Antenna Parameters with TSL:** The dipole is mounted with the spacer to position its feed point exactly below the center marking of the flat phantom section, with the arms oriented parallel to the body axis.
- Feed Point Impedance and Return Loss:** These parameters are measured with the dipole positioned under the liquid filled phantom. The impedance stated is transformed from the measurement at the SMA connector to the feed point. The Return Loss ensures low reflected power. No uncertainty required.
- Electrical Delay:** One-way delay between the SMA connector and the antenna feed point. No uncertainty required.
- SAR measured:** SAR measured at the stated antenna input power.
- SAR normalized:** SAR as measured, normalized to an input power of 1 W at the antenna connector.
- SAR for nominal TSL parameters:** The measured TSL parameters are used to calculate the nominal SAR result.

The reported uncertainty of measurement is stated as the standard uncertainty of measurement multiplied by the coverage factor  $k=2$ , which for a normal distribution corresponds to a coverage probability of approximately 95%.

## Measurement Conditions

DASY system configuration, as far as not given on page 1.

<b>DASY Version</b>	DASY5	V52.10.4
<b>Extrapolation</b>	Advanced Extrapolation	
<b>Phantom</b>	Modular Flat Phantom	
<b>Distance Dipole Center - TSL</b>	15 mm	with Spacer
<b>Zoom Scan Resolution</b>	dx, dy, dz = 5 mm	
<b>Frequency</b>	900 MHz ± 1 MHz	

## Head TSL parameters

The following parameters and calculations were applied.

	<b>Temperature</b>	<b>Permittivity</b>	<b>Conductivity</b>
<b>Nominal Head TSL parameters</b>	22.0 °C	41.5	0.97 mho/m
<b>Measured Head TSL parameters</b>	(22.0 ± 0.2) °C	42.3 ± 6 %	0.96 mho/m ± 6 %
<b>Head TSL temperature change during test</b>	< 0.5 °C	----	----

## SAR result with Head TSL

<b>SAR averaged over 1 cm<sup>3</sup> (1 g) of Head TSL</b>	Condition	
SAR measured	250 mW input power	2.76 W/kg
SAR for nominal Head TSL parameters	normalized to 1W	<b>11.2 W/kg ± 17.0 % (k=2)</b>

<b>SAR averaged over 10 cm<sup>3</sup> (10 g) of Head TSL</b>	condition	
SAR measured	250 mW input power	1.77 W/kg
SAR for nominal Head TSL parameters	normalized to 1W	<b>7.14 W/kg ± 16.5 % (k=2)</b>

## Appendix (Additional assessments outside the scope of SCS 0108)

### Antenna Parameters with Head TSL

Impedance, transformed to feed point	51.0 $\Omega$ - 0.6 j $\Omega$
Return Loss	- 38.5 dB

### General Antenna Parameters and Design

Electrical Delay (one direction)	1.412 ns
----------------------------------	----------

After long term use with 100W radiated power, only a slight warming of the dipole near the feedpoint can be measured.

The dipole is made of standard semirigid coaxial cable. The center conductor of the feeding line is directly connected to the second arm of the dipole. The antenna is therefore short-circuited for DC-signals. On some of the dipoles, small end caps are added to the dipole arms in order to improve matching when loaded according to the position as explained in the "Measurement Conditions" paragraph. The SAR data are not affected by this change. The overall dipole length is still according to the Standard.

No excessive force must be applied to the dipole arms, because they might bend or the soldered connections near the feedpoint may be damaged.

### Additional EUT Data

Manufactured by	SPEAG
-----------------	-------

#### Extended Calibration

Usage of SAR dipoles calibrated less than 3 years ago but more than 1 year ago were confirmed in maintaining return loss (<-20 dB, within 20% of prior calibration) and impedance (within 5 ohm from prior calibration) requirements per extended calibrations in KDB Publication 865664 D01 v01r04.

D900V2 SN: 1d128 - Head						
Date of Measurement	Return Loss (dB)	$\Delta\%$	Impedance Real ( $\Omega$ )	$\Delta\Omega$	Impedance Imaginary (j $\Omega$ )	$\Delta\Omega$
6/4/2021	-38.5		51.0		-0.6	
6/4/2022	-37.2	-3.4	52.3	1.3	-0.8	-0.2
6/6/2023	-36.8	-4.4	52.9	1.9	-0.7	-0.1

# DASY5 Validation Report for Head TSL

Date: 04.06.2021

Test Laboratory: SPEAG, Zurich, Switzerland

**DUT: Dipole 900 MHz; Type: D900V2; Serial: D900V2 - SN:1d128**

Communication System: UID 0 - CW; Frequency: 900 MHz

Medium parameters used:  $f = 900 \text{ MHz}$ ;  $\sigma = 0.96 \text{ S/m}$ ;  $\epsilon_r = 42.3$ ;  $\rho = 1000 \text{ kg/m}^3$

Phantom section: Flat Section

Measurement Standard: DASY5 (IEEE/IEC/ANSI C63.19-2011)

DASY52 Configuration:

- Probe: EX3DV4 - SN7349; ConvF(9.62, 9.62, 9.62) @ 900 MHz; Calibrated: 28.12.2020
- Sensor-Surface: 1.4mm (Mechanical Surface Detection)
- Electronics: DAE4 Sn601; Calibrated: 02.11.2020
- Phantom: Flat Phantom 4.9 (front); Type: QD 00L P49 AA; Serial: 1001
- DASY52 52.10.4(1527); SEMCAD X 14.6.14(7483)

## Dipole Calibration for Head Tissue/Pin=250 mW, d=15mm/Zoom Scan (7x7x7)/Cube 0:

Measurement grid:  $dx=5\text{mm}$ ,  $dy=5\text{mm}$ ,  $dz=5\text{mm}$

Reference Value = 65.79 V/m; Power Drift = 0.03 dB

Peak SAR (extrapolated) = 4.23 W/kg

**SAR(1 g) = 2.76 W/kg; SAR(10 g) = 1.77 W/kg**

Smallest distance from peaks to all points 3 dB below = 16 mm

Ratio of SAR at M2 to SAR at M1 = 65%

Maximum value of SAR (measured) = 3.74 W/kg

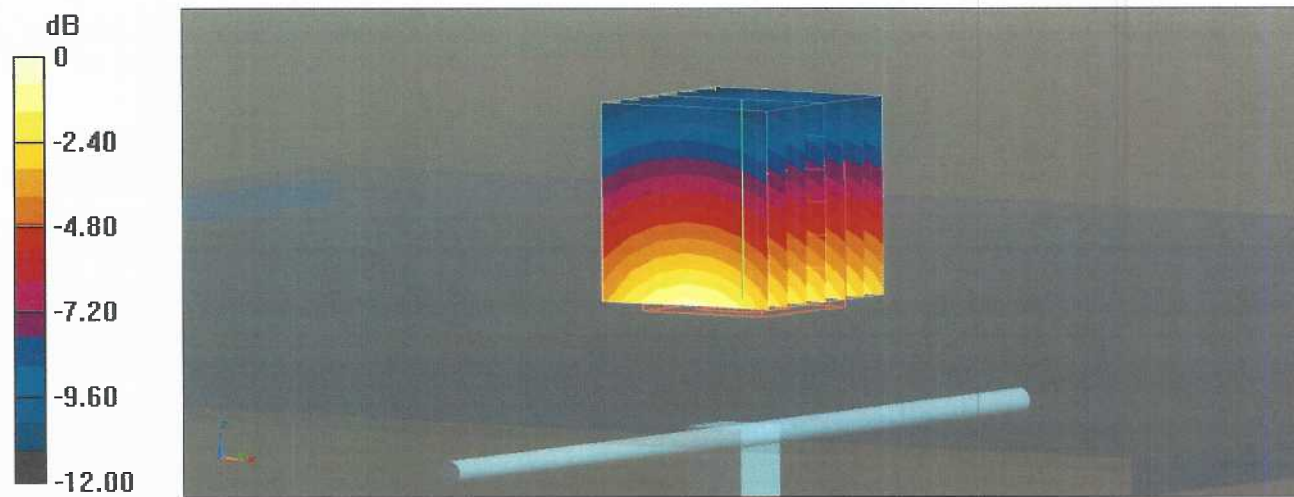

0 dB = 3.74 W/kg = 5.73 dBW/kg

# Impedance Measurement Plot for Head TSL

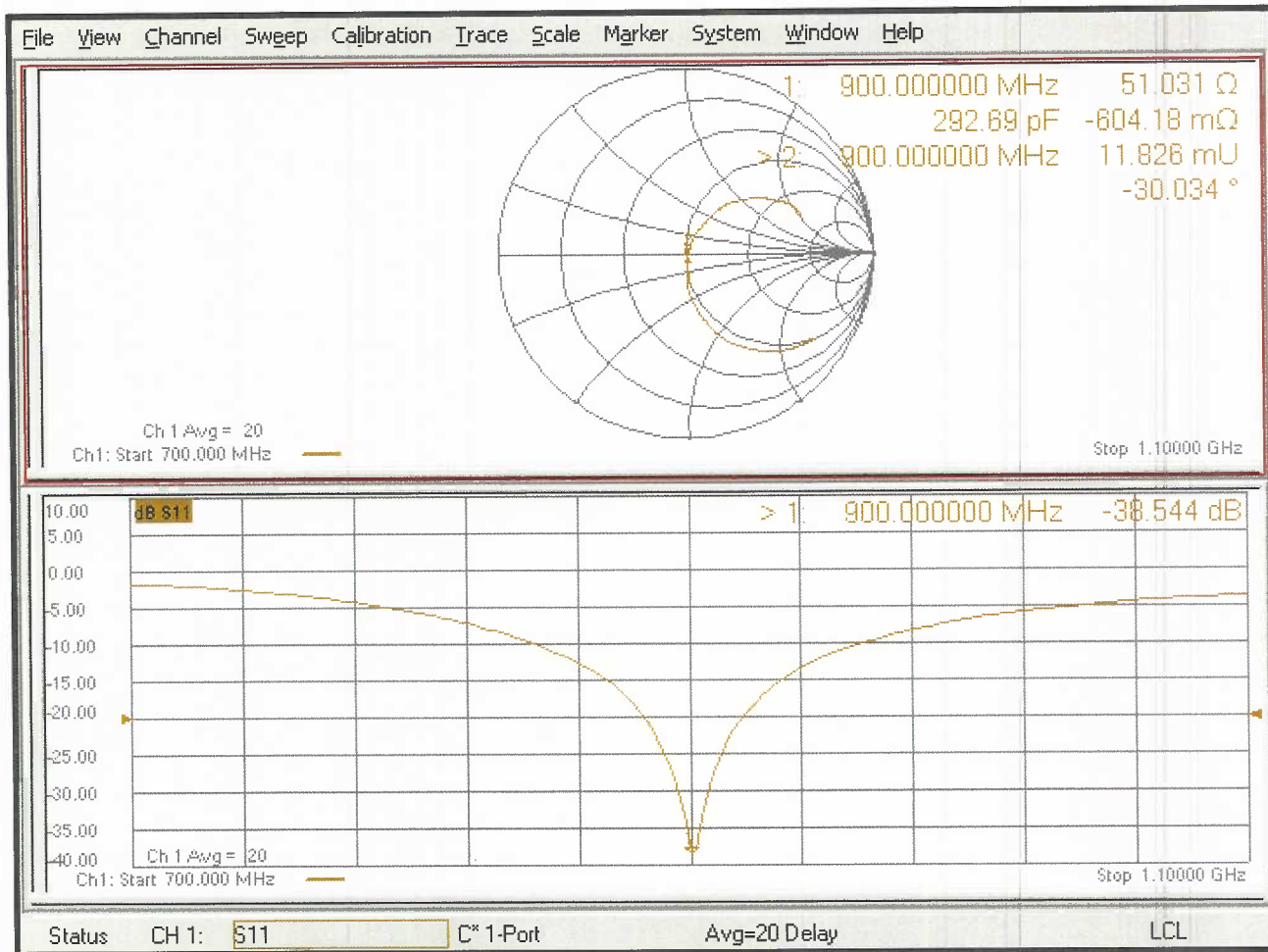

gm

Calibration Laboratory of  
Schmid & Partner  
Engineering AG  
Zeughausstrasse 43, 8004 Zurich, Switzerland



S Schweizerischer Kalibrierdienst  
C Service suisse d'étalonnage  
S Servizio svizzero di taratura  
S Swiss Calibration Service

Accredited by the Swiss Accreditation Service (SAS)  
The Swiss Accreditation Service is one of the signatories to the EA  
Multilateral Agreement for the recognition of calibration certificates

Accreditation No.: SCS 0108

Client RF Exposure Lab

Certificate No: D1750V2-1061\_Jun21

### CALIBRATION CERTIFICATE

Object D1750V2 - SN:1061

Calibration procedure(s) QA CAL-05 v11  
Calibration Procedure for SAR Validation Sources between 0.7-3 GHz

Calibration date: June 03, 2021

This calibration certificate documents the traceability to national standards, which realize the physical units of measurements (SI).  
The measurements and the uncertainties with confidence probability are given on the following pages and are part of the certificate.

All calibrations have been conducted in the closed laboratory facility: environment temperature (22 ± 3)°C and humidity < 70%.

Calibration Equipment used (M&TE critical for calibration)

Primary Standards	ID #	Cal Date (Certificate No.)	Scheduled Calibration
Power meter NRP	SN: 104778	09-Apr-21 (No. 217-03291/03292)	Apr-22
Power sensor NRP-Z91	SN: 103244	09-Apr-21 (No. 217-03291)	Apr-22
Power sensor NRP-Z91	SN: 103245	09-Apr-21 (No. 217-03292)	Apr-22
Reference 20 dB Attenuator	SN: BH9394 (20k)	09-Apr-21 (No. 217-03343)	Apr-22
Type-N mismatch combination	SN: 310982 / 06327	09-Apr-21 (No. 217-03344)	Apr-22
Reference Probe EX3DV4	SN: 7349	28-Dec-20 (No. EX3-7349_Dec20)	Dec-21
DAE4	SN: 601	02-Nov-20 (No. DAE4-601_Nov20)	Nov-21

Secondary Standards	ID #	Check Date (in house)	Scheduled Check
Power meter E4419B	SN: GB39512475	30-Oct-14 (in house check Oct-20)	In house check: Oct-22
Power sensor HP 8481A	SN: US37292783	07-Oct-15 (in house check Oct-20)	In house check: Oct-22
Power sensor HP 8481A	SN: MY41092317	07-Oct-15 (in house check Oct-20)	In house check: Oct-22
RF generator R&S SMT-06	SN: 100972	15-Jun-15 (in house check Oct-20)	In house check: Oct-22
Network Analyzer Agilent E8358A	SN: US41080477	31-Mar-14 (in house check Oct-20)	In house check: Oct-21

Calibrated by:	Name Jeffrey Katzman	Function Laboratory Technician	Signature 
----------------	-------------------------	-----------------------------------	---------------

Approved by:	Name Katja Pokovic	Function Technical Manager	Signature 
--------------	-----------------------	-------------------------------	---------------

Issued: June 8, 2021

This calibration certificate shall not be reproduced except in full without written approval of the laboratory.



Accredited by the Swiss Accreditation Service (SAS)

The Swiss Accreditation Service is one of the signatories to the EA  
Multilateral Agreement for the recognition of calibration certificates

Accreditation No.: **SCS 0108**

### Glossary:

TSL	tissue simulating liquid
ConvF	sensitivity in TSL / NORM x,y,z
N/A	not applicable or not measured

### Calibration is Performed According to the Following Standards:

- IEEE Std 1528-2013, "IEEE Recommended Practice for Determining the Peak Spatial-Averaged Specific Absorption Rate (SAR) in the Human Head from Wireless Communications Devices: Measurement Techniques", June 2013
- IEC 62209-1, "Measurement procedure for the assessment of Specific Absorption Rate (SAR) from hand-held and body-mounted devices used next to the ear (frequency range of 300 MHz to 6 GHz)", July 2016
- IEC 62209-2, "Procedure to determine the Specific Absorption Rate (SAR) for wireless communication devices used in close proximity to the human body (frequency range of 30 MHz to 6 GHz)", March 2010
- KDB 865664, "SAR Measurement Requirements for 100 MHz to 6 GHz"

### Additional Documentation:

- DASY4/5 System Handbook

### Methods Applied and Interpretation of Parameters:

- Measurement Conditions:** Further details are available from the Validation Report at the end of the certificate. All figures stated in the certificate are valid at the frequency indicated.
- Antenna Parameters with TSL:** The dipole is mounted with the spacer to position its feed point exactly below the center marking of the flat phantom section, with the arms oriented parallel to the body axis.
- Feed Point Impedance and Return Loss:** These parameters are measured with the dipole positioned under the liquid filled phantom. The impedance stated is transformed from the measurement at the SMA connector to the feed point. The Return Loss ensures low reflected power. No uncertainty required.
- Electrical Delay:** One-way delay between the SMA connector and the antenna feed point. No uncertainty required.
- SAR measured:** SAR measured at the stated antenna input power.
- SAR normalized:** SAR as measured, normalized to an input power of 1 W at the antenna connector.
- SAR for nominal TSL parameters:** The measured TSL parameters are used to calculate the nominal SAR result.

The reported uncertainty of measurement is stated as the standard uncertainty of measurement multiplied by the coverage factor  $k=2$ , which for a normal distribution corresponds to a coverage probability of approximately 95%.

## Measurement Conditions

DASY system configuration, as far as not given on page 1.

<b>DASY Version</b>	DASY5	V52.10.4
<b>Extrapolation</b>	Advanced Extrapolation	
<b>Phantom</b>	Modular Flat Phantom	
<b>Distance Dipole Center - TSL</b>	10 mm	with Spacer
<b>Zoom Scan Resolution</b>	dx, dy, dz = 5 mm	
<b>Frequency</b>	1750 MHz ± 1 MHz	

## Head TSL parameters

The following parameters and calculations were applied.

	Temperature	Permittivity	Conductivity
<b>Nominal Head TSL parameters</b>	22.0 °C	40.1	1.37 mho/m
<b>Measured Head TSL parameters</b>	(22.0 ± 0.2) °C	40.7 ± 6 %	1.37 mho/m ± 6 %
<b>Head TSL temperature change during test</b>	< 0.5 °C	----	----

## SAR result with Head TSL

<b>SAR averaged over 1 cm<sup>3</sup> (1 g) of Head TSL</b>	Condition	
SAR measured	250 mW input power	9.38 W/kg
SAR for nominal Head TSL parameters	normalized to 1W	<b>37.7 W/kg ± 17.0 % (k=2)</b>

<b>SAR averaged over 10 cm<sup>3</sup> (10 g) of Head TSL</b>	condition	
SAR measured	250 mW input power	4.93 W/kg
SAR for nominal Head TSL parameters	normalized to 1W	<b>19.8 W/kg ± 16.5 % (k=2)</b>



## Appendix (Additional assessments outside the scope of SCS 0108)

### Antenna Parameters with Head TSL

Impedance, transformed to feed point	49.4 $\Omega$ + 0.0 j $\Omega$
Return Loss	- 44.5 dB

### General Antenna Parameters and Design

Electrical Delay (one direction)	1.221 ns
----------------------------------	----------

After long term use with 100W radiated power, only a slight warming of the dipole near the feedpoint can be measured.

The dipole is made of standard semirigid coaxial cable. The center conductor of the feeding line is directly connected to the second arm of the dipole. The antenna is therefore short-circuited for DC-signals. On some of the dipoles, small end caps are added to the dipole arms in order to improve matching when loaded according to the position as explained in the "Measurement Conditions" paragraph. The SAR data are not affected by this change. The overall dipole length is still according to the Standard.

No excessive force must be applied to the dipole arms, because they might bend or the soldered connections near the feedpoint may be damaged.

### Additional EUT Data

Manufactured by	SPEAG
-----------------	-------

#### Extended Calibration

Usage of SAR dipoles calibrated less than 3 years ago but more than 1 year ago were confirmed in maintaining return loss (<-20 dB, within 20% of prior calibration) and impedance (within 5 ohm from prior calibration) requirements per extended calibrations in KDB Publication 865664 D01 v01r04.

D1750V2 SN: 1061 - Head						
Date of Measurement	Return Loss (dB)	$\Delta\%$	Impedance Real ( $\Omega$ )	$\Delta\Omega$	Impedance Imaginary (j $\Omega$ )	$\Delta\Omega$
6/3/2021	-44.5		49.4		0.0	
6/4/2022	-42.3	-4.9	47.9	-1.5	-0.2	-0.2
6/6/2023	-43.6	-2.0	48.5	-0.9	-0.3	-0.3

# DASY5 Validation Report for Head TSL

Date: 03.06.2021

Test Laboratory: SPEAG, Zurich, Switzerland

**DUT: Dipole 1750 MHz; Type: D1750V2; Serial: D1750V2 - SN:1061**

Communication System: UID 0 - CW; Frequency: 1750 MHz

Medium parameters used:  $f = 1750 \text{ MHz}$ ;  $\sigma = 1.37 \text{ S/m}$ ;  $\epsilon_r = 40.7$ ;  $\rho = 1000 \text{ kg/m}^3$

Phantom section: Flat Section

Measurement Standard: DASY5 (IEEE/IEC/ANSI C63.19-2011)

DASY52 Configuration:

- Probe: EX3DV4 - SN7349; ConvF(8.67, 8.67, 8.67) @ 1750 MHz; Calibrated: 28.12.2020
- Sensor-Surface: 1.4mm (Mechanical Surface Detection)
- Electronics: DAE4 Sn601; Calibrated: 02.11.2020
- Phantom: Flat Phantom 5.0 (front); Type: QD 000 P50 AA; Serial: 1001
- DASY52 52.10.4(1527); SEMCAD X 14.6.14(7483)

## Dipole Calibration for Head Tissue/Pin=250 mW, d=10mm/Zoom Scan (7x7x7)/Cube 0:

Measurement grid:  $dx=5\text{mm}$ ,  $dy=5\text{mm}$ ,  $dz=5\text{mm}$

Reference Value = 107.4 V/m; Power Drift = 0.08 dB

Peak SAR (extrapolated) = 17.5 W/kg

**SAR(1 g) = 9.38 W/kg; SAR(10 g) = 4.93 W/kg**

Smallest distance from peaks to all points 3 dB below = 9.1 mm

Ratio of SAR at M2 to SAR at M1 = 54%

Maximum value of SAR (measured) = 14.6 W/kg

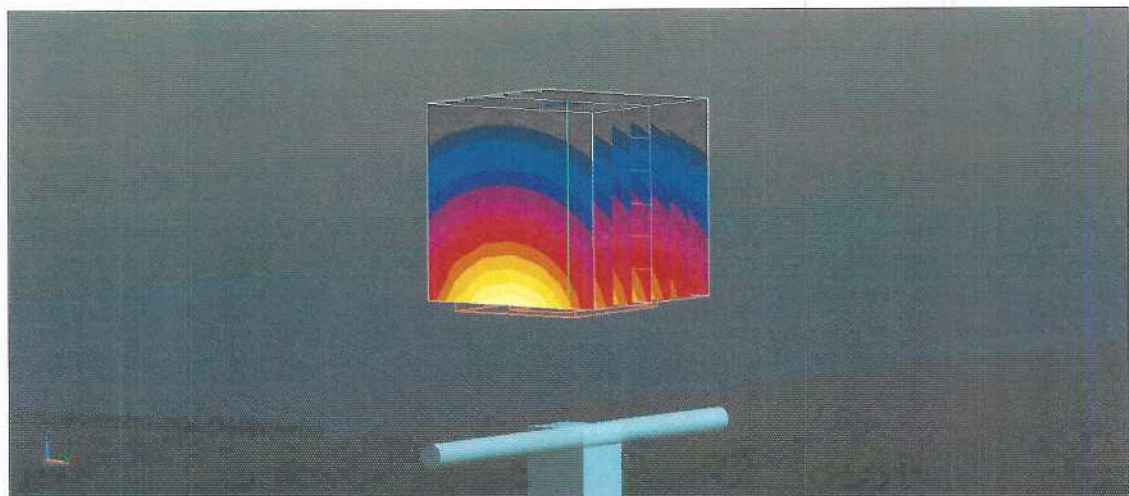
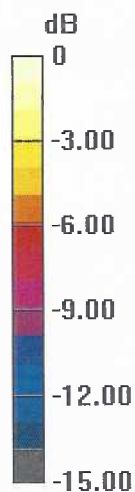

0 dB = 14.6 W/kg = 11.64 dBW/kg

# Impedance Measurement Plot for Head TSL

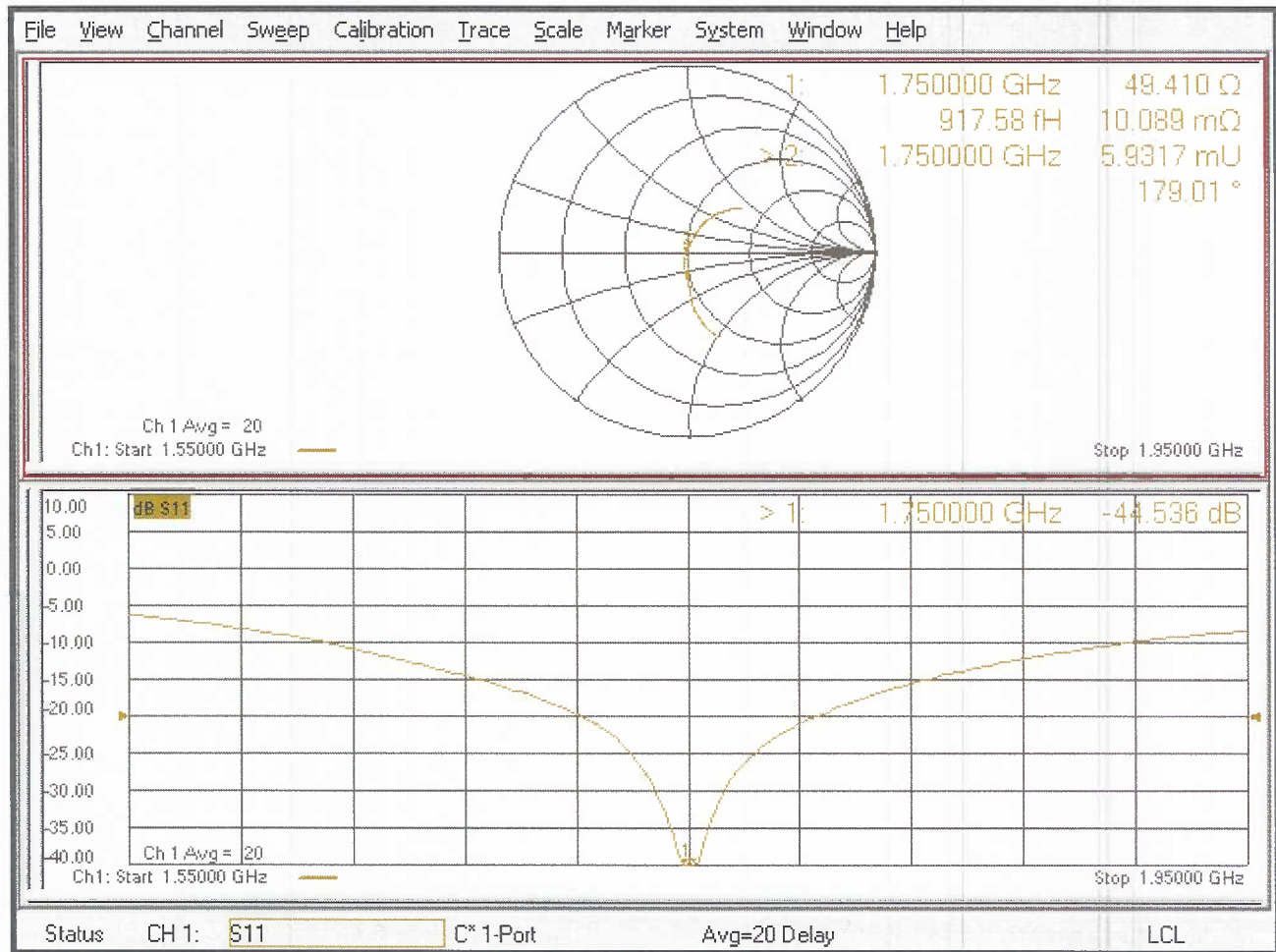

Jon

**Calibration Laboratory of  
Schmid & Partner  
Engineering AG**  
Zeughausstrasse 43, 8004 Zurich, Switzerland



**S** Schweizerischer Kalibrierdienst  
**C** Service suisse d'étalonnage  
**S** Servizio svizzero di taratura  
**S** Swiss Calibration Service

Accredited by the Swiss Accreditation Service (SAS)  
The Swiss Accreditation Service is one of the signatories to the EA  
Multilateral Agreement for the recognition of calibration certificates

Accreditation No.: **SCS 0108**

Client **RF Exposure Lab**

Certificate No: **D1900V2-5d147\_Jun21**

## CALIBRATION CERTIFICATE

Object **D1900V2 - SN:5d147**

Calibration procedure(s) **QA CAL-05.v11  
Calibration Procedure for SAR Validation Sources between 0.7-3 GHz**

Calibration date: **June 04, 2021**

This calibration certificate documents the traceability to national standards, which realize the physical units of measurements (SI).  
The measurements and the uncertainties with confidence probability are given on the following pages and are part of the certificate.

All calibrations have been conducted in the closed laboratory facility: environment temperature (22 ± 3)°C and humidity < 70%.

Calibration Equipment used (M&TE critical for calibration)

Primary Standards	ID #	Cal Date (Certificate No.)	Scheduled Calibration
Power meter NRP	SN: 104778	09-Apr-21 (No. 217-03291/03292)	Apr-22
Power sensor NRP-Z91	SN: 103244	09-Apr-21 (No. 217-03291)	Apr-22
Power sensor NRP-Z91	SN: 103245	09-Apr-21 (No. 217-03292)	Apr-22
Reference 20 dB Attenuator	SN: BH9394 (20k)	09-Apr-21 (No. 217-03343)	Apr-22
Type-N mismatch combination	SN: 310982 / 06327	09-Apr-21 (No. 217-03344)	Apr-22
Reference Probe EX3DV4	SN: 7349	28-Dec-20 (No. EX3-7349_Dec20)	Dec-21
DAE4	SN: 601	02-Nov-20 (No. DAE4-601_Nov20)	Nov-21
Secondary Standards	ID #	Check Date (in house)	Scheduled Check
Power meter E4419B	SN: GB39512475	30-Oct-14 (in house check Oct-20)	In house check: Oct-22
Power sensor HP 8481A	SN: US37292783	07-Oct-15 (in house check Oct-20)	In house check: Oct-22
Power sensor HP 8481A	SN: MY41092317	07-Oct-15 (in house check Oct-20)	In house check: Oct-22
RF generator R&S SMT-06	SN: 100972	15-Jun-15 (in house check Oct-20)	In house check: Oct-22
Network Analyzer Agilent E8358A	SN: US41080477	31-Mar-14 (in house check Oct-20)	In house check: Oct-21

Calibrated by: **Michael Weber** Laboratory Technician

Signature

Approved by: **Katja Pokovic** Technical Manager

Issued: June 8, 2021

This calibration certificate shall not be reproduced except in full without written approval of the laboratory.



Accredited by the Swiss Accreditation Service (SAS)

The Swiss Accreditation Service is one of the signatories to the EA Multilateral Agreement for the recognition of calibration certificates

Accreditation No.: **SCS 0108**

### Glossary:

TSL	tissue simulating liquid
ConvF	sensitivity in TSL / NORM x,y,z
N/A	not applicable or not measured

### Calibration is Performed According to the Following Standards:

- IEEE Std 1528-2013, "IEEE Recommended Practice for Determining the Peak Spatial-Averaged Specific Absorption Rate (SAR) in the Human Head from Wireless Communications Devices: Measurement Techniques", June 2013
- IEC 62209-1, "Measurement procedure for the assessment of Specific Absorption Rate (SAR) from hand-held and body-mounted devices used next to the ear (frequency range of 300 MHz to 6 GHz)", July 2016
- IEC 62209-2, "Procedure to determine the Specific Absorption Rate (SAR) for wireless communication devices used in close proximity to the human body (frequency range of 30 MHz to 6 GHz)", March 2010
- KDB 865664, "SAR Measurement Requirements for 100 MHz to 6 GHz"

### Additional Documentation:

- DASY4/5 System Handbook

### Methods Applied and Interpretation of Parameters:

- Measurement Conditions:** Further details are available from the Validation Report at the end of the certificate. All figures stated in the certificate are valid at the frequency indicated.
- Antenna Parameters with TSL:** The dipole is mounted with the spacer to position its feed point exactly below the center marking of the flat phantom section, with the arms oriented parallel to the body axis.
- Feed Point Impedance and Return Loss:** These parameters are measured with the dipole positioned under the liquid filled phantom. The impedance stated is transformed from the measurement at the SMA connector to the feed point. The Return Loss ensures low reflected power. No uncertainty required.
- Electrical Delay:** One-way delay between the SMA connector and the antenna feed point. No uncertainty required.
- SAR measured:** SAR measured at the stated antenna input power.
- SAR normalized:** SAR as measured, normalized to an input power of 1 W at the antenna connector.
- SAR for nominal TSL parameters:** The measured TSL parameters are used to calculate the nominal SAR result.

The reported uncertainty of measurement is stated as the standard uncertainty of measurement multiplied by the coverage factor  $k=2$ , which for a normal distribution corresponds to a coverage probability of approximately 95%.

## Measurement Conditions

DASY system configuration, as far as not given on page 1.

<b>DASY Version</b>	DASY5	V52.10.4
<b>Extrapolation</b>	Advanced Extrapolation	
<b>Phantom</b>	Modular Flat Phantom	
<b>Distance Dipole Center - TSL</b>	10 mm	with Spacer
<b>Zoom Scan Resolution</b>	dx, dy, dz = 5 mm	
<b>Frequency</b>	1900 MHz ± 1 MHz	

## Head TSL parameters

The following parameters and calculations were applied.

	<b>Temperature</b>	<b>Permittivity</b>	<b>Conductivity</b>
<b>Nominal Head TSL parameters</b>	22.0 °C	40.0	1.40 mho/m
<b>Measured Head TSL parameters</b>	(22.0 ± 0.2) °C	40.9 ± 6 %	1.41 mho/m ± 6 %
<b>Head TSL temperature change during test</b>	< 0.5 °C	----	----

## SAR result with Head TSL

<b>SAR averaged over 1 cm<sup>3</sup> (1 g) of Head TSL</b>	Condition	
SAR measured	250 mW input power	10.1 W/kg
SAR for nominal Head TSL parameters	normalized to 1W	<b>40.4 W/kg ± 17.0 % (k=2)</b>

<b>SAR averaged over 10 cm<sup>3</sup> (10 g) of Head TSL</b>	condition	
SAR measured	250 mW input power	5.28 W/kg
SAR for nominal Head TSL parameters	normalized to 1W	<b>21.1 W/kg ± 16.5 % (k=2)</b>

## Appendix (Additional assessments outside the scope of SCS 0108)

### Antenna Parameters with Head TSL

Impedance, transformed to feed point	53.3 $\Omega$ + 5.4 $j\Omega$
Return Loss	- 24.2 dB

### General Antenna Parameters and Design

Electrical Delay (one direction)	1.192 ns
----------------------------------	----------

After long term use with 100W radiated power, only a slight warming of the dipole near the feedpoint can be measured.

The dipole is made of standard semirigid coaxial cable. The center conductor of the feeding line is directly connected to the second arm of the dipole. The antenna is therefore short-circuited for DC-signals. On some of the dipoles, small end caps are added to the dipole arms in order to improve matching when loaded according to the position as explained in the "Measurement Conditions" paragraph. The SAR data are not affected by this change. The overall dipole length is still according to the Standard.

No excessive force must be applied to the dipole arms, because they might bend or the soldered connections near the feedpoint may be damaged.

### Additional EUT Data

Manufactured by	SPEAG
-----------------	-------

#### Extended Calibration

Usage of SAR dipoles calibrated less than 3 years ago but more than 1 year ago were confirmed in maintaining return loss (<-20 dB, within 20% of prior calibration) and impedance (within 5 ohm from prior calibration) requirements per extended calibrations in KDB Publication 865664 D01 v01r04.

D1900V2 SN: 5d147 - Head						
Date of Measurement	Return Loss (dB)	$\Delta\%$	Impedance Real ( $\Omega$ )	$\Delta\Omega$	Impedance Imaginary ( $j\Omega$ )	$\Delta\Omega$
6/4/2021	-24.2		53.3		5.4	
6/4/2022	-25.6	5.8	52.6	-0.7	5.7	0.3
6/6/2023	-26.2	8.3	54.6	1.3	5.5	0.1

## DASY5 Validation Report for Head TSL

Date: 04.06.2021

Test Laboratory: SPEAG, Zurich, Switzerland

**DUT: Dipole 1900 MHz; Type: D1900V2; Serial: D1900V2 - SN:5d147**

Communication System: UID 0 - CW; Frequency: 1900 MHz

Medium parameters used:  $f = 1900$  MHz;  $\sigma = 1.41$  S/m;  $\epsilon_r = 40.9$ ;  $\rho = 1000$  kg/m<sup>3</sup>

Phantom section: Flat Section

Measurement Standard: DASY5 (IEEE/IEC/ANSI C63.19-2011)

DASY52 Configuration:

- Probe: EX3DV4 - SN7349; ConvF(8.43, 8.43, 8.43) @ 1900 MHz; Calibrated: 28.12.2020
- Sensor-Surface: 1.4mm (Mechanical Surface Detection)
- Electronics: DAE4 Sn601; Calibrated: 02.11.2020
- Phantom: Flat Phantom 5.0 (front); Type: QD 000 P50 AA; Serial: 1001
- DASY52 52.10.4(1527); SEMCAD X 14.6.14(7483)

### Dipole Calibration for Head Tissue/Pin=250 mW, d=10mm/Zoom Scan (7x7x7)/Cube 0:

Measurement grid: dx=5mm, dy=5mm, dz=5mm

Reference Value = 110.2 V/m; Power Drift = 0.04 dB

Peak SAR (extrapolated) = 18.7 W/kg

**SAR(1 g) = 10.1 W/kg; SAR(10 g) = 5.28 W/kg**

Smallest distance from peaks to all points 3 dB below = 10 mm

Ratio of SAR at M2 to SAR at M1 = 54.6%

Maximum value of SAR (measured) = 15.6 W/kg

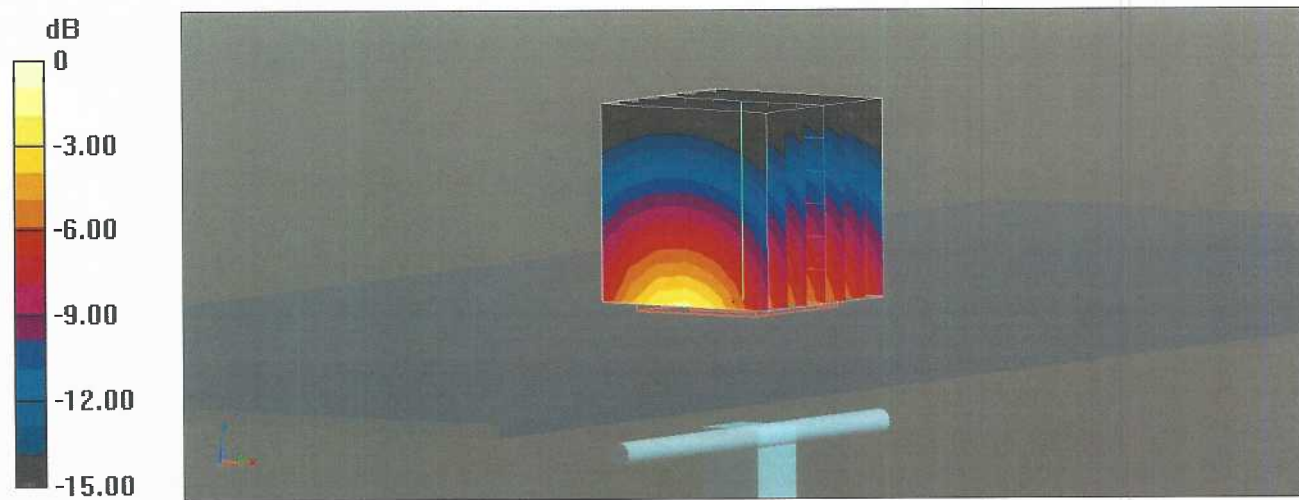

0 dB = 15.6 W/kg = 11.93 dBW/kg



# Impedance Measurement Plot for Head TSL

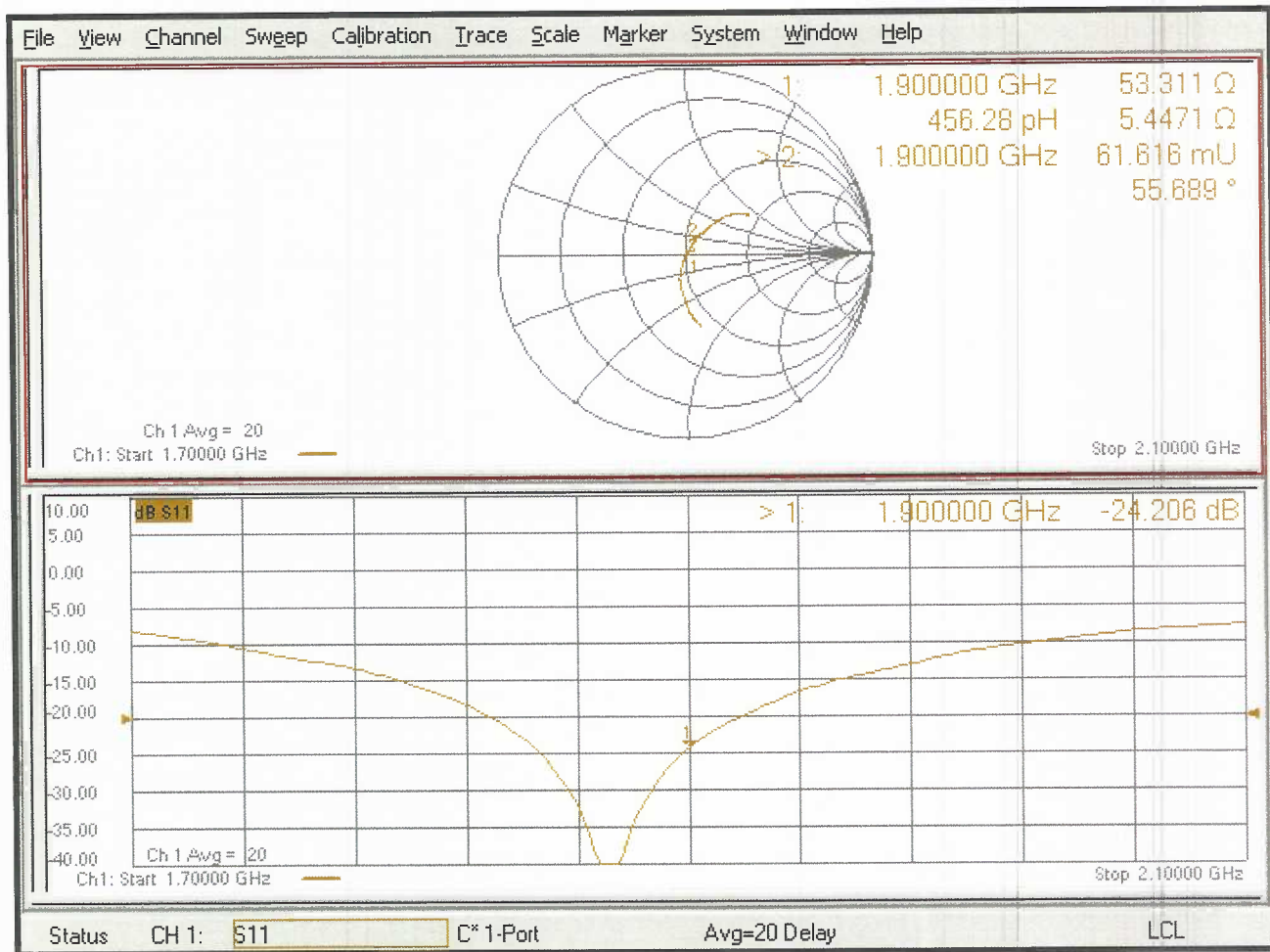

**Calibration Laboratory of  
Schmid & Partner  
Engineering AG**  
Zeughausstrasse 43, 8004 Zurich, Switzerland



**S** Schweizerischer Kalibrierdienst  
**C** Service suisse d'étalonnage  
**S** Servizio svizzero di taratura  
**S** Swiss Calibration Service

Accredited by the Swiss Accreditation Service (SAS)  
The Swiss Accreditation Service is one of the signatories to the EA  
Multilateral Agreement for the recognition of calibration certificates

Accreditation No.: **SCS 0108**

Client **RF Exposure Lab**

Certificate No: **D2550V2-1003\_Jun21**

## CALIBRATION CERTIFICATE

Object **D2550V2 - SN:1003**

Calibration procedure(s) **QA CAL-05.v11  
Calibration Procedure for SAR Validation Sources between 0.7-3 GHz**

Calibration date: **June 03, 2021**

This calibration certificate documents the traceability to national standards, which realize the physical units of measurements (SI).  
The measurements and the uncertainties with confidence probability are given on the following pages and are part of the certificate.

All calibrations have been conducted in the closed laboratory facility: environment temperature (22 ± 3)°C and humidity < 70%.

Calibration Equipment used (M&TE critical for calibration)

Primary Standards	ID #	Cal Date (Certificate No.)	Scheduled Calibration
Power meter NRP	SN: 104778	09-Apr-21 (No. 217-03291/03292)	Apr-22
Power sensor NRP-Z91	SN: 103244	09-Apr-21 (No. 217-03291)	Apr-22
Power sensor NRP-Z91	SN: 103245	09-Apr-21 (No. 217-03292)	Apr-22
Reference 20 dB Attenuator	SN: BH9394 (20k)	09-Apr-21 (No. 217-03343)	Apr-22
Type-N mismatch combination	SN: 310982 / 06327	09-Apr-21 (No. 217-03344)	Apr-22
Reference Probe EX3DV4	SN: 7349	28-Dec-20 (No. EX3-7349_Dec20)	Dec-21
DAE4	SN: 601	02-Nov-20 (No. DAE4-601_Nov20)	Nov-21

Secondary Standards	ID #	Check Date (in house)	Scheduled Check
Power meter E4419B	SN: GB39512475	30-Oct-14 (in house check Oct-20)	In house check: Oct-22
Power sensor HP 8481A	SN: US37292783	07-Oct-15 (in house check Oct-20)	In house check: Oct-22
Power sensor HP 8481A	SN: MY41092317	07-Oct-15 (in house check Oct-20)	In house check: Oct-22
RF generator R&S SMT-06	SN: 100972	15-Jun-15 (in house check Oct-20)	In house check: Oct-22
Network Analyzer Agilent E8358A	SN: US41080477	31-Mar-14 (in house check Oct-20)	In house check: Oct-21

	Name	Function	Signature
Calibrated by:	Jeffrey Katzman	Laboratory Technician	

	Name	Function	Signature
Approved by:	Katja Pokovic	Technical Manager	

Issued: June 8, 2021

This calibration certificate shall not be reproduced except in full without written approval of the laboratory.



Accredited by the Swiss Accreditation Service (SAS)

The Swiss Accreditation Service is one of the signatories to the EA  
Multilateral Agreement for the recognition of calibration certificates

Accreditation No.: **SCS 0108**

### Glossary:

TSL	tissue simulating liquid
ConvF	sensitivity in TSL / NORM x,y,z
N/A	not applicable or not measured

### Calibration is Performed According to the Following Standards:

- IEEE Std 1528-2013, "IEEE Recommended Practice for Determining the Peak Spatial-Averaged Specific Absorption Rate (SAR) in the Human Head from Wireless Communications Devices: Measurement Techniques", June 2013
- IEC 62209-1, "Measurement procedure for the assessment of Specific Absorption Rate (SAR) from hand-held and body-mounted devices used next to the ear (frequency range of 300 MHz to 6 GHz)", July 2016
- IEC 62209-2, "Procedure to determine the Specific Absorption Rate (SAR) for wireless communication devices used in close proximity to the human body (frequency range of 30 MHz to 6 GHz)", March 2010
- KDB 865664, "SAR Measurement Requirements for 100 MHz to 6 GHz"

### Additional Documentation:

- DASY4/5 System Handbook

### Methods Applied and Interpretation of Parameters:

- Measurement Conditions:** Further details are available from the Validation Report at the end of the certificate. All figures stated in the certificate are valid at the frequency indicated.
- Antenna Parameters with TSL:** The dipole is mounted with the spacer to position its feed point exactly below the center marking of the flat phantom section, with the arms oriented parallel to the body axis.
- Feed Point Impedance and Return Loss:** These parameters are measured with the dipole positioned under the liquid filled phantom. The impedance stated is transformed from the measurement at the SMA connector to the feed point. The Return Loss ensures low reflected power. No uncertainty required.
- Electrical Delay:** One-way delay between the SMA connector and the antenna feed point. No uncertainty required.
- SAR measured:** SAR measured at the stated antenna input power.
- SAR normalized:** SAR as measured, normalized to an input power of 1 W at the antenna connector.
- SAR for nominal TSL parameters:** The measured TSL parameters are used to calculate the nominal SAR result.

The reported uncertainty of measurement is stated as the standard uncertainty of measurement multiplied by the coverage factor  $k=2$ , which for a normal distribution corresponds to a coverage probability of approximately 95%.

## Measurement Conditions

DASY system configuration, as far as not given on page 1.

<b>DASY Version</b>	DASY5	V52.10.4
<b>Extrapolation</b>	Advanced Extrapolation	
<b>Phantom</b>	Modular Flat Phantom	
<b>Distance Dipole Center - TSL</b>	10 mm	with Spacer
<b>Zoom Scan Resolution</b>	dx, dy, dz = 5 mm	
<b>Frequency</b>	2550 MHz ± 1 MHz	

## Head TSL parameters

The following parameters and calculations were applied.

	Temperature	Permittivity	Conductivity
<b>Nominal Head TSL parameters</b>	22.0 °C	39.1	1.91 mho/m
<b>Measured Head TSL parameters</b>	(22.0 ± 0.2) °C	37.3 ± 6 %	1.98 mho/m ± 6 %
<b>Head TSL temperature change during test</b>	< 0.5 °C	---	---

## SAR result with Head TSL

<b>SAR averaged over 1 cm<sup>3</sup> (1 g) of Head TSL</b>	Condition	
SAR measured	250 mW input power	14.2 W/kg
SAR for nominal Head TSL parameters	normalized to 1W	<b>55.3 W/kg ± 17.0 % (k=2)</b>

<b>SAR averaged over 10 cm<sup>3</sup> (10 g) of Head TSL</b>	condition	
SAR measured	250 mW input power	6.28 W/kg
SAR for nominal Head TSL parameters	normalized to 1W	<b>24.7 W/kg ± 16.5 % (k=2)</b>

## Appendix (Additional assessments outside the scope of SCS 0108)

### Antenna Parameters with Head TSL

Impedance, transformed to feed point	49.4 $\Omega$ - 3.5 j $\Omega$
Return Loss	- 29.0 dB

### General Antenna Parameters and Design

Electrical Delay (one direction)	1.156 ns
----------------------------------	----------

After long term use with 100W radiated power, only a slight warming of the dipole near the feedpoint can be measured.

The dipole is made of standard semirigid coaxial cable. The center conductor of the feeding line is directly connected to the second arm of the dipole. The antenna is therefore short-circuited for DC-signals. On some of the dipoles, small end caps are added to the dipole arms in order to improve matching when loaded according to the position as explained in the "Measurement Conditions" paragraph. The SAR data are not affected by this change. The overall dipole length is still according to the Standard.

No excessive force must be applied to the dipole arms, because they might bend or the soldered connections near the feedpoint may be damaged.

### Additional EUT Data

Manufactured by	SPEAG
-----------------	-------

#### Extended Calibration

Usage of SAR dipoles calibrated less than 3 years ago but more than 1 year ago were confirmed in maintaining return loss (<-20 dB, within 20% of prior calibration) and impedance (within 5 ohm from prior calibration) requirements per extended calibrations in KDB Publication 865664 D01 v01r04.

D2550V2 SN: 1003 - Head						
Date of Measurement	Return Loss (dB)	$\Delta\%$	Impedance ( $\Omega$ )	$\Delta\Omega$	Impedance Imaginary (j $\Omega$ )	$\Delta\Omega$
6/3/2021	-29.0		49.4		-3.5	
6/4/2022	-28.6	-1.4	48.5	-0.9	-3.8	-0.3
6/6/2023	-27.3	-5.9	47.1	-2.3	-4.1	-0.6

## DASY5 Validation Report for Head TSL

Date: 03.06.2021

Test Laboratory: SPEAG, Zurich, Switzerland

**DUT: Dipole 2550 MHz; Type: D2550V2; Serial: D2550V2 - SN:1003**

Communication System: UID 0 - CW; Frequency: 2550 MHz

Medium parameters used:  $f = 2550$  MHz;  $\sigma = 1.98$  S/m;  $\epsilon_r = 37.3$ ;  $\rho = 1000$  kg/m<sup>3</sup>

Phantom section: Flat Section

Measurement Standard: DASY5 (IEEE/IEC/ANSI C63.19-2011)

DASY52 Configuration:

- Probe: EX3DV4 - SN7349; ConvF(7.85, 7.85, 7.85) @ 2550 MHz; Calibrated: 28.12.2020
- Sensor-Surface: 1.4mm (Mechanical Surface Detection)
- Electronics: DAE4 Sn601; Calibrated: 02.11.2020
- Phantom: Flat Phantom 5.0 (front); Type: QD 000 P50 AA; Serial: 1001
- DASY52 52.10.4(1527); SEMCAD X 14.6.14(7483)

### **Dipole Calibration for Head Tissue/Pin=250 mW, d=10mm/Zoom Scan (7x7x7)/Cube 0:**

Measurement grid: dx=5mm, dy=5mm, dz=5mm

Reference Value = 117.6 V/m; Power Drift = 0.07 dB

Peak SAR (extrapolated) = 29.9 W/kg

**SAR(1 g) = 14.2 W/kg; SAR(10 g) = 6.28 W/kg**

Smallest distance from peaks to all points 3 dB below = 8.5 mm

Ratio of SAR at M2 to SAR at M1 = 47.1%

Maximum value of SAR (measured) = 24.3 W/kg

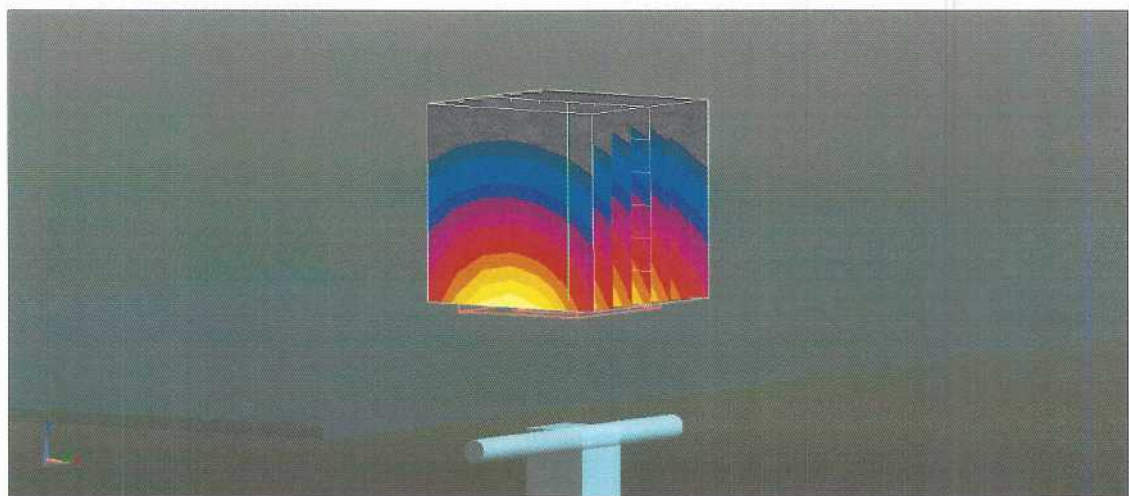
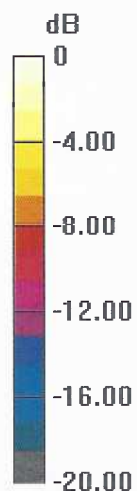

0 dB = 24.3 W/kg = 13.86 dBW/kg

# Impedance Measurement Plot for Head TSL

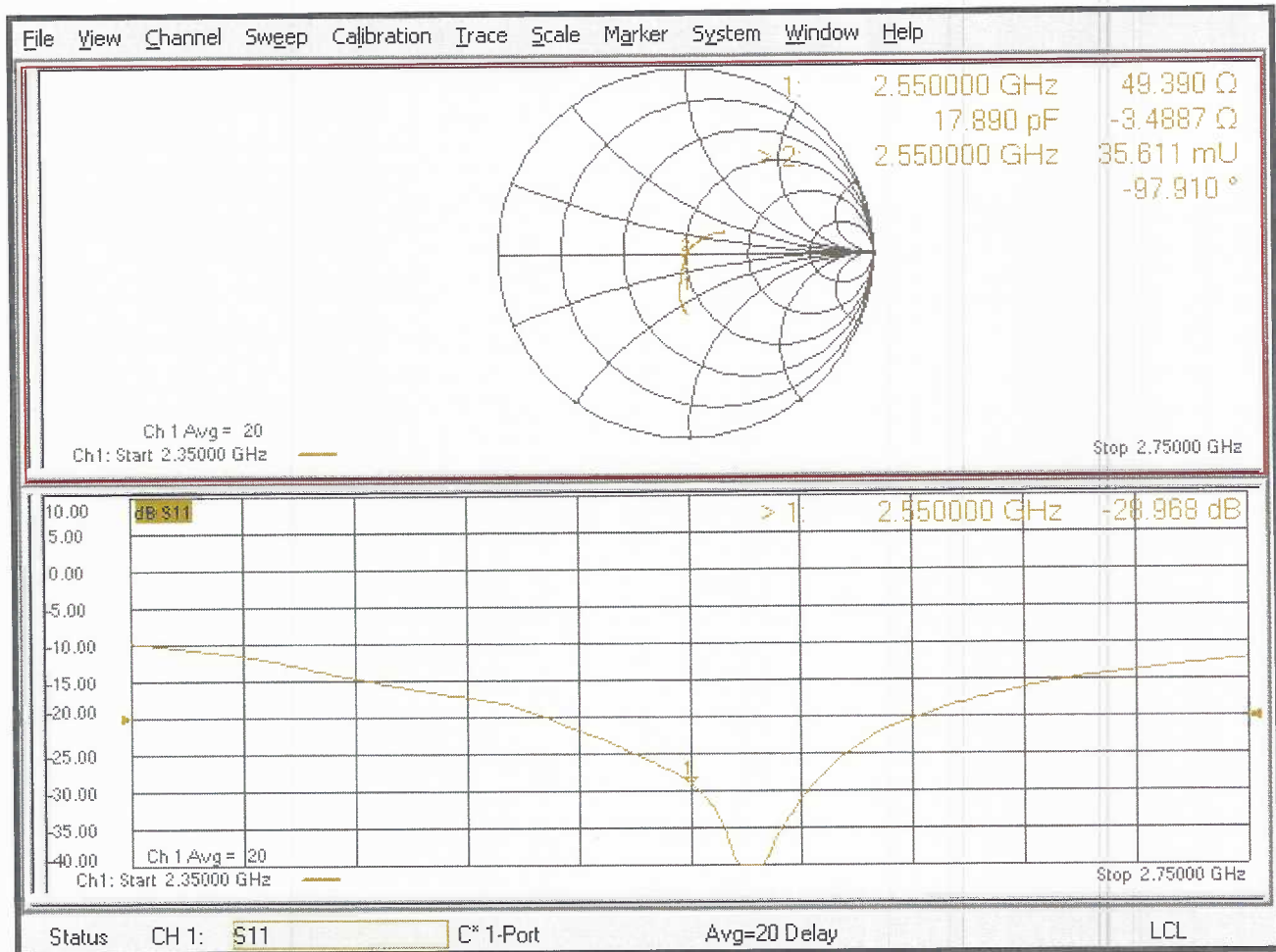

## Appendix F – DAE Calibration Data Sheets





Accredited by the Swiss Accreditation Service (SAS)  
The Swiss Accreditation Service is one of the signatories to the EA  
Multilateral Agreement for the recognition of calibration certificates

Accreditation No.: **SCS 0108**

Client **RF Exposure Lab**

Certificate No: **DAE4-1217\_Feb23**

**CALIBRATION CERTIFICATE**

Object **DAE4 - SD 000 D04 BJ - SN: 1217**

Calibration procedure(s) **QA CAL-06.v30  
Calibration procedure for the data acquisition electronics (DAE)**

Calibration date: **February 14, 2023**

This calibration certificate documents the traceability to national standards, which realize the physical units of measurements (SI).  
The measurements and the uncertainties with confidence probability are given on the following pages and are part of the certificate.

All calibrations have been conducted in the closed laboratory facility: environment temperature (22 ± 3)°C and humidity < 70%.

Calibration Equipment used (M&TE critical for calibration)

Primary Standards	ID #	Cal Date (Certificate No.)	Scheduled Calibration
Keithley Multimeter Type 2001	SN: 0810278	29-Aug-22 (No:34389)	Aug-23
Secondary Standards	ID #	Check Date (in house)	Scheduled Check
Auto DAE Calibration Unit	SE UWS 053 AA 1001	27-Jan-23 (in house check)	In house check: Jan-24
Calibrator Box V2.1	SE UMS 006 AA 1002	27-Jan-23 (in house check)	In house check: Jan-24

Calibrated by: **Name** Adrian Gehring **Function** Laboratory Technician

**Signature**

Approved by: **Name** Sven Kühn **Function** Technical Manager

Issued: February 14, 2023

This calibration certificate shall not be reproduced except in full without written approval of the laboratory.



Accredited by the Swiss Accreditation Service (SAS)  
The Swiss Accreditation Service is one of the signatories to the EA  
Multilateral Agreement for the recognition of calibration certificates

## Glossary

DAE data acquisition electronics  
Connector angle information used in DASY system to align probe sensor X to the robot coordinate system.

## Methods Applied and Interpretation of Parameters

- *DC Voltage Measurement*: Calibration Factor assessed for use in DASY system by comparison with a calibrated instrument traceable to national standards. The figure given corresponds to the full scale range of the voltmeter in the respective range.
- *Connector angle*: The angle of the connector is assessed measuring the angle mechanically by a tool inserted. Uncertainty is not required.
- The following parameters as documented in the Appendix contain technical information as a result from the performance test and require no uncertainty.
  - *DC Voltage Measurement Linearity*: Verification of the Linearity at +10% and -10% of the nominal calibration voltage. Influence of offset voltage is included in this measurement.
  - *Common mode sensitivity*: Influence of a positive or negative common mode voltage on the differential measurement.
  - *Channel separation*: Influence of a voltage on the neighbor channels not subject to an input voltage.
  - *AD Converter Values with inputs shorted*: Values on the internal AD converter corresponding to zero input voltage
  - *Input Offset Measurement*: Output voltage and statistical results over a large number of zero voltage measurements.
  - *Input Offset Current*: Typical value for information; Maximum channel input offset current, not considering the input resistance.
  - *Input resistance*: Typical value for information: DAE input resistance at the connector, during internal auto-zeroing and during measurement.
  - *Low Battery Alarm Voltage*: Typical value for information. Below this voltage, a battery alarm signal is generated.
  - *Power consumption*: Typical value for information. Supply currents in various operating modes.

## DC Voltage Measurement

A/D - Converter Resolution nominal

High Range: 1LSB = 6.1 $\mu$ V, full range = -100...+300 mV

Low Range: 1LSB = 61nV, full range = -1.....+3mV

DASY measurement parameters: Auto Zero Time: 3 sec; Measuring time: 3 sec

Calibration Factors	X	Y	Z
High Range	403.728 $\pm$ 0.02% (k=2)	404.159 $\pm$ 0.02% (k=2)	403.544 $\pm$ 0.02% (k=2)
Low Range	3.96075 $\pm$ 1.50% (k=2)	3.99910 $\pm$ 1.50% (k=2)	3.95128 $\pm$ 1.50% (k=2)

## Connector Angle

Connector Angle to be used in DASY system	282.0 $^{\circ}$ $\pm$ 1 $^{\circ}$
---	-------------------------------------

## Appendix (Additional assessments outside the scope of SCS0108)

### 1. DC Voltage Linearity

High Range	Reading ( $\mu\text{V}$ )	Difference ( $\mu\text{V}$ )	Error (%)
Channel X + Input	199998.06	3.61	0.00
Channel X + Input	20004.03	1.44	0.01
Channel X - Input	-19999.29	1.91	-0.01
Channel Y + Input	199998.59	4.10	0.00
Channel Y + Input	20003.11	0.68	0.00
Channel Y - Input	-20001.61	-0.37	0.00
Channel Z + Input	199993.34	-1.05	-0.00
Channel Z + Input	20000.75	-1.64	-0.01
Channel Z - Input	-20002.31	-0.99	0.00

Low Range	Reading ( $\mu\text{V}$ )	Difference ( $\mu\text{V}$ )	Error (%)
Channel X + Input	2003.09	1.39	0.07
Channel X + Input	202.30	0.39	0.19
Channel X - Input	-197.64	0.35	-0.18
Channel Y + Input	2002.61	1.16	0.06
Channel Y + Input	201.33	-0.48	-0.24
Channel Y - Input	-198.30	-0.26	0.13
Channel Z + Input	2002.06	0.74	0.04
Channel Z + Input	200.23	-1.45	-0.72
Channel Z - Input	-199.25	-1.07	0.54

### 2. Common mode sensitivity

DASY measurement parameters: Auto Zero Time: 3 sec; Measuring time: 3 sec

	Common mode Input Voltage (mV)	High Range Average Reading ( $\mu\text{V}$ )	Low Range Average Reading ( $\mu\text{V}$ )
Channel X	200	-1.27	-3.91
	- 200	5.04	3.07
Channel Y	200	17.98	17.91
	- 200	-19.51	-19.36
Channel Z	200	-13.62	-13.42
	- 200	11.84	11.45

### 3. Channel separation

DASY measurement parameters: Auto Zero Time: 3 sec; Measuring time: 3 sec

	Input Voltage (mV)	Channel X ( $\mu\text{V}$ )	Channel Y ( $\mu\text{V}$ )	Channel Z ( $\mu\text{V}$ )
Channel X	200	-	0.66	-4.91
Channel Y	200	7.42	-	0.76
Channel Z	200	10.20	5.17	-

#### 4. AD-Converter Values with inputs shorted

DASY measurement parameters: Auto Zero Time: 3 sec; Measuring time: 3 sec

	High Range (LSB)	Low Range (LSB)
Channel X	16287	14305
Channel Y	15792	14215
Channel Z	16818	15854

#### 5. Input Offset Measurement

DASY measurement parameters: Auto Zero Time: 3 sec; Measuring time: 3 sec

Input 10M $\Omega$

	Average ( $\mu$ V)	min. Offset ( $\mu$ V)	max. Offset ( $\mu$ V)	Std. Deviation ( $\mu$ V)
Channel X	0.55	-0.41	1.58	0.43
Channel Y	-0.44	-2.12	0.86	0.55
Channel Z	-0.77	-2.07	0.55	0.49

#### 6. Input Offset Current

Nominal Input circuitry offset current on all channels: <25fA

#### 7. Input Resistance (Typical values for information)

	Zeroing (kOhm)	Measuring (MOhm)
Channel X	200	200
Channel Y	200	200
Channel Z	200	200

#### 8. Low Battery Alarm Voltage (Typical values for information)

Typical values	Alarm Level (VDC)
Supply (+ Vcc)	+7.9
Supply (- Vcc)	-7.6

#### 9. Power Consumption (Typical values for information)

Typical values	Switched off (mA)	Stand by (mA)	Transmitting (mA)
Supply (+ Vcc)	+0.01	+6	+14
Supply (- Vcc)	-0.01	-8	-9



Accredited by the Swiss Accreditation Service (SAS)  
The Swiss Accreditation Service is one of the signatories to the EA  
Multilateral Agreement for the recognition of calibration certificates

Accreditation No.: **SCS 0108**

Client **RF Exposure Lab**  
San Marcos, USA

Certificate No: **DAE4-1416\_Apr23**

## CALIBRATION CERTIFICATE

Object **DAE4 - SD 000 D04 BM - SN: 1416**

Calibration procedure(s) **QA CAL-06.v30**  
**Calibration procedure for the data acquisition electronics (DAE)**

Calibration date: **April 19, 2023**

This calibration certificate documents the traceability to national standards, which realize the physical units of measurements (SI).  
The measurements and the uncertainties with confidence probability are given on the following pages and are part of the certificate.

All calibrations have been conducted in the closed laboratory facility: environment temperature ( $22 \pm 3$ )°C and humidity < 70%.

Calibration Equipment used (M&TE critical for calibration)

Primary Standards	ID #	Cal Date (Certificate No.)	Scheduled Calibration
Keithley Multimeter Type 2001	SN: 0810278	29-Aug-22 (No:34389)	Aug-23
Secondary Standards	ID #	Check Date (in house)	Scheduled Check
Auto DAE Calibration Unit	SE UWS 053 AA 1001	27-Jan-23 (in house check)	In house check: Jan-24
Calibrator Box V2.1	SE UMS 006 AA 1002	27-Jan-23 (in house check)	In house check: Jan-24

Calibrated by: **Adrian Gehring**      **Adrian Gehring**      **Adrian Gehring**  
Name      Function      Signature  
Laboratory Technician

Approved by: **Sven Kühn**      **Sven Kühn**      **Sven Kühn**  
Name      Function      Signature  
Technical Manager

Issued: April 19, 2023

This calibration certificate shall not be reproduced except in full without written approval of the laboratory.



Accredited by the Swiss Accreditation Service (SAS)

The Swiss Accreditation Service is one of the signatories to the EA  
Multilateral Agreement for the recognition of calibration certificates

## Glossary

**DAE** data acquisition electronics  
**Connector angle** information used in DASY system to align probe sensor X to the robot coordinate system.

## Methods Applied and Interpretation of Parameters

- *DC Voltage Measurement:* Calibration Factor assessed for use in DASY system by comparison with a calibrated instrument traceable to national standards. The figure given corresponds to the full scale range of the voltmeter in the respective range.
- *Connector angle:* The angle of the connector is assessed measuring the angle mechanically by a tool inserted. Uncertainty is not required.
- The following parameters as documented in the Appendix contain technical information as a result from the performance test and require no uncertainty.
  - *DC Voltage Measurement Linearity:* Verification of the Linearity at +10% and -10% of the nominal calibration voltage. Influence of offset voltage is included in this measurement.
  - *Common mode sensitivity:* Influence of a positive or negative common mode voltage on the differential measurement.
  - *Channel separation:* Influence of a voltage on the neighbor channels not subject to an input voltage.
  - *AD Converter Values with inputs shorted:* Values on the internal AD converter corresponding to zero input voltage
  - *Input Offset Measurement:* Output voltage and statistical results over a large number of zero voltage measurements.
  - *Input Offset Current:* Typical value for information; Maximum channel input offset current, not considering the input resistance.
  - *Input resistance:* Typical value for information: DAE input resistance at the connector, during internal auto-zeroing and during measurement.
  - *Low Battery Alarm Voltage:* Typical value for information. Below this voltage, a battery alarm signal is generated.
  - *Power consumption:* Typical value for information. Supply currents in various operating modes.

## DC Voltage Measurement

A/D - Converter Resolution nominal

High Range: 1LSB = 6.1 $\mu$ V, full range = -100...+300 mV

Low Range: 1LSB = 61nV, full range = -1.....+3mV

DASY measurement parameters: Auto Zero Time: 3 sec; Measuring time: 3 sec

Calibration Factors	X	Y	Z
High Range	403.576 $\pm$ 0.02% (k=2)	403.882 $\pm$ 0.02% (k=2)	404.149 $\pm$ 0.02% (k=2)
Low Range	3.97826 $\pm$ 1.50% (k=2)	3.99531 $\pm$ 1.50% (k=2)	3.97142 $\pm$ 1.50% (k=2)

## Connector Angle

Connector Angle to be used in DASY system	181.0 $^{\circ}$ $\pm$ 1 $^{\circ}$
---	-------------------------------------



## Appendix (Additional assessments outside the scope of SCS0108)

### 1. DC Voltage Linearity

High Range	Reading ( $\mu\text{V}$ )	Difference ( $\mu\text{V}$ )	Error (%)
Channel X + Input	199994.69	-0.41	-0.00
Channel X + Input	20001.60	-1.04	-0.01
Channel X - Input	-20000.15	1.22	-0.01
Channel Y + Input	199996.57	1.52	0.00
Channel Y + Input	20000.09	-2.36	-0.01
Channel Y - Input	-20003.05	-1.65	0.01
Channel Z + Input	199995.51	0.44	0.00
Channel Z + Input	19999.49	-2.93	-0.01
Channel Z - Input	-20003.45	-2.02	0.01

Low Range	Reading ( $\mu\text{V}$ )	Difference ( $\mu\text{V}$ )	Error (%)
Channel X + Input	2001.59	-0.18	-0.01
Channel X + Input	202.16	0.15	0.07
Channel X - Input	-197.31	0.40	-0.20
Channel Y + Input	2001.43	-0.20	-0.01
Channel Y + Input	201.00	-0.84	-0.42
Channel Y - Input	-198.62	-0.66	0.33
Channel Z + Input	2001.53	-0.06	-0.00
Channel Z + Input	200.32	-1.54	-0.76
Channel Z - Input	-199.56	-1.57	0.79

### 2. Common mode sensitivity

DASY measurement parameters: Auto Zero Time: 3 sec; Measuring time: 3 sec

	Common mode Input Voltage (mV)	High Range Average Reading ( $\mu\text{V}$ )	Low Range Average Reading ( $\mu\text{V}$ )
Channel X	200	-3.92	-4.61
	- 200	7.37	4.65
Channel Y	200	-5.88	-7.43
	- 200	6.96	5.86
Channel Z	200	-23.77	-23.62
	- 200	21.74	21.52

### 3. Channel separation

DASY measurement parameters: Auto Zero Time: 3 sec; Measuring time: 3 sec

	Input Voltage (mV)	Channel X ( $\mu\text{V}$ )	Channel Y ( $\mu\text{V}$ )	Channel Z ( $\mu\text{V}$ )
Channel X	200	-	2.98	-4.77
Channel Y	200	7.89	-	2.79
Channel Z	200	9.17	6.36	-

#### 4. AD-Converter Values with inputs shorted

DASY measurement parameters: Auto Zero Time: 3 sec; Measuring time: 3 sec

	High Range (LSB)	Low Range (LSB)
Channel X	15996	17581
Channel Y	16150	16491
Channel Z	16130	15361

#### 5. Input Offset Measurement

DASY measurement parameters: Auto Zero Time: 3 sec; Measuring time: 3 sec

Input 10M $\Omega$

	Average ( $\mu$ V)	min. Offset ( $\mu$ V)	max. Offset ( $\mu$ V)	Std. Deviation ( $\mu$ V)
Channel X	0.78	-0.03	1.52	0.32
Channel Y	-0.79	-1.76	0.77	0.41
Channel Z	-0.57	-1.39	0.58	0.37

#### 6. Input Offset Current

Nominal Input circuitry offset current on all channels: <25fA

#### 7. Input Resistance (Typical values for information)

	Zeroing (kOhm)	Measuring (MOhm)
Channel X	200	200
Channel Y	200	200
Channel Z	200	200

#### 8. Low Battery Alarm Voltage (Typical values for information)

Typical values	Alarm Level (VDC)
Supply (+ Vcc)	+7.9
Supply (- Vcc)	-7.6

#### 9. Power Consumption (Typical values for information)

Typical values	Switched off (mA)	Stand by (mA)	Transmitting (mA)
Supply (+ Vcc)	+0.01	+6	+14
Supply (- Vcc)	-0.01	-8	-9

## Appendix G – Phantom Calibration Data Sheets

**Certificate of Conformity / First Article Inspection**

Item	Oval Flat Phantom ELI 4.0
Type No	QD OVA 001 B
Series No	1003 and higher
Manufacturer	Untersee Composites Knebelstrasse 8 CH-8268 Mannenbach, Switzerland

**Tests**

Complete tests were made on the prototype units QD OVA 001 AA 1001, QD OVA 001 AB 1002, pre-series units QD OVA 001 BA 1003-1005 as well as on the series units QD OVA 001 BB, 1006 ff.

Test	Requirement	Details	Units tested
Material thickness	Compliant with the standard requirements	Bottom plate: 2.0mm +/- 0.2mm	all
Material parameters	Dielectric parameters for required frequencies	< 6 GHz: Rel. permittivity = 4 +/-1, Loss tangent ≤ 0.05	Material sample
Material resistivity	The material has been tested to be compatible with the liquids defined in the standards if handled and cleaned according to the instructions.	DGBE based simulating liquids. Observe Technical Note for material compatibility.	Equivalent phantoms, Material sample
Shape	Thickness of bottom material, Internal dimensions, Sagging compatible with standards from minimum frequency	Bottom elliptical 600 x 400 mm Depth 190 mm, Shape is within tolerance for filling height up to 155 mm, Eventual sagging is reduced or eliminated by support via DUT	Prototypes, Sample testing

**Standards**

- [1] CENELEC EN 50361-2001, « Basic standard for the measurement of the Specific Absorption Rate related to human exposure to electromagnetic fields from mobile phones (300 MHz – 3 GHz) », July 2001
- [2] IEEE 1528-2003, "Recommended Practice for Determining the Peak Spatial-Average Specific Absorption Rate (SAR) in the Human Head from Wireless Communications Devices: Measurement Techniques, December 2003
- [3] IEC 62209 – 1, "Specific Absorption Rate (SAR) in the frequency range of 300 MHz to 3 GHz – Measurement Procedure, Part 1: Hand-held mobile wireless communication devices", February 2005
- [4] IEC 62209 – 2, Draft, "Human Exposure to Radio Frequency Fields from Handheld and Body-Mounted Wireless Communication Devices – Human models, Instrumentation and Procedures – Part 2: Procedure to determine the Specific Absorption Rate (SAR) in the head and body for 30 MHz to 6 GHz Handheld and Body-Mounted Devices used in close proximity to the Body.", February 2005
- [5] OET Bulletin 65, Supplement C, "Evaluating Compliance with FCC Guidelines for Human Exposure to Radiofrequency Electromagnetic Fields", Edition January 2001

Based on the tests above, we certify that this item is in compliance with the standards [1] to [5] if operated according to the specific requirements and considering the thickness. The dimensions are fully compliant with [4] from 30 MHz to 6 GHz. For the other standards, the minimum lower frequency limit is limited due to the dimensional requirements ([1]: 450 MHz, [2]: 300 MHz, [3]: 800 MHz, [5]: 375 MHz) and possibly further by the dimensions of the DUT.

Date 28.4.2008 Signature / Stamp

**s p e a g**  
Schmid & Partner Engineering AG  
Zeughausstrasse 43, 8004 Zurich, Switzerland  
Phone +41 44 245 9700, Fax +41 44 245 9779  
info@speag.com; http://www.speag.com