



FCC RF Test Report

APPLICANT : Moon Winker L.L.C.
EQUIPMENT : Wireless Speaker
MODEL NAME : PW3840KL
FCC ID : 2AET6-0610
STANDARD : FCC Part 15 Subpart C §15.247
CLASSIFICATION : (DTS) Digital Transmission System

The testing was completed on Sep. 15, 2015. We, SPORTON INTERNATIONAL INC., would like to declare that the tested sample has been evaluated in accordance with the test procedures and has been in compliance with the applicable technical standards.

The test results in this report apply exclusively to the tested model / sample. Without written approval of SPORTON INTERNATIONAL INC., the test report shall not be reproduced except in full.

Reviewed by: Joseph Lin / Supervisor

Approved by: Jones Tsai / Manager



SPORTON INTERNATIONAL INC.

No. 52, Hwa Ya 1st Rd., Hwa Ya Technology Park, Kwei-Shan District, Tao Yuan City, Taiwan, R.O.C.



TABLE OF CONTENTS

SUMMARY OF TEST RESULT 4

1 GENERAL DESCRIPTION..... 5

1.1 Applicant 5

1.2 Product Feature of Equipment Under Test..... 5

1.3 Product Specification subjective to this standard 5

1.4 Modification of EUT 5

1.5 Testing Location 6

1.6 Applicable Standards..... 6

2 TEST CONFIGURATION OF EQUIPMENT UNDER TEST..... 7

2.1 Descriptions of Test Mode 7

2.2 Test Mode 8

2.3 Connection Diagram of Test System 9

2.4 Support Unit used in test configuration and system 10

2.5 EUT Operation Test Setup 10

2.6 Measurement Results Explanation Example..... 11

3 TEST RESULT 12

3.1 6dB Bandwidth Measurement 12

3.2 Peak Output Power Measurement 17

3.3 Power Spectral Density Measurement 18

3.4 Conducted Band Edges and Spurious Emission Measurement 27

3.5 Radiated Band Edges and Spurious Emission Measurement 36

3.6 AC Conducted Emission Measurement..... 41

3.7 Antenna Requirements 45

4 LIST OF MEASURING EQUIPMENT..... 46

5 UNCERTAINTY OF EVALUATION..... 47

APPENDIX A. CONDUCTED TEST RESULTS

APPENDIX B. RADIATED SPURIOUS EMISSION

APPENDIX C. RADIATED SPURIOUS EMISSION PLOTS



REVISION HISTORY

REPORT NO.	VERSION	DESCRIPTION	ISSUED DATE
FR552738-01B	Rev. 01	Initial issue of report	Sep. 21, 2015
FR552738-01B	Rev. 02	Update report of renewing standard	Jan. 21, 2016



SUMMARY OF TEST RESULT

Report Section	FCC Rule	Description	Limit	Result	Remark
3.1	15.247(a)(2)	6dB Bandwidth	$\geq 0.5\text{MHz}$	Pass	-
3.2	15.247(b)(1)	Peak Output Power	$\leq 30\text{dBm}$	Pass	-
3.3	15.247(e)	Power Spectral Density	$\leq 8\text{dBm}/3\text{kHz}$	Pass	-
3.4	15.247(d)	Conducted Band Edges and Spurious Emission	$\leq 20\text{dBc}$	Pass	-
3.5	15.247(d)	Radiated Band Edges and Spurious Emission	15.209(a) & 15.247(d)	Pass	Under limit 3.09 dB at 4690.000 MHz
3.6	15.207	AC Conducted Emission	15.207(a)	Pass	Under limit 7.40 dB at 0.406 MHz
3.7	15.203 & 15.247(b)	Antenna Requirement	N/A	Pass	-



1 General Description

1.1 Applicant

Moon Winker L.L.C.
 One Westbrook Corporate Center, Suite 300
 Westchester, Illinois, 60154

1.2 Product Feature of Equipment Under Test

Product Feature	
Equipment	Wireless Speaker
Model Name	PW3840KL
FCC ID	2AET6-0610
EUT supports Radios application	WLAN 11b/g/n HT20 Bluetooth v4.0 EDR/LE

Remark: The above EUT's information was declared by manufacturer. Please refer to the specifications or user's manual for more detailed description.

1.3 Product Specification subjective to this standard

Product Specification subjective to this standard			
Tx/Rx Frequency Range	2402 MHz ~ 2480 MHz		
Number of Channels	40		
Carrier Frequency of Each Channel	40 Channel(37 hopping + 3 advertising channel)		
Maximum Output Power to Antenna	Ant. 1: 8.59 dBm (0.0072 W) Ant. 2: 7.82 dBm (0.0061 W)		
Antenna Type	Fixed Internal Antenna type		
Antenna Gain	Channel	Ant. 1	Ant. 2
	00	3.58	2.00
	19	2.87	1.47
	39	3.06	1.24
Type of Modulation	Bluetooth LE : GFSK		

1.4 Modification of EUT

No modifications are made to the EUT during all test items.



1.5 Testing Location

Sporton Lab is accredited to ISO 17025 by Taiwan Accreditation Foundation (TAF code : 1190) and the FCC designation No. TW1022 under the FCC 2.948(e) by Mutual Recognition Agreement (MRA) in FCC Test.

Test Site	SPORTON INTERNATIONAL INC.		
Test Site Location	No. 52, Hwa Ya 1 st Rd., Hwa Ya Technology Park, Kwei-Shan District, Tao Yuan City, Taiwan, R.O.C. TEL: +886-3-327-3456 FAX: +886-3-328-4978		
Test Site No.	Sporton Site No.		
	TH05-HY	CO05-HY	03CH07-HY

Note: The test site complies with ANSI C63.4 2009 requirement.

1.6 Applicable Standards

According to the specifications of the manufacturer, the EUT must comply with the requirements of the following standards:

- ♦ FCC Part 15 Subpart C §15.247
- ♦ FCC KDB Publication No. 558074 D01 DTS Meas. Guidance v03r04
- ♦ ANSI C63.10-2009

Remark:

1. All test items were verified and recorded according to the standards and without any deviation during the test.
2. FCC permits the use of the 1.5 meter table as an alternative in C63.10-2013 through inquiry tracking number 961829.
3. This EUT has also been tested and complied with the requirements of FCC Part 15, Subpart B, recorded in a separate test report.



2 Test Configuration of Equipment Under Test

2.1 Descriptions of Test Mode

The RF output power was recorded in the following table:

<Ant. 1>

Channel	Frequency	Bluetooth 4.0 – LE RF Output Power
		Data Rate / Modulation
		GFSK
		1Mbps
Ch00	2402MHz	8.35 dBm
Ch19	2440MHz	8.59 dBm
Ch39	2480MHz	8.39 dBm

<Ant. 2>

Channel	Frequency	Bluetooth 4.0 – LE RF Output Power
		Data Rate / Modulation
		GFSK
		1Mbps
Ch00	2402MHz	7.53 dBm
Ch19	2440MHz	7.82 dBm
Ch39	2480MHz	7.49 dBm

- a. The EUT has been associated with peripherals and configuration operated in a manner tended to maximize its emission characteristics in a typical application. Frequency range investigated: conduction (150 kHz to 30 MHz), radiation (9 kHz to the 10th harmonic of the highest fundamental frequency or to 40 GHz, whichever is lower). Pre-scanned tests, X, Y, Z in three orthogonal panels to determine the final configuration (Y plane for Ant. 1 and Ant. 2 (EUT with Base); X plane for Ant. 2 as worst plane) from all possible combinations.
- b. AC power line Conducted Emission was tested under maximum output power.



2.2 Test Mode

The following summary table is showing all test modes to demonstrate in compliance with the standard.

Summary table of Test Cases	
Test Item	Data Rate / Modulation
	Bluetooth 4.0 – LE / GFSK
Conducted TCs (For Ant. 1)	Mode 1: Bluetooth Tx CH00_2402 MHz_1Mbps Mode 2: Bluetooth Tx CH19_2440 MHz_1Mbps Mode 3: Bluetooth Tx CH39_2480 MHz_1Mbps
Conducted TCs (For Ant. 2)	Mode 1: Bluetooth Tx CH00_2402 MHz_1Mbps Mode 2: Bluetooth Tx CH19_2440 MHz_1Mbps Mode 3: Bluetooth Tx CH39_2480 MHz_1Mbps
Radiated TCs	Mode 1: Bluetooth Tx CH00_2402 MHz_1Mbps for Ant. 1 Mode 2: Bluetooth Tx CH19_2440 MHz_1Mbps for Ant. 1 Mode 3: Bluetooth Tx CH39_2480 MHz_1Mbps for Ant. 1 Mode 4: Bluetooth Tx CH00_2402 MHz_1Mbps for Ant. 2 Mode 5: Bluetooth Tx CH19_2440 MHz_1Mbps for Ant. 2 Mode 6: Bluetooth Tx CH39_2480 MHz_1Mbps for Ant. 2 Mode 7: Bluetooth Tx CH39_2480 MHz_1Mbps for Ant. 2 + Base
AC Conducted Emission	Mode 1: WLAN Link + Bluetooth Link

2.3 Connection Diagram of Test System

<Bluetooth 4.0 – LE Tx Mode>

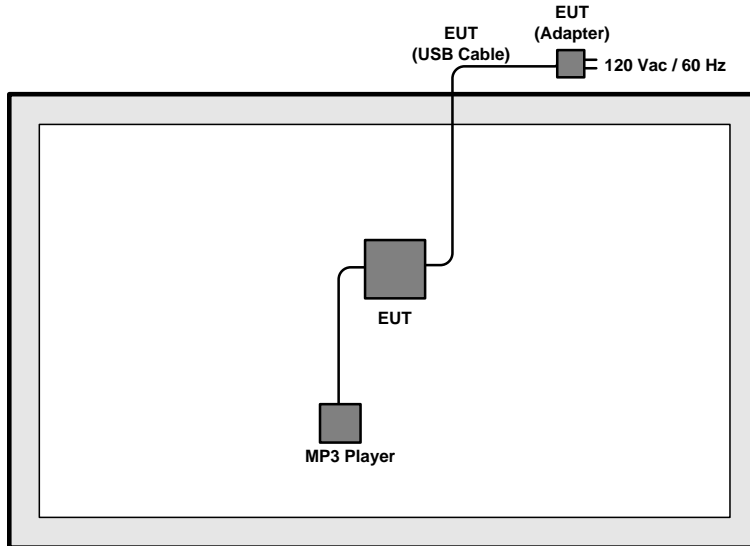

<Bluetooth 4.0 – LE Tx Mode with Base>

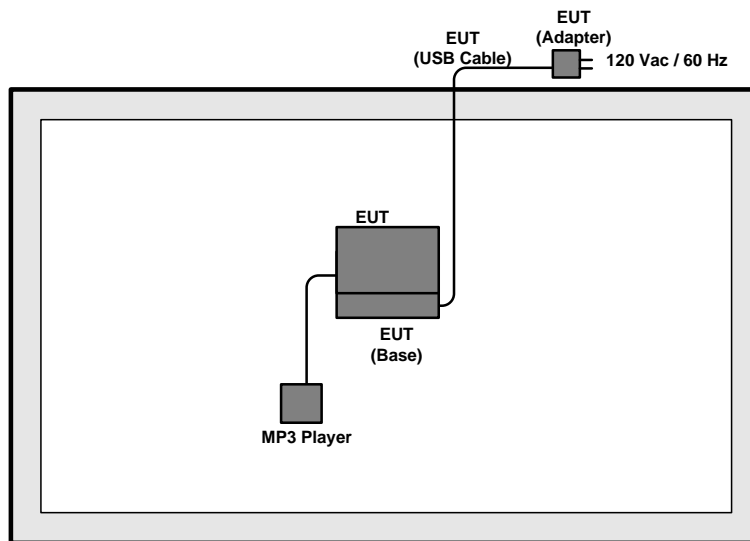

<AC Conducted Emission Mode>

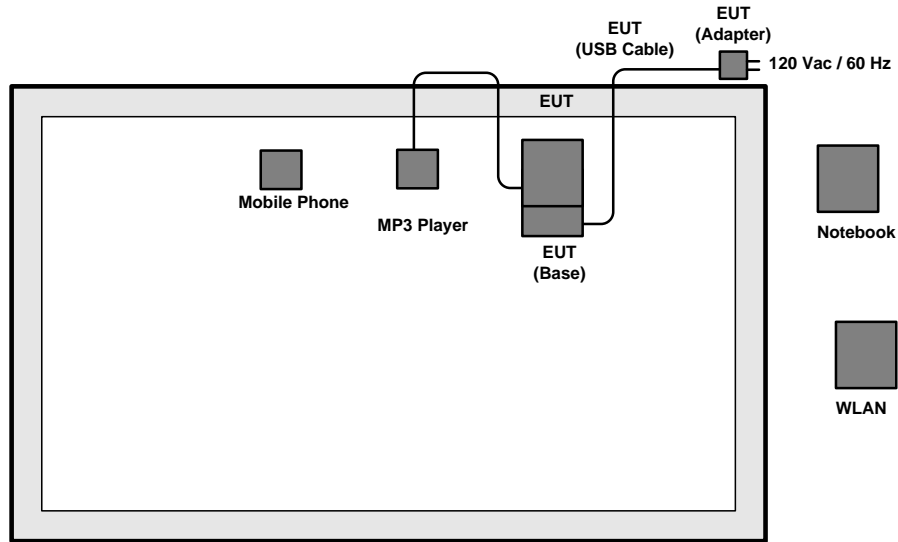

2.4 Support Unit used in test configuration and system

Item	Equipment	Trade Name	Model Name	FCC ID	Data Cable	Power Cord
1.	WLAN AP	N/A	N/A	N/A	N/A	N/A
2.	Notebook	N/A	N/A	N/A	N/A	N/A
3.	Mobile Phone	N/A	N/A	N/A	N/A	N/A
4.	MP3 Player	N/A	N/A	N/A	N/A	N/A

2.5 EUT Operation Test Setup

For Bluetooth function, programmed RF utility, installed in the notebook make the EUT provide functions like channel selection and power level for continuous transmitting and receiving signals.



2.6 Measurement Results Explanation Example

For all conducted test items:

The offset level is set in the spectrum analyzer to compensate the RF cable loss and attenuator factor between EUT conducted output port and spectrum analyzer. With the offset compensation, the spectrum analyzer reading level is exactly the EUT RF output level.

Example :

The spectrum analyzer offset is derived from RF cable loss and attenuator factor.

Offset = RF cable loss + attenuator factor.

Following shows an offset computation example with cable loss 4.2 dB and 10dB attenuator.

$$\begin{aligned} \text{Offset(dB)} &= \text{RF cable loss(dB)} + \text{attenuator factor(dB)}. \\ &= 4.2 + 10 = 14.2 \text{ (dB)} \end{aligned}$$

3 Test Result

3.1 6dB Bandwidth Measurement

3.1.1 Limit of 6dB Bandwidth

The minimum 6 dB bandwidth shall be at least 500 kHz.

3.1.2 Measuring Instruments

The measuring equipment is listed in the section 4 of this test report.

3.1.3 Test Procedures

1. The testing follows FCC KDB Publication No. 558074 D01 DTS Meas. Guidance v03r04.
2. The RF output of EUT was connected to the spectrum analyzer by RF cable and attenuator. The path loss was compensated to the results for each measurement.
3. Set to the maximum power setting and enable the EUT transmit continuously.
4. Make the measurement with the spectrum analyzer's resolution bandwidth (RBW) = 100 kHz. Set the Video bandwidth (VBW) = 300 kHz. In order to make an accurate measurement. The 6 dB bandwidth must be greater than 500 kHz.
5. Measure and record the results in the test report.

3.1.4 Test Setup



3.1.5 Test Result of 6dB Bandwidth

Please refer to Appendix A of this test report.



<Ant. 1>

6 dB Bandwidth Plot on Channel 00

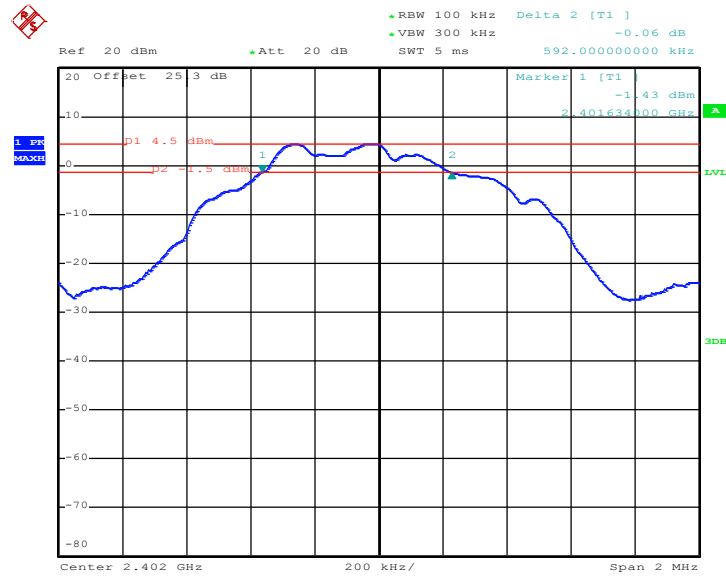

Date: 31.AUG.2015 10:16:57

6 dB Bandwidth Plot on Channel 19

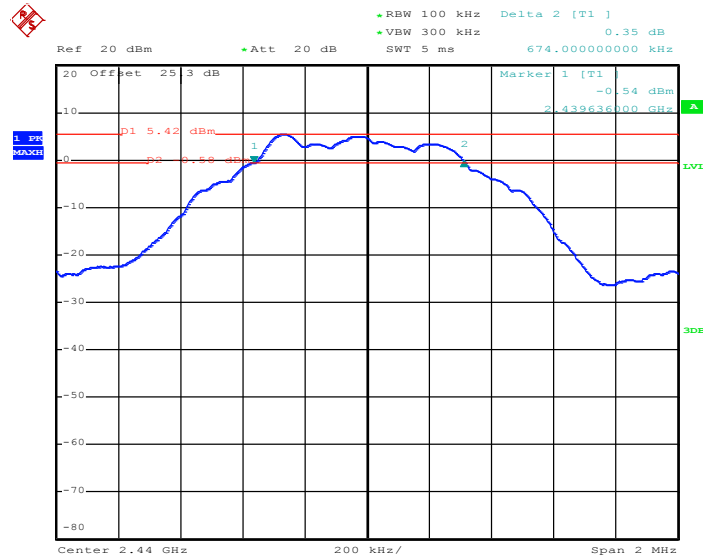

Date: 31.AUG.2015 10:28:10



6 dB Bandwidth Plot on Channel 39

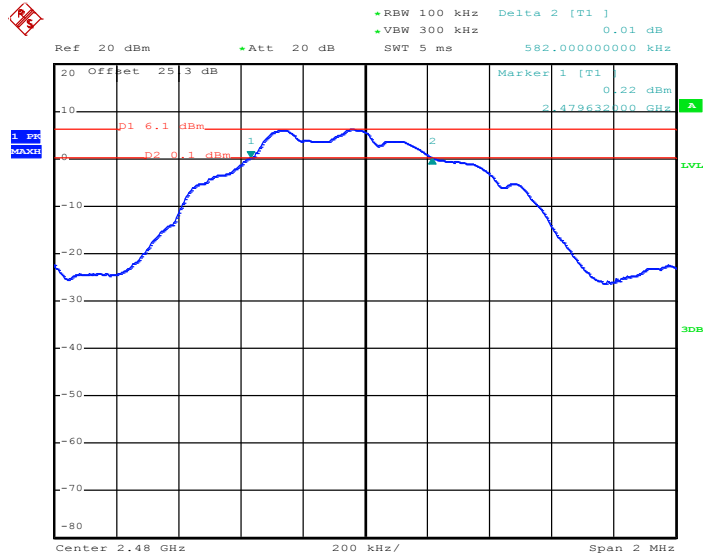

Date: 31.AUG.2015 10:43:32



<Ant. 2>

6 dB Bandwidth Plot on Channel 00

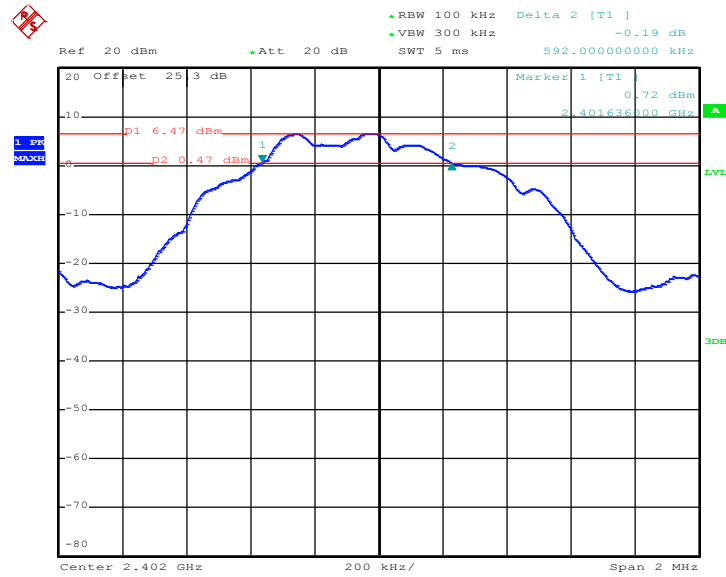

Date: 1.SEP.2015 09:42:44

6 dB Bandwidth Plot on Channel 19

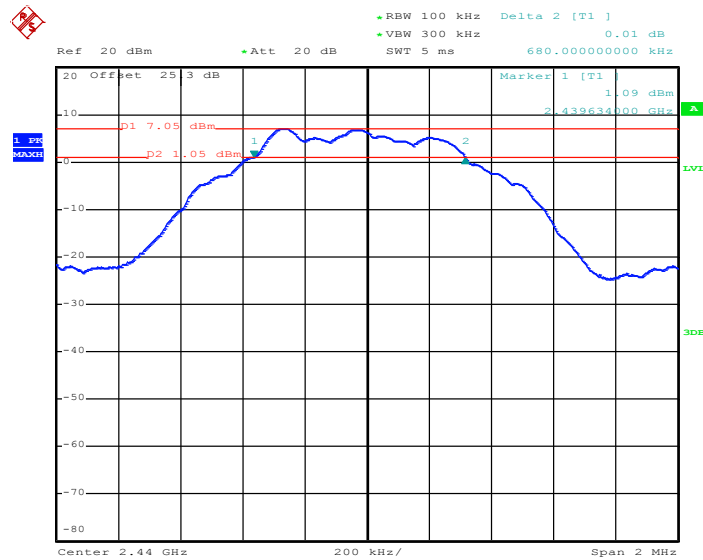

Date: 1.SEP.2015 09:56:56



6 dB Bandwidth Plot on Channel 39

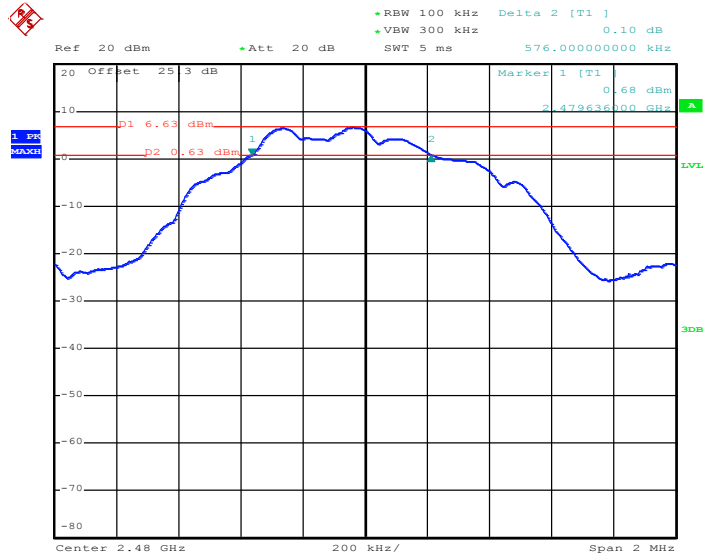

Date: 1.SEP.2015 10:03:45

3.2 Peak Output Power Measurement

3.2.1 Limit of Peak Output Power

For systems using digital modulation in the 2400-2483.5MHz, the limit for peak output power is 30dBm. If transmitting antenna of directional gain greater than 6dBi is used, the peak output power from the intentional radiator shall be reduced below the above stated value by the amount in dB that the directional gain of the antenna exceeds 6 dBi. In case of point-to-point operation, the limit has to be reduced by 1dB for every 3dB that the directional gain of the antenna exceeds 6dBi.

3.2.2 Measuring Instruments

The measuring equipment is listed in the section 4 of this test report.

3.2.3 Test Procedures

1. The testing follows the Measurement Procedure of FCC KDB No. 558074 DTS D01 Meas. Guidance v03r04 section 9.1.2 PKPM1 Peak power meter method.
2. The RF output of EUT was connected to the power meter by RF cable and attenuator. The path loss was compensated to the results for each measurement.
3. Set to the maximum power setting and enable the EUT transmit continuously.
4. Measure the conducted output power and record the results in the test report.

3.2.4 Test Setup

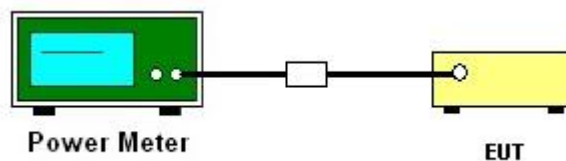

3.2.5 Test Result of Peak Output Power

Please refer to Appendix A of this test report.

3.3 Power Spectral Density Measurement

3.3.1 Limit of Power Spectral Density

The peak power spectral density shall not be greater than 8dBm in any 3kHz band at any time interval of continuous transmission.

3.3.2 Measuring Instruments

The measuring equipment is listed in the section 4 of this test report.

3.3.3 Test Procedures

1. The testing follows Measurement Procedure 10.2 Method PKPSD of FCC KDB Publication No. 558074 D01 DTS Meas. Guidance v03r04
2. The RF output of EUT was connected to the spectrum analyzer by RF cable and attenuator. The path loss was compensated to the results for each measurement.
3. Set to the maximum power setting and enable the EUT transmit continuously.
4. Make the measurement with the spectrum analyzer's resolution bandwidth (RBW) = 3 kHz. Video bandwidth VBW = 10 kHz In order to make an accurate measurement, set the span to 1.5 times DTS Channel Bandwidth. (6dB BW)
5. Detector = peak, Sweep time = auto couple, Trace mode = max hold, Allow trace to fully stabilize. Use the peak marker function to determine the maximum power level.
6. Measure and record the results in the test report.
7. The Measured power density (dBm)/ 100kHz is a reference level and used as 20dBc down limit line for Conducted Band Edges and Conducted Spurious Emission.

3.3.4 Test Setup

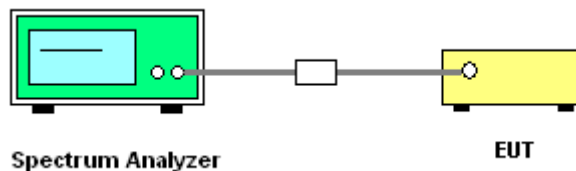

3.3.5 Test Result of Power Spectral Density

Please refer to Appendix A of this test report.



3.3.6 Test Result of Power Spectral Density Plots (100kHz)

<Ant. 1>

PSD 100kHz Plot on Channel 00

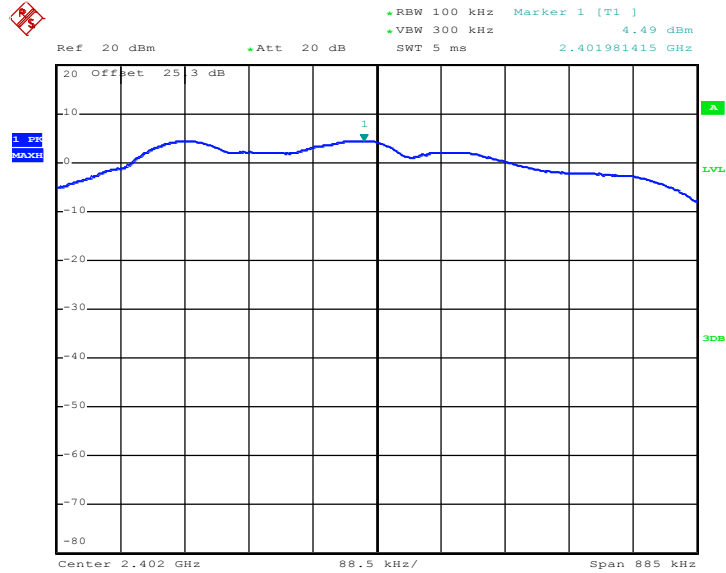

Date: 31.AUG.2015 10:18:18

PSD 100kHz Plot on Channel 19

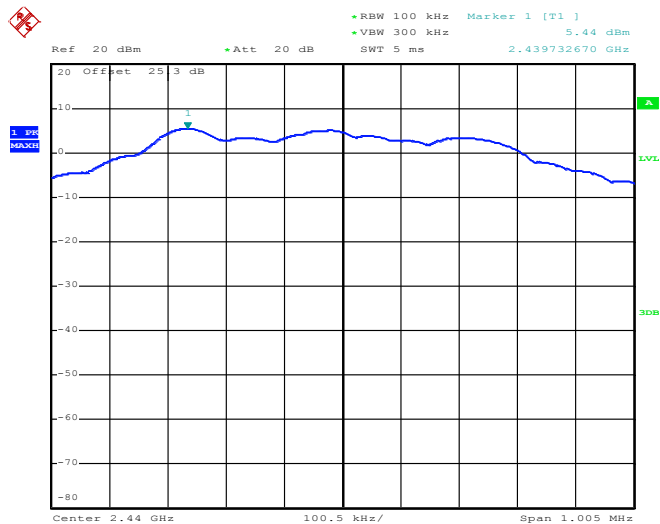

Date: 31.AUG.2015 10:31:43



PSD 100kHz Plot on Channel 39

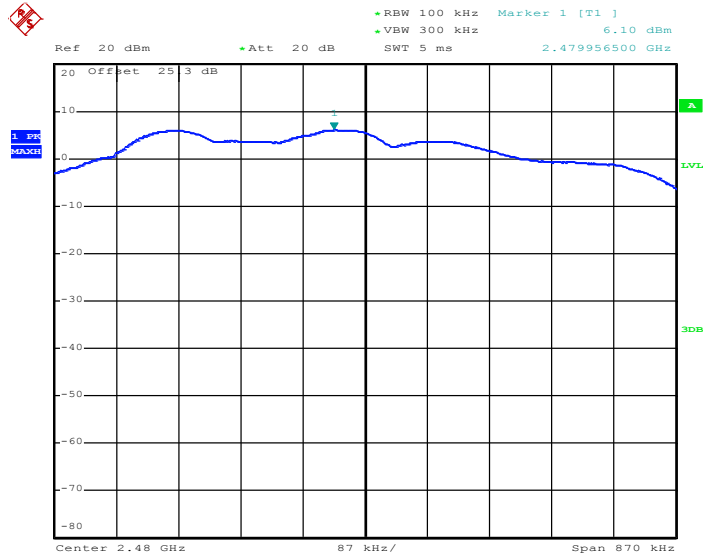

Date: 31.AUG.2015 10:45:02



<Ant. 2>

PSD 100kHz Plot on Channel 00

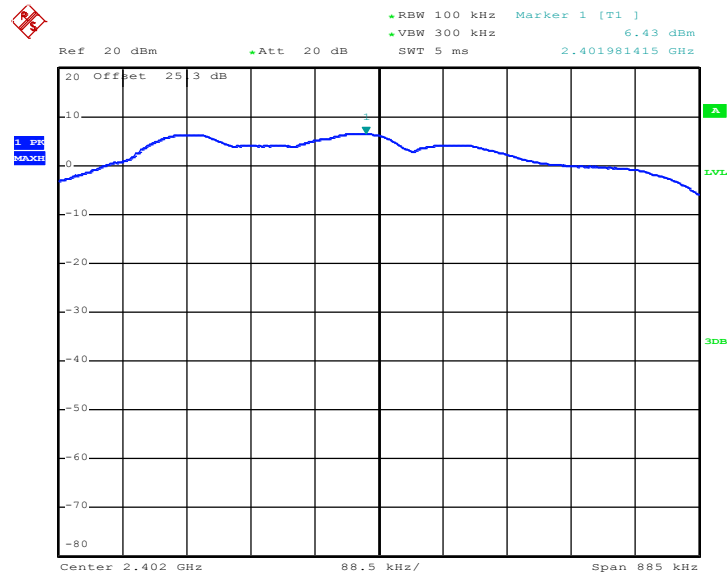

Date: 1.SEP.2015 09:44:00

PSD 100kHz Plot on Channel 19

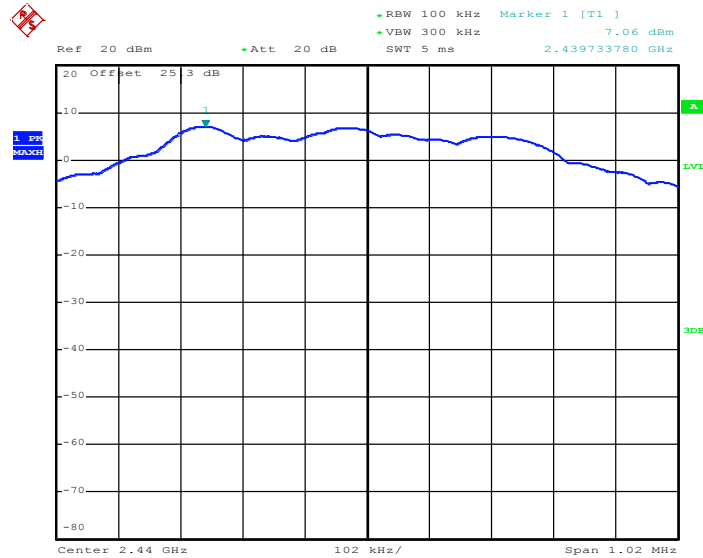

Date: 1.SEP.2015 09:59:40



PSD 100kHz Plot on Channel 39

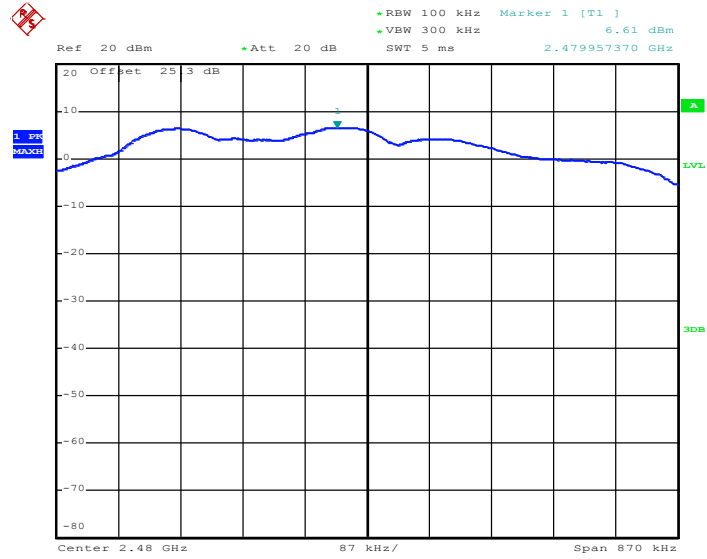

Date: 1.SEP.2015 10:04:39



3.3.7 Test Result of Power Spectral Density Plots (3kHz)

<Ant. 1>

PSD 3kHz Plot on Channel 00

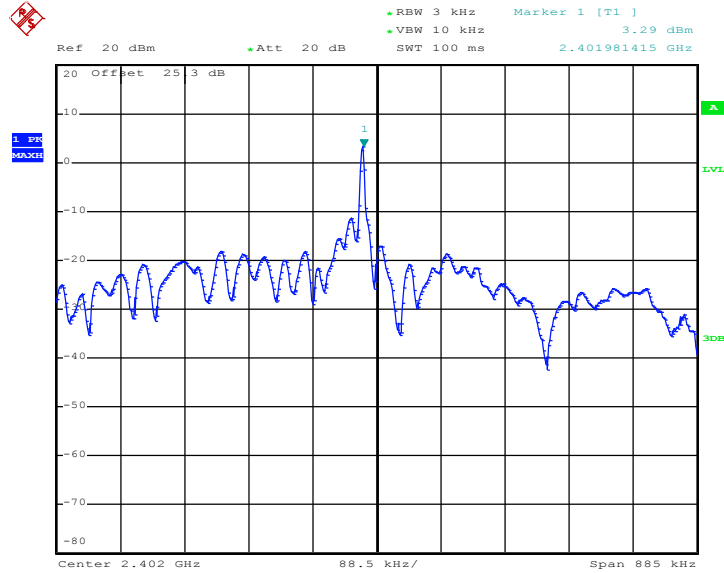

Date: 31.AUG.2015 10:17:52

PSD 3kHz Plot on Channel 19

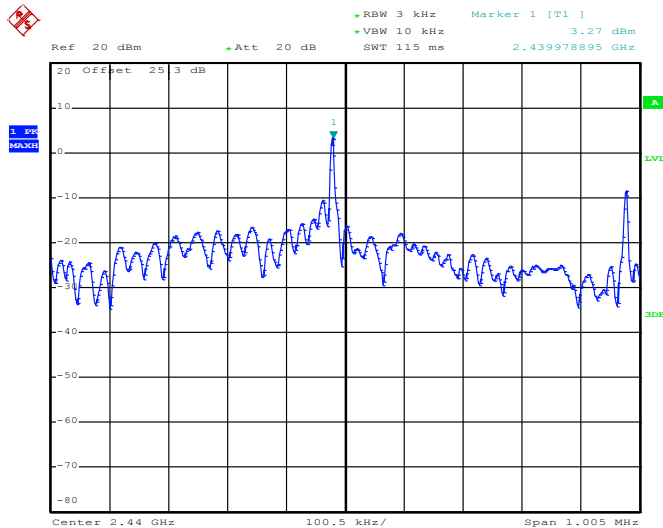

Date: 31.AUG.2015 10:29:00



PSD 3kHz Plot on Channel 39

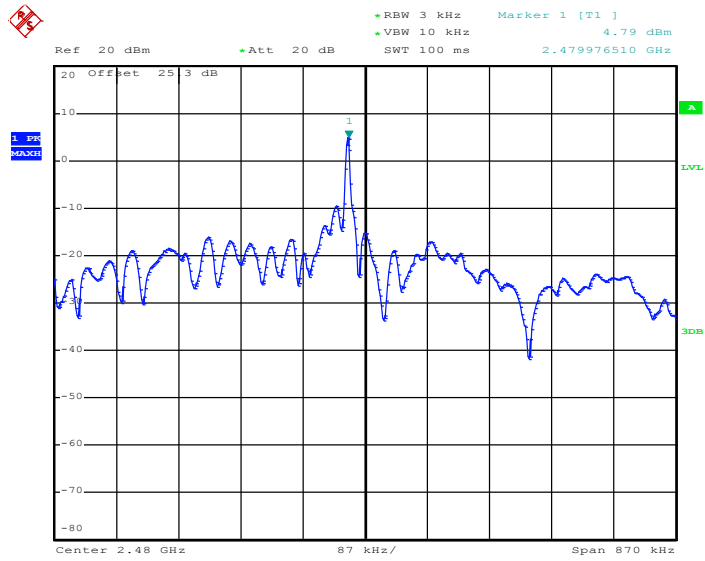

Date: 31.AUG.2015 10:44:36



<Ant. 2>

PSD 3kHz Plot on Channel 00

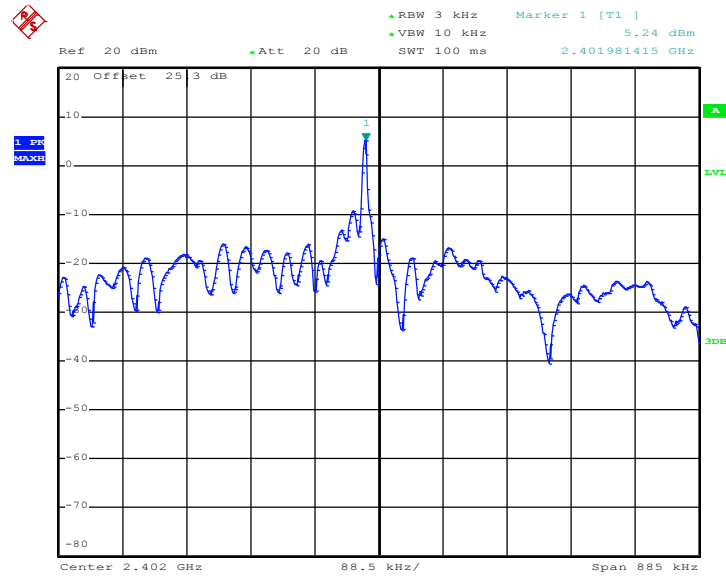

Date: 1.SEP.2015 09:43:27

PSD 3kHz Plot on Channel 19

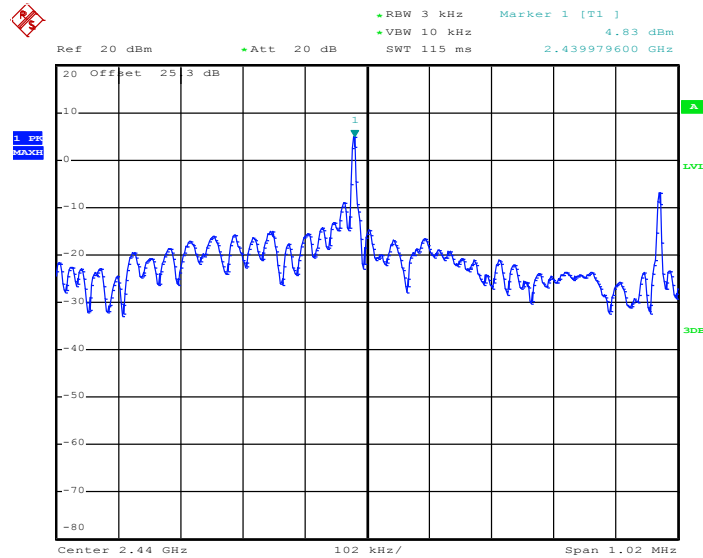

Date: 1.SEP.2015 09:59:13



PSD 3kHz Plot on Channel 39

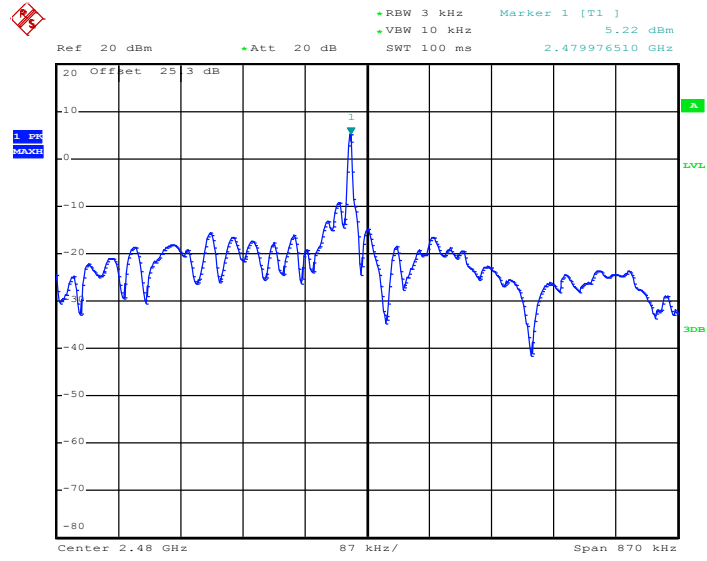

Date: 1.SEP.2015 10:04:13

3.4 Conducted Band Edges and Spurious Emission Measurement

3.4.1 Limit of Conducted Band Edges and Spurious Emission

All harmonics/spurious must be at least 20 dB down from the highest emission level within the authorized band.

3.4.2 Measuring Instruments

The measuring equipment is listed in the section 4 of this test report.

3.4.3 Test Procedure

1. The testing follows FCC KDB Publication No. 558074 D01 DTS Meas. Guidance v03r04.
2. The RF output of EUT was connected to the spectrum analyzer by RF cable and attenuator. The path loss was compensated to the results for each measurement.
3. Set to the maximum power setting and enable the EUT transmit continuously.
4. Set RBW = 100 kHz, VBW=300 kHz, Peak Detector. Unwanted Emissions measured in any 100 kHz bandwidth outside of the authorized frequency band shall be attenuated by at least 20 dB relative to the maximum in-band peak PSD level in 100 kHz when maximum peak conducted output power procedure is used. If the transmitter complies with the conducted power limits based on the use of RMS averaging over a time interval, the attenuation required under this paragraph shall be 30 dB instead of 20 dB per 15.247(d).
5. Measure and record the results in the test report.
6. The RF fundamental frequency should be excluded against the limit line in the operating frequency band.

3.4.4 Test Setup

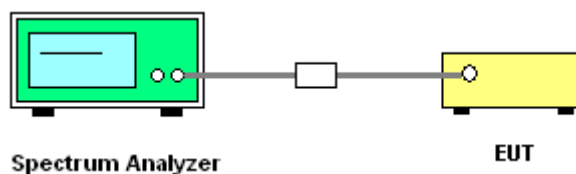



3.4.5 Test Result of Conducted Band Edges Plots

<Ant. 1>

Low Band Edge Plot on Channel 00

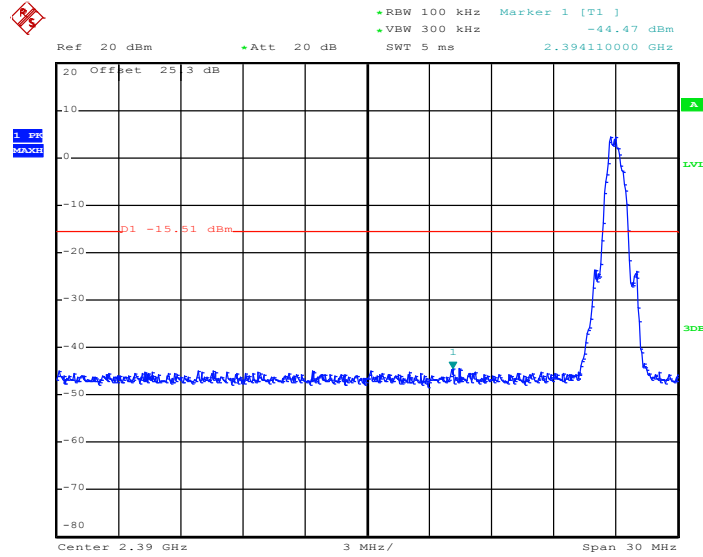

Date: 31.AUG.2015 10:22:56

High Band Edge Plot on Channel 39

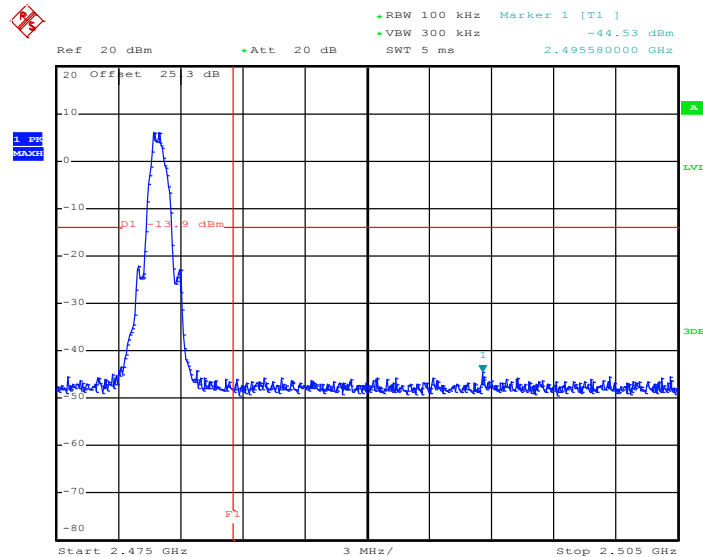

Date: 31.AUG.2015 10:50:38



<Ant. 2>

Low Band Edge Plot on Channel 00

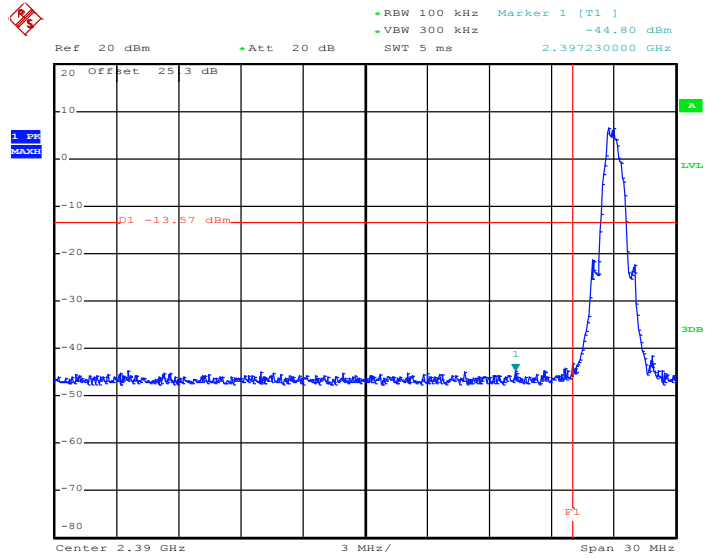

Date: 1.SEP.2015 09:48:59

High Band Edge Plot on Channel 39

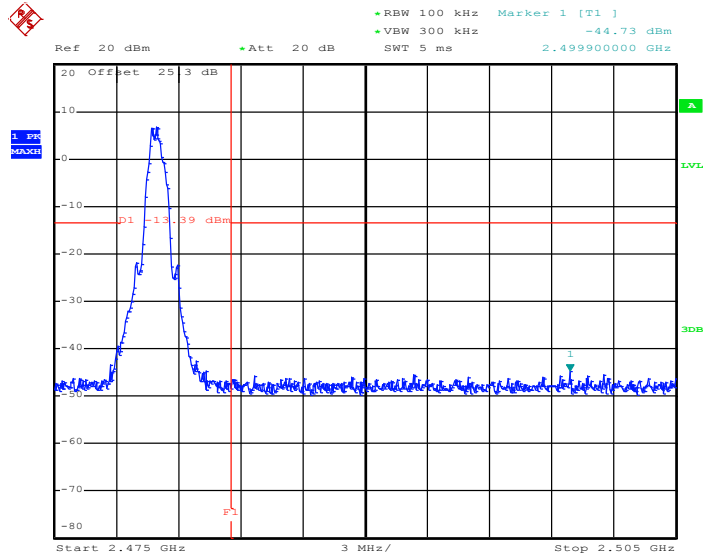

Date: 1.SEP.2015 10:05:14



3.4.6 Test Result of Conducted Spurious Emission Plots

<Ant. 1>

Conducted Spurious Emission Plot on Bluetooth LE 1Mbps GFSK Channel 00

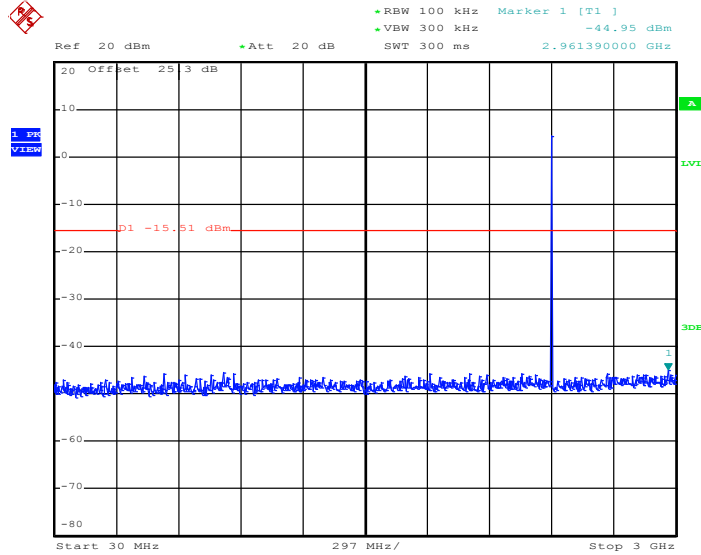

Date: 31.AUG.2015 10:24:24

Conducted Spurious Emission Plot on Bluetooth LE 1Mbps GFSK Channel 00

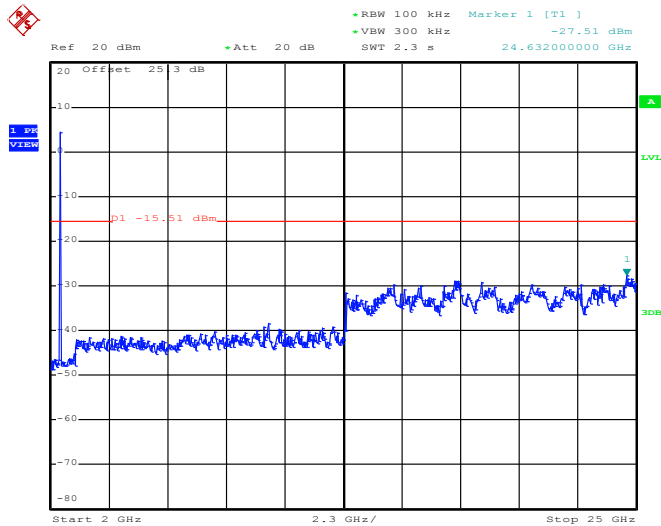

Date: 31.AUG.2015 10:24:32



Conducted Spurious Emission Plot on Bluetooth LE 1Mbps GFSK Channel 19

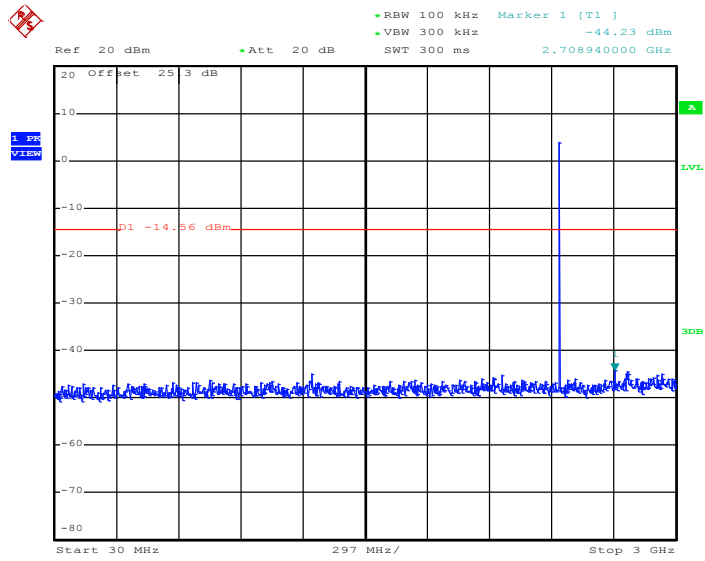

Date: 31.AUG.2015 10:55:09

Conducted Spurious Emission Plot on Bluetooth LE 1Mbps GFSK Channel 19

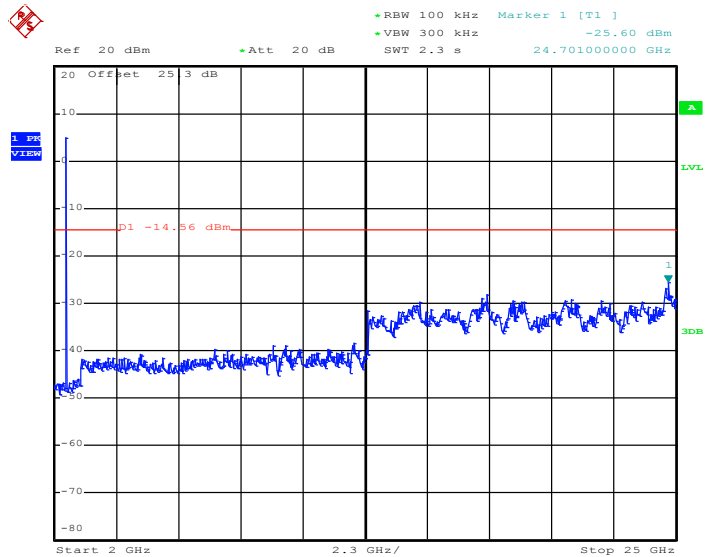

Date: 31.AUG.2015 10:55:17



Conducted Spurious Emission Plot on Bluetooth LE 1Mbps GFSK Channel 39

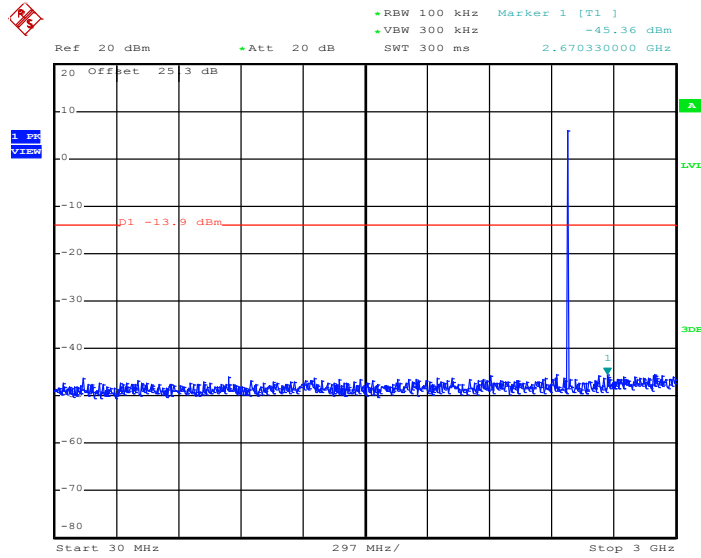

Date: 31.AUG.2015 10:50:58

Conducted Spurious Emission Plot on Bluetooth LE 1Mbps GFSK Channel 39

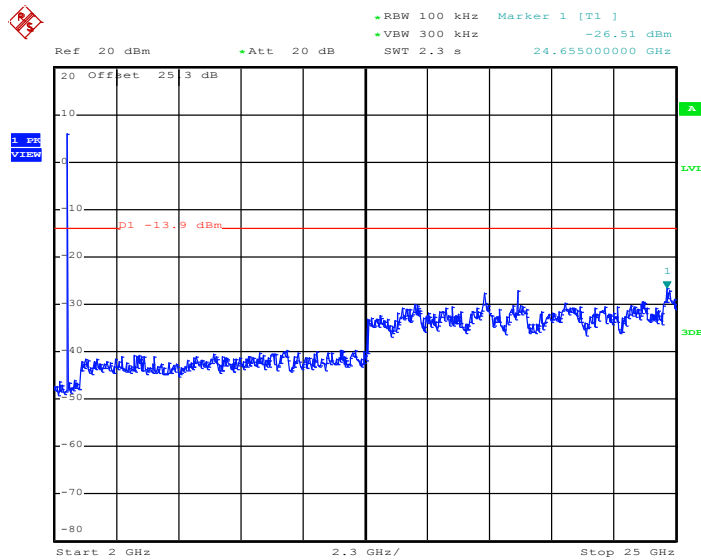

Date: 31.AUG.2015 10:51:06



<Ant. 2>

Conducted Spurious Emission Plot on Bluetooth LE 1Mbps
GFSK Channel 00

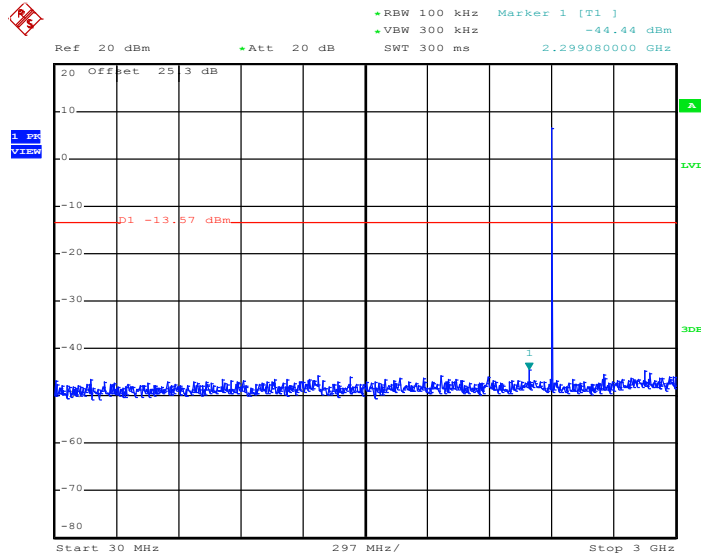

Date: 1.SEP.2015 09:50:23

Conducted Spurious Emission Plot on Bluetooth LE 1Mbps
GFSK Channel 00

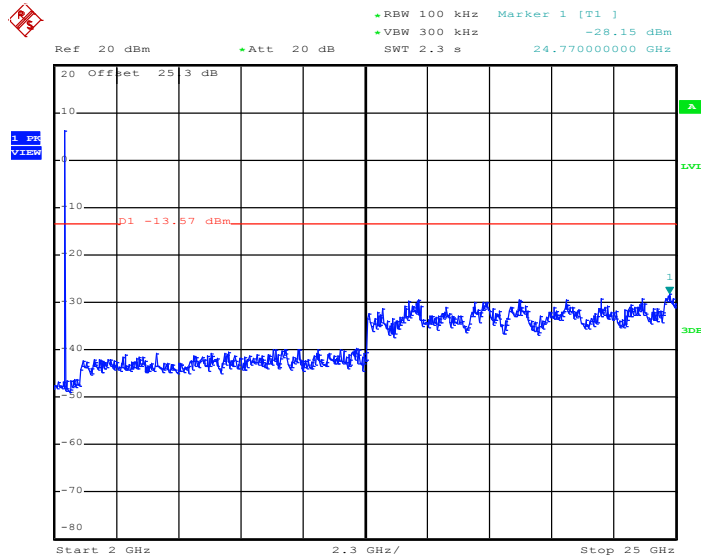

Date: 1.SEP.2015 09:50:31



Conducted Spurious Emission Plot on Bluetooth LE 1Mbps GFSK Channel 19

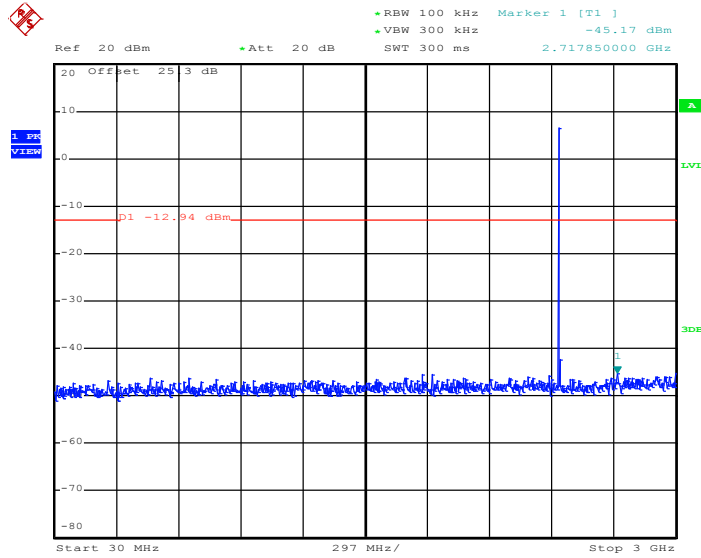

Date: 1.SEP.2015 10:00:03

Conducted Spurious Emission Plot on Bluetooth LE 1Mbps GFSK Channel 19

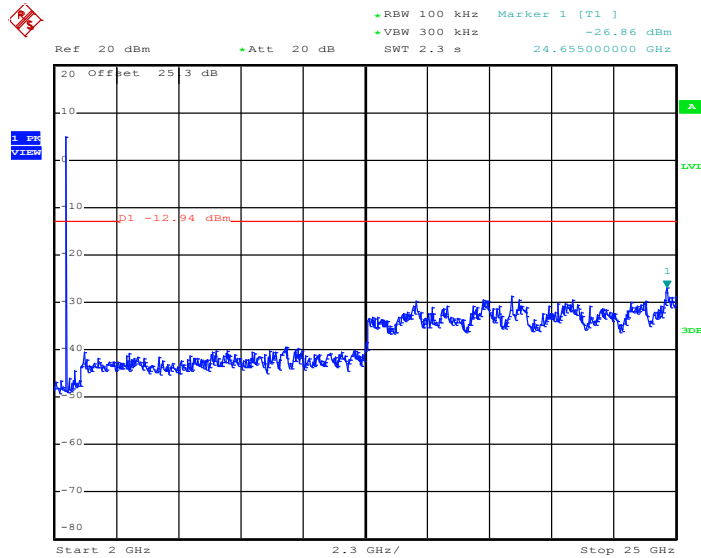

Date: 1.SEP.2015 10:00:12



Conducted Spurious Emission Plot on Bluetooth LE 1Mbps GFSK Channel 39

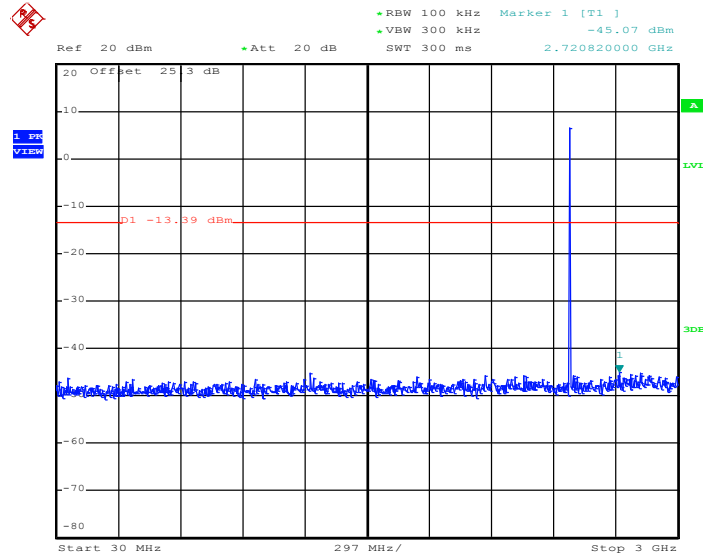

Date: 1.SEP.2015 10:05:28

Conducted Spurious Emission Plot on Bluetooth LE 1Mbps GFSK Channel 39

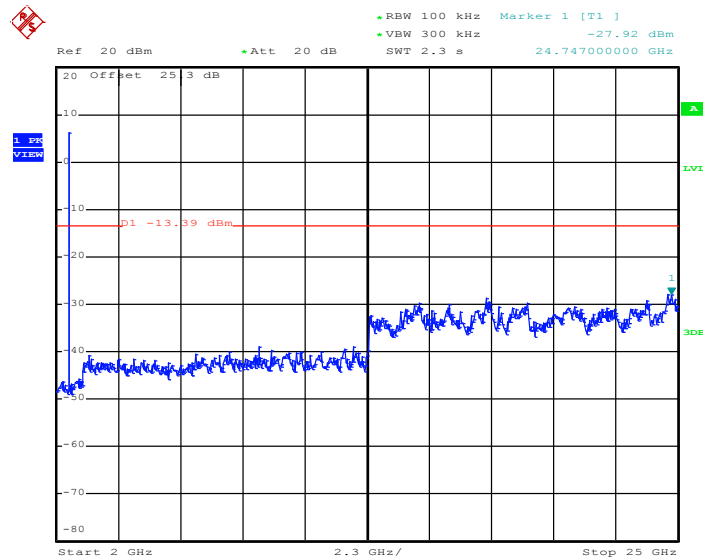

Date: 1.SEP.2015 10:05:36



3.5 Radiated Band Edges and Spurious Emission Measurement

3.5.1 Limit of Radiated Band Edges and Spurious Emission

In any 100 kHz bandwidth outside the intentional radiator frequency band, all harmonics/spurious must be at least 20 dB below the highest emission level within the authorized band. If the output power of this device was measured by spectrum analyzer, the attenuation under this paragraph shall be 30 dB instead of 20 dB. In addition, radiated emissions which fall in the restricted bands must also comply with the FCC section 15.209 limits as below.

Frequency (MHz)	Field Strength (microvolts/meter)	Measurement Distance (meters)
0.009 – 0.490	2400/F(kHz)	300
0.490 – 1.705	24000/F(kHz)	30
1.705 – 30.0	30	30
30 – 88	100	3
88 – 216	150	3
216 - 960	200	3
Above 960	500	3

3.5.2 Measuring Instruments

The measuring equipment is listed in the section 4 of this test report.



3.5.3 Test Procedures

1. The testing follows FCC KDB Publication No. 558074 D01 DTS Meas. Guidance v03r04.
2. The EUT was arranged to its worst case and then tune the antenna tower (from 1 m to 4 m) and turntable (from 0 degree to 360 degrees) to find the maximum reading. A pre-amp and a high pass filter are used for the test in order to get better signal level.
3. The EUT was placed on a turntable with 0.8 meter for frequency below 1GHz and 1.5 meter for frequency above 1GHz respectively above ground.
4. The EUT was set 3 meters from the interference receiving antenna, which was mounted on the top of a variable height antenna tower.
5. Corrected Reading: Antenna Factor + Cable Loss + Read Level - Preamp Factor = Level
6. For measurement below 1GHz, If the emission level of the EUT measured by the peak detector is 3 dB lower than the applicable limit, the peak emission level will be reported. Otherwise, the emission measurement will be repeated using the quasi-peak detector and reported.
7. Use the following spectrum analyzer settings:
 - (1) Span shall wide enough to fully capture the emission being measured;
 - (2) Set RBW=100 kHz for $f < 1 \text{ GHz}$; $\text{VBW} \geq \text{RBW}$; Sweep = auto; Detector function = peak; Trace = max hold;
 - (3) Set RBW = 1 MHz, VBW= 3MHz for $f \geq 1 \text{ GHz}$ for peak measurement.

For average measurement:

 - $\text{VBW} = 10 \text{ Hz}$, when duty cycle is no less than 98 percent.
 - $\text{VBW} \geq 1/T$, when duty cycle is less than 98 percent where T is the minimum transmission duration over which the transmitter is on and is transmitting at its maximum power control level for the tested mode of operation.

Band	Duty Cycle(%)	T(μs)	1/T(kHz)	VBW Setting
Bluetooth 4.0 – LE for Ant. 1	55.56	350.00	2.86	3kHz
Bluetooth 4.0 – LE for Ant. 2	55.56	350.00	2.86	3kHz

3.5.4 Test Setup

For radiated emissions below 30MHz

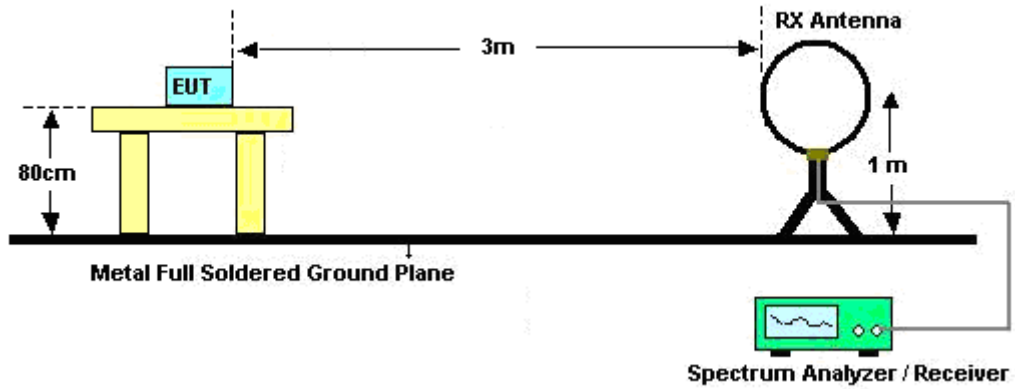

For radiated emissions from 30MHz to 1GHz

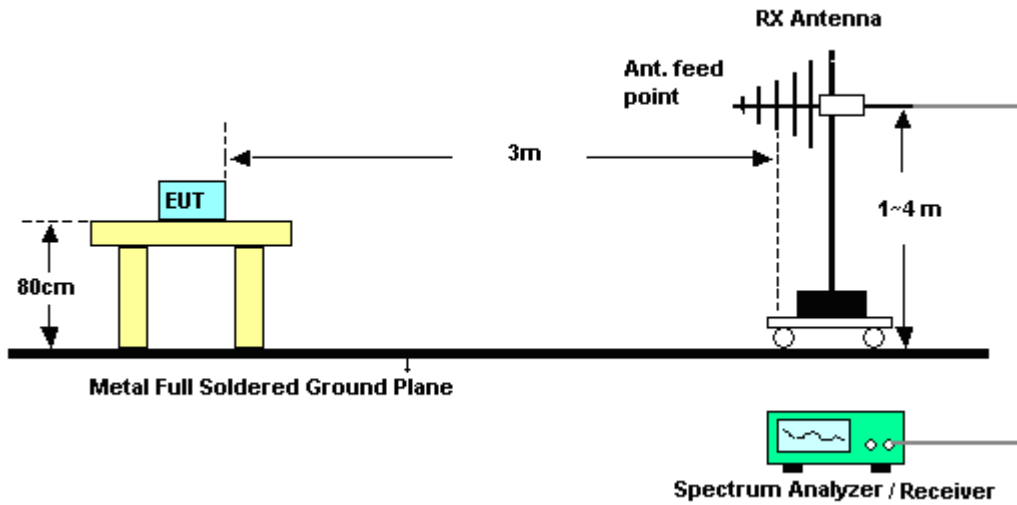

For radiated emissions above 1GHz

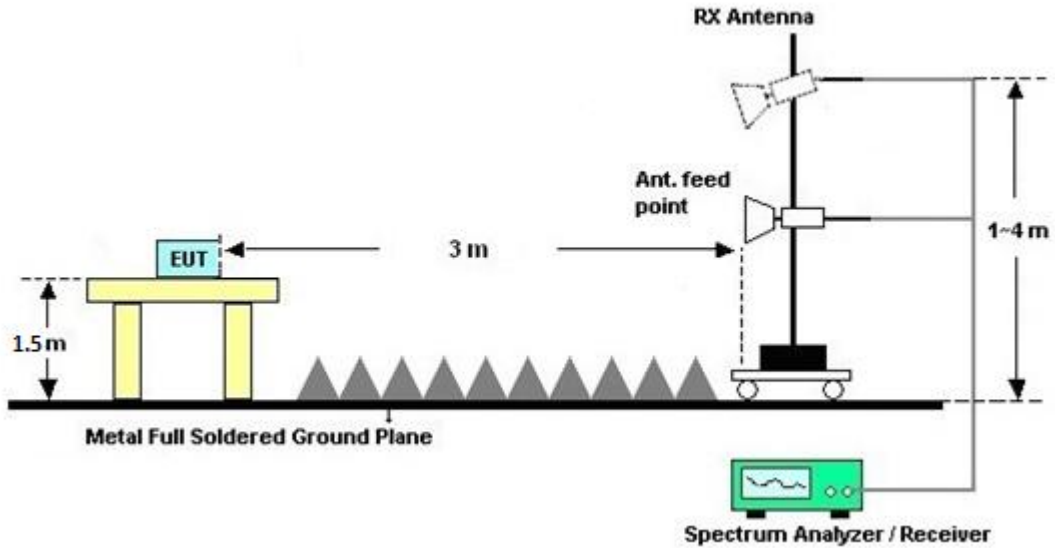

3.5.5 Test Results of Radiated Spurious Emissions (9 kHz ~ 30 MHz)

The low frequency, which started from 9 kHz to 30MHz, was pre-scanned and the result which was 20dB lower than the limit line per 15.31(o) was not reported.

3.5.6 Test Result of Radiated Spurious at Band Edges

Please refer to Appendix B and Appendix C.



3.5.7 Duty Cycle

<Ant. 1>

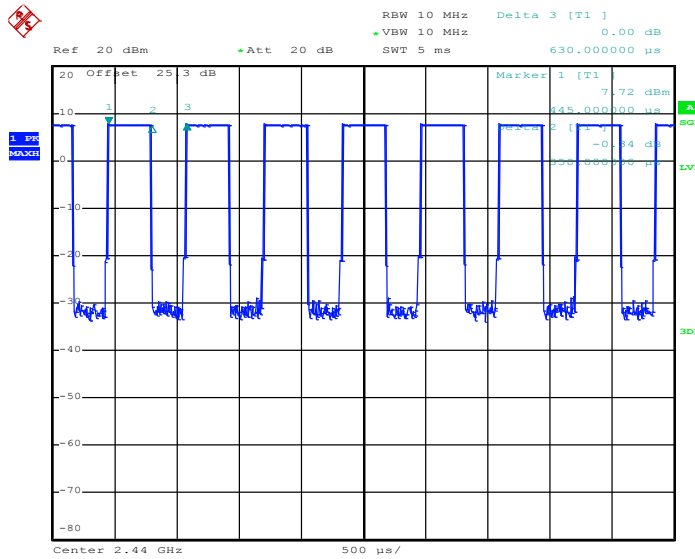

Date: 27.AUG.2015 15:54:18

<Ant. 2>

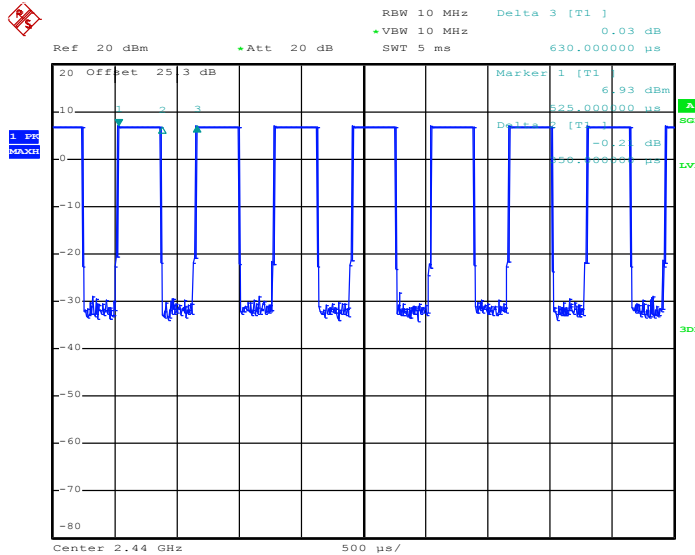

Date: 27.AUG.2015 16:09:49

3.5.8 Test Result of Radiated Spurious Emission (30MHz ~ 10th Harmonic)

Please refer to Appendix B and Appendix C.



3.6 AC Conducted Emission Measurement

3.6.1 Limit of AC Conducted Emission

For equipment that is designed to be connected to the public utility (AC) power line, the radio frequency voltage that is conducted back onto the AC power line on any frequency or frequencies within the band 150 kHz to 30 MHz shall not exceed the limits in the following table.

Frequency of emission (MHz)	Conducted limit (dBµV)	
	Quasi-peak	Average
0.15-0.5	66 to 56*	56 to 46*
0.5-5	56	46
5-30	60	50

*Decreases with the logarithm of the frequency.

3.6.2 Measuring Instruments

The measuring equipment is listed in the section 4 of this test report.

3.6.3 Test Procedures

1. The EUT was placed 0.4 meter from the conducting wall of the shielding room was kept at least 80 centimeters from any other grounded conducting surface.
2. Connect EUT to the power mains through a line impedance stabilization network (LISN).
3. All the support units are connecting to the other LISN.
4. The LISN provides 50 ohm coupling impedance for the measuring instrument.
5. The FCC states that a 50 ohm, 50 microhenry LISN should be used.
6. Both sides of AC line were checked for maximum conducted interference.
7. The frequency range from 150 kHz to 30 MHz was searched.
8. Set the test-receiver system to Peak Detect Function and specified bandwidth (IF Bandwidth = 9kHz) with Maximum Hold Mode. Then measurement is also conducted by Average Detector and Quasi-Peak Detector Function respectively.

3.6.4 Test Setup

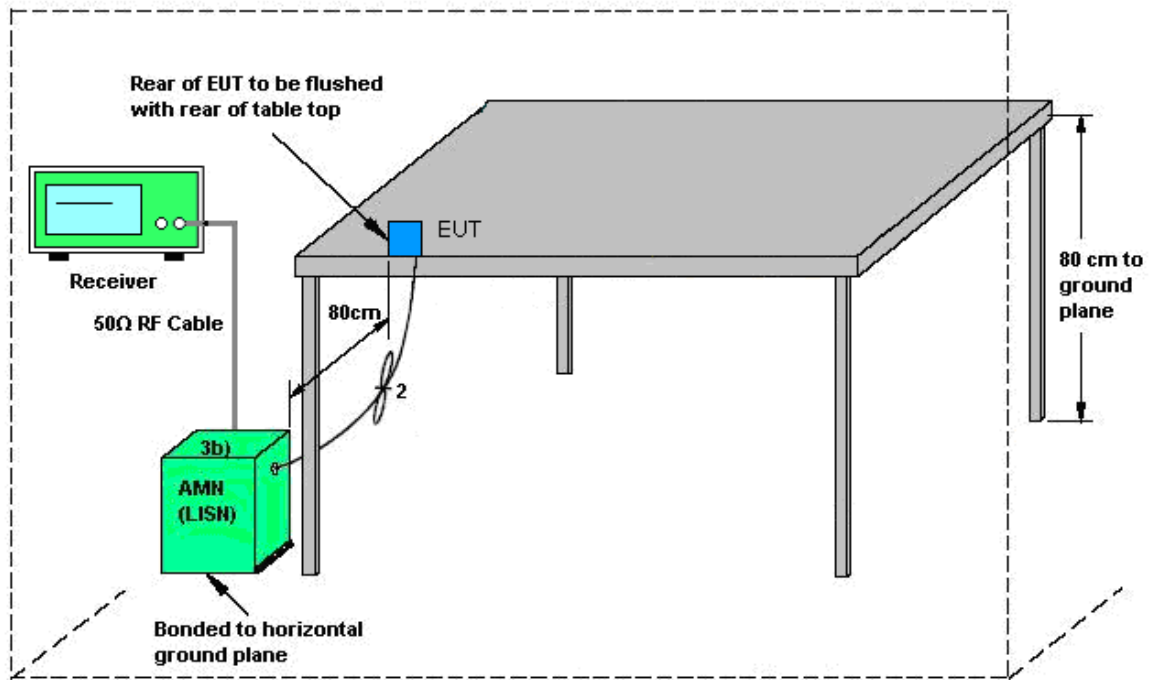

AMN = Artificial mains network (LISN)
AE = Associated equipment
EUT = Equipment under test
ISN = Impedance stabilization network



3.6.5 Test Result of AC Conducted Emission

Test Mode :	Mode 1	Temperature :	24~26°C
Test Engineer :	Derreck Chen	Relative Humidity :	49~53%
Test Voltage :	120Vac / 60Hz	Phase :	Line
Function Type :	WLAN Link + Bluetooth Link		

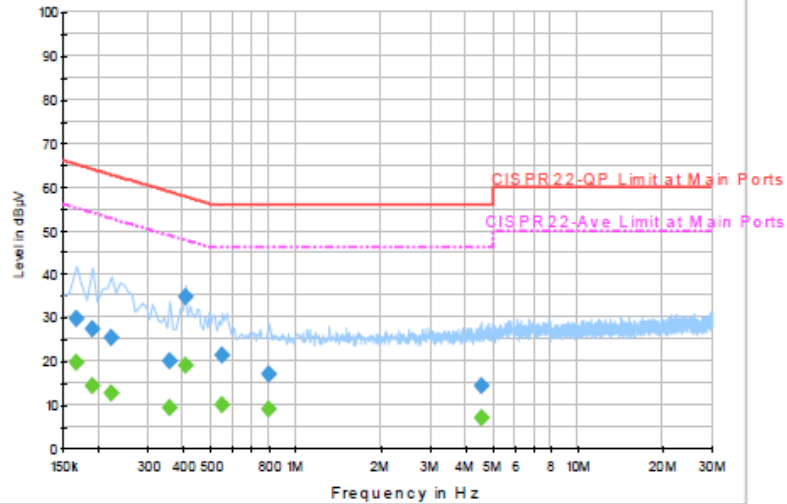

Final Result : Quasi-Peak

Frequency (MHz)	Quasi-Peak (dBµV)	Filter	Line	Corr. (dB)	Margin (dB)	Limit (dBµV)
0.166000	29.6	Off	L1	19.5	35.6	65.2
0.190000	27.4	Off	L1	19.5	36.6	64.0
0.222000	25.4	Off	L1	19.4	37.3	62.7
0.358000	20.2	Off	L1	19.5	38.6	58.8
0.406000	34.9	Off	L1	19.5	22.8	57.7
0.550000	21.3	Off	L1	19.5	34.7	56.0
0.806000	17.0	Off	L1	19.6	39.0	56.0
4.574000	14.5	Off	L1	19.7	41.5	56.0

Final Result : Average

Frequency (MHz)	Average (dBµV)	Filter	Line	Corr. (dB)	Margin (dB)	Limit (dBµV)
0.166000	19.6	Off	L1	19.5	35.6	55.2
0.190000	14.5	Off	L1	19.5	39.5	54.0
0.222000	12.6	Off	L1	19.4	40.1	52.7
0.358000	9.5	Off	L1	19.5	39.3	48.8
0.406000	18.9	Off	L1	19.5	28.8	47.7
0.550000	10.0	Off	L1	19.5	36.0	46.0
0.806000	9.1	Off	L1	19.6	36.9	46.0
4.574000	7.1	Off	L1	19.7	38.9	46.0



Test Mode :	Mode 1	Temperature :	24~26°C
Test Engineer :	Derreck Chen	Relative Humidity :	49~53%
Test Voltage :	120Vac / 60Hz	Phase :	Neutral
Function Type :	WLAN Link + Bluetooth Link		

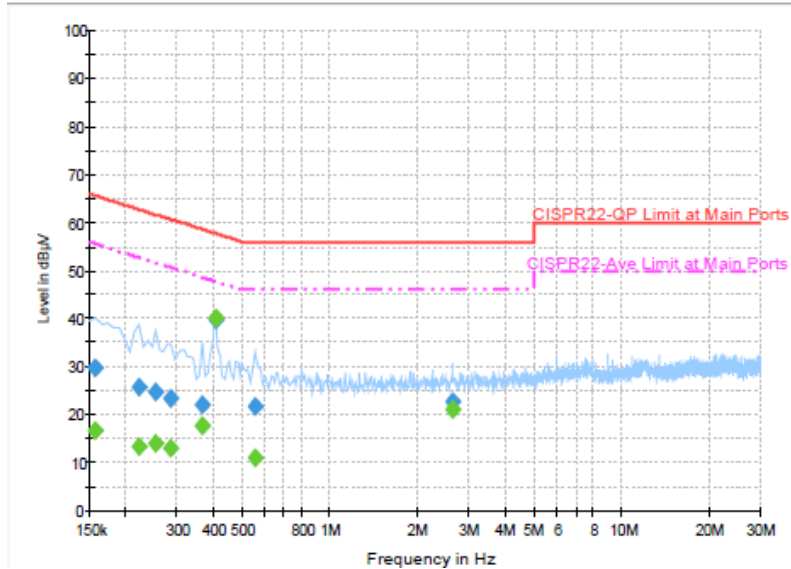

Final Result : Quasi-Peak

Frequency (MHz)	Quasi-Peak (dBµV)	Filter	Line	Corr. (dB)	Margin (dB)	Limit (dBµV)
0.158000	29.7	Off	N	19.5	35.9	65.6
0.222000	25.7	Off	N	19.4	37.0	62.7
0.254000	24.8	Off	N	19.6	36.8	61.6
0.286000	23.5	Off	N	19.5	37.1	60.6
0.366000	22.0	Off	N	19.5	36.6	58.6
0.406000	39.8	Off	N	19.5	17.9	57.7
0.558000	21.8	Off	N	19.5	34.2	56.0
2.646000	22.7	Off	N	19.6	33.3	56.0

Final Result : Average

Frequency (MHz)	Average (dBµV)	Filter	Line	Corr. (dB)	Margin (dB)	Limit (dBµV)
0.158000	16.7	Off	N	19.5	38.9	55.6
0.222000	13.4	Off	N	19.4	39.3	52.7
0.254000	14.0	Off	N	19.6	37.6	51.6
0.286000	13.1	Off	N	19.5	37.5	50.6
0.366000	17.7	Off	N	19.5	30.9	48.6
0.406000	40.3	Off	N	19.5	7.4	47.7
0.558000	11.0	Off	N	19.5	35.0	46.0
2.646000	21.1	Off	N	19.6	24.9	46.0



3.7 Antenna Requirements

3.7.1 Standard Applicable

If directional gain of transmitting antennas is greater than 6dBi, the power shall be reduced by the same level in dB comparing to gain minus 6dBi. The use of a permanently attached antenna or of an antenna that uses a unique coupling to the intentional radiator shall be considered sufficient to comply with the FCC rule.

3.7.2 Antenna Anti-Replacement Construction

An embedded-in antenna design is used.

3.7.3 Antenna Gain

The antenna peak gain of EUT is less than 6 dBi. Therefore, it is not necessary to reduce maximum peak output power limit.



4 List of Measuring Equipment

Instrument	Manufacturer	Model No.	Serial No.	Characteristics	Calibration Date	Test Date	Due Date	Remark
Power Meter	Agilent	E4416A	GB41292344	300MHz~40GHz	Jan. 14, 2015	Aug. 27, 2015 ~ Sep. 01, 2015	Jan. 13, 2016	Conducted (TH05-HY)
Power Sensor	Agilent	E9327A	US40441548	300MHz~40GHz	Jan. 14, 2015	Aug. 27, 2015 ~ Sep. 01, 2015	Jan. 13, 2016	Conducted (TH05-HY)
Spectrum Analyzer	Rohde & Schwarz	FSP40	100055	9kHz~40GHz	Jun. 18, 2015	Aug. 27, 2015 ~ Sep. 01, 2015	Jun. 17, 2016	Conducted (TH05-HY)
Bilog Antenna	Schaffner	CBL6111C	2726	30MHz ~ 1GHz	Sep. 27, 2014	Aug. 19, 2015 ~ Sep. 01, 2015	Sep. 26, 2015	Radiation (03CH07-HY)
Double Ridge Horn Antenna	EMCO	3117	00066583	1GHz~18GHz	Jul. 20, 2015	Aug. 19, 2015 ~ Sep. 01, 2015	Jul. 19, 2016	Radiation (03CH07-HY)
EMI Test Receiver	Rohde & Schwarz	ESCI 7	100724	9kHz~7GHz	Aug. 30, 2014	Aug. 19, 2015 ~ Aug. 23, 2015	Aug. 29, 2015	Radiation (03CH07-HY)
EMI Test Receiver	Rohde & Schwarz	ESCI 7	100724	9kHz~7GHz	Aug. 26, 2015	Aug. 26, 2015 ~ Sep. 01, 2015	Aug. 25, 2016	Radiation (03CH07-HY)
Horn Antenna	SCHWARZBECK	BBHA 9170	BBHA9170584	18GHz- 40GHz	Nov. 03, 2014	Aug. 19, 2015 ~ Sep. 01, 2015	Nov. 02, 2015	Radiation (03CH07-HY)
Loop Antenna	TESEQ	HLA6120	31244	9 kHz~30 MHz	Feb. 02 ,2015	Aug. 19, 2015 ~ Sep. 01, 2015	Feb. 01, 2016	Radiation (03CH07-HY)
Hygrometer	Testo	608-H1	34897197	N/A	May 04, 2015	Aug. 19, 2015 ~ Sep. 01, 2015	May 03, 2016	Radiation (03CH07-HY)
Preamplifier	MITEQ	AMF-7D-0010 1800-30-10P	1590075	1GHz ~ 18GHz	Apr. 20, 2015	Aug. 19, 2015 ~ Sep. 01, 2015	Apr. 19, 2016	Radiation (03CH07-HY)
Preamplifier	COM-POWER	PA-103A	161241	10MHz~1000MHz	Mar. 12, 2015	Aug. 19, 2015 ~ Sep. 01, 2015	Mar. 11, 2016	Radiation (03CH07-HY)
Preamplifier	Agilent	8449B	3008A02362	1GHz~ 26.5GHz	Oct. 21, 2014	Aug. 19, 2015 ~ Sep. 01, 2015	Oct. 20, 2015	Radiation (03CH07-HY)
Signal Analyzer	Rohde & Schwarz	FSV 30	101749	10Hz~30GHz	Mar. 10, 2015	Aug. 19, 2015 ~ Sep. 01, 2015	Mar. 09, 2016	Radiation (03CH07-HY)
Antenna Mast	Max-Full	MFA520BS	N/A	1m~4m	N/A	Aug. 19, 2015 ~ Sep. 01, 2015	N/A	Radiation (03CH07-HY)
Turn Table	ChainTek	Chaintek 3000	N/A	0~360 degree	N/A	Aug. 19, 2015 ~ Sep. 01, 2015	N/A	Radiation (03CH07-HY)
Preamplifier	MITEQ	JS44-180040 00-33-8P	1840917	18GHz ~ 40GHz	Jun. 02, 2015	Aug. 19, 2015 ~ Sep. 01, 2015	Jun. 01, 2016	Radiation (03CH07-HY)
EMI Test Receiver	Rohde & Schwarz	ESCS 30	100356	9kHz ~ 2.75GHz	Dec. 01, 2014	Sep. 15, 2015	Nov. 30, 2015	Conduction (CO05-HY)
LISN	Rohde & Schwarz	ENV216	100080	9kHz~30MHz	Dec. 02, 2014	Sep. 15, 2015	Dec. 01, 2015	Conduction (CO05-HY)
AC Power Source	ChainTek	APC-1000W	N/A	N/A	N/A	Sep. 15, 2015	N/A	Conduction (CO05-HY)
LISN	Rohde & Schwarz	ENV216	100080	9kHz~30MHz	Dec. 02, 2014	Sep. 15, 2015	Dec. 01, 2015	Conduction (CO05-HY)
AC Power Source	ChainTek	APC-1000W	N/A	N/A	N/A	Sep. 15, 2015	N/A	Conduction (CO05-HY)



5 Uncertainty of Evaluation

Uncertainty of Conducted Emission Measurement (150 kHz ~ 30 MHz)

Measuring Uncertainty for a Level of Confidence of 95% ($U = 2Uc(y)$)	2.26
-------------------------------------------------------------------------	------

Uncertainty of Radiated Emission Measurement (30 MHz ~ 1000 MHz)

Measuring Uncertainty for a Level of Confidence of 95% ($U = 2Uc(y)$)	4.8
-------------------------------------------------------------------------	-----

Appendix A. Conducted Test Results - Bluetooth Low Energy (Ant. 1)

Test Engineer:	Tommy Lee	Temperature:	21~25	°C
Test Date:	2015/08/27 ~ 2015/09/01	Relative Humidity:	51~54	%

TEST RESULTS DATA **6dB Occupied Bandwidth**

Mod.	Data Rate	N _{TX}	CH.	Freq. (MHz)	6dB BW (MHz)	6dB BW Limit (MHz)	Pass/Fail
BLE	1Mbps	1	0	2402	0.59	0.50	Pass
BLE	1Mbps	1	19	2440	0.67	0.50	Pass
BLE	1Mbps	1	39	2480	0.58	0.50	Pass

TEST RESULTS DATA **Peak Power Table**

Mod.	Data Rate	N _{TX}	CH.	Freq. (MHz)	Peak Conducted Power (dBm)	Conducted Power Limit (dBm)	DG (dBi)	EIRP Power (dBm)	EIRP Power Limit (dBm)	Pass /Fail
BLE	1Mbps	1	0	2402	8.35	30.00	3.58	11.93	36.00	Pass
BLE	1Mbps	1	19	2440	8.59	30.00	2.87	11.46	36.00	Pass
BLE	1Mbps	1	39	2480	8.39	30.00	3.06	11.45	36.00	Pass

TEST RESULTS DATA **Average Power Table** **(Reporting Only)**

Mod.	Data Rate	N _{TX}	CH.	Freq. (MHz)	Duty Factor (dB)	Average Conducted Power (dBm)
BLE	1Mbps	1	0	2402	2.55	7.73
BLE	1Mbps	1	19	2440	2.55	7.87
BLE	1Mbps	1	39	2480	2.55	7.72

TEST RESULTS DATA **Peak Power Density**

Mod.	Data Rate	N _{TX}	CH.	Freq. (MHz)	Peak PSD (dBm /100kHz)	Peak PSD (dBm /3kHz)	DG (dBi)	Peak PSD Limit (dBm /3kHz)	Pass/Fail
BLE	1Mbps	1	0	2402	4.49	3.29	3.58	8.00	Pass
BLE	1Mbps	1	19	2440	5.44	3.27	2.87	8.00	Pass
BLE	1Mbps	1	39	2480	6.10	4.79	3.06	8.00	Pass

Note: PSD (dBm/ 100kHz) is a reference level used for Conducted Band Edges and Conducted Spurious Emission 20dBc limit.

(Ant. 2)

Test Engineer:	Tommy Lee	Temperature:	21~25	°C
Test Date:	2015/08/27 ~ 2015/09/01	Relative Humidity:	51~54	%

TEST RESULTS DATA
6dB Occupied Bandwidth

Mod.	Data Rate	NTX	CH.	Freq. (MHz)	6dB BW (MHz)	6dB BW Limit (MHz)	Pass/Fail	
BLE	1Mbps	1	0	2402		0.59	0.50	Pass
BLE	1Mbps	1	19	2440		0.68	0.50	Pass
BLE	1Mbps	1	39	2480		0.58	0.50	Pass

TEST RESULTS DATA
Peak Power Table

Mod.	Data Rate	NTX	CH.	Freq. (MHz)	Peak Conducted Power (dBm)	Conducted Power Limit (dBm)	DG (dBi)	EIRP Power (dBm)	EIRP Power Limit (dBm)	Pass /Fail
BLE	1Mbps	1	0	2402	7.53	30.00	2.00	9.53	36.00	Pass
BLE	1Mbps	1	19	2440	7.82	30.00	1.47	9.29	36.00	Pass
BLE	1Mbps	1	39	2480	7.49	30.00	1.24	8.73	36.00	Pass

TEST RESULTS DATA
Average Power Table
(Reporting Only)

Mod.	Data Rate	NTX	CH.	Freq. (MHz)	Duty Factor (dB)	Average Conducted Power (dBm)
BLE	1Mbps	1	0	2402	2.55	6.88
BLE	1Mbps	1	19	2440	2.55	7.09
BLE	1Mbps	1	39	2480	2.55	6.77

TEST RESULTS DATA
Peak Power Density

Mod.	Data Rate	NTX	CH.	Freq. (MHz)	Peak PSD (dBm /100kHz)	Peak PSD (dBm /3kHz)	DG (dBi)	Peak PSD Limit (dBm /3kHz)	Pass/Fail
BLE	1Mbps	1	0	2402	6.43	5.24	2.00	8.00	Pass
BLE	1Mbps	1	19	2440	7.06	4.83	1.47	8.00	Pass
BLE	1Mbps	1	39	2480	6.61	5.22	1.24	8.00	Pass

Note: PSD (dBm/ 100kHz) is a reference level used for Conducted Band Edges and Conducted Spurious Emission 20dBc limit.



Appendix B. Radiated Spurious Emission

Test Engineer :	Wei Chen, Ken Wu, and James Chiu	Temperature :	21~23°C
		Relative Humidity :	60~63%

2.4GHz 2400~2483.5MHz

BLE (Band Edge @ 3m)

BLE	Note	Frequency	Level	Over	Limit	Read	Antenna	Cable	Preamp	Ant	Table	Peak	Pol.	
Ant.				Limit	Line	Level	Factor	Loss	Factor	Pos	Pos	Avg.		
1		(MHz)	(dBμV/m)	(dB)	(dBμV/m)	(dBμV)	(dB/m)	(dB)	(dB)	(cm)	(deg)	(P/A)	(H/V)	
BLE CH 00 2402MHz		2332.05	46.6	-27.4	74	41.13	32.09	7.6	34.22	244	248	P	H	
		2317.2	34.91	-19.09	54	29.46	32.07	7.6	34.22	244	248	A	H	
	*	2402.254	97.8	-	-	92.17	32.18	7.75	34.3	244	248	P	H	
	*	2401.92	97.09	-	-	91.46	32.18	7.75	34.3	244	248	A	H	
													H	
													H	
			2323.95	47.3	-26.7	74	41.83	32.09	7.6	34.22	119	0	P	V
			2343.03	35.06	-18.94	54	29.52	32.11	7.68	34.25	119	0	A	V
	*		2402.254	105.2	-	-	99.57	32.18	7.75	34.3	119	0	P	V
	*		2401.92	104.46	-	-	98.83	32.18	7.75	34.3	119	0	A	V
													V	
													V	
BLE CH 19 2440MHz		2330.52	47.29	-26.71	74	41.82	32.09	7.6	34.22	216	308	P	H	
		2378.4	35.02	-18.98	54	29.45	32.16	7.68	34.27	216	308	A	H	
	*	2440.08	96.58	-	-	90.86	32.24	7.83	34.35	216	308	P	H	
	*	2439.997	95.88	-	-	90.16	32.24	7.83	34.35	216	308	A	H	
			2495.64	47.34	-26.66	74	41.61	32.3	7.91	34.48	216	308	P	H
			2483.84	35.02	-18.98	54	29.26	32.28	7.91	34.43	216	308	A	H
			2390.01	50.86	-23.14	74	45.23	32.18	7.75	34.3	200	19	P	V
			2389.74	35.29	-18.71	54	29.63	32.18	7.75	34.27	200	19	A	V
	*		2440.08	104.46	-	-	98.74	32.24	7.83	34.35	200	19	P	V
	*		2439.997	103.8	-	-	98.08	32.24	7.83	34.35	200	19	A	V
			2483.84	47.26	-26.74	74	41.5	32.28	7.91	34.43	200	19	P	V
			2491.88	35.95	-18.05	54	30.22	32.3	7.91	34.48	200	19	A	V



BLE CH 39 2480MHz	*	2480.076	95.31	-	-	89.55	32.28	7.91	34.43	200	307	P	H
	*	2479.993	94.48	-	-	88.72	32.28	7.91	34.43	200	307	A	H
		2484.04	50.96	-23.04	74	45.2	32.28	7.91	34.43	200	307	P	H
		2483.76	35.5	-18.5	54	29.74	32.28	7.91	34.43	200	307	A	H
													H
													H
	*	2480.076	105.81	-	-	100.05	32.28	7.91	34.43	200	4	P	V
	*	2479.993	104.99	-	-	99.23	32.28	7.91	34.43	200	4	A	V
		2483.6	60.33	-13.67	74	54.57	32.28	7.91	34.43	200	4	P	V
		2483.52	40.3	-13.7	54	34.54	32.28	7.91	34.43	200	4	A	V
													V
													V
Remark	1. No other spurious found. 2. All results are PASS against Peak and Average limit line.												



2.4GHz 2400~2483.5MHz

BLE (Harmonic @ 3m)

BLE	Note	Frequency	Level	Over	Limit	Read	Antenna	Cable	Preamp	Ant	Table	Peak	Pol.
Ant.				Limit	Line	Level	Factor	Loss	Factor	Pos	Pos	Avg.	
1		(MHz)	(dBμV/m)	(dB)	(dBμV/m)	(dBμV)	(dB/m)	(dB)	(dB)	(cm)	(deg)	(P/A)	(H/V)
BLE CH 00 2402MHz		4804	49.24	-24.76	74	63.55	34.25	11.11	59.67	100	0	P	H
													H
													H
													H
		4804	44.72	-29.28	74	59.03	34.25	11.11	59.67	100	0	P	V
													V
													V
													V
BLE CH 19 2440MHz		4880	51.5	-22.5	74	65.56	34.3	11.21	59.57	200	232	P	H
		4880	48.99	-5.01	54	63.05	34.3	11.21	59.57	200	232	A	H
		7440	42.82	-31.18	74	50.73	35.6	15.13	58.64	100	0	P	H
													H
		4880	44.91	-29.09	74	58.97	34.3	11.21	59.57	100	0	P	V
		7440	41.65	-32.35	74	49.56	35.6	15.13	58.64	100	0	P	V
													V
													V
BLE CH 39 2480MHz		4962	52.98	-21.02	74	66.74	34.37	11.32	59.45	200	238	P	H
		4962	50.85	-3.15	54	64.61	34.37	11.32	59.45	200	238	A	H
		7440	44.16	-29.84	74	52.07	35.6	15.13	58.64	100	0	P	H
													H
		4962	46.3	-27.7	74	60.06	34.37	11.32	59.45	100	0	P	V
		7440	42.38	-31.62	74	50.29	35.6	15.13	58.64	100	0	P	V
													V
													V
Remark	1. No other spurious found. 2. All results are PASS against Peak and Average limit line.												



Emission below 1GHz

2.4GHz BLE (LF)

BLE	Note	Frequency	Level	Over	Limit	Read	Antenna	Cable	Preamp	Ant	Table	Peak	Pol.	
Ant.				Limit	Line	Level	Factor	Loss	Factor	Pos	Pos	Avg.		
1		(MHz)	(dBμV/m)	(dB)	(dBμV/m)	(dBμV)	(dB/m)	(dB)	(dB)	(cm)	(deg)	(P/A)	(H/V)	
2.4GHz BLE LF		107.49	23.59	-19.91	43.5	41.71	10.68	2.38	31.18	-	-	P	H	
		173.1	30.55	-12.95	43.5	49.6	9.38	2.61	31.04	-	-	P	H	
		297.84	38.2	-7.8	46	52.88	13.18	3.16	31.02	100	0	P	H	
		386.1	31.95	-14.05	46	44.06	15.34	3.52	30.97	-	-	P	H	
		671.7	32.09	-13.91	46	37.78	20.42	4.35	30.46	-	-	P	H	
		720	34.25	-11.75	46	38.84	21.4	4.41	30.4	-	-	P	H	
														H
														H
														H
														H
														H
														H
			106.68	31.57	-11.93	43.5	49.74	10.62	2.38	31.17	-	-	P	V
			209.28	28.95	-14.55	43.5	48.17	9.19	2.69	31.1	-	-	P	V
			257.61	33.37	-12.63	46	47.73	13.68	2.96	31	-	-	P	V
			301.4	37.16	-8.84	46	51.66	13.22	3.28	31	-	-	P	V
			624.1	37.55	-8.45	46	43.61	20.27	4.22	30.55	100	0	P	V
			720	37.37	-8.63	46	41.96	21.4	4.41	30.4	-	-	P	V
														V
														V
													V	
													V	
													V	
													V	
Remark	1. No other spurious found. 2. All results are PASS against limit line.													



2.4GHz 2400~2483.5MHz

BLE (Band Edge @ 3m)

BLE	Note	Frequency	Level	Over	Limit	Read	Antenna	Cable	Preamp	Ant	Table	Peak	Pol.	
Ant.				Limit	Line	Level	Factor	Loss	Factor	Pos	Pos	Avg.		
2		(MHz)	(dBμV/m)	(dB)	(dBμV/m)	(dBμV)	(dB/m)	(dB)	(dB)	(cm)	(deg)	(P/A)	(H/V)	
BLE CH 00 2402MHz		2342.67	46.81	-27.19	74	41.27	32.11	7.68	34.25	100	316	P	H	
		2331.6	35.27	-18.73	54	29.8	32.09	7.6	34.22	100	316	A	H	
	*	2402.254	97.05	-	-	91.42	32.18	7.75	34.3	100	316	P	H	
	*	2402.004	96.27	-	-	90.64	32.18	7.75	34.3	100	316	A	H	
													H	
														H
			2389.74	47.02	-26.98	74	41.36	32.18	7.75	34.27	123	290	P	V
			2389.74	35.35	-18.65	54	29.69	32.18	7.75	34.27	123	290	A	V
	*		2402.004	108.19	-	-	102.56	32.18	7.75	34.3	123	290	P	V
	*		2401.92	107.41	-	-	101.78	32.18	7.75	34.3	123	290	A	V
														V
														V
BLE CH 19 2440MHz		2376.6	47.08	-26.92	74	41.51	32.16	7.68	34.27	117	347	P	H	
		2342.22	34.89	-19.11	54	29.35	32.11	7.68	34.25	117	347	A	H	
	*	2440.08	99.21	-	-	93.49	32.24	7.83	34.35	117	347	P	H	
	*	2439.997	98.51	-	-	92.79	32.24	7.83	34.35	117	347	A	H	
			2487.16	47.37	-26.63	74	41.61	32.28	7.91	34.43	117	347	P	H
			2490.04	35.25	-18.75	54	29.47	32.3	7.91	34.43	117	347	A	H
			2389.92	48.23	-25.77	74	42.6	32.18	7.75	34.3	136	293	P	V
			2388.12	34.99	-19.01	54	29.33	32.18	7.75	34.27	136	293	A	V
	*		2439.997	108.26	-	-	102.54	32.24	7.83	34.35	136	293	P	V
	*		2439.997	107.52	-	-	101.8	32.24	7.83	34.35	136	293	A	V
			2495.28	47.91	-26.09	74	42.18	32.3	7.91	34.48	136	293	P	V
			2491.8	36.04	-17.96	54	30.31	32.3	7.91	34.48	136	293	A	V



BLE CH 39 2480MHz	*	2480.16	100.48	-	-	94.72	32.28	7.91	34.43	100	324	P	H
	*	2479.993	99.67	-	-	93.91	32.28	7.91	34.43	100	324	A	H
		2483.56	55.15	-18.85	74	49.39	32.28	7.91	34.43	100	324	P	H
		2483.56	36.63	-17.37	54	30.87	32.28	7.91	34.43	100	324	A	H
													H
													H
	*	2480.076	107.38	-	-	101.62	32.28	7.91	34.43	106	274	P	V
	*	2479.993	106.61	-	-	100.85	32.28	7.91	34.43	106	274	A	V
		2483.76	61.33	-12.67	74	55.57	32.28	7.91	34.43	106	274	P	V
		2483.6	40.94	-13.06	54	35.18	32.28	7.91	34.43	106	274	A	V
													V
													V
BLE CH 39 2480MHz + Base	*	2480.076	99.64	-	-	93.88	32.28	7.91	34.43	152	314	P	H
	*	2479.993	98.93	-	-	93.17	32.28	7.91	34.43	152	314	A	H
		2483.64	59.39	-14.61	74	53.63	32.28	7.91	34.43	152	314	P	H
		2484.08	37.58	-16.42	54	31.82	32.28	7.91	34.43	152	314	A	H
													H
													H
	*	2480.076	101.55	-	-	95.79	32.28	7.91	34.43	126	91	P	V
	*	2479.993	100.85	-	-	95.09	32.28	7.91	34.43	126	91	A	V
		2483.52	61.48	-12.52	74	55.72	32.28	7.91	34.43	126	91	P	V
		2483.64	38.7	-15.3	54	32.94	32.28	7.91	34.43	126	91	A	V
													V
													V
Remark	1. No other spurious found. 2. All results are PASS against Peak and Average limit line.												



15C 2.4GHz 2400~2483.5MHz

BLE (Harmonic @ 3m)

BLE	Note	Frequency	Level	Over	Limit	Read	Antenna	Cable	Preamp	Ant	Table	Peak	Pol.
Ant.				Limit	Line	Level	Factor	Loss	Factor	Pos	Pos	Avg.	
2		(MHz)	(dBµV/m)	(dB)	(dBµV/m)	(dBµV)	(dB/m)	(dB)	(dB)	(cm)	(deg)	(P/A)	(H/V)
BLE CH 00 2402MHz		4804	47.14	-26.86	74	61.45	34.25	11.11	59.67	100	0	P	H
													H
													H
													H
		4804	49.36	-24.64	74	63.67	34.25	11.11	59.67	100	0	P	V
													V
													V
													V
BLE CH 19 2440MHz		4880	49.5	-24.5	74	63.56	34.3	11.21	59.57	100	0	P	H
		7320	43.85	-30.15	74	51.66	35.6	15.08	58.49	100	0	P	H
													H
													H
		4880	48.97	-25.03	74	63.03	34.3	11.21	59.57	100	0	P	V
		7320	44.39	-29.61	74	52.2	35.6	15.08	58.49	100	0	P	V
													V
													V
BLE CH 39 2480MHz		4960	48.86	-25.14	74	62.62	34.37	11.32	59.45	100	0	P	H
		7440	44.5	-29.5	74	52.41	35.6	15.13	58.64	100	0	P	H
													H
													H
		4960	53.13	-20.87	74	66.89	34.37	11.32	59.45	100	102	P	V
		4960	50.91	-3.09	54	64.67	34.37	11.32	59.45	100	102	A	V
		7440	43.6	-30.4	74	51.51	35.6	15.13	58.64	100	0	P	V
													V



BLE CH 39 2480MHz + Base		4960	55	-19	74	68.76	34.37	11.32	59.45	107	67	P	H
		4960	51.15	-2.85	54	64.91	34.37	11.32	59.45	107	67	A	H
		7440	47.96	-26.04	74	55.87	35.6	15.13	58.64	100	0	P	H
													H
		4960	53.79	-20.21	74	67.55	34.37	11.32	59.45	100	46	P	V
		4960	49.55	-4.45	54	63.31	34.37	11.32	59.45	100	46	A	V
		7440	46.15	-27.85	74	54.06	35.6	15.13	58.64	100	0	P	V
Remark	1. No other spurious found. 2. All results are PASS against Peak and Average limit line.												



Emission below 1GHz

2.4GHz BLE (LF)

BLE	Note	Frequency	Level	Over	Limit	Read	Antenna	Cable	Preamp	Ant	Table	Peak	Pol.	
Ant.				Limit	Line	Level	Factor	Loss	Factor	Pos	Pos	Avg.		
2		(MHz)	(dBμV/m)	(dB)	(dBμV/m)	(dBμV)	(dB/m)	(dB)	(dB)	(cm)	(deg)	(P/A)	(H/V)	
2.4GHz BLE LF		107.49	29.12	-14.38	43.5	47.24	10.68	2.38	31.18	-	-	P	H	
		169.05	32.95	-10.55	43.5	51.73	9.72	2.61	31.11	-	-	P	H	
		294.06	39.62	-6.38	46	54.38	13.14	3.16	31.06	-	-	P	H	
		301.4	39.71	-6.29	46	54.21	13.22	3.28	31	100	0	P	H	
		720	36.36	-9.64	46	40.95	21.4	4.41	30.4	-	-	P	H	
		768.3	34.74	-11.26	46	38.52	22.1	4.48	30.36	-	-	P	H	
														H
														H
														H
														H
														H
														H
			105.33	33.21	-10.29	43.5	51.42	10.56	2.38	31.15	-	-	P	V
			169.05	28.37	-15.13	43.5	47.15	9.72	2.61	31.11	-	-	P	V
			297.84	39.86	-6.14	46	54.54	13.18	3.16	31.02	100	0	P	V
			301.4	39.68	-6.32	46	54.18	13.22	3.28	31	-	-	P	V
			720	39.23	-6.77	46	43.82	21.4	4.41	30.4	-	-	P	V
			768.3	35.37	-10.63	46	39.15	22.1	4.48	30.36	-	-	P	V
														V
														V
													V	
													V	
													V	
													V	
Remark	1. No other spurious found. 2. All results are PASS against limit line.													



Note symbol

*	Fundamental Frequency which can be ignored. However, the level of any unwanted emissions shall not exceed the level of the fundamental frequency per 15.209(c).
!	Test result is over limit line.
P/A	Peak or Average
H/V	Horizontal or Vertical



A calculation example for radiated spurious emission is shown as below:

WIFI	Note	Frequency	Level	Over	Limit	Read	Antenna	Cable	Preamp	Ant	Table	Peak	Pol.
Ant.				Limit	Line	Level	Factor	Loss	Factor	Pos	Pos	Avg.	
1+2		(MHz)	(dBμV/m)	(dB)	(dBμV/m)	(dBμV)	(dB/m)	(dB)	(dB)	(cm)	(deg)	(P/A)	(H/V)
802.11b		2390	55.45	-18.55	74	54.51	32.22	4.58	35.86	103	308	P	H
CH 01													
2412MHz		2390	43.54	-10.46	54	42.6	32.22	4.58	35.86	103	308	A	H

- Level(dBμV/m) =
Antenna Factor(dB/m) + Cable Loss(dB) + Read Level(dBμV) - Preamp Factor(dB)
- Over Limit(dB) = Level(dBμV/m) – Limit Line(dBμV/m)

For Peak Limit @ 2390MHz:

- Level(dBμV/m)
= Antenna Factor(dB/m) + Cable Loss(dB) + Read Level(dBμV) - Preamp Factor(dB)
= 32.22(dB/m) + 4.58(dB) + 54.51(dBμV) – 35.86 (dB)
= 55.45 (dBμV/m)
- Over Limit(dB)
= Level(dBμV/m) – Limit Line(dBμV/m)
= 55.45(dBμV/m) – 74(dBμV/m)
= -18.55(dB)

For Average Limit @ 2390MHz:

- Level(dBμV/m)
= Antenna Factor(dB/m) + Cable Loss(dB) + Read Level(dBμV) - Preamp Factor(dB)
= 32.22(dB/m) + 4.58(dB) + 42.6(dBμV) – 35.86 (dB)
= 43.54 (dBμV/m)
- Over Limit(dB)
= Level(dBμV/m) – Limit Line(dBμV/m)
= 43.54(dBμV/m) – 54(dBμV/m)
= -10.46(dB)

Both peak and average measured complies with the limit line, so test result is “PASS”.



Appendix C. Radiated Spurious Emission Plots

2.4GHz 2400~2483.5MHz

BLE (Band Edge @ 3m)

BLE	2.4GHz 2400~2483.5MHz Band Edge @ 3m	
ANT	BLE CH00 2402MHz	
1	Horizontal	Vertical
Peak	<p>Site : 03CH07-HY Condition : FCC CLASS-B 3m HF-ANT_130829 HORIZONTAL RBW:1000.000KHz VBW:3000.000KHz SWT:Auto Detector : Peak</p>	<p>Site : 03CH07-HY Condition : FCC CLASS-B 3m HF-ANT_130829 VERTICAL RBW:1000.000KHz VBW:3000.000KHz SWT:Auto Detector : Peak</p>
Avg.	<p>Site : 03CH07-HY Condition : FCC CLASS-B (AVG) 3m HF-ANT_130829 HORIZONTAL RBW:1000.000KHz VBW:3.000KHz SWT:Auto Detector : Peak</p>	<p>Site : 03CH07-HY Condition : FCC CLASS-B (AVG) 3m HF-ANT_130829 VERTICAL RBW:1000.000KHz VBW:3.000KHz SWT:Auto Detector : Peak</p>

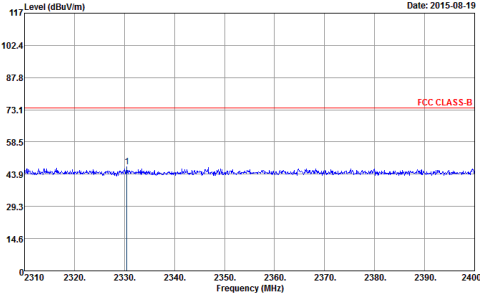
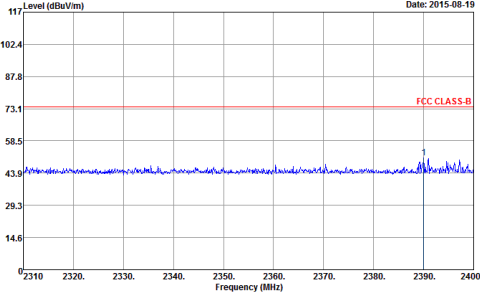
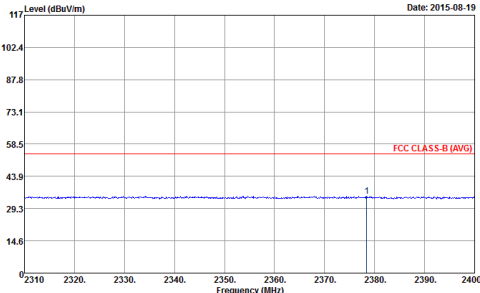
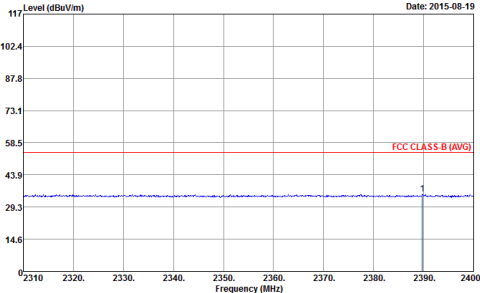

BLE	2.4GHz 2400~2483.5MHz Band Edge @ 3m	
ANT	BLE CH19 2440MHz - Low Channel Location	
1	Horizontal	Vertical
Peak	 <p>Site : 03CH07-HY Condition : FCC CLASS-B 3m HF-ANT_130829 HORIZONTAL RBW:1000.000kHz VBW:3000.000kHz SWT:Auto Detector : Peak</p>	 <p>Site : 03CH07-HY Condition : FCC CLASS-B 3m HF-ANT_130829 VERTICAL RBW:1000.000kHz VBW:3000.000kHz SWT:Auto Detector : Peak</p>
Avg.	 <p>Site : 03CH07-HY Condition : FCC CLASS-B (AVG) 3m HF-ANT_130829 HORIZONTAL RBW:1000.000kHz VBW:3.000kHz SWT:Auto Detector : Peak</p>	 <p>Site : 03CH07-HY Condition : FCC CLASS-B (AVG) 3m HF-ANT_130829 VERTICAL RBW:1000.000kHz VBW:3.000kHz SWT:Auto Detector : Peak</p>

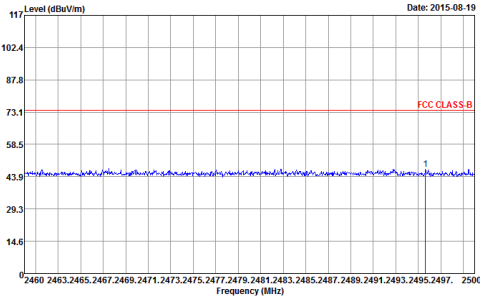
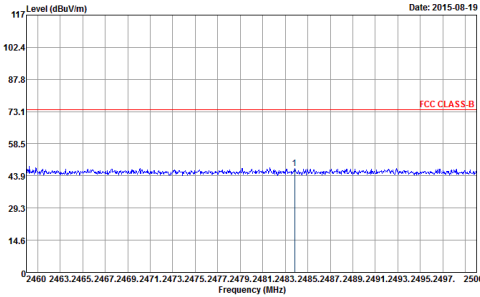
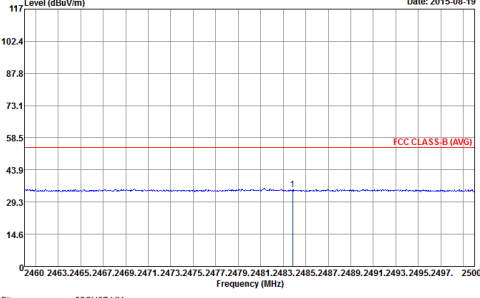
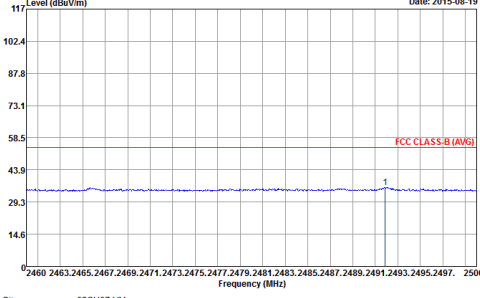

BLE	2.4GHz 2400~2483.5MHz Band Edge @ 3m	
ANT	BLE CH19 2440MHz - High Channel Location	
1	Horizontal	Vertical
Peak	 <p>Level (dBuV/m) vs Frequency (MHz) plot for Horizontal Peak. The y-axis ranges from 14.6 to 117 dBuV/m. The x-axis ranges from 2460 to 2500 MHz. A red horizontal line indicates the FCC CLASS-B limit at 73.1 dBuV/m. A blue signal trace shows a peak at approximately 2440 MHz, labeled '1', which is below the limit line.</p> <p>Site : 03CH07-HY Condition : FCC CLASS-B 3m HF-ANT_130829 HORIZONTAL Detector : Peak RBW:1000.000KHz VBW:3000.000KHz SWT:Auto</p>	 <p>Level (dBuV/m) vs Frequency (MHz) plot for Vertical Peak. The y-axis ranges from 14.6 to 117 dBuV/m. The x-axis ranges from 2460 to 2500 MHz. A red horizontal line indicates the FCC CLASS-B limit at 73.1 dBuV/m. A blue signal trace shows a peak at approximately 2440 MHz, labeled '1', which is below the limit line.</p> <p>Site : 03CH07-HY Condition : FCC CLASS-B 3m HF-ANT_130829 VERTICAL Detector : Peak RBW:1000.000KHz VBW:3000.000KHz SWT:Auto</p>
Avg.	 <p>Level (dBuV/m) vs Frequency (MHz) plot for Horizontal Avg. The y-axis ranges from 14.6 to 117 dBuV/m. The x-axis ranges from 2460 to 2500 MHz. A red horizontal line indicates the FCC CLASS-B (AVG) limit at 58.5 dBuV/m. A blue signal trace shows a peak at approximately 2440 MHz, labeled '1', which is below the limit line.</p> <p>Site : 03CH07-HY Condition : FCC CLASS-B (AVG) 3m HF-ANT_130829 HORIZONTAL Detector : Peak RBW:1000.000KHz VBW:3.000KHz SWT:Auto</p>	 <p>Level (dBuV/m) vs Frequency (MHz) plot for Vertical Avg. The y-axis ranges from 14.6 to 117 dBuV/m. The x-axis ranges from 2460 to 2500 MHz. A red horizontal line indicates the FCC CLASS-B (AVG) limit at 58.5 dBuV/m. A blue signal trace shows a peak at approximately 2440 MHz, labeled '1', which is below the limit line.</p> <p>Site : 03CH07-HY Condition : FCC CLASS-B (AVG) 3m HF-ANT_130829 VERTICAL Detector : Peak RBW:1000.000KHz VBW:3.000KHz SWT:Auto</p>

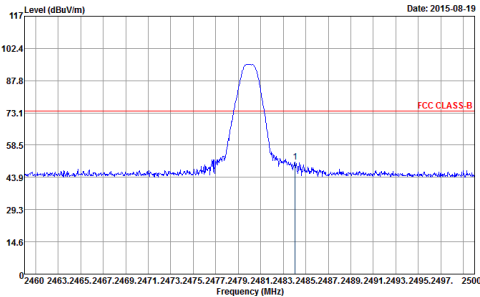
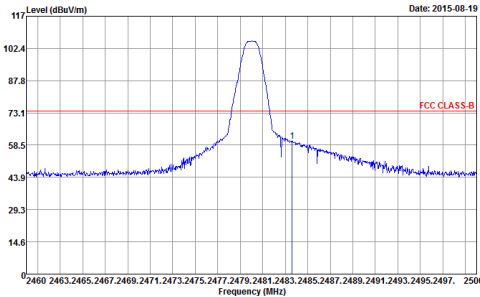
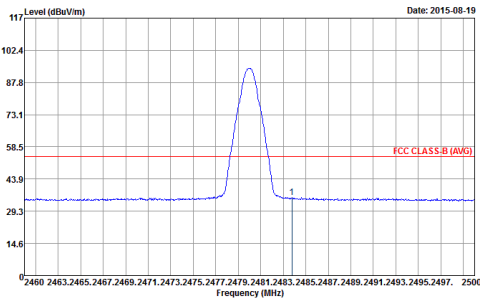
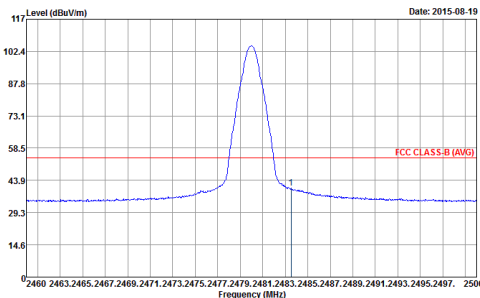

BLE	2.4GHz 2400~2483.5MHz Band Edge @ 3m	
ANT	BLE CH39 2480MHz	
1	Horizontal	Vertical
Peak	 <p>Level (dBuV/m) vs Frequency (MHz) plot for Horizontal orientation. The y-axis ranges from 14.6 to 117 dBuV/m, and the x-axis ranges from 2460 to 2500 MHz. A peak is observed at approximately 2480 MHz, reaching a level of about 102.4 dBuV/m. A red horizontal line indicates the FCC CLASS-B limit at 73.1 dBuV/m. A vertical line marks the peak at 2480 MHz.</p> <p>Site : 03CH07-HY Condition : FCC CLASS-B 3m HF-ANT_130829 HORIZONTAL RBW:1000.000kHz VBW:3000.000kHz SWT:Auto Detector : Peak</p>	 <p>Level (dBuV/m) vs Frequency (MHz) plot for Vertical orientation. The y-axis ranges from 14.6 to 117 dBuV/m, and the x-axis ranges from 2460 to 2500 MHz. A peak is observed at approximately 2480 MHz, reaching a level of about 102.4 dBuV/m. A red horizontal line indicates the FCC CLASS-B limit at 73.1 dBuV/m. A vertical line marks the peak at 2480 MHz.</p> <p>Site : 03CH07-HY Condition : FCC CLASS-B 3m HF-ANT_130829 VERTICAL RBW:1000.000kHz VBW:3000.000kHz SWT:Auto Detector : Peak</p>
Avg.	 <p>Level (dBuV/m) vs Frequency (MHz) plot for Horizontal orientation (Average). The y-axis ranges from 14.6 to 117 dBuV/m, and the x-axis ranges from 2460 to 2500 MHz. A peak is observed at approximately 2480 MHz, reaching a level of about 102.4 dBuV/m. A red horizontal line indicates the FCC CLASS-B (AVG) limit at 58.5 dBuV/m. A vertical line marks the peak at 2480 MHz.</p> <p>Site : 03CH07-HY Condition : FCC CLASS-B (AVG) 3m HF-ANT_130829 HORIZONTAL RBW:1000.000kHz VBW:3000.000kHz SWT:Auto Detector : Peak</p>	 <p>Level (dBuV/m) vs Frequency (MHz) plot for Vertical orientation (Average). The y-axis ranges from 14.6 to 117 dBuV/m, and the x-axis ranges from 2460 to 2500 MHz. A peak is observed at approximately 2480 MHz, reaching a level of about 102.4 dBuV/m. A red horizontal line indicates the FCC CLASS-B (AVG) limit at 58.5 dBuV/m. A vertical line marks the peak at 2480 MHz.</p> <p>Site : 03CH07-HY Condition : FCC CLASS-B (AVG) 3m HF-ANT_130829 VERTICAL RBW:1000.000kHz VBW:3000.000kHz SWT:Auto Detector : Peak</p>



2.4GHz 2400~2483.5MHz

BLE (Harmonic @ 3m)

BLE	2.4GHz 2400~2483.5MHz Harmonic @ 3m	
ANT	BLE CH00 2402MHz	
1	Horizontal	Vertical
Peak Avg.	<p>Site : 03CH07-HY Condition : FCC CLASS-B 3m SHF-EHF_131029 HORIZONTAL Detector : Peak</p>	<p>Site : 03CH07-HY Condition : FCC CLASS-B 3m SHF-EHF_131029 VERTICAL Detector : Peak</p>

BLE	2.4GHz 2400~2483.5MHz Harmonic @ 3m	
ANT	BLE CH19 2440MHz	
1	Horizontal	Vertical
Peak Avg.	<p>Site : 03CH07-HY Condition : FCC CLASS-B 3m SHF-EHF_131029 HORIZONTAL Detector : Peak</p>	<p>Site : 03CH07-HY Condition : FCC CLASS-B 3m SHF-EHF_131029 VERTICAL Detector : Peak</p>



BLE	2.4GHz 2400~2483.5MHz Harmonic @ 3m	
ANT	BLE CH39 2480MHz	
1	Horizontal	Vertical
Peak Avg.	<p>Site : 03CH07-HY Condition : FCC CLASS-B 3m SHF-EHF_131029 HORIZONTAL Detector : Peak</p>	<p>Site : 03CH07-HY Condition : FCC CLASS-B 3m SHF-EHF_131029 VERTICAL Detector : Peak</p>



Emission below 1GHz

2.4GHz BLE (LF)

BLE	2.4GHz 2400~2483.5MHz	
ANT	BLE LF	
1	Horizontal	Vertical
QP / Peak	<p>Site : 03CH07-HY Condition : FCC CLASS-B 3m LF-ANT(131102) HORIZONTAL Detector : Peak</p>	<p>Site : 03CH07-HY Condition : FCC CLASS-B 3m LF-ANT(131102) VERTICAL Detector : Peak</p>



2.4GHz 2400~2483.5MHz

BLE (Band Edge @ 3m)

BLE	2.4GHz 2400~2483.5MHz Band Edge @ 3m	
ANT	BLE CH00 2402MHz	
2	Horizontal	Vertical
Peak	<p>Site : 03CH07-HY Condition : FCC CLASS-B 3m HF-ANT_130829 HORIZONTAL RBW: 1000.000KHz VBW: 3000.000KHz SWT: Auto Detector : Peak</p>	<p>Site : 03CH07-HY Condition : FCC CLASS-B 3m HF-ANT_130829 VERTICAL RBW: 1000.000KHz VBW: 3000.000KHz SWT: Auto Detector : Peak</p>
Avg.	<p>Site : 03CH07-HY Condition : FCC CLASS-B (AVG) 3m HF-ANT_130829 HORIZONTAL RBW: 1000.000KHz VBW: 3.000KHz SWT: Auto Detector : Peak</p>	<p>Site : 03CH07-HY Condition : FCC CLASS-B (AVG) 3m HF-ANT_130829 VERTICAL RBW: 1000.000KHz VBW: 3.000KHz SWT: Auto Detector : Peak</p>

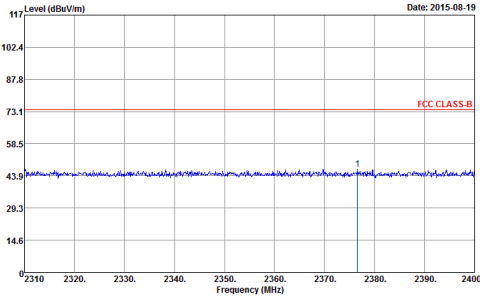
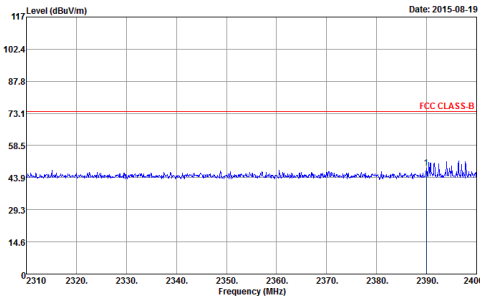
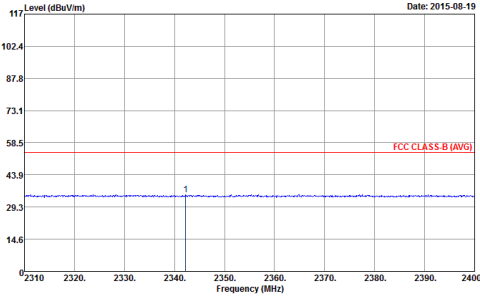
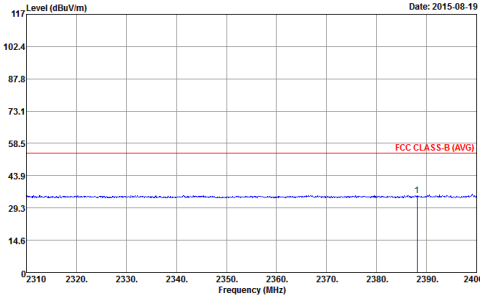

BLE	2.4GHz 2400~2483.5MHz Band Edge @ 3m	
ANT	BLE CH19 2440MHz - Low Channel Location	
2	Horizontal	Vertical
Peak	 <p>Level (dBuV/m) vs Frequency (MHz) plot for Horizontal orientation. The y-axis ranges from 0 to 117 dBuV/m, and the x-axis ranges from 2310 to 2400 MHz. A red horizontal line indicates the FCC CLASS-B limit at 73.1 dBuV/m. The blue signal trace shows a peak at approximately 2378 MHz, reaching about 70 dBuV/m.</p> <p>Site : 03CH07-HY Condition : FCC CLASS-B 3m HF-ANT_130829 HORIZONTAL RBW: 1000.000kHz VBW: 3000.000kHz SWT: Auto Detector : Peak</p>	 <p>Level (dBuV/m) vs Frequency (MHz) plot for Vertical orientation. The y-axis ranges from 0 to 117 dBuV/m, and the x-axis ranges from 2310 to 2400 MHz. A red horizontal line indicates the FCC CLASS-B limit at 73.1 dBuV/m. The blue signal trace shows a peak at approximately 2390 MHz, reaching about 70 dBuV/m.</p> <p>Site : 03CH07-HY Condition : FCC CLASS-B 3m HF-ANT_130829 VERTICAL RBW: 1000.000kHz VBW: 3000.000kHz SWT: Auto Detector : Peak</p>
Avg.	 <p>Level (dBuV/m) vs Frequency (MHz) plot for Horizontal orientation (Average). The y-axis ranges from 0 to 117 dBuV/m, and the x-axis ranges from 2310 to 2400 MHz. A red horizontal line indicates the FCC CLASS-B (AVG) limit at 58.5 dBuV/m. The blue signal trace shows a peak at approximately 2378 MHz, reaching about 55 dBuV/m.</p> <p>Site : 03CH07-HY Condition : FCC CLASS-B (AVG) 3m HF-ANT_130829 HORIZONTAL RBW: 1000.000kHz VBW: 3.000kHz SWT: Auto Detector : Peak</p>	 <p>Level (dBuV/m) vs Frequency (MHz) plot for Vertical orientation (Average). The y-axis ranges from 0 to 117 dBuV/m, and the x-axis ranges from 2310 to 2400 MHz. A red horizontal line indicates the FCC CLASS-B (AVG) limit at 58.5 dBuV/m. The blue signal trace shows a peak at approximately 2390 MHz, reaching about 55 dBuV/m.</p> <p>Site : 03CH07-HY Condition : FCC CLASS-B (AVG) 3m HF-ANT_130829 VERTICAL RBW: 1000.000kHz VBW: 3.000kHz SWT: Auto Detector : Peak</p>

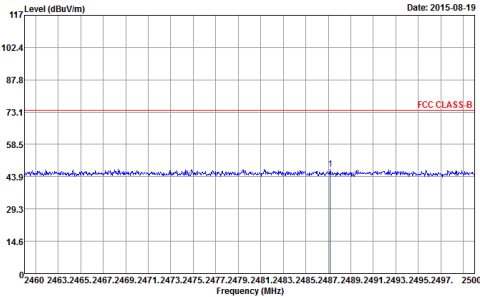
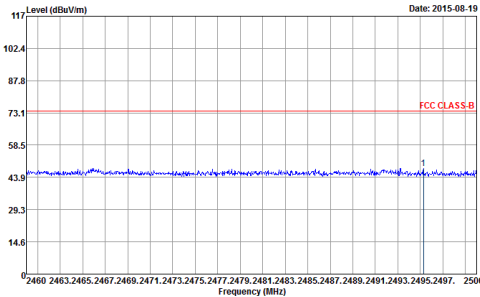
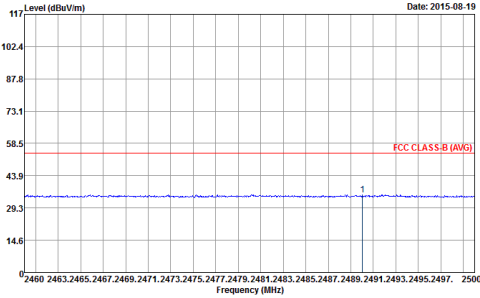
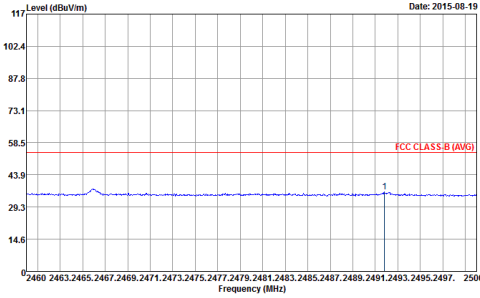

BLE	2.4GHz 2400~2483.5MHz Band Edge @ 3m	
ANT	BLE CH19 2440MHz - High Channel Location	
2	Horizontal	Vertical
Peak	 <p>Level (dBuV/m) vs Frequency (MHz) plot for Horizontal orientation. The y-axis ranges from 14.6 to 117 dBuV/m, and the x-axis ranges from 2460 to 2500 MHz. A red horizontal line indicates the FCC CLASS-B limit at 73.1 dBuV/m. A single sharp peak is visible at approximately 2440 MHz, reaching a level of about 58.5 dBuV/m.</p> <p>Site : 03CH07-HY Condition : FCC CLASS-B 3m HF-ANT_130829 HORIZONTAL RBW: 1000.000kHz VBW: 3000.000kHz SWT: Auto Detector : Peak</p>	 <p>Level (dBuV/m) vs Frequency (MHz) plot for Vertical orientation. The y-axis ranges from 14.6 to 117 dBuV/m, and the x-axis ranges from 2460 to 2500 MHz. A red horizontal line indicates the FCC CLASS-B limit at 73.1 dBuV/m. A single sharp peak is visible at approximately 2440 MHz, reaching a level of about 58.5 dBuV/m.</p> <p>Site : 03CH07-HY Condition : FCC CLASS-B 3m HF-ANT_130829 VERTICAL RBW: 1000.000kHz VBW: 3000.000kHz SWT: Auto Detector : Peak</p>
Avg.	 <p>Level (dBuV/m) vs Frequency (MHz) plot for Horizontal orientation showing average levels. The y-axis ranges from 14.6 to 117 dBuV/m, and the x-axis ranges from 2460 to 2500 MHz. A red horizontal line indicates the FCC CLASS-B (AVG) limit at 58.5 dBuV/m. The average signal level is consistently below this limit, around 43.9 dBuV/m.</p> <p>Site : 03CH07-HY Condition : FCC CLASS-B (AVG) 3m HF-ANT_130829 HORIZONTAL RBW: 1000.000kHz VBW: 3.000kHz SWT: Auto Detector : Peak</p>	 <p>Level (dBuV/m) vs Frequency (MHz) plot for Vertical orientation showing average levels. The y-axis ranges from 14.6 to 117 dBuV/m, and the x-axis ranges from 2460 to 2500 MHz. A red horizontal line indicates the FCC CLASS-B (AVG) limit at 58.5 dBuV/m. The average signal level is consistently below this limit, around 43.9 dBuV/m.</p> <p>Site : 03CH07-HY Condition : FCC CLASS-B (AVG) 3m HF-ANT_130829 VERTICAL RBW: 1000.000kHz VBW: 3.000kHz SWT: Auto Detector : Peak</p>

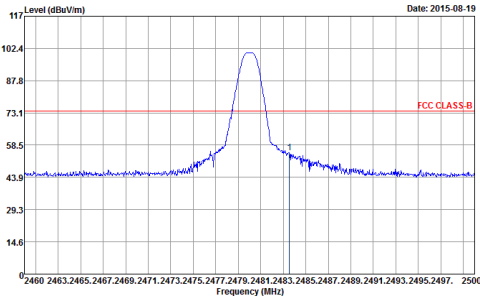
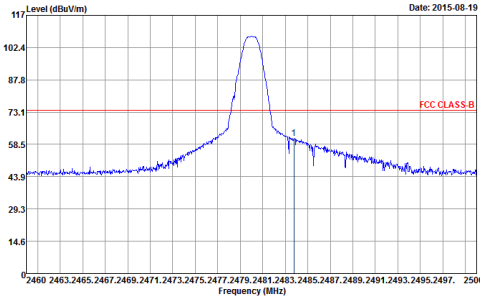
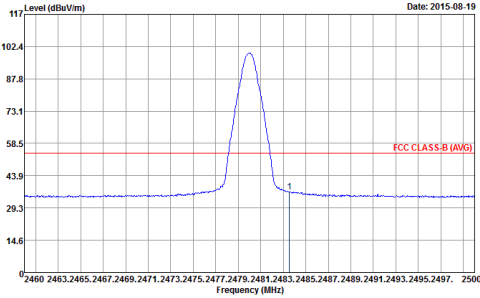
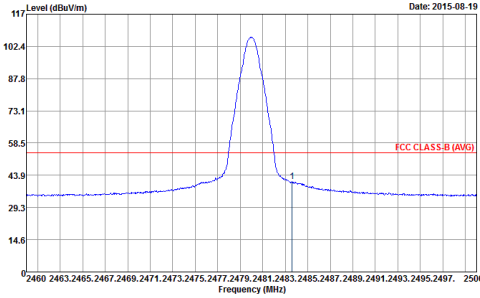

BLE	2.4GHz 2400~2483.5MHz Band Edge @ 3m	
ANT	BLE CH39 2480MHz	
2	Horizontal	Vertical
Peak	 <p>Site : 03CH07-HY Condition : FCC CLASS-B 3m HF-ANT_130829 HORIZONTAL RBW:1000.000kHz VBW:3000.000kHz SWT:Auto Detector : Peak</p>	 <p>Site : 03CH07-HY Condition : FCC CLASS-B 3m HF-ANT_130829 VERTICAL RBW:1000.000kHz VBW:3000.000kHz SWT:Auto Detector : Peak</p>
Avg.	 <p>Site : 03CH07-HY Condition : FCC CLASS-B (AVG) 3m HF-ANT_130829 HORIZONTAL RBW:1000.000kHz VBW:3.000kHz SWT:Auto Detector : Peak</p>	 <p>Site : 03CH07-HY Condition : FCC CLASS-B (AVG) 3m HF-ANT_130829 VERTICAL RBW:1000.000kHz VBW:3.000kHz SWT:Auto Detector : Peak</p>



BLE	2.4GHz 2400~2483.5MHz Band Edge @ 3m	
ANT	BLE CH39 2480MHz with Base	
2	Horizontal	Vertical
Peak	<p>Date: 2015-09-01</p> <p>Site : 03CH07-HY Condition : FCC CLASS-B 3m HF-ANT_130829 HORIZONTAL RBW:1000.000kHz VBW:3000.000kHz SWT:Auto Detector : Peak</p>	<p>Date: 2015-09-01</p> <p>Site : 03CH07-HY Condition : FCC CLASS-B 3m HF-ANT_130829 VERTICAL RBW:1000.000kHz VBW:3000.000kHz SWT:Auto Detector : Peak</p>
Avg.	<p>Date: 2015-09-01</p> <p>Site : 03CH07-HY Condition : FCC CLASS-B (AVG) 3m HF-ANT_130829 HORIZONTAL RBW:1000.000kHz VBW:3.000kHz SWT:Auto Detector : Peak</p>	<p>Date: 2015-09-01</p> <p>Site : 03CH07-HY Condition : FCC CLASS-B (AVG) 3m HF-ANT_130829 VERTICAL RBW:1000.000kHz VBW:3.000kHz SWT:Auto Detector : Peak</p>



2.4GHz 2400~2483.5MHz

BLE (Harmonic @ 3m)

BLE	2.4GHz 2400~2483.5MHz Harmonic @ 3m	
ANT	BLE CH00 2402MHz	
2	Horizontal	Vertical
Peak Avg.	<p>Site : 03CH07-HY Condition : FCC CLASS-B 3m SHF-EHF_131029 HORIZONTAL Detector : Peak</p>	<p>Site : 03CH07-HY Condition : FCC CLASS-B 3m SHF-EHF_131029 VERTICAL Detector : Peak</p>

BLE	2.4GHz 2400~2483.5MHz Harmonic @ 3m	
ANT	BLE CH19 2440MHz	
2	Horizontal	Vertical
Peak Avg.	<p>Site : 03CH07-HY Condition : FCC CLASS-B 3m SHF-EHF_131029 HORIZONTAL Detector : Peak</p>	<p>Site : 03CH07-HY Condition : FCC CLASS-B 3m SHF-EHF_131029 VERTICAL Detector : Peak</p>



BLE	2.4GHz 2400~2483.5MHz Harmonic @ 3m	
ANT	BLE CH39 2480MHz	
2	Horizontal	Vertical
Peak Avg.	<p>Site : 03CH07-HY Condition : FCC CLASS-B 3m SHF-EHF_131029 HORIZONTAL Detector : Peak</p>	<p>Site : 03CH07-HY Condition : FCC CLASS-B 3m SHF-EHF_131029 VERTICAL Detector : Peak</p>

BLE	2.4GHz 2400~2483.5MHz Harmonic @ 3m	
ANT	BLE CH39 2480MHz with Base	
2	Horizontal	Vertical
Peak Avg.	<p>Site : 03CH07-HY Condition : FCC CLASS-B 3m SHF-EHF_131029 HORIZONTAL Detector : Peak</p>	<p>Site : 03CH07-HY Condition : FCC CLASS-B 3m SHF-EHF_131029 VERTICAL Detector : Peak</p>



Emission below 1GHz

2.4GHz BLE (LF)

BLE	2.4GHz 2400~2483.5MHz	
ANT	BLE LF	
2	Horizontal	Vertical
QP / Peak	<p>Site : 03CH07-HY Condition : FCC CLASS-B 3m LF-ANT(131102) HORIZONTAL Detector : Peak</p>	<p>Site : 03CH07-HY Condition : FCC CLASS-B 3m LF-ANT(131102) VERTICAL Detector : Peak</p>