



FCC RF Test Report

APPLICANT : Moon Winker L.L.C.
EQUIPMENT : Wireless Speaker
MODEL NAME : PW3840KL
FCC ID : 2AET6-0610
STANDARD : FCC Part 15 Subpart C §15.247
CLASSIFICATION : (DSS) Spread Spectrum Transmitter

The testing was completed on Sep. 15, 2015. We, SPORTON INTERNATIONAL INC., would like to declare that the tested sample has been evaluated in accordance with the test procedures and has been in compliance with the applicable technical standards.

The test results in this report apply exclusively to the tested model / sample. Without written approval of SPORTON INTERNATIONAL INC., the test report shall not be reproduced except in full.

Reviewed by: Joseph Lin / Supervisor

Approved by: Jones Tsai / Manager



SPORTON INTERNATIONAL INC.

No. 52, Hwa Ya 1st Rd., Hwa Ya Technology Park, Kwei-Shan District, Tao Yuan City, Taiwan, R.O.C.



TABLE OF CONTENTS

REVISION HISTORY..... 3

SUMMARY OF TEST RESULT 4

1 GENERAL DESCRIPTION..... 5

 1.1 Applicant 5

 1.2 Product Feature of Equipment Under Test..... 5

 1.3 Product Specification subjective to this standard 5

 1.4 Modification of EUT 6

 1.5 Testing Location 6

 1.6 Applicable Standards..... 6

2 TEST CONFIGURATION OF EQUIPMENT UNDER TEST..... 7

 2.1 Descriptions of Test Mode 7

 2.2 Test Mode 8

 2.3 Connection Diagram of Test System 9

 2.4 Support Unit used in test configuration and system 10

 2.5 EUT Operation Test Setup 10

 2.6 Measurement Results Explanation Example..... 11

3 TEST RESULT 12

 3.1 Number of Channel Measurement 12

 3.2 Hopping Channel Separation Measurement 15

 3.3 Dwell Time Measurement..... 28

 3.4 20dB Bandwidth Measurement 31

 3.5 Peak Output Power Measurement 44

 3.6 Conducted Band Edges Measurement..... 47

 3.7 Conducted Spurious Emission Measurement 60

 3.8 Radiated Band Edges and Spurious Emission Measurement 79

 3.9 AC Conducted Emission Measurement..... 86

 3.10 Antenna Requirements 90

4 LIST OF MEASURING EQUIPMENT 91

5 UNCERTAINTY OF EVALUATION..... 92

APPENDIX A. RADIATED SPURIOUS EMISSION

APPENDIX B. RADIATED SPURIOUS EMISSION PLOTS



REVISION HISTORY

REPORT NO.	VERSION	DESCRIPTION	ISSUED DATE
FR552738-01A	Rev. 01	Initial issue of report	Jan. 21, 2016



SUMMARY OF TEST RESULT

Report Section	FCC Rule	Description	Limit	Result	Remark
3.1	15.247(a)(1)	Number of Channels	≥ 15 Chs	Pass	-
3.2	15.247(a)(1)	Hopping Channel Separation	$\geq 2/3$ of 20dB BW	Pass	-
3.3	15.247(a)(1)	Dwell Time of Each Channel	≤ 0.4 sec in 31.6sec period	Pass	-
3.4	15.247(a)(1)	20dB Bandwidth	NA	Pass	-
3.5	15.247(b)(1)	Peak Output Power	≤ 125 mW	Pass	-
3.6	15.247(d)	Conducted Band Edges	≤ 20 dBc	Pass	-
3.7	15.247(d)	Conducted Spurious Emission	≤ 20 dBc	Pass	-
3.8	15.247(d)	Radiated Band Edges and Radiated Spurious Emission	15.209(a) & 15.247(d)	Pass	Under limit 6.22 dB at 301.400 MHz
3.9	15.207	AC Conducted Emission	15.207(a)	Pass	Under limit 7.40 dB at 0.406 MHz
3.10	15.203 & 15.247(b)	Antenna Requirement	N/A	Pass	-



1 General Description

1.1 Applicant

Moon Winker L.L.C.
 One Westbrook Corporate Center, Suite 300
 Westchester, Illinois, 60154

1.2 Product Feature of Equipment Under Test

Product Feature	
Equipment	Wireless Speaker
Model Name	PW3840KL
FCC ID	2AET6-0610
EUT supports Radios application	WLAN 11b/g/n HT20 Bluetooth v4.0 EDR/LE

Remark: The above EUT's information was declared by manufacturer. Please refer to the specifications or user's manual for more detailed description.

1.3 Product Specification subjective to this standard

Product Specification subjective to this standard			
Tx/Rx Frequency Range	2402 MHz ~ 2480 MHz		
Number of Channels	79		
Carrier Frequency of Each Channel	2402+n*1 MHz; n=0~78		
Maximum Output Power to Antenna	<Ant. 1> Bluetooth BR(1Mbps) : 9.01 dBm (0.0080 W) Bluetooth EDR (2Mbps) : 8.92 dBm (0.0078 W) Bluetooth EDR (3Mbps) : 8.94 dBm (0.0078 W) <Ant. 2> Bluetooth BR(1Mbps) : 8.14 dBm (0.0065 W) Bluetooth EDR (2Mbps) : 8.10 dBm (0.0065 W) Bluetooth EDR (3Mbps) : 8.13 dBm (0.0065 W)		
Antenna Type	Fixed Internal Antenna type		
Antenna Gain	Channel	Ant. 1	Ant. 2
	00	3.58	2.00
	39	2.87	1.47
	78	3.06	1.24
Type of Modulation	Bluetooth BR (1Mbps) : GFSK Bluetooth EDR (2Mbps) : $\pi/4$ -DQPSK Bluetooth EDR (3Mbps) : 8-DPSK		



1.4 Modification of EUT

No modifications are made to the EUT during all test items.

1.5 Testing Location

Sporton Lab is accredited to ISO 17025 by Taiwan Accreditation Foundation (TAF code : 1190) and the FCC designation No. TW1022 under the FCC 2.948(e) by Mutual Recognition Agreement (MRA) in FCC Test.

Test Site	SPORTON INTERNATIONAL INC.		
Test Site Location	No. 52, Hwa Ya 1 st Rd., Hwa Ya Technology Park, Kwei-Shan District, Tao Yuan City, Taiwan, R.O.C. TEL: +886-3-327-3456 FAX: +886-3-328-4978		
Test Site No.	Sporton Site No.		
	TH05-HY	CO05-HY	03CH07-HY

Note: The test site complies with ANSI C63.4 2009 requirement.

1.6 Applicable Standards

According to the specifications of the manufacturer, the EUT must comply with the requirements of the following standards:

- FCC Part 15 Subpart C §15.247
- ANSI C63.10-2009

Remark:

1. All test items were verified and recorded according to the standards and without any deviation during the test.
2. FCC permits the use of the 1.5 meter table as an alternative in C63.10-2013 through inquiry tracking number 961829.
3. This EUT has also been tested and complied with the requirements of FCC Part 15, Subpart B, recorded in a separate test report.



2 Test Configuration of Equipment Under Test

2.1 Descriptions of Test Mode

Preliminary tests were performed in different data rates and recorded the RF output power in the following table:

<Ant. 1>

Channel	Frequency	Bluetooth RF Output Power		
		Data Rate / Modulation		
		GFSK	$\pi/4$ -DQPSK	8-DPSK
		1Mbps	2Mbps	3Mbps
Ch00	2402MHz	8.10 dBm	8.31 dBm	8.63 dBm
Ch39	2441MHz	9.01 dBm	8.92 dBm	8.94 dBm
Ch78	2480MHz	9.00 dBm	8.70 dBm	8.84 dBm

<Ant. 2>

Channel	Frequency	Bluetooth RF Output Power		
		Data Rate / Modulation		
		GFSK	$\pi/4$ -DQPSK	8-DPSK
		1Mbps	2Mbps	3Mbps
Ch00	2402MHz	7.22 dBm	7.69 dBm	7.68 dBm
Ch39	2441MHz	8.14 dBm	8.10 dBm	8.13 dBm
Ch78	2480MHz	8.00 dBm	7.78 dBm	7.79 dBm

Remark:

1. All the test data for each data rate were verified, but only the worst case was reported.
 2. The data rate was set in 1Mbps for all the test items due to the highest RF output power.
- a. The EUT has been associated with peripherals and configuration operated in a manner tended to maximize its emission characteristics in a typical application. Frequency range investigated: conduction (150 kHz to 30 MHz), radiation (9 kHz to the 10th harmonic of the highest fundamental frequency or to 40 GHz, whichever is lower). Pre-scanned tests, X, Y, Z in three orthogonal panels, and different data rates were conducted to determine the final configuration (Z plane for Ant. 1; X plane for Ant. 2; Y plane for Ant. 2 (EUT with Base)) from all possible combinations, and the worst mode of radiated spurious emissions is Bluetooth 1Mbps mode, and recorded in this report.
- b. AC power line Conducted Emission was tested under maximum output power.



2.2 Test Mode

The following summary table is showing all test modes to demonstrate in compliance with the standard.

Summary table of Test Cases			
Test Item	Data Rate / Modulation		
	Bluetooth BR 1Mbps GFSK	Bluetooth EDR 2Mbps $\pi/4$ -DQPSK	Bluetooth EDR 3Mbps 8-DPSK
Conducted Test Cases (For Ant. 1)	Mode 1: CH00_2402 MHz	Mode 4: CH00_2402 MHz	Mode 7: CH00_2402 MHz
	Mode 2: CH39_2441 MHz	Mode 5: CH39_2441 MHz	Mode 8: CH39_2441 MHz
	Mode 3: CH78_2480 MHz	Mode 6: CH78_2480 MHz	Mode 9: CH78_2480 MHz
Conducted Test Cases (For Ant. 2)	Mode 1: CH00_2402 MHz	Mode 4: CH00_2402 MHz	Mode 7: CH00_2402 MHz
	Mode 2: CH39_2441 MHz	Mode 5: CH39_2441 MHz	Mode 8: CH39_2441 MHz
	Mode 3: CH78_2480 MHz	Mode 6: CH78_2480 MHz	Mode 9: CH78_2480 MHz
Radiated Test Cases	Bluetooth BR 1Mbps GFSK		
	Mode 1: CH00_2402 MHz for Ant. 1		
	Mode 2: CH39_2441 MHz for Ant. 1		
	Mode 3: CH78_2480 MHz for Ant. 1		
	Mode 4: CH00_2402 MHz for Ant. 2		
	Mode 5: CH39_2441 MHz for Ant. 2		
	Mode 6: CH78_2480 MHz for Ant. 2		
	Mode 7: CH78_2480 MHz for Ant. 2 + Base		
AC Conducted Emission	Mode 1 :WLAN Link + Bluetooth Link		
Remark: For radiated test cases, the worst mode data rate 1Mbps was reported only, because this data rate has the highest RF output power at preliminary tests, and the conducted spurious emissions and conducted band edge measurement for each data rate are no worse than 1Mbps, and no other significantly frequencies found in conducted spurious emission.			

2.3 Connection Diagram of Test System

<Bluetooth Tx Mode>

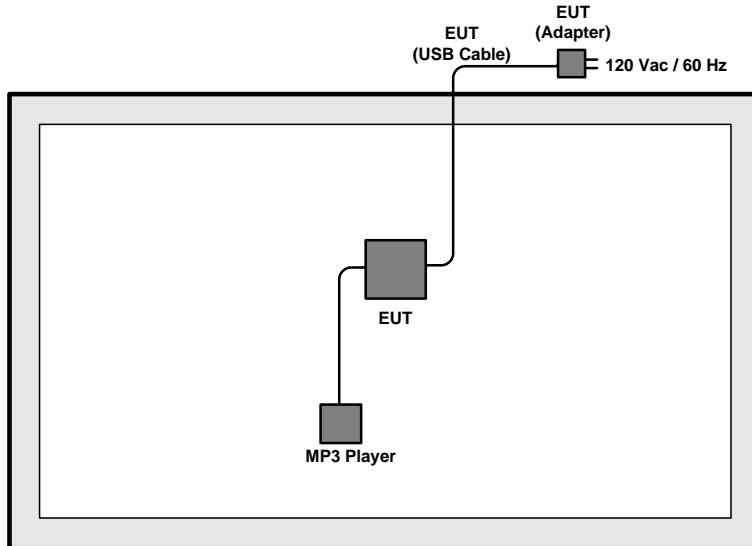

<Bluetooth Tx Mode with Base>

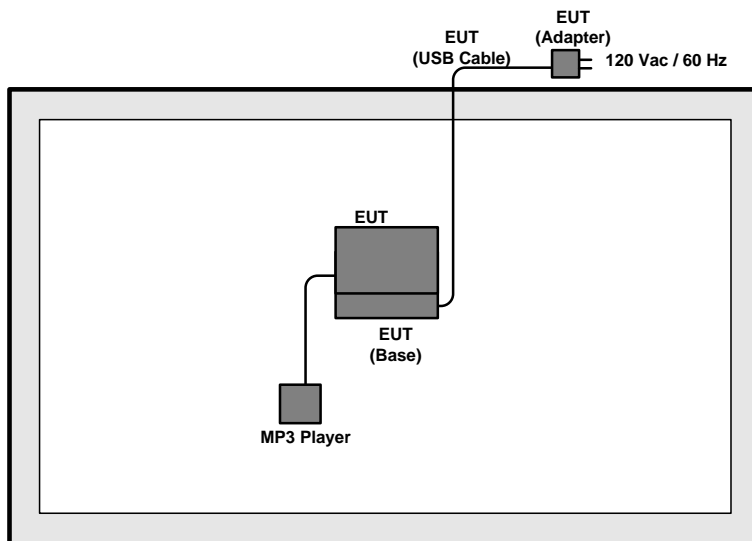

<AC Conducted Emission Mode>

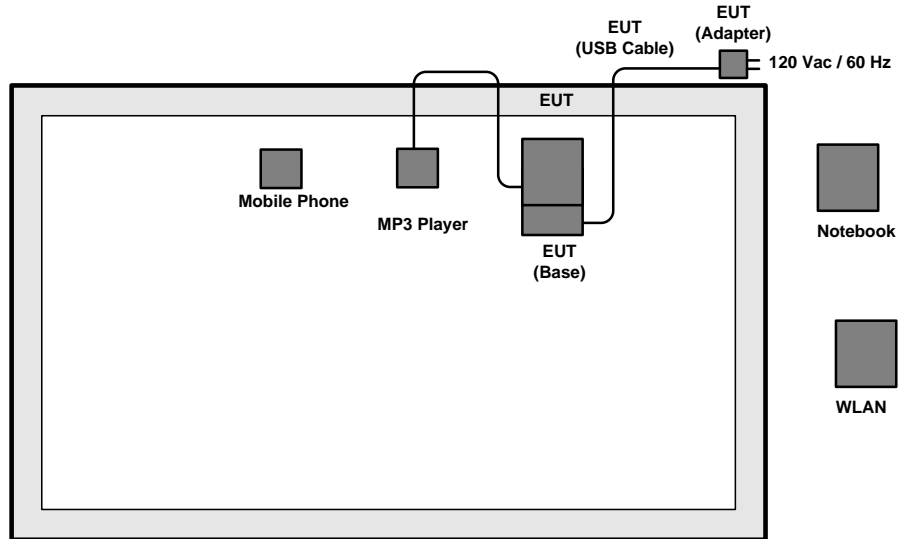

2.4 Support Unit used in test configuration and system

Item	Equipment	Trade Name	Model Name	FCC ID	Data Cable	Power Cord
1.	WLAN AP	N/A	N/A	N/A	N/A	N/A
2.	Notebook	N/A	N/A	N/A	N/A	N/A
3.	Mobile Phone	N/A	N/A	N/A	N/A	N/A
4.	MP3 Player	N/A	N/A	N/A	N/A	N/A

2.5 EUT Operation Test Setup

For Bluetooth function, programmed RF utility, installed in the notebook make the EUT provide functions like channel selection and power level for continuous transmitting and receiving signals.



2.6 Measurement Results Explanation Example

For all conducted test items:

The offset level is set in the spectrum analyzer to compensate the RF cable loss and attenuator factor between EUT conducted output port and spectrum analyzer. With the offset compensation, the spectrum analyzer reading level is exactly the EUT RF output level.

Example:

The spectrum analyzer offset is derived from RF cable loss and attenuator factor.

Offset = RF cable loss + attenuator factor.

Following shows an offset computation example with cable loss 4.2 dB and 10dB attenuator.

$$\begin{aligned} \text{Offset(dB)} &= \text{RF cable loss(dB)} + \text{attenuator factor(dB)}. \\ &= 4.2 + 10 = 14.2 \text{ (dB)} \end{aligned}$$

3 Test Result

3.1 Number of Channel Measurement

3.1.1 Limits of Number of Hopping Frequency

Frequency hopping systems in the 2400-2483.5 MHz band shall use at least 15 channels.

3.1.2 Measuring Instruments

The measuring equipment is listed in the section 4 of this test report.

3.1.3 Test Procedure

1. The testing follows ANSI C63.10-2009 clause 7.7.3.
2. The RF output of EUT was connected to the spectrum analyzer by RF cable and attenuator. The path loss was compensated to the results for each measurement.
3. Set to the maximum power setting and enable the EUT transmit continuously.
4. Enable the EUT hopping function.
5. Use the following spectrum analyzer settings: Span = the frequency band of operation; RBW \geq 1% of the span; VBW \geq RBW; Sweep = auto; Detector function = peak; Trace = max hold.
6. The number of hopping frequency used is defined as the number of total channel.
7. Record the measurement data derived from spectrum analyzer.

3.1.4 Test Setup

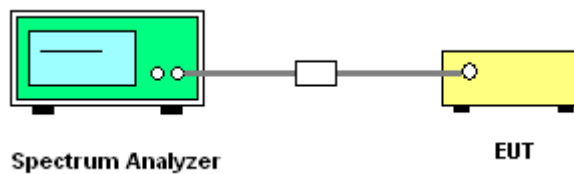

3.1.5 Test Result of Number of Hopping Frequency

Test Mode :	1Mbps	Temperature :	24~26°C
Test Engineer :	Tommy Lee	Relative Humidity :	48~51%
Number of Hopping (Channel)	Adaptive Frequency Hopping (Channel)	Limits (Channel)	Pass/Fail
79	20	> 15	Pass



<Ant. 1>

Number of Hopping Channel Plot on Channel 00 - 78

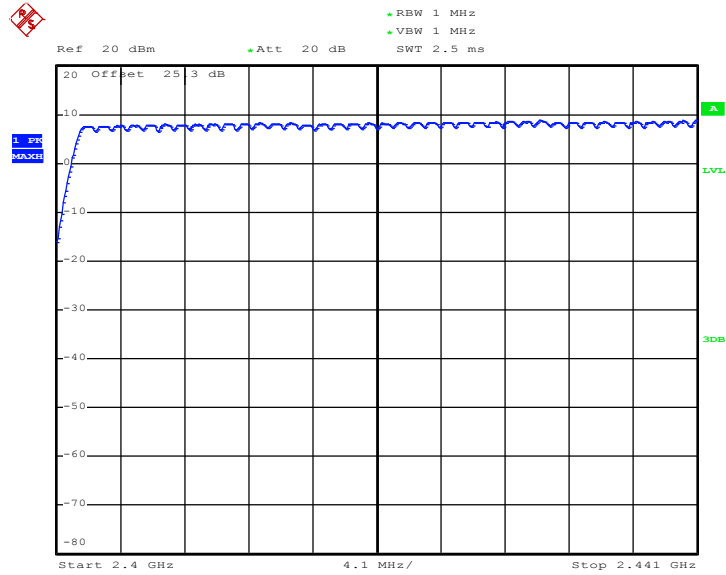

Date: 11.SEP.2015 21:00:44

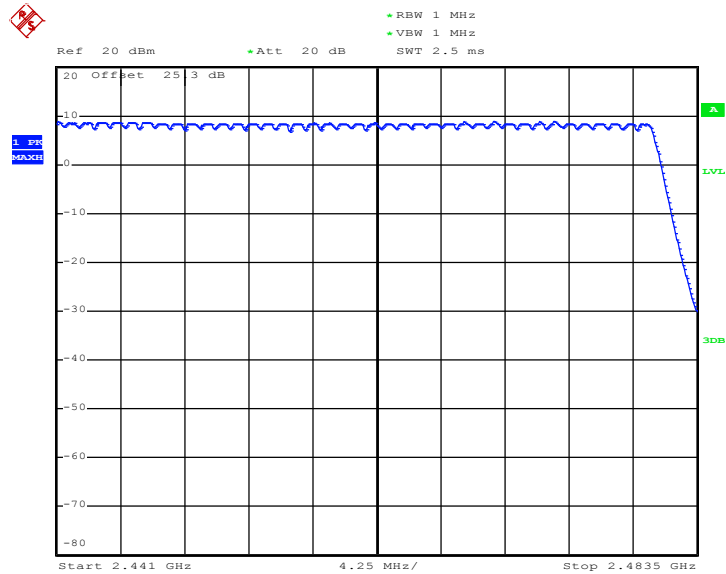

Date: 11.SEP.2015 21:01:22



<Ant. 2>

Number of Hopping Channel Plot on Channel 00 - 78

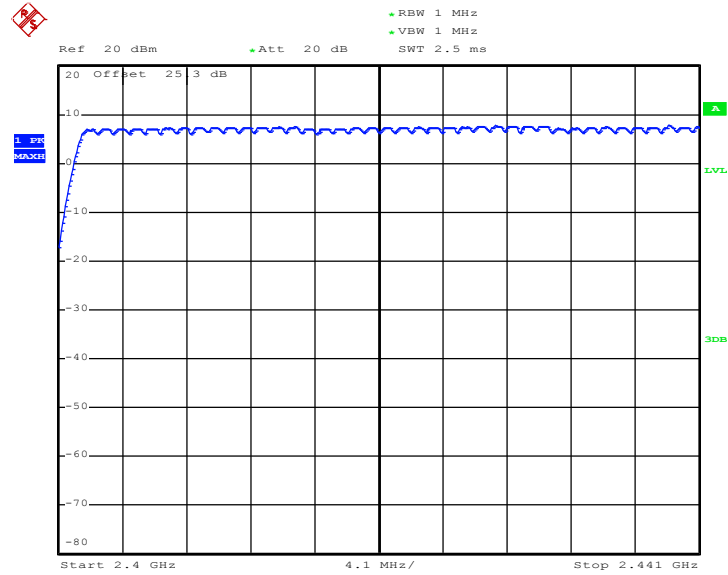

Date: 11.SEP.2015 21:33:00

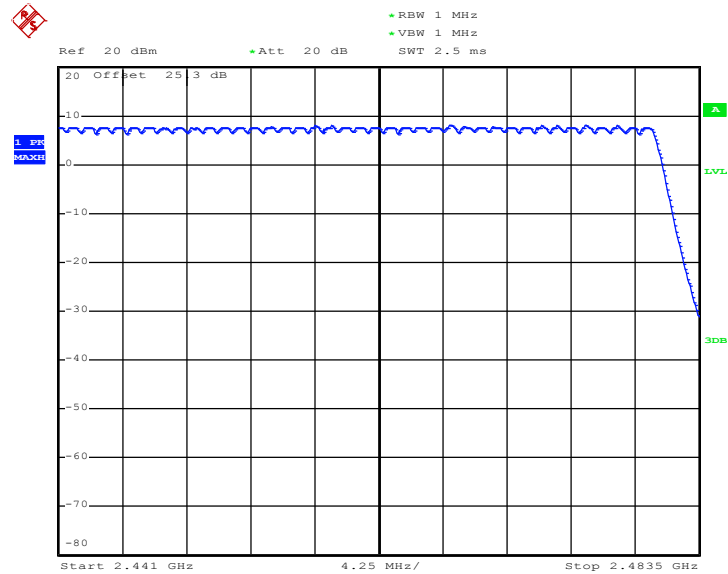

Date: 11.SEP.2015 21:33:40

3.2 Hopping Channel Separation Measurement

3.2.1 Limit of Hopping Channel Separation

Frequency hopping systems operating in the 2400-2483.5 MHz band may have hopping channel carrier frequencies that are separated by 25 kHz or two-thirds of the 20 dB bandwidth of the hopping channel, whichever is greater.

3.2.2 Measuring Instruments

The measuring equipment is listed in the section 4 of this test report.

3.2.3 Test Procedures

1. The testing follows ANSI C63.10-2009 clause 7.7.2.
2. The RF output of EUT was connected to the spectrum analyzer by RF cable and attenuator. The path loss was compensated to the results for each measurement.
3. Set to the maximum power setting and enable the EUT transmit continuously.
4. Enable the EUT hopping function.
5. Use the following spectrum analyzer settings:
Span = wide enough to capture the peaks of two adjacent channels;
RBW \geq 1% of the span; VBW \geq RBW; Sweep = auto; Detector function = peak; Trace = max hold.
6. Measure and record the results in the test report.

3.2.4 Test Setup

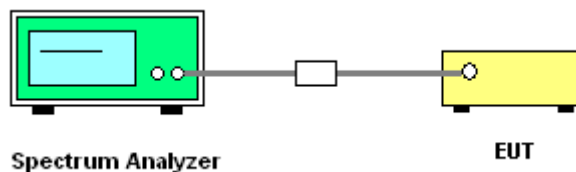



3.2.5 Test Result of Hopping Channel Separation

<Ant. 1>

Test Mode :	1Mbps	Temperature :	24~26°C
Test Engineer :	Tommy Lee	Relative Humidity :	48~51%

Channel	Frequency (MHz)	Frequency Separation (MHz)	(2/3 of 20dB BW) Limits (MHz)	Pass/Fail
00	2402	1.002	0.6987	Pass
39	2441	1.008	0.6987	Pass
78	2480	1.008	0.7013	Pass

Channel Separation Plot on Channel 00 - 01

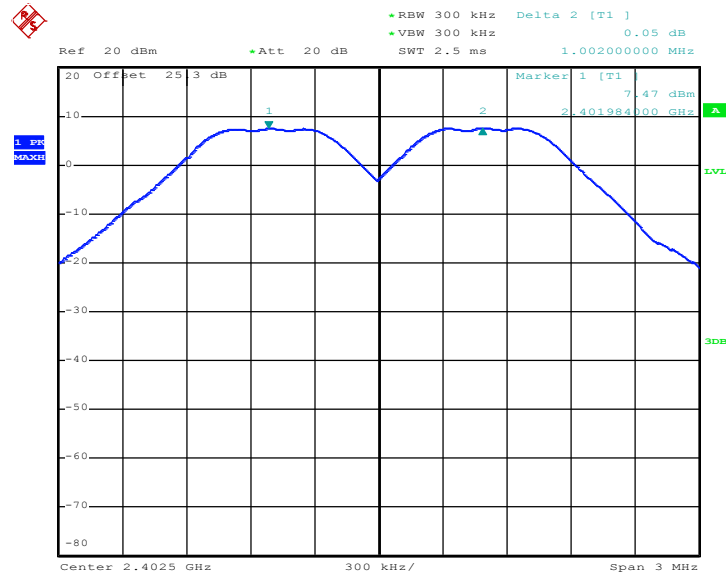

Date: 1.SEP.2015 10:51:53



Channel Separation Plot on Channel 39 - 40

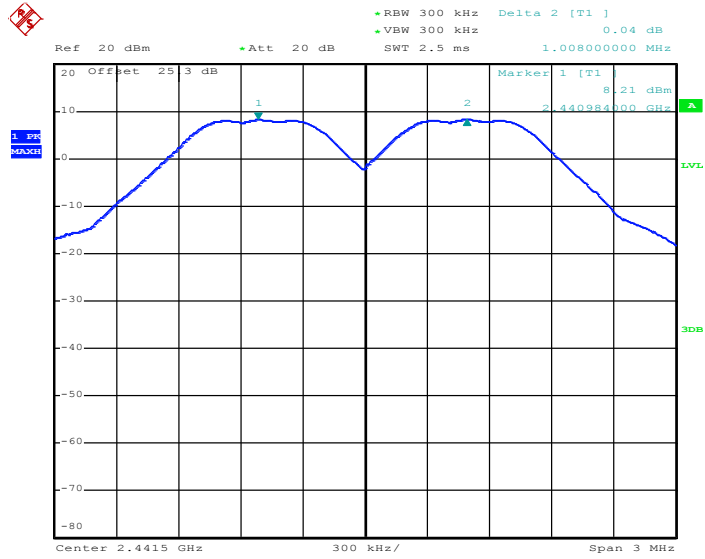

Date: 1.SEP.2015 13:40:18

Channel Separation Plot on Channel 77 - 78

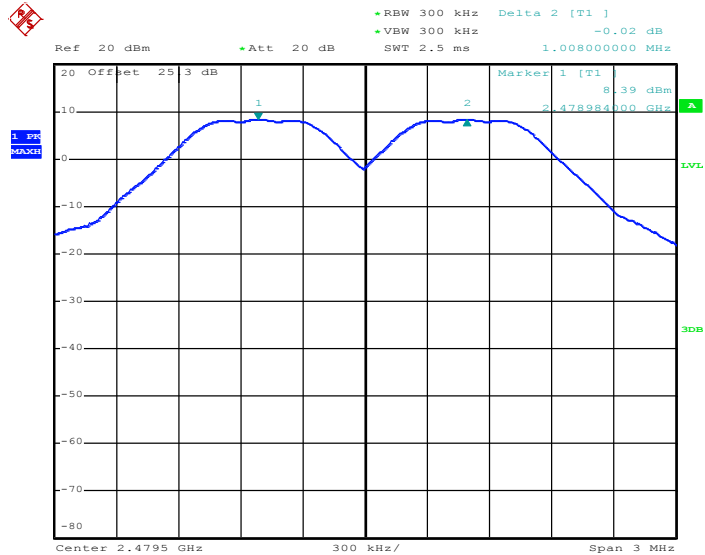

Date: 1.SEP.2015 13:45:58



Test Mode :	2Mbps	Temperature :	24~26°C
Test Engineer :	Tommy Lee	Relative Humidity :	48~51%

Channel	Frequency (MHz)	Frequency Separation (MHz)	(2/3 of 20dB BW) Limits (MHz)	Pass/Fail
00	2402	1.002	0.9040	Pass
39	2441	1.002	0.9040	Pass
78	2480	1.002	0.9080	Pass

Channel Separation Plot on Channel 00 - 01

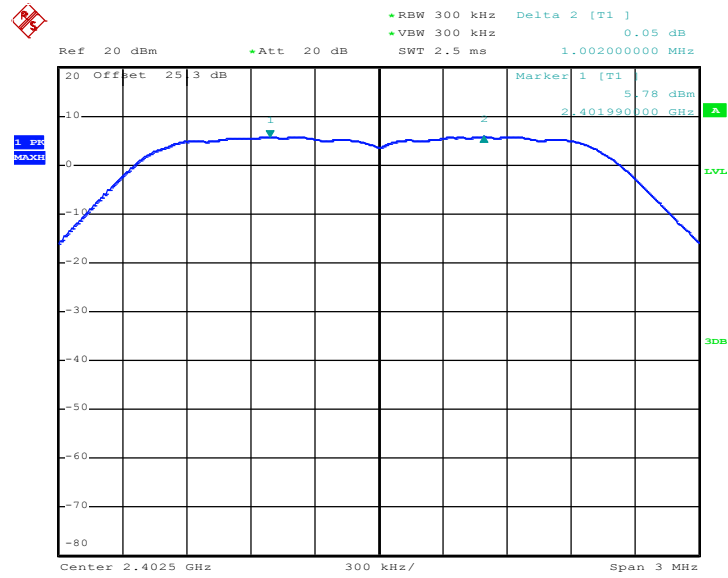

Date: 1.SEP.2015 13:58:09



Channel Separation Plot on Channel 39 - 40

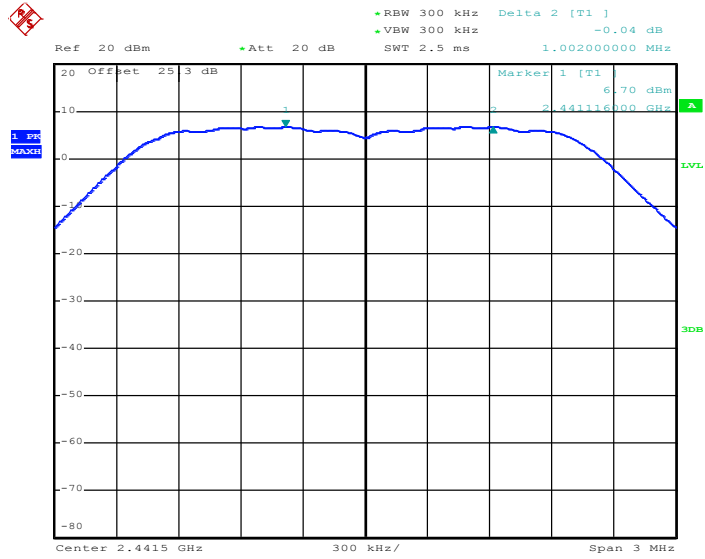

Date: 1.SEP.2015 14:16:20

Channel Separation Plot on Channel 77 - 78

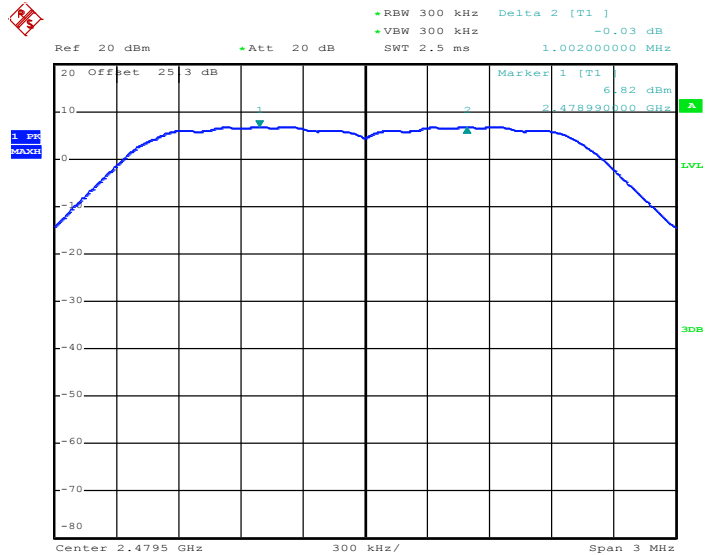

Date: 1.SEP.2015 14:18:54



Test Mode :	3Mbps	Temperature :	24~26°C
Test Engineer :	Tommy Lee	Relative Humidity :	48~51%

Channel	Frequency (MHz)	Frequency Separation (MHz)	(2/3 of 20dB BW) Limits (MHz)	Pass/Fail
00	2402	1.014	0.9080	Pass
39	2441	1.008	0.9160	Pass
78	2480	1.002	0.9200	Pass

Channel Separation Plot on Channel 00 - 01

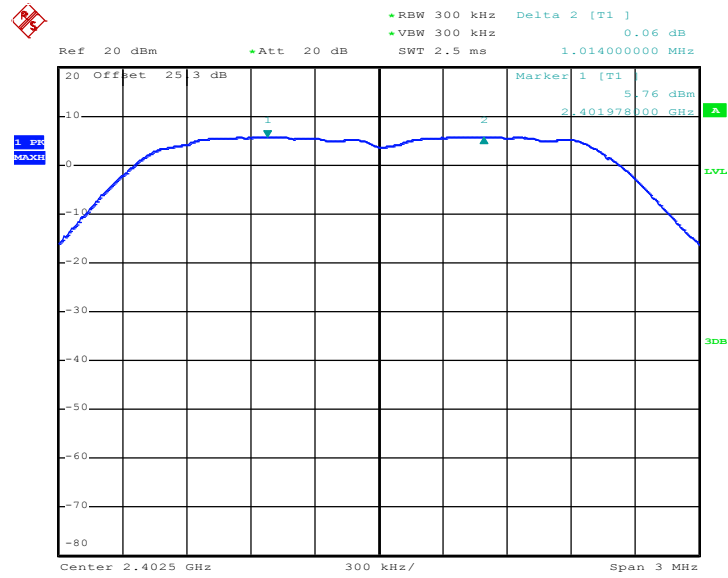

Date: 1.SEP.2015 14:26:32



Channel Separation Plot on Channel 39 - 40

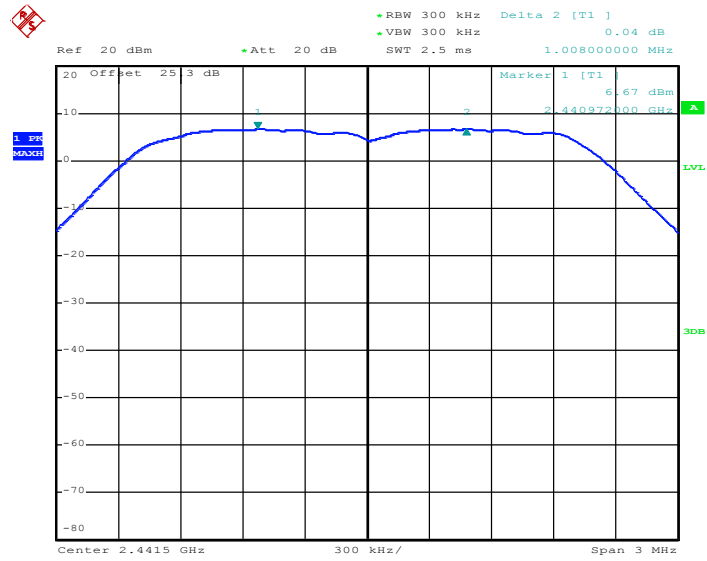

Date: 1.SEP.2015 14:50:05

Channel Separation Plot on Channel 77 - 78

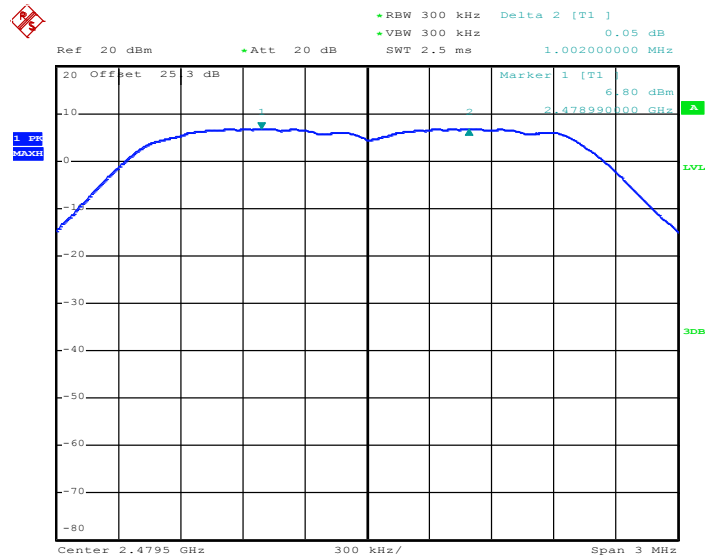

Date: 1.SEP.2015 14:51:43



<Ant. 2>

Test Mode :	1Mbps	Temperature :	24~26°C
Test Engineer :	Tommy Lee	Relative Humidity :	48~51%

Channel	Frequency (MHz)	Frequency Separation (MHz)	(2/3 of 20dB BW) Limits (MHz)	Pass/Fail
00	2402	1.002	0.7013	Pass
39	2441	1.002	0.6987	Pass
78	2480	1.002	0.6987	Pass

Channel Separation Plot on Channel 00 - 01

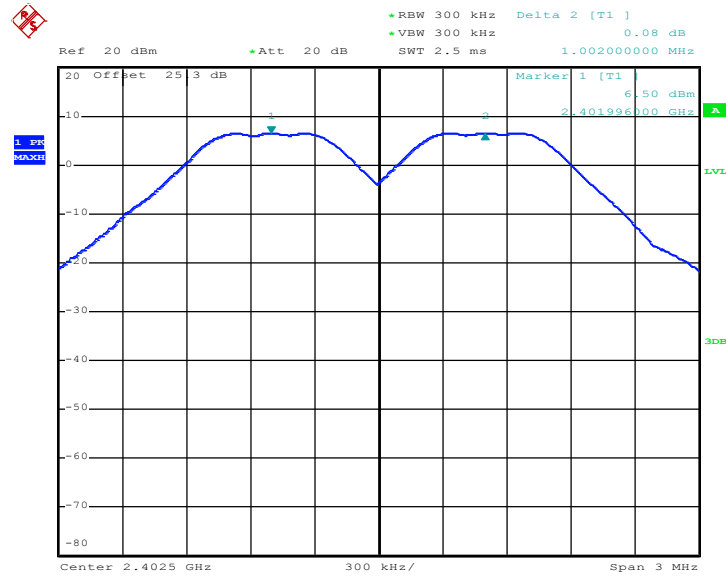

Date: 1.SEP.2015 15:13:59



Channel Separation Plot on Channel 39 - 40

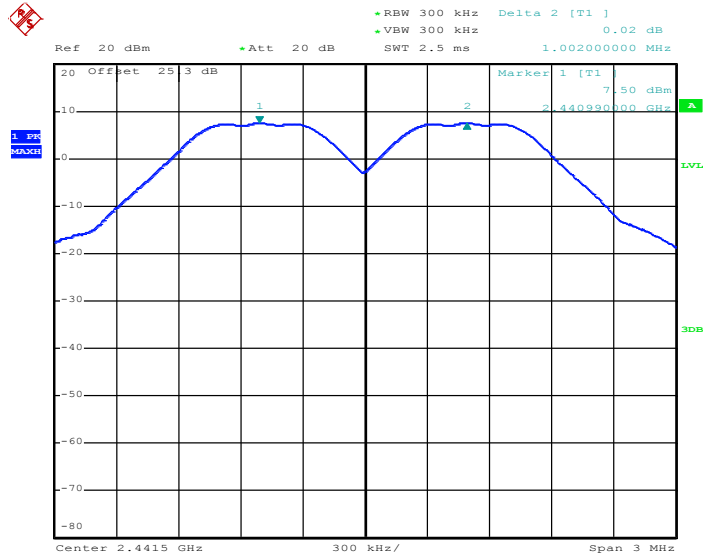

Date: 1.SEP.2015 15:43:18

Channel Separation Plot on Channel 77 - 78

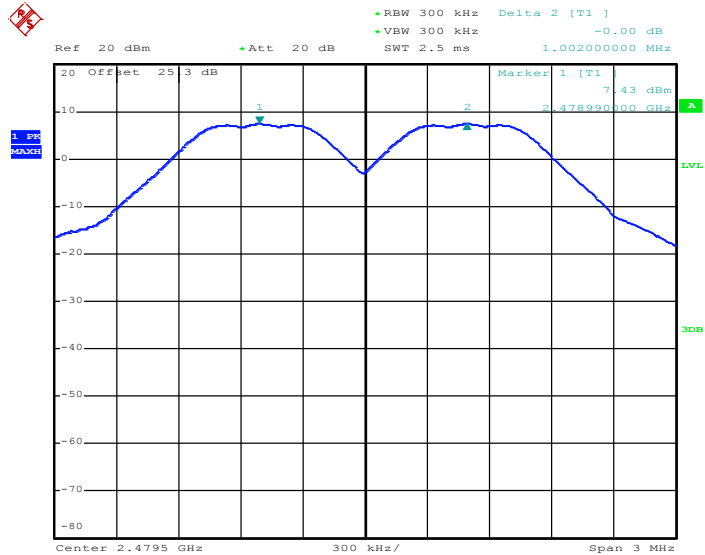

Date: 1.SEP.2015 15:45:24



Test Mode :	2Mbps	Temperature :	24~26°C
Test Engineer :	Tommy Lee	Relative Humidity :	48~51%

Channel	Frequency (MHz)	Frequency Separation (MHz)	(2/3 of 20dB BW) Limits (MHz)	Pass/Fail
00	2402	1.002	0.9040	Pass
39	2441	1.002	0.9040	Pass
78	2480	1.008	0.9200	Pass

Channel Separation Plot on Channel 00 - 01

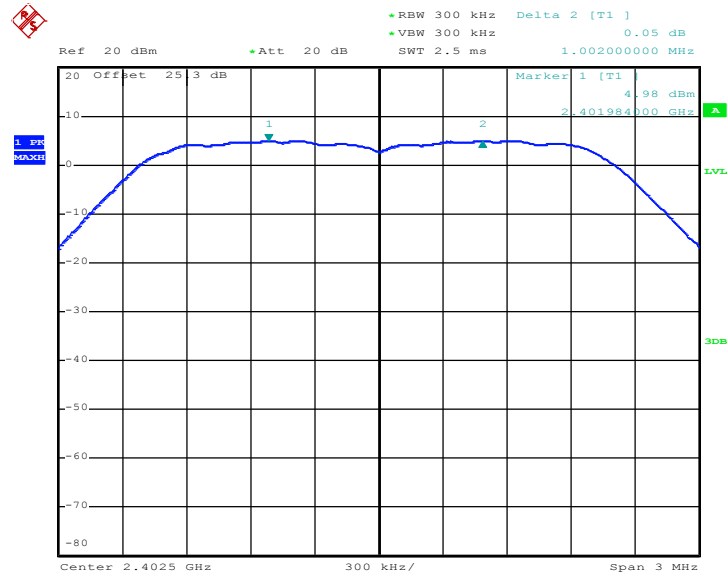

Date: 1.SEP.2015 15:53:30



Channel Separation Plot on Channel 39 - 40

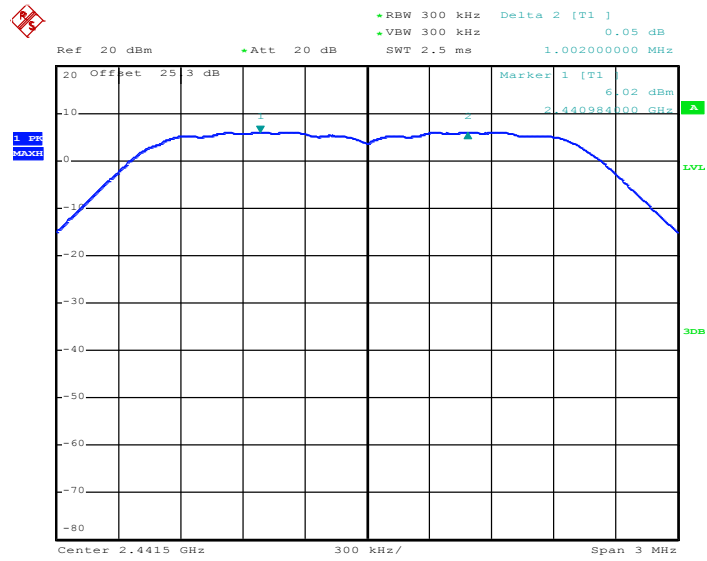

Date: 1.SEP.2015 16:12:19

Channel Separation Plot on Channel 77 - 78

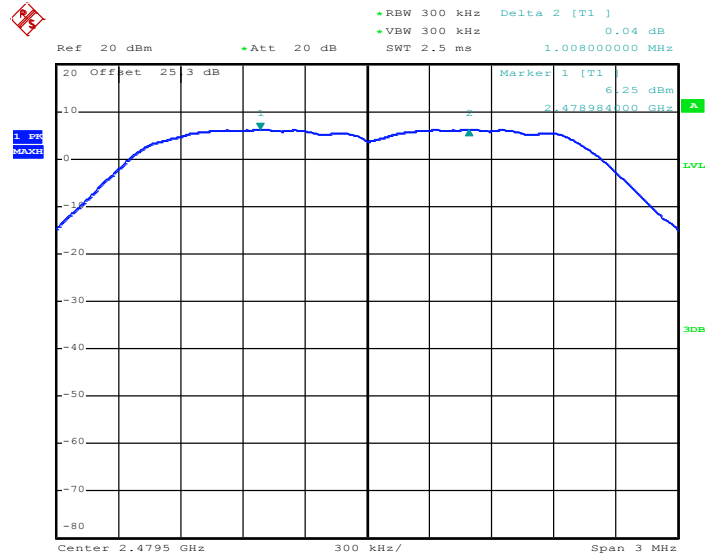

Date: 1.SEP.2015 16:15:13



Test Mode :	3Mbps	Temperature :	24~26°C
Test Engineer :	Tommy Lee	Relative Humidity :	48~51%

Channel	Frequency (MHz)	Frequency Separation (MHz)	(2/3 of 20dB BW) Limits (MHz)	Pass/Fail
00	2402	1.008	0.9080	Pass
39	2441	1.002	0.9160	Pass
78	2480	1.002	0.9200	Pass

Channel Separation Plot on Channel 00 - 01

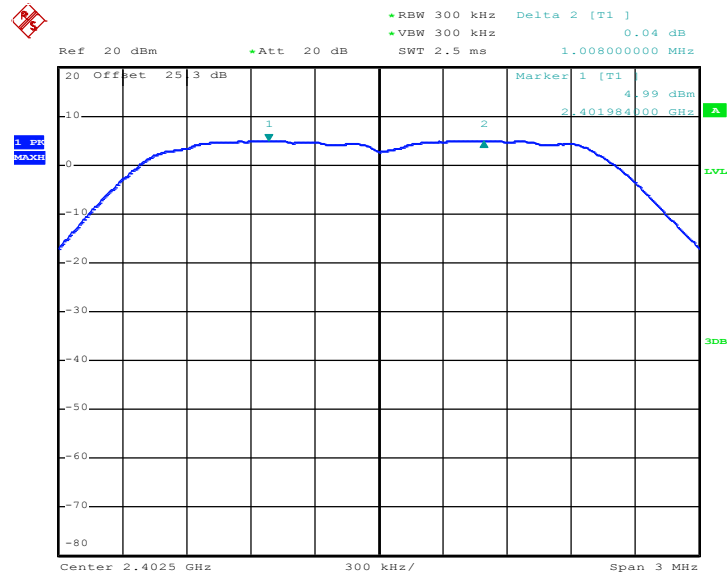

Date: 1.SEP.2015 16:23:02



Channel Separation Plot on Channel 39 - 40

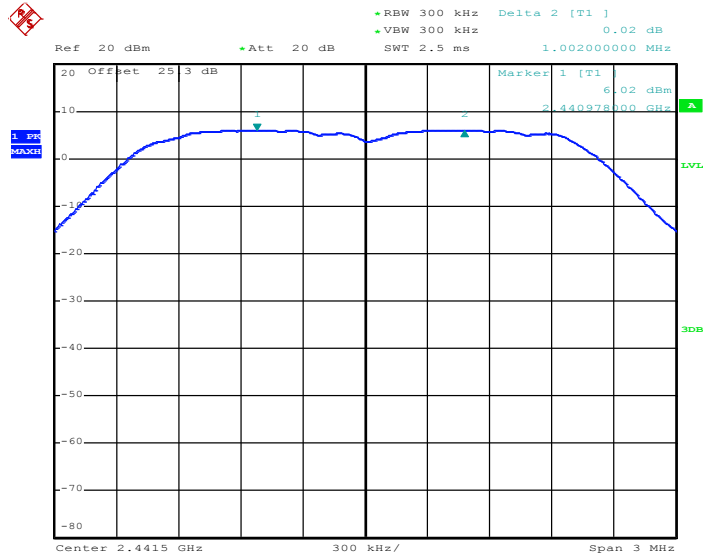

Date: 1.SEP.2015 16:38:50

Channel Separation Plot on Channel 77 - 78

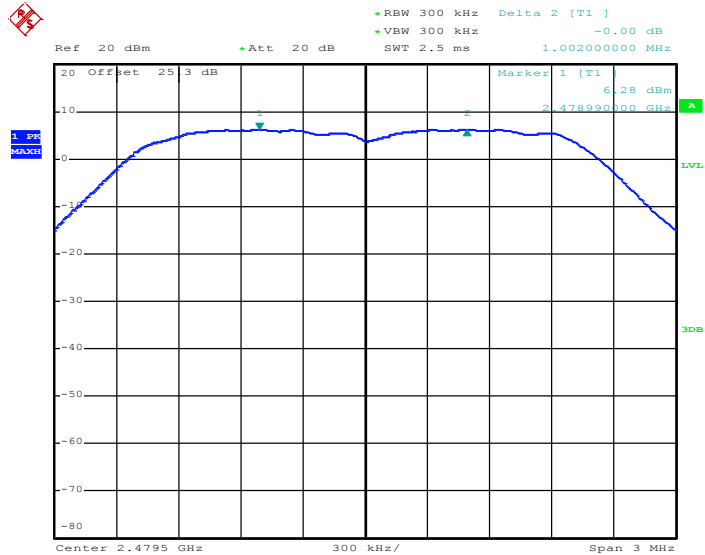

Date: 1.SEP.2015 16:40:29

3.3 Dwell Time Measurement

3.3.1 Limit of Dwell Time

The average time of occupancy on any channel shall not be greater than 0.4 seconds within a period of 0.4 seconds multiplied by the number of hopping channels employed.

3.3.2 Measuring Instruments

The measuring equipment is listed in the section 4 of this test report.

3.3.3 Test Procedures

1. The testing follows ANSI C63.10-2009 clause 7.7.4.
2. The RF output of EUT was connected to the spectrum analyzer by RF cable and attenuator. The path loss was compensated to the results for each measurement.
3. Set to the maximum power setting and enable the EUT transmit continuously.
4. Enable the EUT hopping function.
5. Use the following spectrum analyzer settings: Span = zero span, centered on a hopping channel; RBW = 1 MHz; VBW \geq RBW; Sweep = as necessary to capture the entire dwell time per hopping channel; Detector function = peak; Trace = max hold.
6. Measure and record the results in the test report.

3.3.4 Test Setup

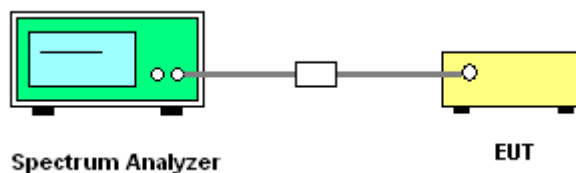



3.3.5 Test Result of Dwell Time

<Ant. 1>

Test Mode :	DH5	Temperature :	24~26°C
Test Engineer :	Tommy Lee	Relative Humidity :	48~51%

Mode	Hopping Channel Number	Hops Over Occupancy Time(hops)	Package Transfer Time (msec)	Dwell Time (sec)	Limits (sec)	Pass/Fail
Normal	79	106.67	2.90	0.31	0.4	Pass
AFH	20	53.34	2.90	0.15	0.4	Pass

<Ant. 2>

Test Mode :	DH5	Temperature :	24~26°C
Test Engineer :	Tommy Lee	Relative Humidity :	48~51%

Mode	Hopping Channel Number	Hops Over Occupancy Time(hops)	Package Transfer Time (msec)	Dwell Time (sec)	Limits (sec)	Pass/Fail
Normal	79	106.67	2.90	0.31	0.4	Pass
AFH	20	53.34	2.90	0.15	0.4	Pass

Remark:

- In normal mode, hopping rate is 1600 hops/s with 6 slots in 79 hopping channels.
With channel hopping rate (1600 / 6 / 79) in Occupancy Time Limit (0.4 x 79) (s),
Hops Over Occupancy Time comes to (1600 / 6 / 79) x (0.4 x 79) = 106.67 hops.
- In AFH mode, hopping rate is 800 hops/s with 6 slots in 20 hopping channels.
With channel hopping rate (800 / 6 / 20) in Occupancy Time Limit (0.4 x 20) (s),
Hops Over Occupancy Time comes to (800 / 6 / 20) x (0.4 x 20) = 53.33 hops.
- Dwell Time(s) = Hops Over Occupancy Time (hops) x Package Transfer Time



Package Transfer Time Plot for Ant. 1

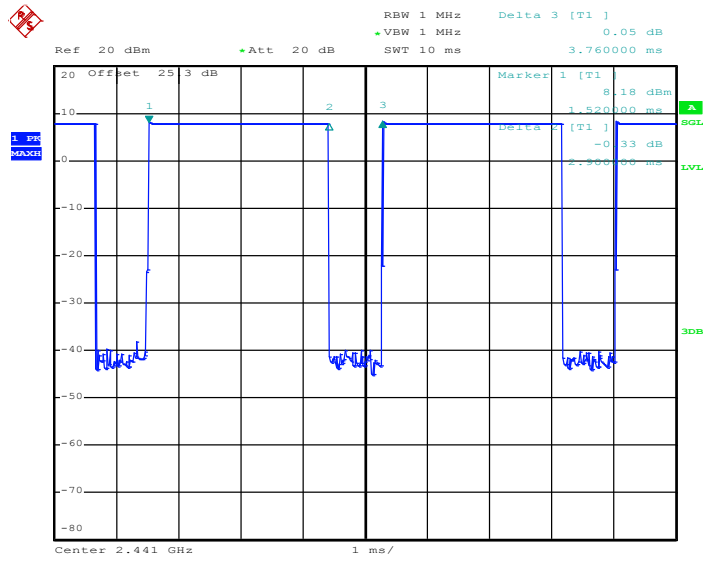

Date: 27.AUG.2015 14:33:41

Package Transfer Time Plot for Ant. 2

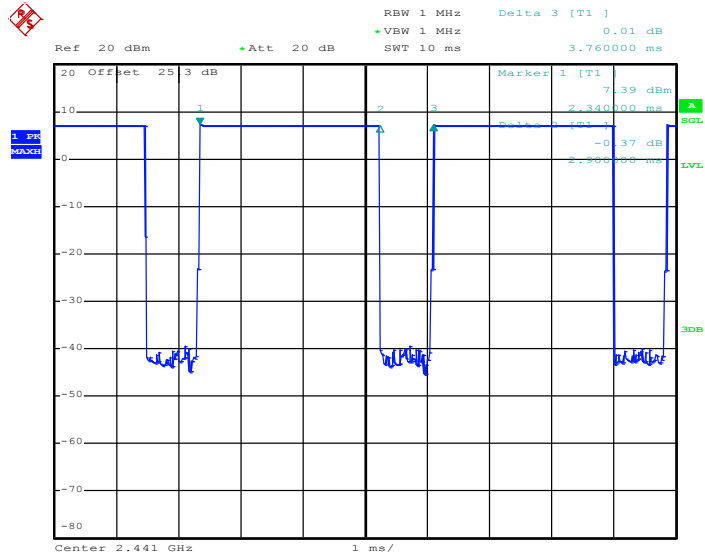

Date: 27.AUG.2015 16:25:07

3.4 20dB Bandwidth Measurement

3.4.1 Limit of 20dB Bandwidth

Reporting only

3.4.2 Measuring Instruments

The measuring equipment is listed in the section 4 of this test report.

3.4.3 Test Procedures

1. The testing follows ANSI C63.10-2009 clause 6.9.1.
2. The RF output of EUT was connected to the spectrum analyzer by RF cable and attenuator. The path loss was compensated to the results for each measurement.
3. Set to the maximum power setting and enable the EUT transmit continuously.
4. Use the following spectrum analyzer settings for 20dB Bandwidth measurement.
Span = approximately 2 to 5 times the 20 dB bandwidth, centered on a hopping channel;
RBW \geq 1% of the 20 dB bandwidth; VBW \geq RBW; Sweep = auto; Detector function = peak;
Trace = max hold.
5. Measure and record the results in the test report.

3.4.4 Test Setup

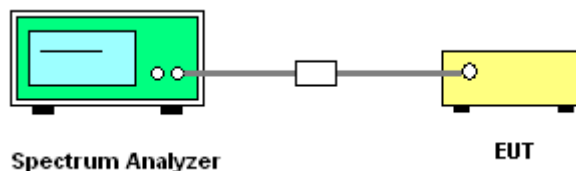



3.4.5 Test Result of 20dB Bandwidth

<Ant. 1>

Test Mode :	1Mbps	Temperature :	24~26°C
Test Engineer :	Tommy Lee	Relative Humidity :	48~51%

Channel	Frequency (MHz)	20dB Bandwidth (MHz)
00	2402	1.048
39	2441	1.048
78	2480	1.052

20 dB Bandwidth Plot on Channel 00

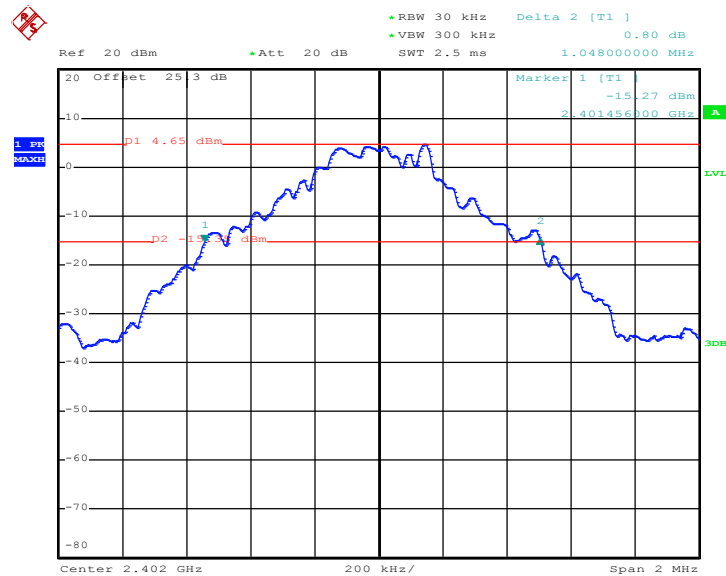

Date: 2.SEP.2015 19:42:34



20 dB Bandwidth Plot on Channel 39

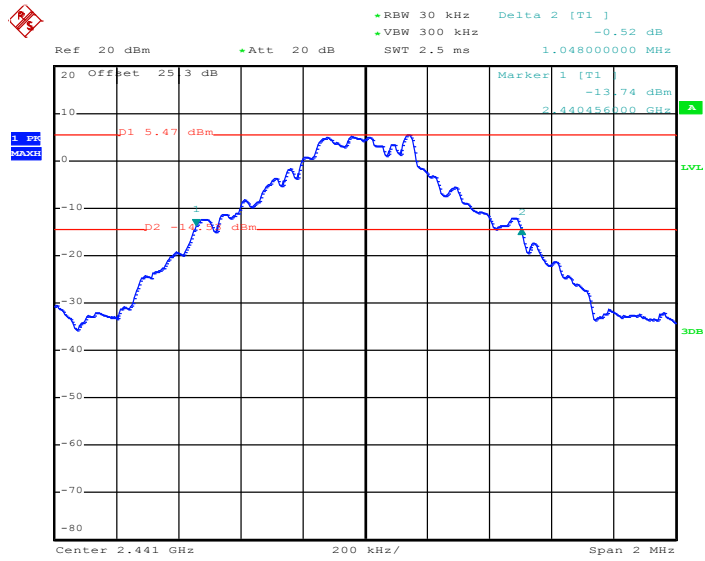

Date: 2.SEP.2015 19:49:24

20 dB Bandwidth Plot on Channel 78

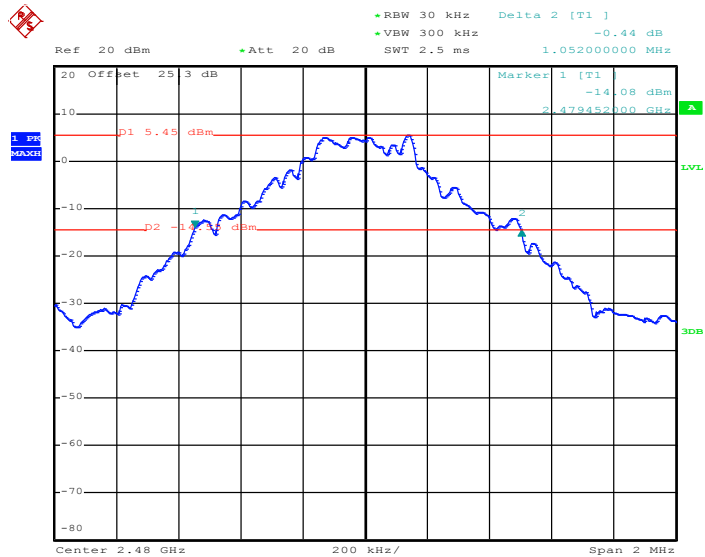

Date: 2.SEP.2015 19:51:30



Test Mode :	2Mbps	Temperature :	24~26°C
Test Engineer :	Tommy Lee	Relative Humidity :	48~51%

Channel	Frequency (MHz)	20dB Bandwidth (MHz)
00	2402	1.356
39	2441	1.356
78	2480	1.362

20 dB Bandwidth Plot on Channel 00

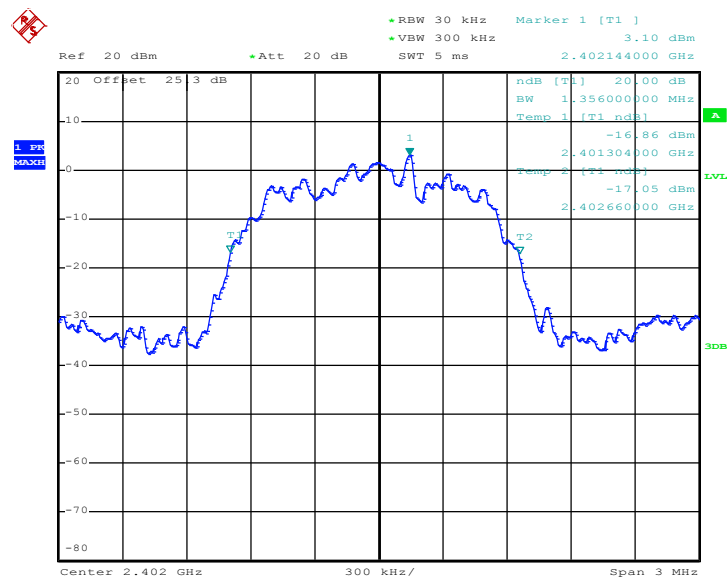

Date: 1.SEP.2015 13:53:00



20 dB Bandwidth Plot on Channel 39

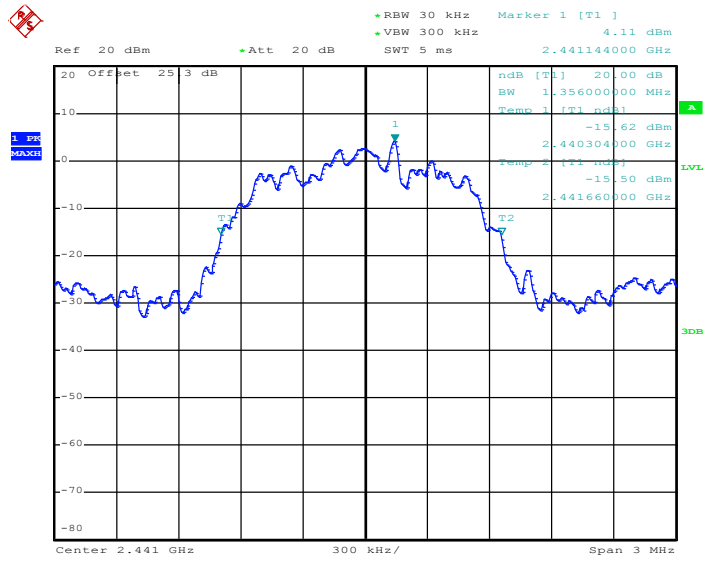

Date: 1.SEP.2015 14:10:11

20 dB Bandwidth Plot on Channel 78

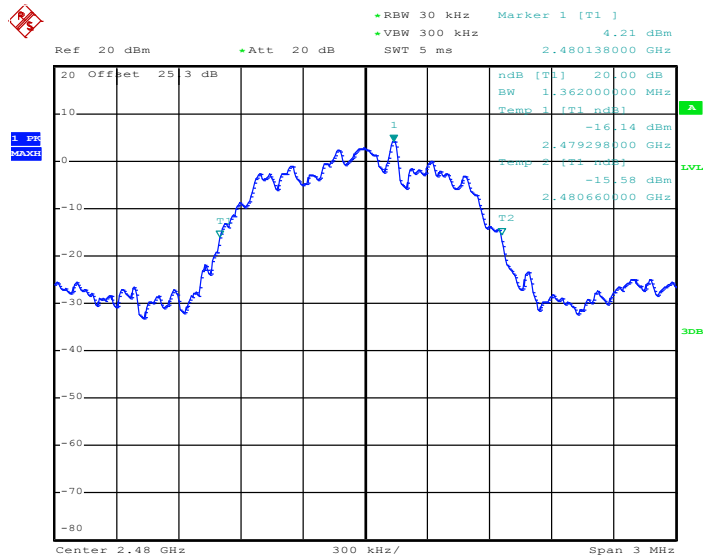

Date: 1.SEP.2015 14:20:14



Test Mode :	3Mbps	Temperature :	24~26°C
Test Engineer :	Tommy Lee	Relative Humidity :	48~51%

Channel	Frequency (MHz)	20dB Bandwidth (MHz)
00	2402	1.362
39	2441	1.374
78	2480	1.380

20 dB Bandwidth Plot on Channel 00

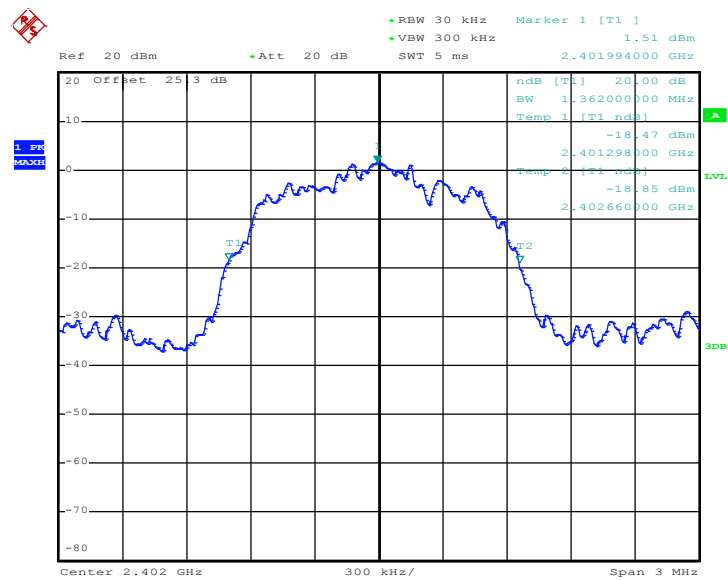

Date: 1.SEP.2015 14:23:34



20 dB Bandwidth Plot on Channel 39

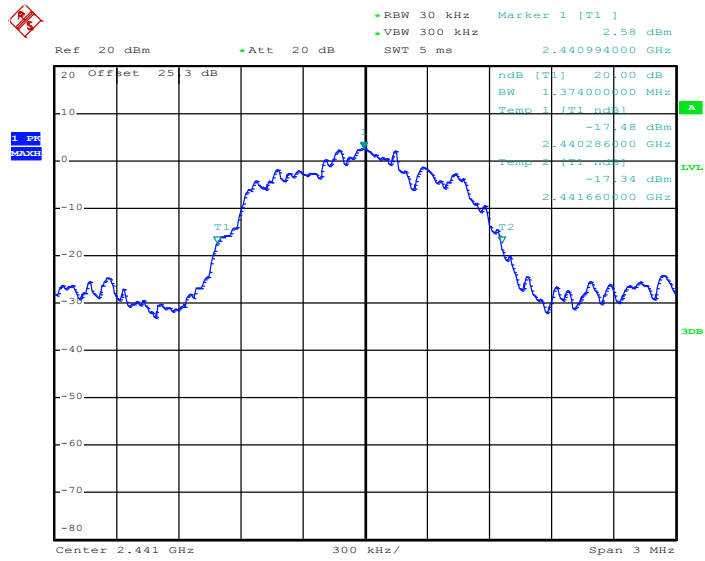

Date: 1.SEP.2015 14:44:48

20 dB Bandwidth Plot on Channel 78

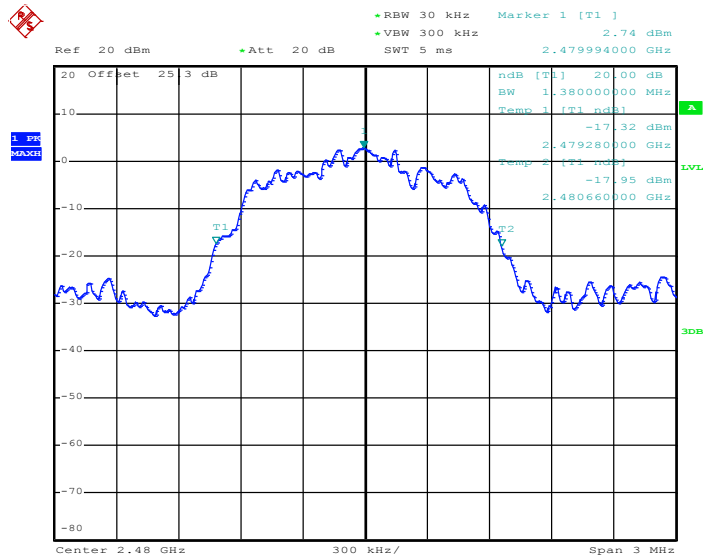

Date: 1.SEP.2015 14:52:09



<Ant. 2>

Test Mode :	1Mbps	Temperature :	24~26°C
Test Engineer :	Tommy Lee	Relative Humidity :	48~51%

Channel	Frequency (MHz)	20dB Bandwidth (MHz)
00	2402	1.052
39	2441	1.048
78	2480	1.048

20 dB Bandwidth Plot on Channel 00

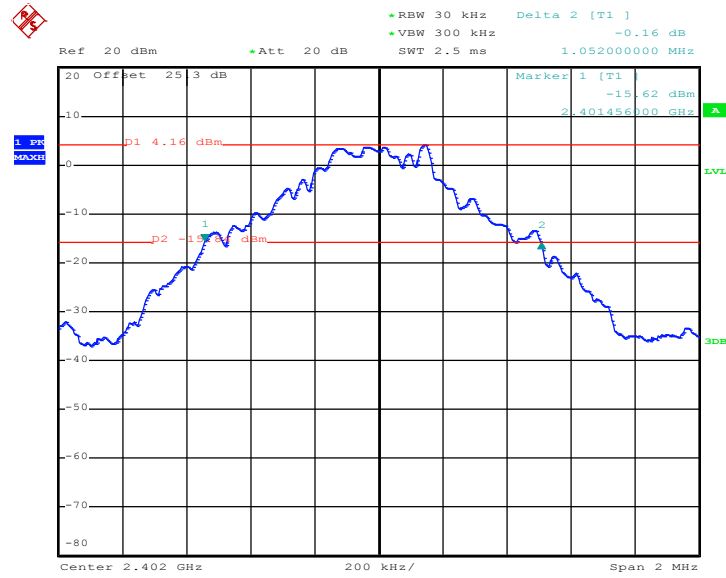

Date: 2.SEP.2015 19:58:50



20 dB Bandwidth Plot on Channel 39

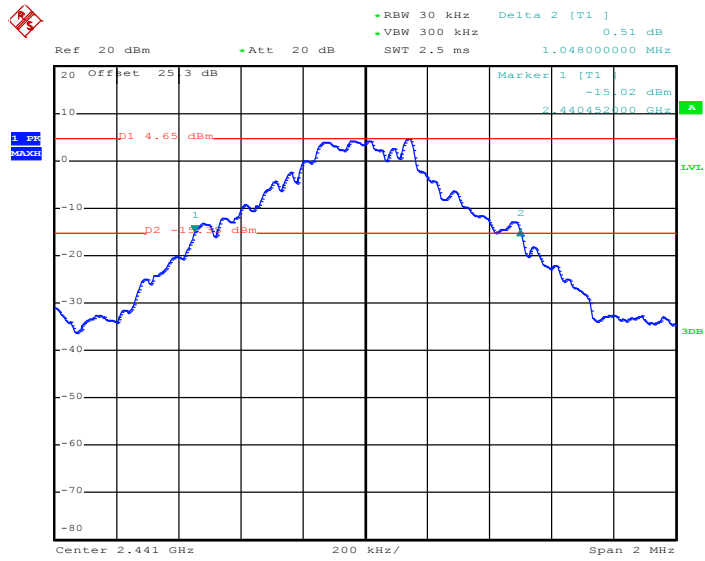

Date: 2.SEP.2015 20:01:30

20 dB Bandwidth Plot on Channel 78

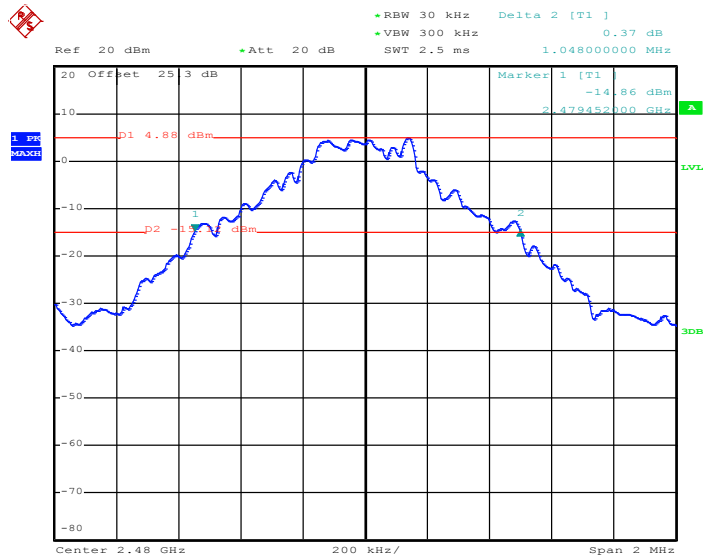

Date: 2.SEP.2015 20:05:30



Test Mode :	2Mbps	Temperature :	24~26°C
Test Engineer :	Tommy Lee	Relative Humidity :	48~51%

Channel	Frequency (MHz)	20dB Bandwidth (MHz)
00	2402	1.356
39	2441	1.356
78	2480	1.380

20 dB Bandwidth Plot on Channel 00

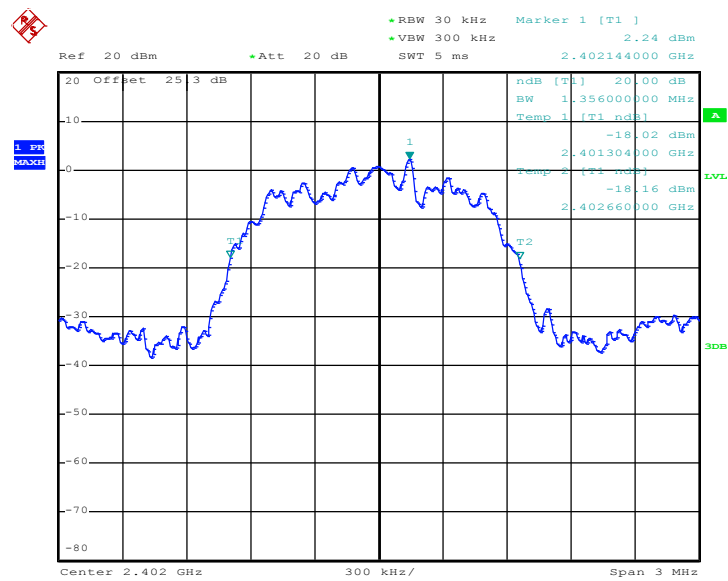

Date: 1.SEP.2015 15:49:57



20 dB Bandwidth Plot on Channel 39

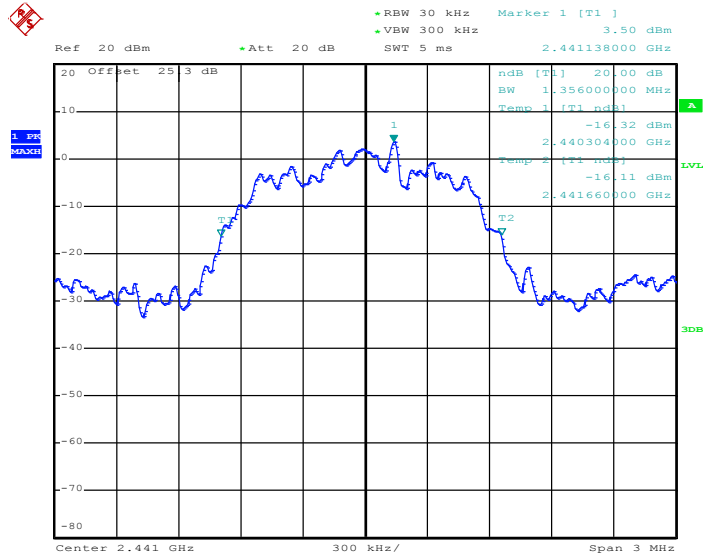

Date: 1.SEP.2015 16:08:06

20 dB Bandwidth Plot on Channel 78

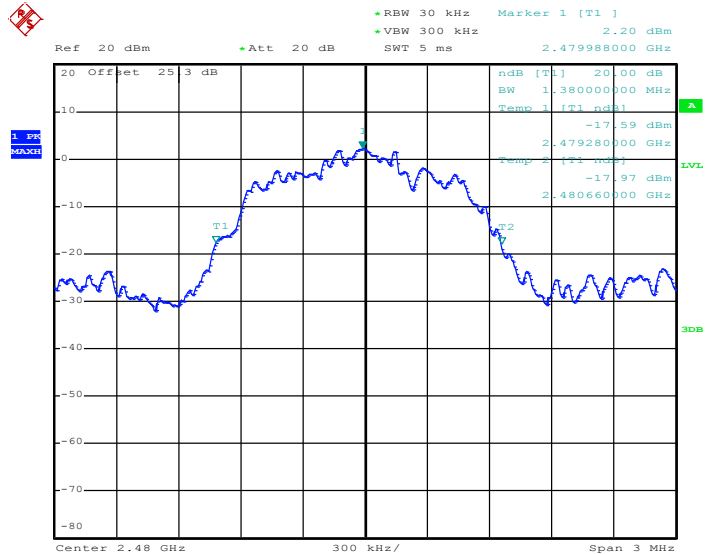

Date: 1.SEP.2015 16:16:04



Test Mode :	3Mbps	Temperature :	24~26°C
Test Engineer :	Tommy Lee	Relative Humidity :	48~51%

Channel	Frequency (MHz)	20dB Bandwidth (MHz)
00	2402	1.362
39	2441	1.374
78	2480	1.380

20 dB Bandwidth Plot on Channel 00

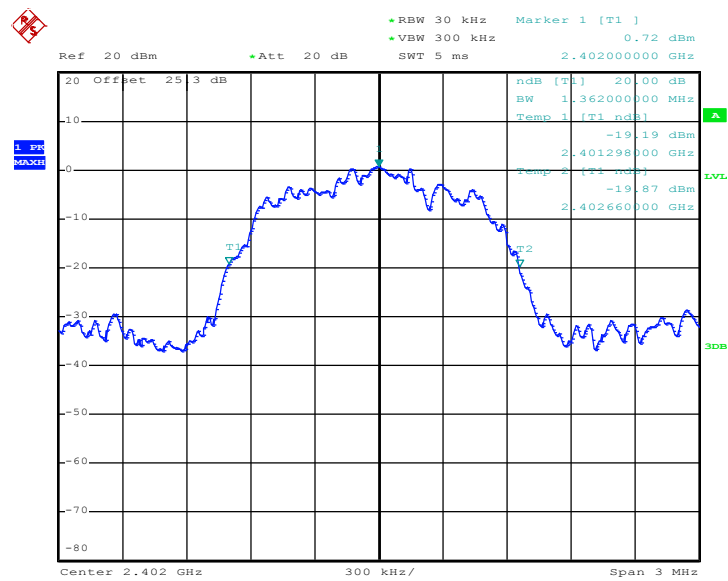

Date: 1.SEP.2015 16:19:59



20 dB Bandwidth Plot on Channel 39

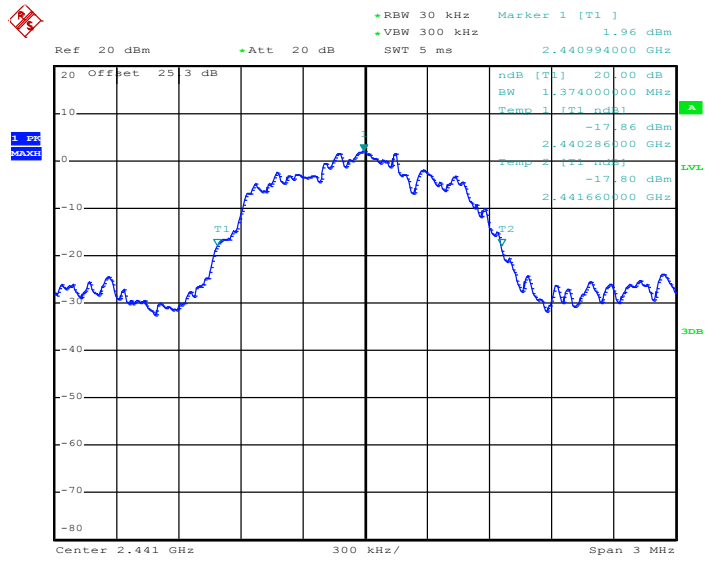

Date: 1.SEP.2015 16:35:53

20 dB Bandwidth Plot on Channel 78

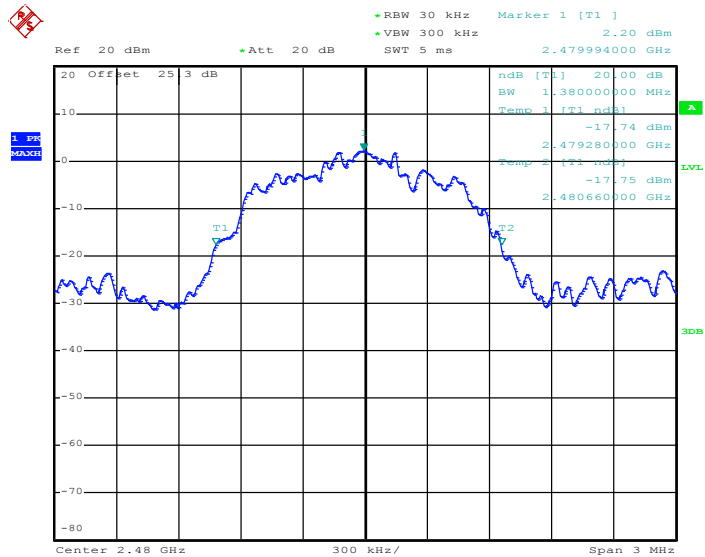

Date: 1.SEP.2015 16:40:55

3.5 Peak Output Power Measurement

3.5.1 Limit of Peak Output Power

Section 15.247 (b) The maximum peak conducted output power of the intentional radiator shall not exceed the following: (1) For frequency hopping systems operating in the 2400-2483.5 MHz band employing at least 75 non-overlapping hopping channels, and all frequency hopping systems in the 5725-5850 MHz band: 1 watt. For all other frequency hopping systems in the 2400-2483.5 MHz band 0.125 watts. The power limit for 1Mbps is 1watt, and for 2Mbps, 3Mbps and AFH are 0.125 watts.

3.5.2 Measuring Instruments

The measuring equipment is listed in the section 4 of this test report.

3.5.3 Test Procedures

1. The testing follows ANSI C63.10-2009 clause 6.10.1.
2. The RF output of EUT was connected to the power meter by RF cable and attenuator. The path loss was compensated to the results for each measurement.
3. Set to the maximum power setting and enable the EUT transmit continuously.
4. Measure the conducted output power with cable loss and record the results in the test report.
5. Measure and record the results in the test report.

3.5.4 Test Setup

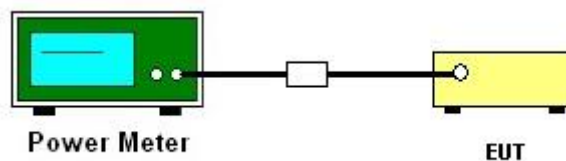



3.5.5 Test Result of Peak Output Power

<Ant. 1>

Test Mode :	1Mbps	Temperature :	24~26°C
Test Engineer :	Tommy Lee	Relative Humidity :	48~51%

Channel	Frequency (MHz)	RF Power (dBm)		
		GFSK	Max. Limits (dBm)	Pass/Fail
		1 Mbps		
00	2402	8.10	20.97	Pass
39	2441	9.01	20.97	Pass
78	2480	9.00	20.97	Pass

Note: For AFH mode using 20 hopping channels, the maximum output power limit is 20.97dBm.

Test Mode :	2Mbps	Temperature :	24~26°C
Test Engineer :	Tommy Lee	Relative Humidity :	48~51%

Channel	Frequency (MHz)	RF Power (dBm)		
		$\pi/4$ -DQPSK	Max. Limits (dBm)	Pass/Fail
		2 Mbps		
00	2402	8.31	20.97	Pass
39	2441	8.92	20.97	Pass
78	2480	8.70	20.97	Pass

Test Mode :	3Mbps	Temperature :	24~26°C
Test Engineer :	Tommy Lee	Relative Humidity :	48~51%

Channel	Frequency (MHz)	RF Power (dBm)		
		8-DPSK	Max. Limits (dBm)	Pass/Fail
		3 Mbps		
00	2402	8.63	20.97	Pass
39	2441	8.94	20.97	Pass
78	2480	8.84	20.97	Pass



<Ant. 2>

Test Mode :	1Mbps	Temperature :	24~26°C
Test Engineer :	Tommy Lee	Relative Humidity :	48~51%

Channel	Frequency (MHz)	RF Power (dBm)		
		GFSK	Max. Limits (dBm)	Pass/Fail
		1 Mbps		
00	2402	7.22	20.97	Pass
39	2441	8.14	20.97	Pass
78	2480	8.00	20.97	Pass

Note: For AFH mode using 20 hopping channels, the maximum output power limit is 20.97dBm.

Test Mode :	2Mbps	Temperature :	24~26°C
Test Engineer :	Tommy Lee	Relative Humidity :	48~51%

Channel	Frequency (MHz)	RF Power (dBm)		
		$\pi/4$ -DQPSK	Max. Limits (dBm)	Pass/Fail
		2 Mbps		
00	2402	7.69	20.97	Pass
39	2441	8.10	20.97	Pass
78	2480	7.78	20.97	Pass

Test Mode :	3Mbps	Temperature :	24~26°C
Test Engineer :	Tommy Lee	Relative Humidity :	48~51%

Channel	Frequency (MHz)	RF Power (dBm)		
		8-DPSK	Max. Limits (dBm)	Pass/Fail
		3 Mbps		
00	2402	7.68	20.97	Pass
39	2441	8.13	20.97	Pass
78	2480	7.79	20.97	Pass

3.6 Conducted Band Edges Measurement

3.6.1 Limit of Band Edges

In any 100 kHz bandwidth outside the intentional radiation frequency band, the radio frequency power shall be at least 20 dB below the highest level of the radiated power. In addition, radiated emissions which fall in the restricted bands must also comply with the radiated emission limits.

3.6.2 Measuring Instruments

The measuring equipment is listed in the section 4 of this test report.

3.6.3 Test Procedures

1. The testing follows ANSI C63.10-2009 clause 7.7.9.
2. Set to the maximum power setting and enable the EUT transmit continuously.
3. Set RBW $\geq 1\%$ of spectrum analyzer display span, VBW \geq RBW. Band edge emissions must be at least 20 dB down from the highest emission level within the authorized band as measured with a 100kHz RBW. The attenuation shall be 30 dB instead of 20 dB when RMS conducted output power procedure is used.
4. Enable hopping function of the EUT and then repeat step 2. and 3.
5. Measure and record the results in the test report.

3.6.4 Test Setup

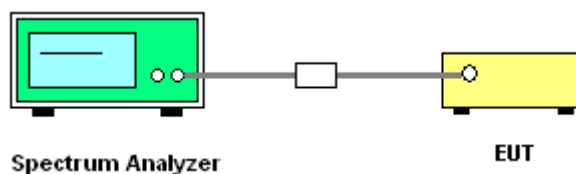



3.6.5 Test Result of Conducted Band Edges

<Ant. 1>

Test Mode :	1Mbps	Temperature :	24~26°C
Test Channel :	00 and 78	Relative Humidity :	48~51%
		Test Engineer :	Tommy Lee

Low Band Edge Plot on Channel 00

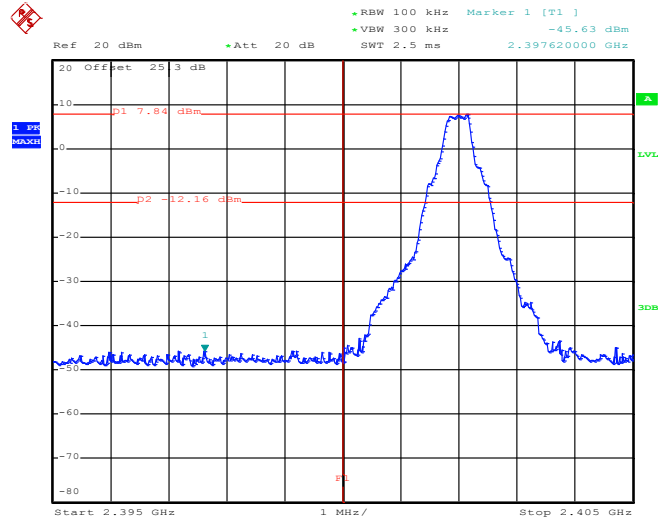

Date: 1.SEP.2015 11:55:46

High Band Edge Plot on Channel 78

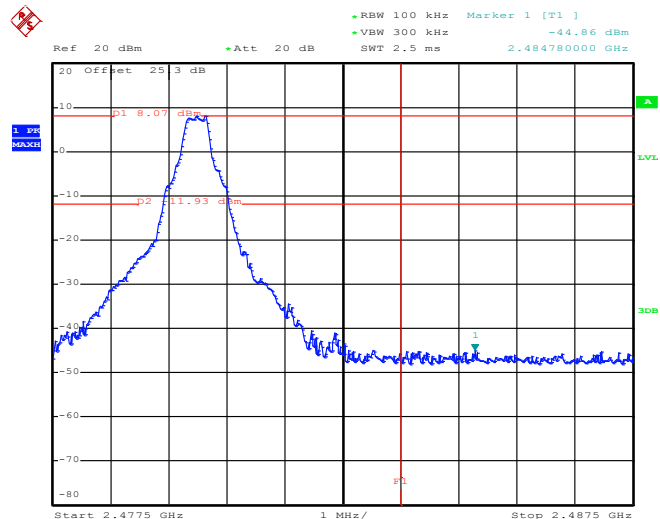

Date: 11.SEP.2015 20:42:57



Test Mode :	2Mbps	Temperature :	24~26°C
Test Channel :	00 and 78	Relative Humidity :	48~51%
		Test Engineer :	Tommy Lee

Low Band Edge Plot on Channel 00

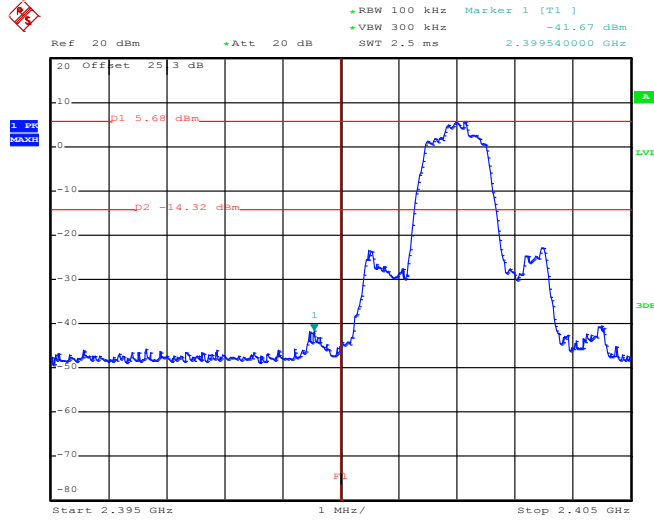

Date: 1.SEP.2015 14:07:53

High Band Edge Plot on Channel 78

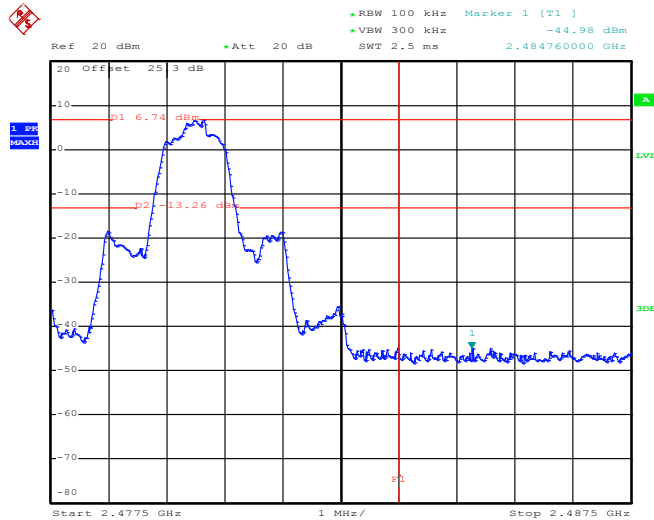

Date: 11.SEP.2015 20:44:38



Test Mode :	3Mbps	Temperature :	24~26°C
Test Channel :	00 and 78	Relative Humidity :	48~51%
		Test Engineer :	Tommy Lee

Low Band Edge Plot on Channel 00

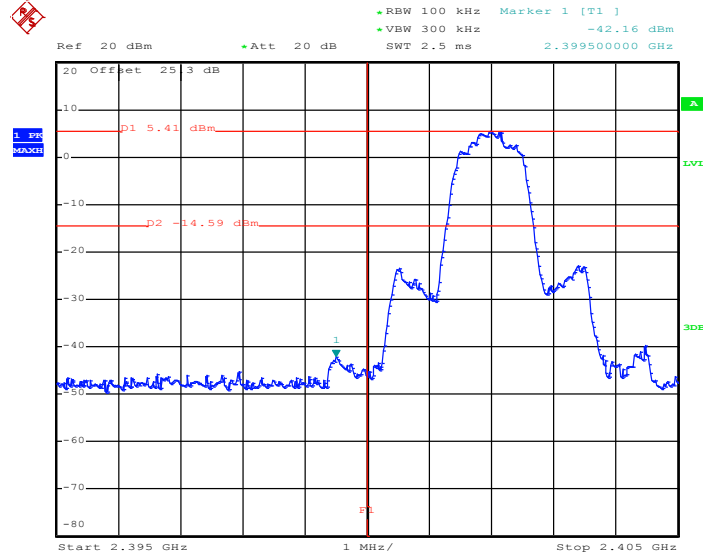

Date: 1.SEP.2015 14:41:42

High Band Edge Plot on Channel 78

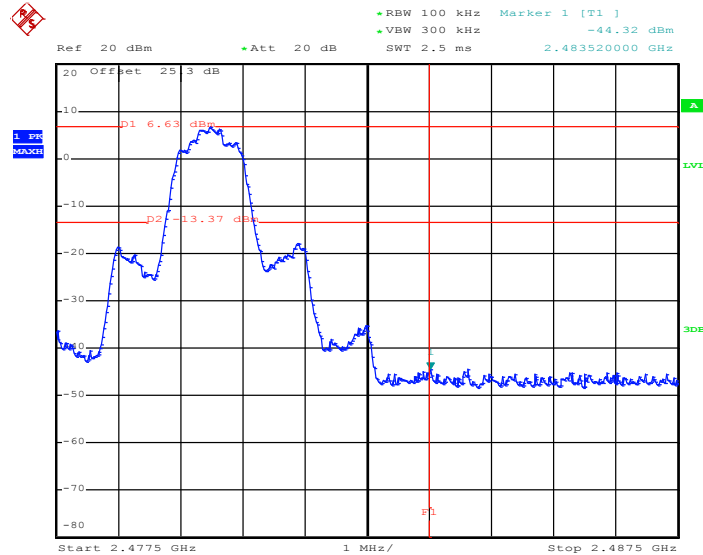

Date: 11.SEP.2015 20:46:21



<Ant. 2>

Test Mode :	1Mbps	Temperature :	24~26°C
Test Channel :	00 and 78	Relative Humidity :	48~51%
		Test Engineer :	Tommy Lee

Low Band Edge Plot on Channel 00

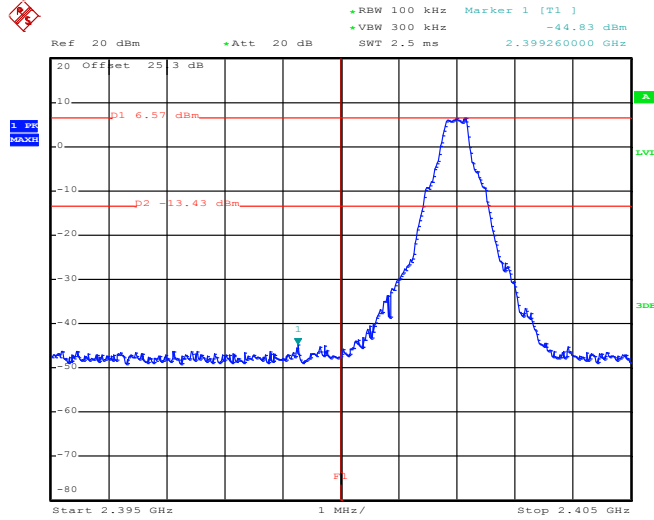

Date: 1.SEP.2015 15:32:09

High Band Edge Plot on Channel 78

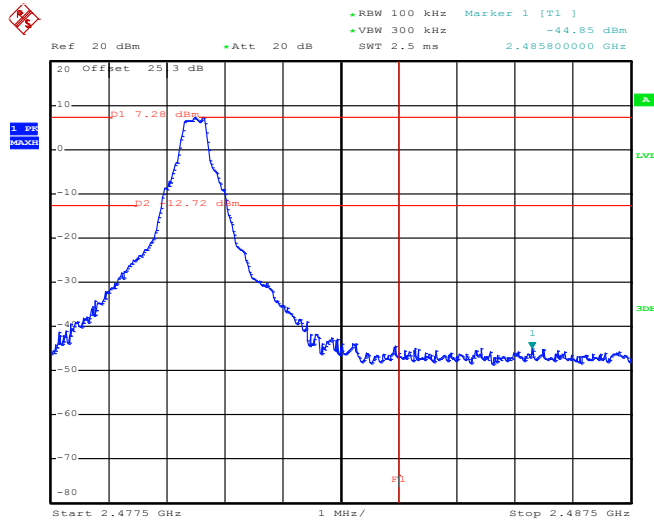

Date: 11.SEP.2015 21:35:14



Test Mode :	2Mbps	Temperature :	24~26°C
Test Channel :	00 and 78	Relative Humidity :	48~51%
		Test Engineer :	Tommy Lee

Low Band Edge Plot on Channel 00

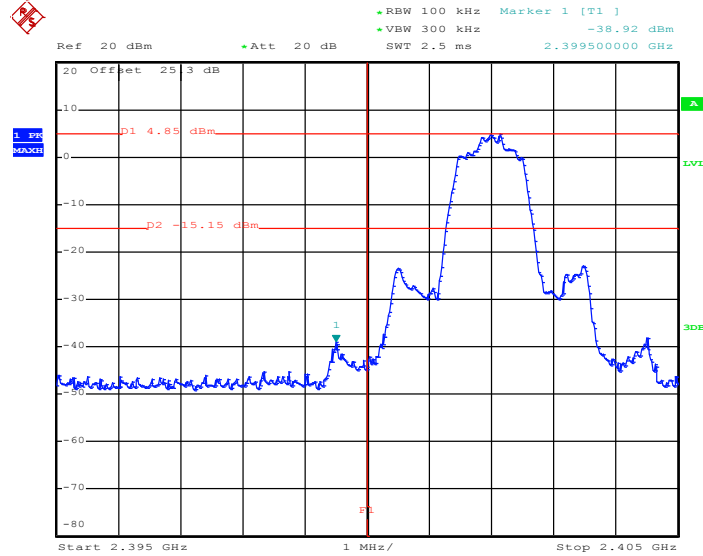

Date: 1.SEP.2015 16:02:42

High Band Edge Plot on Channel 78

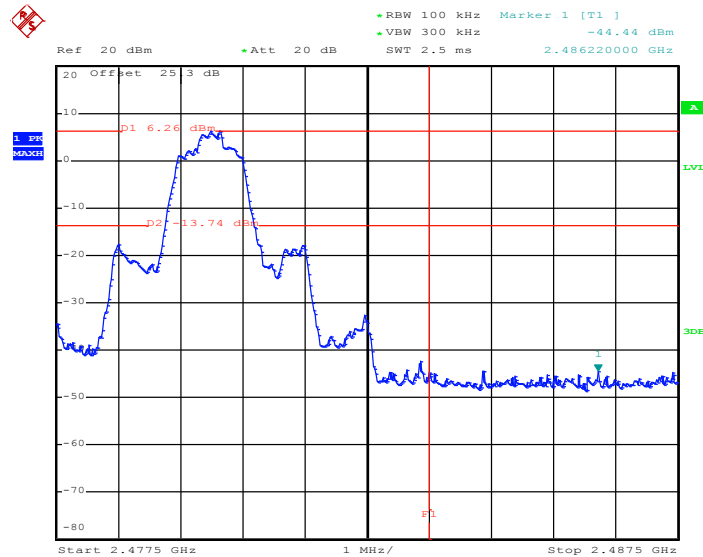

Date: 11.SEP.2015 21:36:12



Test Mode :	3Mbps	Temperature :	24~26°C
Test Channel :	00 and 78	Relative Humidity :	48~51%
		Test Engineer :	Tommy Lee

Low Band Edge Plot on Channel 00

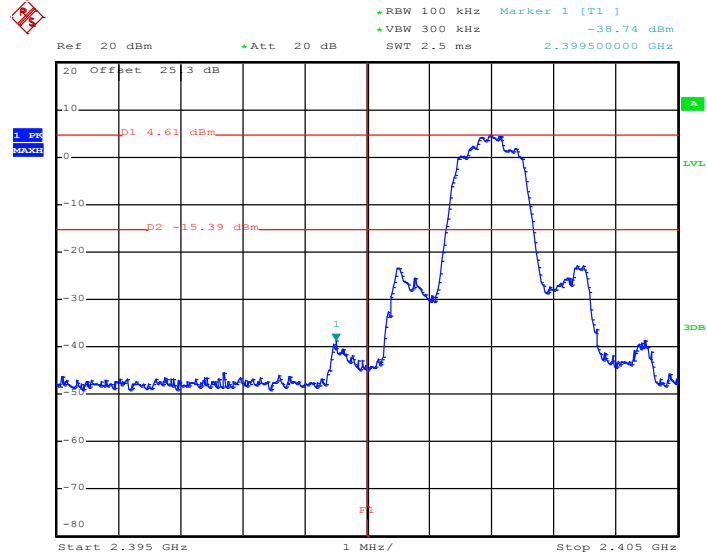

Date: 1.SEP.2015 16:28:59

High Band Edge Plot on Channel 78

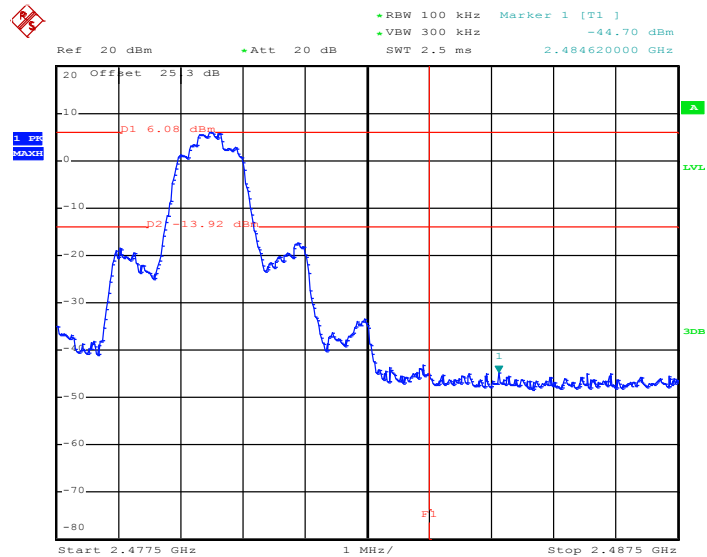

Date: 11.SEP.2015 21:38:03



3.6.6 Test Result of Conducted Hopping Mode Band Edges

<Ant. 1>

Test Mode :	1Mbps	Temperature :	24~26°C
Test Engineer :	Tommy Lee	Relative Humidity :	48~51%

1Mbps Hopping Mode Low Band Edge Plot

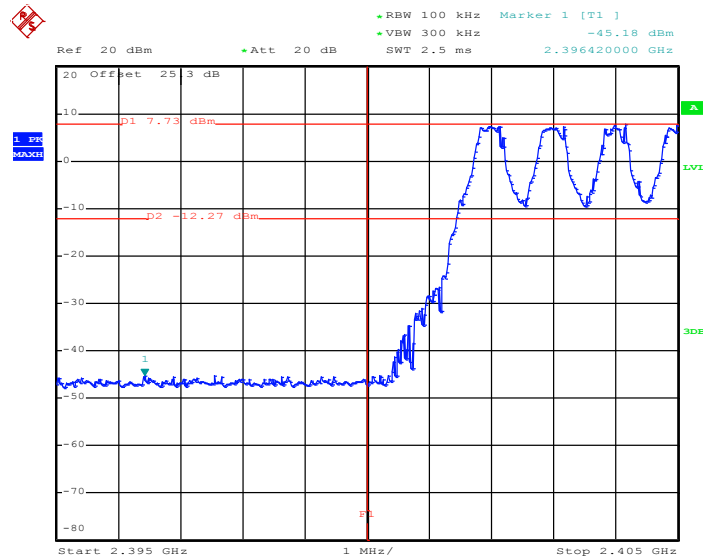

Date: 1.SEP.2015 11:45:00

1Mbps Hopping Mode High Band Edge Plot

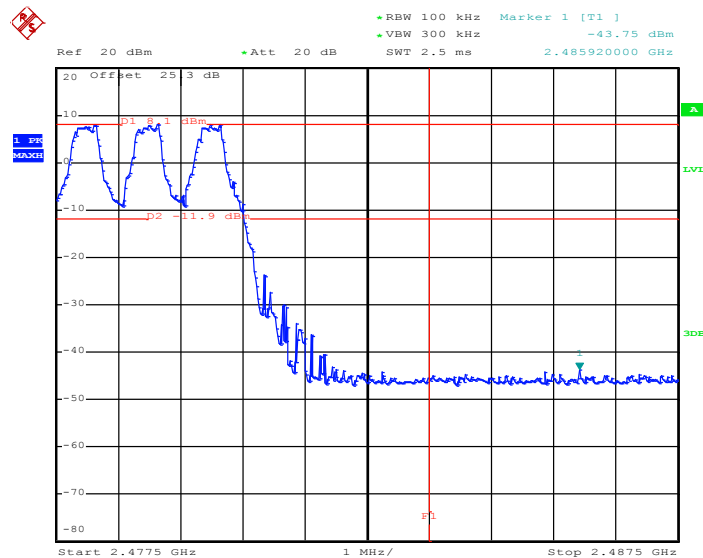

Date: 11.SEP.2015 20:49:56



Test Mode :	2Mbps	Temperature :	24~26°C
Test Engineer :	Tommy Lee	Relative Humidity :	48~51%

2Mbps Hopping Mode Low Band Edge Plot

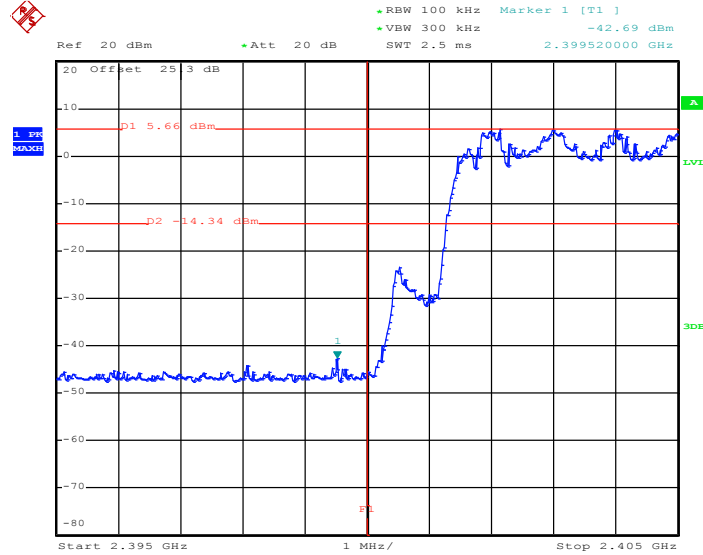

Date: 1.SEP.2015 14:01:36

2Mbps Hopping Mode High Band Edge Plot

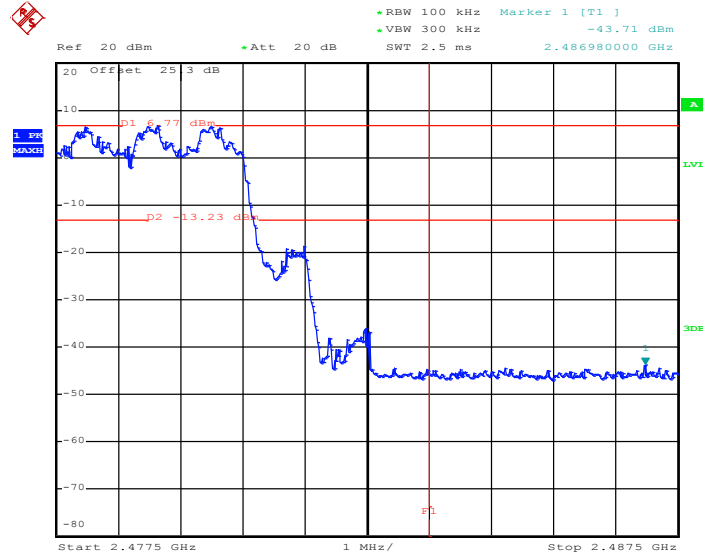

Date: 11.SEP.2015 20:53:07



Test Mode :	3Mbps	Temperature :	24~26°C
Test Engineer :	Tommy Lee	Relative Humidity :	48~51%

3Mbps Hopping Mode Low Band Edge Plot

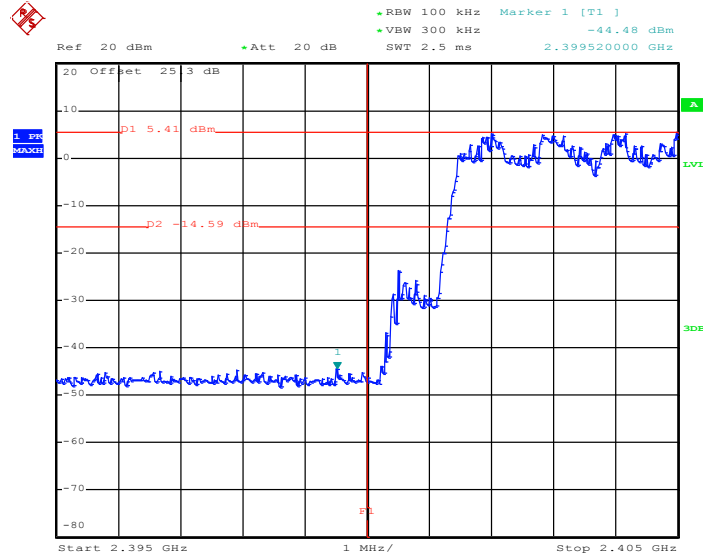

Date: 1.SEP.2015 14:28:35

3Mbps Hopping Mode High Band Edge Plot

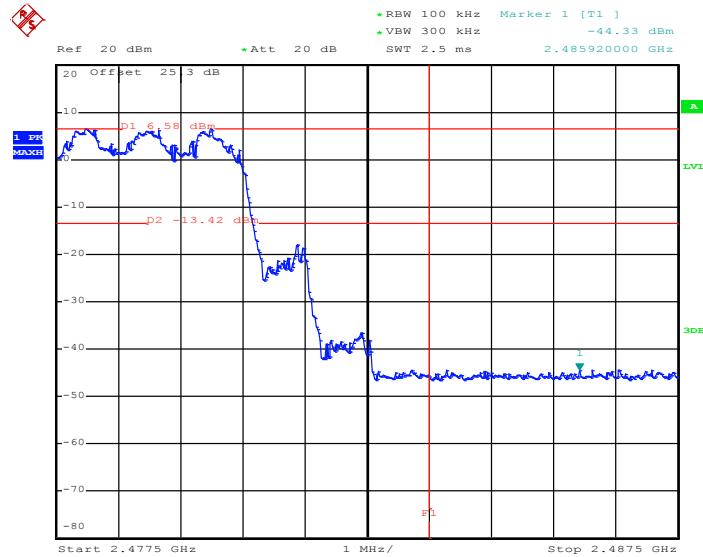

Date: 11.SEP.2015 20:57:30



<Ant. 2>

Test Mode :	1Mbps	Temperature :	24~26°C
Test Engineer :	Tommy Lee	Relative Humidity :	48~51%

1Mbps Hopping Mode Low Band Edge Plot

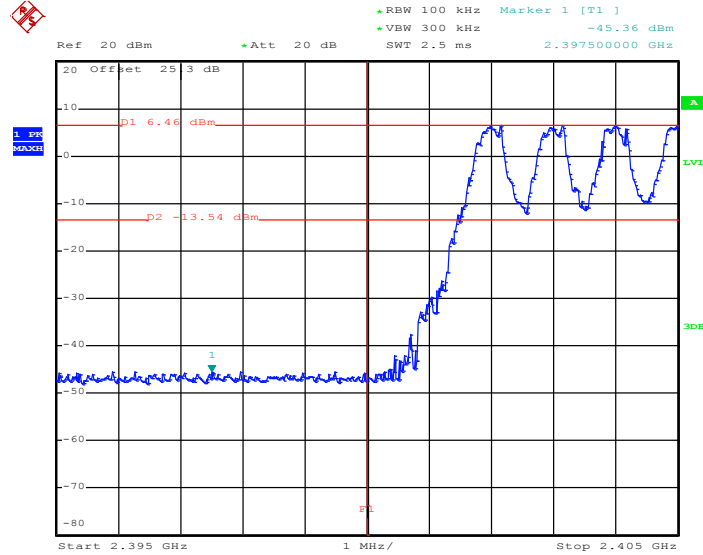

Date: 1.SEP.2015 15:26:24

1Mbps Hopping Mode High Band Edge Plot

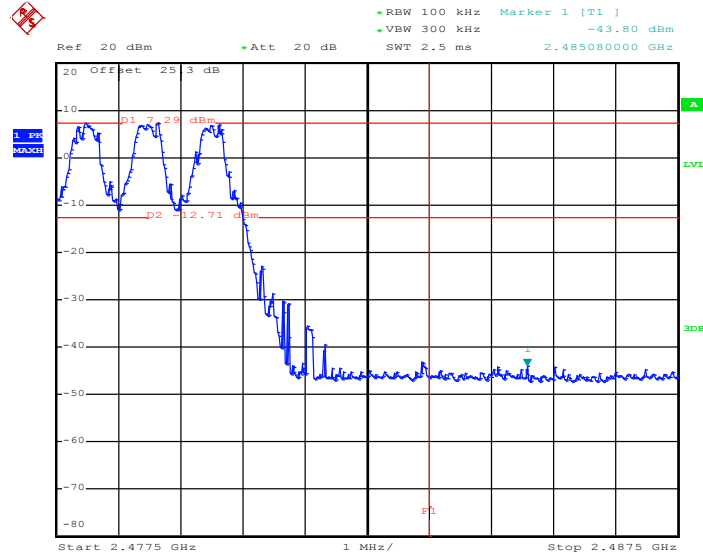

Date: 11.SEP.2015 21:22:48



Test Mode :	2Mbps	Temperature :	24~26°C
Test Engineer :	Tommy Lee	Relative Humidity :	48~51%

2Mbps Hopping Mode Low Band Edge Plot

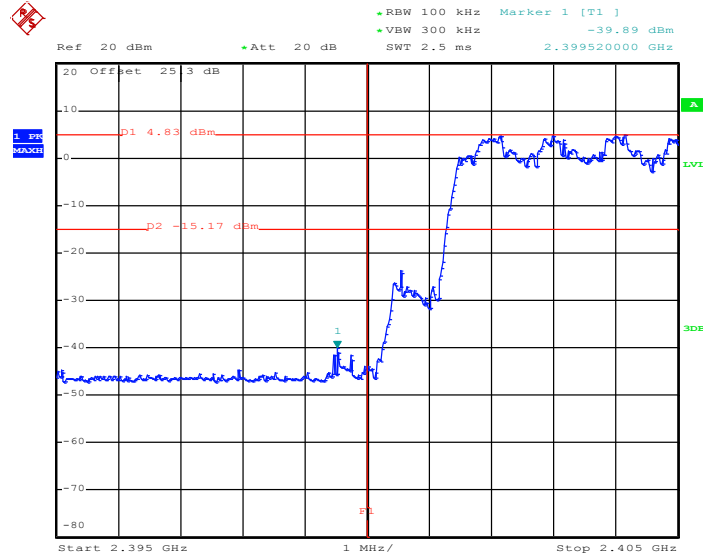

Date: 1.SEP.2015 15:58:02

2Mbps Hopping Mode High Band Edge Plot

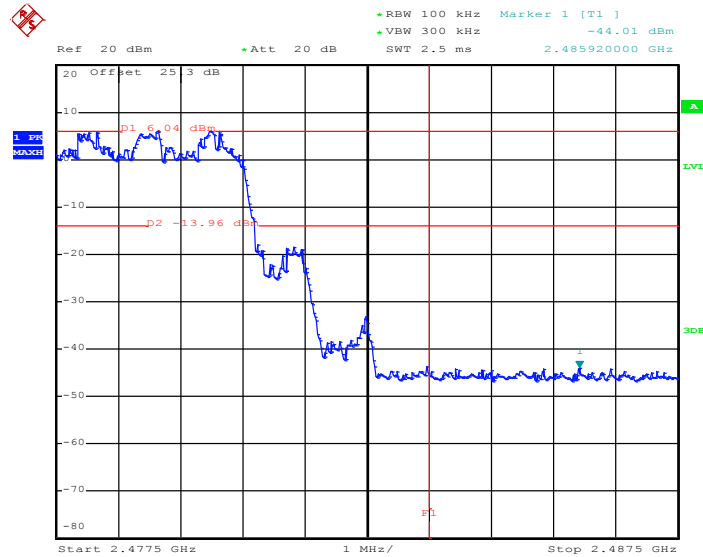

Date: 11.SEP.2015 21:26:20



Test Mode :	3Mbps	Temperature :	24~26°C
Test Engineer :	Tommy Lee	Relative Humidity :	48~51%

3Mbps Hopping Mode Low Band Edge Plot

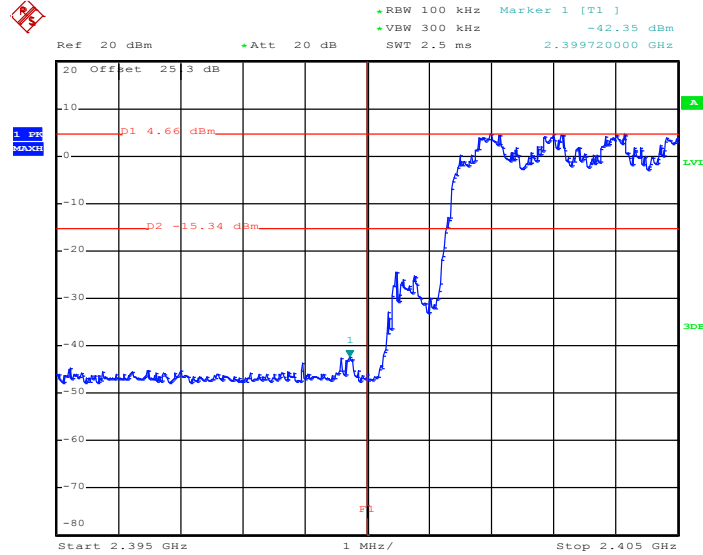

Date: 1.SEP.2015 16:25:47

3Mbps Hopping Mode High Band Edge Plot

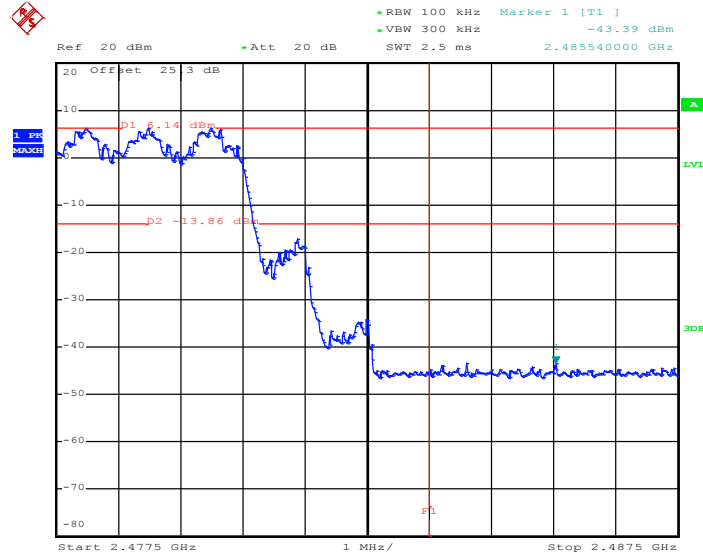

Date: 11.SEP.2015 21:30:58

3.7 Conducted Spurious Emission Measurement

3.7.1 Limit of Spurious Emission Measurement

In any 100 kHz bandwidth outside the intentional radiation frequency band, the radio frequency power shall be at least 20 dB below the highest level of the radiated power. In addition, radiated emissions which fall in the restricted bands must also comply with the radiated emission limits.

3.7.2 Measuring Instruments

The measuring equipment is listed in the section 4 of this test report.

3.7.3 Test Procedure

1. The testing follows ANSI C63.10-2009 clause 7.7.10
2. The RF output of EUT was connected to the spectrum analyzer by RF cable and attenuator. The path loss was compensated to the results for each measurement.
3. Set to the maximum power setting and enable the EUT transmit continuously.
4. Set RBW = 100 kHz, VBW = 300kHz, scan up through 10th harmonic. All harmonics / spurs must be at least 20 dB down from the highest emission level within the authorized band as measured with a 100 kHz RBW.
5. Measure and record the results in the test report.
6. The RF fundamental frequency should be excluded against the limit line in the operating frequency band.

3.7.4 Test Setup

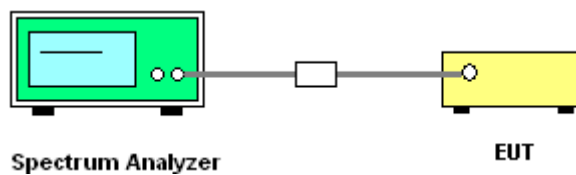



3.7.5 Test Result of Conducted Spurious Emission

<Ant. 1>

Test Mode :	1Mbps	Temperature :	24~26°C
Test Channel :	00	Relative Humidity :	48~51%
		Test Engineer :	Tommy Lee

1Mbps CSE Plot on Ch 00 between 30MHz ~ 3 GHz

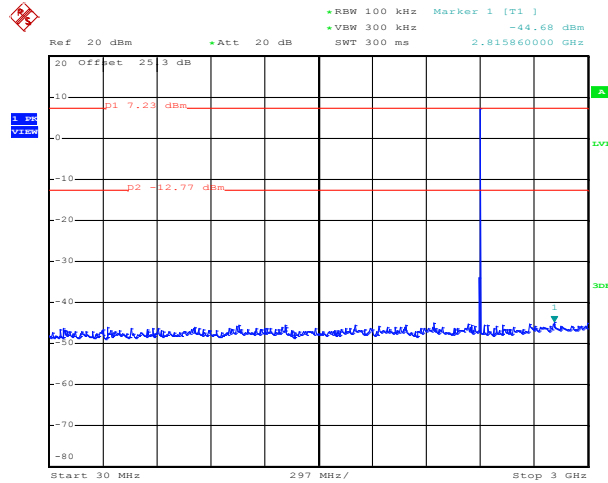

Date: 1.SEP.2015 10:57:36

1Mbps CSE Plot on Ch 00 between 2 GHz ~ 25 GHz

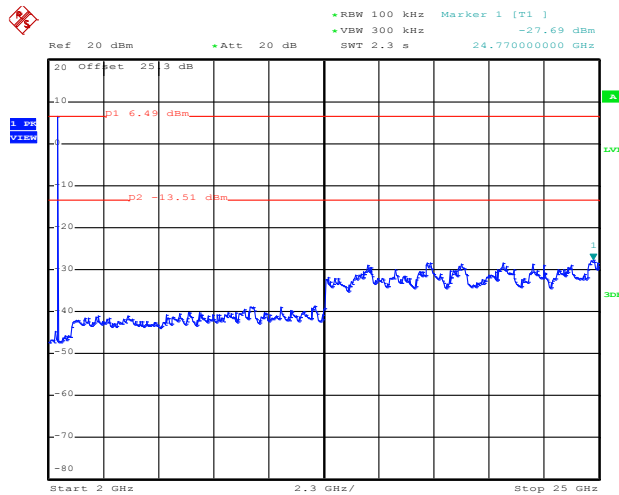

Date: 1.SEP.2015 10:57:57



Test Mode :	1Mbps	Temperature :	24~26°C
Test Channel :	39	Relative Humidity :	48~51%
		Test Engineer :	Tommy Lee

1Mbps CSE Plot on Ch 39 between 30MHz ~ 3 GHz

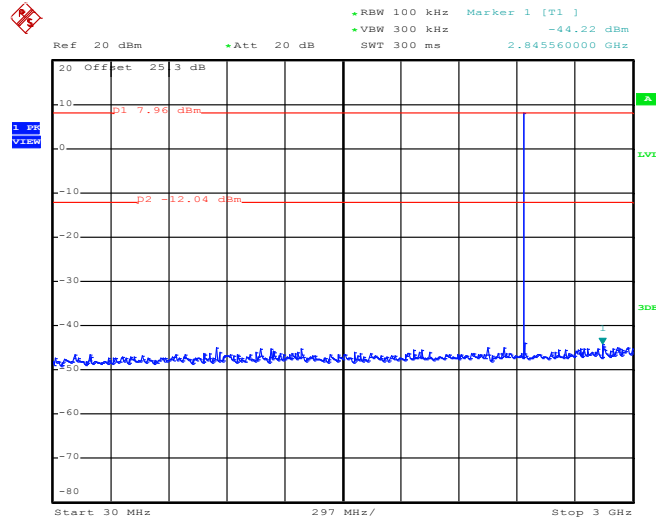

Date: 1.SEP.2015 13:37:50

1Mbps CSE Plot on Ch 39 between 2 GHz ~ 25 GHz

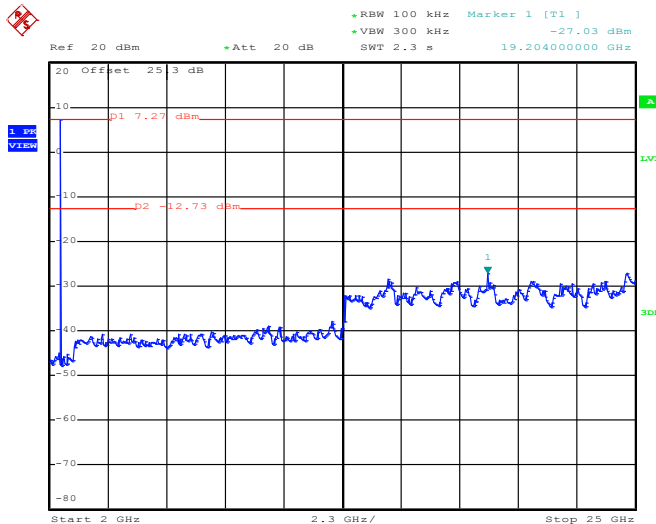

Date: 1.SEP.2015 13:38:12



Test Mode :	1Mbps	Temperature :	24~26°C
Test Channel :	78	Relative Humidity :	48~51%
		Test Engineer :	Tommy Lee

1Mbps CSE Plot on Ch 78 between 30MHz ~ 3 GHz

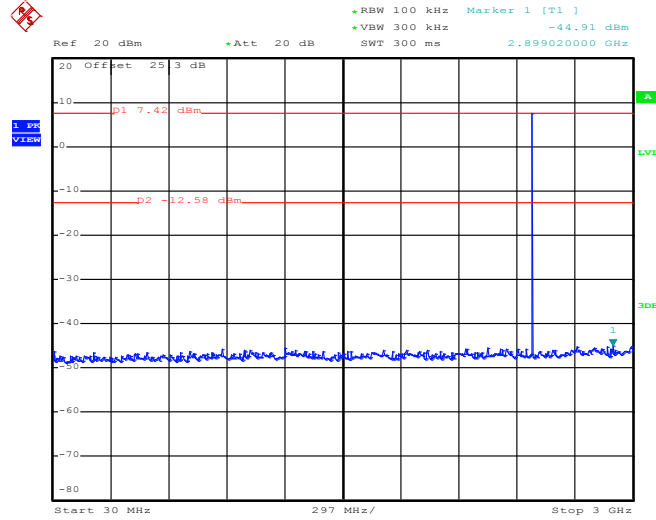

Date: 1.SEP.2015 13:49:05

1Mbps CSE Plot on Ch 78 between 2 GHz ~ 25 GHz

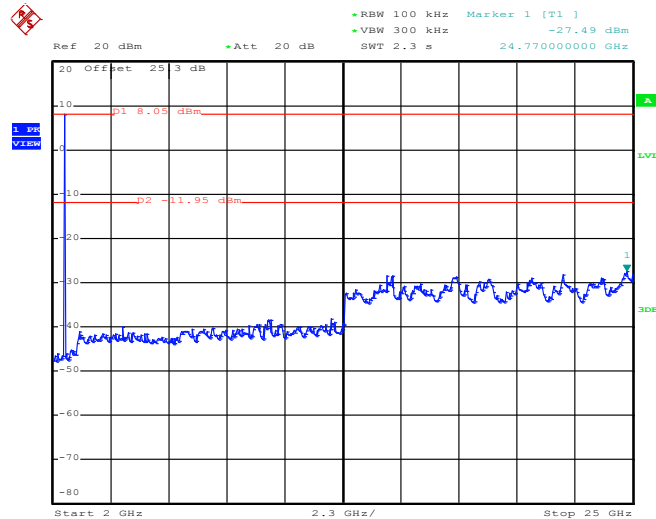

Date: 1.SEP.2015 13:49:27



Test Mode :	2Mbps	Temperature :	24~26°C
Test Channel :	00	Relative Humidity :	48~51%
		Test Engineer :	Tommy Lee

2Mbps CSE Plot on Ch 00 between 30MHz ~ 3 GHz

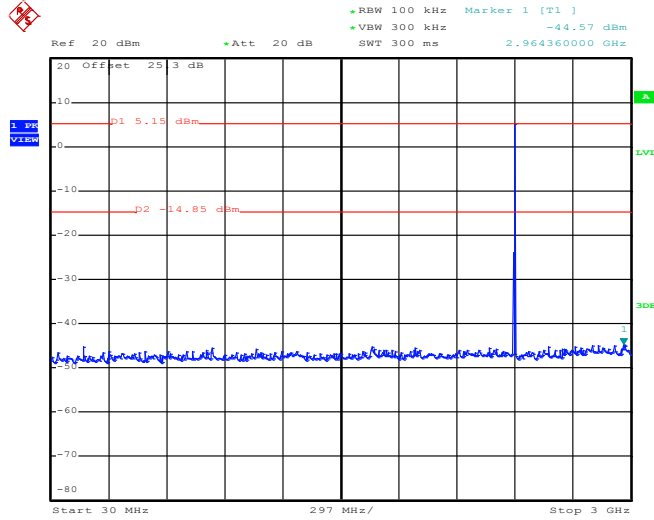

Date: 1.SEP.2015 13:54:18

2Mbps CSE Plot on Ch 00 between 2 GHz ~ 25 GHz

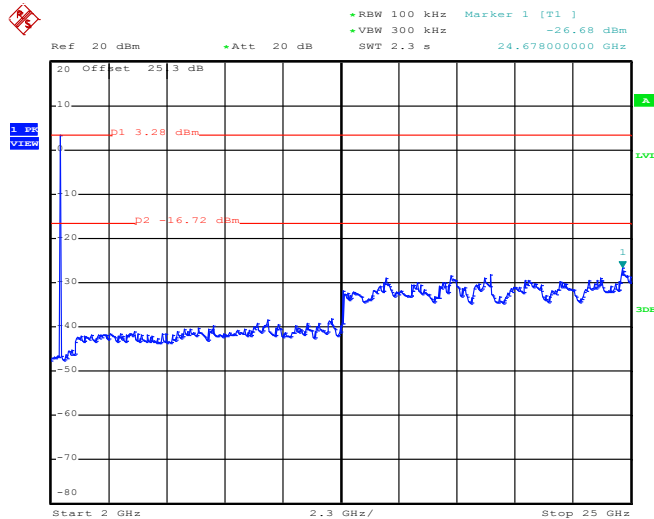

Date: 1.SEP.2015 13:54:40



Test Mode :	2Mbps	Temperature :	24~26°C
Test Channel :	39	Relative Humidity :	48~51%
		Test Engineer :	Tommy Lee

2Mbps CSE Plot on Ch 39 between 30MHz ~ 3 GHz

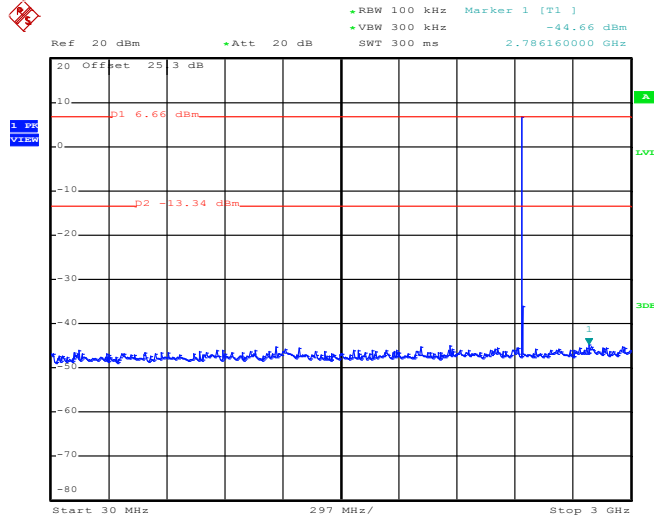

Date: 1.SEP.2015 14:11:31

2Mbps CSE Plot on Ch 39 between 2 GHz ~ 25 GHz

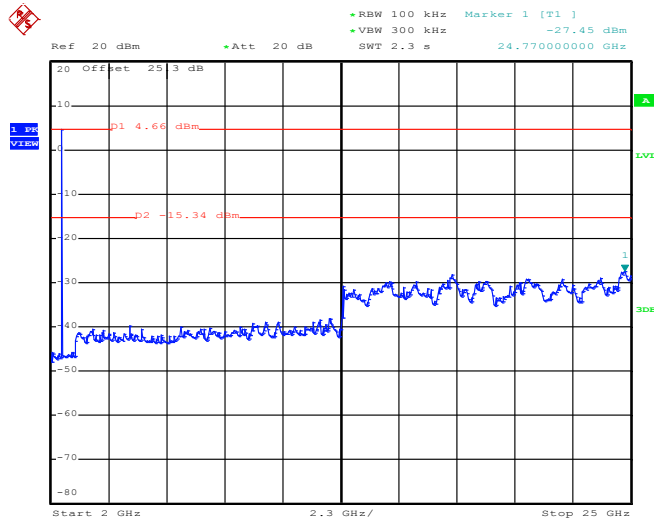

Date: 1.SEP.2015 14:11:53



Test Mode :	2Mbps	Temperature :	24~26°C
Test Channel :	78	Relative Humidity :	48~51%
		Test Engineer :	Tommy Lee

2Mbps CSE Plot on Ch 78 between 30MHz ~ 3 GHz

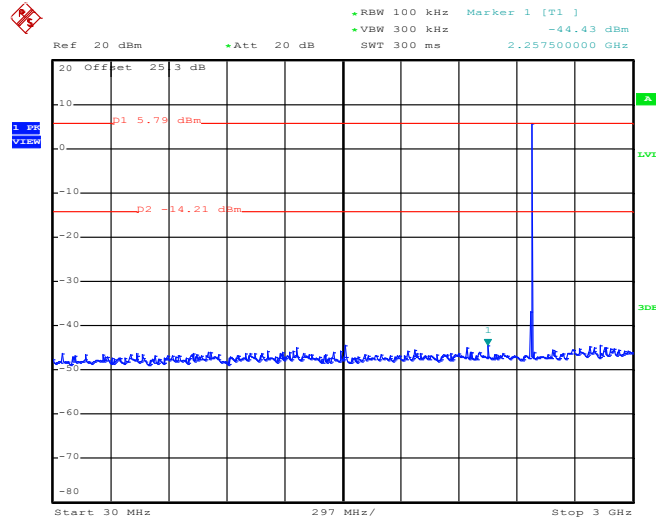

Date: 1.SEP.2015 14:21:22

2Mbps CSE Plot on Ch 78 between 2 GHz ~ 25 GHz

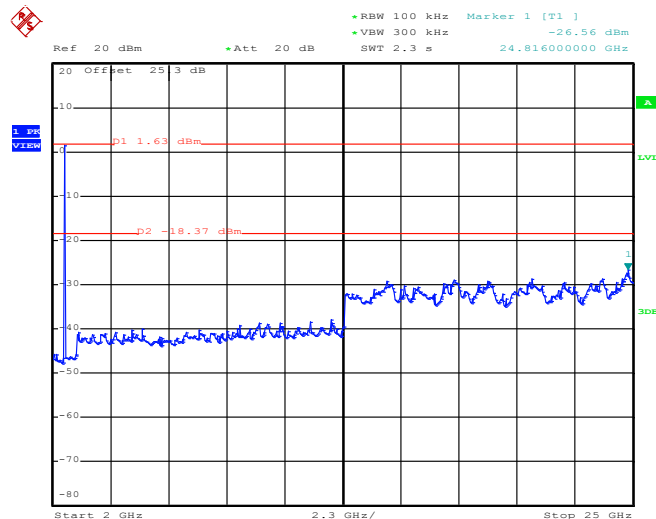

Date: 1.SEP.2015 14:21:43



Test Mode :	3Mbps	Temperature :	24~26°C
Test Channel :	00	Relative Humidity :	48~51%
		Test Engineer :	Tommy Lee

3Mbps CSE Plot on Ch 00 between 30MHz ~ 3 GHz

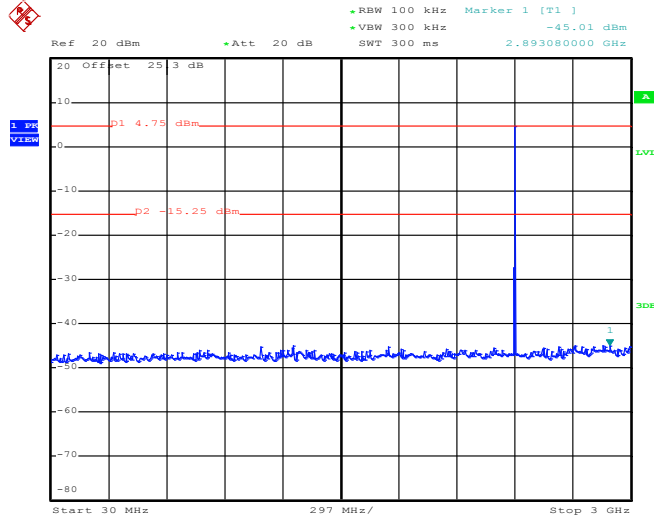

Date: 1.SEP.2015 14:24:45

3Mbps CSE Plot on Ch 00 between 2 GHz ~ 25 GHz

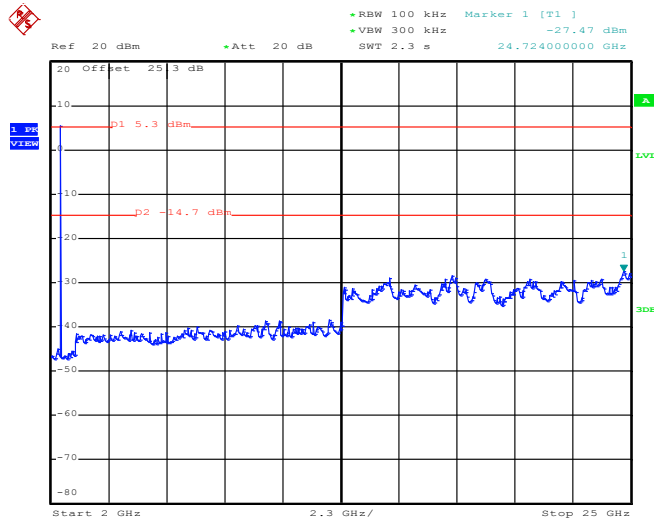

Date: 1.SEP.2015 14:25:07



Test Mode :	3Mbps	Temperature :	24~26°C
Test Channel :	39	Relative Humidity :	48~51%
		Test Engineer :	Tommy Lee

3Mbps CSE Plot on Ch 39 between 30MHz ~ 3 GHz

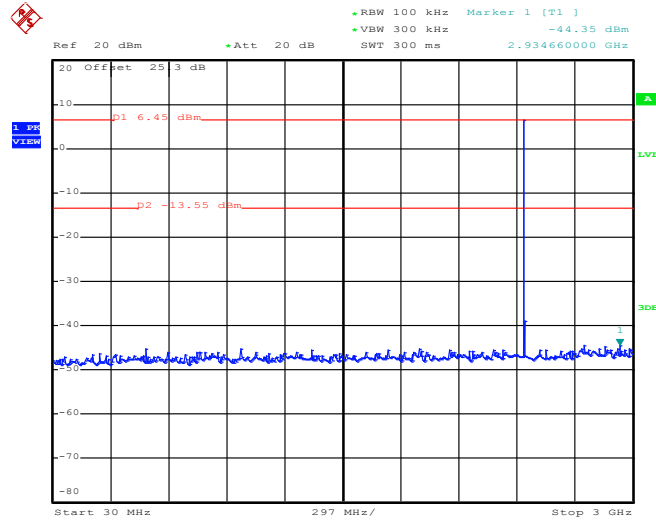

Date: 1.SEP.2015 14:45:53

3Mbps CSE Plot on Ch 39 between 2 GHz ~ 25 GHz

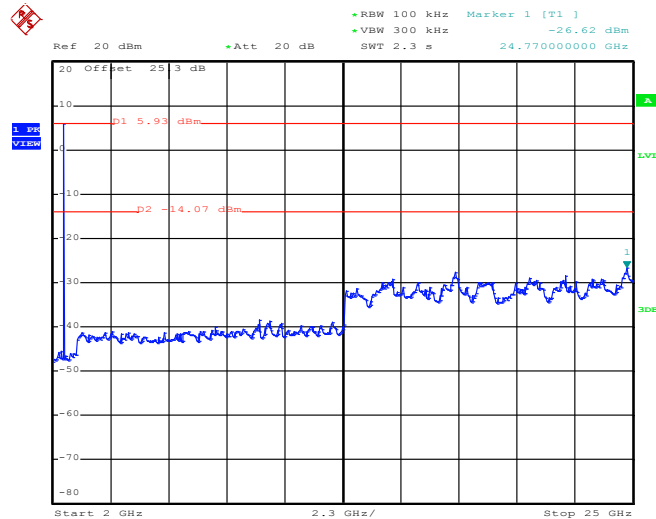

Date: 1.SEP.2015 14:46:15



Test Mode :	3Mbps	Temperature :	24~26°C
Test Channel :	78	Relative Humidity :	48~51%
		Test Engineer :	Tommy Lee

3Mbps CSE Plot on Ch 78 between 30MHz ~ 3 GHz

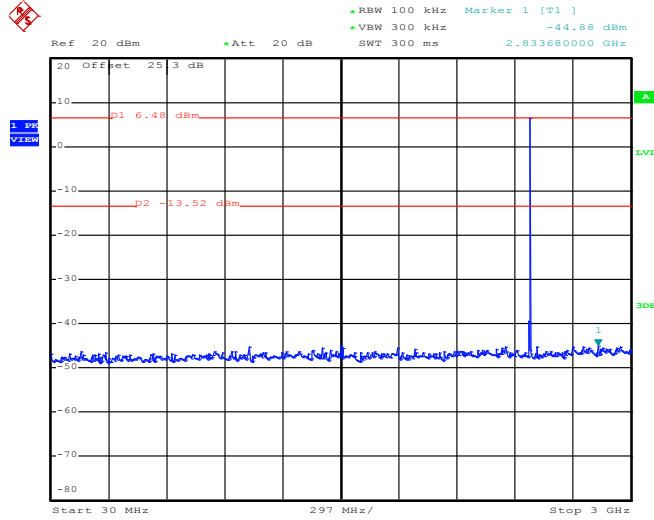

Date: 1.SEP.2015 14:53:39

3Mbps CSE Plot on Ch 78 between 2 GHz ~ 25 GHz

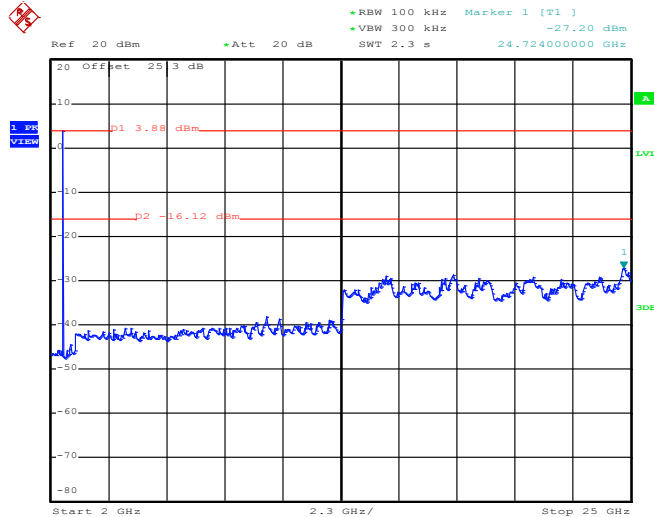

Date: 1.SEP.2015 14:54:01



<Ant. 2>

Test Mode :	1Mbps	Temperature :	24~26°C
Test Channel :	00	Relative Humidity :	48~51%
		Test Engineer :	Tommy Lee

1Mbps CSE Plot on Ch 00 between 30MHz ~ 3 GHz

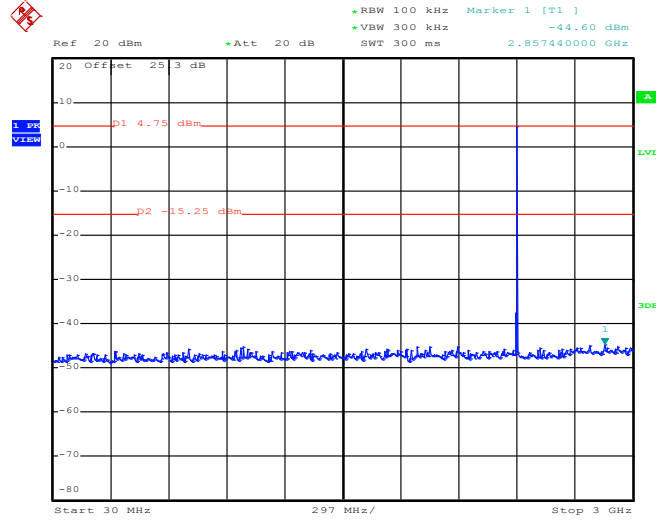

Date: 1.SEP.2015 15:11:12

1Mbps CSE Plot on Ch 00 between 2 GHz ~ 25 GHz

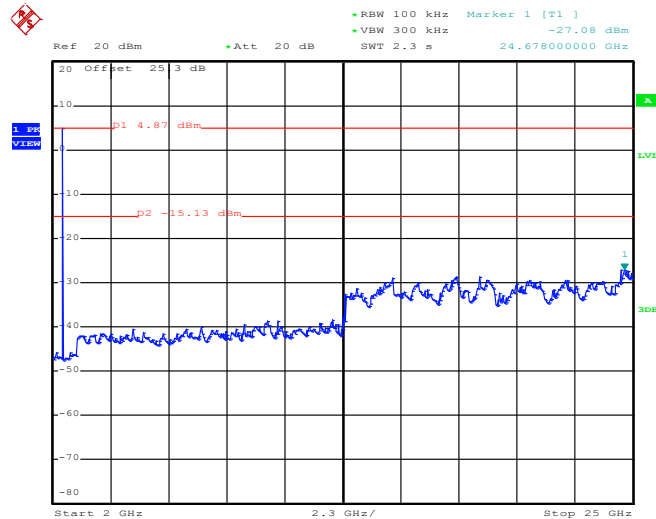

Date: 1.SEP.2015 15:11:33



Test Mode :	1Mbps	Temperature :	24~26°C
Test Channel :	39	Relative Humidity :	48~51%
		Test Engineer :	Tommy Lee

1Mbps CSE Plot on Ch 39 between 30MHz ~ 3 GHz

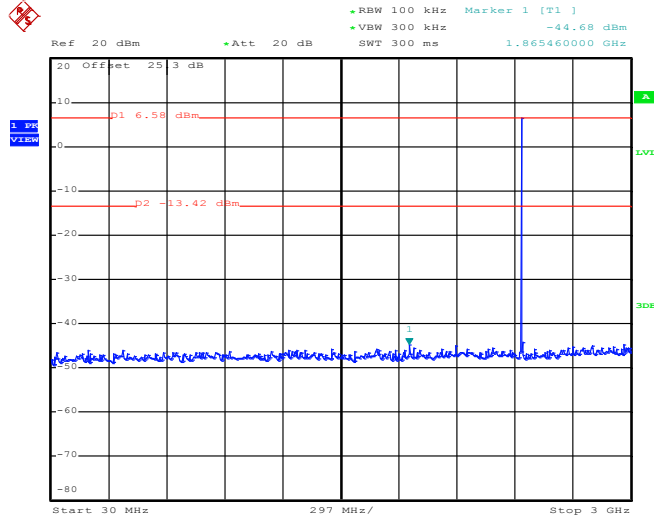

Date: 1.SEP.2015 15:40:59

1Mbps CSE Plot on Ch 39 between 2 GHz ~ 25 GHz

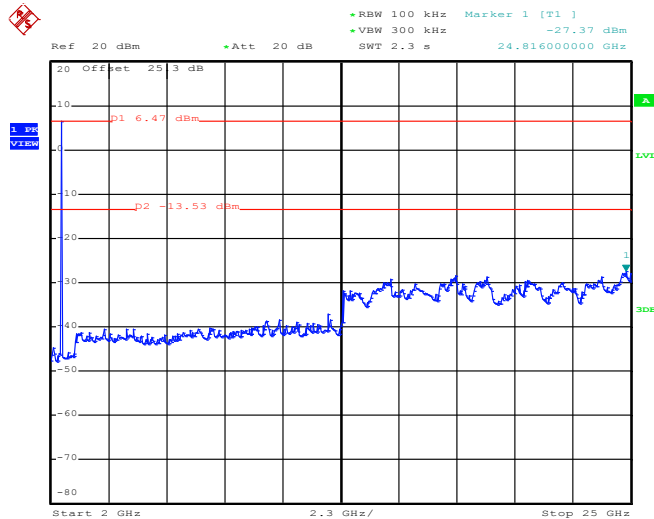

Date: 1.SEP.2015 15:41:21



Test Mode :	1Mbps	Temperature :	24~26°C
Test Channel :	78	Relative Humidity :	48~51%
		Test Engineer :	Tommy Lee

1Mbps CSE Plot on Ch 78 between 30MHz ~ 3 GHz

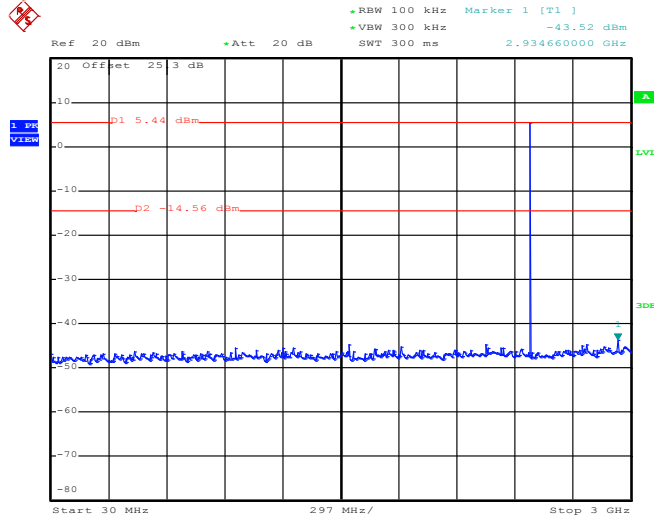

Date: 1.SEP.2015 15:48:06

1Mbps CSE Plot on Ch 78 between 2 GHz ~ 25 GHz

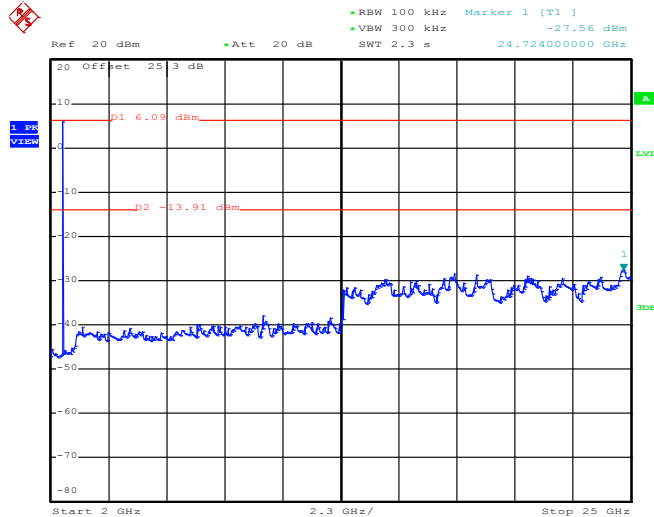

Date: 1.SEP.2015 15:48:28



Test Mode :	2Mbps	Temperature :	24~26°C
Test Channel :	00	Relative Humidity :	48~51%
		Test Engineer :	Tommy Lee

2Mbps CSE Plot on Ch 00 between 30MHz ~ 3 GHz

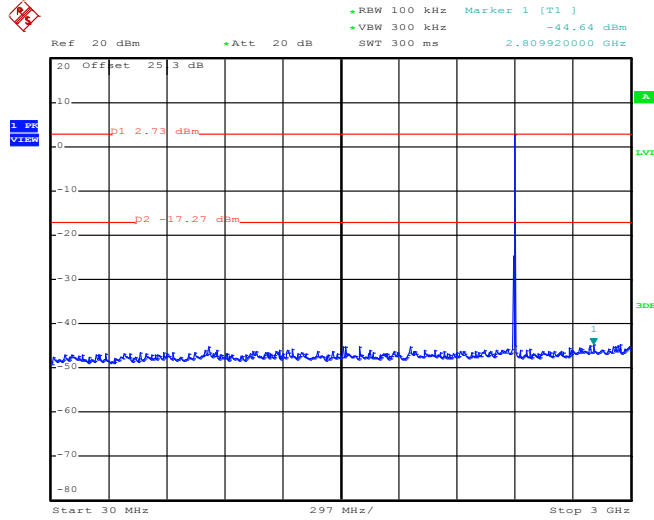

Date: 1.SEP.2015 15:51:44

2Mbps CSE Plot on Ch 00 between 2 GHz ~ 25 GHz

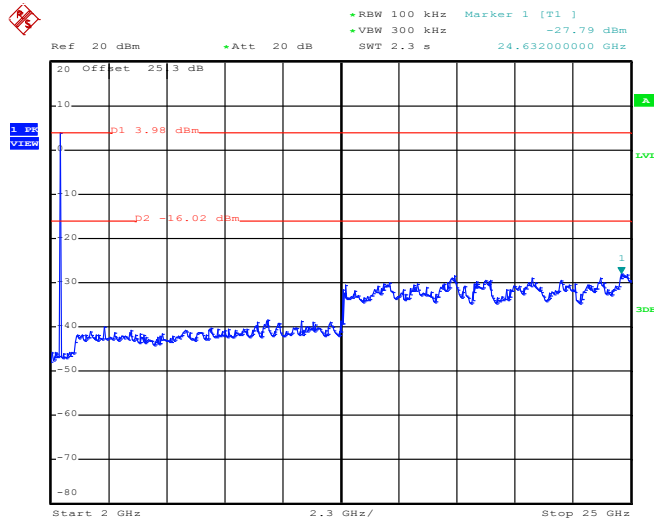

Date: 1.SEP.2015 15:52:05



Test Mode :	2Mbps	Temperature :	24~26°C
Test Channel :	39	Relative Humidity :	48~51%
		Test Engineer :	Tommy Lee

2Mbps CSE Plot on Ch 39 between 30MHz ~ 3 GHz

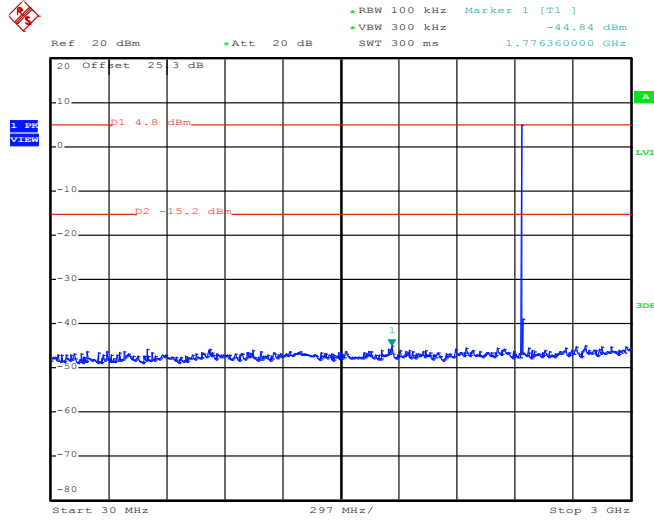

Date: 1.SEP.2015 16:10:10

2Mbps CSE Plot on Ch 39 between 2 GHz ~ 25 GHz

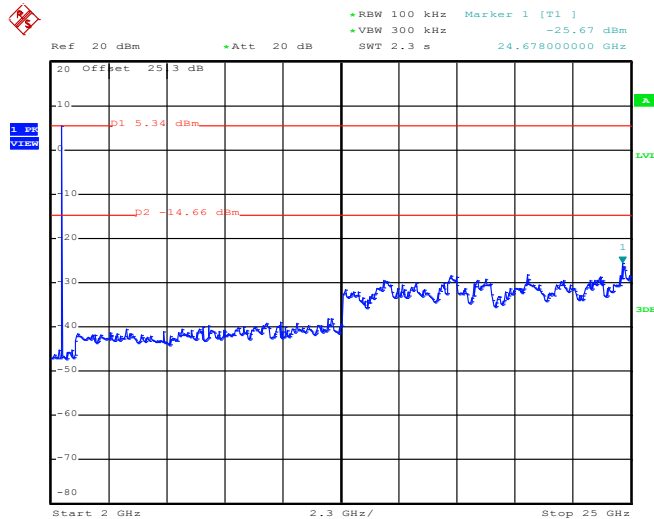

Date: 1.SEP.2015 16:10:32



Test Mode :	2Mbps	Temperature :	24~26°C
Test Channel :	78	Relative Humidity :	48~51%
		Test Engineer :	Tommy Lee

2Mbps CSE Plot on Ch 78 between 30MHz ~ 3 GHz

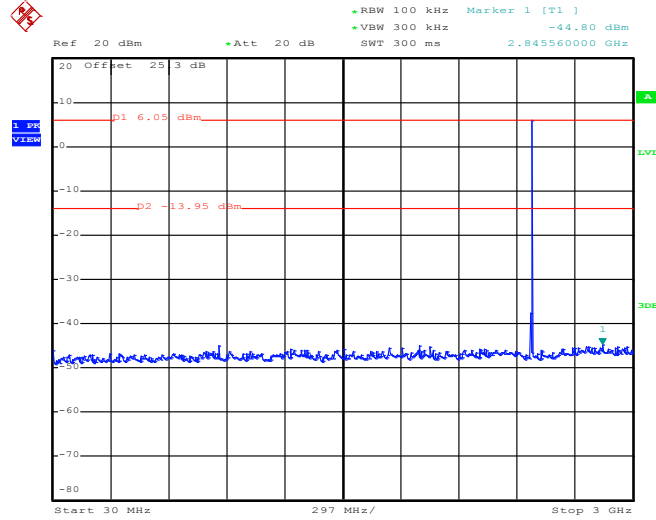

Date: 1.SEP.2015 16:18:16

2Mbps CSE Plot on Ch 78 between 2 GHz ~ 25 GHz

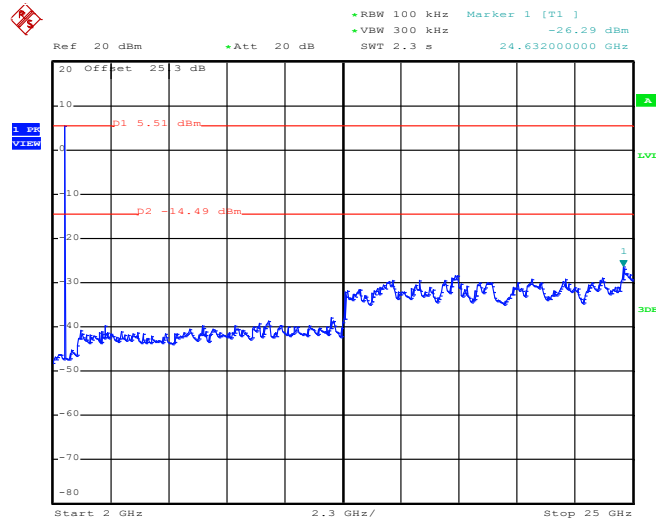

Date: 1.SEP.2015 16:18:38



Test Mode :	3Mbps	Temperature :	24~26°C
Test Channel :	00	Relative Humidity :	48~51%
		Test Engineer :	Tommy Lee

3Mbps CSE Plot on Ch 00 between 30MHz ~ 3 GHz

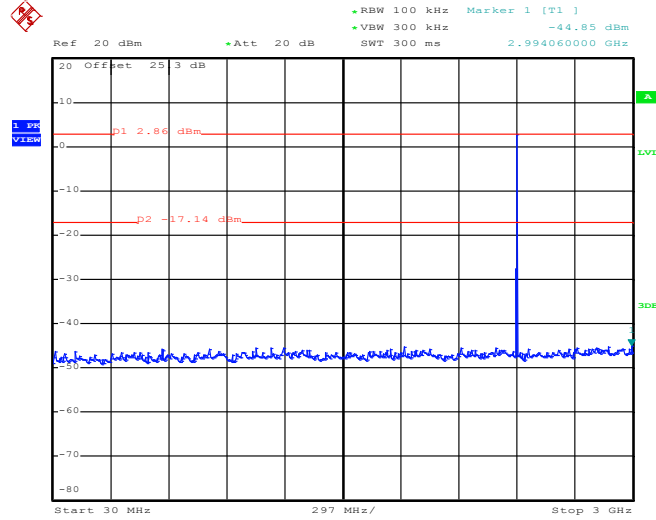

Date: 1.SEP.2015 16:21:01

3Mbps CSE Plot on Ch 00 between 2 GHz ~ 25 GHz

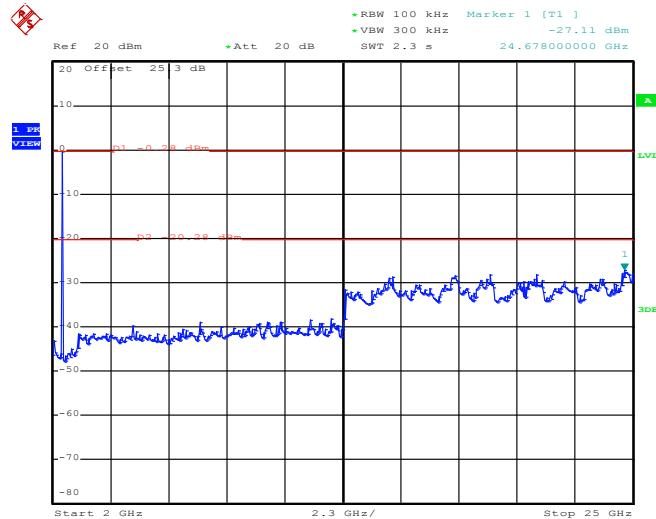

Date: 1.SEP.2015 16:21:23



Test Mode :	3Mbps	Temperature :	24~26°C
Test Channel :	39	Relative Humidity :	48~51%
		Test Engineer :	Tommy Lee

3Mbps CSE Plot on Ch 39 between 30MHz ~ 3 GHz

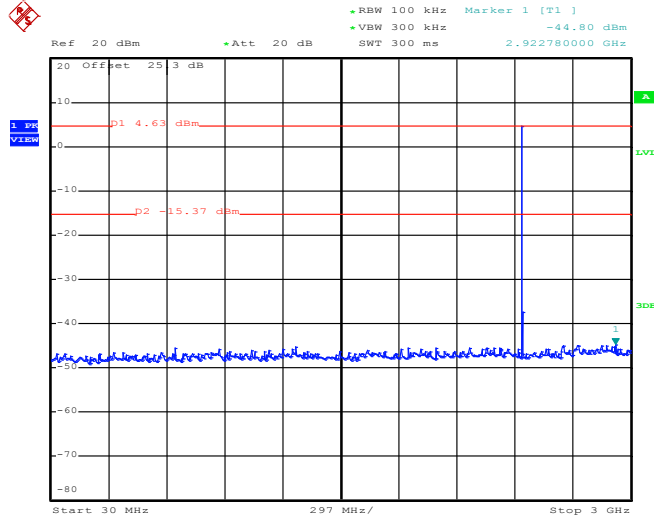

Date: 1.SEP.2015 16:37:04

3Mbps CSE Plot on Ch 39 between 2 GHz ~ 25 GHz

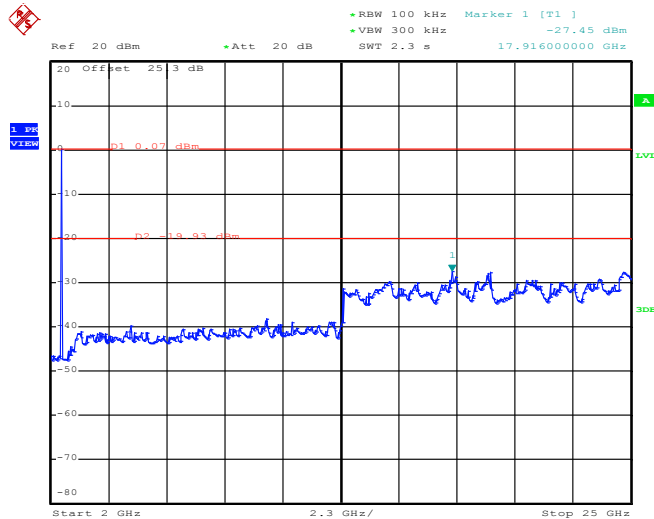

Date: 1.SEP.2015 16:37:25



Test Mode :	3Mbps	Temperature :	24~26°C
Test Channel :	78	Relative Humidity :	48~51%
		Test Engineer :	Tommy Lee

3Mbps CSE Plot on Ch 78 between 30MHz ~ 3 GHz

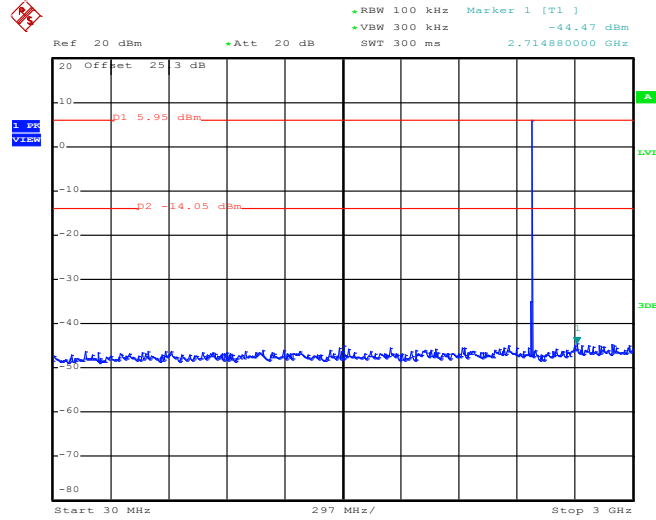

Date: 1.SEP.2015 16:42:52

3Mbps CSE Plot on Ch 78 between 2 GHz ~ 25 GHz

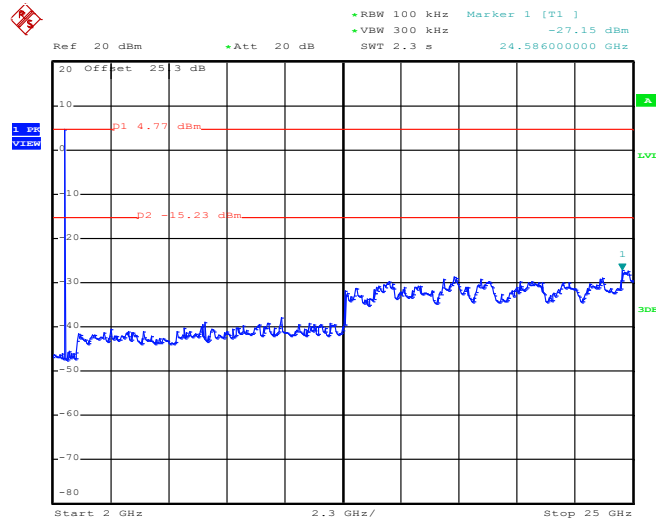

Date: 1.SEP.2015 16:43:14



3.8 Radiated Band Edges and Spurious Emission Measurement

3.8.1 Limit of Radiated Band Edges and Spurious Emission

In any 100 kHz bandwidth outside the intentional radiator frequency band, all harmonics/spurious must be at least 20 dB below the highest emission level within the authorized band. In addition, radiated emissions which fall in the restricted bands must also comply with the FCC section 15.209 limits as below.

Frequency (MHz)	Field Strength (microvolts/meter)	Measurement Distance (meters)
0.009 – 0.490	2400/F(kHz)	300
0.490 – 1.705	24000/F(kHz)	30
1.705 – 30.0	30	30
30 – 88	100	3
88 – 216	150	3
216 - 960	200	3
Above 960	500	3

3.8.2 Measuring Instruments

The measuring equipment is listed in the section 4 of this test report.



3.8.3 Test Procedures

1. The EUT was placed on a turntable with 0.8 meter for frequency below 1GHz and 1.5 meter for frequency above 1GHz respectively above ground.
2. The EUT was set 3 meters from the interference receiving antenna, which was mounted on the top of a variable height antenna tower.
3. For each suspected emission, the EUT was arranged to its worst case and then tune the Antenna tower (from 1 m to 4 m) and turntable (from 0 degree to 360 degrees) to find the maximum reading. A pre-amp and a high pass filter are used for the test in order to get better signal level to comply with the guidelines.
4. Set to the maximum power setting and enable the EUT transmit continuously.
5. Use the following spectrum analyzer settings:
 - (1) Span shall wide enough to fully capture the emission being measured;
 - (2) Set RBW=100 kHz for $f < 1 \text{ GHz}$, RBW=1MHz for $f > 1\text{GHz}$; VBW \geq RBW; Sweep = auto; Detector function = peak; Trace = max hold for peak
 - (3) For average measurement: use duty cycle correction factor method per 15.35(c).
Duty cycle = On time/100 milliseconds
On time = $N_1 * L_1 + N_2 * L_2 + \dots + N_{n-1} * L_{n-1} + N_n * L_n$
Where N_1 is number of type 1 pulses, L_1 is length of type 1 pulses, etc.
Average Emission Level = Peak Emission Level + $20 * \log(\text{Duty cycle})$
6. Corrected Reading: Antenna Factor + Cable Loss + Read Level - Preamp Factor = Level

Note: The average levels were calculated from the peak level corrected with duty cycle correction factor (24.76dB) derived from $20 \log (\text{dwell time}/100\text{ms})$. This correction is only for signals that hop with the fundamental signal, such as band-edge and harmonic. Other spurious signals that are independent of the hopping signal would not use this correction.

3.8.4 Test Setup

For radiated emissions below 30MHz

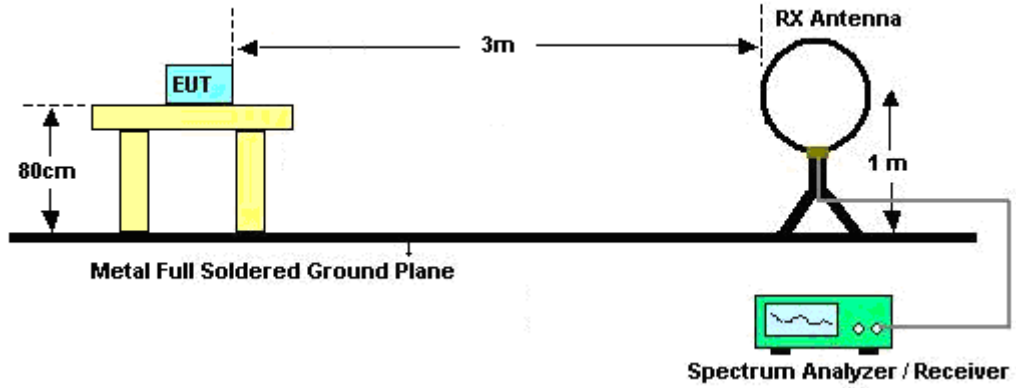

For radiated emissions from 30MHz to 1GHz

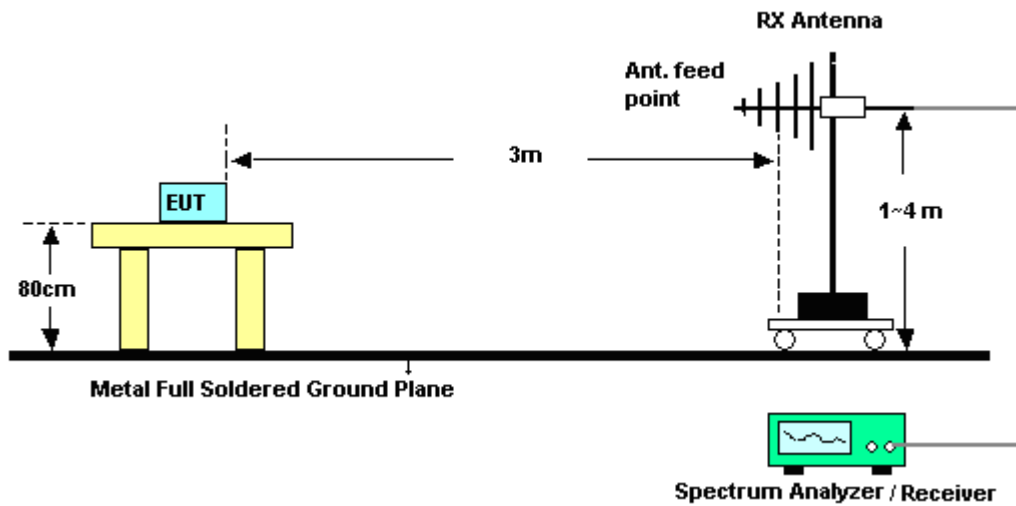

For radiated emissions above 1GHz

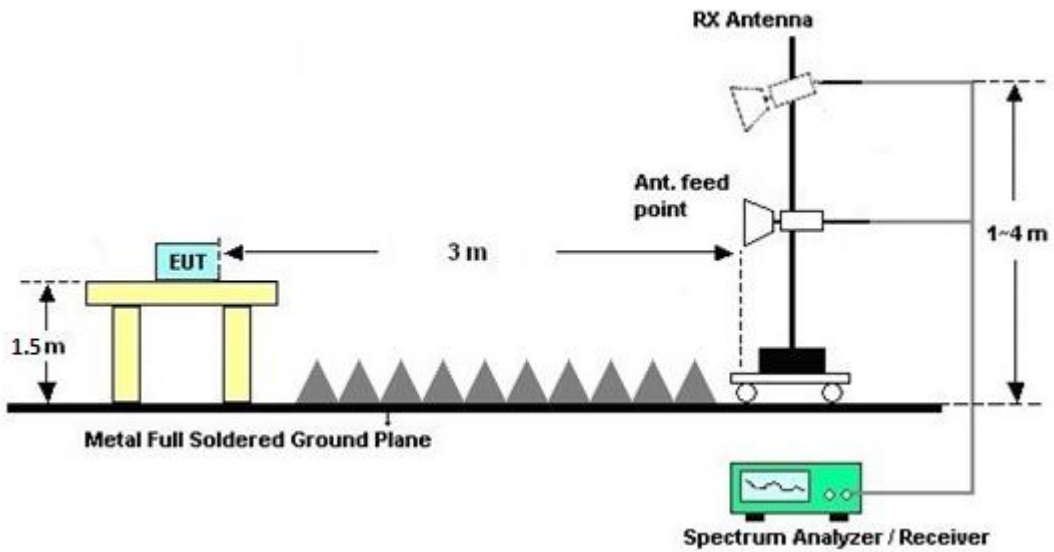

3.8.5 Test Results of Radiated Spurious Emissions (9 kHz ~ 30 MHz)

The low frequency, which started from 9 kHz to 30MHz, was pre-scanned and the result which was 20dB lower than the limit line per 15.31(o) was not reported.



3.8.6 Duty cycle correction factor for average measurement

<Ant. 1>

DH5 on time (One Pulse) Plot on Channel 39

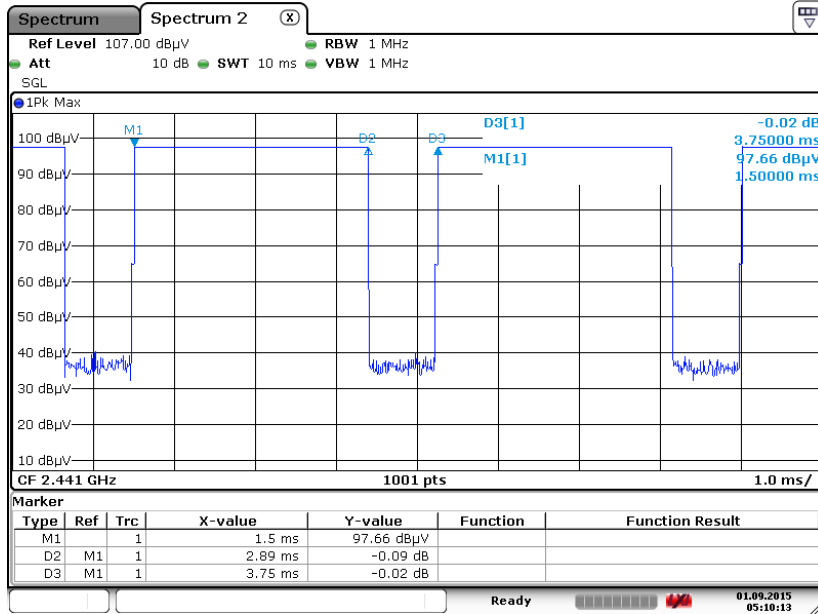

Date: 1.SEP.2015 05:10:13

DH5 on time (Count Pulses) Plot on Channel 39

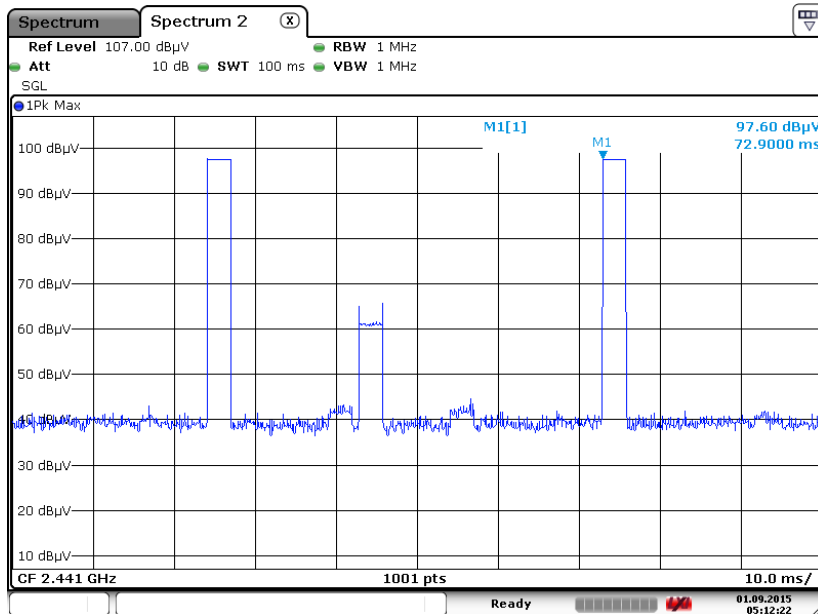

Date: 1.SEP.2015 05:12:23

Note:

1. Worst case Duty cycle = on time/100 milliseconds = 2 * 2.89 / 100 = 5.78 %
2. Worst case Duty cycle correction factor = 20*log(Duty cycle) = -24.76 dB
3. DH5 has the highest duty cycle worst case and is reported.



<Ant. 2>

DH5 on time (One Pulse) Plot on Channel 39

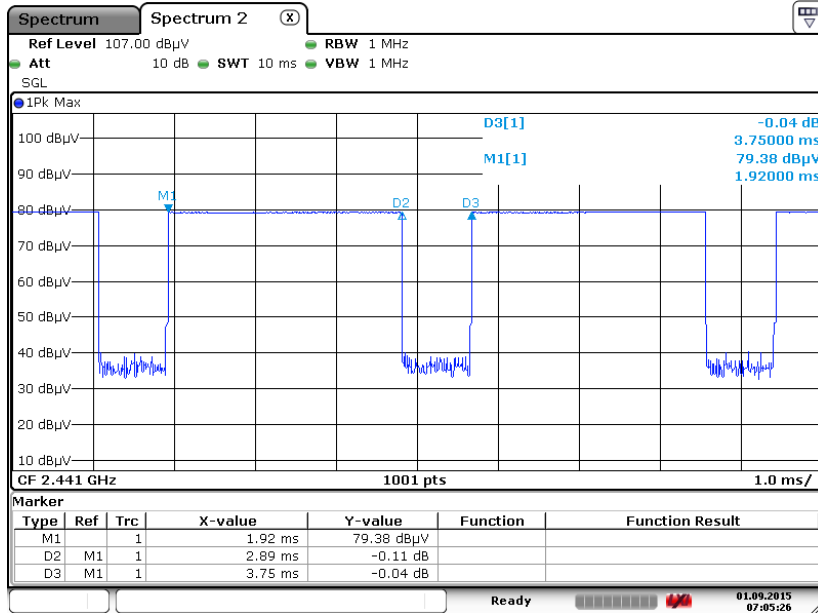

Date: 1.SEP.2015 07:05:26

DH5 on time (Count Pulses) Plot on Channel 39

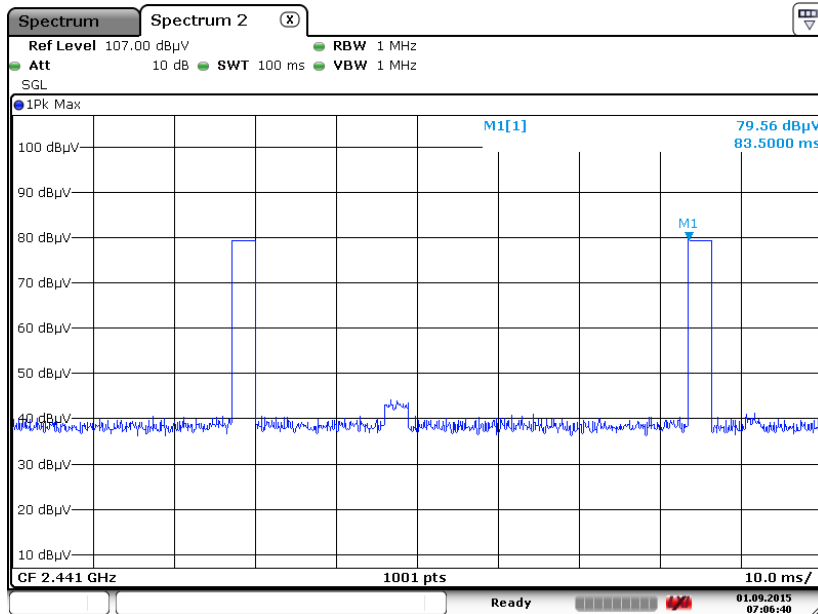

Date: 1.SEP.2015 07:06:40

Note:

1. Worst case Duty cycle = on time/100 milliseconds = 2 * 2.89 / 100 = 5.78 %
2. Worst case Duty cycle correction factor = 20*log(Duty cycle) = -24.76 dB
3. DH5 has the highest duty cycle worst case and is reported.



Duty Cycle Correction Factor Consideration for AFH mode:

Bluetooth normal hopping rate is 1600Hz and reduced to 800Hz in AFH mode; due to the reduced number of hopping frequencies, with the same packet configuration the dwell time in each channel frequency within 100msec period is longer in AFH mode than normal mode.

In AFH mode, the minimum hopping frequencies are 20, to get the longest dwell time DH5 packet is observed; the period to have DH5 packet completing one hopping sequence is

$$2.89 \text{ ms} \times 20 \text{ channels} = 57.8 \text{ ms}$$

There cannot be 2 complete hopping sequences within 100ms period, considering the random hopping behavior, maximum 2 hops can be possibly observed within the period. $[100\text{ms} / 57.6\text{ms}] = 2 \text{ hops}$

Thus, the maximum possible ON time:

$$2.89 \text{ ms} \times 2 = 5.78 \text{ ms}$$

Worst case Duty Cycle Correction factor, which is derived from the maximum possible ON time,

$$20 \times \log(5.78 \text{ ms}/100\text{ms}) = -24.76 \text{ dB}$$

3.8.7 Test Result of Radiated Spurious at Band Edges

Please refer to Appendix A and Appendix B.

3.8.8 Test Result of Radiated Spurious Emission (30MHz ~ 10th Harmonic)

Please refer to Appendix A and Appendix B.



3.9 AC Conducted Emission Measurement

3.9.1 Limit of AC Conducted Emission

For equipment that is designed to be connected to the public utility (AC) power line, the radio frequency voltage that is conducted back onto the AC power line on any frequency or frequencies within the band 150 kHz to 30 MHz shall not exceed the limits in the following table.

Frequency of emission (MHz)	Conducted limit (dBµV)	
	Quasi-peak	Average
0.15-0.5	66 to 56*	56 to 46*
0.5-5	56	46
5-30	60	50

*Decreases with the logarithm of the frequency.

3.9.2 Measuring Instruments

The measuring equipment is listed in the section 4 of this test report.

3.9.3 Test Procedures

1. The EUT was placed 0.4 meter from the conducting wall of the shielding room was kept at least 80 centimeters from any other grounded conducting surface.
2. Connect EUT to the power mains through a line impedance stabilization network (LISN).
3. All the support units are connecting to the other LISN.
4. The LISN provides 50 ohm coupling impedance for the measuring instrument.
5. The FCC states that a 50 ohm, 50 microhenry LISN should be used.
6. Both sides of AC line were checked for maximum conducted interference.
7. The frequency range from 150 kHz to 30 MHz was searched.
8. Set the test-receiver system to Peak Detect Function and specified bandwidth (IF Bandwidth = 9kHz) with Maximum Hold Mode. Then measurement is also conducted by Average Detector and Quasi-Peak Detector Function respectively.

3.9.4 Test Setup

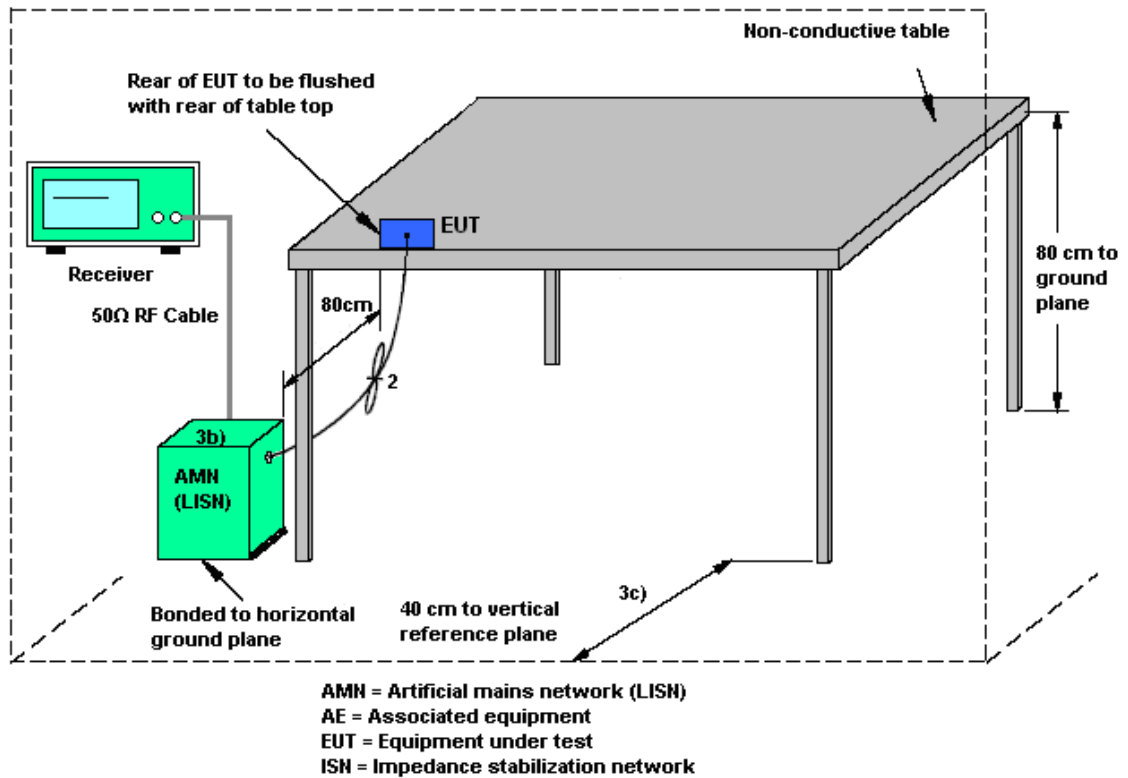



3.9.5 Test Result of AC Conducted Emission

Test Mode :	Mode 1	Temperature :	24~26°C
Test Engineer :	Derreck Chen	Relative Humidity :	49~53%
Test Voltage :	120Vac / 60Hz	Phase :	Line
Function Type :	WLAN Link + Bluetooth Link		

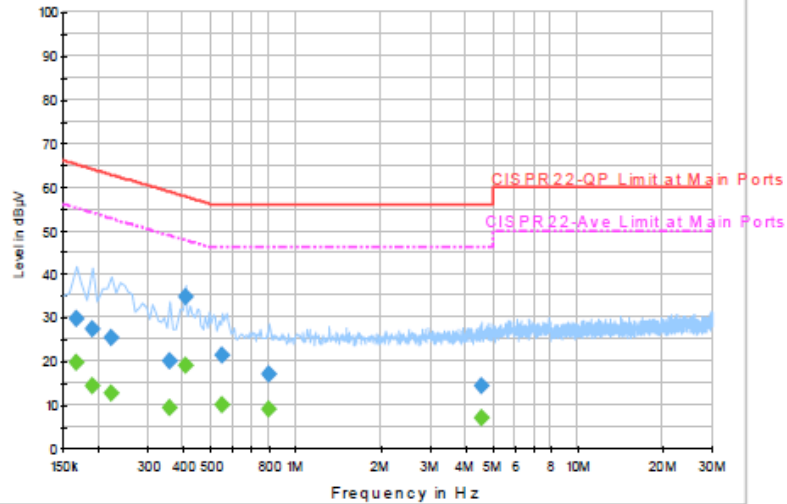

Final Result : Quasi-Peak

Frequency (MHz)	Quasi-Peak (dBµV)	Filter	Line	Corr. (dB)	Margin (dB)	Limit (dBµV)
0.166000	29.6	Off	L1	19.5	35.6	65.2
0.190000	27.4	Off	L1	19.5	36.6	64.0
0.222000	25.4	Off	L1	19.4	37.3	62.7
0.358000	20.2	Off	L1	19.5	38.6	58.8
0.406000	34.9	Off	L1	19.5	22.8	57.7
0.550000	21.3	Off	L1	19.5	34.7	56.0
0.806000	17.0	Off	L1	19.6	39.0	56.0
4.574000	14.5	Off	L1	19.7	41.5	56.0

Final Result : Average

Frequency (MHz)	Average (dBµV)	Filter	Line	Corr. (dB)	Margin (dB)	Limit (dBµV)
0.166000	19.6	Off	L1	19.5	35.6	55.2
0.190000	14.5	Off	L1	19.5	39.5	54.0
0.222000	12.6	Off	L1	19.4	40.1	52.7
0.358000	9.5	Off	L1	19.5	39.3	48.8
0.406000	18.9	Off	L1	19.5	28.8	47.7
0.550000	10.0	Off	L1	19.5	36.0	46.0
0.806000	9.1	Off	L1	19.6	36.9	46.0
4.574000	7.1	Off	L1	19.7	38.9	46.0



Test Mode :	Mode 1	Temperature :	24~26°C
Test Engineer :	Derreck Chen	Relative Humidity :	49~53%
Test Voltage :	120Vac / 60Hz	Phase :	Neutral
Function Type :	WLAN Link + Bluetooth Link		

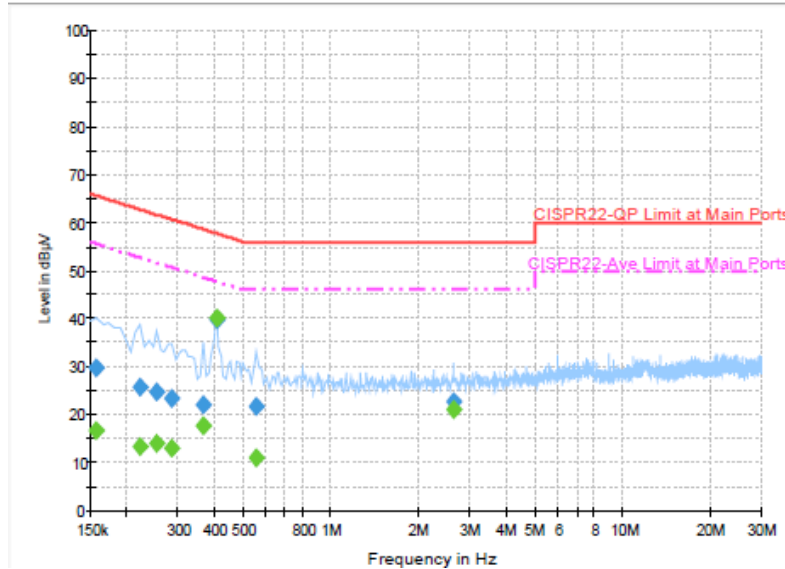

Final Result : Quasi-Peak

Frequency (MHz)	Quasi-Peak (dBµV)	Filter	Line	Corr. (dB)	Margin (dB)	Limit (dBµV)
0.158000	29.7	Off	N	19.5	35.9	65.6
0.222000	25.7	Off	N	19.4	37.0	62.7
0.254000	24.8	Off	N	19.6	36.8	61.6
0.286000	23.5	Off	N	19.5	37.1	60.6
0.366000	22.0	Off	N	19.5	36.6	58.6
0.406000	39.8	Off	N	19.5	17.9	57.7
0.558000	21.8	Off	N	19.5	34.2	56.0
2.646000	22.7	Off	N	19.6	33.3	56.0

Final Result : Average

Frequency (MHz)	Average (dBµV)	Filter	Line	Corr. (dB)	Margin (dB)	Limit (dBµV)
0.158000	16.7	Off	N	19.5	38.9	55.6
0.222000	13.4	Off	N	19.4	39.3	52.7
0.254000	14.0	Off	N	19.6	37.6	51.6
0.286000	13.1	Off	N	19.5	37.5	50.6
0.366000	17.7	Off	N	19.5	30.9	48.6
0.406000	40.3	Off	N	19.5	7.4	47.7
0.558000	11.0	Off	N	19.5	35.0	46.0
2.646000	21.1	Off	N	19.6	24.9	46.0



3.10 Antenna Requirements

3.10.1 Standard Applicable

If directional gain of transmitting antennas is greater than 6dBi, the power shall be reduced by the same level in dB comparing to gain minus 6dBi. The use of a permanently attached antenna or of an antenna that uses a unique coupling to the intentional radiator shall be considered sufficient to comply with the FCC rule.

3.10.2 Antenna Anti-Replacement Construction

An embedded-in antenna design is used.

3.10.3 Antenna Gain

The antenna peak gain of EUT is less than 6 dBi. Therefore, it is not necessary to reduce maximum peak output power limit.



4 List of Measuring Equipment

Instrument	Manufacturer	Model No.	Serial No.	Characteristics	Calibration Date	Test Date	Due Date	Remark
Power Meter	Agilent	E4416A	GB41292344	300MHz~40GHz	Jan. 14, 2015	Aug. 27, 2015 ~ Sep. 11, 2015	Jan. 13, 2016	Conducted (TH05-HY)
Power Sensor	Agilent	E9327A	US40441548	300MHz~40GHz	Jan. 14, 2015	Aug. 27, 2015 ~ Sep. 11, 2015	Jan. 13, 2016	Conducted (TH05-HY)
Spectrum Analyzer	Rohde & Schwarz	FSP40	100055	9kHz-40GHz	Jun. 18, 2015	Aug. 27, 2015 ~ Sep. 11, 2015	Jun. 17, 2016	Conducted (TH05-HY)
Bilog Antenna	Schaffner	CBL6111C	2726	30MHz ~ 1GHz	Sep. 27, 2014	Sep. 01, 2015	Sep. 26, 2015	Radiation (03CH07-HY)
Double Ridge Horn Antenna	ESCO	3117	00075962	1GHz ~ 18GHz	Aug. 21, 2015	Sep. 01, 2015	Aug. 20, 2016	Radiation (03CH07-HY)
EMI Test Receiver	Rohde & Schwarz	ESCI 7	100724	9kHz~7GHz	Aug. 26, 2015	Sep. 01, 2015	Aug. 25, 2016	Radiation (03CH07-HY)
Horn Antenna	SCHWARZBECK	BBHA 9170	BBHA9170584	18GHz- 40GHz	Nov. 03, 2014	Sep. 01, 2015	Nov. 02, 2015	Radiation (03CH07-HY)
Loop Antenna	TESEQ	HLA6120	31244	9 kHz~30 MHz	Feb. 02, 2015	Sep. 01, 2015	Feb. 01, 2016	Radiation (03CH07-HY)
Hygrometer	Testo	608-H1	34897197	N/A	May 04, 2015	Sep. 01, 2015	May 03, 2016	Radiation (03CH07-HY)
Preamplifier	MITEQ	AMF-7D-0010 1800-30-10P	1590075	1GHz ~ 18GHz	Apr. 20, 2015	Sep. 01, 2015	Apr. 19, 2016	Radiation (03CH07-HY)
Preamplifier	COM-POWER	PA-103A	161241	10MHz-1000MHz	Mar. 12, 2015	Sep. 01, 2015	Mar. 11, 2016	Radiation (03CH07-HY)
Preamplifier	Agilent	8449B	3008A02362	1GHz~ 26.5GHz	Oct. 21, 2014	Sep. 01, 2015	Oct. 20, 2015	Radiation (03CH07-HY)
Signal Analyzer	Rohde & Schwarz	FSV 30	101749	10Hz~30GHz	Mar. 10, 2015	Sep. 01, 2015	Mar. 09, 2016	Radiation (03CH07-HY)
Antenna Mast	Max-Full	MFA520BS	N/A	1m~4m	N/A	Sep. 01, 2015	N/A	Radiation (03CH07-HY)
Turn Table	ChainTek	Chaintek 3000	N/A	0~360 degree	N/A	Sep. 01, 2015	N/A	Radiation (03CH07-HY)
Preamplifier	MITEQ	JS44-180040 00-33-8P	1840917	18GHz ~ 40GHz	Jun. 02, 2015	Sep. 01, 2015	Jun. 01, 2016	Radiation (03CH07-HY)
EMI Test Receiver	Rohde & Schwarz	ESCS 30	100356	9kHz – 2.75GHz	Dec. 01, 2014	Sep. 15, 2015	Nov. 30, 2015	Conduction (CO05-HY)
LISN	Rohde & Schwarz	ENV216	100080	9kHz~30MHz	Dec. 02, 2014	Sep. 15, 2015	Dec. 01, 2015	Conduction (CO05-HY)
AC Power Source	ChainTek	APC-1000W	N/A	N/A	N/A	Sep. 15, 2015	N/A	Conduction (CO05-HY)



5 Uncertainty of Evaluation

Uncertainty of Conducted Emission Measurement (150 kHz ~ 30 MHz)

Measuring Uncertainty for a Level of Confidence of 95% ($U = 2Uc(y)$)	2.26
---	------

Uncertainty of Radiated Emission Measurement (30 MHz ~ 1000 MHz)

Measuring Uncertainty for a Level of Confidence of 95% ($U = 2Uc(y)$)	4.8
---	-----



Appendix A. Radiated Spurious Emission

Test Engineer :	Wei Chen, Ken Wu, and James Chiu	Temperature :	21~23°C
		Relative Humidity :	60~63%

2.4GHz 2400~2483.5MHz

BT (Band Edge @ 3m)

BT Ant. 1	Note	Frequency (MHz)	Level (dBμV/m)	Over Limit (dB)	Limit Line (dBμV/m)	Read Level (dBμV)	Antenna Factor (dB/m)	Cable Loss (dB)	Preamp Factor (dB)	Ant Pos (cm)	Table Pos (deg)	Peak Avg. (P/A)	Pol. (H/V)	
BT CH00 2402MHz		2324.56	49.65	-24.35	74	44.18	32.09	7.6	34.22	227	267	P	H	
		2324.56	24.89	-29.11	54	-	-	-	-	-	-	A	H	
	*	2402.3	109.54	-	-	103.91	32.18	7.75	34.3	227	267	P	H	
		2402.3	84.78	-	-	-	-	-	-	-	-	A	H	
													H	
													H	
			2337.56	48.47	-25.53	74	42.98	32.11	7.6	34.22	312	229	P	V
			2337.56	23.71	-30.29	54	-	-	-	-	-	-	A	V
	*		2401.91	101.04	-	-	95.41	32.18	7.75	34.3	312	229	P	V
			2401.91	76.28	-	-	-	-	-	-	-	-	A	V
													V	
													V	
BT CH 39 2441MHz		2389.42	48.26	-25.74	74	42.6	32.18	7.75	34.27	249	260	P	H	
		2389.42	23.5	-30.5	54	-	-	-	-	-	-	A	H	
	*	2440.91	107.72	-	-	102.04	32.24	7.83	34.39	249	260	P	H	
		2440.91	82.96	-	-	-	-	-	-	-	-	A	H	
			2488.98	47.73	-26.27	74	41.95	32.3	7.91	34.43	249	260	P	H
			2488.98	22.97	-31.03	54	-	-	-	-	-	-	A	H
			2325.77	47.97	-26.03	74	42.5	32.09	7.6	34.22	309	293	P	V
			2325.77	23.21	-30.79	54	-	-	-	-	-	-	A	V
	*		2441.29	98.85	-	-	93.17	32.24	7.83	34.39	309	293	P	V
			2441.29	74.09	-	-	-	-	-	-	-	-	A	V
			2489.93	47.92	-26.08	74	42.14	32.3	7.91	34.43	309	293	P	V
			2489.93	23.16	-30.84	54	-	-	-	-	-	-	A	V



BT CH 78 2480MHz	*	2480.05	107.67	-	-	101.91	32.28	7.91	34.43	215	340	P	H
		2480.05	82.91	-	-	-	-	-	-	-	-	A	H
		2483.5	55.72	-18.28	74	49.96	32.28	7.91	34.43	215	340	P	H
		2483.5	30.96	-23.04	54	-	-	-	-	-	-	A	H
													H
													H
	*	2479.98	101.15	-	-	95.39	32.28	7.91	34.43	380	241	P	V
		2479.98	76.39	-	-	-	-	-	-	-	-	A	V
		2483.97	49.14	-24.86	74	43.38	32.28	7.91	34.43	380	241	P	V
		2483.97	24.38	-29.62	54	-	-	-	-	-	-	A	V
													V
													V
Remark	<ol style="list-style-type: none"> 1. No other spurious found. 2. All results are PASS against Peak and Average limit line. 												



2.4GHz 2400~2483.5MHz

BT (Harmonic @ 3m)

BT Ant. 1	Note	Frequency (MHz)	Level (dBμV/m)	Over Limit (dB)	Limit Line (dBμV/m)	Read Level (dBμV)	Antenna Factor (dB/m)	Cable Loss (dB)	Preamp Factor (dB)	Ant Pos (cm)	Table Pos (deg)	Peak Avg. (P/A)	Pol. (H/V)
BT CH 00 2402MHz		4806	46.31	-27.69	74	60.62	34.25	11.11	59.67	100	0	P	H
		4806	21.55	-32.45	54	-	-	-	-	-	-	A	H
													H
													H
		4806	50.15	-23.85	74	64.46	34.25	11.11	59.67	100	0	P	V
		4806	25.39	-28.61	54	-	-	-	-	-	-	A	V
													V
													V
BT CH 39 2441MHz		4884	47.5	-26.5	74	61.56	34.3	11.21	59.57	100	0	P	H
		4884	22.74	-31.26	54	-	-	-	-	-	-	A	H
		7323	44.56	-29.44	74	52.37	35.6	15.08	58.49	100	0	P	H
		7323	19.8	-34.2	54	-	-	-	-	-	-	A	H
		4884	49.8	-24.2	74	63.86	34.3	11.21	59.57	100	0	P	V
		4884	25.04	-28.96	54	-	-	-	-	-	-	A	V
		7320	44.52	-29.48	74	52.33	35.6	15.08	58.49	100	0	P	V
		7320	19.76	-34.24	54	-	-	-	-	-	-	A	V
BT CH 78 2480MHz		4962	49.51	-24.49	74	63.27	34.37	11.32	59.45	100	0	P	H
		4962	24.75	-29.25	54	-	-	-	-	-	-	A	H
		7440	47.39	-26.61	74	55.3	35.6	15.13	58.64	100	0	P	H
		7440	22.63	-31.37	54	-	-	-	-	-	-	A	H
		4962	53.1	-20.9	74	66.86	34.37	11.32	59.45	100	0	P	V
		4962	28.34	-25.66	54	-	-	-	-	-	-	A	V
		7440	45.99	-28.01	74	53.9	35.6	15.13	58.64	100	0	P	V
		7440	21.23	-32.77	54	-	-	-	-	-	-	A	V
Remark	1. No other spurious found. 2. All results are PASS against Peak and Average limit line.												



Emission below 1GHz

2.4GHz BT (LF)

BT	Note	Frequency	Level	Over	Limit	Read	Antenna	Cable	Preamp	Ant	Table	Peak	Pol.	
Ant.				Limit	Line	Level	Factor	Loss	Factor	Pos	Pos	Avg.		
1		(MHz)	(dBμV/m)	(dB)	(dBμV/m)	(dBμV)	(dB/m)	(dB)	(dB)	(cm)	(deg)	(P/A)	(H/V)	
2.4GHz BT LF		108.3	26.16	-17.34	43.5	44.22	10.74	2.38	31.18	-	-	P	H	
		172.83	33.14	-10.36	43.5	52.11	9.46	2.61	31.04	-	-	P	H	
		237.63	36.19	-9.81	46	53.17	11.06	2.96	31	-	-	P	H	
		301.4	39.78	-6.22	46	54.28	13.22	3.28	31	100	0	P	H	
		671.7	37.04	-8.96	46	42.73	20.42	4.35	30.46	-	-	P	H	
		768.3	38.8	-7.2	46	42.58	22.1	4.48	30.36	-	-	P	H	
														H
														H
														H
														H
														H
														H
			106.95	31.66	-11.84	43.5	49.83	10.62	2.38	31.17	-	-	P	V
			132.33	27.75	-15.75	43.5	44.67	11.8	2.38	31.1	-	-	P	V
			297.84	35.07	-10.93	46	49.75	13.18	3.16	31.02	-	-	P	V
			305.6	36.85	-9.15	46	51.32	13.25	3.28	31	-	-	P	V
			671.7	34.87	-11.13	46	40.56	20.42	4.35	30.46	-	-	P	V
			720	36.88	-9.12	46	41.47	21.4	4.41	30.4	100	0	P	V
													V	
													V	
													V	
													V	
													V	
													V	
Remark	1. No other spurious found. 2. All results are PASS against limit line.													



2.4GHz 2400~2483.5MHz

BT (Band Edge @ 3m)

BT Ant.	Note	Frequency	Level	Over Limit	Limit Line	Read Level	Antenna Factor	Cable Loss	Preamp Factor	Ant Pos	Table Pos	Peak Avg.	Pol.	
2		(MHz)	(dBμV/m)	(dB)	(dBμV/m)	(dBμV)	(dB/m)	(dB)	(dB)	(cm)	(deg)	(P/A)	(H/V)	
BT CH00 2402MHz		2347.83	48.72	-25.28	74	43.18	32.11	7.68	34.25	100	297	P	H	
		2347.83	23.96	-30.04	54	-	-	-	-	-	-	A	H	
	*	2402.3	100.21	-	-	94.58	32.18	7.75	34.3	100	297	P	H	
		2402.3	75.45	-	-	-	-	-	-	-	-	A	H	
													H	
													H	
			2389.56	52.1	-21.9	74	46.44	32.18	7.75	34.27	122	296	P	V
			2389.56	27.34	-26.66	54	-	-	-	-	-	-	A	V
	*		2401.91	108.4	-	-	102.77	32.18	7.75	34.3	122	296	P	V
			2401.91	83.64	-	-	-	-	-	-	-	-	A	V
													V	
													V	
BT CH 39 2441MHz		2330.33	48.52	-25.48	74	43.05	32.09	7.6	34.22	164	48	P	H	
		2330.33	23.76	-30.24	54	-	-	-	-	-	-	A	H	
	*	2441.1	101.28	-	-	95.6	32.24	7.83	34.39	164	48	P	H	
		2441.1	76.52	-	-	-	-	-	-	-	-	A	H	
			2492.02	47.82	-26.18	74	42.09	32.3	7.91	34.48	164	48	P	H
			2492.02	23.06	-30.94	54	-	-	-	-	-	-	A	H
			2337.55	48.36	-25.64	74	42.87	32.11	7.6	34.22	100	261	P	V
			2337.55	23.6	-30.4	54	-	-	-	-	-	-	A	V
	*		2440.91	107.91	-	-	102.23	32.24	7.83	34.39	100	261	P	V
			2440.91	83.15	-	-	-	-	-	-	-	-	A	V
			2499.05	48.8	-25.2	74	43.07	32.3	7.91	34.48	100	261	P	V
			2499.05	24.04	-29.96	54	-	-	-	-	-	-	A	V



BT CH 78 2480MHz	*	2480.05	101.54	-	-	95.78	32.28	7.91	34.43	100	329	P	H	
		2480.05	76.78	-	-	-	-	-	-	-	-	A	H	
		2483.5	53.2	-20.8	74	47.44	32.28	7.91	34.43	100	329	P	H	
		2483.5	28.44	-25.56	54	-	-	-	-	-	-	A	H	
													H	
													H	
	*	2480.05	107.85	-	-	102.09	32.28	7.91	34.43	107	278	P	V	
		2480.05	83.09	-	-	-	-	-	-	-	-	-	A	V
		2483.5	57.73	-16.27	74	51.97	32.28	7.91	34.43	107	278	P	V	
		2483.5	32.97	-21.03	54	-	-	-	-	-	-	-	A	V
													V	
													V	
BT CH 78 2480MHz + Base	*	2480.05	100.72	-	-	94.96	32.28	7.91	34.43	170	304	P	H	
		2480.05	75.96	-	-	-	-	-	-	-	-	A	H	
		2483.62	52.5	-21.5	74	46.74	32.28	7.91	34.43	170	304	P	H	
		2483.62	27.74	-26.26	54	-	-	-	-	-	-	A	H	
													H	
													H	
	*	2480.05	103.78	-	-	98.02	32.28	7.91	34.43	191	360	P	V	
		2480.05	79.02	-	-	-	-	-	-	-	-	-	A	V
		2483.48	55.07	-18.93	74	49.31	32.28	7.91	34.43	191	360	P	V	
		2483.48	30.31	-23.69	54	-	-	-	-	-	-	-	A	V
Remark	1. No other spurious found. 2. All results are PASS against Peak and Average limit line.													



2.4GHz 2400~2483.5MHz

BT (Harmonic @ 3m)

BT Ant. 2	Note	Frequency (MHz)	Level (dBμV/m)	Over Limit (dB)	Limit Line (dBμV/m)	Read Level (dBμV)	Antenna Factor (dB/m)	Cable Loss (dB)	Preamp Factor (dB)	Ant Pos (cm)	Table Pos (deg)	Peak Avg. (P/A)	Pol. (H/V)
BT CH 00 2402MHz		4804	52.09	-21.91	74	65.69	34.25	11.11	58.96	100	0	P	H
		4804	27.33	-26.67	54	-	-	-	-	-	-	A	H
													H
													H
		4804	50.93	-23.07	74	64.53	34.25	11.11	58.96	100	0	P	V
		4804	26.17	-27.83	54	-	-	-	-	-	-	A	V
													V
													V
BT CH 39 2441MHz		4882	52.81	-21.19	74	66.13	34.3	11.21	58.83	100	0	P	H
		4882	28.05	-25.95	54	-	-	-	-	-	-	A	H
		7323	51.44	-22.56	74	58.5	35.6	15.08	57.74	100	0	P	H
		7323	26.68	-27.32	54	-	-	-	-	-	-	A	H
		4882	53.85	-20.15	74	67.17	34.3	11.21	58.83	100	0	P	V
		4882	29.09	-24.91	54	-	-	-	-	-	-	A	V
		7323	53.01	-20.99	74	60.07	35.6	15.08	57.74	100	0	P	V
		7323	28.25	-25.75	54	-	-	-	-	-	-	A	V
BT CH 78 2480MHz		4962	55.1	-18.9	74	68.07	34.37	11.32	58.66	100	0	P	H
		4962	30.34	-23.66	54	-	-	-	-	-	-	A	H
		7440	51.08	-22.92	74	58.2	35.6	15.13	57.85	100	0	P	H
		7440	26.32	-27.68	54	-	-	-	-	-	-	A	H
		4962	56.87	-17.13	74	69.84	34.37	11.32	58.66	100	0	P	V
		4962	32.11	-21.89	54	-	-	-	-	-	-	A	V
		7440	50.04	-23.96	74	57.16	35.6	15.13	57.85	100	0	P	V
		7440	25.28	-28.72	54	-	-	-	-	-	-	A	V



BT CH 78 2480MHz + Base		4962	55.98	-18.02	74	69.74	34.37	11.32	59.45	100	0	P	H
		4962	31.22	-22.78	54	-	-	-	-	-	-	A	H
		7440	49.21	-24.79	74	57.12	35.6	15.13	58.64	100	0	P	H
		7440	24.45	-29.55	54	-	-	-	-	-	-	A	H
		4962	54.4	-19.6	74	68.16	34.37	11.32	59.45	100	0	P	V
		4962	29.64	-24.36	54	-	-	-	-	-	-	A	V
		7440	47.15	-26.85	74	55.06	35.6	15.13	58.64	100	0	P	V
		7440	22.39	-31.61	54	-	-	-	-	-	-	A	V

Remark	1. No other spurious found.												
	2. All results are PASS against Peak and Average limit line.												



Emission below 1GHz

2.4GHz BT (LF)

BT	Note	Frequency	Level	Over	Limit	Read	Antenna	Cable	Preamp	Ant	Table	Peak	Pol.	
Ant.				Limit	Line	Level	Factor	Loss	Factor	Pos	Pos	Avg.		
2		(MHz)	(dBμV/m)	(dB)	(dBμV/m)	(dBμV)	(dB/m)	(dB)	(dB)	(cm)	(deg)	(P/A)	(H/V)	
2.4GHz BT LF		105.33	26.53	-16.97	43.5	44.74	10.56	2.38	31.15	-	-	P	H	
		169.05	31.64	-11.86	43.5	50.42	9.72	2.61	31.11	-	-	P	H	
		277.86	39.68	-6.32	46	54.63	12.82	3.16	30.93	100	0	P	H	
		301.4	39.43	-6.57	46	53.93	13.22	3.28	31	-	-	P	H	
		720	38.57	-7.43	46	43.16	21.4	4.41	30.4	-	-	P	H	
		815.9	33.92	-12.08	46	37.25	22.38	4.62	30.33	-	-	P	H	
														H
														H
														H
														H
														H
														H
														H
			108.84	31.08	-12.42	43.5	49.15	10.74	2.38	31.19	-	-	P	V
			209.28	28.26	-15.24	43.5	47.48	9.19	2.69	31.1	-	-	P	V
			277.86	34.53	-11.47	46	49.48	12.82	3.16	30.93	-	-	P	V
			301.4	37.66	-8.34	46	52.16	13.22	3.28	31	100	0	P	V
			671.7	34.68	-11.32	46	40.37	20.42	4.35	30.46	-	-	P	V
			815.9	31.25	-14.75	46	34.58	22.38	4.62	30.33	-	-	P	V
														V
													V	
													V	
													V	
													V	
													V	
Remark	1. No other spurious found. 2. All results are PASS against limit line.													



Note symbol

*	Fundamental Frequency which can be ignored. However, the level of any unwanted emissions shall not exceed the level of the fundamental frequency.
!	Test result is over limit line.
P/A	Peak or Average
H/V	Horizontal or Vertical



A calculation example for radiated spurious emission is shown as below:

WIFI	Note	Frequency	Level	Over	Limit	Read	Antenna	Cable	Preamp	Ant	Table	Peak	Pol.
Ant.				Limit	Line	Level	Factor	Loss	Factor	Pos	Pos	Avg.	
1+2		(MHz)	(dBμV/m)	(dB)	(dBμV/m)	(dBμV)	(dB/m)	(dB)	(dB)	(cm)	(deg)	(P/A)	(H/V)
802.11b		2390	55.45	-18.55	74	54.51	32.22	4.58	35.86	103	308	P	H
CH 01													
2412MHz		2390	43.54	-10.46	54	42.6	32.22	4.58	35.86	103	308	A	H

- Level(dBμV/m) =
Antenna Factor(dB/m) + Cable Loss(dB) + Read Level(dBμV) - Preamp Factor(dB)
- Over Limit(dB) = Level(dBμV/m) – Limit Line(dBμV/m)

For Peak Limit @ 2390MHz:

- Level(dBμV/m)
= Antenna Factor(dB/m) + Cable Loss(dB) + Read Level(dBμV) - Preamp Factor(dB)
= 32.22(dB/m) + 4.58(dB) + 54.51(dBμV) – 35.86 (dB)
= 55.45 (dBμV/m)
- Over Limit(dB)
= Level(dBμV/m) – Limit Line(dBμV/m)
= 55.45(dBμV/m) – 74(dBμV/m)
= -18.55(dB)

For Average Limit @ 2390MHz:

- Level(dBμV/m)
= Antenna Factor(dB/m) + Cable Loss(dB) + Read Level(dBμV) - Preamp Factor(dB)
= 32.22(dB/m) + 4.58(dB) + 42.6(dBμV) – 35.86 (dB)
= 43.54 (dBμV/m)
- Over Limit(dB)
= Level(dBμV/m) – Limit Line(dBμV/m)
= 43.54(dBμV/m) – 54(dBμV/m)
= -10.46(dB)

Both peak and average measured complies with the limit line, so test result is “PASS”.



Appendix B. Radiated Spurious Emission Plots

2.4GHz 2400~2483.5MHz

BT (Band Edge @ 3m)

BT	2.4GHz 2400~2483.5MHz Band Edge @ 3m	
ANT	BT CH00 2402MHz	
1	Horizontal	Vertical
Peak	<p>Site : 03CH07-HY Condition : FCC CLASS-B 3m HF-ANT_130829 HORIZONTAL RBW:1000.000kHz VBW:5000.000kHz SWT:Auto Detector : Peak</p>	<p>Site : 03CH07-HY Condition : FCC CLASS-B 3m HF-ANT_130829 VERTICAL RBW:1000.000kHz VBW:5000.000kHz SWT:Auto Detector : Peak</p>

BT	2.4GHz 2400~2483.5MHz Band Edge @ 3m	
ANT	BT CH39 2441MHz	
1	Horizontal	Vertical
Peak	<p>Site : 03CH07-HY Condition : FCC CLASS-B 3m HF-ANT_130829 HORIZONTAL RBW:1000.000kHz VBW:5000.000kHz SWT:Auto Detector : Peak</p>	<p>Site : 03CH07-HY Condition : FCC CLASS-B 3m HF-ANT_130829 VERTICAL RBW:1000.000kHz VBW:5000.000kHz SWT:Auto Detector : Peak</p>



BT	2.4GHz 2400~2483.5MHz Band Edge @ 3m	
ANT	BT CH78 2480MHz	
1	Horizontal	Vertical
Peak	<p>Site : 03CH07-HY Condition : FCC CLASS-B 3m HF-ANT_130829 HORIZONTAL RBW:1000.000kHz VBW:3000.000kHz SWT:Auto Detector : Peak</p>	<p>Site : 03CH07-HY Condition : FCC CLASS-B 3m HF-ANT_130829 VERTICAL RBW:1000.000kHz VBW:3000.000kHz SWT:Auto Detector : Peak</p>



2.4GHz 2400~2483.5MHz

BT (Harmonic @ 3m)

BT	2.4GHz 2400~2483.5MHz Harmonic @ 3m	
ANT	BT CH00 2402MHz	
1	Horizontal	Vertical
Peak	<p>Site : 03CH07-HY Condition : FCC CLASS-B 3m SHF-EHF_131029 HORIZONTAL RBW: 1000.000KHz VBW: 3000.000KHz SWT: Auto Detector : Peak</p>	<p>Site : 03CH07-HY Condition : FCC CLASS-B 3m SHF-EHF_131029 VERTICAL RBW: 1000.000KHz VBW: 3000.000KHz SWT: Auto Detector : Peak</p>

BT	2.4GHz 2400~2483.5MHz Harmonic @ 3m	
ANT	BT CH39 2441MHz	
1	Horizontal	Vertical
Peak	<p>Site : 03CH07-HY Condition : FCC CLASS-B 3m SHF-EHF_131029 HORIZONTAL RBW: 1000.000KHz VBW: 3000.000KHz SWT: Auto Detector : Peak</p>	<p>Site : 03CH07-HY Condition : FCC CLASS-B 3m SHF-EHF_131029 VERTICAL RBW: 1000.000KHz VBW: 3000.000KHz SWT: Auto Detector : Peak</p>



BT	2.4GHz 2400~2483.5MHz Harmonic @ 3m	
ANT	BT CH78 2480MHz	
1	Horizontal	Vertical
Peak	<p>Site : 03CH07-HY Condition : FCC CLASS-B 3m SHF-EHF_131029 HORIZONTAL RBW:1000.000kHz VBW:3000.000kHz SWT:Auto Detector : Peak</p>	<p>Site : 03CH07-HY Condition : FCC CLASS-B 3m SHF-EHF_131029 VERTICAL RBW:1000.000kHz VBW:3000.000kHz SWT:Auto Detector : Peak</p>



Emission below 1GHz

2.4GHz BT (LF)

BT	2.4GHz 2400~2483.5MHz	
ANT	BT LF	
1	Horizontal	Vertical
QP / Peak	<p>Site : 03CH07-HY Condition : FCC CLASS-B 3m LF-ANT(131102) HORIZONTAL Detector : Peak</p>	<p>Site : 03CH07-HY Condition : FCC CLASS-B 3m LF-ANT(131102) VERTICAL Detector : Peak</p>



2.4GHz 2400~2483.5MHz

BT (Band Edge @ 3m)

BT	2.4GHz 2400~2483.5MHz Band Edge @ 3m	
ANT	BT CH00 2402MHz	
2	Horizontal	Vertical
Peak	<p>Site : 03CH07-HY Condition : FCC CLASS-B 3m HF-ANT_130829 HORIZONTAL Detector : Peak RBW:1000.000kHz VBW:3000.000kHz SWT:Auto</p>	<p>Site : 03CH07-HY Condition : FCC CLASS-B 3m HF-ANT_130829 VERTICAL Detector : Peak RBW:1000.000kHz VBW:3000.000kHz SWT:Auto</p>

BT	2.4GHz 2400~2483.5MHz Band Edge @ 3m	
ANT	BT CH39 2441MHz	
2	Horizontal	Vertical
Peak	<p>Site : 03CH07-HY Condition : FCC CLASS-B 3m HF-ANT_130829 HORIZONTAL Detector : Peak RBW:1000.000kHz VBW:3000.000kHz SWT:Auto</p>	<p>Site : 03CH07-HY Condition : FCC CLASS-B 3m HF-ANT_130829 VERTICAL Detector : Peak RBW:1000.000kHz VBW:3000.000kHz SWT:Auto</p>



BT	2.4GHz 2400~2483.5MHz Band Edge @ 3m	
ANT	BT CH78 2480MHz	
2	Horizontal	Vertical
Peak	<p>Site : 03CH07-HY Condition : FCC CLASS-B 3m HF-ANT_130829 HORIZONTAL RBW: 1000.000kHz VBW:3000.000kHz SWT:Auto Detector : Peak</p>	<p>Site : 03CH07-HY Condition : FCC CLASS-B 3m HF-ANT_130829 VERTICAL RBW: 1000.000kHz VBW:3000.000kHz SWT:Auto Detector : Peak</p>

BT	2.4GHz 2400~2483.5MHz Band Edge @ 3m	
ANT	BT CH78 2480MHz with Base	
2	Horizontal	Vertical
Peak	<p>Site : 03CH07-HY Condition : FCC CLASS-B 3m HF-ANT_130829 HORIZONTAL RBW: 1000.000kHz VBW:3000.000kHz SWT:Auto Detector : Peak</p>	<p>Site : 03CH07-HY Condition : FCC CLASS-B 3m HF-ANT_130829 VERTICAL RBW: 1000.000kHz VBW:3000.000kHz SWT:Auto Detector : Peak</p>



2.4GHz 2400~2483.5MHz

BT (Harmonic @ 3m)

BT	2.4GHz 2400~2483.5MHz Harmonic @ 3m	
ANT	BT CH00 2402MHz	
2	Horizontal	Vertical
Peak	<p>Site : 03CH07-HY Condition : FCC CLASS-B 3m SHF-EHF_131029 HORIZONTAL Detector : Peak</p>	<p>Site : 03CH07-HY Condition : FCC CLASS-B 3m SHF-EHF_131029 VERTICAL Detector : Peak</p>

BT	2.4GHz 2400~2483.5MHz Harmonic @ 3m	
ANT	BT CH39 2441MHz	
2	Horizontal	Vertical
Peak	<p>Site : 03CH07-HY Condition : FCC CLASS-B 3m SHF-EHF_131029 HORIZONTAL Detector : Peak</p>	<p>Site : 03CH07-HY Condition : FCC CLASS-B 3m SHF-EHF_131029 VERTICAL Detector : Peak</p>



BT	2.4GHz 2400~2483.5MHz Harmonic @ 3m	
ANT	BT CH78 2480MHz	
2	Horizontal	Vertical
Peak	<p>Site : 03CH07-HY Condition : FCC CLASS-B 3m SHF-EHF_131029 HORIZONTAL Detector : Peak</p>	<p>Site : 03CH07-HY Condition : FCC CLASS-B 3m SHF-EHF_131029 VERTICAL Detector : Peak</p>

BT	2.4GHz 2400~2483.5MHz Harmonic @ 3m	
ANT	BT CH78 2480MHz with Base	
2	Horizontal	Vertical
Peak	<p>Site : 03CH07-HY Condition : FCC CLASS-B 3m SHF-EHF_131029 HORIZONTAL RBW: 1000.000kHz VBW:3000.000kHz SWT:Auto Detector : Peak</p>	<p>Site : 03CH07-HY Condition : FCC CLASS-B 3m SHF-EHF_131029 VERTICAL RBW: 1000.000kHz VBW:3000.000kHz SWT:Auto Detector : Peak</p>



Emission below 1GHz

2.4GHz BT (LF)

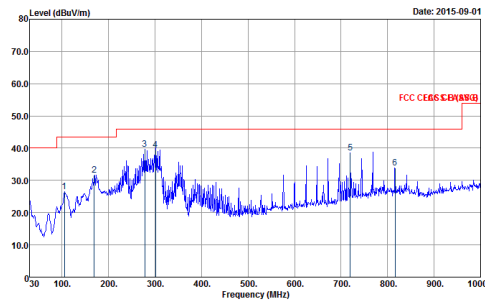
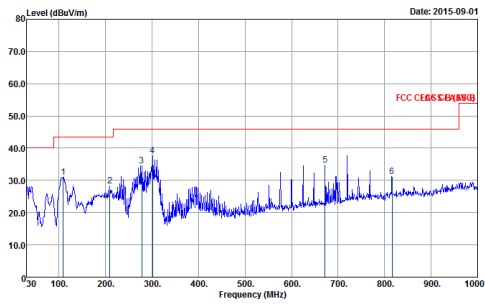
BT	2.4GHz 2400~2483.5MHz	
ANT	BT LF	
2	Horizontal	Vertical
QP / Peak	 <p>Site : 03CH07-HY Condition : FCC CLASS-B 3m LF-ANT(131102) HORIZONTAL Detector : Peak</p>	 <p>Site : 03CH07-HY Condition : FCC CLASS-B 3m LF-ANT(131102) VERTICAL Detector : Peak</p>