



# RF TEST REPORT

**Applicant** UAB Teltonika  
**FCC ID** 2AET4RUT955V  
**Product** LTE Router  
**Brand** Teltonika  
**Model** RUT955  
**Report No.** RXA1708-0302RF02R1  
**Issue Date** December 15, 2017

TA Technology (Shanghai) Co., Ltd. tested the above equipment in accordance with the requirements in **FCC CFR47 Part 15C (2017)**. The test results show that the equipment tested is capable of demonstrating compliance with the requirements as documented in this report.

*Performed by: Xianqing Li*

*Approved by: Kai Xu*

---

## TA Technology (Shanghai) Co., Ltd.

No.145, Jintang Rd, Tangzhen Industry Park, Pudong Shanghai, China

TEL: +86-021-50791141/2/3

FAX: +86-021-50791141/2/3-8000



# TABLE OF CONTENT

- 1. Test Laboratory ..... 4
  - 1.1. Notes of the test report..... 4
  - 1.2. Test facility ..... 4
  - 1.3. Testing Location..... 5
- 2. General Description of Equipment under Test..... 6
- 3. Applied Standards ..... 7
- 4. Test Configuration ..... 8
- 5. Test Case Results ..... 9
  - 5.1. Average Power Output –Conducted..... 9
  - 5.2. 6dB Bandwidth ..... 12
  - 5.3. Band Edge ..... 16
  - 5.4. Power Spectral Density ..... 18
  - 5.5. Spurious RF Conducted Emissions..... 24
  - 5.6. Radiated Emissions in the Restricted Band ..... 30
  - 5.7. Radiates Emission ..... 35
  - 5.8. Conducted Emission ..... 63
- 6. Main Test Instruments ..... 65



## Summary of measurement results

Number	Summary of measurements of results	Clause in FCC rules	Verdict
1	Maximum Average conducted output power	15.247(b)(3)	PASS
2	6 dB bandwidth	15.247(a)(2)	PASS
3	Power spectral density	15.247(e)	PASS
4	Band Edge	15.247(d)	PASS
5	Spurious RF Conducted Emissions	15.247(d)	PASS
6	Radiated Emissions in restricted frequency bands	15.247(d),15.205,15.209	PASS
7	Radiated Emissions	15.247(d),15.205,15.209	PASS
8	Conducted Emissions	15.207	PASS
Date of Testing: November 11, 2017 ~ November 29, 2017			



## 1. Test Laboratory

### 1.1. Notes of the test report

This report shall not be reproduced in full or partial, without the written approval of **TA technology (shanghai) co., Ltd.** The results documented in this report apply only to the tested sample, under the conditions and modes of operation as described herein .Measurement Uncertainties were not taken into account and are published for informational purposes only. This report is written to support regulatory compliance of the applicable standards stated above.

### 1.2. Test facility

#### **CNAS (accreditation number: L2264)**

TA Technology (Shanghai) Co., Ltd. has obtained the accreditation of China National Accreditation Service for Conformity Assessment (CNAS).

#### **FCC (Designation number: CN1179, Test Firm Registration Number: 446626)**

TA Technology (Shanghai) Co., Ltd. has been listed on the US Federal Communications Commission list of test facilities recognized to perform electromagnetic emissions measurements.

#### **IC (recognition number is 8510A)**

TA Technology (Shanghai) Co., Ltd. has been listed by industry Canada to perform electromagnetic emission measurement.

#### **VCCI (recognition number is C-4595, T-2154, R-4113, G-10766)**

TA Technology (Shanghai) Co., Ltd. has been listed by industry Japan to perform electromagnetic emission measurement.

#### **A2LA (Certificate Number: 3857.01)**

TA Technology (Shanghai) Co., Ltd. has been listed by American Association for Laboratory Accreditation to perform electromagnetic emission measurement.



### 1.3. Testing Location

Company: TA Technology (Shanghai) Co., Ltd.  
Address: No.145, Jintang Rd, Tangzhen Industry Park, Pudong  
City: Shanghai  
Post code: 201201  
Country: P. R. China  
Contact: Xu Kai  
Telephone: +86-021-50791141/2/3  
Fax: +86-021-50791141/2/3-8000  
Website: <http://www.ta-shanghai.com>  
E-mail: [xukai@ta-shanghai.com](mailto:xukai@ta-shanghai.com)

## 2. General Description of Equipment under Test

### Client Information

Applicant	UAB TELTONIKA
Applicant address	Saltoniskiu st. 10c, Vilnius, Lithuania
Manufacturer	UAB TELTONIKA
Manufacturer address	Saltoniskiu st. 10c, Vilnius, Lithuania

### General information

EUT Description	
Model	RUT955
IMEI	861107031550883
Hardware Version	11
Software Version	RUT9XX_R_00.03.832
Power Supply	Adapter
Antenna Type	Sub or Retractable Antenna
Antenna Gain	5.00 dBi
additional beamforming gain	0 dB
Test Mode	802.11b 802.11g, 802.11n(HT20/HT40);
Modulation Type	802.11b: DSSS; 802.11g/n(HT20/HT40): OFDM
Max. Conducted Power	Wi-Fi 2.4G :12.43dBm
Operating Frequency Range(s)	802.11b/g/n(HT20): 2412 ~ 2462 MHz 802.11n(HT40): 2422 ~ 2452 MHz
EUT Accessory	
Adapter	Manufacturer: Shenzhen Shengi Mains Model: SJ-38809010001
LTE antenna	Manufacturer: Beyondoors Model: BY-LTE-06-02-Sticker-LTE
WiFi antenna	Manufacturer: Beyondoors Model: BY-2400-03-Sticker-WiFi
Note: The information of the EUT is declared by the manufacturer.	



### 3. Applied Standards

According to the specifications of the manufacturer, it must comply with the requirements of the following standards:

#### Test standards

- **FCC CFR47 Part 15C (2017) Radio Frequency Devices**
- **ANSI C63.10 (2013)**
- **KDB 558074 D01 DTS Meas Guidance v04**
- **KDB 662911 D01 Multiple Transmitter Output v02r01**

## 4. Test Configuration

### Test Mode

The EUT has been associated with peripherals and configuration operated in a manner tended to maximize its emission characteristics in a typical application.

The radiated emission was measured in the following position: EUT stand-up position (Z axis), lie-down position (X, Y axis). The worst emission was found in stand-up position (Zaxis) and the worst case was recorded.

In order to find the worst case condition, Pre-tests are needed at the presence of different data rate. Preliminary tests have been done on all the configuration for confirming worst case. Data rate below means worst-case rate of each test item.

### The test software is used ARTGUI

The worst case Antenna mode for each of the following tests for Wi-Fi:

Test Cases	MIMO Antenna 1	MIMO Antenna 2
Average Power Output –Conducted	O	O
6dB Bandwidth	--	O
Band Edge	--	O
Power Spectral Density	O	O
Spurious RF Conducted Emissions	O	O
Radiates Emission in the Restricted Band	--	O
Radiates Emission	--	O
Conducted Emission	--	O
Note: "O": test all bands		



## 5. Test Case Results

### 5.1. Average Power Output –Conducted

#### Ambient condition

Temperature	Relative humidity	Pressure
23°C ~25°C	45%~50%	101.5kPa

#### Methods of Measurement

During the process of the testing, The EUT was connected to Spectrum Analyzer with a known loss. The EUT is max power transmission with proper modulation. The Average detector is used. We use Maximum Average Conducted Output Power Level Method in KDB 558074 D01 for this test.

The conducted Power is measured at each antenna port. The measured results at the various antenna ports are then summed mathematically.

#### Test Setup

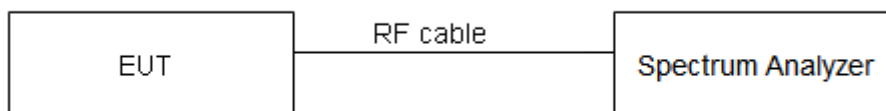

#### Limits

Rule Part 15.247 (b) (3) specifies that " For systems using digital modulation in the 902–928 MHz, 2400–2483.5 MHz: 1 Watt."

Average Output Power	$\leq 1W$ (30dBm)
----------------------	-------------------

#### Measurement Uncertainty

The assessed measurement uncertainty to ensure 95% confidence level for the normal distribution is with the coverage factor  $k = 2$ ,  $U = 0.44$  dB.

**Test Results**

MIMO Antenna Power Index						
Packet Type	Antenna 1			Antenna 2		
	CH1	CH6	CH11	CH1	CH6	CH11
802.11b	10	10	10	10	10	10
802.11g	10	10	10	10	10	10
802.11n HT20	10	10	10	10	10	10
Packet Type	CH3	CH6	CH9	CH3	CH6	CH9
802.11n HT40	10	10	10	10	10	10

Band	T <sub>on</sub> (ms)	T <sub>(on+off)</sub> (ms)	Duty cycle	Duty cycle correction Factor(dB)
802.11b	8.18	8.24	0.99	NA
802.11g	1.36	1.41	0.96	0.16
802.11n HT20	1.27	1.32	0.96	0.16
802.11n HT40	0.63	0.67	0.94	0.27
Note: when Duty cycle>0.98, Duty cycle correction Factor not required.				

**MIMO**

Network Standards	Carrier frequency (MHz)	Antenna 1			Antenna 2			Total Power		Limit (dBm)	Conclusion
		Read Value (dBm)	Average Output Power		Read Value (dBm)	Average Output Power		Average Output Power			
			(dBm)	(mW)		(dBm)	(dBm)	(mW)	(dBm)		
802.11b	2412	4.68	4.68	2.94	11.39	11.39	13.77	16.71	12.23	30	PASS
	2437	5.28	5.28	3.37	10.12	10.12	10.28	13.65	11.35	30	PASS
	2462	5.95	5.95	3.94	8.87	8.87	7.71	11.64	10.66	30	PASS
802.11g	2412	4.85	5.01	3.17	11.40	11.56	14.32	17.49	12.43	30	PASS
	2437	5.48	5.64	3.66	10.21	10.37	10.89	14.55	11.63	30	PASS
	2462	5.95	6.11	4.08	9.04	9.20	8.32	12.40	10.93	30	PASS
802.11n HT20	2412	4.90	5.06	3.21	10.87	11.03	12.68	15.88	12.01	30	PASS
	2437	5.49	5.65	3.67	10.24	10.40	10.96	14.64	11.65	30	PASS
	2462	5.55	5.71	3.72	9.07	9.23	8.38	12.10	10.83	30	PASS
802.11n HT40	2422	5.08	5.35	3.43	11.17	11.44	13.93	17.36	12.40	30	PASS
	2437	5.30	5.57	3.61	9.91	10.18	10.42	14.03	11.47	30	PASS
	2452	6.15	6.42	4.39	9.77	10.04	10.09	14.48	11.61	30	PASS

Note: 1. Output Power=Read Value+Duty cycle correction factor  
 2. For Total Power, according to KDB 662911 D01 Multiple Transmitter Output v02r01 1),  
 The Total Power =  $10\log(10^{(\text{Power antenna1 in dBm}/10)} + 10^{(\text{Power antenna2 in dBm}/10)})$ .  
 3. The manufacturer declared the transmitter output signals is CDD mode. And  $N_{ss}=2$ . According to KDB 662911 D01 Multiple Transmitter Output v02r01 2)f)(i): If all antennas have the same gain,  
 Directional gain =  $G_{ANT} + \text{Array Gain}$ ,  
 For power measurements on IEEE 802.11 devices,  
 Array Gain = 0 dB (i.e., no array gain) for  $N_{ANT} \leq 4$ ;  
 Array Gain = 0 dB (i.e., no array gain) for channel widths  $\geq 40$  MHz for any  $N_{ANT}$ ;  
 Array Gain =  $5 \log(N_{ANT}/N_{SS})$  dB or 3 dB, whichever is less, for 20-MHz channel widths with  $N_{ANT} \geq 5$ .  
 So directional gain =  $G_{ANT} + \text{Array Gain} = 5 + 0 = 5 \text{ dB} < 6 \text{ dBi}$ . So the power limit is 30dBm

## 5.2. 6dB Bandwidth

### Ambient condition

Temperature	Relative humidity	Pressure
23°C ~25°C	45%~50%	101.5kPa

### Method of Measurement

The EUT was connected to the spectrum analyzer through an external attenuator (20dB) and a known loss cable. RBW is set to 100 kHz; VBW is set to 300 kHz on spectrum analyzer.

### Test Setup

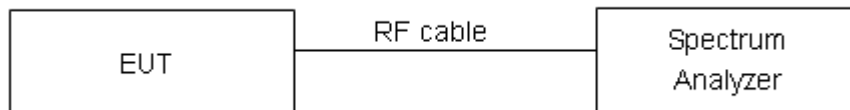

### Limits

Rule Part 15.247 (a) (2) specifies that “Systems using digital modulation techniques may operate in the 902–928 MHz, 2400–2483.5 MHz bands. The minimum 6 dB bandwidth shall be at least 500 kHz.”

minimum 6 dB bandwidth	≥ 500 kHz
------------------------	-----------

### Measurement Uncertainty

The assessed measurement uncertainty to ensure 95% confidence level for the normal distribution is with the coverage factor  $k = 2$ ,  $U = 936$  Hz.

**Test Results:****MIMO Antenna 2**

Network Standards	Carrier frequency (MHz)	99% bandwidth (MHz)	Minimum 6 dB bandwidth (MHz)	Limit (kHz)	Conclusion
802.11b	2412	13.900	10.11	500	PASS
	2437	13.912	10.11	500	PASS
	2462	13.888	10.09	500	PASS
802.11g	2412	16.496	16.49	500	PASS
	2437	16.511	16.56	500	PASS
	2462	16.494	16.50	500	PASS
802.11n HT20	2412	17.695	17.65	500	PASS
	2437	17.696	17.64	500	PASS
	2462	17.711	17.74	500	PASS
802.11n HT40	2422	36.287	36.11	500	PASS
	2437	36.342	36.54	500	PASS
	2452	36.342	36.50	500	PASS



### MIMO Antenna 2

802.11b, Carrier frequency (MHz): 2412



802.11g, Carrier frequency (MHz): 2412



802.11b, Carrier frequency (MHz): 2437



802.11g, Carrier frequency (MHz): 2437



802.11b, Carrier frequency (MHz): 2462



802.11g, Carrier frequency (MHz): 2462



802.11n(HT20), Carrier frequency (MHz): 2412



802.11n(HT40), Carrier frequency (MHz): 2422



802.11n(HT20), Carrier frequency (MHz): 2437



802.11n(HT40), Carrier frequency (MHz): 2437



802.11n(HT20), Carrier frequency (MHz):2462



802.11n(HT40), Carrier frequency (MHz):2452



### 5.3. Band Edge

#### Ambient condition

Temperature	Relative humidity	Pressure
23°C ~25°C	45%~50%	101.5kPa

#### Method of Measurement

The EUT was connected to the spectrum analyzer through an external attenuator (20dB) and a known loss cable the band edge of the lowest and highest channels were measured. The peak detector is used and RBW is set to 100 kHz and VBW is set to 300 kHz on spectrum analyzer. Spectrum analyzer plots are included on the following pages.

#### Test Setup

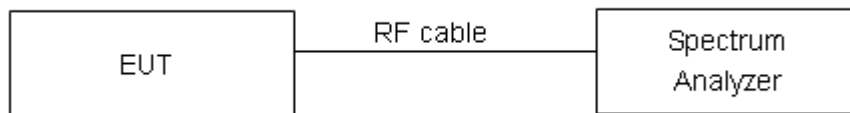

#### Limits

Rule Part 15.247(d) specifies that “In any 100 kHz bandwidth outside the frequency band in which the spread spectrum or digitally modulated intentional radiator is operating, the radio frequency power that is produced by the intentional radiator shall be at least 20 dB below that in the 100 kHz bandwidth within the band that contains the highest level of the desired power, based on either an RF conducted or a radiated measurement, provided the transmitter demonstrates compliance with the peak conducted power limits.”

#### Measurement Uncertainty

The assessed measurement uncertainty to ensure 95% confidence level for the normal distribution is with the coverage factor  $k = 1.96$ .

Frequency	Uncertainty
2GHz-3GHz	1.407 dB





Test Results: PASS

MIMO Antenna 2

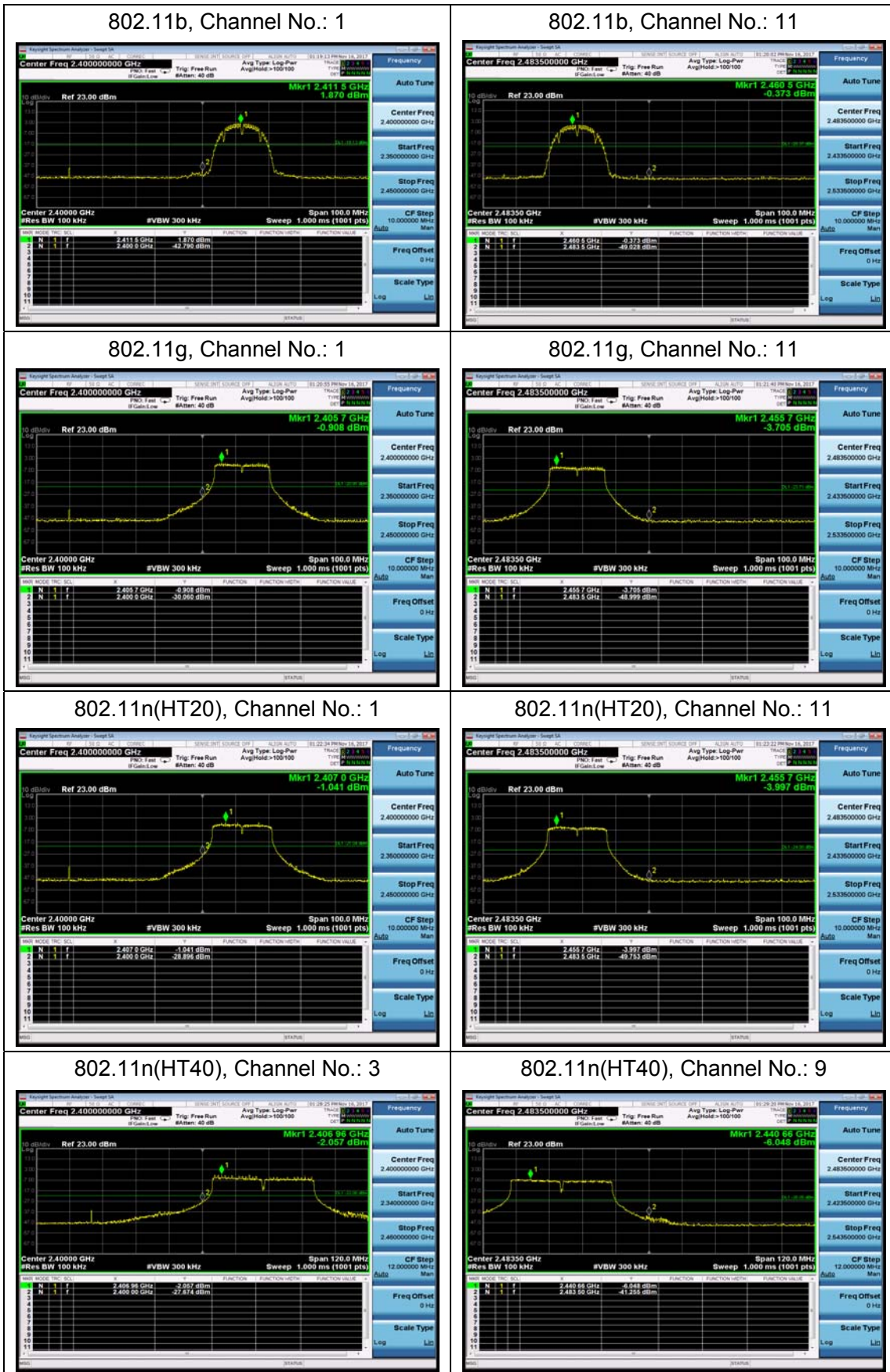

### 5.4. Power Spectral Density

#### Ambient condition

Temperature	Relative humidity	Pressure
23°C ~25°C	45%~50%	101.5kPa

#### Method of Measurement

The EUT was connected to the spectrum analyzer through an external attenuator (20dB) and a known loss cable.

RBW is set to 3 kHz and VBW is set to 10 kHz for Wi-Fi 2.4G on spectrum analyzer.

Set the span to 1.5 times the DTS channel bandwidth. Sweep time = auto couple. Trace mode = max hold. The Average power spectral density is recorded.

The conducted Power is measured at each antenna port. The measured results at the various antenna ports are then summed mathematically.

#### Test setup

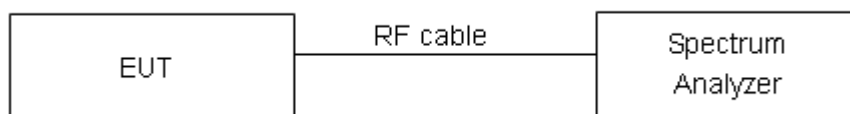

#### Limits

Rule Part 15.247(e) specifies that” For digitally modulated systems, the power spectral density conducted from the intentional radiator to the antenna shall not be greater than 8 dBm in any 3 kHz band during any time interval of continuous transmission. ”

Limits	≤ 8 dBm / 3kHz
--------	----------------

#### Measurement Uncertainty

The assessed measurement uncertainty to ensure 95% confidence level for the normal distribution is with the coverage factor  $k = 2$ ,  $U = 0.75\text{dB}$ .

**Test Results:****MIMO**

Network Standards	Channel Number	Antenna 1			Antenna 2			Total PSD		Limit (dBm / 3kHz)	Conclusion
		Read Value (dBm / 3kHz)	Power Spectral Density		Read Value (dBm / 3kHz)	Power Spectral Density		Power Spectral Density			
			(dBm / 3kHz)	(mW/ 3kHz)		(dBm / 3kHz)	(mW/ 3kHz)	(mW/ 3kHz)	(dBm / 3kHz)		
802.11n HT20	1	-28.661	-28.661	0.001	-22.283	-22.283	0.006	0.007	-21.383	8	PASS
	6	-28.044	-28.044	0.002	-23.594	-23.594	0.004	0.006	-22.262	8	PASS
	11	-27.654	-27.654	0.002	-24.649	-24.649	0.003	0.005	-22.886	8	PASS
802.11b	1	-30.251	-30.088	0.001	-23.974	-23.811	0.004	0.005	-22.892	8	PASS
	6	-29.197	-29.034	0.001	-25.239	-25.076	0.003	0.004	-23.609	8	PASS
	11	-29.191	-29.028	0.001	-26.365	-26.202	0.002	0.004	-24.379	8	PASS
802.11g	1	-30.289	-30.128	0.001	-24.059	-23.898	0.004	0.005	-22.970	8	PASS
	6	-29.537	-29.376	0.001	-25.502	-25.341	0.003	0.004	-23.896	8	PASS
	11	-29.563	-29.402	0.001	-26.520	-26.359	0.002	0.003	-24.609	8	PASS
802.11n HT40	3	-32.708	-32.441	0.001	-29.956	-29.689	0.001	0.002	-27.840	8	PASS
	6	-32.120	-31.853	0.001	-28.852	-28.585	0.001	0.002	-26.908	8	PASS
	9	-32.282	-32.015	0.001	-28.686	-28.419	0.001	0.002	-26.845	8	PASS

Note: 1. Power Spectral Density = Read Value + Duty cycle correction factor

2. For Total PSD, according to KDB 662911 D01 Multiple Transmitter Output v02r01 2)a), the power spectral density =  $10\log(10^{(PSD\ antenna1\ in\ dBm/10)} + 10^{(PSD\ antenna2\ in\ dBm/10)})$

3. The manufacturer declared the transmitter output signals is CDD mode And Nss=2. According to KDB 662911 D01 Multiple Transmitter Output v02r01 2)f)(i): If all antennas have the same gain, Directional gain = GANT + Array Gain, For PSD measurements on all devices,

Array Gain =  $10\log(Nant/Nss)$  dB,

so directional gain = GANT + Array Gain =  $5 + 10\log(2/2) = 5 < 6$  dBi. So the PSD limit is 8 dBm.



### MIMO Antenna 1

#### 802.11b, Channel No.: 1



#### 802.11g, Channel No.: 1

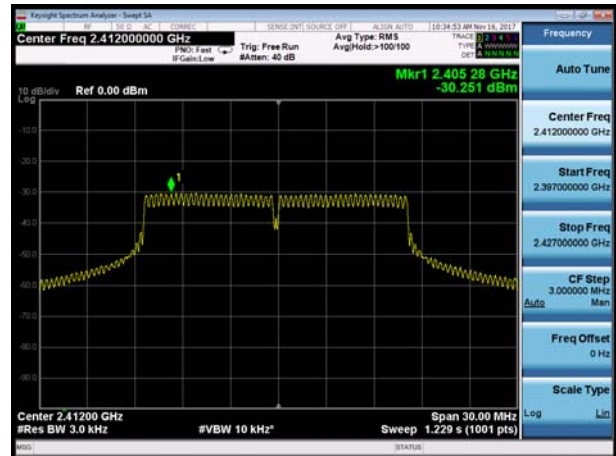

#### 802.11b, Channel No.: 6



#### 802.11g, Channel No.: 6



#### 802.11b, Channel No.: 11



#### 802.11g, Channel No.: 11

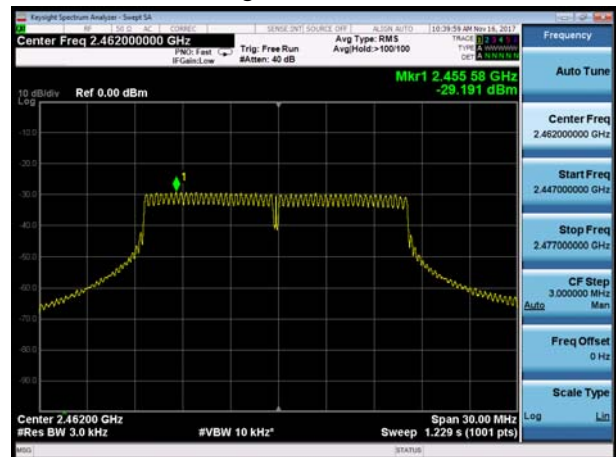



802.11n(HT20), Channel No. 1



802.11n(HT40), Channel No. 3



802.11n(HT20), Channel No. 6



802.11n(HT40), Channel No. 6



802.11n(HT20), Channel No. 11

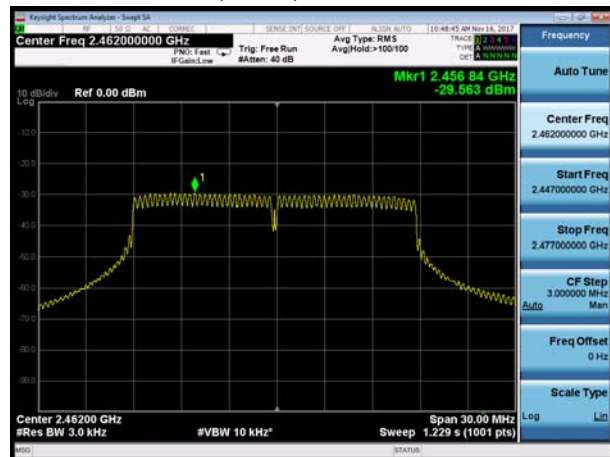

802.11n(HT40), Channel No. 9





### MIMO Antenna 2

#### 802.11b, Channel No.: 1



#### 802.11g, Channel No.: 1

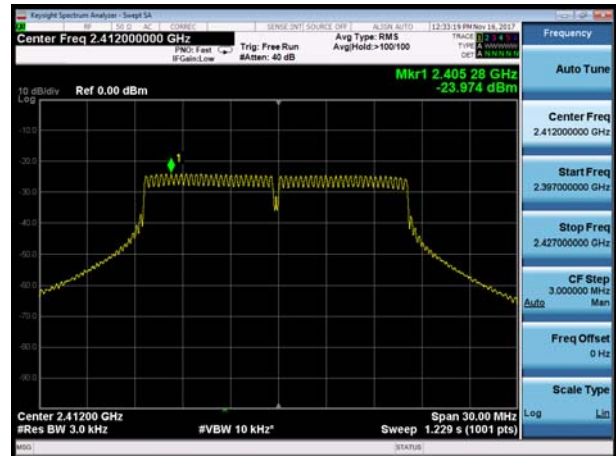

#### 802.11b, Channel No.: 6



#### 802.11g, Channel No.: 6

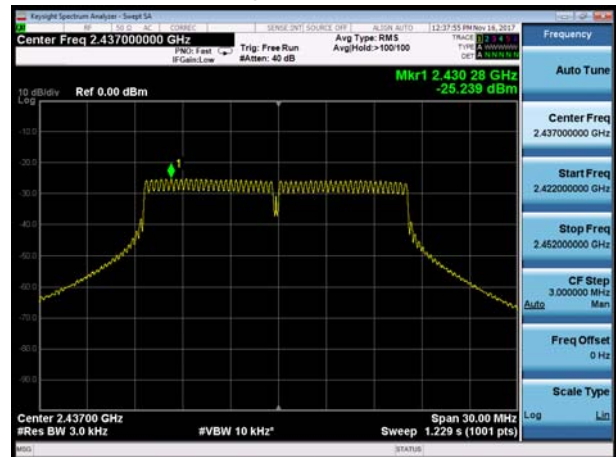

#### 802.11b, Channel No.: 11

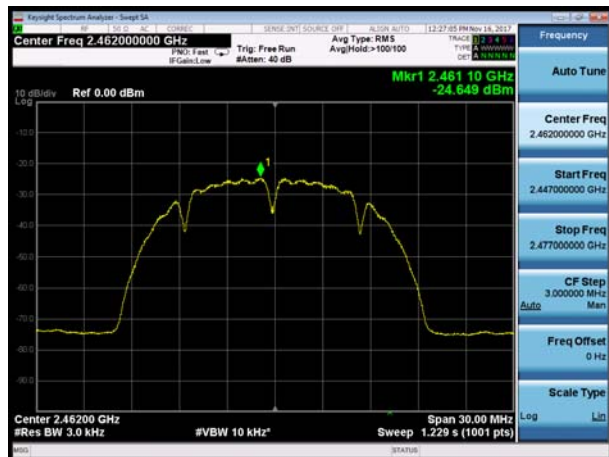

#### 802.11g, Channel No.: 11

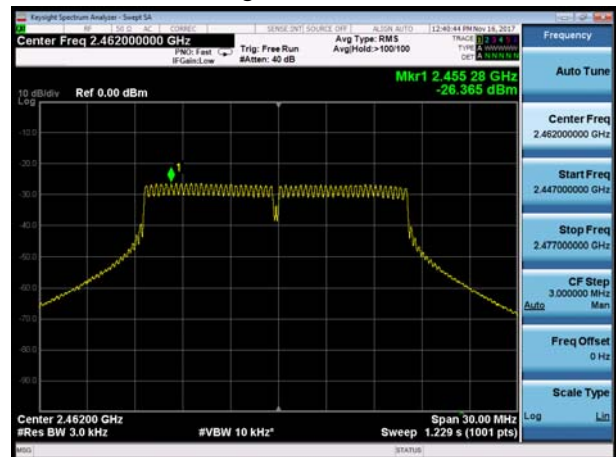



802.11n(HT20), Channel No. 1

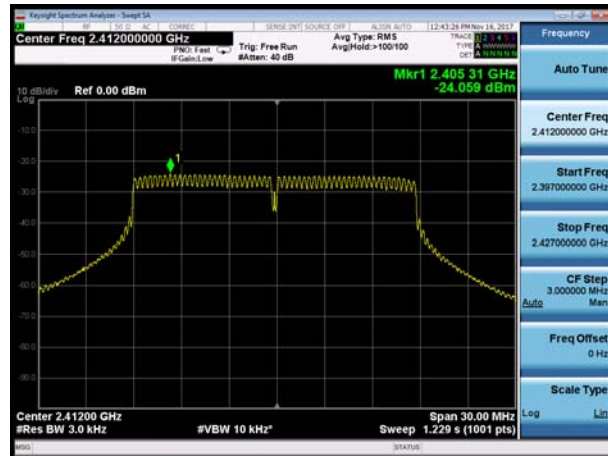

802.11n(HT40), Channel No. 3

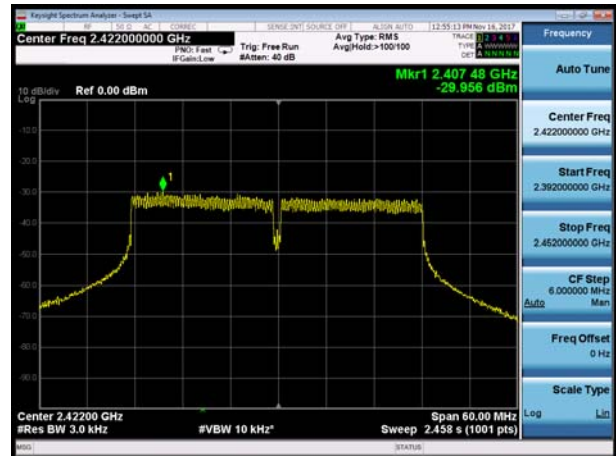

802.11n(HT20), Channel No. 6

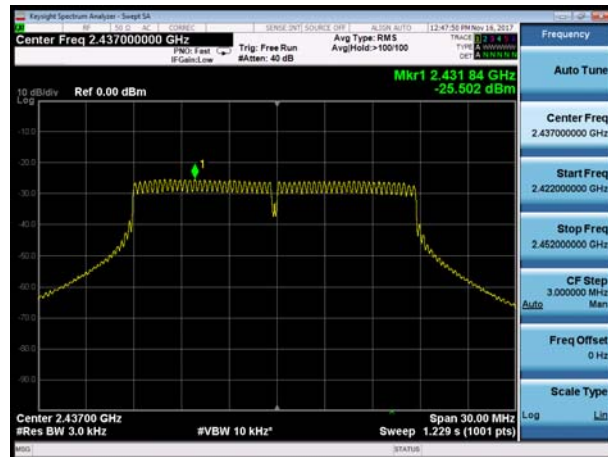

802.11n(HT40), Channel No. 6

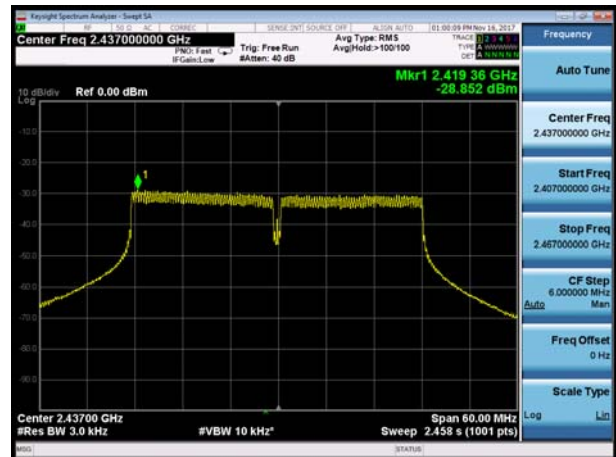

802.11n(HT20), Channel No. 11

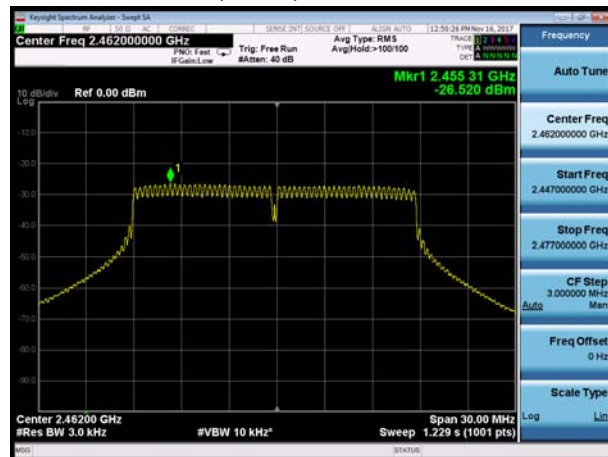

802.11n(HT40), Channel No. 9



### 5.5. Spurious RF Conducted Emissions

**Ambient condition**

Temperature	Relative humidity	Pressure
23°C ~25°C	45%~50%	101.5kPa

**Method of Measurement**

The EUT was connected to the spectrum analyzer with a known loss. The spectrum analyzer scans from 30MHz to the 10th harmonic of the carrier. The peak detector is used. Set RBW to100kHz and VBW to 300 kHz, Sweep is set to ATUO.

The test is in transmitting mode.

**Test setup**



**Limits**

Rule Part 15.247(d) pacifies that “In any 100 kHz bandwidth outside the frequency band in which the spread spectrum intentional radiator is operating, the radio frequency power that is produced by the intentional radiator shall be at least 20 dB below that in the 100 kHz bandwidth within the band that contains the highest level of the desired power.”

**MIMO**

Network Standards	Carrier frequency (MHz)	Reference value (dBm)	Limit
802.11b	2412	4.619	-15.381
	2437	4.137	-15.863
	2462	3.339	-16.661
802.11g	2412	8.107	-11.893
	2437	8.003	-11.997
	2462	6.85	-13.15
802.11n HT20	2412	8.631	-11.369
	2437	6.884	-13.116
	2462	6.734	-13.266
802.11n HT40	2422	5.052	-14.948
	2437	4.735	-15.265
	2452	4.677	-15.323



**Measurement Uncertainty**

The assessed measurement uncertainty to ensure 95% confidence level for the normal distribution is with the coverage factor  $k = 1.96$ .

Frequency	Uncertainty
100kHz-2GHz	0.684 dB
2GHz-26GHz	1.407 dB



Test Results:

MIMO

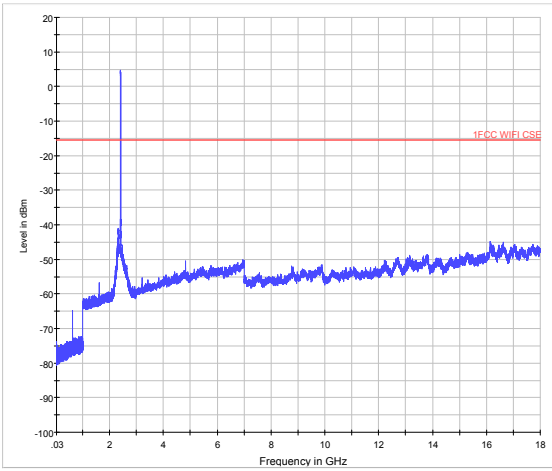

802.11b CH1 30MHz to 18GHz

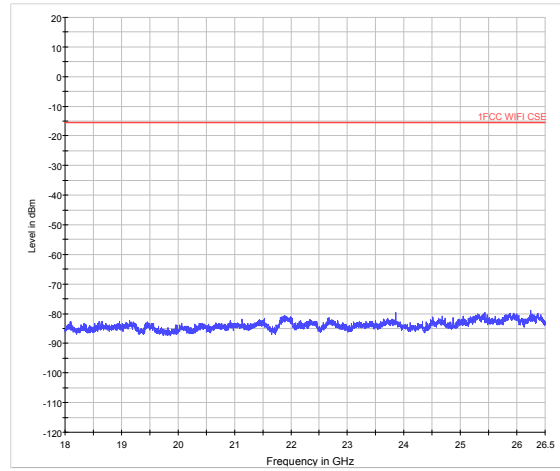

802.11b CH1 18GHz to 26.5GHz

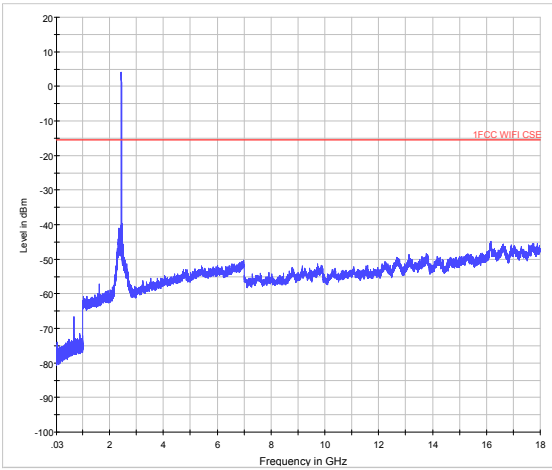

802.11b CH6 30MHz to 18GHz

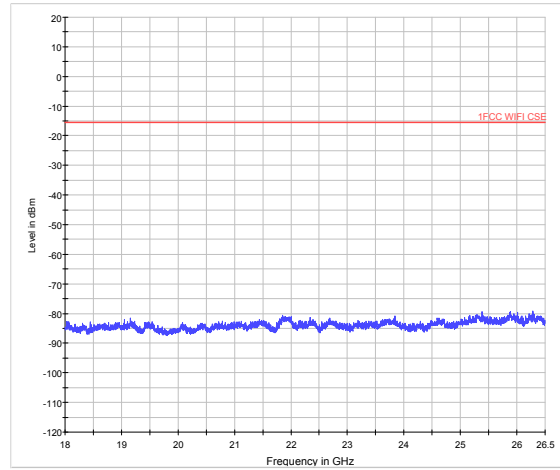

802.11b CH6 18GHz to 26.5GHz

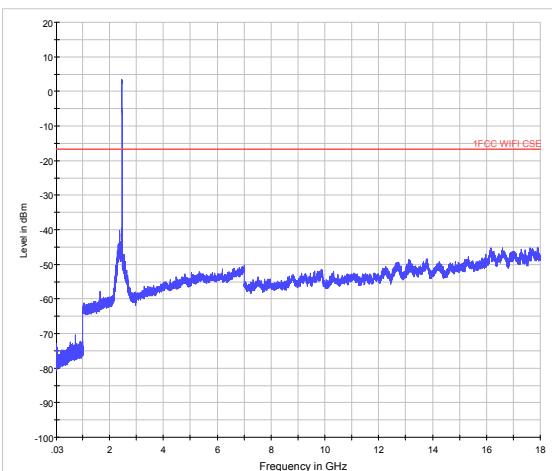

802.11b CH11 30MHz to 18GHz

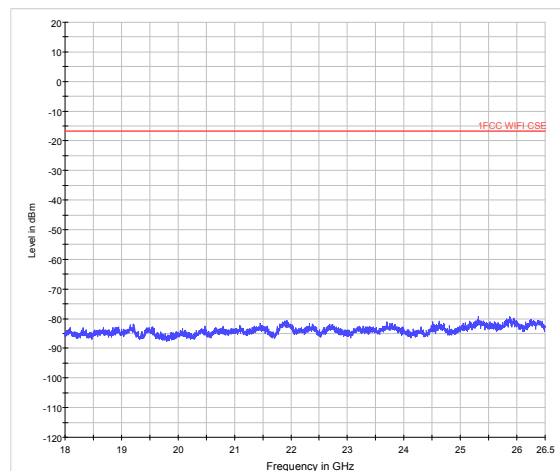

802.11b CH11 18GHz to 26.5GHz

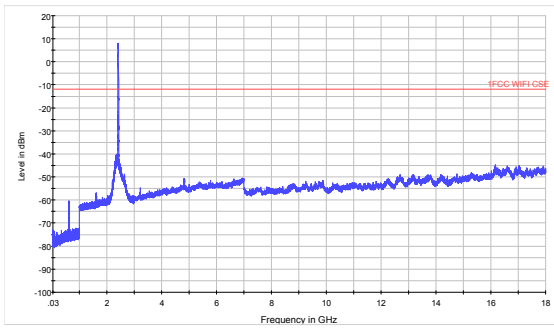

802.11g CH1 30MHz to 18GHz

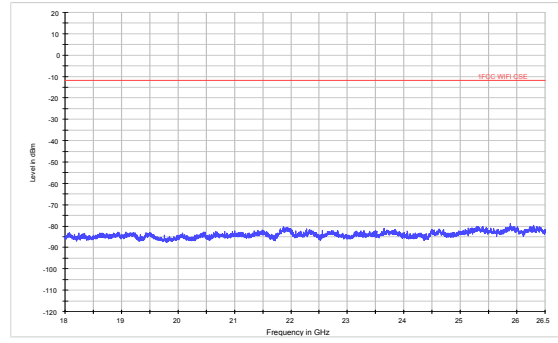

802.11g CH1 18GHz to 26.5GHz

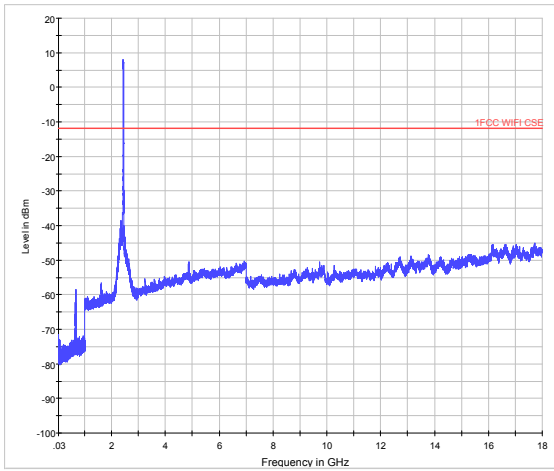

802.11g CH6 30MHz to 18GHz

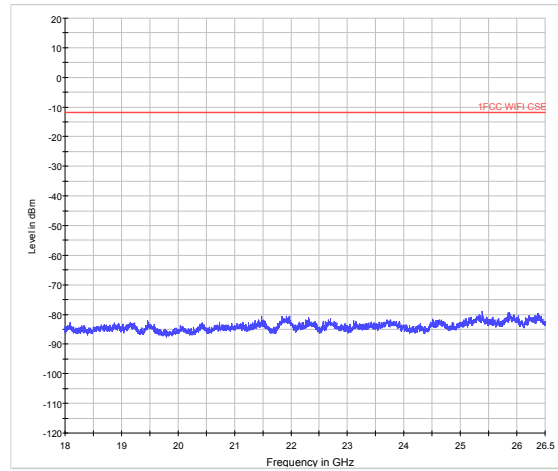

802.11g CH6 18GHz to 26.5GHz

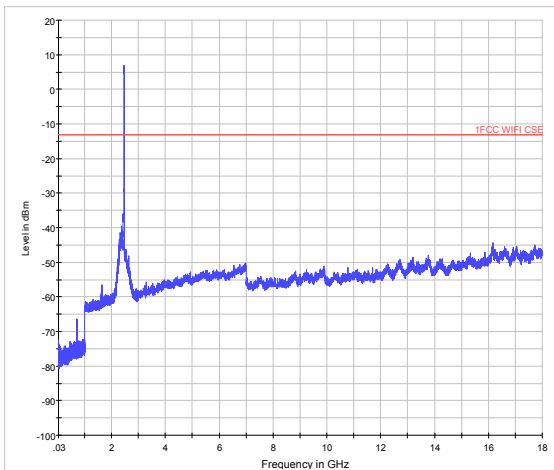

802.11g CH11 30MHz to 18GHz

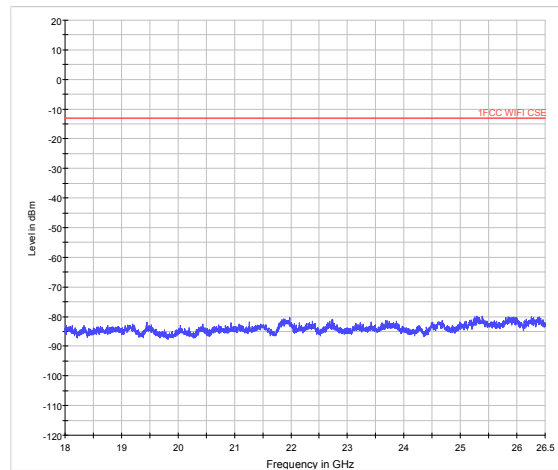

802.11g CH11 18GHz to 26.5GHz

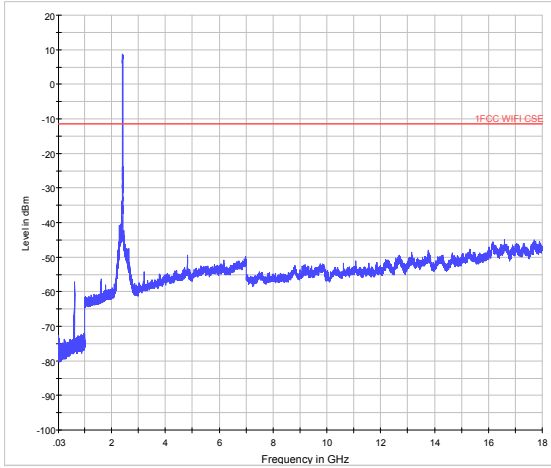

802.11n (HT20) CH1 30MHz to 18GHz

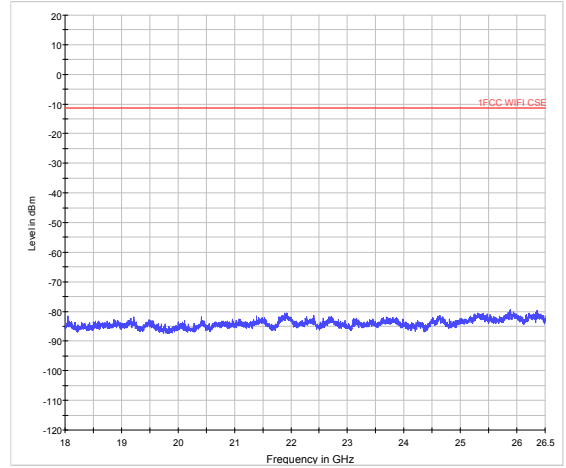

802.11n (HT20) CH1 18GHz to 26.5GHz

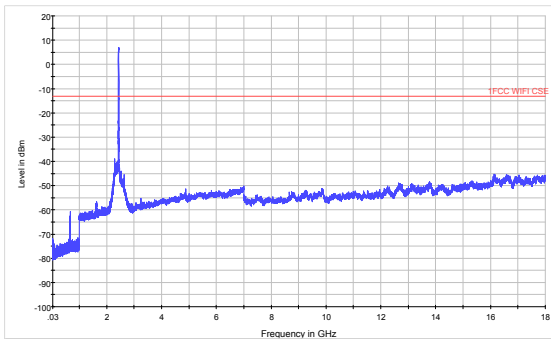

802.11n (HT20) CH6 30MHz to 18GHz

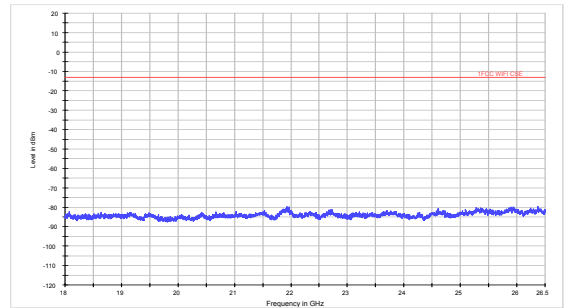

802.11n (HT20) CH6 18GHz to 26.5GHz

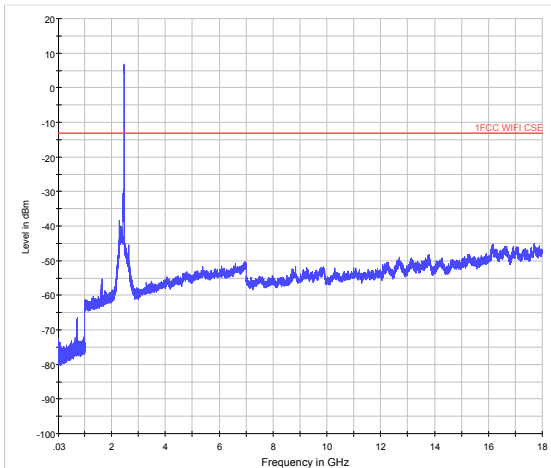

802.11n (HT20) CH11 30MHz to 18GHz

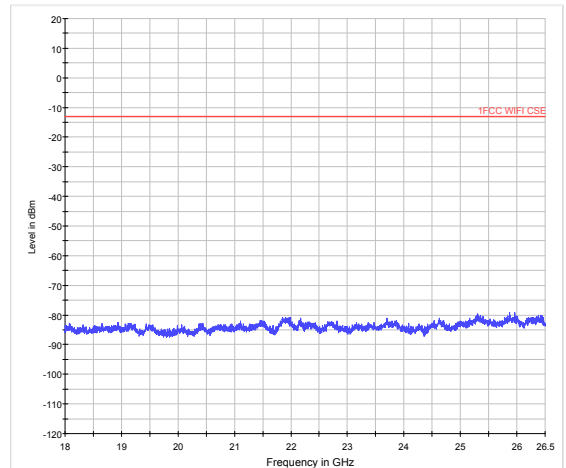

802.11n (HT20) CH11 18GHz to 26.5GHz

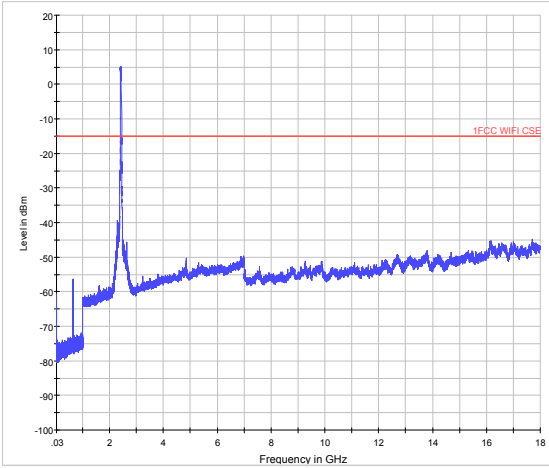

802.11n (HT40) CH3 30MHz to 18GHz

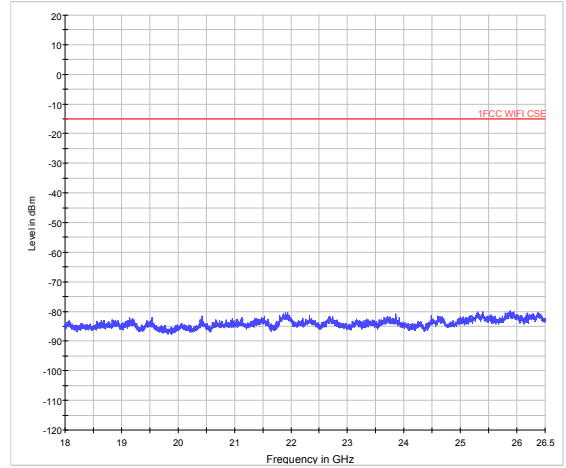

802.11n (HT40) CH3 18GHz to 26.5GHz

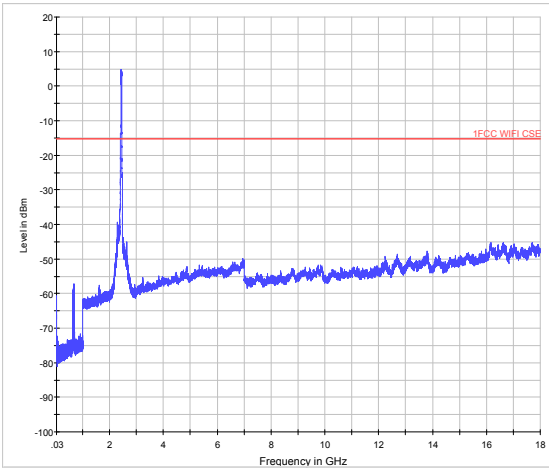

802.11n (HT40) CH6 30MHz to 18GHz

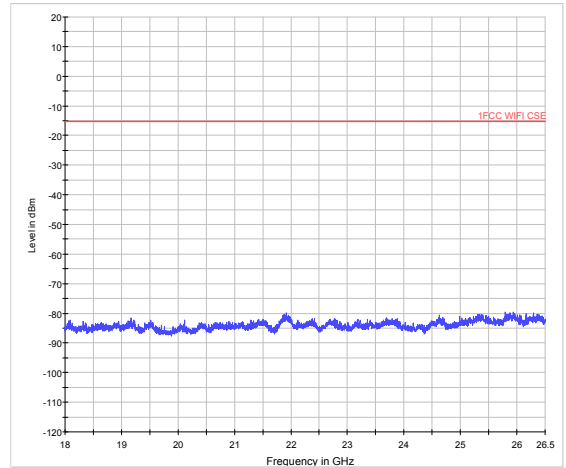

802.11n (HT40) CH6 18GHz to 26.5GHz

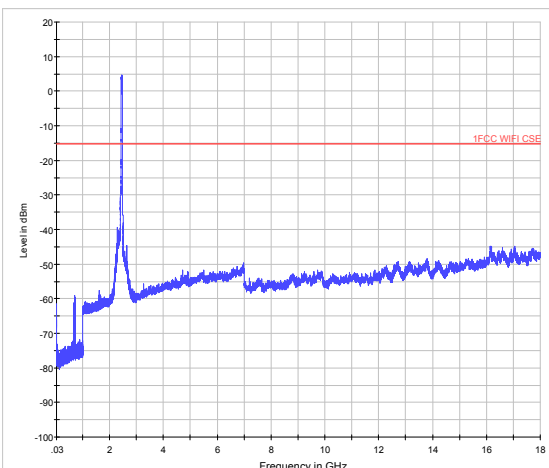

802.11n (HT40) CH9 30MHz to 18GHz

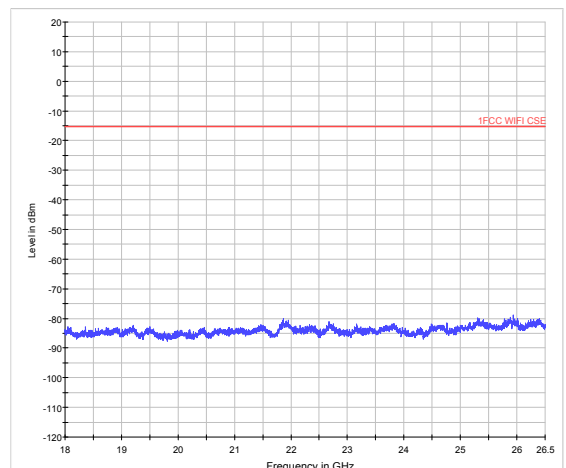

802.11n (HT40) CH9 18GHz to 26.5GHz

## 5.6. Radiated Emissions in the Restricted Band

### Ambient condition

Temperature	Relative humidity	Pressure
23°C ~25°C	45%~50%	101.5kPa

### Method of Measurement

The Equipment Under Test (EUT) was set up on a non-conductive table in the semi-anechoic chamber. The test was performed at the distance of 3 m between the EUT and the receiving antenna. The turntable shall be rotated from 0 to 360 degrees for detecting the maximum of radiated spurious signal level. The measurements shall be repeated with orthogonal polarization of the test antenna. The data of cable loss and antenna factor has been calibrated in full testing frequency range before the testing. Sweep the Restricted Band and the emissions less than 20 dB below the permissible value are reported.

This method refer to KDB 558074.

The procedure for peak unwanted emissions measurements above 1000 MHz is as follows:

I) Peak emission levels are measured by setting the instrument as follows:

- 1) RBW = 1 MHz.
- 2) VBW  $\geq$  [3  $\times$  RBW]
- 3) Detector = peak.
- 4) Sweep time = auto.
- 5) Trace mode = max hold.
- 6) Allow sweeps to continue until the trace stabilizes. Note that if the transmission is not continuous, then the time required for the trace to stabilize will increase by a factor of approximately 1 / D, where D is the duty cycle.

II) Average emission levels are measured by setting the instrument as follows:

- a) RBW = 1 MHz.
- b) VBW  $\geq$  [3  $\times$  RBW].
- c) Detector = RMS (power averaging), if [span / (# of points in sweep)]  $\leq$  RBW / 2. Satisfying this condition can require increasing the number of points in the sweep or reducing the span. If the condition is not satisfied, then the detector mode shall be set to peak.
- d) Averaging type = power (i.e., rms) (As an alternative, the detector and averaging type may be set for linear voltage averaging. Some instruments require linear display mode to use linear voltage averaging. Log or dB averaging shall not be used.)
- e) Sweep time = auto.
- f) Perform a trace average of at least 100 traces if the transmission is continuous. If the transmission is not continuous, then the number of traces shall be increased by a factor of 1 / D, where D is the duty cycle. For example, with 50% duty cycle, at least 200 traces shall be averaged. (If a specific emission is demonstrated to be continuous—i.e., 100% duty cycle—then rather than turning ON and OFF with the transmit cycle, at least 100 traces shall be averaged.)
- g) If tests are performed with the EUT transmitting at a duty cycle less than 98%, then a correction

factor shall be added to the measurement results prior to comparing with the emission limit, to compute the emission level that would have been measured had the test been performed at 100% duty cycle. The correction factor is computed as follows:

- 1) If power averaging (rms) mode was used in the preceding step e), then the correction factor is  $[10 \log (1 / D)]$ , where D is the duty cycle. For example, if the transmit duty cycle was 50%, then 3 dB shall be added to the measured emission levels.
- 2) If linear voltage averaging mode was used in the preceding step e), then the correction factor is  $[20 \log (1 / D)]$ , where D is the duty cycle. For example, if the transmit duty cycle was 50%, then 6 dB shall be added to the measured emission levels.
- 3) If a specific emission is demonstrated to be continuous (100% duty cycle) rather than turning ON and OFF with the transmit cycle, then no duty cycle correction is required for that emission.

The field strength of spurious emission was measured in the following position: EUT stand-up position (Z axis), lie-down position (X, Y axis). The worst emission was found in stand-up position (Z axis) and the antenna is vertical.

The test is in transmitting mode.

**Test setup**

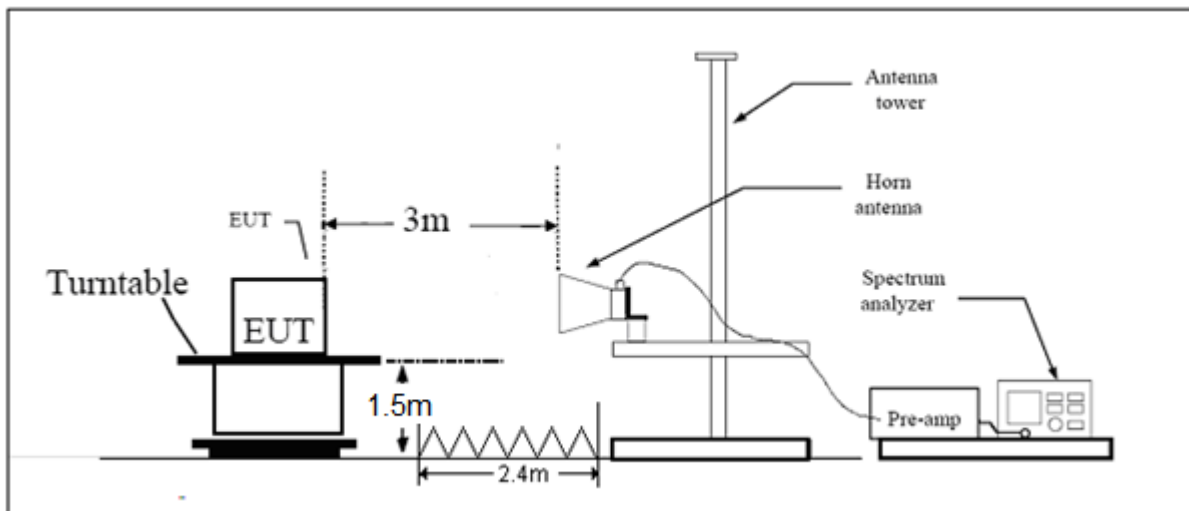

Note: Area side: 2.4mX3.6m

**Limits**

Spurious Radiated Emissions are permitted in any of the frequency bands listed below:



MHz	MHz	MHz	GHz
0.090 - 0.110	16.42 - 16.423	399.9 - 410	4.5 - 5.15
0.495 - 0.505	16.69475 - 16.69525	608 - 614	5.35 - 5.46
2.1735 - 2.1905	16.80425 - 16.80475	960 - 1240	7.25 - 7.75
4.125 - 4.128	25.5 - 25.67	1300 - 1427	8.025 - 8.5
4.17725 - 4.17775	37.5 - 38.25	1435 - 1626.5	9.0 - 9.2
4.20725 - 4.20775	73 - 74.6	1645.5 - 1646.5	9.3 - 9.5
6.215 - 6.218	74.8 - 75.2	1660 - 1710	10.6 - 12.7
6.26775 - 6.26825	108 - 121.94	1718.8 - 1722.2	13.25 - 13.4
6.31175 - 6.31225	123 - 138	2200 - 2300	14.47 - 14.5
8.291 - 8.294	149.9 - 150.05	2310 - 2390	15.35 - 16.2
8.362 - 8.366	156.52475 - 156.52525	2483.5 - 2500	17.7 - 21.4
8.37625 - 8.38675	156.7 - 156.9	2690 - 2900	22.01 - 23.12
8.41425 - 8.41475	162.0125 - 167.17	3260 - 3267	23.6 - 24.0
12.29 - 12.293	167.72 - 173.2	3332 - 3339	31.2 - 31.8
12.51975 - 12.52025	240 - 285	3345.8 - 3358	36.43 - 36.5
12.57675 - 12.57725	322 - 335.4	3600 - 4400	( <sup>2</sup> )
13.36 - 13.41			

Limit in restricted band

Frequency of emission (MHz)	Field strength(uV/m)	Field strength(dBuV/m)
30-88	100	40
88-216	150	43.5
216-960	200	46
Above960	500	54

#### §15.35(b)

There is also a limit on the radio frequency emissions, as measured using instrumentation with a peak detector function, corresponding to 20 dB above the maximum permitted average limit.

Peak Limit=74 dBuV/m

Average Limit=54 dBuV/m

#### Measurement Uncertainty

The assessed measurement uncertainty to ensure 95% confidence level for the normal distribution is with the coverage factor  $k = 1.96$ ,  $U = 3.55$  dB.



**Test Results:****PASS**

Band	T <sub>on</sub> (ms)	T <sub>(on+off)</sub> (ms)	Duty cycle	Duty cycle correction Factor(dB)
802.11b	8.18	8.24	0.99	0
802.11g	1.36	1.41	0.96	0.16
802.11n HT20	1.27	1.32	0.96	0.16
802.11n HT40	0.63	0.67	0.94	0.27

Note: when Duty cycle>0.98, Duty cycle correction Factor not required.

**MIMO****802.11b-Channel 1**

Frequency (MHz)	Peak (dBuV/m)	Average (dBuV/m)	Height (cm)	Polarization	Azimuth (deg)	Duty cycle correction Factor(dB)	conclusion value (dBuV/m)	Margin (dB)	Limit (dBuV/m)
2390	47.378	--	200.0	V	135	0	47.378	26.622	74
2390	--	35.477	200.0	V	135	0	35.477	18.523	54

**802.11b-Channel 11**

Frequency (MHz)	Peak (dBuV/m)	Average (dBuV/m)	Height (cm)	Polarization	Azimuth (deg)	Duty cycle correction Factor(dB)	conclusion value (dBuV/m)	Margin (dB)	Limit (dBuV/m)
2483.5	48.107	--	200.0	V	135	0	48.107	25.893	74
2483.5	--	36.342	200.0	V	135	0	36.342	17.658	54

**802.11g-Channel 1**

Frequency (MHz)	Peak (dBuV/m)	Average (dBuV/m)	Height (cm)	Polarization	Azimuth (deg)	Duty cycle correction Factor(dB)	conclusion value (dBuV/m)	Margin (dB)	Limit (dBuV/m)
2390	60.884	--	150	V	65	0.16	61.044	12.956	74
2390	--	42.762	150	V	65	0.16	42.922	11.078	54

**802.11g-Channel 11**

Frequency (MHz)	Peak (dBuV/m)	Average (dBuV/m)	Height (cm)	Polarization	Azimuth (deg)	Duty cycle correction Factor(dB)	conclusion value (dBuV/m)	Margin (dB)	Limit (dBuV/m)
2483.5	56.762	--	150	V	78	0.16	56.922	17.078	74
2483.5	--	39.503	150	V	78	0.16	39.663	14.337	54

**802.11n HT20 -Channel 1**

Frequency (MHz)	Peak (dBuV/m)	Average (dBuV/m)	Height (cm)	Polarization	Azimuth (deg)	Duty cycle correction Factor(dB)	conclusion value (dBuV/m)	Margin (dB)	Limit (dBuV/m)
2390	63.325	--	200	V	90	0.16	63.485	10.515	74
2390	--	46.895	200	V	90	0.16	47.055	6.945	54

**802.11n HT20-Channel 11**

Frequency (MHz)	Peak (dBuV/m)	Average (dBuV/m)	Height (cm)	Polarization	Azimuth (deg)	Duty cycle correction Factor(dB)	conclusion value (dBuV/m)	Margin (dB)	Limit (dBuV/m)
2483.5	63.816	--	200	V	90	0.16	63.976	10.024	74
2483.5	--	43.836	200	V	90	0.16	43.996	10.004	54

**802.11n HT40 -Channel 3**

Frequency (MHz)	Peak (dBuV/m)	Average (dBuV/m)	Height (cm)	Polarization	Azimuth (deg)	Duty cycle correction Factor(dB)	conclusion value (dBuV/m)	Margin (dB)	Limit (dBuV/m)
2390	67.447	--	150	V	46	0.27	67.717	6.283	74
2390	--	38.235	150	V	46	0.27	38.505	15.495	54

**802.11n HT40-Channel 9**

Frequency (MHz)	Peak (dBuV/m)	Average (dBuV/m)	Height (cm)	Polarization	Azimuth (deg)	Duty cycle correction Factor(dB)	conclusion value (dBuV/m)	Margin (dB)	Limit (dBuV/m)
2483.5	68.174	--	150	V	46	0.27	68.444	5.556	74
2483.5	--	50.219	150	V	46	0.27	50.489	3.511	54

## 5.7. Radiates Emission

### Ambient condition

Temperature	Relative humidity	Pressure
23°C ~25°C	45%~50%	102.5kPa

### Method of Measurement

The test set-up was made in accordance to the general provisions of ANSI C63.10-2013. The Equipment Under Test (EUT) was set up on a non-conductive table in the semi-anechoic chamber. The test was performed at the distance of 3 m between the EUT and the receiving antenna. The radiated emissions measurements were made in a typical installation configuration.

Sweep the whole frequency band through the range from 9 kHz to the 10th harmonic of the carrier, and the emissions less than 20 dB below the permissible value are reported.

During the test, below 30MHz, the center of the loop shall be 1 meters; above 30MHz, the height of receive antenna shall be moved from 1 to 4 meters, and the antenna shall be performed under horizontal and vertical polarization. The turntable shall be rotated from 0 to 360 degrees for detecting the maximum of radiated spurious signal level. The measurements shall be repeated with orthogonal polarization of the test antenna. The data of cable loss and antenna factor has been calibrated in full testing frequency range before the testing.

Set the spectrum analyzer in the following:

Below 1GHz (detector: Peak and Quasi-Peak)

RBW=100 kHz / VBW=300 kHz / Sweep=AUTO

Above 1GHz (detector: Peak):

(a) PEAK: RBW=1MHz / VBW=3MHz/ Sweep=AUTO

(b) AVERAGE: RBW=1MHz / VBW=3MHz / Sweep=AUTO

The radiated emission was measured in the following position: EUT stand-up position (Z axis), lie-down position (X, Y axis). The worst emission was found in stand-up position (Z axis) and the worst case was recorded.

The test is in transmitting mode.

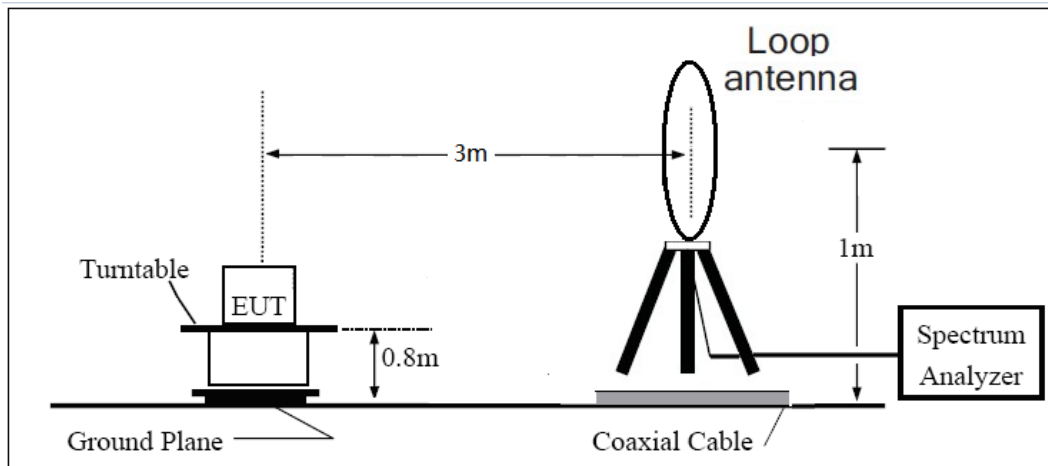
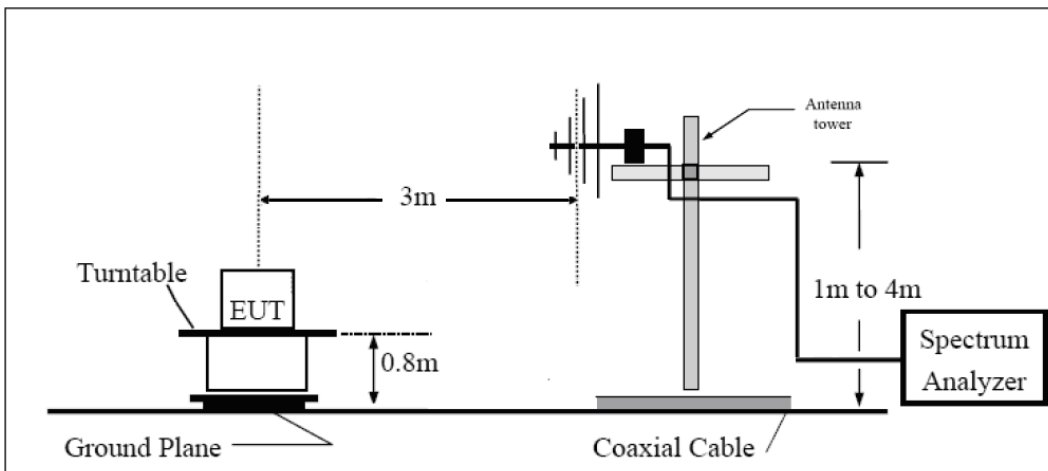
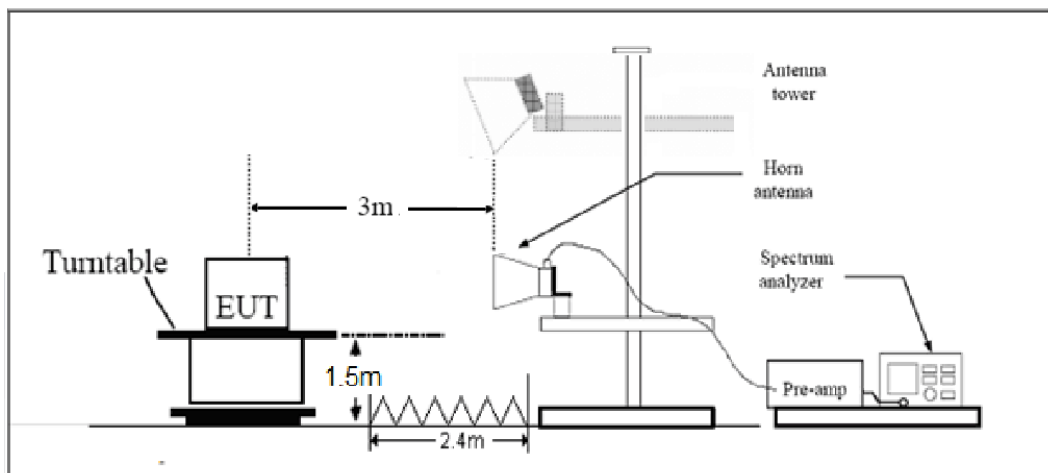
**Test setup****9KHz ~ 30MHz****30MHz ~ 1GHz****Above 1GHz**

Note: Area side:2.4mX3.6m

**Limits**

Rule Part 15.247(d) specifies that “In addition, radiated emissions which fall in the restricted bands, as defined in § 15.205(a), must also comply with the radiated emission limits specified in § 15.209(a) (see § 15.205(c)).”

Limit in restricted band

Frequency of emission (MHz)	Field strength(uV/m)	Field strength(dBuV/m)
0.009–0.490	2400/F(kHz)	/
0.490–1.705	24000/F(kHz)	/
1.705–30.0	30	/
30-88	100	40
88-216	150	43.5
216-960	200	46
Above960	500	54

## §15.35(b)

There is also a limit on the radio frequency emissions, as measured using instrumentation with a peak detector function, corresponding to 20 dB above the maximum permitted average limit.

**Measurement Uncertainty**

The assessed measurement uncertainty to ensure 95% confidence level for the normal distribution is with the coverage factor  $k = 1.96$ .

Frequency	Uncertainty
9KHz-30MHz	3.55 dB
30MHz-200MHz	4.19 dB
200MHz-1GHz	3.63 dB
Above 1GHz	3.68 dB

**Test result**

Sweep from 9 kHz to 30MHz, and the emissions more than 20 dB below the permissible value are not reported.

The following graphs display the maximum values of horizontal and vertical by software.

For above 1GHz, Blue trace uses the peak detection, Green trace uses the average detection.

During the test, the Radiates Emission from 30MHz to 1GHz was performed in all modes with all channels, 802.11b, Channel 6 are selected as the worst condition. The test data of the worst-case condition was recorded in this report.

**Continuous TX mode:**

FCC RE 0.03-1GHz QP Class B

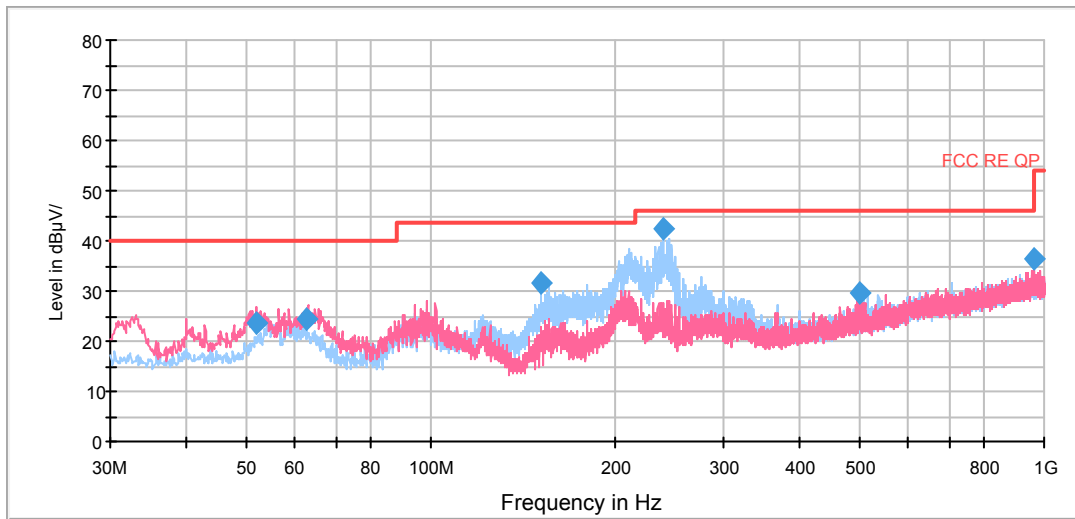

Radiates Emission from 30MHz to 1GHz

Frequency (MHz)	Quasi-Peak (dBuV/m)	Reading value (dBuV/m)	Height (cm)	Polarization	Azimuth (deg)	Correct Factor (dB)	Margin (dB)	Limit (dBuV/m)
51.786250	23.5	10.4	100.0	V	91.0	13.1	16.5	40.0
62.780000	24.4	12.9	100.0	V	103.0	11.5	15.6	40.0
151.572500	31.5	22.2	125.0	H	144.0	9.3	12.0	43.5
240.005000	42.5	28.8	125.0	H	253.0	13.7	3.5	46.0
499.965000	29.6	9.1	100.0	V	4.0	20.5	16.4	46.0
959.987500	36.5	10.4	100.0	V	15.0	27.4	9.5	46.0

**Remark: 1. Quasi-Peak = Reading value + Correction factor**

**2. Correction Factor = Antenna factor+ Insertion loss(cable loss+amplifier gain)**

**3. Margin = Limit – Quasi-Peak**

802.11b CH1

FCC RE 1G-18GHz PK+AV Class B

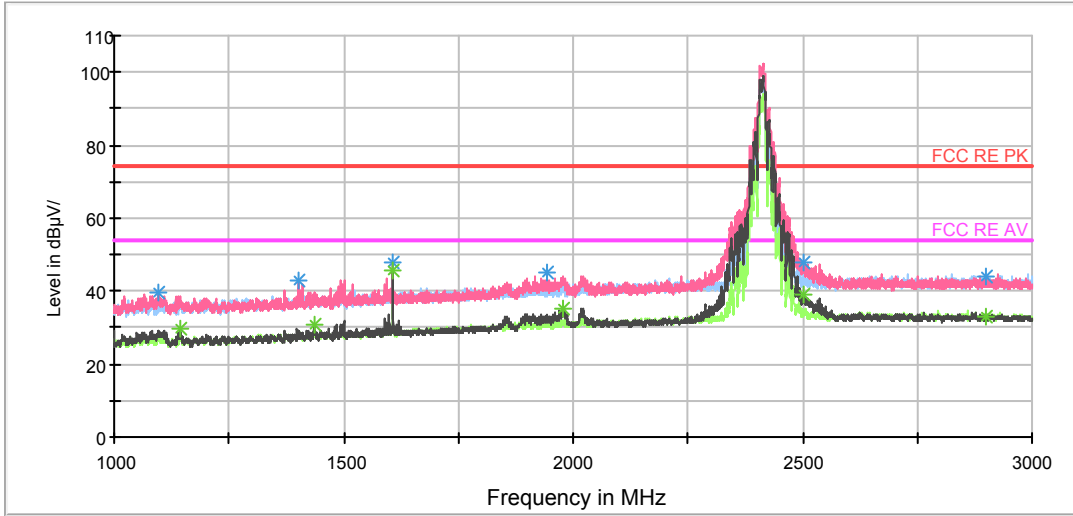

Note: The signal beyond the limit is carrier.  
Radiates Emission from 1GHz to 3GHz

FCC RE 1G-18GHz PK+AV Class B

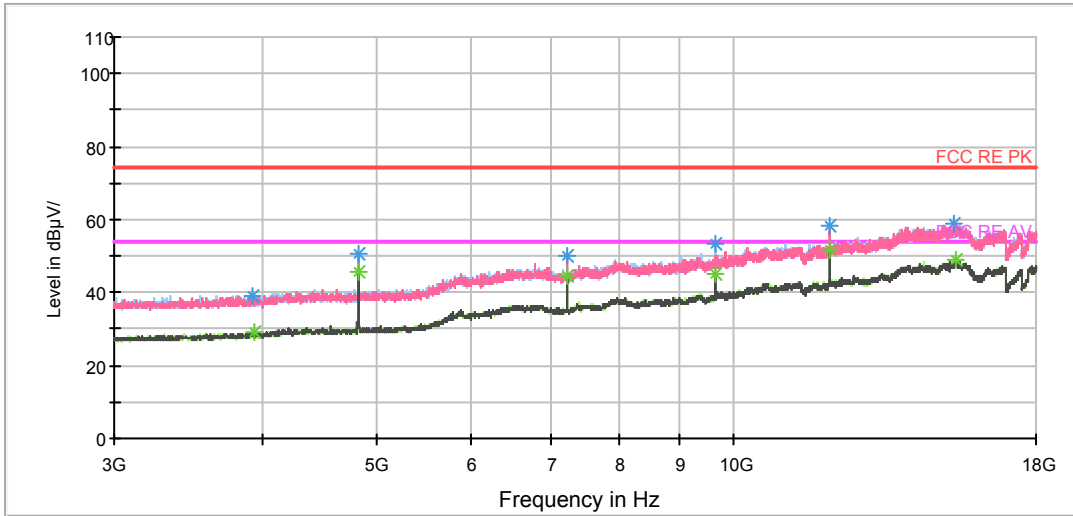

Radiates Emission from 3GHz to 18GHz

RE 18-26.5GHz PK+AV

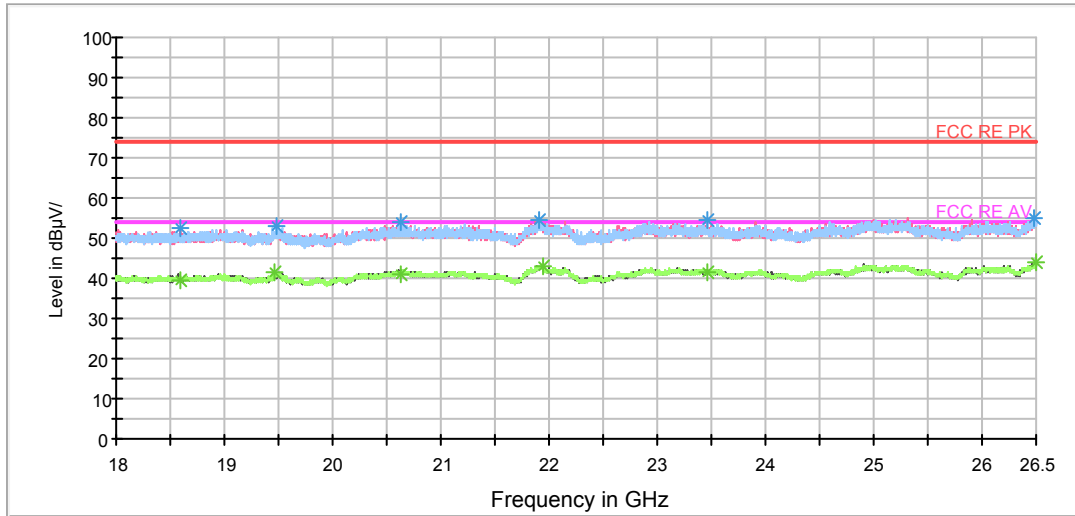

Radiates Emission from 18GHz to 26.5GHz

Frequency (MHz)	Peak (dBuV/m)	Height (cm)	Polarization	Azimuth (deg)	Reading value (dBuV/m)	Correct Factor (dB)	Margin (dB)	Limit (dBuV/m)
1098.250000	39.3	100.0	V	14.0	48.1	-8.8	34.7	74
1401.000000	42.8	100.0	V	119.0	49.8	-7.0	31.2	74
1607.750000	48.1	100.0	V	232.0	53.9	-5.8	25.9	74
1944.250000	44.9	100.0	V	4.0	48.8	-3.9	29.1	74
2502.000000	47.7	100.0	V	158.0	48.6	-0.9	26.3	74
2898.000000	44.2	100.0	V	3.0	44.7	-0.5	29.8	74

Remark: 1. Correction Factor = Antenna factor+ Insertion loss (cable loss + amplifier gain)

Frequency (MHz)	Average (dBuV/m)	Height (cm)	Polarization	Azimuth (deg)	Reading value (dBuV/m)	Correct Factor (dB)	Margin (dB)	Limit (dBuV/m)
1143.000000	29.7	100.0	V	10.0	38.2	-8.5	24.3	54
1434.500000	31.0	100.0	V	283.0	37.8	-6.8	23.0	54
1607.750000	45.7	100.0	V	232.0	51.5	-5.8	8.3	54
1976.750000	35.1	100.0	V	2.0	38.7	-3.6	18.9	54
2502.750000	38.9	100.0	V	168.0	39.8	-0.9	15.1	54
2898.000000	33.1	100.0	V	3.0	33.6	-0.5	20.9	54

Remark: 1. Correction Factor = Antenna factor+ Insertion loss (cable loss + amplifier gain)



802.11b CH6

FCC RE 1G-18GHz PK+AV Class B

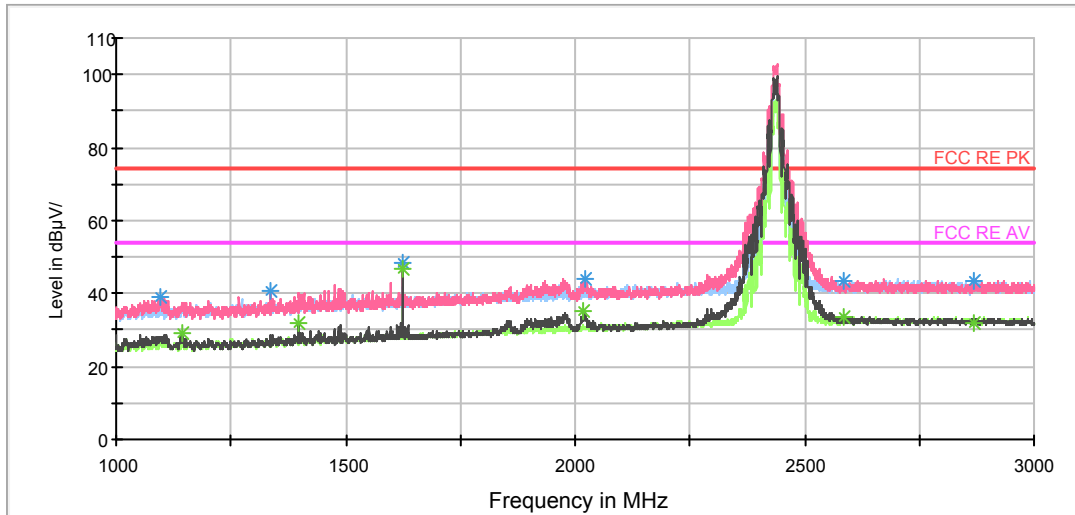

Note: The signal beyond the limit is carrier.  
Radiates Emission from 1GHz to 3GHz

FCC RE 1G-18GHz PK+AV Class B

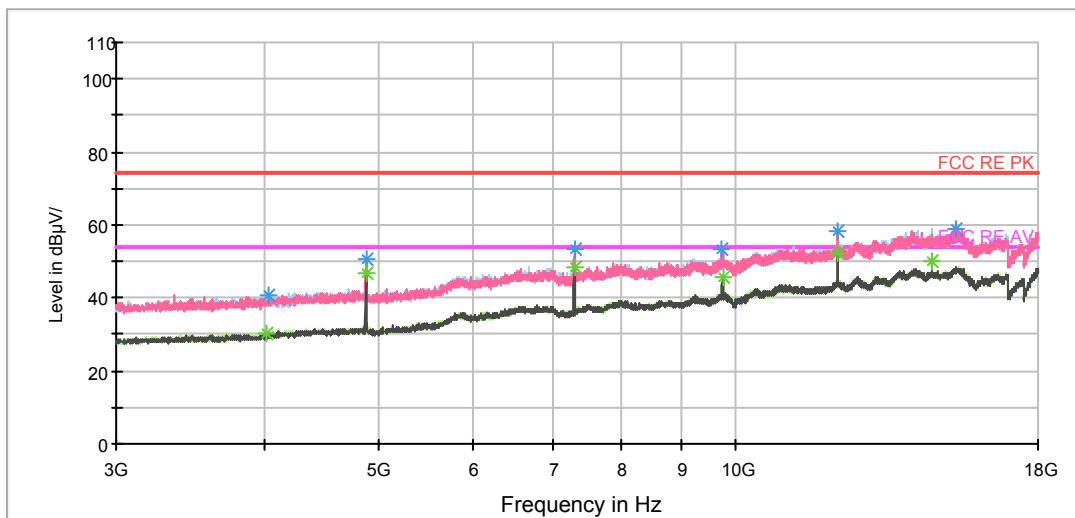

Radiates Emission from 3GHz to 18GHz

RE 18-26.5GHz PK+AV

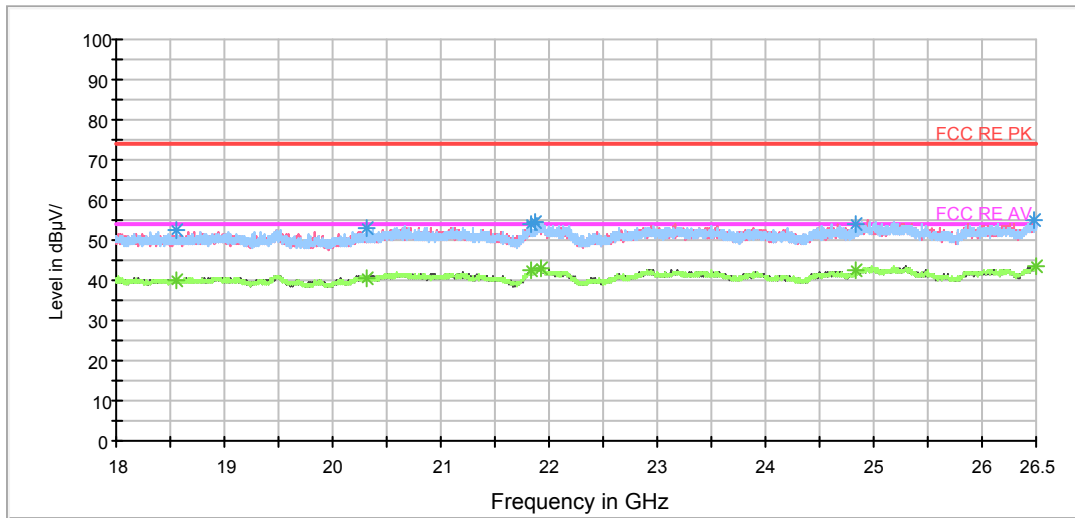

Radiates Emission from 18GHz to 26.5GHz

Frequency (MHz)	Peak (dBuV/m)	Height (cm)	Polarization	Azimuth (deg)	Reading value (dBuV/m)	Correct Factor (dB)	Margin (dB)	Limit (dBuV/m)
1097.750000	38.8	100.0	V	20.0	47.6	-8.8	35.2	74
1337.250000	40.6	100.0	V	140.0	48.0	-7.4	33.4	74
1624.500000	48.3	100.0	V	234.0	54.0	-5.7	25.7	74
2020.500000	44.0	100.0	V	20.0	47.3	-3.3	30.0	74
2583.250000	43.3	100.0	V	223.0	44.1	-0.8	30.7	74
2869.750000	43.4	100.0	H	296.0	43.7	-0.3	30.6	74

Remark: 1. Correction Factor = Antenna factor+ Insertion loss (cable loss + amplifier gain)

Frequency (MHz)	Average (dBuV/m)	Height (cm)	Polarization	Azimuth (deg)	Reading value (dBuV/m)	Correct Factor (dB)	Margin (dB)	Limit (dBuV/m)
1143.000000	28.9	100.0	V	20.0	37.4	-8.5	25.1	54
1398.750000	31.9	100.0	V	212.0	38.9	-7.0	22.1	54
1624.500000	46.6	100.0	V	234.0	52.3	-5.7	7.4	54
2019.500000	35.1	100.0	V	6.0	38.4	-3.3	18.9	54
2583.250000	33.4	100.0	V	223.0	34.2	-0.8	20.6	54
2869.750000	32.1	100.0	H	296.0	32.4	-0.3	21.9	54

Remark: 1. Correction Factor = Antenna factor+ Insertion loss (cable loss + amplifier gain)

802.11b CH11

FCC RE 1G-18GHz PK+AV Class B

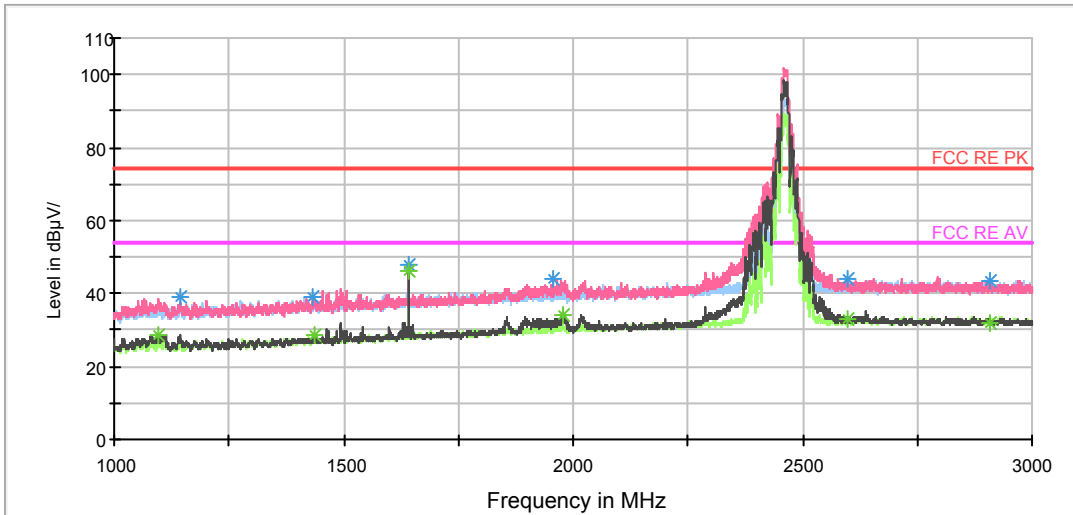

Note: The signal beyond the limit is carrier.  
Radiates Emission from 1GHz to 3GHz

FCC RE 1G-18GHz PK+AV Class B

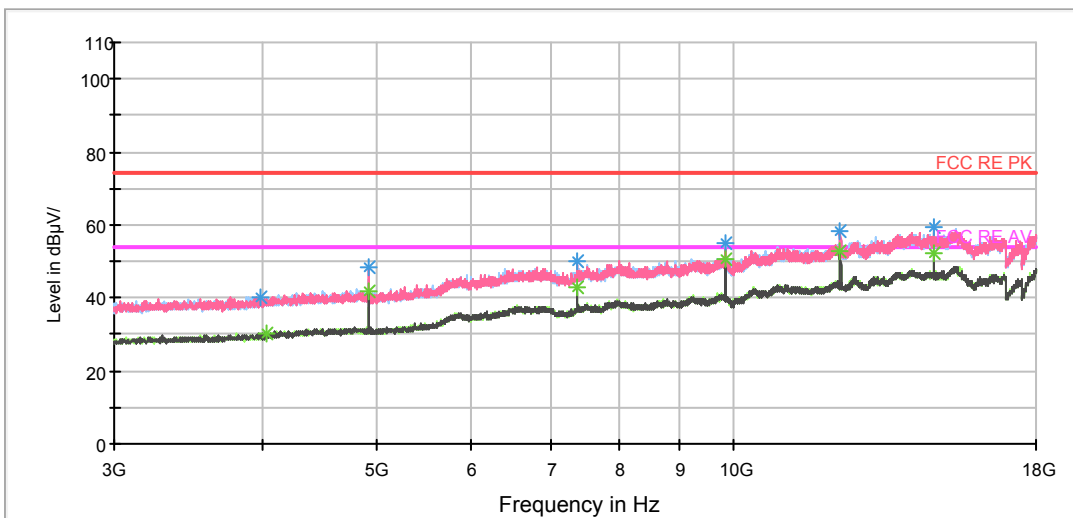

Radiates Emission from 3GHz to 18GHz

RE 18-26.5GHz PK+AV

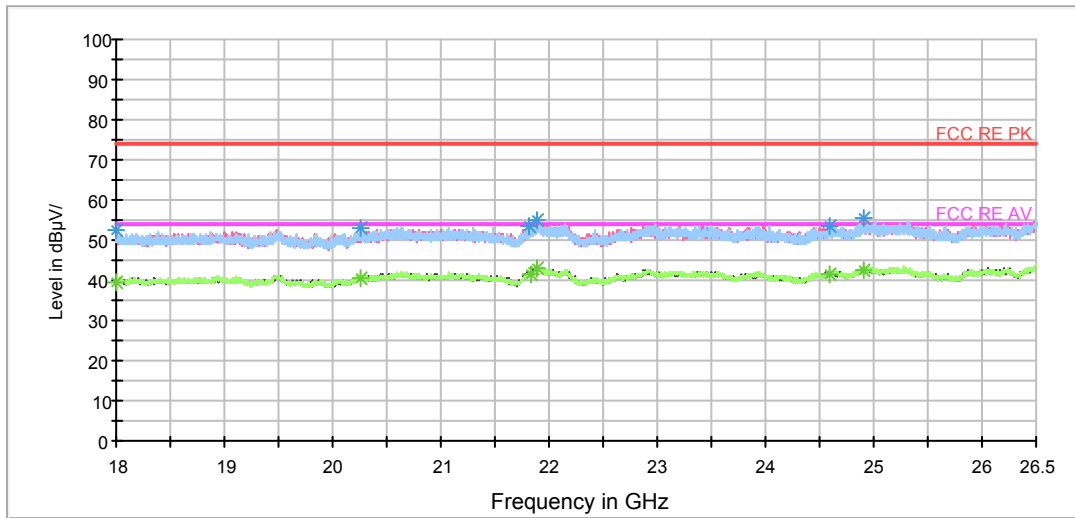

Radiates Emission from 18GHz to 26.5GHz

Frequency (MHz)	Peak (dBuV/m)	Height (cm)	Polarization	Azimuth (deg)	Reading value (dBuV/m)	Correct Factor (dB)	Margin (dB)	Limit (dBuV/m)
1143.750000	39.0	100.0	H	0.0	47.5	-8.5	35.0	74
1433.500000	39.3	100.0	V	127.0	46.1	-6.8	34.7	74
1641.250000	48.1	100.0	V	155.0	53.7	-5.6	25.9	74
1956.500000	44.0	100.0	V	18.0	47.8	-3.8	30.0	74
2598.750000	43.8	100.0	H	341.0	44.6	-0.8	30.2	74
2908.500000	43.3	100.0	V	1.0	43.7	-0.4	30.7	74

Remark: 1. Correction Factor = Antenna factor+ Insertion loss (cable loss + amplifier gain)

Frequency (MHz)	Average (dBuV/m)	Height (cm)	Polarization	Azimuth (deg)	Reading value (dBuV/m)	Correct Factor (dB)	Margin (dB)	Limit (dBuV/m)
1096.250000	28.8	100.0	V	24.0	37.6	-8.8	25.2	54
1437.750000	28.5	100.0	V	4.0	35.2	-6.7	25.5	54
1641.250000	46.3	100.0	V	155.0	51.9	-5.6	7.7	54
1976.750000	34.1	100.0	V	9.0	37.7	-3.6	19.9	54
2598.750000	33.0	100.0	H	341.0	33.8	-0.8	21.0	54
2908.500000	32.2	100.0	V	1.0	32.6	-0.4	21.8	54

Remark: 1. Correction Factor = Antenna factor+ Insertion loss (cable loss + amplifier gain)

802.11g CH1

FCC RE 1G-18GHz PK+AV Class B

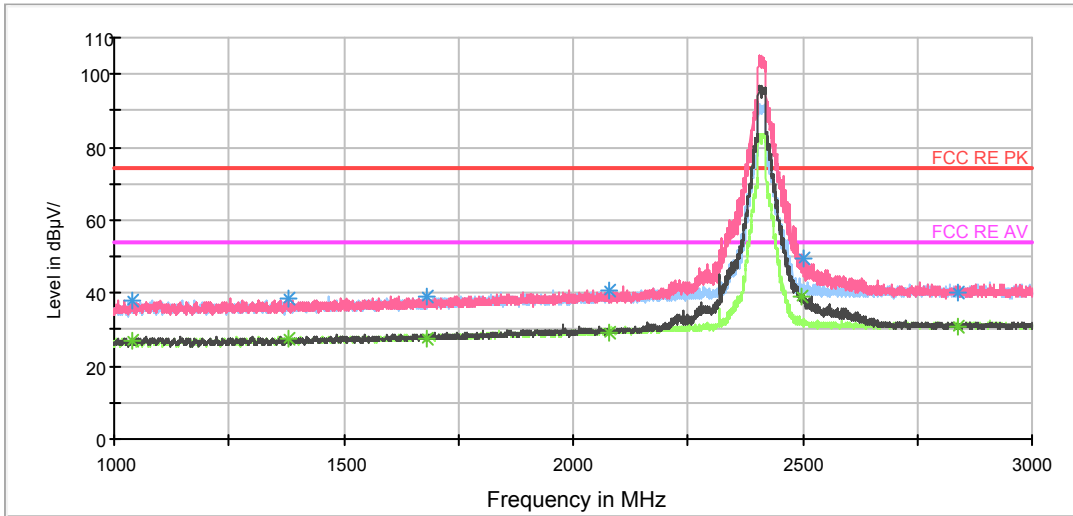

Note: The signal beyond the limit is carrier.  
Radiates Emission from 1GHz to 3GHz

FCC RE 1G-18GHz PK+AV Class B

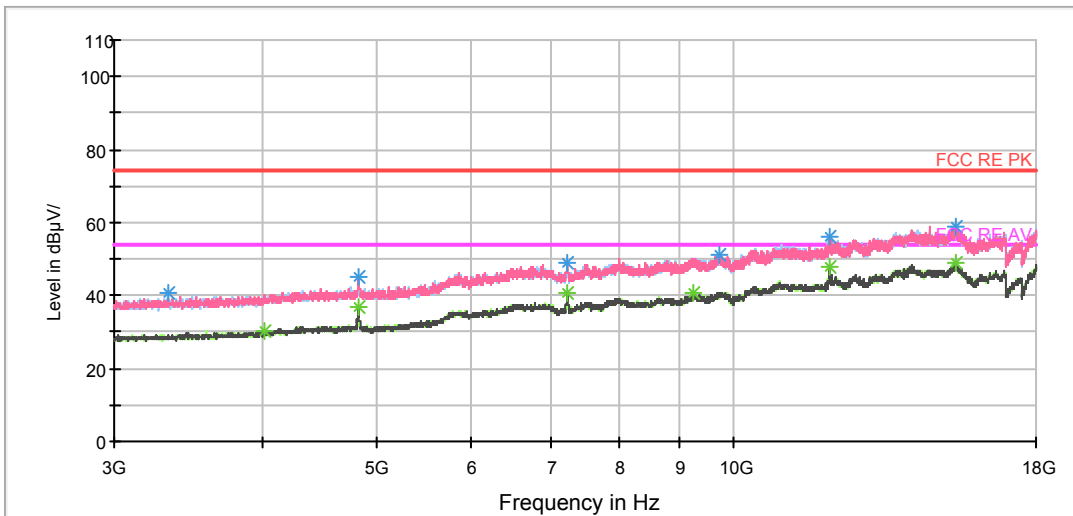

Radiates Emission from 3GHz to 18GHz

RE 18-26.5GHz PK+AV

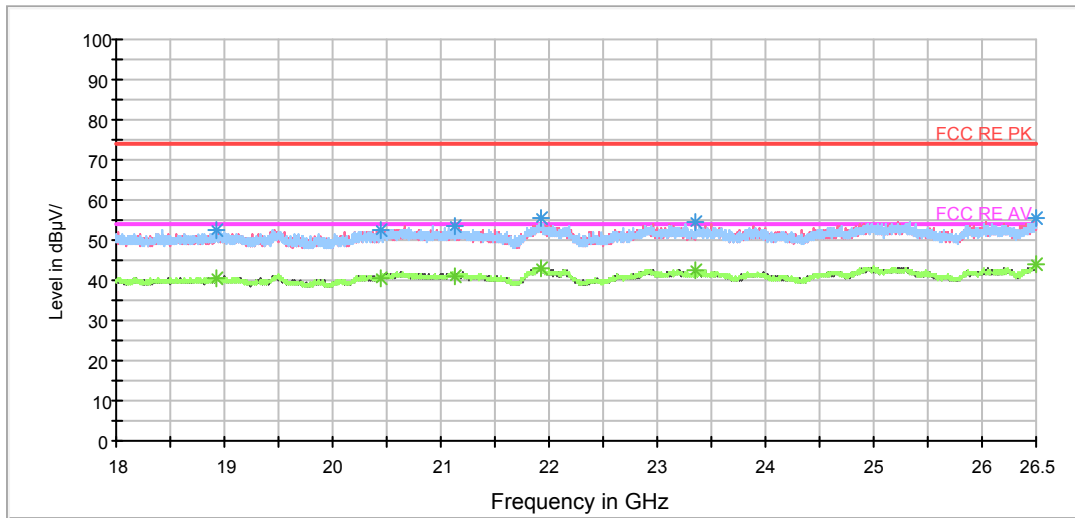

Radiates Emission from 18GHz to 26.5GHz

Frequency (MHz)	Peak (dBuV/m)	Height (cm)	Polarization	Azimuth (deg)	Reading value (dBuV/m)	Correct Factor (dB)	Margin (dB)	Limit (dBuV/m)
1040.250000	38.1	100.0	V	2.0	47.1	-9.0	35.9	74
1381.500000	38.4	100.0	H	182.0	45.5	-7.1	35.6	74
1679.750000	39.0	100.0	H	117.0	44.4	-5.4	35.0	74
2079.750000	40.8	100.0	V	2.0	43.8	-3.0	33.2	74
2501.750000	49.2	100.0	V	274.0	50.1	-0.9	24.8	74
2836.250000	40.1	100.0	H	348.0	40.6	-0.5	33.9	74

Remark: 1. Correction Factor = Antenna factor+ Insertion loss (cable loss + amplifier gain)

Frequency (MHz)	Average (dBuV/m)	Height (cm)	Polarization	Azimuth (deg)	Reading value (dBuV/m)	Correct Factor (dB)	Margin (dB)	Limit (dBuV/m)
1040.250000	27.2	100.0	V	2.0	36.2	-9.0	26.8	54
1381.500000	27.7	100.0	H	182.0	34.8	-7.1	26.3	54
1679.750000	27.5	100.0	H	117.0	32.9	-5.4	26.5	54
2079.750000	29.2	100.0	V	2.0	32.2	-3.0	24.8	54
2495.750000	38.8	100.0	V	289.0	39.7	-0.9	15.2	54
2838.000000	30.8	100.0	V	64.0	31.3	-0.5	23.2	54

Remark: 1. Correction Factor = Antenna factor+ Insertion loss (cable loss + amplifier gain)



802.11g CH6

FCC RE 1G-18GHz PK+AV Class B

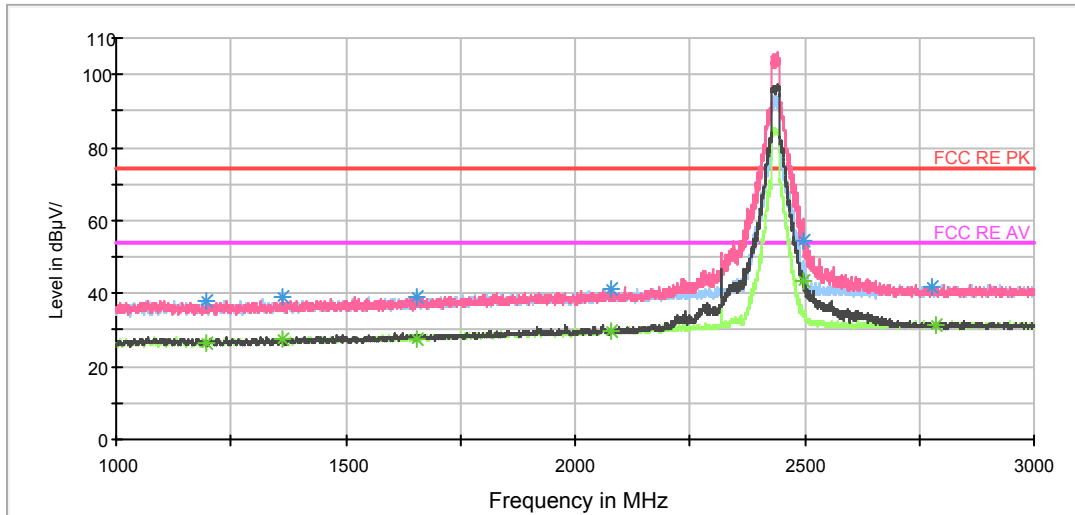

Note: The signal beyond the limit is carrier.  
Radiates Emission from 1GHz to 3GHz

FCC RE 1G-18GHz PK+AV Class B

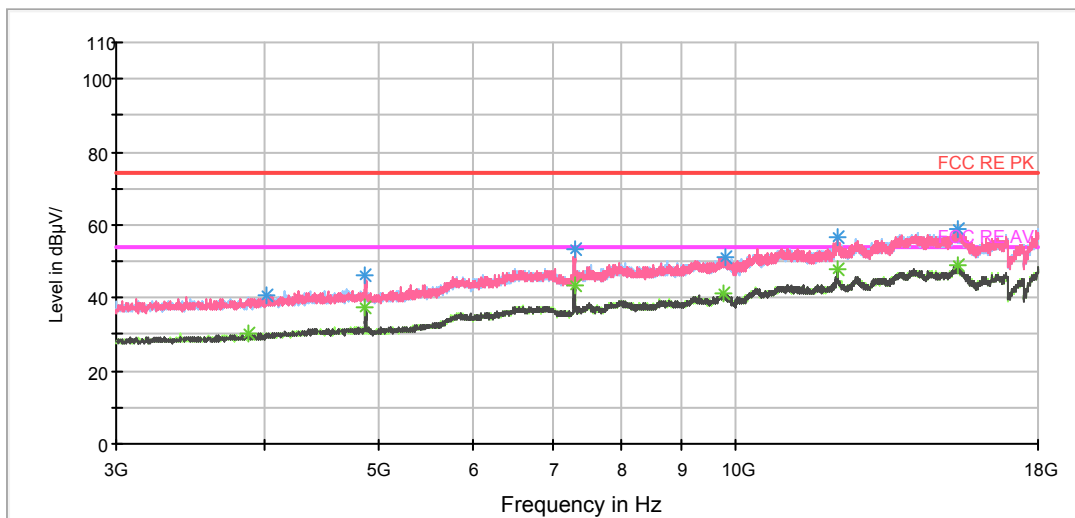

Radiates Emission from 3GHz to 18GHz

RE 18-26.5GHz PK+AV

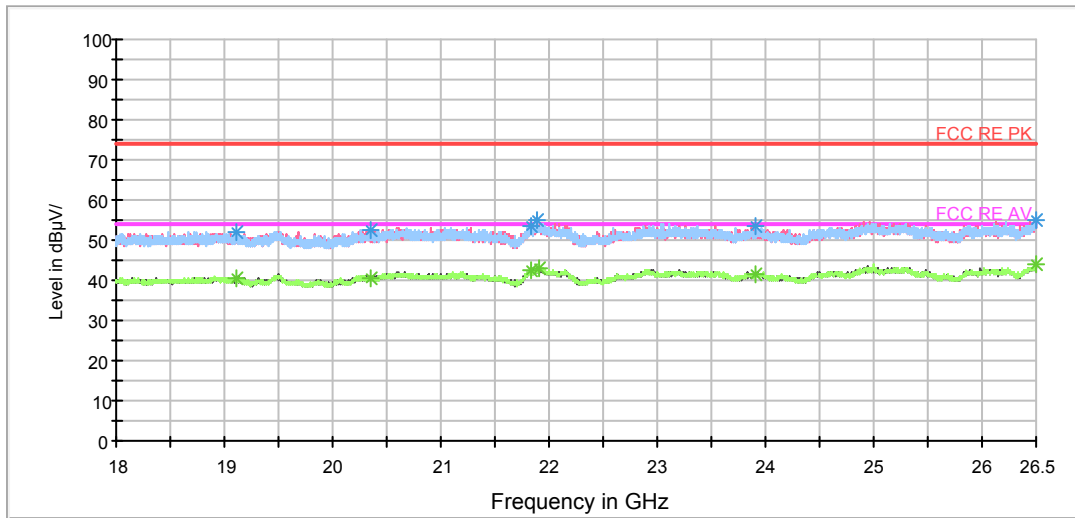

Radiates Emission from 18GHz to 26.5GHz

Frequency (MHz)	Peak (dBuV/m)	Height (cm)	Polarization	Azimuth (deg)	Reading value (dBuV/m)	Correct Factor (dB)	Margin (dB)	Limit (dBuV/m)
1195.750000	38.1	100.0	V	14.0	46.3	-8.2	35.9	74
1361.250000	39.0	100.0	V	0.0	46.2	-7.2	35.0	74
1653.000000	39.1	100.0	V	111.0	44.7	-5.6	34.9	74
2079.250000	41.0	100.0	V	130.0	44.0	-3.0	33.0	74
2499.000000	54.5	100.0	V	269.0	55.4	-0.9	19.5	74
2775.500000	41.6	100.0	V	258.0	42.1	-0.5	32.4	74

Remark: 1. Correction Factor = Antenna factor+ Insertion loss (cable loss + amplifier gain)

Frequency (MHz)	Average (dBuV/m)	Height (cm)	Polarization	Azimuth (deg)	Reading value (dBuV/m)	Correct Factor (dB)	Margin (dB)	Limit (dBuV/m)
1195.750000	26.5	100.0	V	14.0	34.7	-8.2	27.5	54
1361.250000	27.7	100.0	V	0.0	34.9	-7.2	26.3	54
1653.500000	27.8	100.0	H	180.0	33.4	-5.6	26.2	54
2079.250000	29.8	100.0	V	130.0	32.8	-3.0	24.2	54
2498.500000	43.6	100.0	V	284.0	44.5	-0.9	10.4	54
2786.000000	31.4	100.0	V	4.0	31.9	-0.5	22.6	54

Remark: 1. Correction Factor = Antenna factor+ Insertion loss (cable loss + amplifier gain)



802.11g CH11

FCC RE 1G-18GHz PK+AV Class B

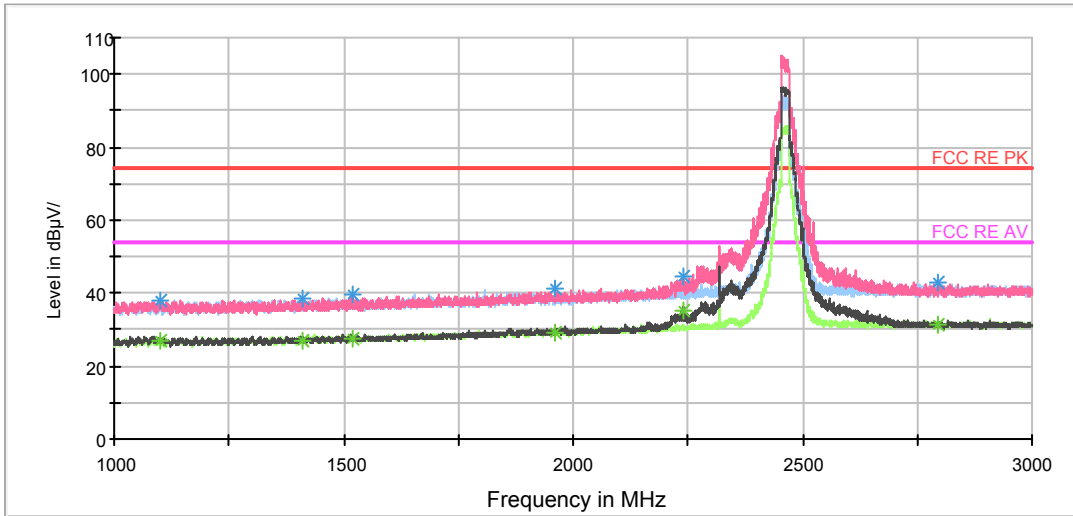

Note: The signal beyond the limit is carrier.  
Radiates Emission from 1GHz to 3GHz

FCC RE 1G-18GHz PK+AV Class B

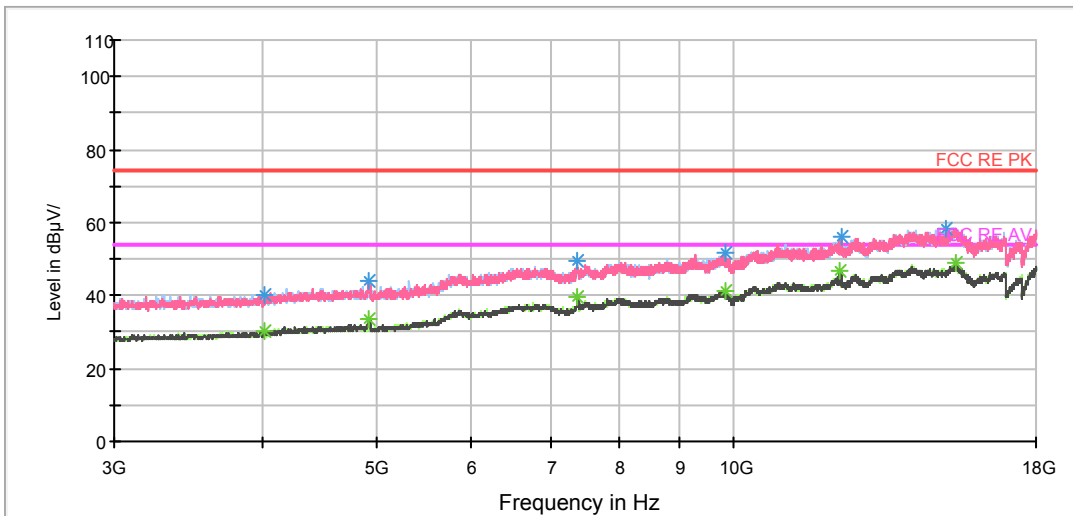

Radiates Emission from 3GHz to 18GHz

RE 18-26.5GHz PK+AV

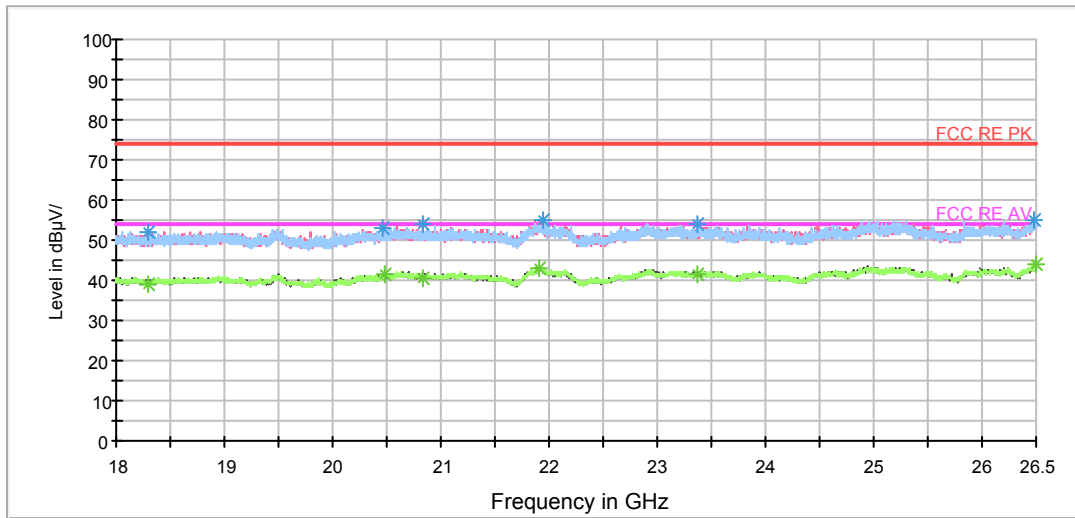

Radiates Emission from 18GHz to 26.5GHz

Frequency (MHz)	Peak (dBuV/m)	Height (cm)	Polarization	Azimuth (deg)	Reading value (dBuV/m)	Correct Factor (dB)	Margin (dB)	Limit (dBuV/m)
1101.000000	38.2	100.0	H	110.0	46.9	-8.7	35.8	74
1411.750000	38.4	100.0	H	0.0	45.3	-6.9	35.6	74
1520.500000	39.7	100.0	V	9.0	46.1	-6.4	34.3	74
1960.500000	41.4	100.0	V	0.0	45.1	-3.7	32.6	74
2239.750000	44.7	100.0	V	278.0	46.8	-2.1	29.3	74
2793.750000	42.9	100.0	V	0.0	43.4	-0.5	31.1	74

Remark: 1. Correction Factor = Antenna factor+ Insertion loss (cable loss + amplifier gain)

Frequency (MHz)	Average (dBuV/m)	Height (cm)	Polarization	Azimuth (deg)	Reading value (dBuV/m)	Correct Factor (dB)	Margin (dB)	Limit (dBuV/m)
1101.000000	26.7	100.0	H	110.0	35.4	-8.7	27.3	54
1411.750000	27.0	100.0	H	0.0	33.9	-6.9	27.0	54
1520.500000	27.8	100.0	V	9.0	34.2	-6.4	26.2	54
1960.500000	28.9	100.0	V	0.0	32.6	-3.7	25.1	54
2239.750000	34.9	100.0	V	278.0	37.0	-2.1	19.1	54
2793.750000	31.4	100.0	V	0.0	31.9	-0.5	22.6	54

Remark: 1. Correction Factor = Antenna factor+ Insertion loss (cable loss + amplifier gain)

802.11n (HT20) CH1

FCC RE 1G-18GHz PK+AV Class B

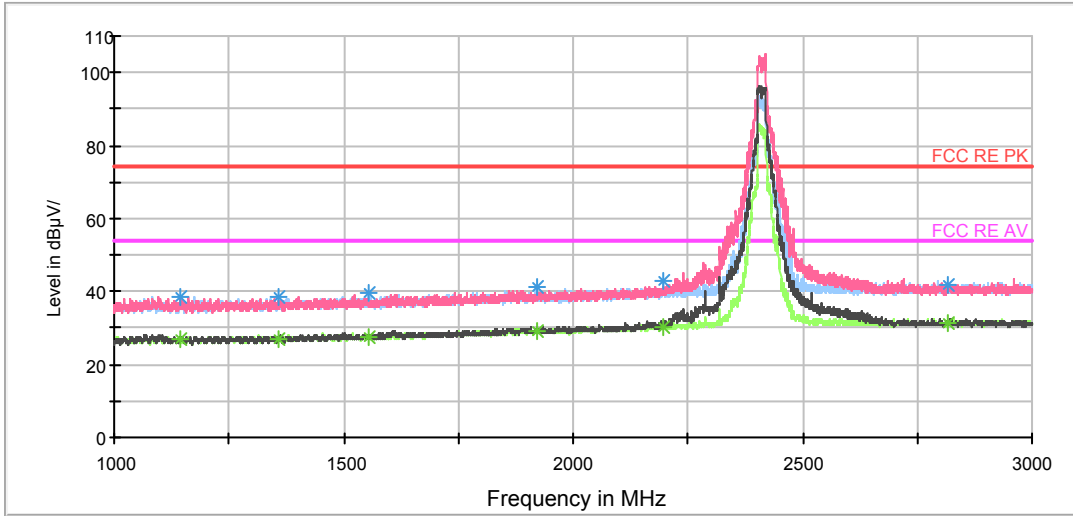

Note: The signal beyond the limit is carrier.  
Radiates Emission from 1GHz to 3GHz

FCC RE 1G-18GHz PK+AV Class B

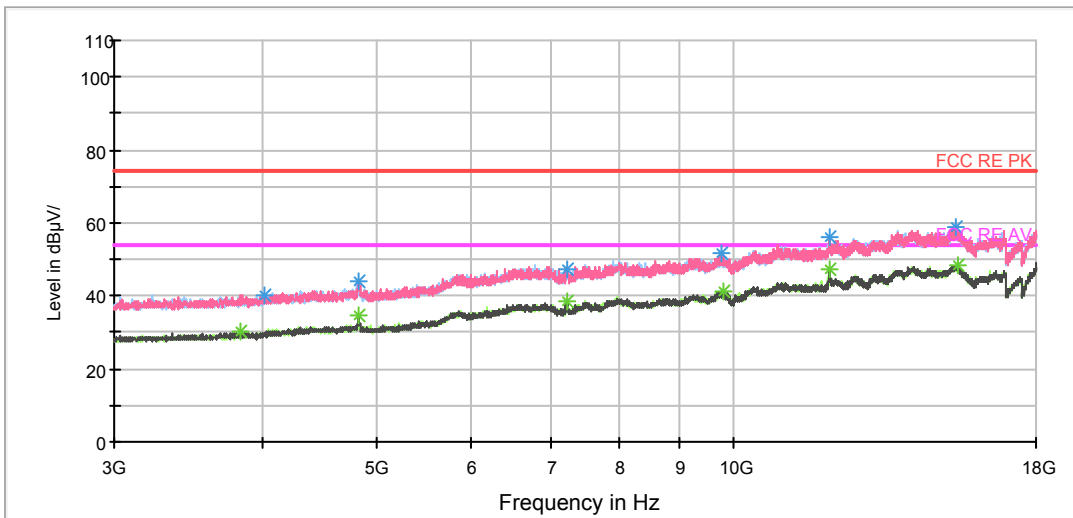

Radiates Emission from 3GHz to 18GHz

RE 18-26.5GHz PK+AV

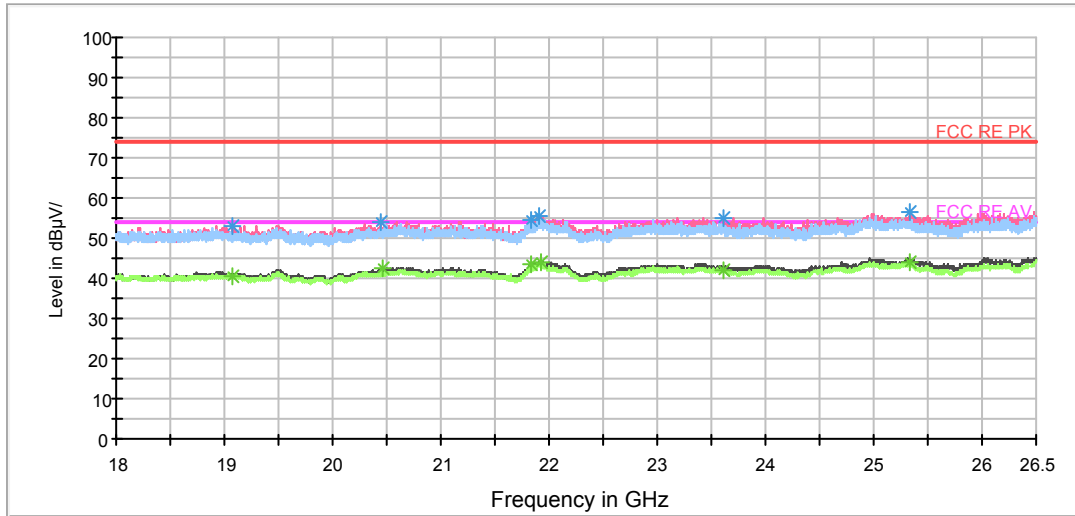

Radiates Emission from 18GHz to 26.5GHz

Frequency (MHz)	Peak (dBuV/m)	Height (cm)	Polarization	Azimuth (deg)	Reading value (dBuV/m)	Correct Factor (dB)	Margin (dB)	Limit (dBuV/m)
1144.750000	38.6	100.0	V	6.0	47.1	-8.5	35.4	74
1359.000000	38.3	100.0	H	356.0	45.5	-7.2	35.7	74
1552.500000	39.7	100.0	H	356.0	45.8	-6.1	34.3	74
1920.250000	41.0	100.0	H	230.0	44.8	-3.8	33.0	74
2195.250000	42.8	100.0	H	45.0	45.1	-2.3	31.2	74
2815.750000	42.0	100.0	H	0.0	42.5	-0.5	32.0	74

Remark: 1. Correction Factor = Antenna factor+ Insertion loss (cable loss + amplifier gain)

Frequency (MHz)	Average (dBuV/m)	Height (cm)	Polarization	Azimuth (deg)	Reading value (dBuV/m)	Correct Factor (dB)	Margin (dB)	Limit (dBuV/m)
1144.750000	27.0	100.0	V	6.0	35.5	-8.5	27.0	54
1359.000000	27.1	100.0	H	356.0	34.3	-7.2	26.9	54
1552.500000	27.7	100.0	H	356.0	33.8	-6.1	26.3	54
1920.250000	29.1	100.0	H	230.0	32.9	-3.8	24.9	54
2195.250000	30.0	100.0	H	45.0	32.3	-2.3	24.0	54
2815.750000	31.4	100.0	H	0.0	31.9	-0.5	22.6	54

Remark: 1. Correction Factor = Antenna factor+ Insertion loss (cable loss + amplifier gain)

802.11n (HT20) CH6

FCC RE 1G-18GHz PK+AV Class B

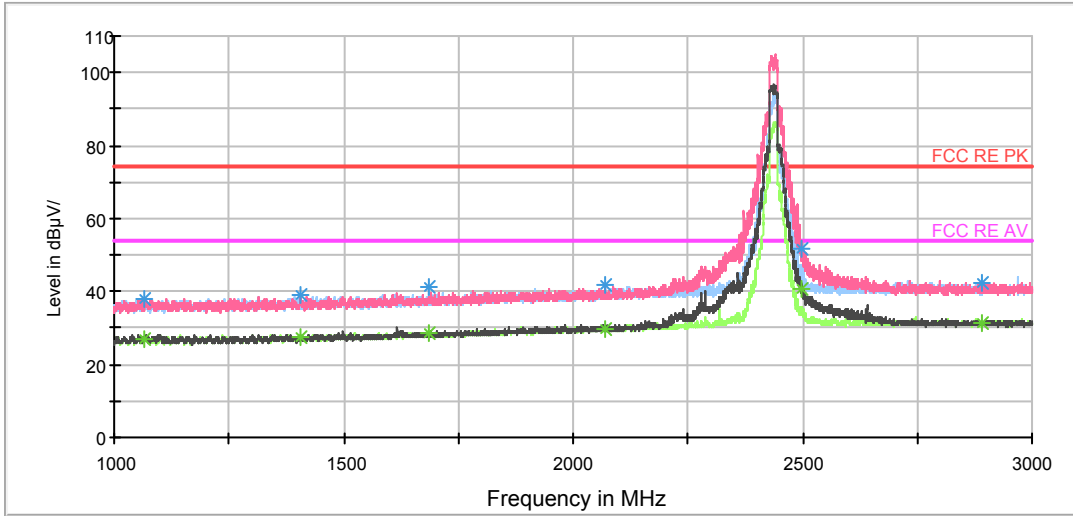

Note: The signal beyond the limit is carrier.  
Radiates Emission from 1GHz to 3GHz

FCC RE 1G-18GHz PK+AV Class B

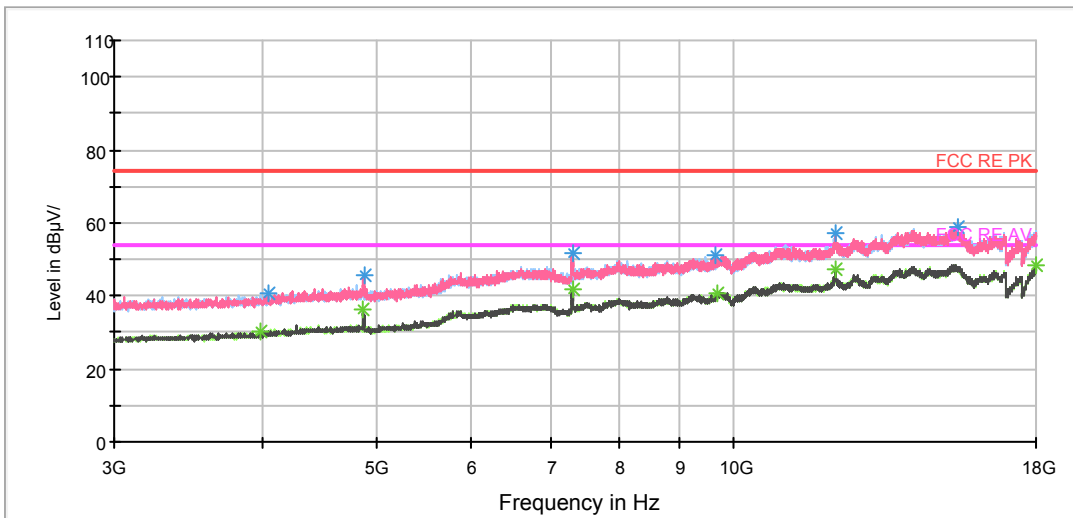

Radiates Emission from 3GHz to 18GHz

RE 18-26.5GHz PK+AV

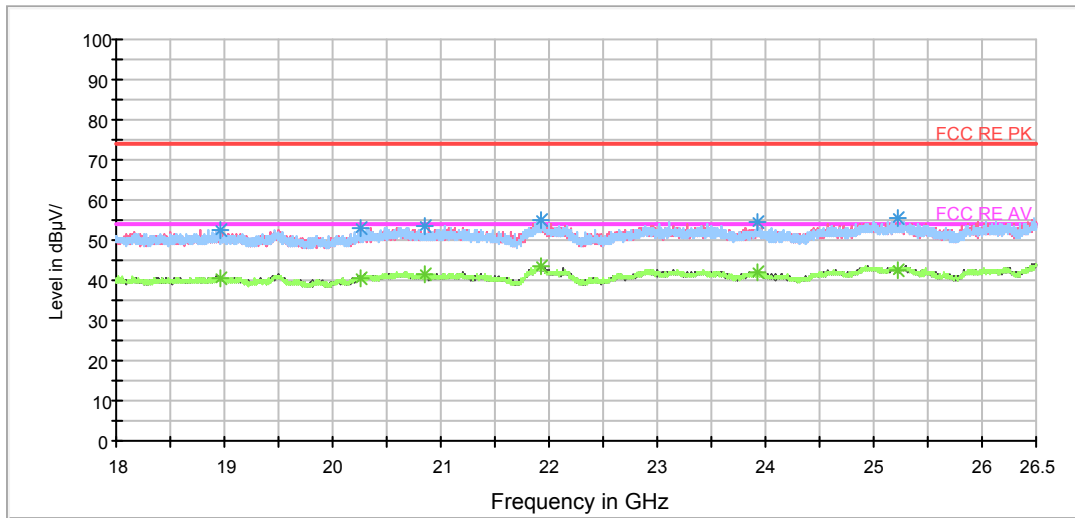

Radiates Emission from 18GHz to 26.5GHz

Frequency (MHz)	Peak (dBuV/m)	Height (cm)	Polarization	Azimuth (deg)	Reading value (dBuV/m)	Correct Factor (dB)	Margin (dB)	Limit (dBuV/m)
1065.000000	38.2	100.0	V	3.0	47.1	-8.9	35.8	74
1406.250000	38.8	100.0	V	2.0	45.7	-6.9	35.2	74
1685.500000	41.1	100.0	H	270.0	46.5	-5.4	32.9	74
2071.500000	41.7	100.0	V	4.0	44.6	-2.9	32.3	74
2498.750000	51.5	100.0	V	256.0	52.4	-0.9	22.5	74
2891.750000	42.4	100.0	H	151.0	43.0	-0.6	31.6	74

Remark: 1. Correction Factor = Antenna factor+ Insertion loss (cable loss + amplifier gain)

Frequency (MHz)	Average (dBuV/m)	Height (cm)	Polarization	Azimuth (deg)	Reading value (dBuV/m)	Correct Factor (dB)	Margin (dB)	Limit (dBuV/m)
1065.000000	27.2	100.0	V	3.0	36.1	-8.9	26.8	54
1406.250000	27.5	100.0	V	2.0	34.4	-6.9	26.5	54
1685.500000	28.6	100.0	H	270.0	34.0	-5.4	25.4	54
2071.500000	29.7	100.0	V	4.0	32.6	-2.9	24.3	54
2498.250000	40.6	100.0	V	0.0	41.5	-0.9	13.4	54
2891.750000	31.3	100.0	H	151.0	31.9	-0.6	22.7	54

Remark: 1. Correction Factor = Antenna factor+ Insertion loss (cable loss + amplifier gain)

802.11n (HT20) CH11

FCC RE 1G-18GHz PK+AV Class B

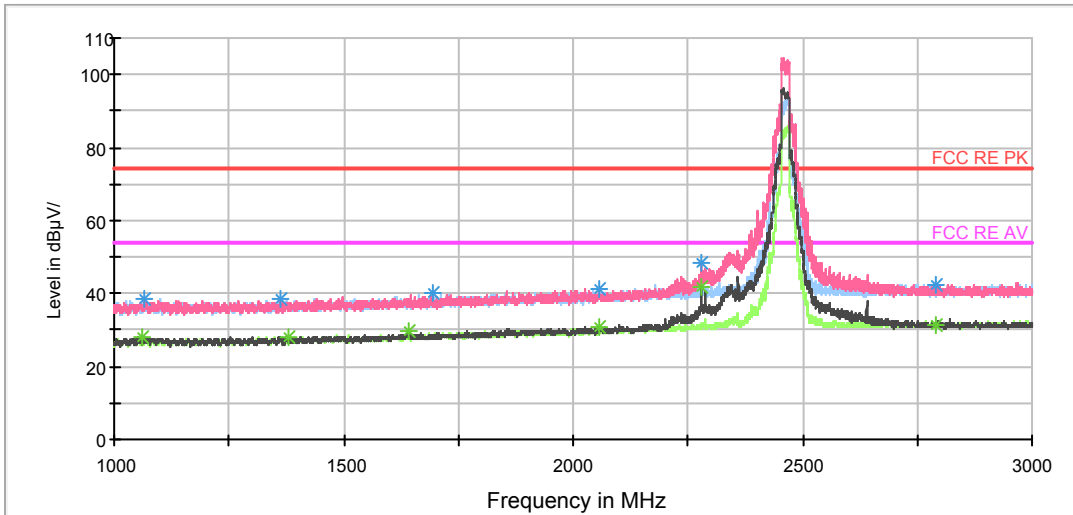

Note: The signal beyond the limit is carrier.  
Radiates Emission from 1GHz to 3GHz

FCC RE 1G-18GHz PK+AV Class B

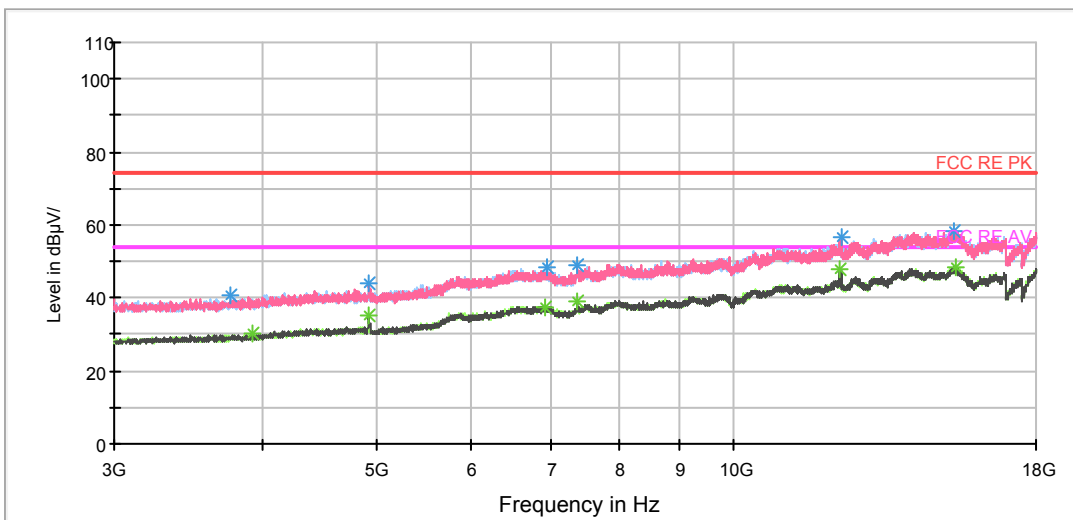

Radiates Emission from 3GHz to 18GHz

RE 18-26.5GHz PK+AV

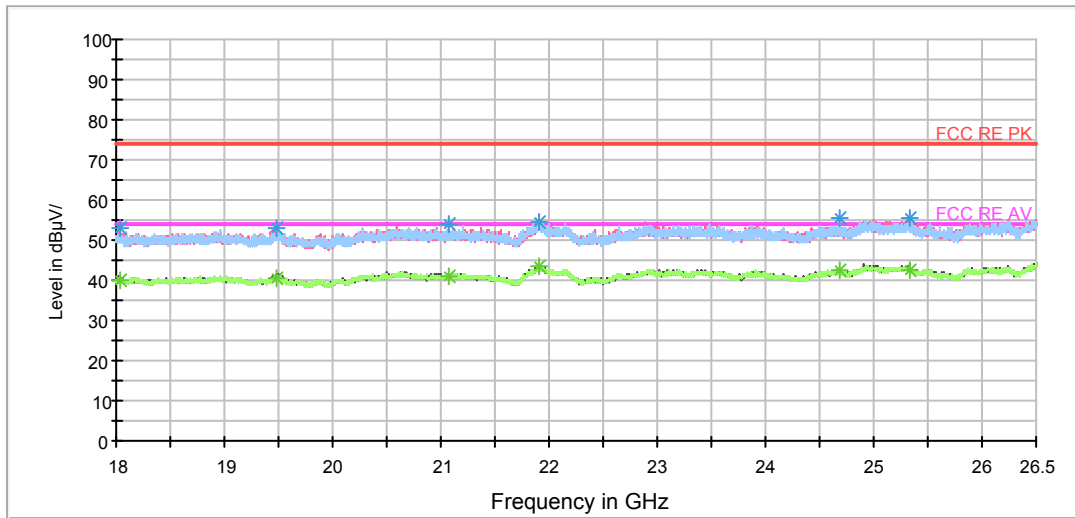

Radiates Emission from 18GHz to 26.5GHz

Frequency (MHz)	Peak (dBuV/m)	Height (cm)	Polarization	Azimuth (deg)	Reading value (dBuV/m)	Correct Factor (dB)	Margin (dB)	Limit (dBuV/m)
1064.500000	38.3	100.0	V	156.0	47.2	-8.9	35.7	74
1361.000000	38.7	100.0	V	147.0	45.9	-7.2	35.3	74
1693.750000	40.0	100.0	V	18.0	45.3	-5.3	34.0	74
2055.250000	41.0	100.0	V	33.0	44.1	-3.1	33.0	74
2280.000000	48.5	100.0	V	278.0	50.4	-1.9	25.5	74
2788.750000	42.3	100.0	V	9.0	42.8	-0.5	31.7	74

Remark: 1. Correction Factor = Antenna factor+ Insertion loss (cable loss + amplifier gain)

Frequency (MHz)	Average (dBuV/m)	Height (cm)	Polarization	Azimuth (deg)	Reading value (dBuV/m)	Correct Factor (dB)	Margin (dB)	Limit (dBuV/m)
1062.750000	28.0	100.0	V	176.0	36.9	-8.9	26.0	54
1378.750000	28.2	100.0	V	137.0	35.3	-7.1	25.8	54
1642.000000	29.5	100.0	V	9.0	35.1	-5.6	24.5	54
2056.500000	30.8	100.0	V	0.0	33.9	-3.1	23.2	54
2280.000000	41.9	100.0	V	278.0	43.8	-1.9	12.1	54
2788.750000	31.2	100.0	V	9.0	31.7	-0.5	22.8	54

Remark: 1. Correction Factor = Antenna factor+ Insertion loss (cable loss + amplifier gain)



802.11n (HT40) CH3

FCC RE 1G-18GHz PK+AV Class B

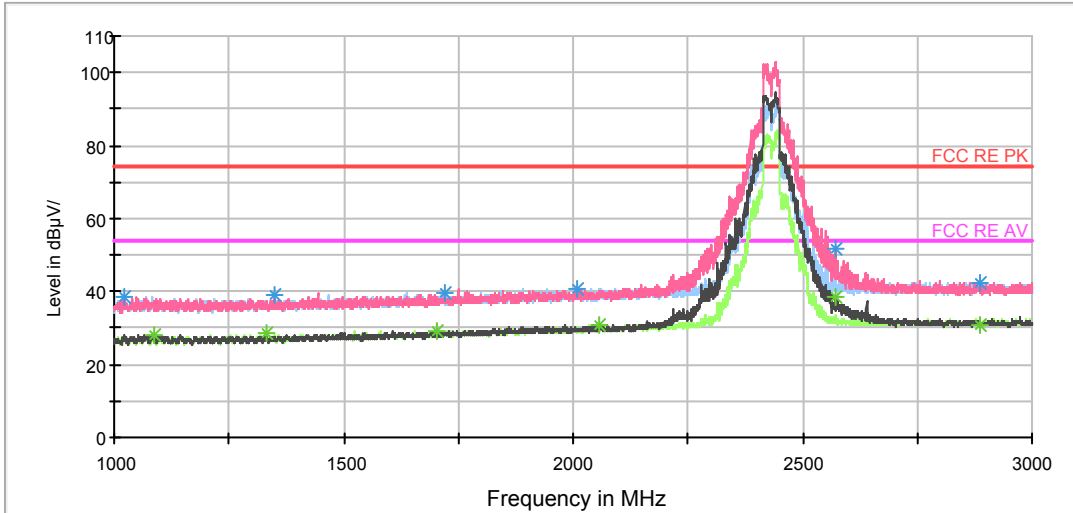

Note: The signal beyond the limit is carrier.  
Radiates Emission from 1GHz to 3GHz

FCC RE 1G-18GHz PK+AV Class B

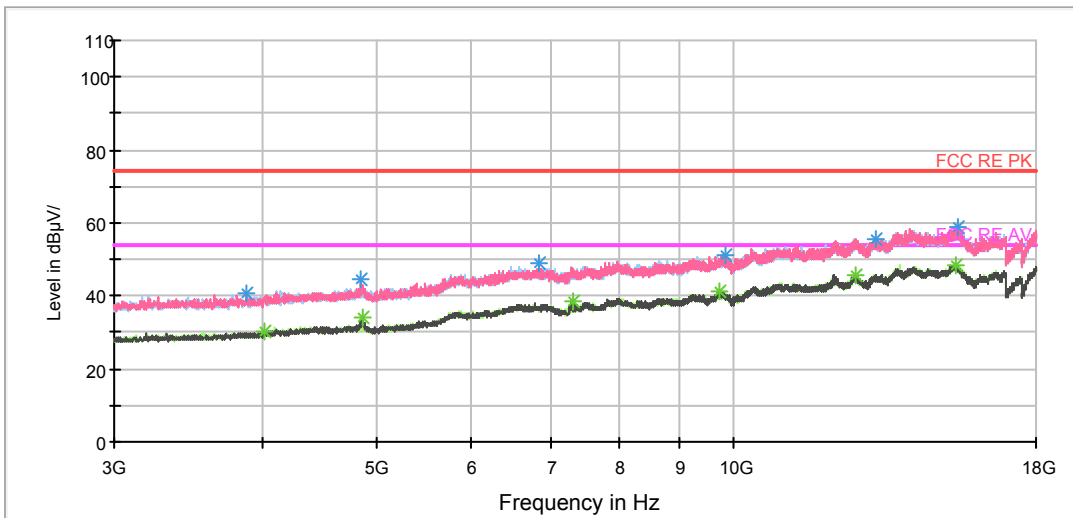

Radiates Emission from 3GHz to 18GHz

RE 18-26.5GHz PK+AV

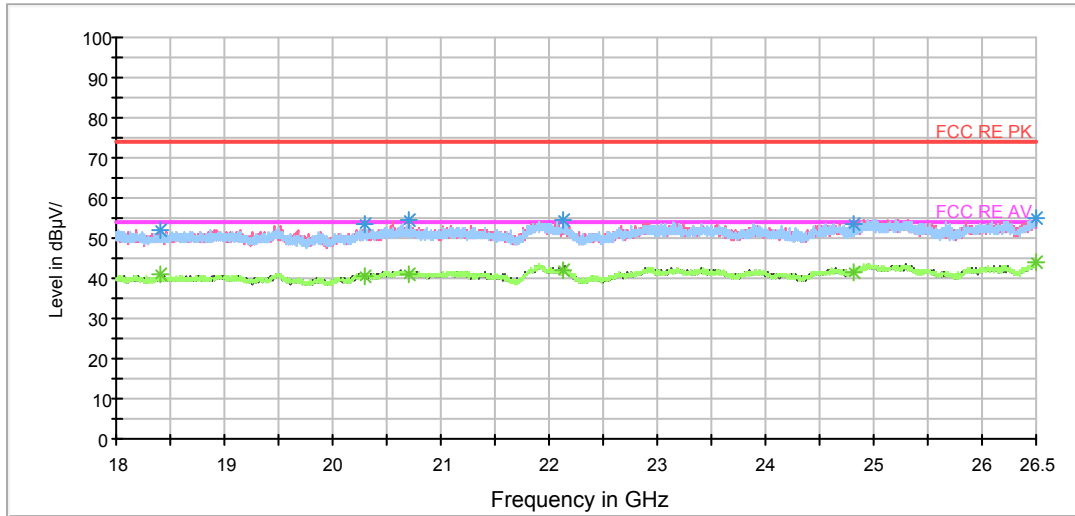

Radiates Emission from 18GHz to 26.5GHz

Frequency (MHz)	Peak (dBuV/m)	Height (cm)	Polarization	Azimuth (deg)	Reading value (dBuV/m)	Correct Factor (dB)	Margin (dB)	Limit (dBuV/m)
1020.000000	38.6	100.0	V	339.0	47.7	-9.1	35.4	74
1349.750000	39.2	100.0	H	347.0	46.5	-7.3	34.8	74
1721.250000	39.9	100.0	V	12.0	45.0	-5.1	34.1	74
2009.250000	40.9	100.0	V	0.0	44.3	-3.4	33.1	74
2571.250000	51.7	100.0	V	278.0	52.5	-0.8	22.3	74
2886.250000	42.3	100.0	H	342.0	42.8	-0.5	31.7	74

Remark: 1. Correction Factor = Antenna factor+ Insertion loss (cable loss + amplifier gain)

Frequency (MHz)	Average (dBuV/m)	Height (cm)	Polarization	Azimuth (deg)	Reading value (dBuV/m)	Correct Factor (dB)	Margin (dB)	Limit (dBuV/m)
1086.250000	28.2	100.0	V	0.0	37.0	-8.8	25.8	54
1331.750000	28.3	100.0	H	356.0	35.8	-7.5	25.7	54
1702.250000	29.2	100.0	H	359.0	34.5	-5.3	24.8	54
2058.250000	30.8	100.0	V	60.0	33.9	-3.1	23.2	54
2571.500000	38.5	100.0	V	278.0	39.3	-0.8	15.5	54
2886.250000	30.9	100.0	H	342.0	31.4	-0.5	23.1	54

Remark: 1. Correction Factor = Antenna factor+ Insertion loss (cable loss + amplifier gain)



802.11n (HT40) CH6

FCC RE 1G-18GHz PK+AV Class B

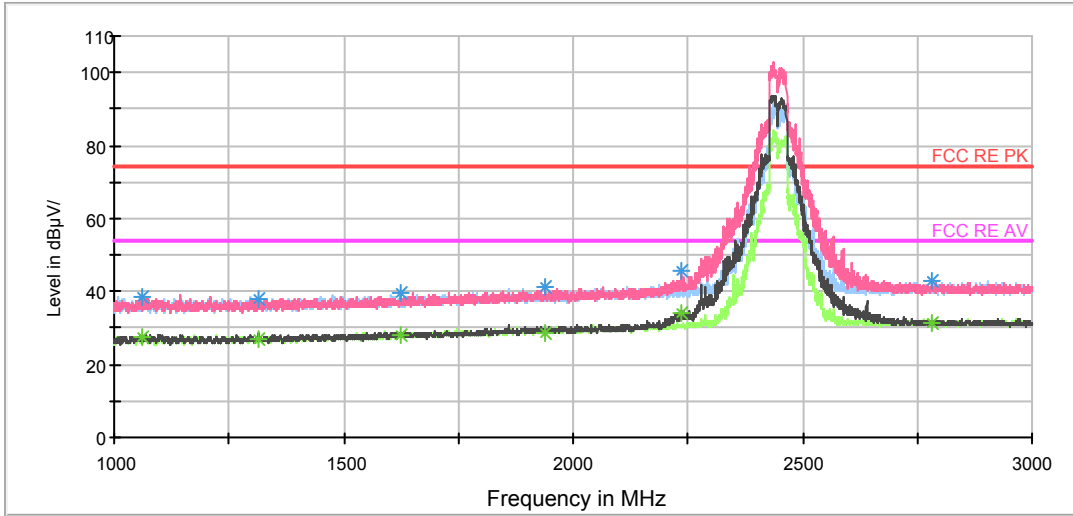

Note: The signal beyond the limit is carrier.  
Radiates Emission from 1GHz to 3GHz

FCC RE 1G-18GHz PK+AV Class B

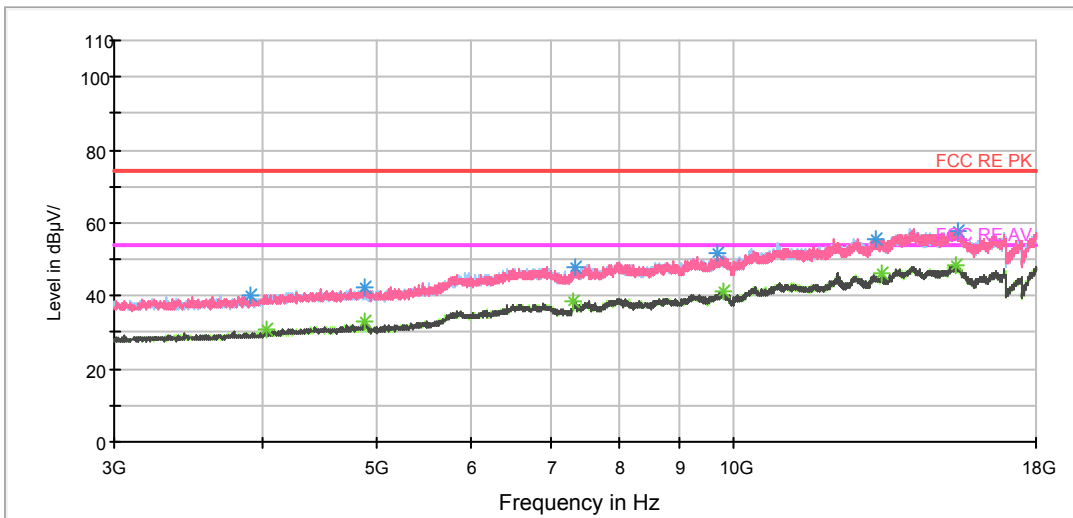

Radiates Emission from 3GHz to 18GHz

RE 18-26.5GHz PK+AV

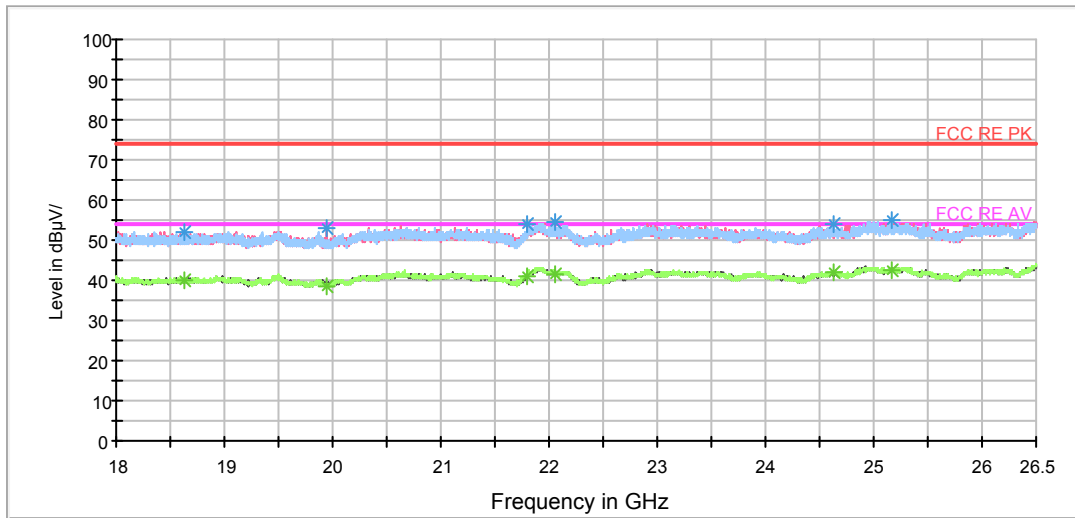

Radiates Emission from 18GHz to 26.5GHz

Frequency (MHz)	Peak (dBuV/m)	Height (cm)	Polarization	Azimuth (deg)	Reading value (dBuV/m)	Correct Factor (dB)	Margin (dB)	Limit (dBuV/m)
1062.500000	38.5	100.0	V	4.0	47.4	-8.9	35.5	74
1315.750000	37.9	100.0	V	156.0	45.4	-7.5	36.1	74
1626.000000	39.4	100.0	V	42.0	45.1	-5.7	34.6	74
1938.250000	41.1	100.0	V	42.0	45.0	-3.9	32.9	74
2237.000000	45.6	100.0	V	279.0	47.7	-2.1	28.4	74
2780.500000	43.0	100.0	H	358.0	43.5	-0.5	31.0	74

Remark: 1. Correction Factor = Antenna factor+ Insertion loss (cable loss + amplifier gain)

Frequency (MHz)	Average (dBuV/m)	Height (cm)	Polarization	Azimuth (deg)	Reading value (dBuV/m)	Correct Factor (dB)	Margin (dB)	Limit (dBuV/m)
1062.500000	27.5	100.0	V	4.0	36.4	-8.9	26.5	54
1315.750000	27.2	100.0	V	156.0	34.7	-7.5	26.8	54
1626.000000	28.0	100.0	V	42.0	33.7	-5.7	26.0	54
1938.250000	28.8	100.0	V	42.0	32.7	-3.9	25.2	54
2237.000000	34.2	100.0	V	279.0	36.3	-2.1	19.8	54
2780.500000	31.2	100.0	H	358.0	31.7	-0.5	22.8	54

Remark: 1. Correction Factor = Antenna factor+ Insertion loss (cable loss + amplifier gain)

802.11n (HT40) CH9

FCC RE 1G-18GHz PK+AV Class B

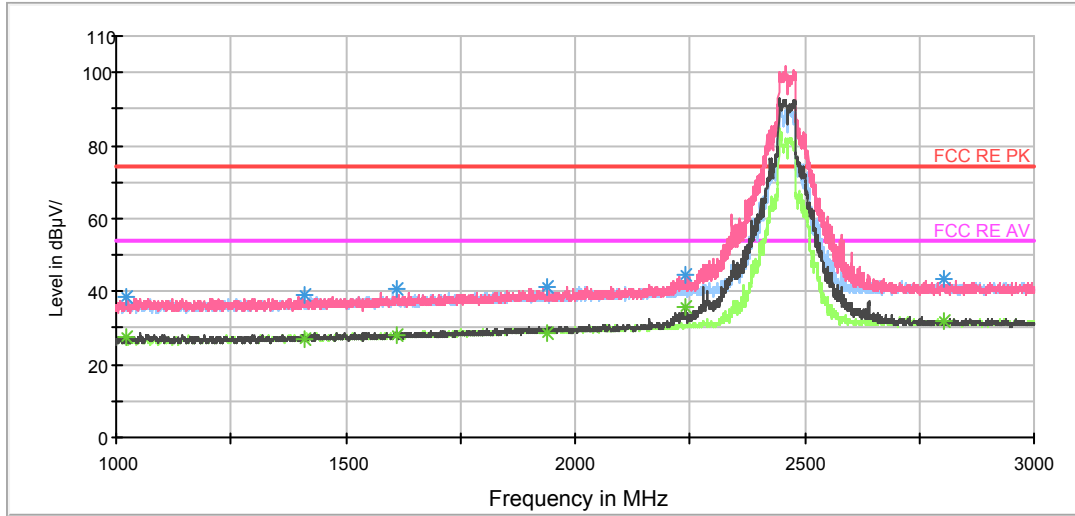

Note: The signal beyond the limit is carrier.  
Radiates Emission from 1GHz to 3GHz

FCC RE 1G-18GHz PK+AV Class B

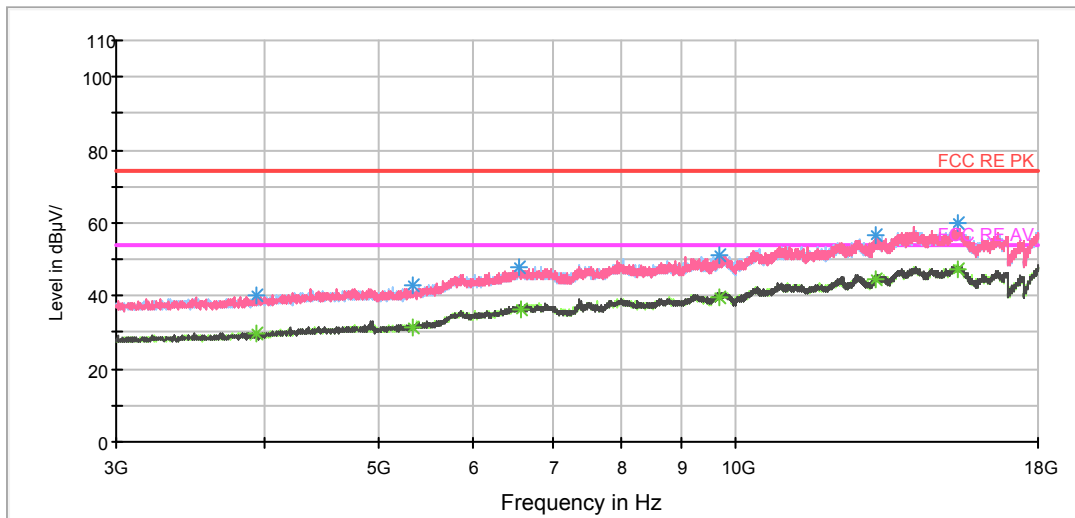

Radiates Emission from 3GHz to 18GHz

RE 18-26.5GHz PK+AV

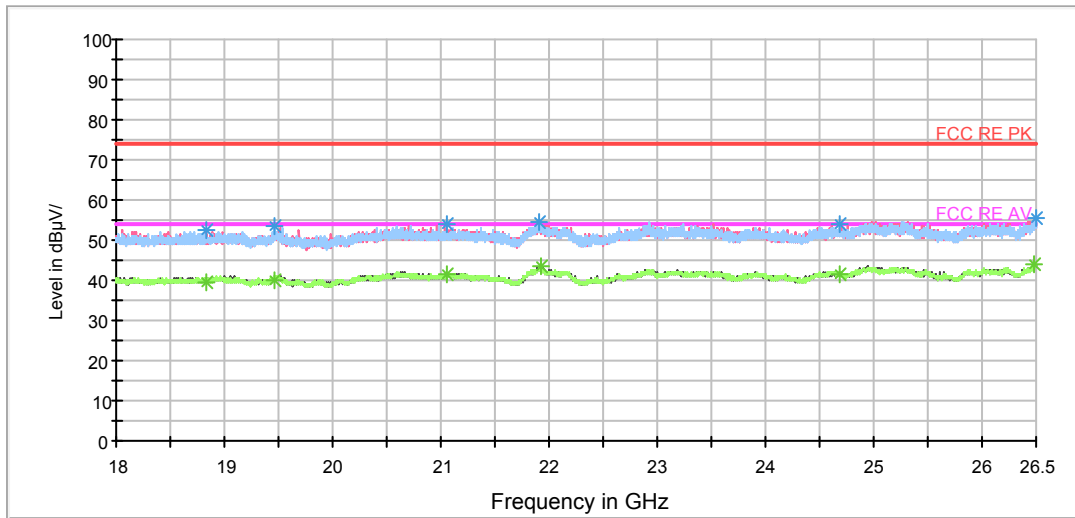

Radiates Emission from 18GHz to 26.5GHz

Frequency (MHz)	Peak (dBuV/m)	Height (cm)	Polarization	Azimuth (deg)	Reading value (dBuV/m)	Correct Factor (dB)	Margin (dB)	Limit (dBuV/m)
1023.250000	38.3	100.0	V	9.0	47.4	-9.1	35.7	74
1410.000000	38.9	100.0	H	352.0	45.8	-6.9	35.1	74
1610.250000	40.5	100.0	H	310.0	46.3	-5.8	33.5	74
1938.000000	41.2	100.0	H	336.0	45.1	-3.9	32.8	74
2239.750000	44.3	100.0	V	277.0	46.4	-2.1	29.7	74
2802.750000	43.2	100.0	V	264.0	43.8	-0.6	30.8	74

Remark: 1. Correction Factor = Antenna factor+ Insertion loss (cable loss + amplifier gain)

Frequency (MHz)	Average (dBuV/m)	Height (cm)	Polarization	Azimuth (deg)	Reading value (dBuV/m)	Correct Factor (dB)	Margin (dB)	Limit (dBuV/m)
1023.250000	27.2	100.0	V	9.0	36.3	-9.1	26.8	54
1410.000000	26.7	100.0	H	352.0	33.6	-6.9	27.3	54
1610.250000	27.9	100.0	H	310.0	33.7	-5.8	26.1	54
1938.000000	28.8	100.0	H	336.0	32.7	-3.9	25.2	54
2239.750000	35.5	100.0	V	277.0	37.6	-2.1	18.5	54
2802.750000	31.9	100.0	V	264.0	32.5	-0.6	22.1	54

Remark: 1. Correction Factor = Antenna factor+ Insertion loss (cable loss + amplifier gain)

### 5.8. Conducted Emission

#### Ambient condition

Temperature	Relative humidity	Pressure
23°C ~25°C	45%~50%	101.5kPa

#### Methods of Measurement

The EUT is placed on a non-metallic table of 80cm height above the horizontal metal reference ground plane. During the test, the EUT was operating in its typical mode. The test method is according to ANSI C63.10-2013. Connect the AC power line of the EUT to the L.I.S.N. Use EMI receiver to detect the average and Quasi-peak value. RBW is set to 9 kHz, VBW is set to 30kHz. The measurement result should include both L line and N line.

The test is in transmitting mode.

#### Test Setup

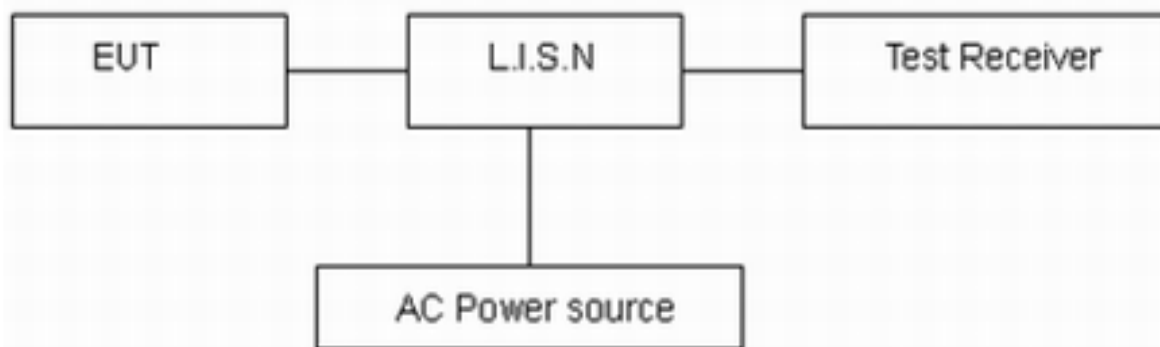

Note: AC Power source is used to change the voltage 110V/60Hz.

#### Limits

Frequency (MHz)	Conducted Limits(dBμV)	
	Quasi-peak	Average
0.15 - 0.5	66 to 56 *	56 to 46 *
0.5 - 5	56	46
5 - 30	60	50

\*: Decreases with the logarithm of the frequency.

#### Measurement Uncertainty

The assessed measurement uncertainty to ensure 95% confidence level for the normal distribution is with the coverage factor  $k = 1.96$ ,  $U = 2.69$  dB.

**Test Results:**

Following plots, Blue trace uses the peak detection and Green trace uses the average detection. During the test, the Conducted Emission was performed in all modes with all channels, 802.11b, Channel 6 are selected as the worst condition. The test data of the worst-case condition was recorded in this report.

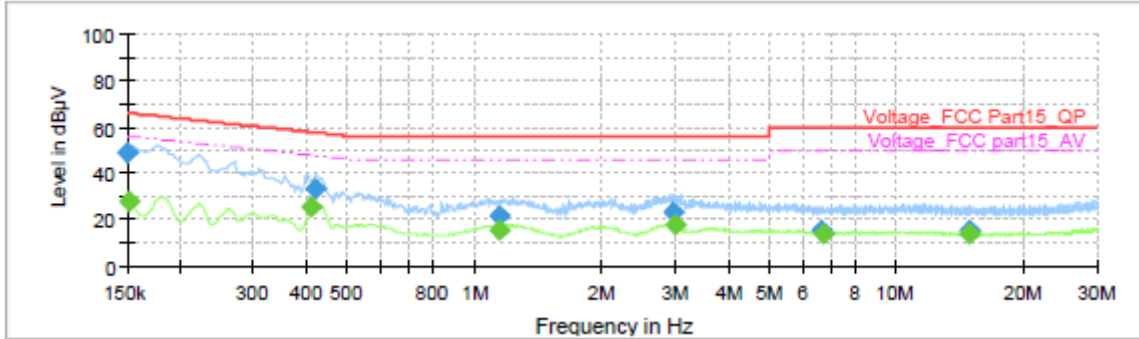

Frequency (MHz)	QuasiPeak (dBµV)	Average (dBµV)	Limit (dBµV)	Margin (dB)	Meas. Time (ms)	Bandwidth (kHz)	Line	Filter	Corr. (dB)
0.150000	49.00	---	66.00	17.00	1000.0	9.000	L1	ON	19.1
0.152250	---	27.72	55.88	28.16	1000.0	9.000	L1	ON	19.0
0.411000	---	25.45	47.63	22.17	1000.0	9.000	L1	ON	19.2
0.417750	33.47	---	57.49	24.02	1000.0	9.000	L1	ON	19.2
1.142250	---	15.32	46.00	30.68	1000.0	9.000	L1	ON	19.2
1.146750	21.34	---	56.00	34.66	1000.0	9.000	L1	ON	19.2
2.946750	22.88	---	56.00	33.12	1000.0	9.000	L1	ON	19.1
2.978250	---	17.98	46.00	28.02	1000.0	9.000	L1	ON	19.1
6.650250	15.25	---	60.00	44.75	1000.0	9.000	L1	ON	19.1
6.733500	---	13.98	50.00	36.02	1000.0	9.000	L1	ON	19.1
14.916750	15.46	---	60.00	44.54	1000.0	9.000	L1	ON	19.5
14.966250	---	13.66	50.00	36.34	1000.0	9.000	L1	ON	19.5

L Line

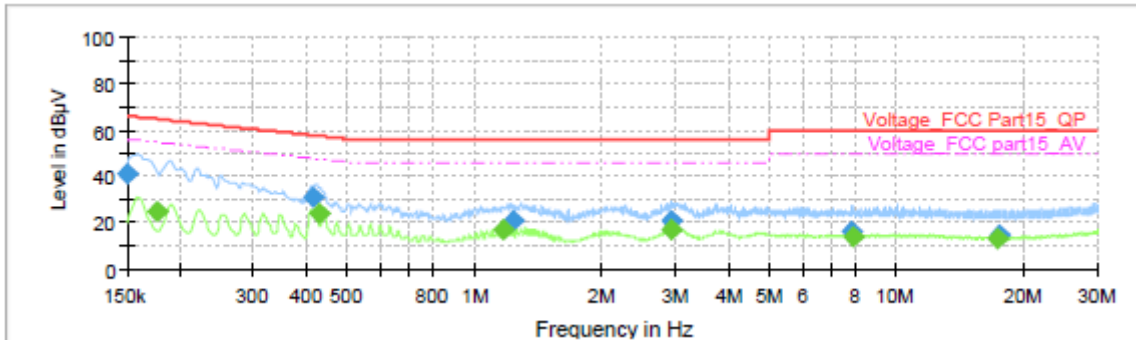

Frequency (MHz)	QuasiPeak (dBµV)	Average (dBµV)	Limit (dBµV)	Margin (dB)	Meas. Time (ms)	Bandwidth (kHz)	Line	Filter	Corr. (dB)
0.150000	41.40	---	66.00	24.60	1000.0	9.000	N	ON	19.1
0.177000	---	24.57	54.63	30.06	1000.0	9.000	N	ON	19.2
0.413250	30.85	---	57.58	26.74	1000.0	9.000	N	ON	19.2
0.429000	---	24.13	47.27	23.14	1000.0	9.000	N	ON	19.2
1.176000	---	17.22	46.00	28.78	1000.0	9.000	N	ON	19.2
1.230000	21.30	---	56.00	34.70	1000.0	9.000	N	ON	19.2
2.917500	---	16.70	46.00	29.30	1000.0	9.000	N	ON	19.1
2.922000	20.69	---	56.00	35.31	1000.0	9.000	N	ON	19.1
7.815750	15.94	---	60.00	44.06	1000.0	9.000	N	ON	19.2
7.928250	---	14.23	50.00	35.77	1000.0	9.000	N	ON	19.2
17.425500	---	13.07	50.00	36.93	1000.0	9.000	N	ON	19.5
17.470500	14.46	---	60.00	45.54	1000.0	9.000	N	ON	19.5

N Line



## 6. Main Test Instruments

Name	Manufacturer	Type	Serial Number	Calibration Date	Expiration Date
Spectrum Analyzer	R&S	FSV30	100815	2016-12-16	2017-12-15
EMI Test Receiver	R&S	ESCI	100948	2017-05-20	2018-05-19
TRILOG Broadband Antenna	Schwarzbeck	VULB 9163	9163-201	2014-12-06	2017-12-05
TRILOG Broadband Antenna	Schwarzbeck	VULB 9163	9163-201	2017-11-18	2020-11-17
Double Ridged Waveguide Horn Antenna	R&S	HF907	100126	2014-12-06	2019-12-05
Loop Antenna	SCHWARZBECK	FMZB1519	1519-047	2017-02-18	2020-02-17
Standard Gain Horn	ETS-Lindgren	3160-09	00102644	2015-01-30	2018-01-29
EMI Test Receiver	R&S	ESCS30	100138	2016-12-16	2017-12-15
LISN	R&S	ENV216	101171	2016-12-16	2019-12-15
Spectrum Analyzer	Agilent	N9010A	MY47191109	2017-05-20	2018-05-19
RF Cable	Agilent	SMA 15cm	0001	2017-08-04	2018-02-03
Software (CE)	ROHDE&SCHW ARZ	EMC32	9.26.0	/	/
Software (RE/RSE)	ROHDE&SCHW ARZ	EMC32	8.52.0	/	/

\*\*\*\*\*END OF REPORT \*\*\*\*\*