



RF TEST REPORT

Applicant UAB Teltonika
FCC ID 2AET4RUT240V
Product LTE Router
Brand Teltonika
Model RUT240
Report No. RXA1708-0301RF01R1
Issue Date December 20, 2017

TA Technology (Shanghai) Co., Ltd. tested the above equipment in accordance with the requirements in **FCC CFR47 Part 2 (2017)/ FCC CFR47 Part 27C (2017)**. The test results show that the equipment tested is capable of demonstrating compliance with the requirements as documented in this report.

Jiang peng Lan

Performed by: Jiangpeng Lan

Kai Xu

Approved by: Kai Xu

TA Technology (Shanghai) Co., Ltd.

No.145, Jintang Rd, Tangzhen Industry Park, Pudong Shanghai, China

TEL: +86-021-50791141/2/3

FAX: +86-021-50791141/2/3-8000

Table of Contents

1	Test Laboratory.....	4
1.1	Notes of the Test Report.....	4
1.2	Test facility.....	4
1.3	Testing Location.....	5
2	General Description of Equipment under Test.....	6
3	Applied Standards.....	7
4	Test Configuration.....	8
5	Test Case Results.....	9
5.1	RF Power Output.....	9
5.2	Effective Isotropic Radiated Power.....	14
5.3	Occupied Bandwidth.....	19
5.4	Band Edge Compliance.....	30
5.5	Peak-to-Average Power Ratio (PAPR).....	48
5.6	Frequency Stability.....	51
5.7	Spurious Emissions at Antenna Terminals.....	56
5.8	Radiates Spurious Emission.....	66
6	Main Test Instruments.....	81
ANNEX A:	EUT Appearance and Test Setup.....	82
A.1	EUT Appearance.....	82
A.2	Test Setup.....	83

Summary of Measurement Results

Number	Test Case	Clause in FCC rules	Verdict
1	RF power output	2.1046	PASS
2	Effective Isotropic Radiated power	27.50(d)(4)/ 27.50(b)(10)	PASS
3	Occupied Bandwidth	2.1049	PASS
4	Band Edge Compliance	27.53(h) /27.53(g) /27.53(c)	PASS
5	Peak-to-Average Power Ratio	27.50(d)/KDB971168 D01(5.7)	PASS
6	Frequency Stability	2.1055 / 27.54	PASS
7	Spurious Emissions at Antenna Terminals	2.1051 / 27.53(h) /27.53(g) /27.53(f)	PASS
8	Radiates Spurious Emission	2.1053 /27.53(h) /27.53(g) /27.53(f)	PASS
Date of Testing: November 5, 2017 ~ November 29, 2017			
Note: PASS: The EUT complies with the essential requirements in the standard. FAIL: The EUT does not comply with the essential requirements in the standard.			

1 Test Laboratory

1.1 Notes of the Test Report

This report shall not be reproduced in full or partial, without the written approval of **TA technology (shanghai) co., Ltd.** The results documented in this report apply only to the tested sample, under the conditions and modes of operation as described herein .Measurement Uncertainties were not taken into account and are published for informational purposes only. This report is written to support regulatory compliance of the applicable standards stated above.

1.2 Test facility

CNAS (accreditation number: L2264)

TA Technology (Shanghai) Co., Ltd. has obtained the accreditation of China National Accreditation Service for Conformity Assessment (CNAS).

FCC (Designation number: CN1179, Test Firm Registration Number: 446626)

TA Technology (Shanghai) Co., Ltd. has been listed on the US Federal Communications Commission list of test facilities recognized to perform electromagnetic emissions measurements.

IC (recognition number is 8510A)

TA Technology (Shanghai) Co., Ltd. has been listed by industry Canada to perform electromagnetic emission measurement.

VCCI (recognition number is C-4595, T-2154, R-4113, G-10766)

TA Technology (Shanghai) Co., Ltd. has been listed by industry Japan to perform electromagnetic emission measurement.

A2LA (Certificate Number: 3857.01)

TA Technology (Shanghai) Co., Ltd. has been listed by American Association for Laboratory Accreditation to perform electromagnetic emission measurement.

1.3 Testing Location

Company: TA Technology (Shanghai) Co., Ltd.
Address: No.145, Jintang Rd, Tangzhen Industry Park, Pudong Shanghai, China
City: Shanghai
Post code: 201201
Country: P. R. China
Contact: Xu Kai
Telephone: +86-021-50791141/2/3
Fax: +86-021-50791141/2/3-8000
Website: <http://www.ta-shanghai.com>
E-mail: xukai@ta-shanghai.com

2 General Description of Equipment under Test

Client Information

Applicant	UAB TELTONIKA
Applicant address	Saltoniskiu st. 10c, Vilnius, Lithuania
Manufacturer	UAB TELTONIKA
Manufacturer address	Saltoniskiu st. 10c, Vilnius, Lithuania

General information

EUT Description			
Model	RUT240		
IMEI	861107031948582		
Hardware Version	5		
Software Version	RUT2XX_R_00.00.284		
Power Supply	Adapter		
Antenna Type	Sub or Retractable Antenna		
Test Mode(s)	LTE Band 4; LTE Band 13,		
Test Modulation	QPSK; 16QAM; 64QAM;		
LTE Category	4		
Maximum E.I.R.P./ E.R.P.	LTE Band 4:	26.93dBm	
	LTE Band 13:	23.73dBm	
Rated Power Supply Voltage:	9V		
Extreme Voltage	Minimum: 7V Maximum: 30V		
Extreme Temperature	Lowest: -40°C Highest: +75°C		
Operating Frequency Range(s)	Mode	Tx (MHz)	Rx (MHz)
	LTE Band 4	1710 ~ 1755	2110 ~ 2155
	LTE Band 13	777 ~ 787	746 ~ 756
EUT Accessory			
Adapter	Manufacturer: Shenzhen Shengji Mains CO., LTD Model: SJ-09010033		
LTE antenna	Manufacturer: Beyondoors Model: BY-LTE-03-03-Silkscreen-LTE		
WiFi antenna	Manufacturer: Beyondoors Model: BY-2400-05-05-01-Silkscreen-WiFi		
Note: 1. The information of the EUT is declared by the manufacturer.			

3 Applied Standards

According to the specifications of the manufacturer, it must comply with the requirements of the following standards:

Test standards

FCC CFR47 Part 2 (2017)

FCC CFR47 Part 27C (2017)

ANSI/TIA-603-D (2010)

KDB 971168 D01 Power Meas License Digital Systems v03

4 Test Configuration

Radiated measurements are performed by rotating the EUT in three different orthogonal test planes. EUT stand-up position (Z axis), lie-down position (X, Y axis). Receiver antenna polarization (horizontal and vertical), the worst emission was found in position (Z axis, horizontal polarization) and the worst case was recorded.

All mode and data rates and positions and RB size and modulations were investigated.

Subsequently, only the worst case emissions are reported.

The following testing in LTE is set based on the maximum RF Output Power.

The following testing in different Bandwidth is set to detail in the following table:

Test modes are chosen to be reported as the worst case configuration below for LTE Band 4/13:

Test items	Modes	Bandwidth (MHz)						Modulation		RB			Test Channel			
		1.4	3	5	10	15	20	QPSK	16QAM	1	50%	100%	L	M	H	
RF power output	LTE 4	O	O	O	O	O	O	O	O	O	O	O	O	O	O	O
	LTE 13	-	-	O	O	-	-	O	O	O	O	O	O	O	O	O
Effective Isotropic Radiated power	LTE 4	O	O	O	O	O	O	O	O	-	-	O	O	O	O	
	LTE 13	-	-	O	O	-	-	O	O	-	-	O	O	O	O	
Occupied Bandwidth	LTE 4	O	O	O	O	O	O	O	O	-	-	O	O	O	O	
	LTE 13	-	-	O	O	-	-	O	O	-	-	O	O	O	O	
Band Edge Compliance	LTE 4	O	O	O	O	O	O	O	O	O	-	O	O	-	O	
	LTE 13	-	-	O	O	-	-	O	O	O	-	O	O	-	O	
Peak-to-Average Power Ratio	LTE 4	O	O	O	O	O	O	O	O	-	-	O	O	O	O	
	LTE 13	-	-	O	O	-	-	O	O	-	-	O	O	O	O	
Frequency Stability	LTE 4	O	O	O	O	O	O	O	O	-	-	O	-	O	-	
	LTE 13	-	-	O	O	-	-	O	O	-	-	O	-	O	-	
Spurious Emissions at Antenna Terminals	LTE 4	O	O	O	O	O	O	-	O	O	-	-	O	O	O	
	LTE 13	-	-	O	O	-	-	-	O	O	-	-	O	O	O	
Radiates Spurious Emission	LTE 4	O	O	O	O	O	O	-	O	O	-	-	O	O	O	
	LTE 13	-	-	O	O	-	-	-	O	O	-	-	O	O	O	
Note	1. The mark "O" means that this configuration is chosen for testing. 2. The mark "-" means that this configuration is not testing.															

5 Test Case Results

5.1 RF Power Output

Ambient condition

Temperature	Relative humidity	Pressure
23°C ~25°C	45%~50%	101.5kPa

Methods of Measurement

During the process of the testing, The EUT is controlled by the Base Station Simulator to ensure max power transmission and proper modulation.

Test Setup

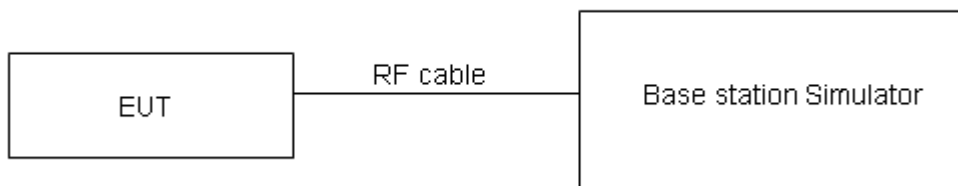

The loss between RF output port of the EUT and the input port of the tester has been taken into consideration.

Limits

No specific RF power output requirements in part 2.1046.

Measurement Uncertainty

The assessed measurement uncertainty to ensure 95% confidence level for the normal distribution is with the coverage factor $k = 2$, $U=0.4$ dB.

Test Results

LTE Band 4				AV Conducted Power(dBm)		
Bandwidth	Modulation	RB size	RB offset	Channel/Frequency (MHz)		
				19957/1710.7	20175/1732.5	20393/1754.3
1.4MHz	QPSK	1	0	22.90	22.89	22.82
		1	2	23.08	23.05	22.92
		1	5	23.01	22.88	22.94
		3	0	23.07	22.98	22.63
		3	2	23.18	23.11	22.83
		3	3	23.05	22.81	22.77
		6	0	22.08	22.00	21.62
	16QAM	1	0	22.30	21.70	21.85
		1	2	22.52	21.96	21.95
		1	5	22.34	21.75	21.82
		3	0	22.02	21.96	21.42
		3	2	22.35	22.21	21.83
		3	3	22.08	21.85	21.55
		6	0	20.91	21.12	20.78
Bandwidth	Modulation	RB size	RB offset	Channel/Frequency (MHz)		
				19965/1711.5	20175/1732.5	20385/1753.5
3MHz	QPSK	1	0	23.02	23.03	22.79
		1	7	23.00	22.77	22.75
		1	14	23.14	22.49	22.68
		8	0	21.92	21.88	21.85
		8	4	21.99	22.35	21.68
		8	7	21.90	21.67	21.57
		15	0	21.91	21.77	21.76
	16QAM	1	0	21.92	22.52	22.38
		1	7	21.74	22.47	22.40
		1	14	21.74	22.32	22.32
		8	0	20.99	20.86	20.94
		8	4	21.15	21.55	20.75
		8	7	20.98	20.73	20.61
		15	0	20.93	20.98	20.84
Bandwidth	Modulation	RB size	RB offset	Channel/Frequency (MHz)		
				19975/1712.5	20175/1732.5	20375/1752.5
5MHz	QPSK	1	0	22.99	23.01	22.75
		1	13	22.98	22.73	22.72
		1	24	23.11	22.44	22.64
		12	0	21.89	21.83	21.81
		12	6	21.97	22.31	21.63
		12	13	21.88	21.65	21.53
		25	0	21.89	21.76	21.74



Bandwidth	Modulation	RB size	RB offset	Channel/Frequency (MHz)		
				20000/1715	20175/1732.5	20350/1750
	16QAM	1	0	21.89	22.48	22.35
		1	13	21.71	22.45	22.37
		1	24	21.71	22.30	22.28
		12	0	20.97	20.82	20.91
		12	6	21.12	21.50	20.71
		12	13	20.95	20.68	20.57
		25	0	20.91	20.94	20.79
Bandwidth	Modulation	RB size	RB offset	Channel/Frequency (MHz)		
				20025/1717.5	20175/1732.5	20325/1747.5
10MHz	QPSK	1	0	23.01	23.02	22.78
		1	25	23.01	22.78	22.76
		1	49	23.13	22.48	22.67
		25	0	21.92	21.88	21.85
		25	13	22.00	22.36	21.67
		25	25	21.90	21.69	21.58
		50	0	21.97	21.78	21.78
	16QAM	1	0	21.91	22.51	22.37
		1	25	21.74	22.49	22.40
		1	49	21.74	22.32	22.31
		25	0	21.00	20.87	20.95
		25	13	21.14	21.54	20.74
		25	25	20.98	20.73	20.61
		50	0	20.94	20.99	20.83
Bandwidth	Modulation	RB size	RB offset	Channel/Frequency (MHz)		
				20050/1720	20175/1732.5	20300/1745
15MHz	QPSK	1	0	23.00	22.98	22.76
		1	38	22.99	22.77	22.73
		1	74	23.10	22.43	22.63
		36	0	21.90	21.84	21.82
		36	18	21.97	22.31	21.63
		36	39	21.87	21.66	21.54
		75	0	21.95	21.74	21.73
	16QAM	1	0	21.86	22.49	22.35
		1	38	21.72	22.46	22.38
		1	74	21.71	22.28	22.28
		36	0	20.97	20.85	20.92
		36	18	21.11	21.49	20.70
		36	39	20.96	20.69	20.58
		75	0	20.91	20.94	20.79
Bandwidth	Modulation	RB size	RB offset	Channel/Frequency (MHz)		
				20050/1720	20175/1732.5	20300/1745
20MHz	QPSK	1	0	22.97	22.94	22.73
		1	50	22.98	22.73	22.71



		1	99	23.08	22.42	22.60
		50	0	21.87	21.79	21.78
		50	25	21.95	22.27	21.60
		50	50	21.84	21.61	21.50
		100	0	21.92	21.69	21.69
	16QAM	1	0	21.84	22.45	22.30
		1	50	21.68	22.44	22.34
		1	99	21.69	22.25	22.26
		50	0	20.94	20.81	20.89
		50	25	21.08	21.47	20.67
		50	50	20.93	20.64	20.54
		100	0	20.89	20.90	20.76

LTE Band 13				Conducted Power(dBm)		
Bandwidth	Modulation	RB size	RB offset	Channel/Frequency (MHz)		
				23205/779.5	23230/782	23255/784.5
5MHz	QPSK	1	0	23.66	23.53	23.47
		1	13	23.54	23.59	23.57
		1	24	23.50	23.58	23.42
		12	0	22.82	22.68	22.47
		12	6	22.59	22.60	22.59
		12	13	22.81	22.66	22.52
		25	0	22.65	22.65	22.60
	16QAM	1	0	22.97	22.33	22.03
		1	13	22.93	22.46	22.08
		1	24	22.89	22.29	21.94
		12	0	21.63	21.58	21.42
		12	6	21.66	21.74	21.62
		12	13	21.69	21.56	21.40
		25	0	21.68	21.61	21.75
Bandwidth	Modulation	RB size	RB offset	Channel/Frequency (MHz)		
				/	23230/782	/
10MHz	QPSK	1	0	/	23.64	/
		1	25	/	23.66	/
		1	49	/	23.60	/
		25	0	/	22.63	/
		25	13	/	22.62	/
		25	25	/	22.51	/
		50	0	/	22.54	/
	16QAM	1	0	/	23.38	/
		1	25	/	23.09	/
		1	49	/	22.85	/
		25	0	/	21.56	/
		25	13	/	21.63	/
		25	25	/	21.42	/
		50	0	/	21.60	/

5.2 Effective Isotropic Radiated Power

Ambient condition

Temperature	Relative humidity	Pressure
23°C ~25°C	45%~50%	101.5kPa

Methods of Measurement

1. The testing follows FCC KDB 971168 v03 Section 5.8 and ANSI/TIA-603-D-2010.

- a) Connect the equipment as illustrated. Mount the equipment with the manufacturer specified antenna in a vertical orientation on a manufacturer specified mounting surface located on a non-conducting rotating platform of a RF anechoic chamber (preferred) or a standard radiation site.
- b) Key the transmitter, then rotate the EUT 360° azimuthally and record spectrum analyzer power level (LVL) measurements at angular increments that are sufficiently small to permit resolution of all peaks. If a standard radiation test site is used, raise and lower the test antenna to obtain a maximum reading at each angular increment. (Note: several batteries may be needed to offset the effect of battery voltage droop, which should not exceed 5% of the manufactured specified battery voltage during transmission).
- c) Replace the transmitter under test with a vertically polarized half-wave dipole (or an antenna whose gain is known relative to an ideal half-wave dipole). The center of the antenna should be at the same location as the center of the antenna under test.
- d) Connect the antenna to a signal generator with a known output power and record the path loss (in dB) as LOSS. If a standard radiation test site is used, raise and lower the test antenna to obtain a maximum reading. $LOSS = \text{Generator Output Power (dBm)} - \text{Analyzer reading (dBm)}$
- e) Determine the effective radiated output power at each angular position from the readings in steps b) and d) using the following equation: $ERP \text{ (dBm)} = \text{LVL (dBm)} + \text{LOSS (dB)}$
- f) The maximum ERP is the maximum value determined in the preceding step.
- g) When calculating ERP, in addition to knowing the antenna radiation and matching characteristics, it is necessary to know the loss values of all elements (e.g.transmission line attenuation, mismatches, filters, combiners) interposed between the point where transmitter output power is measured, and the point where power is applied to the antenna. ERP can then be calculated as follows:

$$ERP \text{ (dBm)} = \text{Output Power (dBm)} - \text{Losses (dB)} + \text{Antenna Gain (dBd)}$$

where: dBd refers to gain relative to an ideal dipole.

$$EIRP \text{ (dBm)} = ERP \text{ (dBm)} + 2.15 \text{ (dB.)}$$

Test setup

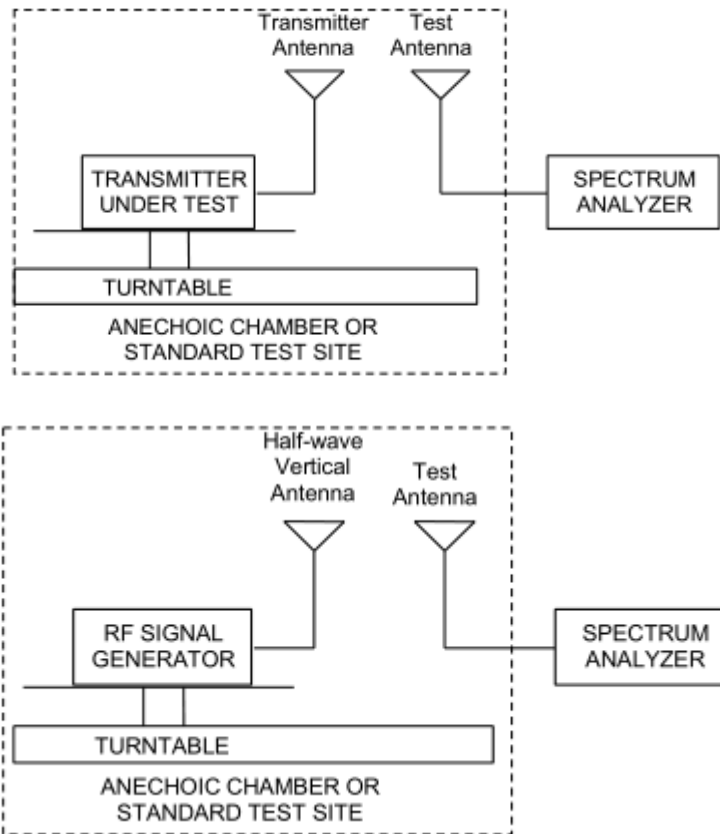

Note: Area side:2.4mX3.6m

The radiated emission was measured in the following position: EUT stand-up position (Z axis), lie-down position (X, Y axis). The worst emission was found in stand-up position (Z axis) and the worst case was recorded.

**Limits**

Rule Part 27.50(b) (10) specifies that “Portable stations (hand-held devices) transmitting in the 746-757 MHz, 776-788 MHz, and 805-806 MHz bands are limited to 3 watts ERP”

Rule Part 27.50(d) (4) specifies that “Fixed, mobile and portable (hand-held) stations operating in the 1710–1755 MHz band are limited to 1 watt EIRP”

Part 27.50(b)(10)Limit (ERP)	$\leq 3 \text{ W}$ (34.77 dBm)
Part 27.50(d)(4)Limit (EIRP)	$\leq 1 \text{ W}$ (30 dBm)

Measurement Uncertainty

The assessed measurement uncertainty to ensure 95% confidence level for the normal distribution is with the coverage factor $k = 2$, $U = 1.19 \text{ dB}$

Test Results

The measurement is performed for both of horizontal and vertical antenna Polarization, and only the data of worst mode is recorded in this report.

LTE Band 4									
Bandwidth	Channel	Frequency (MHz)	Polarization	Output Power (dBm)	Losses (dB)	Antenna Gain (dBd)	EIRP (dBm)	Limit (dBm)	Conclusion
1.4 MHz (QPSK)	Low	1710.7	Horizontal	-28.81	-54.30	1.44	26.93	30	Pass
	Mid	1732.5	Horizontal	-29.45	-54.32	1.57	26.44	30	Pass
	High	1754.3	Horizontal	-30.22	-54.10	1.72	25.60	30	Pass
3 MHz (QPSK)	Low	1711.5	Horizontal	-30.21	-54.35	1.44	25.58	30	Pass
	Mid	1732.5	Horizontal	-30.44	-54.41	1.57	25.54	30	Pass
	High	1753.5	Horizontal	-31.24	-54.48	1.72	24.96	30	Pass
5 MHz (QPSK)	Low	1712.5	Horizontal	-32.13	-54.34	1.44	23.65	30	Pass
	Mid	1732.5	Horizontal	-32.53	-54.32	1.57	23.35	30	Pass
	High	1752.5	Horizontal	-32.90	-54.13	1.72	22.94	30	Pass
10 MHz (QPSK)	Low	1715	Horizontal	-28.89	-54.32	1.44	26.87	30	Pass
	Mid	1732.5	Horizontal	-29.42	-54.41	1.57	26.56	30	Pass
	High	1750	Horizontal	-30.14	-54.52	1.66	26.04	30	Pass
15 MHz (QPSK)	Low	1717.5	Horizontal	-30.06	-54.35	1.49	25.78	30	Pass
	Mid	1732.5	Horizontal	-30.21	-54.32	1.57	25.67	30	Pass
	High	1747.5	Horizontal	-30.61	-54.17	1.66	25.22	30	Pass
20 MHz (QPSK)	Low	1720	Horizontal	-38.27	-54.44	1.49	17.66	30	Pass
	Mid	1732.5	Horizontal	-37.95	-54.41	1.57	18.02	30	Pass
	High	1745	Horizontal	-37.18	-54.59	1.63	19.04	30	Pass
1.4 MHz (16QAM)	Low	1710.7	Horizontal	-28.92	-54.30	1.44	26.82	30	Pass
	Mid	1732.5	Horizontal	-29.56	-54.32	1.57	26.33	30	Pass
	High	1754.3	Horizontal	-30.33	-54.10	1.72	25.49	30	Pass
3 MHz (16QAM)	Low	1711.5	Horizontal	-30.32	-54.35	1.44	25.47	30	Pass
	Mid	1732.5	Horizontal	-30.55	-54.41	1.57	25.43	30	Pass
	High	1753.5	Horizontal	-31.35	-54.48	1.72	24.85	30	Pass
5 MHz (16QAM)	Low	1712.5	Horizontal	-32.24	-54.34	1.44	23.54	30	Pass
	Mid	1732.5	Horizontal	-32.64	-54.32	1.57	23.24	30	Pass
	High	1752.5	Horizontal	-33.01	-54.13	1.72	22.83	30	Pass
10 MHz (16QAM)	Low	1715	Horizontal	-29.00	-54.32	1.44	26.76	30	Pass
	Mid	1732.5	Horizontal	-29.53	-54.41	1.57	26.45	30	Pass
	High	1750	Horizontal	-30.25	-54.52	1.66	25.93	30	Pass
15 MHz (16QAM)	Low	1717.5	Horizontal	-30.17	-54.35	1.49	25.66	30	Pass
	Mid	1732.5	Horizontal	-30.32	-54.32	1.57	25.56	30	Pass
	High	1747.5	Horizontal	-30.72	-54.17	1.66	25.11	30	Pass
20 MHz (16QAM)	Low	1720	Horizontal	-38.38	-54.44	1.49	17.54	30	Pass
	Mid	1732.5	Horizontal	-38.06	-54.41	1.57	17.91	30	Pass
	High	1745	Horizontal	-37.30	-54.59	1.63	18.93	30	Pass



LTE Band 13									
Bandwidth	Channel	Frequency (MHz)	Polarization	Output Power (dBm)	Losses (dB)	Antenna Gain (dBd)	ERP (dBm)	Limit (dBm)	Conclusion
5MHz (QPSK)	Low	779.5	Horizontal	-25.73	-47.01	1.81	23.09	34.77	Pass
	Mid	782	Horizontal	-25.96	-47.17	1.81	23.02	34.77	Pass
	High	784.5	Horizontal	-26.05	-47.59	1.83	23.37	34.77	Pass
10MHz (QPSK)	Mid	782	Horizontal	-24.67	-46.58	1.81	23.73	34.77	Pass
5MHz (16QAM)	Low	779.5	Horizontal	-25.84	-47.01	1.81	22.98	34.77	Pass
	Mid	782	Horizontal	-26.07	-47.17	1.81	22.90	34.77	Pass
	High	784.5	Horizontal	-26.16	-47.59	1.83	23.26	34.77	Pass
10MHz (16QAM)	Mid	782	Horizontal	-24.78	-46.58	1.81	23.62	34.77	Pass

Note: 1. EIRP= E.R.P+2.15

5.3 Occupied Bandwidth

Ambient condition

Temperature	Relative humidity	Pressure
23°C ~25°C	45%~50%	101.5kPa

Method of Measurement

The EUT was connected to Spectrum Analyzer and Base Station Simulator via power Splitter. The occupied bandwidth is measured using spectrum analyzer.

RBW is set to 51 kHz, VBW is set to 160 kHz for LTE Band 4 (1.4MHz).

RBW is set to 100 kHz, VBW is set to 300 kHz for LTE Band 4/13 (3MHz/5MHz).

RBW is set to 300 kHz, VBW is set to 1MHz for LTE Band 4/13 (10MHz).

RBW is set to 300 kHz, VBW is set to 1MHz for LTE Band 4 (15MHz/20MHz).

99% power and -26dBc occupied bandwidths are recorded. Spectrum analyzer plots are included on the following pages.

Test Setup

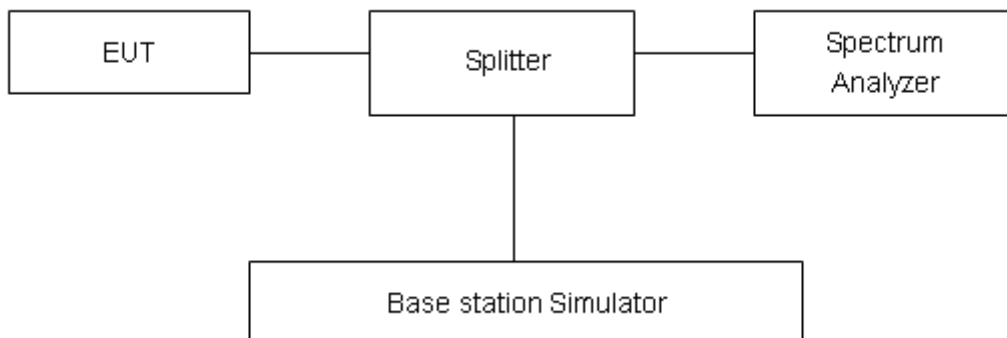

Limits

No specific occupied bandwidth requirements in part 2.1049.

Measurement Uncertainty

The assessed measurement uncertainty to ensure 95% confidence level for the normal distribution is with the coverage factor $k = 2$, $U=624\text{Hz}$.

Test Result

LTE Band 4						
RB	Modulation	Bandwidth (MHz)	Channel	Frequency (MHz)	99% Power Bandwidth(MHz)	-26dBc Bandwidth(MHz)
100%	QPSK	1.4	19957	1710.7	1.129	1.369
			20175	1732.5	1.126	1.352
			20393	1754.3	1.130	1.372
		3	19965	1711.5	2.745	3.071
			20175	1732.5	2.749	3.070
			20385	1753.5	2.740	3.077
		5	19975	1712.5	4.513	5.053
			20175	1732.5	4.528	5.032
			20375	1752.5	4.531	5.031
		10	20000	1715	9.018	10.100
			20175	1732.5	9.021	10.120
			20350	1750	9.048	10.170
		15	20025	1717.5	13.433	14.710
			20175	1732.5	13.436	14.800
			20325	1747.5	13.471	14.830
	20	20050	1720	17.868	19.260	
		20175	1732.5	17.828	19.120	
		20300	1745	17.946	19.590	
	16QAM	1.4	19957	1710.7	1.124	1.330
			20175	1732.5	1.130	1.349
			20393	1754.3	1.126	1.326
		3	19965	1711.5	2.741	3.080
			20175	1732.5	2.736	3.059
			20385	1753.5	2.761	3.072
		5	19975	1712.5	4.536	5.045
			20175	1732.5	4.509	5.015
			20375	1752.5	4.514	5.019
		10	20000	1715	9.029	10.070
			20175	1732.5	9.037	10.030
			20350	1750	9.048	10.010
15		20025	1717.5	13.469	14.740	
		20175	1732.5	13.437	14.690	
		20325	1747.5	13.493	14.800	
20	20050	1720	17.905	19.410		
	20175	1732.5	17.863	19.270		
	20300	1745	17.919	19.410		

LTE Band 13						
RB	Modulation	Bandwidth (MHz)	Channel	Frequency (MHz)	99% Power Bandwidth(MHz)	-26dBc Bandwidth(MHz)
100%	QPSK	5	23205	779.5	4.510	5.031
			23230	782	4.530	5.058
			23255	784.5	4.522	5.022
		10	23230	782	9.075	10.130
	16QAM	5	23205	779.5	4.532	5.034
			23230	782	4.521	5.001
			23255	784.5	4.548	5.088
		10	23230	782	9.072	10.090

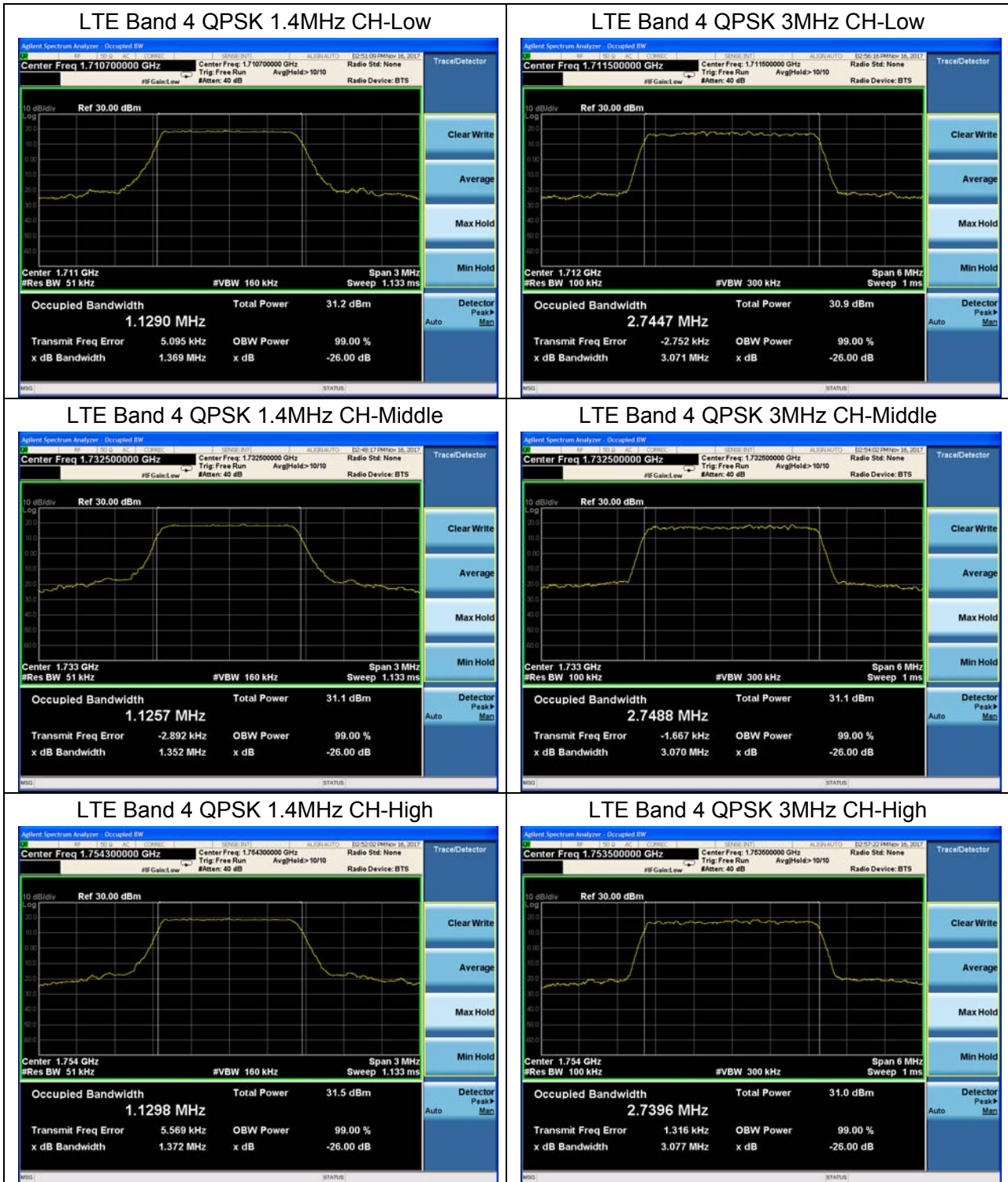

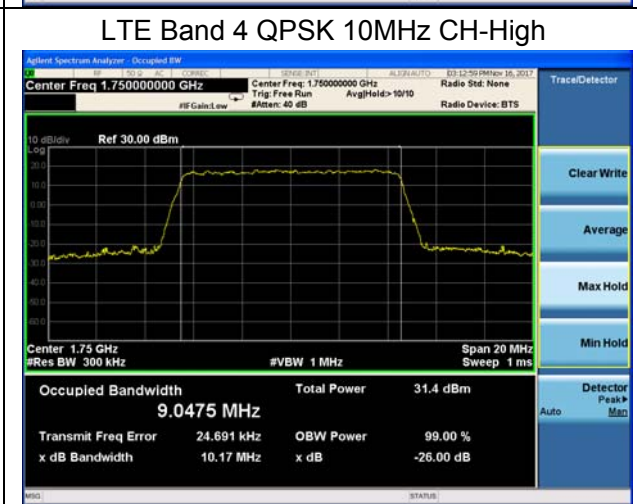
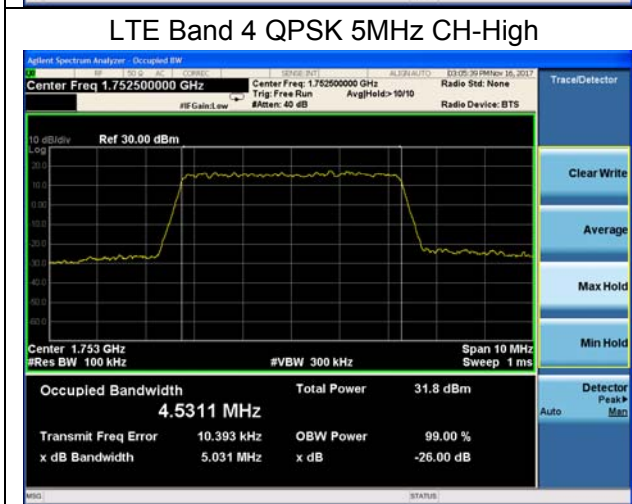
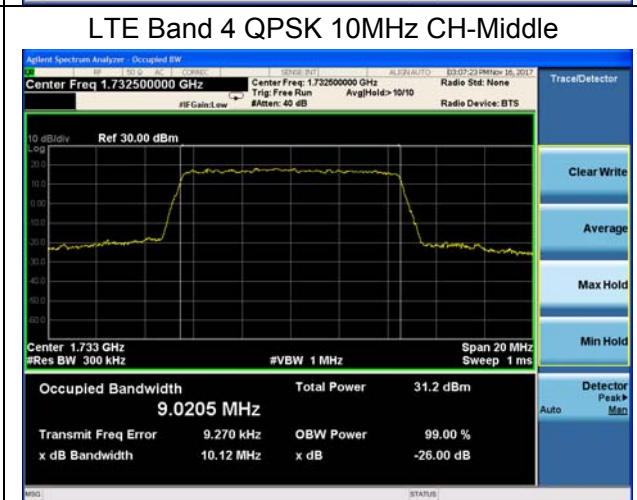
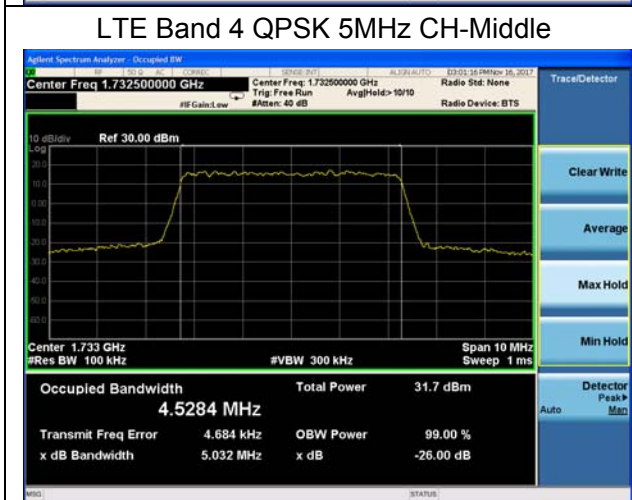
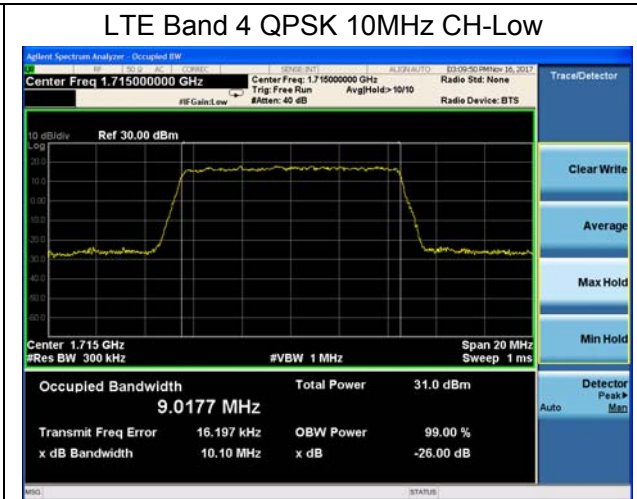
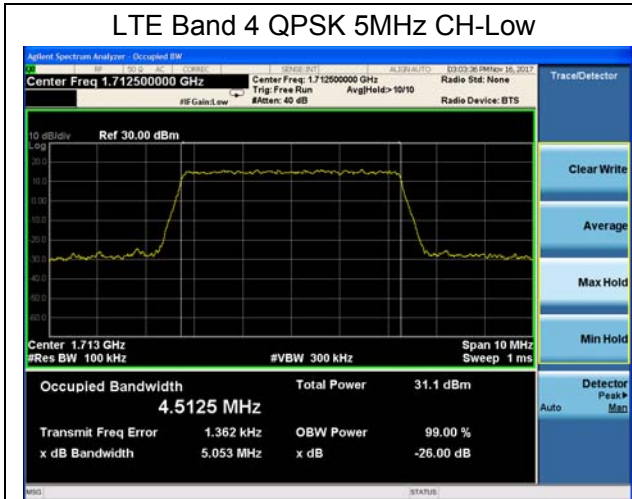

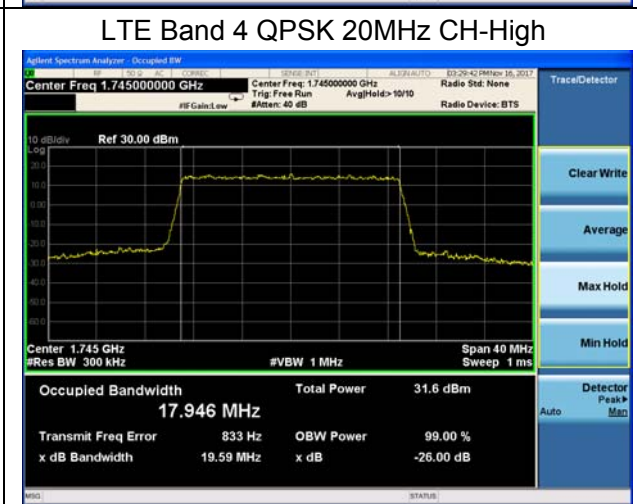
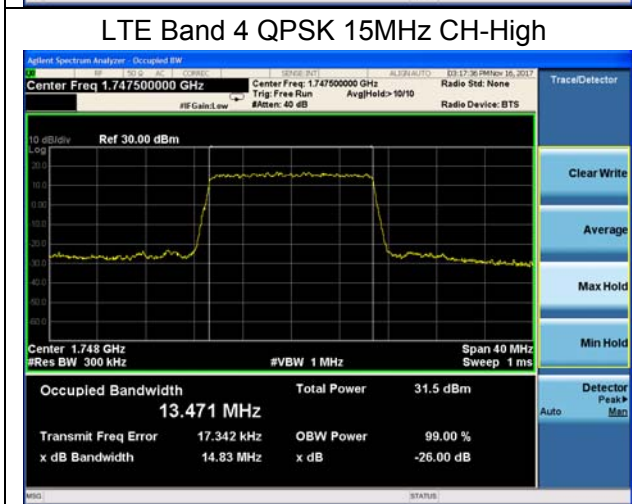
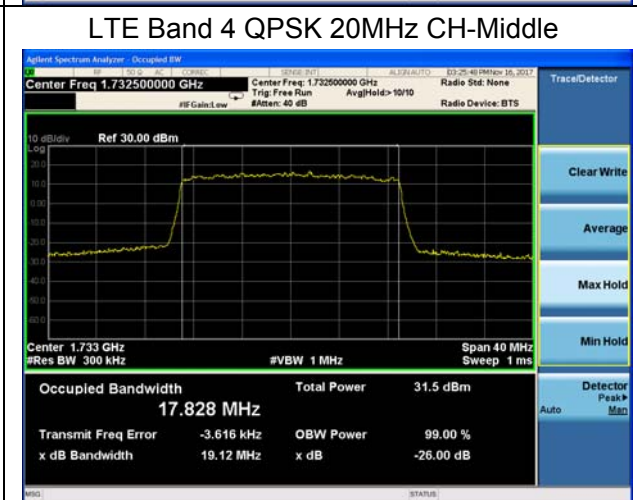
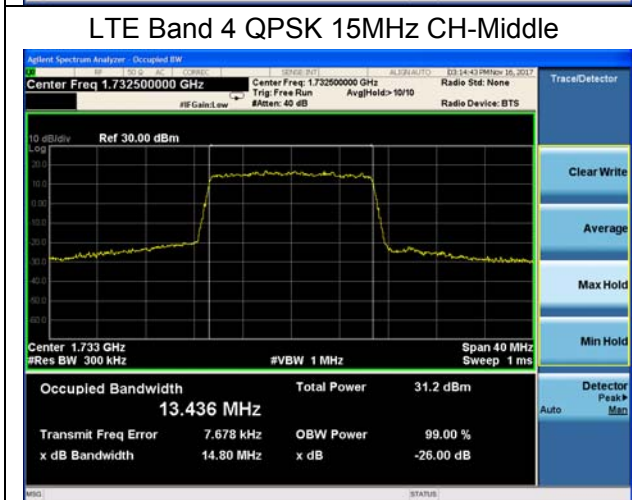
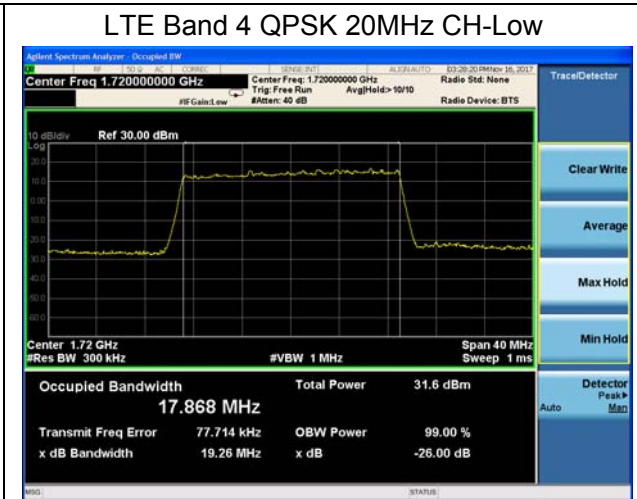
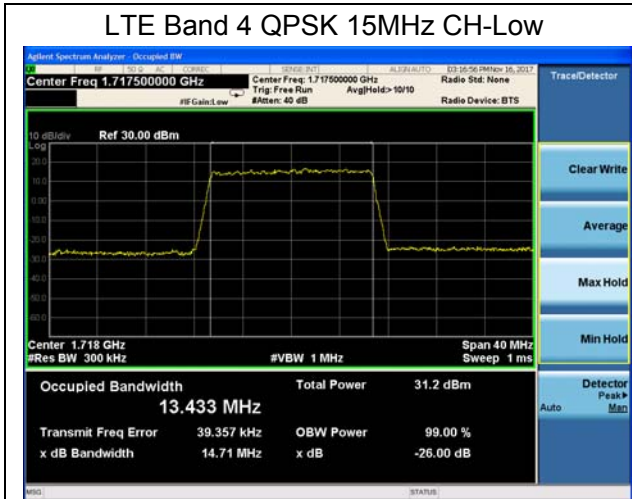

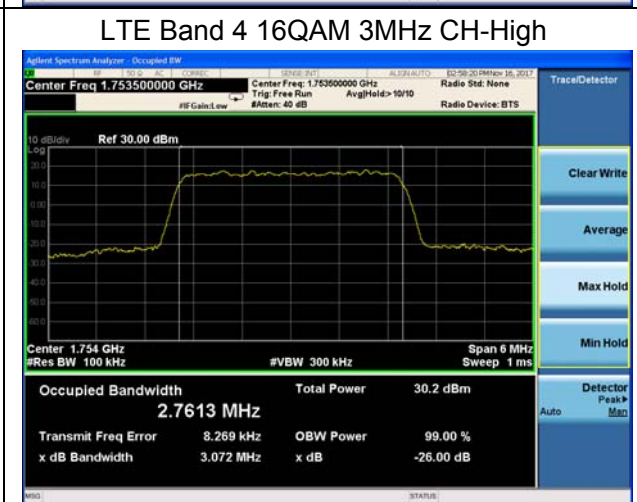
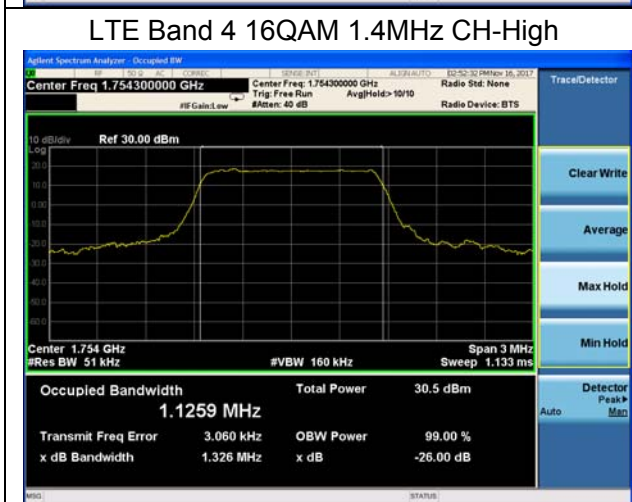
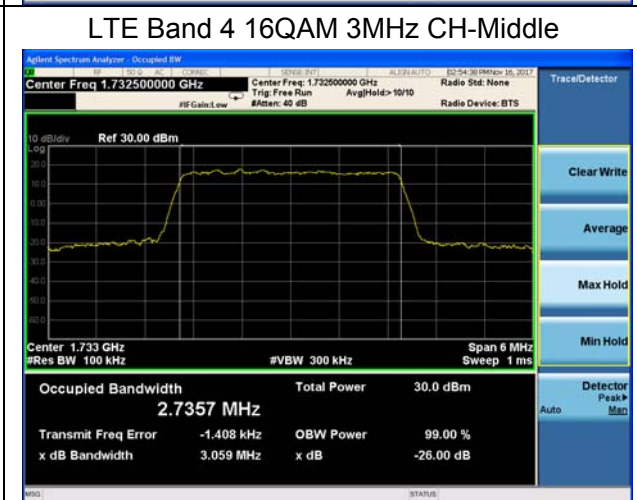
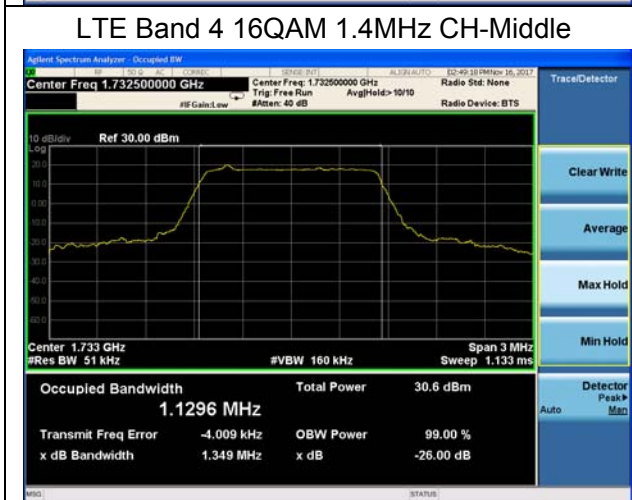
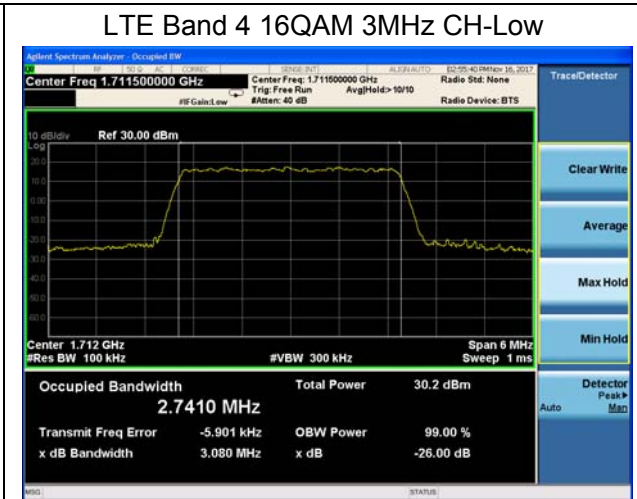
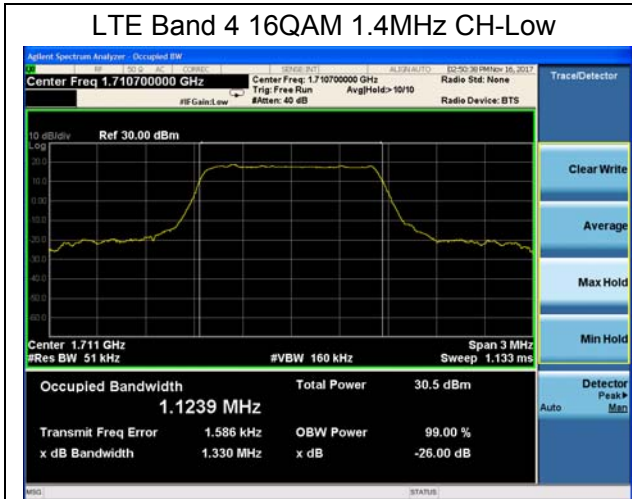

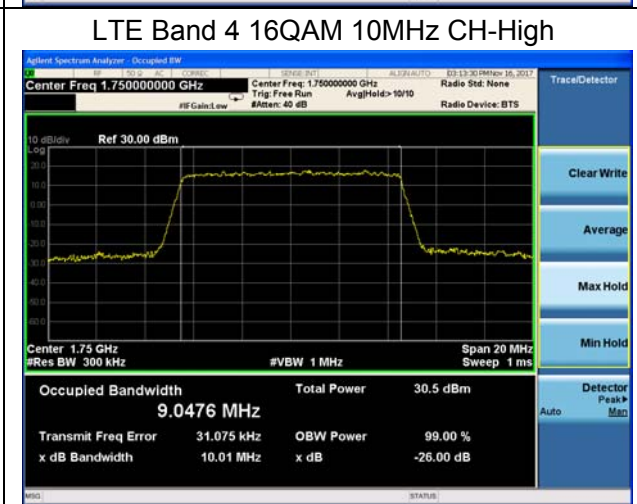
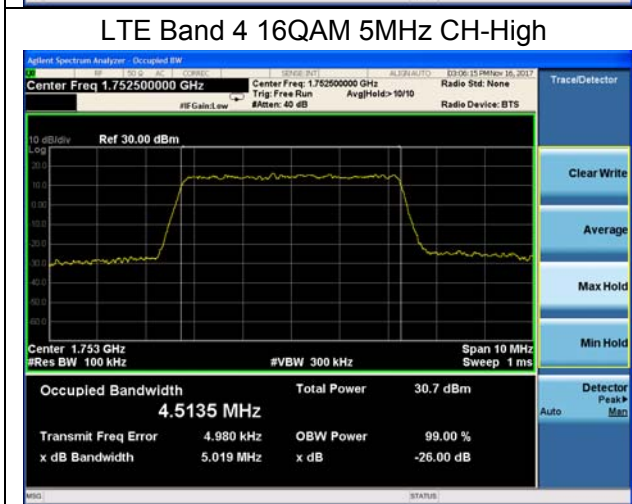
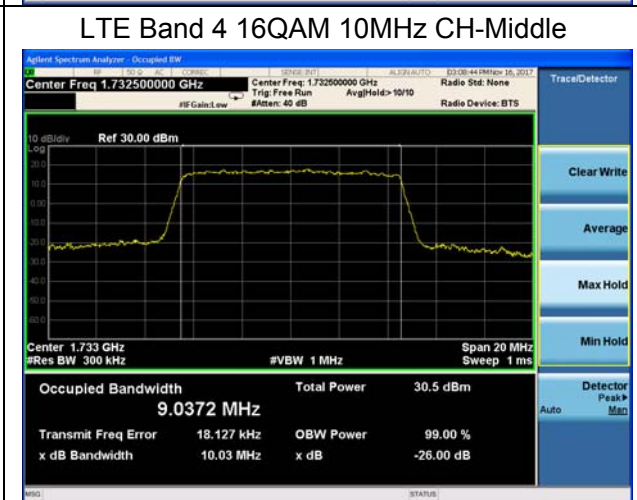
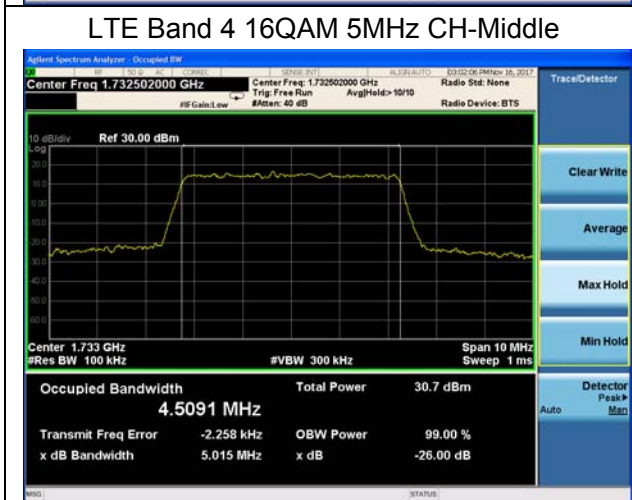
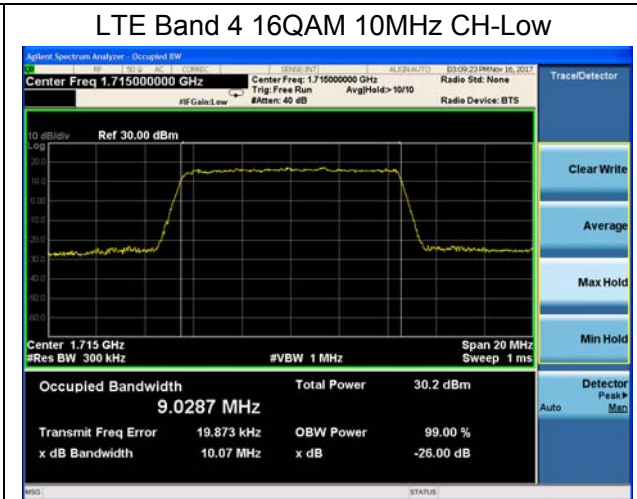
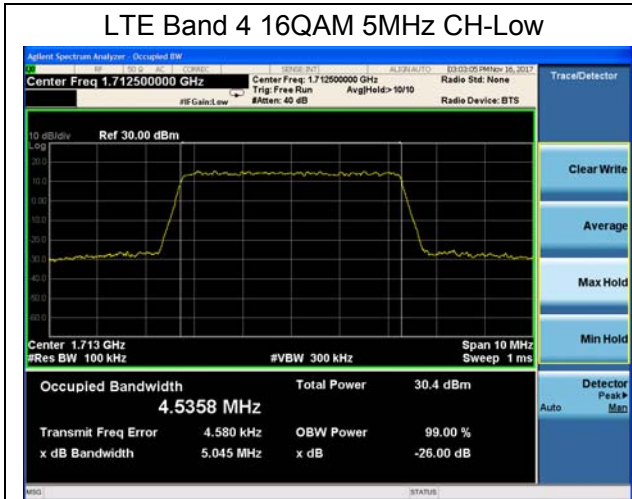

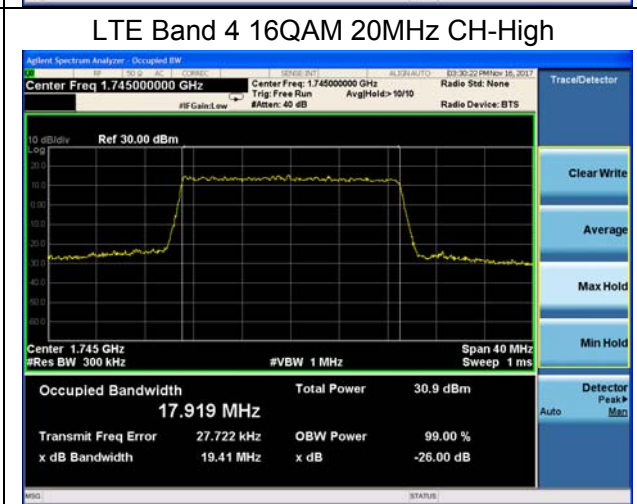
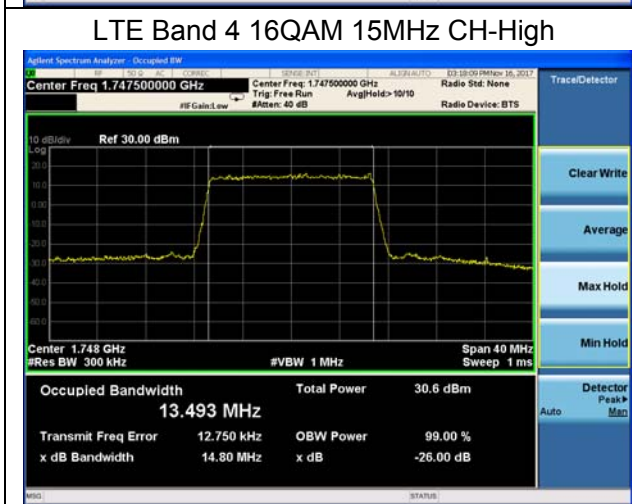
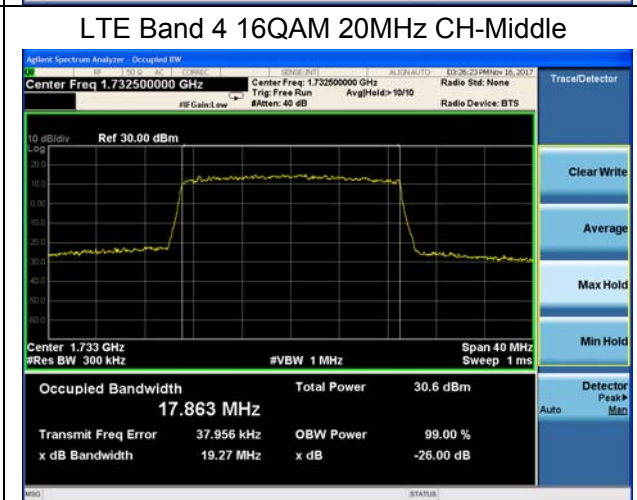
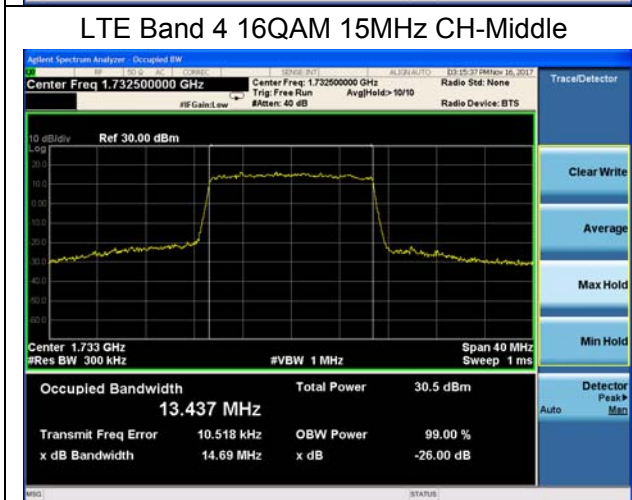
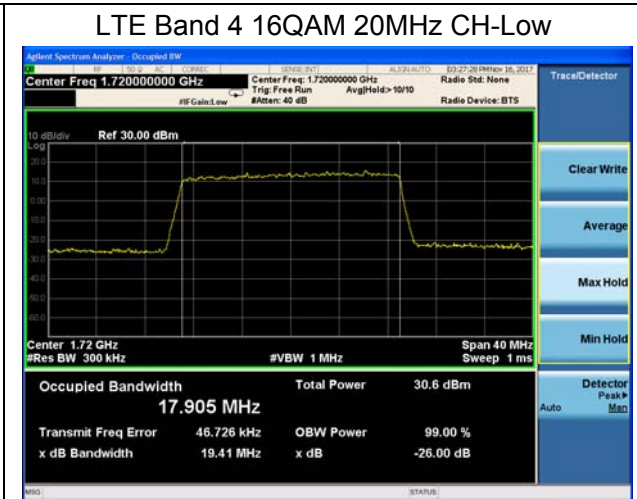
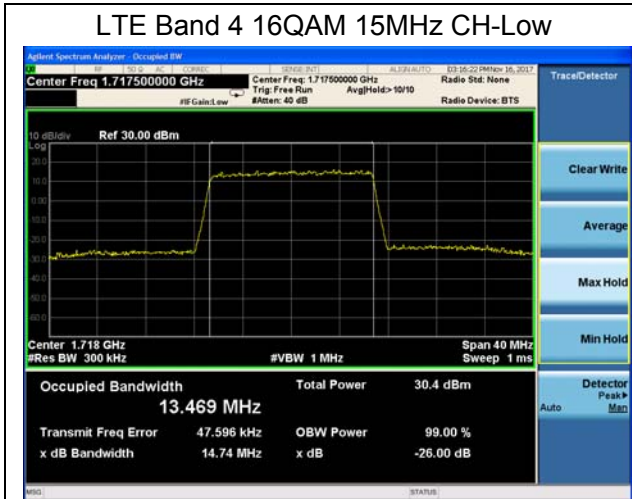

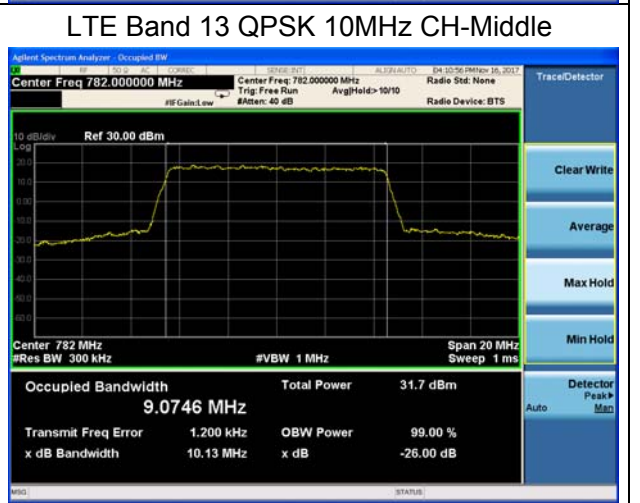
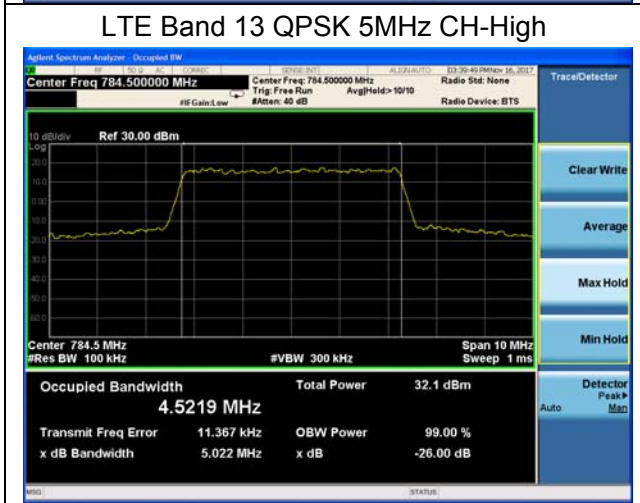
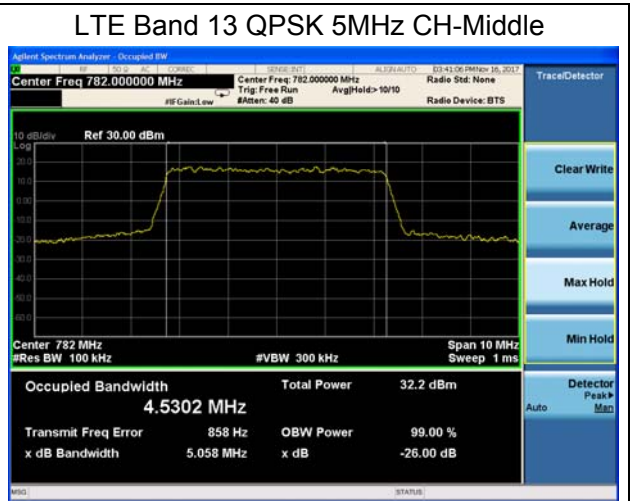
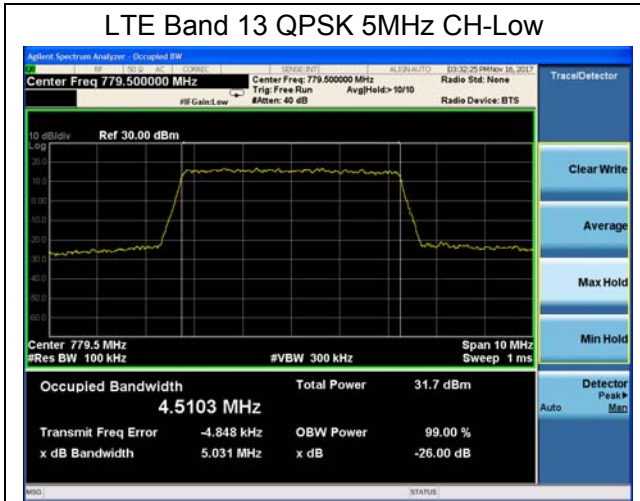

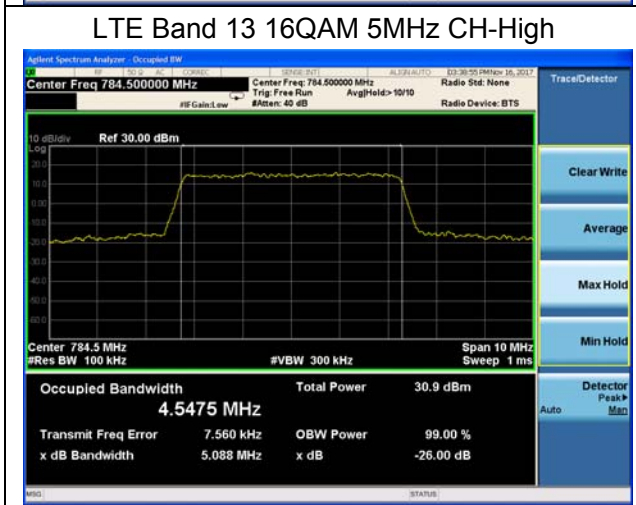
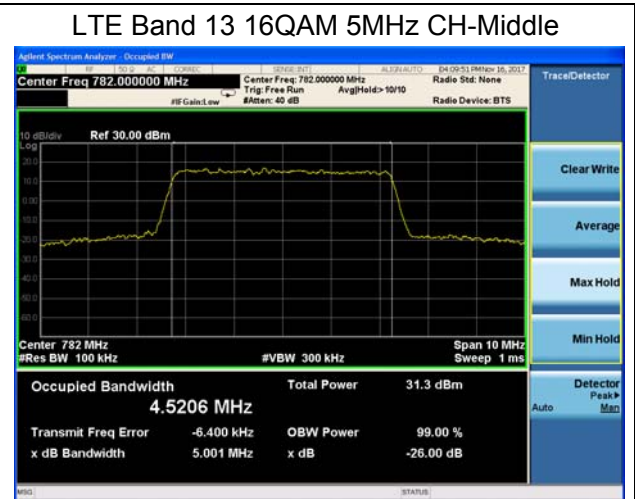
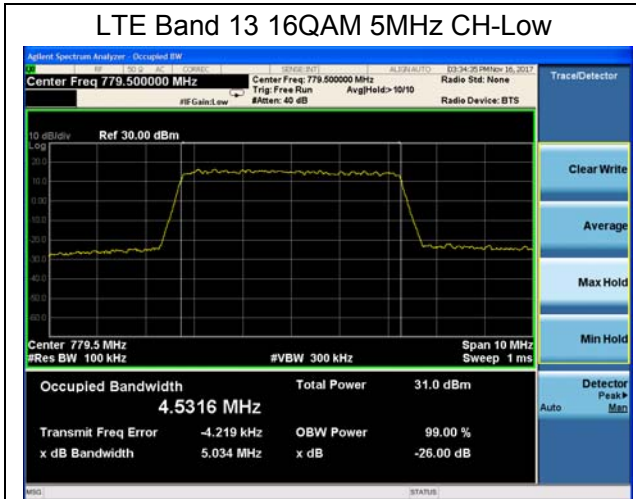

5.4 Band Edge Compliance

Ambient condition

Temperature	Relative humidity	Pressure
23°C ~25°C	45%~50%	101.5kPa

Method of Measurement

The EUT was connected to Spectrum Analyzer and Base Station Simulator via power Splitter. The band edge of the lowest and highest channels were measured.

The testing follows KDB 971168 v03 Section 6.0

- 1.The EUT was connected to spectrum analyzer and system simulator via a power divider.
2. The band edges of low and high channels for the highest RF powers were measured.
 RBW is set to 15 kHz, VBW is set to 51 kHz for LTE Band 4(1.4MHz).
 RBW is set to 30 kHz, VBW is set to 100 kHz for LTE Band 4 (3MHz).
 RBW is set to 51 kHz, VBW is set to 160 kHz for LTE Band 4 (5MHz).
 RBW is set to 100 kHz, VBW is set to 300kHz for LTE Band 4 (10MHz).
 RBW is set to 150 kHz, VBW is set to 510 kHz for LTE Band 4 (15MHz).
 RBW is set to 200 kHz, VBW is set to 620 kHz for LTE Band 4 (20MHz)
3. RBW is set to 10 kHz, VBW is set to 30 kHz for LTE Band 13 (763MHz~775MHz).
 RBW is set to 100 kHz, VBW is set to 300 kHz for LTE Band 13 (775MHz~777MHz).
 RBW is set to 100 kHz, VBW is set to 300 kHz for LTE Band 13 (787MHz~793MHz).
 RBW is set 10 kHz, VBW is set to 30 kHz for LTE Band 13 (793MHz~805MHz) on spectrum analyzer.
4. Set spectrum analyzer with RMS detector.
5. The RF fundamental frequency should be excluded against the limit line in the operating frequency band.
6. Checked that all the results comply with the emission limit line.

Test Setup

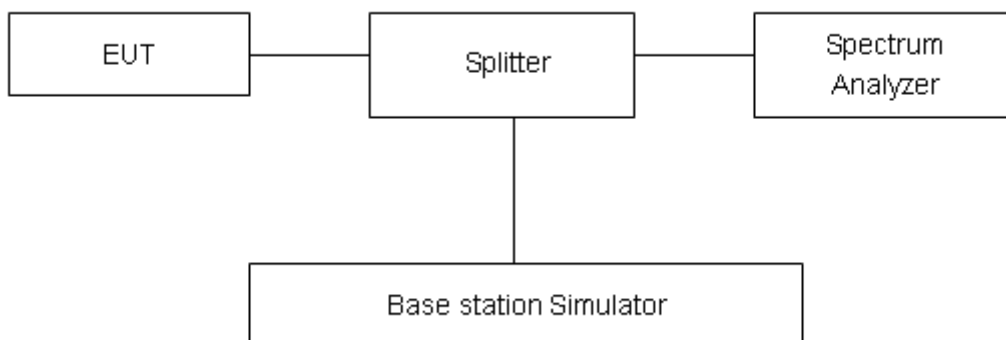

Limits

Rule Part 27.53(h) specifies that “ for operations in the 1695-1710 MHz, 1710-1755 MHz, 1755-1780 MHz, 1915-1920 MHz, 1995-2000 MHz, 2000-2020 MHz, 2110-2155 MHz, 2155-2180 MHz, and 2180-2200 bands, the power of any emission outside a licensee's frequency block shall be attenuated below the transmitter power (P) in watts by at least $43 + 10 \log_{10} (P)$ dB”

Part 27.53(g) specifies that “ For operations in the 600 MHz band and the 698-746 MHz band, the power of any emission outside a licensee's frequency block shall be attenuated below the transmitter power (P) within the licensed band(s) of operation, measured in watts, by at least $43 + 10 \log_{10} (P)$ dB.”

Part 27.53 (c) For operations in the 746-758 MHz band and the 776-788 MHz band, the power of any emission outside the licensee's frequency band(s) of operation shall be attenuated below the transmitter power (P) within the licensed band(s) of operation, measured in watts, in accordance with the following:

- (1) On any frequency outside the 746-758 MHz band, the power of any emission shall be attenuated outside the band below the transmitter power (P) by at least $43 + 10 \log (P)$ dB;
- (2) On any frequency outside the 776-788 MHz band, the power of any emission shall be attenuated outside the band below the transmitter power (P) by at least $43 + 10 \log (P)$ dB;
- (3) On all frequencies between 763-775 MHz and 793-805 MHz, by a factor not less than $76 + 10 \log (P)$ dB in a 6.25 kHz band segment, for base and fixed stations;
- (4) On all frequencies between 763-775 MHz and 793-805 MHz, by a factor not less than $65 + 10 \log (P)$ dB in a 6.25 kHz band segment, for mobile and portable stations;
- (5) Compliance with the provisions of paragraphs (c)(1) and (c)(2) of this section is based on the use of measurement instrumentation employing a resolution bandwidth of 100 kHz or greater. However, in the 100 kHz bands immediately outside and adjacent to the frequency block, a resolution bandwidth of at least 30 kHz may be employed;
- (6) Compliance with the provisions of paragraphs (c)(3) and (c)(4) of this section is based on the use of measurement instrumentation such that the reading taken with any resolution bandwidth setting should be adjusted to indicate spectral energy in a 6.25 kHz segment.

Measurement Uncertainty

The assessed measurement uncertainty to ensure 95% confidence level for the normal distribution is with the coverage factor $k = 1.96$, $U=0.684$ dB.

Test Result

All the test traces in the plots shows the test results clearly.

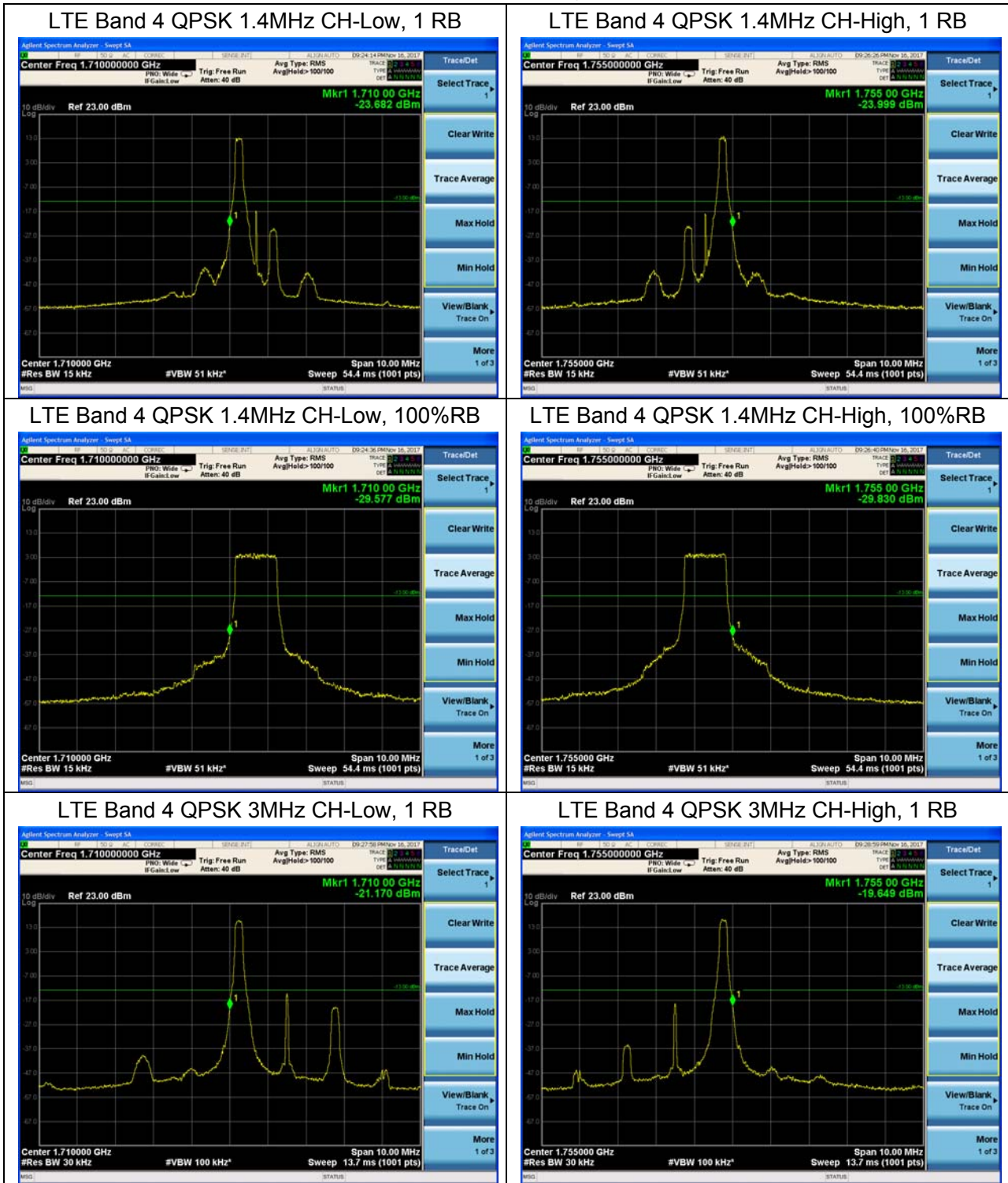



LTE Band 4 QPSK 3MHz CH-Low, 100%RB



LTE Band 4 QPSK 3MHz CH-High, 100%RB



LTE Band 4 QPSK 5MHz CH-Low, 1 RB

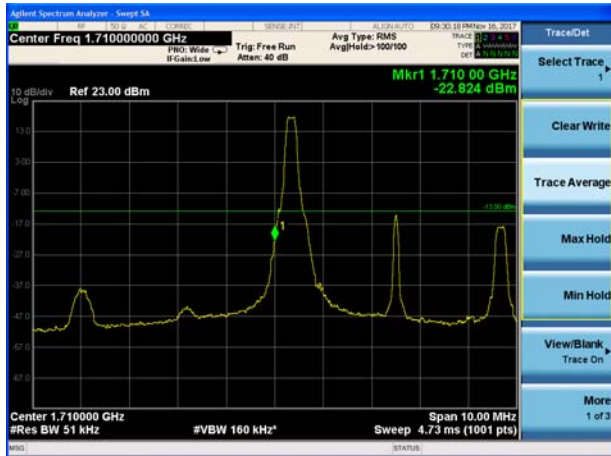

LTE Band 4 QPSK 5MHz CH-High, 1 RB

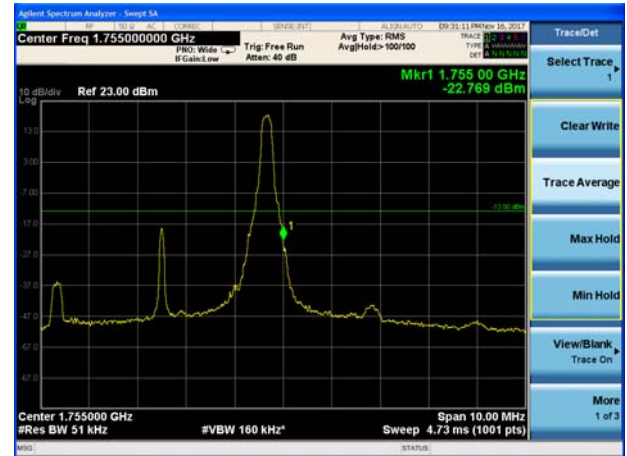

LTE Band 4 QPSK 5MHz CH-Low, 100%RB

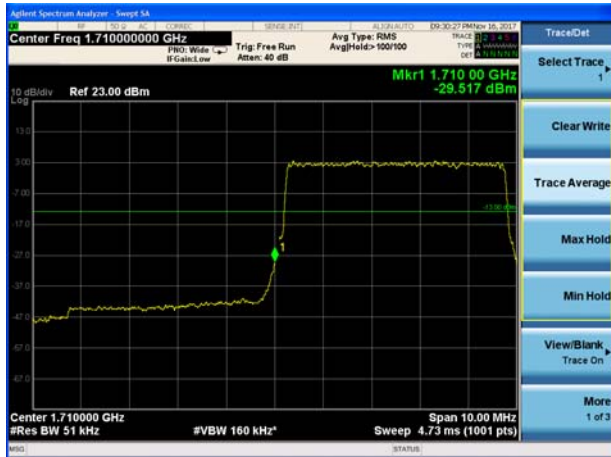

LTE Band 4 QPSK 5MHz CH-High, 100%RB

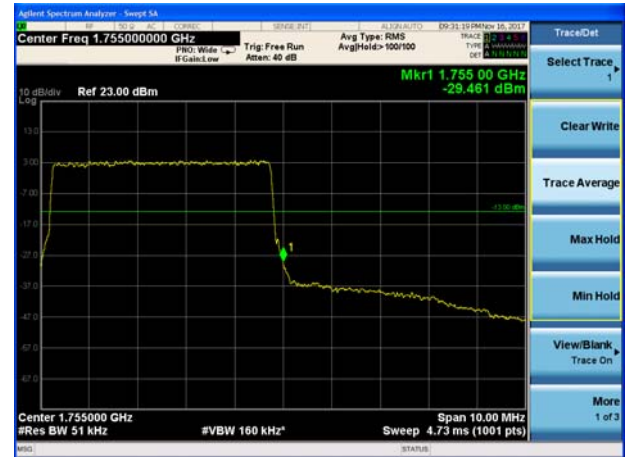



LTE Band 4 QPSK 10MHz CH-Low, 1 RB

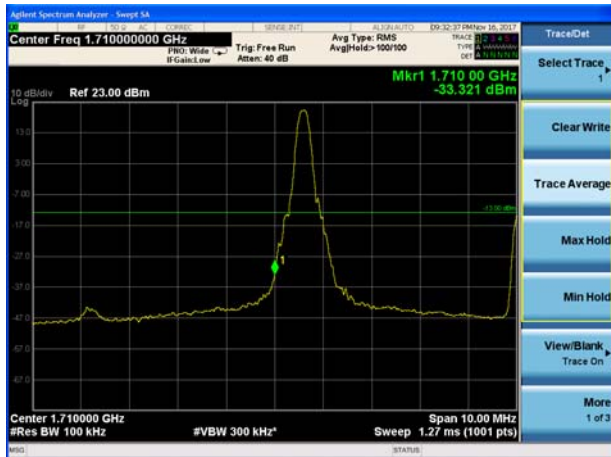

LTE Band 4 QPSK 10MHz CH-High, 1 RB

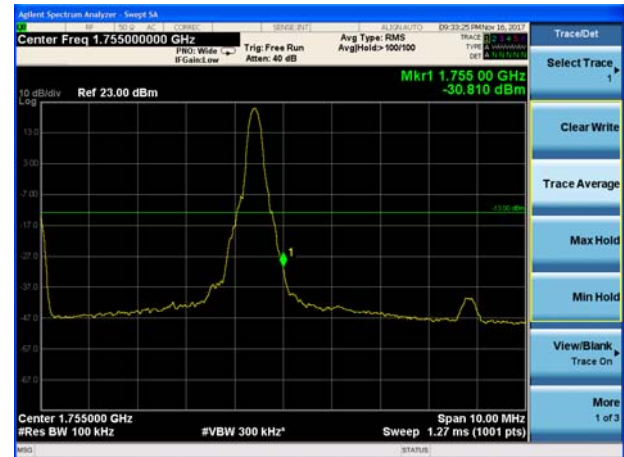

LTE Band 4 QPSK 10MHz CH-Low, 100%RB

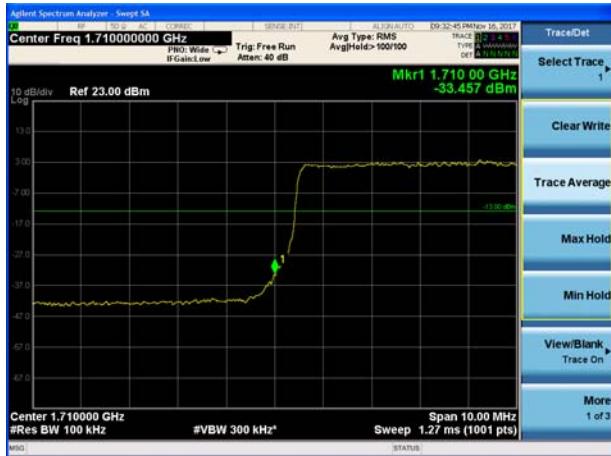

LTE Band 4 QPSK 10MHz CH-High, 100%RB



LTE Band 4 QPSK 15MHz CH-Low, 1 RB

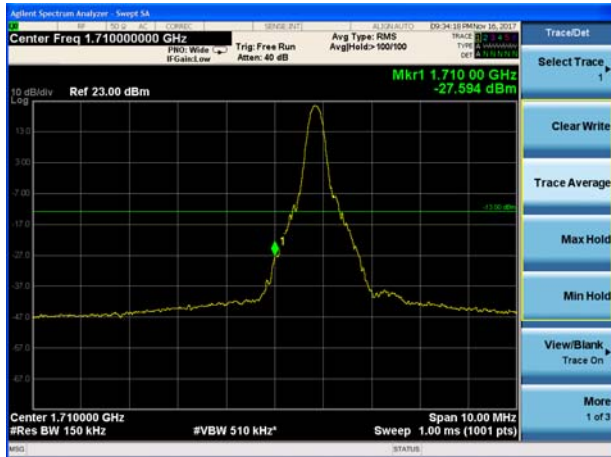

LTE Band 4 QPSK 15MHz CH-High, 1 RB

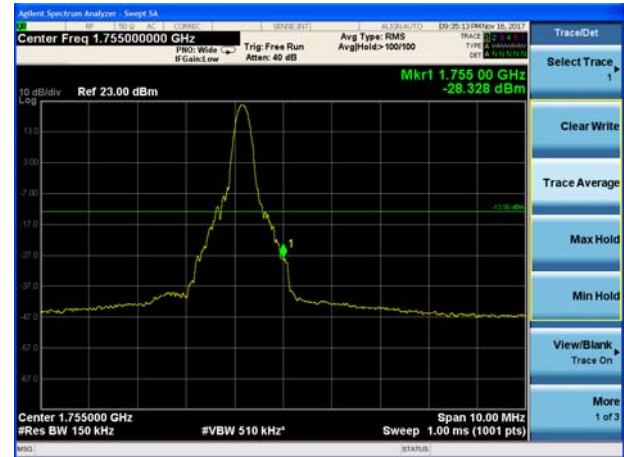

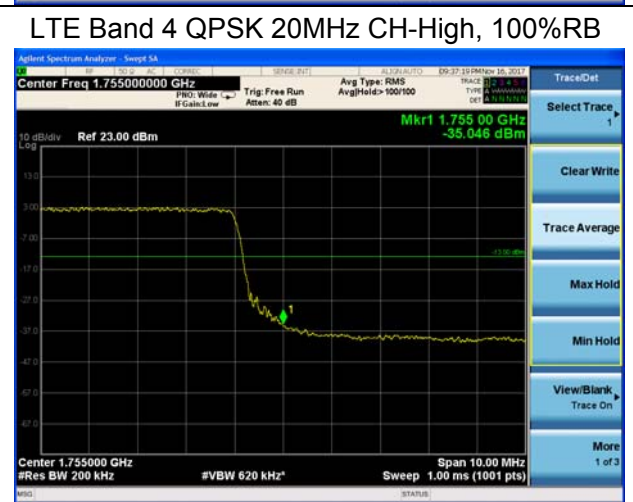
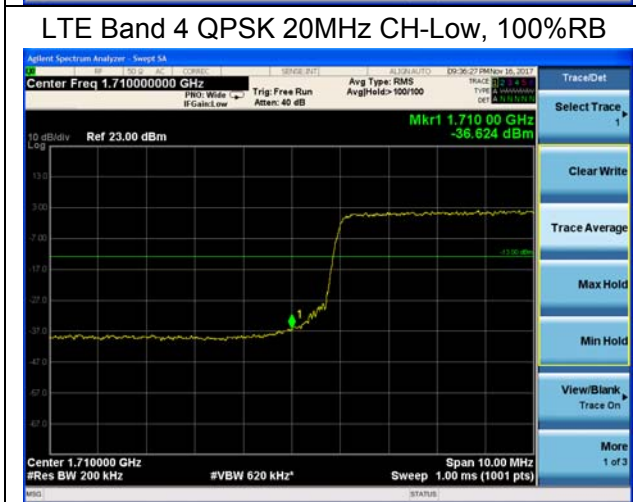
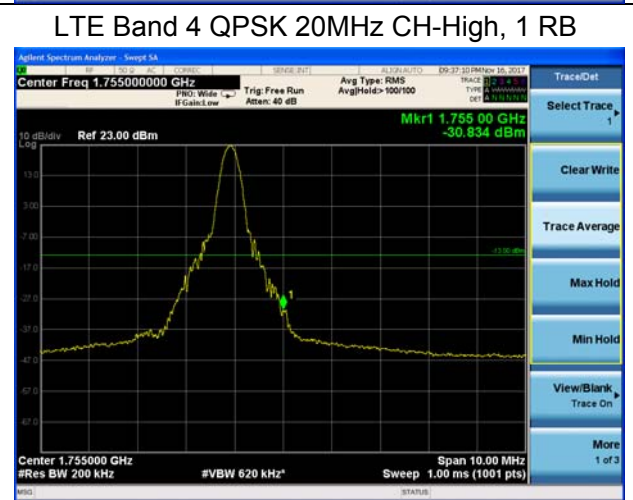
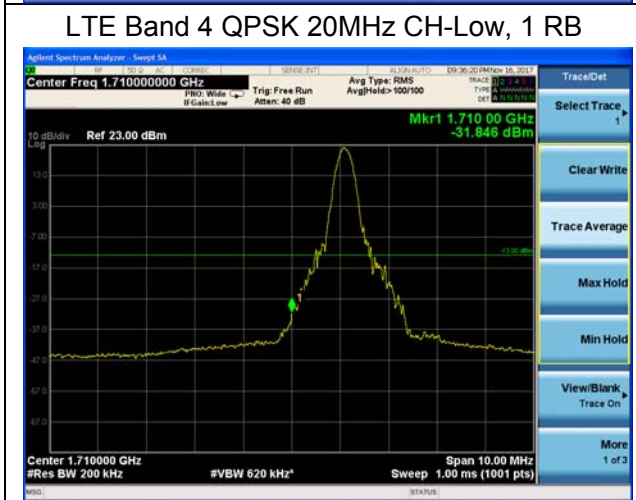
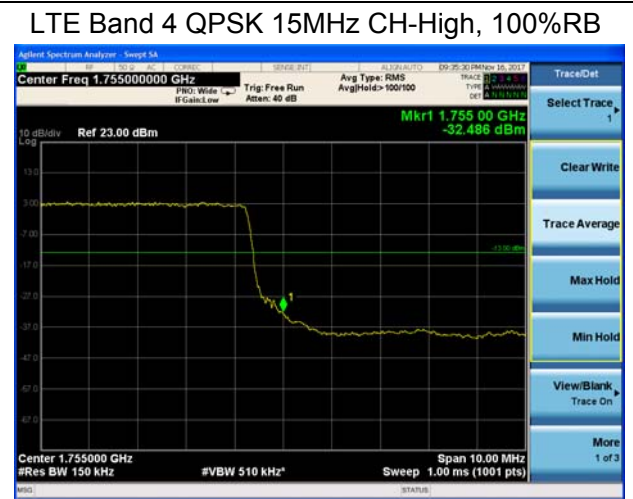
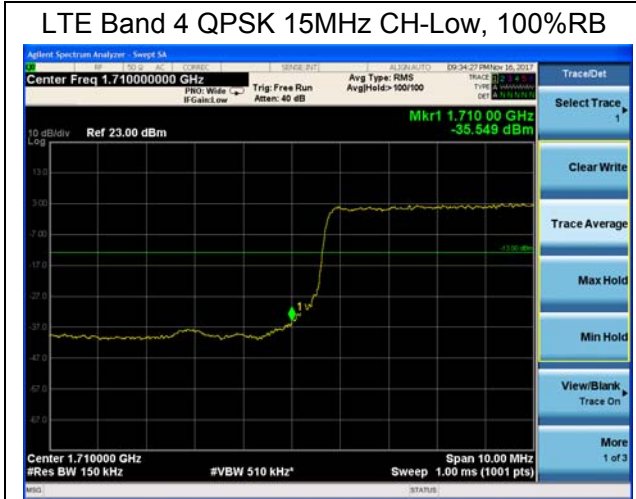

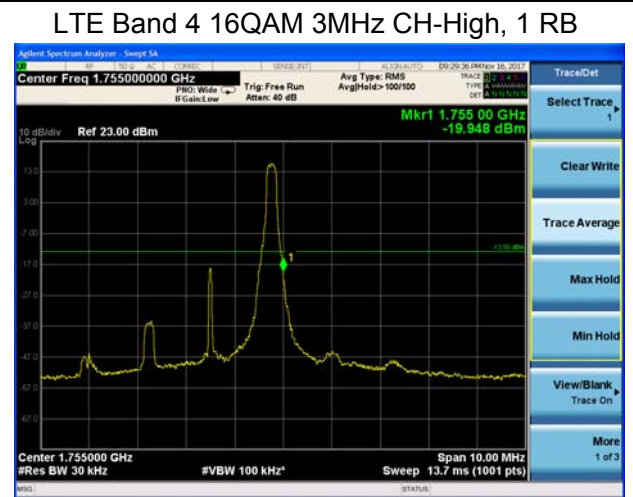
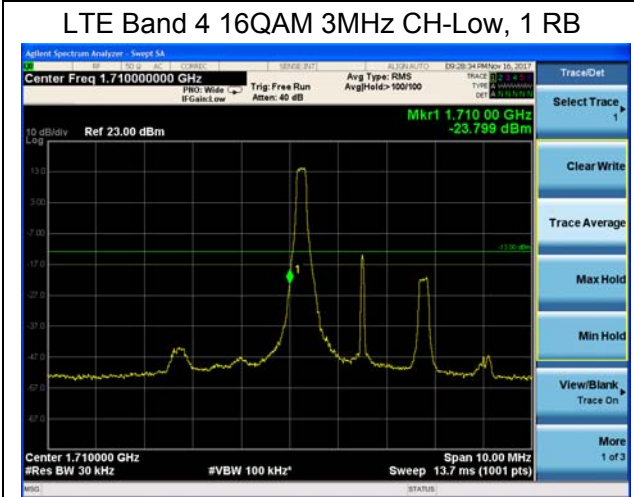
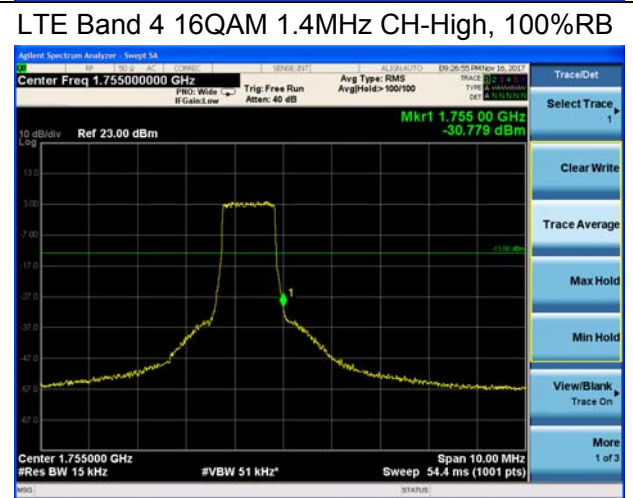
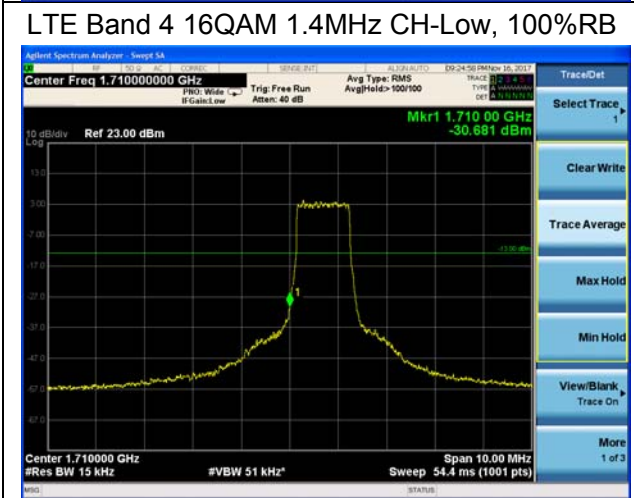
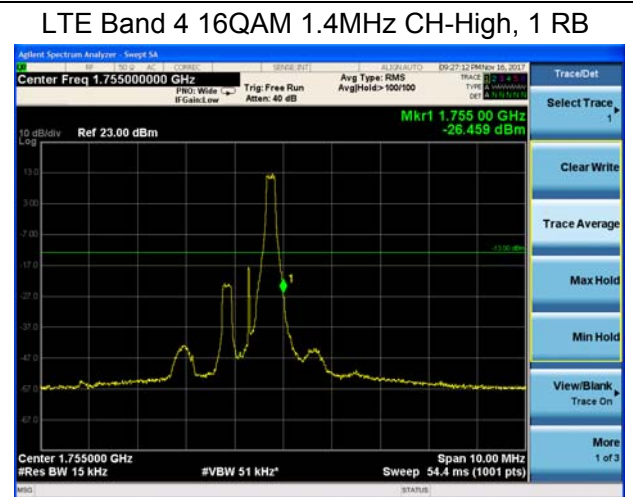
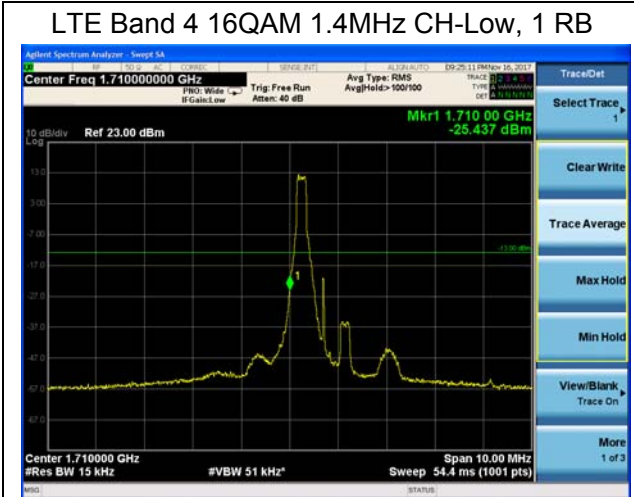



LTE Band 4 16QAM 3MHz CH-Low, 100%RB

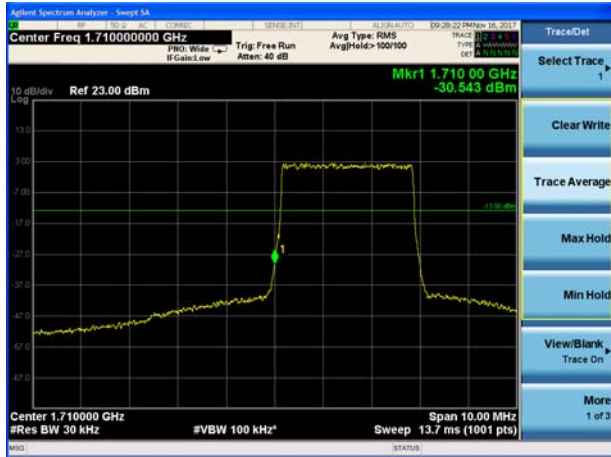

LTE Band 4 16QAM 3MHz CH-High, 100%RB



LTE Band 4 16QAM 5MHz CH-Low, 1 RB

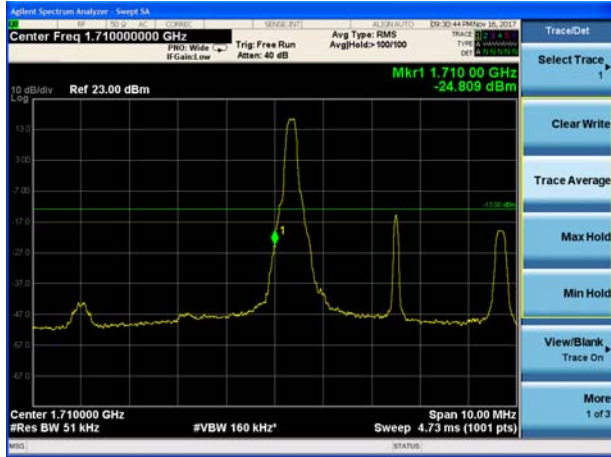

LTE Band 4 16QAM 5MHz CH-High, 1 RB

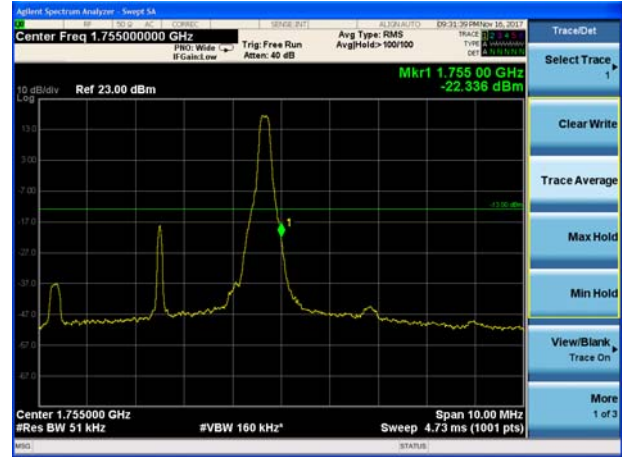

LTE Band 4 16QAM 5MHz CH-Low, 100%RB

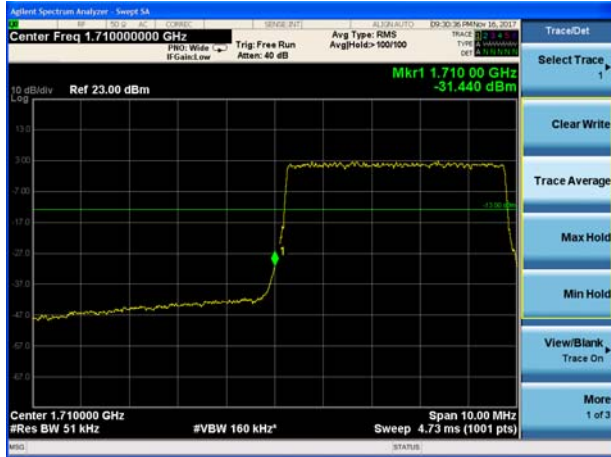

LTE Band 4 16QAM 5MHz CH-High, 100%RB



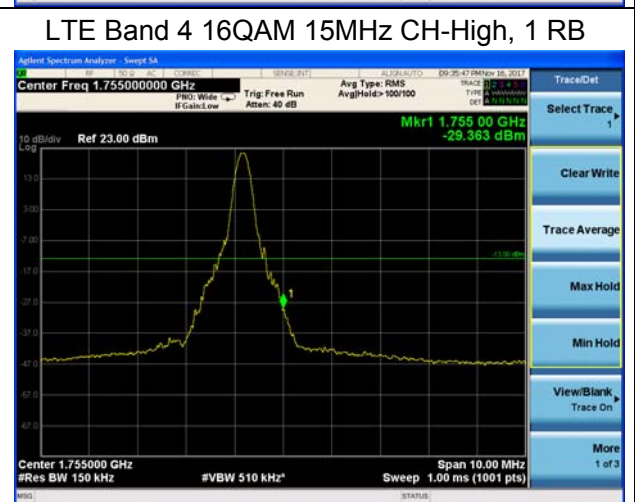
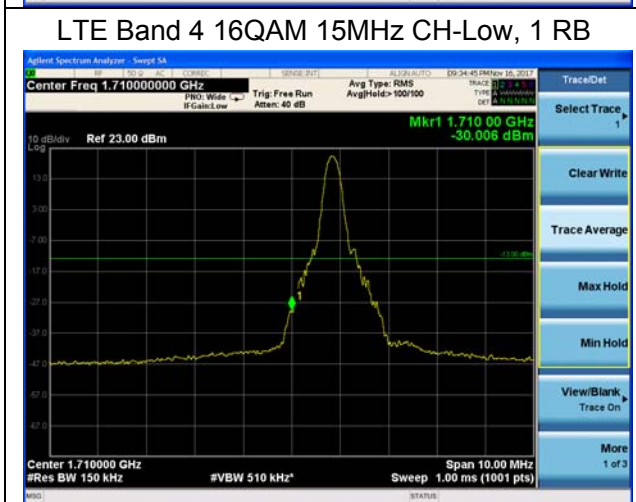
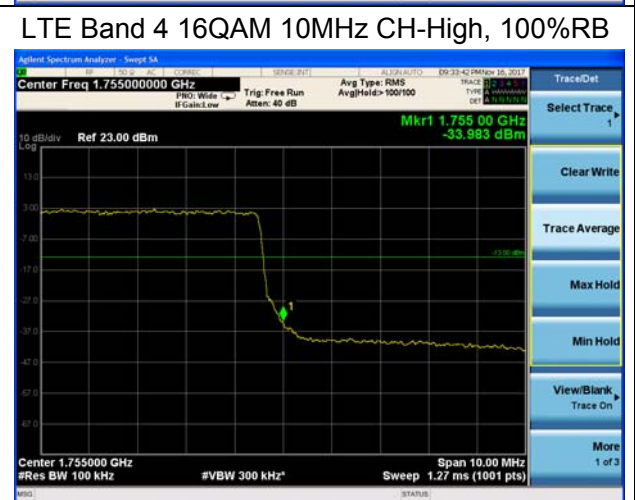
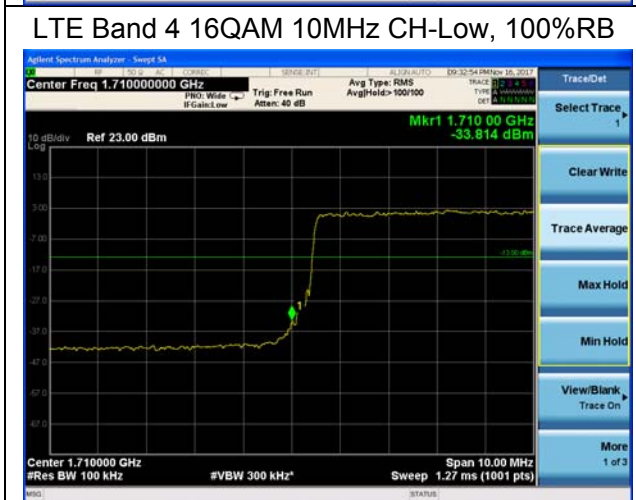
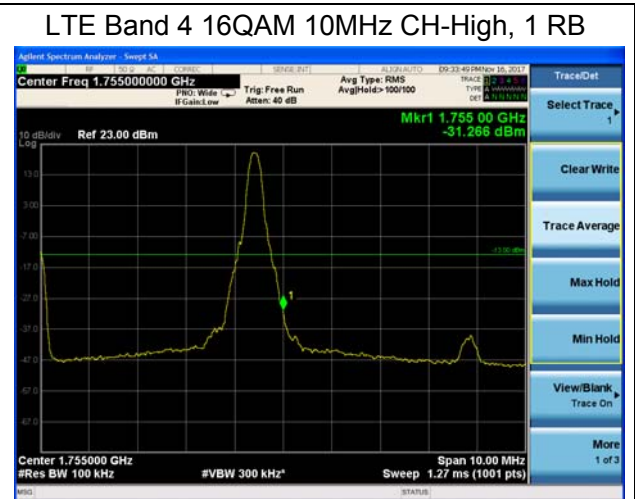
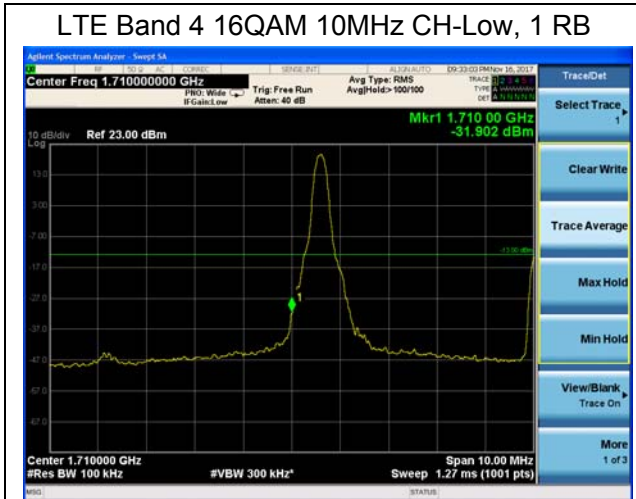

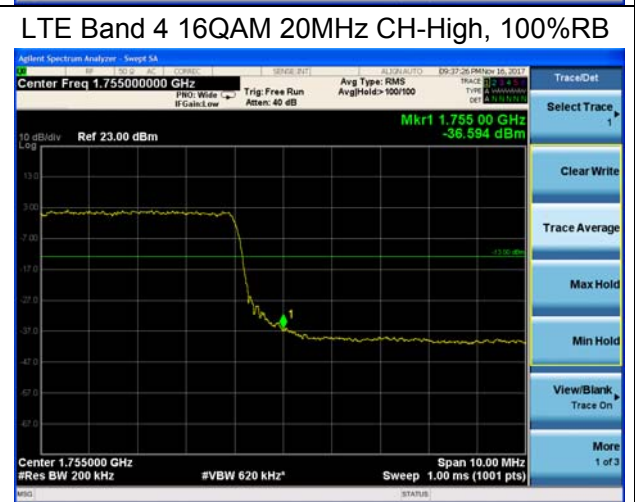
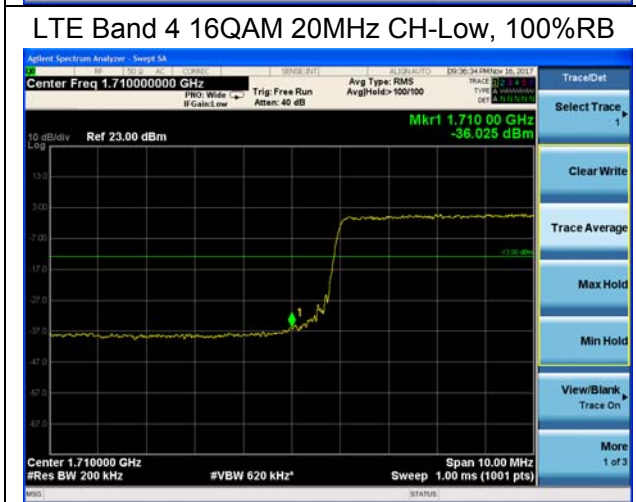
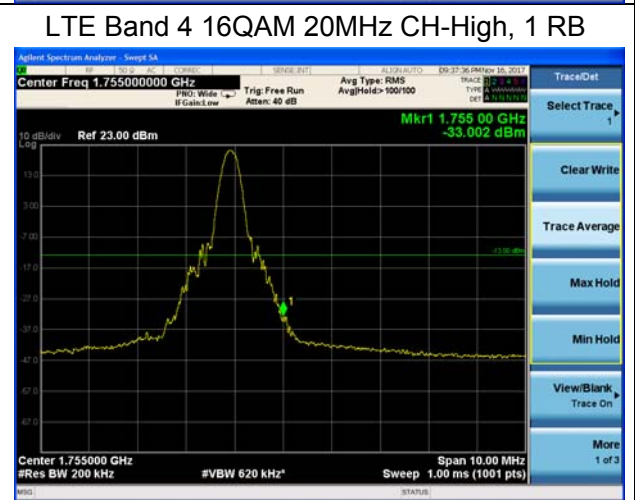
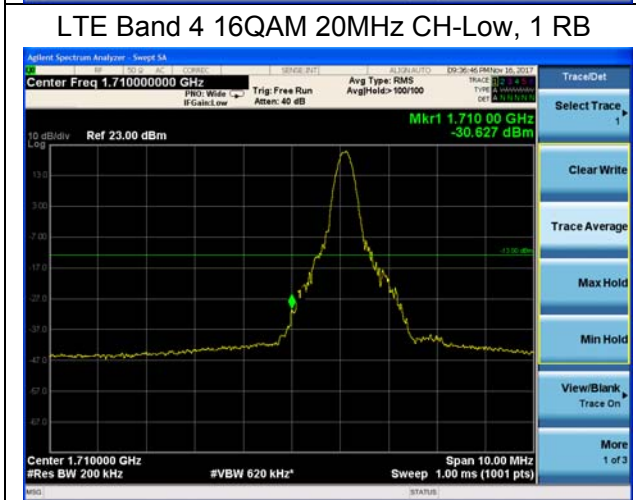
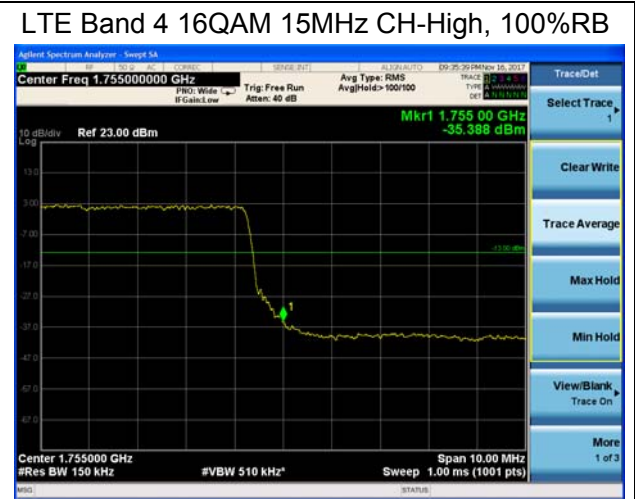
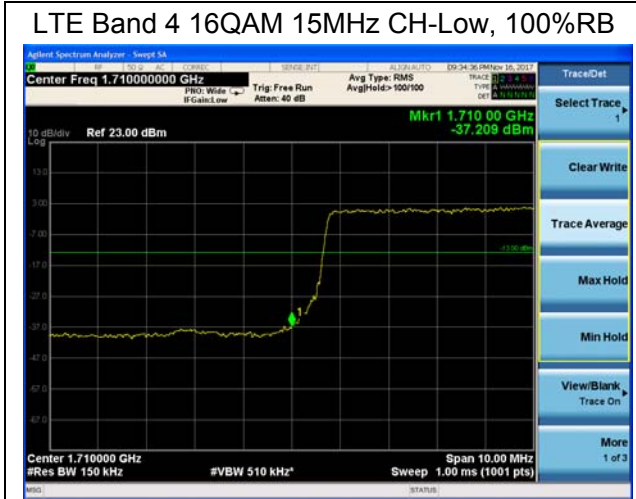



LTE Band 13 QPSK 5MHz CH-Low, 1 RB (763MHz ~775MHz)



LTE Band 13 QPSK 5MHz CH-Low, 1 RB (775MHz ~777MHz)

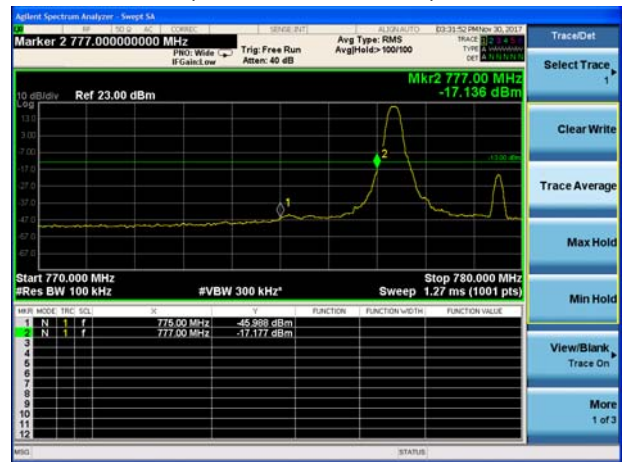

LTE Band 13 QPSK 5MHz CH-High, 1 RB (787MHz ~793MHz)

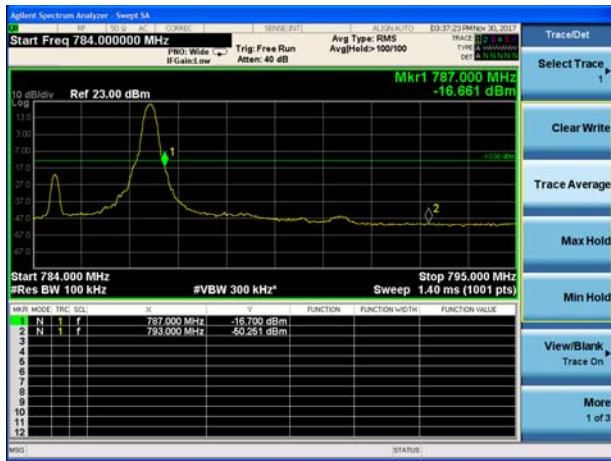

LTE Band 13 QPSK 5MHz CH-High, 1 RB (793MHz ~805MHz)

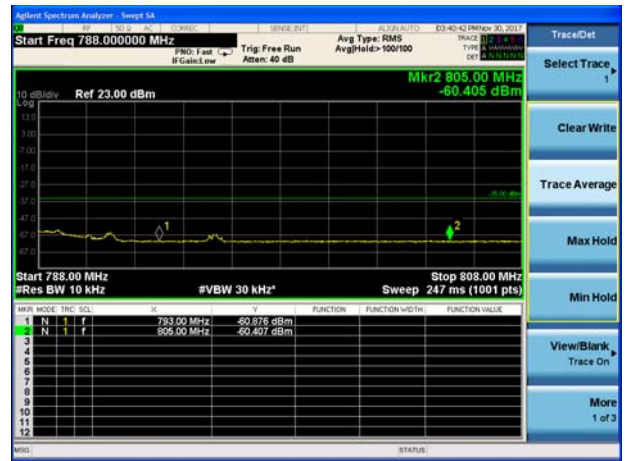



LTE Band 13 QPSK 5MHz CH-Low, 100%RB (763MHz ~775MHz)



LTE Band 13 QPSK 5MHz CH-Low, 100%RB (775MHz ~777MHz)

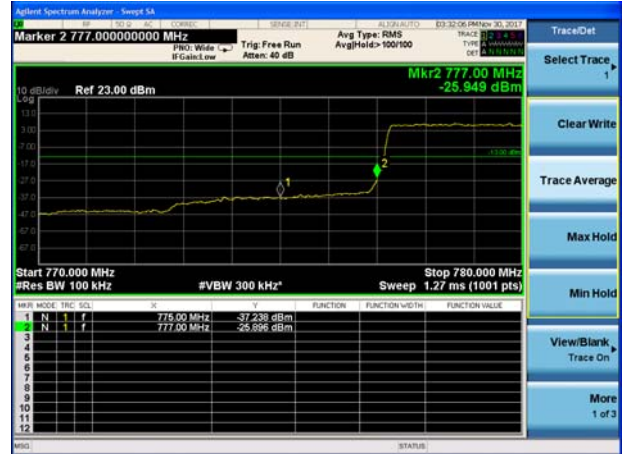

LTE Band 13 QPSK 5MHz CH-High, 100%RB (787MHz ~793MHz)



LTE Band 13 QPSK 5MHz CH-High, 100%RB (793MHz ~805MHz)





LTE Band 13 QPSK 10MHz CH-Low, 1 RB (763MHz ~775MHz)



LTE Band 13 QPSK 10MHz CH-Low, 1 RB (775MHz ~777MHz)



LTE Band 13 QPSK 10MHz CH-High, 1 RB (787MHz ~793MHz)



LTE Band 13 QPSK 10MHz CH-High, 1 RB (793MHz ~805MHz)

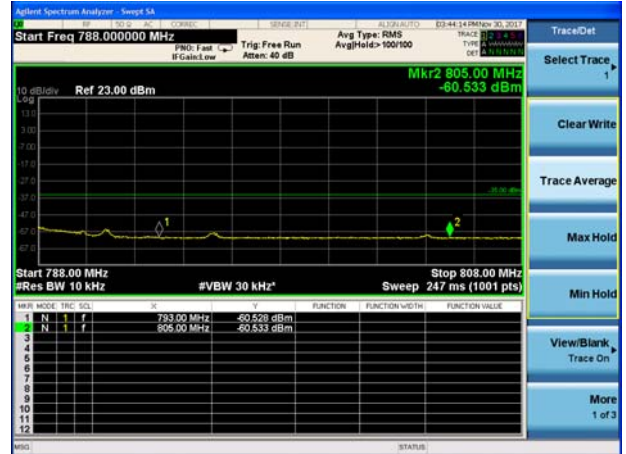

LTE Band 13 QPSK 10MHz CH-Low, 100%RB
(763MHz ~775MHz)



LTE Band 13 QPSK 10MHz CH-Low, 100%RB
(775MHz ~777MHz)



LTE Band 13 QPSK 10MHz CH-High, 100%RB
(787MHz ~793MHz)



LTE Band 13 QPSK 10MHz CH-High, 100%RB
(793MHz ~805MHz)





LTE Band 13 16QAM 5MHz CH-Low, 1 RB (763MHz ~775MHz)



LTE Band 13 16QAM 5MHz CH-Low, 1 RB (775MHz ~777MHz)

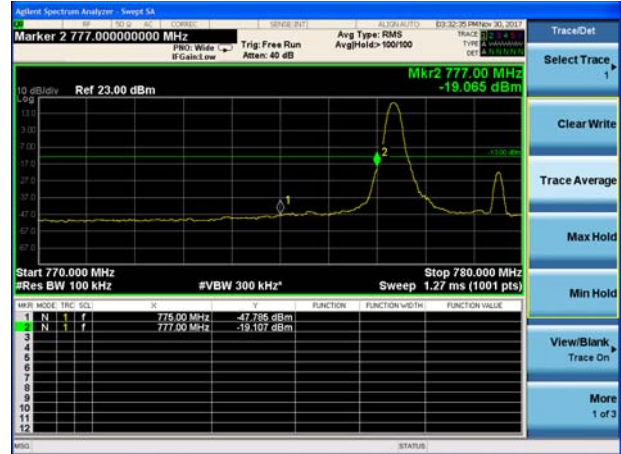

LTE Band 13 16QAM 5MHz CH-High, 1 RB (787MHz ~793MHz)

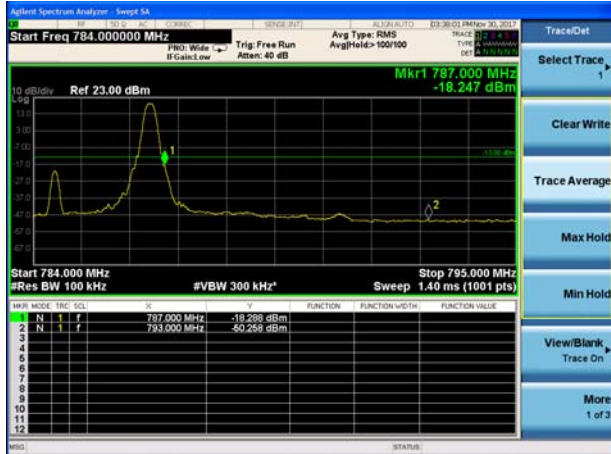

LTE Band 13 16QAM 5MHz CH-High, 1 RB (793MHz ~805MHz)



LTE Band 13 16QAM 5MHz CH-Low, 100%RB
(763MHz ~775MHz)



LTE Band 13 16QAM 5MHz CH-Low, 100%RB
(775MHz ~777MHz)



LTE Band 13 16QAM 5MHz CH-High, 100%RB
(787MHz ~793MHz)



LTE Band 13 16QAM 5MHz CH-High, 100%RB
(793MHz ~805MHz)





LTE Band 13 16QAM 10MHz CH-Low, 1 RB (763MHz ~775MHz)



LTE Band 13 16QAM 10MHz CH-Low, 1 RB (775MHz ~777MHz)

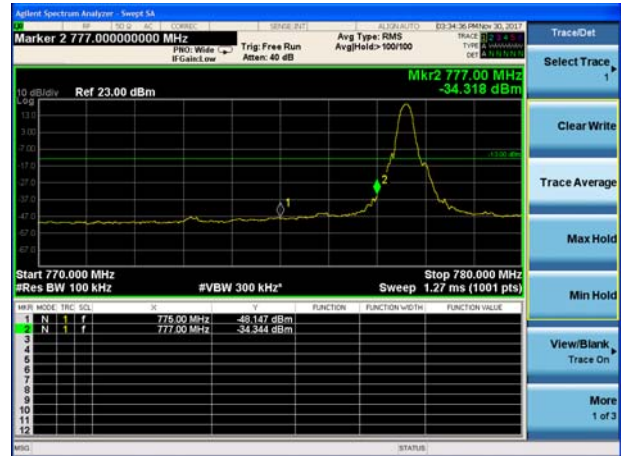

LTE Band 13 16QAM 10MHz CH-High, 1 RB (787MHz ~793MHz)



LTE Band 13 16QAM 10MHz CH-High, 1 RB (793MHz ~805MHz)



LTE Band 13 16QAM 10MHz CH-Low, 100%RB
(763MHz ~775MHz)



LTE Band 13 16QAM 10MHz CH-Low, 100%RB
(775MHz ~777MHz)



LTE Band 13 16QAM 10MHz CH-High, 100%RB
(787MHz ~793MHz)



LTE Band 13 16QAM 10MHz CH-High, 100%RB
(793MHz ~805MHz)



5.5 Peak-to-Average Power Ratio (PAPR)

Ambient condition

Temperature	Relative humidity	Pressure
23°C ~25°C	45%~50%	101.5kPa

Methods of Measurement

Measure the total peak power and record as Ppk. And measure the total average power and record as PAvg. Both the peak and average power levels must be expressed in the same logarithmic units (e.g., dBm). Determine the PAPR from:

$$PAPR (dB) = Ppk (dBm) - PAvg (dBm).$$

Test Setup

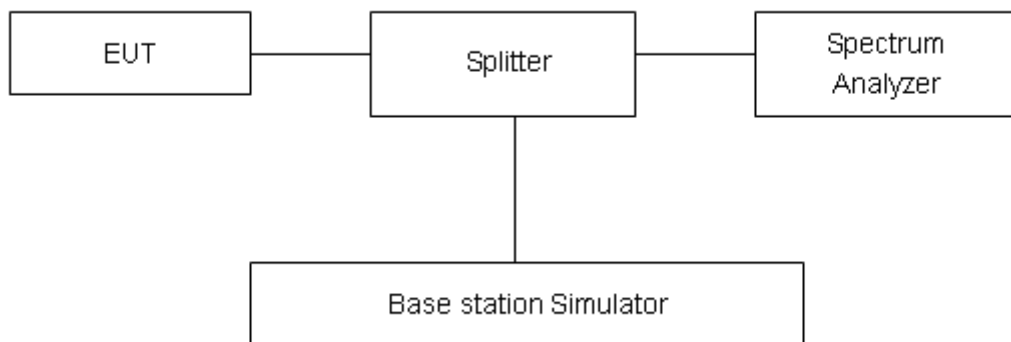

Limits

Rule Part 27.50(d)(5) Equipment employed must be authorized in accordance with the provisions of 24.51. Power measurements for transmissions by stations authorized under this section may be made either in accordance with a Commission-approved average power technique or in compliance with paragraph (d)(6) of this section. In measuring transmissions in this band using an average power technique, the peak-to-average ratio (PAR) of the transmission may not exceed 13 dB.

Measurement Uncertainty

The assessed measurement uncertainty to ensure 95% confidence level for the normal distribution is with the coverage factor k = 2, U= 0.4 dB.

Test Results

LTE Band 4								
Modulation	Bandwidth (MHz)	Channel	Frequency (MHz)	Peak (dBm)	Avg (dBm)	PAPR (dB)	Limit (dB)	Conclusion
QPSK	1.4	19957	1710.7	26.75	22.08	4.67	≤13	PASS
		20175	1732.5	26.81	22.00	4.81	≤13	PASS
		20393	1754.3	26.45	21.62	4.83	≤13	PASS
	3	19965	1711.5	26.81	21.91	4.90	≤13	PASS
		20175	1732.5	26.75	21.77	4.98	≤13	PASS
		20385	1753.5	26.81	21.76	5.05	≤13	PASS
	5	19975	1712.5	26.88	21.89	4.99	≤13	PASS
		20175	1732.5	26.72	21.76	4.96	≤13	PASS
		20375	1752.5	26.77	21.74	5.03	≤13	PASS
	10	20000	1715	27.05	21.97	5.08	≤13	PASS
		20175	1732.5	26.68	21.78	4.90	≤13	PASS
		20350	1750	26.83	21.78	5.05	≤13	PASS
	15	20025	1717.5	27.22	21.95	5.27	≤13	PASS
		20175	1732.5	26.77	21.74	5.03	≤13	PASS
		20325	1747.5	26.79	21.73	5.06	≤13	PASS
20	20050	1720	27.03	21.92	5.11	≤13	PASS	
	20175	1732.5	26.58	21.69	4.89	≤13	PASS	
	20300	1745	26.72	21.69	5.03	≤13	PASS	
16QAM	1.4	19957	1710.7	26.36	20.91	5.45	≤13	PASS
		20175	1732.5	26.77	21.12	5.65	≤13	PASS
		20393	1754.3	26.42	20.78	5.64	≤13	PASS
	3	19965	1711.5	26.63	20.93	5.70	≤13	PASS
		20175	1732.5	26.76	20.98	5.78	≤13	PASS
		20385	1753.5	26.71	20.84	5.87	≤13	PASS
	5	19975	1712.5	26.65	20.91	5.74	≤13	PASS
		20175	1732.5	26.71	20.94	5.77	≤13	PASS
		20375	1752.5	26.66	20.79	5.87	≤13	PASS
	10	20000	1715	26.81	20.94	5.87	≤13	PASS
		20175	1732.5	26.72	20.99	5.73	≤13	PASS
		20350	1750	26.72	20.83	5.89	≤13	PASS
	15	20025	1717.5	26.90	20.91	5.99	≤13	PASS
		20175	1732.5	26.74	20.94	5.80	≤13	PASS
		20325	1747.5	26.60	20.79	5.81	≤13	PASS
20	20050	1720	26.85	20.89	5.96	≤13	PASS	
	20175	1732.5	26.67	20.90	5.77	≤13	PASS	
	20300	1745	26.56	20.76	5.80	≤13	PASS	



LTE Band 13								
Modulation	Bandwidth (MHz)	Channel	Frequency (MHz)	Peak (dBm)	Avg (dBm)	PAPR (dB)	Limit (dB)	Conclusion
QPSK	5	23205	779.5	27.97	22.65	5.32	≤13	PASS
		23230	782	28.31	22.65	5.66	≤13	PASS
		23255	784.5	28.50	22.60	5.90	≤13	PASS
	10	23230	782	28.15	22.54	5.61	≤13	PASS
16QAM	5	23205	779.5	27.82	21.68	6.14	≤13	PASS
		23230	782	28.08	21.61	6.47	≤13	PASS
		23255	784.5	28.48	21.75	6.73	≤13	PASS
	10	23230	782	28.01	21.60	6.41	≤13	PASS

5.6 Frequency Stability

Ambient condition

Temperature	Relative humidity	Pressure
23°C ~25°C	45%~50%	101.5kPa

Method of Measurement

1. Frequency Stability (Temperature Variation)

The temperature inside the climate chamber is varied from -40°C to +75°C in 10°C step size.

(1)With all power removed, the temperature was decreased to -10°C and permitted to stabilize for three hours.

(2)Measure the carrier frequency with the test equipment in a “call mode”. These measurements should be made within 1 minute of powering up the mobile station, to prevent significant self warming.

(3) Repeat the above measurements at 10°C increments from -40°C to +75°C. Allow at least 1.5 hours at each temperature, un-powered, before making measurements.

2. Frequency Stability (Voltage Variation)

The frequency stability shall be measured with variation of primary supply voltage as follows:

(1) Vary primary supply voltage from 85 to 115 percent of the nominal value for other than hand carried battery equipment.

(2) For hand carried, battery powered equipment, reduce primary supply voltage to the battery-operating end point which shall be specified by the manufacturer.

This transceiver is specified to operate with an input voltage of between 7V and 30V, with a nominal voltage of 9V.

Test setup

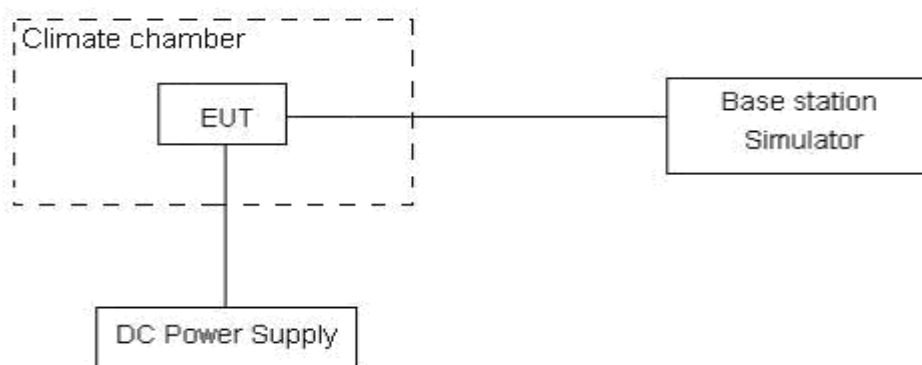

Limits

No specific frequency stability requirements in part 27.54

Measurement Uncertainty

The assessed measurement uncertainty to ensure 99.75% confidence level for the normal distribution is with the coverage factor $k = 3, U=0.01\text{ppm}$.

Test Result

Bandwidth	Test status	LTE Band 4 Channel 20175 Test Results (ppm)	
		QPSK	16QAM
1.4MHz	-40°C/Normal Voltage	-0.00234	0.00441
	-30°C/Normal Voltage	-0.00083	0.00702
	-20°C/Normal Voltage	-0.00202	0.00491
	-10°C/Normal Voltage	-0.00234	0.00530
	0°C/Normal Voltage	-0.00036	-0.00211
	10°C/Normal Voltage	0.00090	0.00366
	20°C/Normal Voltage	0.00046	-0.00714
	30°C/Normal Voltage	0.00166	0.00378
	40°C/Normal Voltage	-0.00046	-0.00078
	50°C/Normal Voltage	-0.00062	0.00455
	60°C/Normal Voltage	-0.00065	0.00387
	70°C/Normal Voltage	0.00063	-0.00193
	75°C/Normal Voltage	0.00094	0.00395
	20°C/Min Voltage	-0.00102	0.00021
	20°C/Max Voltage	0.00072	0.00059
3MHz	-40°C/Normal Voltage	-0.00073	-0.00106
	-30°C/Normal Voltage	-0.00113	0.00049
	-20°C/Normal Voltage	0.00077	-0.00230
	-10°C/Normal Voltage	-0.00010	0.00176
	0°C/Normal Voltage	-0.00204	0.00261
	10°C/Normal Voltage	-0.00005	0.00241
	20°C/Normal Voltage	0.00184	0.00040
	30°C/Normal Voltage	0.00172	0.00096
	40°C/Normal Voltage	-0.00151	-0.00029
	50°C/Normal Voltage	0.00065	-0.00173
	60°C/Normal Voltage	0.00238	0.00063
	70°C/Normal Voltage	-0.00048	-0.00476
	75°C/Normal Voltage	-0.00127	0.00117
	20°C/Min Voltage	-0.00075	-0.00317
	20°C/Max Voltage	-0.00095	-0.00281
5MHz	-40°C/Normal Voltage	-0.00104	-0.00215
	-30°C/Normal Voltage	0.00063	-0.00195
	-20°C/Normal Voltage	-0.00035	0.00418
	-10°C/Normal Voltage	0.00042	0.00507
	0°C/Normal Voltage	0.00054	-0.00101
	10°C/Normal Voltage	-0.00088	0.00491



	20°C/Normal Voltage	0.00012	0.00670
	30°C/Normal Voltage	0.00085	0.00657
	40°C/Normal Voltage	0.00048	-0.00130
	50°C/Normal Voltage	0.00047	0.00410
	60°C/Normal Voltage	0.00068	-0.00106
	70°C/Normal Voltage	-0.00038	0.00464
	75°C/Normal Voltage	0.00125	0.00687
	20°C/Min Voltage	-0.00067	-0.00284
	20°C/Max Voltage	-0.00169	0.00678
10MHz	-40°C/Normal Voltage	-0.00098	-0.00044
	-30°C/Normal Voltage	0.00013	-0.00027
	-20°C/Normal Voltage	-0.00125	-0.00245
	-10°C/Normal Voltage	-0.00234	-0.00291
	0°C/Normal Voltage	-0.00002	-0.00124
	10°C/Normal Voltage	-0.00056	-0.00105
	20°C/Normal Voltage	-0.00002	-0.00025
	30°C/Normal Voltage	0.00094	-0.00106
	40°C/Normal Voltage	0.00147	-0.00305
	50°C/Normal Voltage	-0.00266	-0.00175
	60°C/Normal Voltage	-0.00031	-0.00060
	70°C/Normal Voltage	-0.00010	-0.00211
	75°C/Normal Voltage	-0.00012	-0.00255
	20°C/Min Voltage	0.00054	-0.00248
20°C/Max Voltage	-0.00008	-0.00053	
15MHz	-40°C/Normal Voltage	-0.00250	0.00399
	-30°C/Normal Voltage	0.00055	-0.00057
	-20°C/Normal Voltage	-0.00047	0.00426
	-10°C/Normal Voltage	0.00083	-0.00048
	0°C/Normal Voltage	-0.00280	-0.00090
	10°C/Normal Voltage	0.00260	0.00272
	20°C/Normal Voltage	-0.00020	-0.00217
	30°C/Normal Voltage	-0.00005	0.00229
	40°C/Normal Voltage	0.00222	0.00139
	50°C/Normal Voltage	-0.00034	-0.00061
	60°C/Normal Voltage	-0.00077	-0.00104
	70°C/Normal Voltage	0.00266	0.00526
	75°C/Normal Voltage	0.00057	0.00044
	20°C/Min Voltage	-0.00020	-0.00185
20°C/Max Voltage	-0.00238	0.00284	
20MHz	-40°C/Normal Voltage	0.00113	-0.00328



	-30°C/Normal Voltage	-0.00042	-0.00296
	-20°C/Normal Voltage	0.00125	-0.00140
	-10°C/Normal Voltage	-0.00192	-0.00382
	0°C/Normal Voltage	0.00054	-0.00300
	10°C/Normal Voltage	-0.00044	-0.00349
	20°C/Normal Voltage	-0.00009	-0.00267
	30°C/Normal Voltage	-0.00040	-0.00177
	40°C/Normal Voltage	-0.00105	-0.00554
	50°C/Normal Voltage	-0.00100	-0.00189
	60°C/Normal Voltage	0.00182	-0.00200
	70°C/Normal Voltage	-0.00117	-0.00287
	75°C/Normal Voltage	-0.00230	-0.00364
	20°C/Min Voltage	0.00081	-0.00330
	20°C/Max Voltage	-0.00050	-0.00297

Bandwidth	Test status	LTE Band 13 Channel 23230 Test Results (ppm)	
		QPSK	16QAM
5MHz	-40°C/Normal Voltage	0.00052	0.01109
	-30°C/Normal Voltage	-0.00260	-0.00637
	-20°C/Normal Voltage	-0.00052	-0.00395
	-10°C/Normal Voltage	-0.00161	0.00977
	0°C/Normal Voltage	-0.00118	0.00935
	10°C/Normal Voltage	-0.00082	0.01413
	20°C/Normal Voltage	-0.00026	0.00949
	30°C/Normal Voltage	0.00216	0.01041
	40°C/Normal Voltage	0.00008	0.01290
	50°C/Normal Voltage	-0.00106	0.01244
	60°C/Normal Voltage	-0.00157	-0.00488
	70°C/Normal Voltage	-0.00207	0.01254
	75°C/Normal Voltage	0.00256	0.01211
	20°C/Min Voltage	-0.00008	-0.00629
	20°C/Max Voltage	0.00226	0.01193
10MHz	-40°C/Normal Voltage	-0.00361	-0.00811
	-30°C/Normal Voltage	-0.00366	-0.00439
	-20°C/Normal Voltage	-0.00205	-0.00871
	-10°C/Normal Voltage	-0.00290	-0.00671
	0°C/Normal Voltage	-0.00307	-0.00371
	10°C/Normal Voltage	-0.00040	-0.00458
	20°C/Normal Voltage	0.00068	-0.00642
	30°C/Normal Voltage	-0.00394	-0.00902



	40°C/Normal Voltage	-0.00203	-0.00731
	50°C/Normal Voltage	-0.00018	-0.00276
	60°C/Normal Voltage	-0.00114	-0.00477
	70°C/Normal Voltage	-0.00119	-0.00307
	75°C/Normal Voltage	-0.00008	-0.00807
	20°C/Min Voltage	-0.00269	-0.00595
	20°C/Max Voltage	0.00084	-0.00318

5.7 Spurious Emissions at Antenna Terminals

Ambient condition

Temperature	Relative humidity	Pressure
23°C ~25°C	45%~50%	101.5kPa

Method of Measurement

The EUT was connected to Spectrum Analyzer and Base Station Simulator via power Splitter. The measurement is carried out using a spectrum analyzer. The spectrum analyzer scans from 30MHz to the 10th harmonic of the carrier. The peak detector is used. Set RBW 1MHz and VBW3MHz, Sweep is set to ATUO.

Of those disturbances below (limit – 20 dB), the mark is not required for the EUT.

Test setup

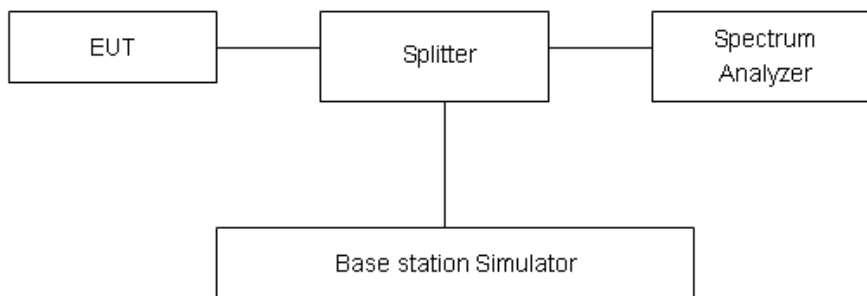

Limits

Rule Part 27.53(h) specifies that “for operations in the 1695-1710 MHz, 1710-1755 MHz, 1755-1780 MHz, 1915-1920 MHz, 1995-2000 MHz, 2000-2020 MHz, 2110-2155 MHz, 2155-2180 MHz, and 2180-2200 bands, the power of any emission outside a licensee's frequency block shall be attenuated below the transmitter power (P) in watts by at least $43 + 10 \log_{10} (P)$ dB..”

Rule Part 27.53(f) For operations in the 746-758 MHz, 775-788 MHz, and 805-806 MHz bands, emissions in the band 1559-1610 MHz shall be limited to -70 dBW/MHz equivalent isotropically radiated power (EIRP) for wideband signals, and -80 dBW EIRP for discrete emissions of less than 700 Hz bandwidth. For the purpose of equipment authorization, a transmitter shall be tested with an antenna that is representative of the type that will be used with the equipment in normal operation.

Rule Part 27.53 (c) For operations in the 746-758 MHz band and the 776-788 MHz band, the power of any emission outside the licensee's frequency band(s) of operation shall be attenuated below the transmitter power (P) within the licensed band(s) of operation, measured in watts, in accordance with the following:

- (1) On any frequency outside the 746-758 MHz band, the power of any emission shall be attenuated outside the band below the transmitter power (P) by at least $43 + 10 \log (P)$ dB;



- (2) On any frequency outside the 776-788 MHz band, the power of any emission shall be attenuated outside the band below the transmitter power (P) by at least $43 + 10 \log (P)$ dB;
- (3) On all frequencies between 763-775 MHz and 793-805 MHz, by a factor not less than $76 + 10 \log (P)$ dB in a 6.25 kHz band segment, for base and fixed stations;
- (4) On all frequencies between 763-775 MHz and 793-805 MHz, by a factor not less than $65 + 10 \log (P)$ dB in a 6.25 kHz band segment, for mobile and portable stations;
- (5) Compliance with the provisions of paragraphs (c)(1) and (c)(2) of this section is based on the use of measurement instrumentation employing a resolution bandwidth of 100 kHz or greater. However, in the 100 kHz bands immediately outside and adjacent to the frequency block, a resolution bandwidth of at least 30 kHz may be employed;
- (6) Compliance with the provisions of paragraphs (c)(3) and (c)(4) of this section is based on the use of measurement instrumentation such that the reading taken with any resolution bandwidth setting should be adjusted to indicate spectral energy in a 6.25 kHz segment.

Part 27.53(h) Limit		-13 dBm
Part 27.53(f) Limit	Limit out of the band 1559-1610 MHz	-13 dBm
	Limit in the band 1559-1610 MHz	-40 dBm

Measurement Uncertainty

The assessed measurement uncertainty to ensure 99.75% confidence level for the normal distribution is with the coverage factor $k = 1.96$.

Frequency	Uncertainty
100kHz-2GHz	0.684 dB
2GHz-18GHz	1.407 dB

Test Result

Sweep from 9 kHz to 30MHz, and the emissions more than 20 dB below the permissible value are not reported.

If disturbances were found more than 20dB below limit line, the mark is not required for the EUT. The signal beyond the limit is carrier.

LTE Band 4 1.4MHz CH-Low 30MHz~3GHz

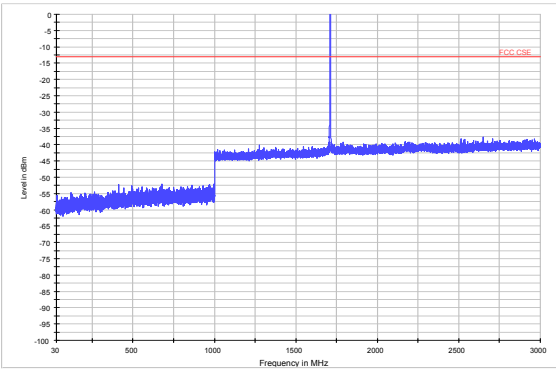

LTE Band 4 1.4MHz CH-Low 3GHz~18GHz

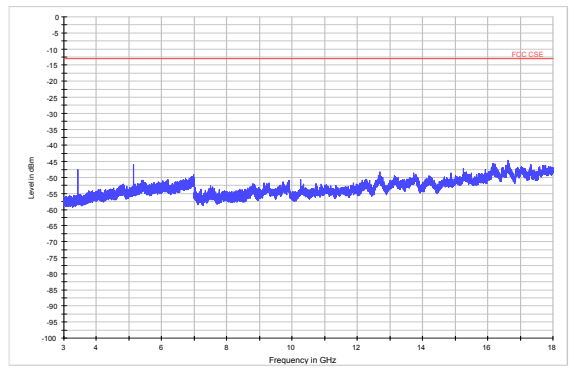

LTE Band 4 1.4MHz CH-Middle 30MHz~3GHz

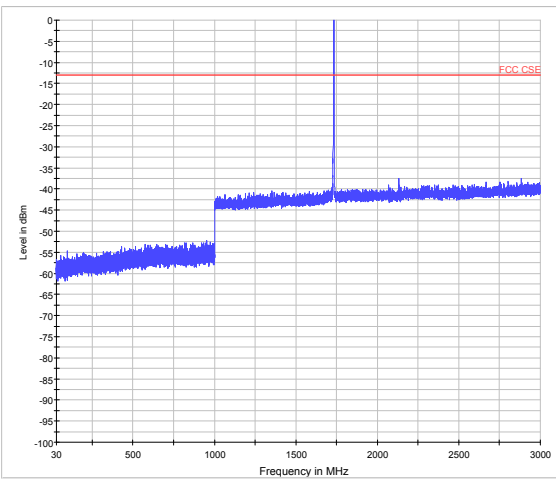

LTE Band 4 1.4MHz CH-Middle 3GHz~18GHz

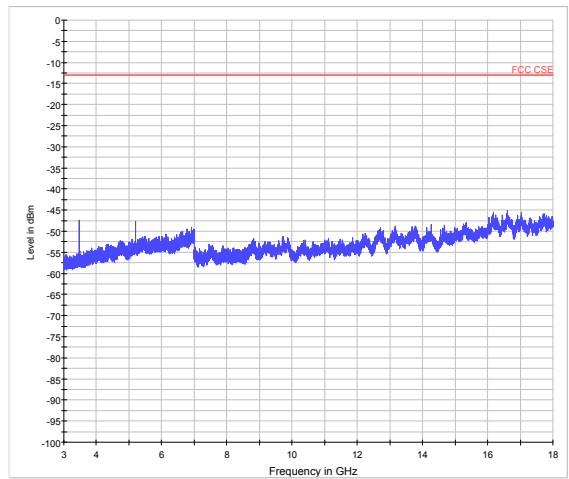

LTE Band 4 1.4MHz CH-High 30MHz~3GHz

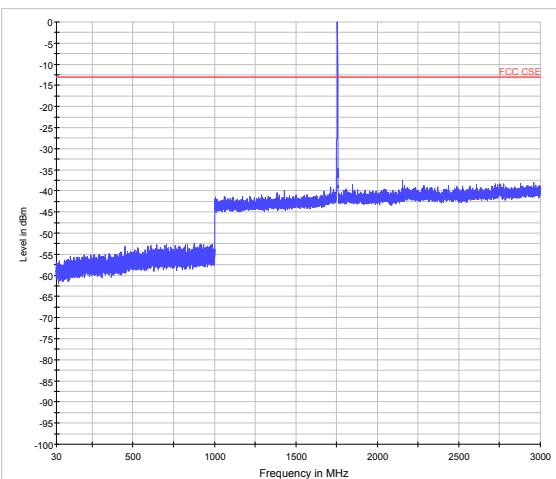

LTE Band 4 1.4MHz CH-High 3GHz~18GHz

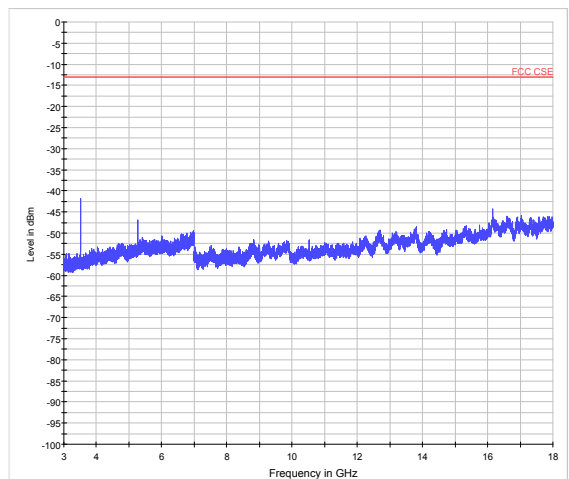



LTE Band 4 3MHz CH-Low 30MHz~3GHz

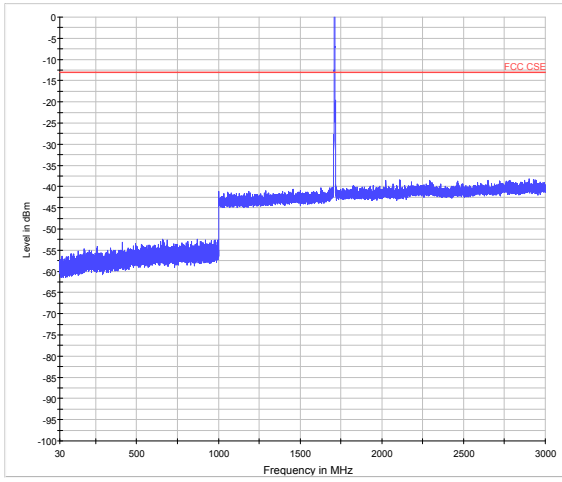

LTE Band 4 3MHz CH-Low 3GHz~18GHz

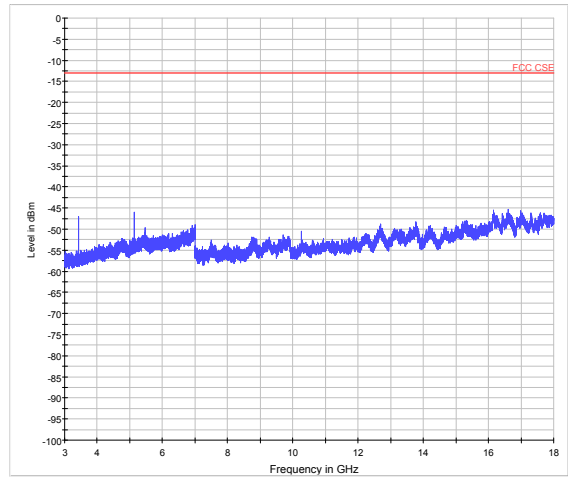

LTE Band 4 3MHz CH-Middle 30MHz~3GHz

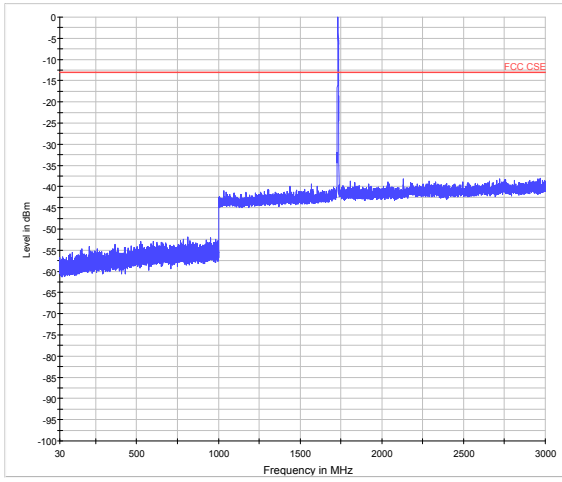

LTE Band 4 3MHz CH-Middle 3GHz~18GHz

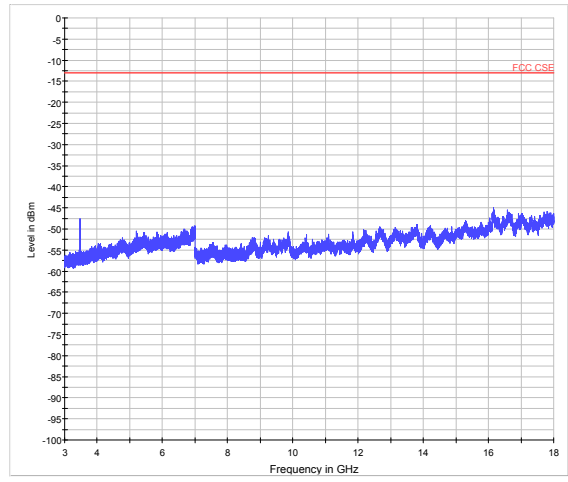

LTE Band 4 3MHz CH-High 30MHz~3GHz

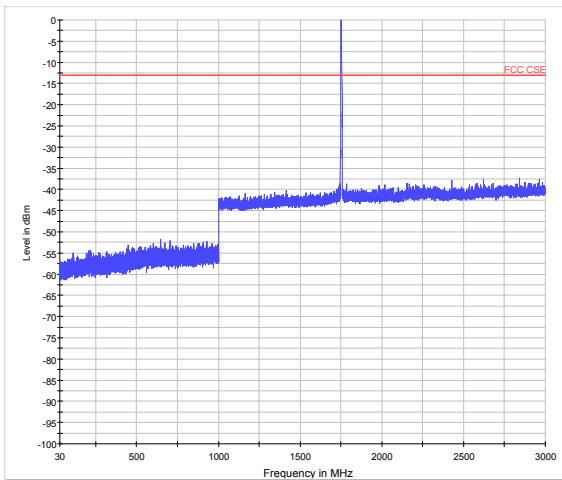

LTE Band 4 3MHz CH-High 3GHz~18GHz

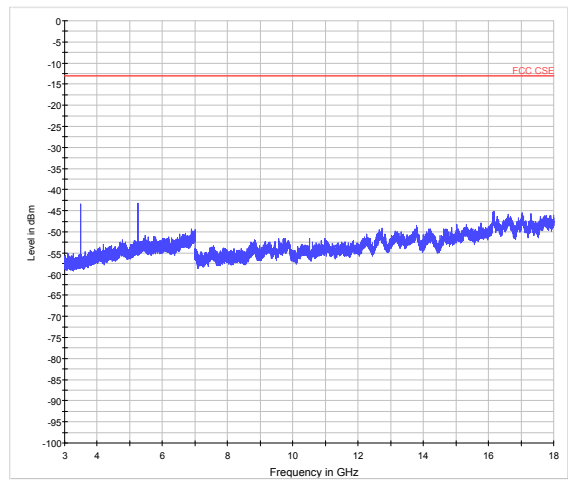



LTE Band 4 5MHz CH-Low 30MHz~3GHz

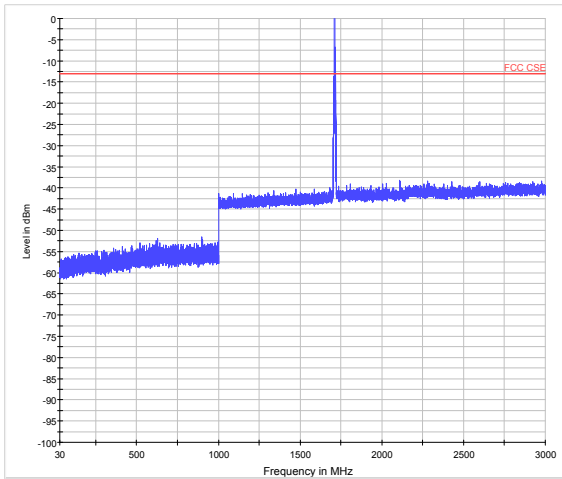

LTE Band 4 5MHz CH-Low 3GHz~18GHz

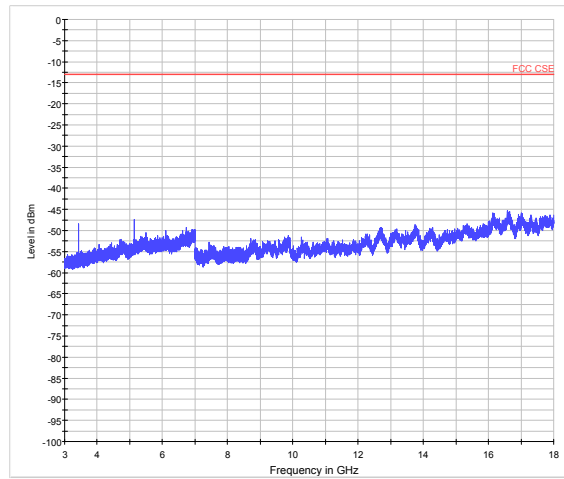

LTE Band 4 5MHz CH-Middle 30MHz~3GHz

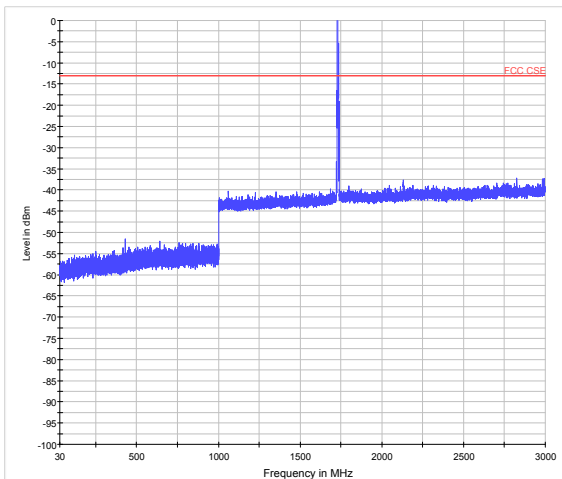

LTE Band 4 5MHz CH-Middle 3GHz~18GHz

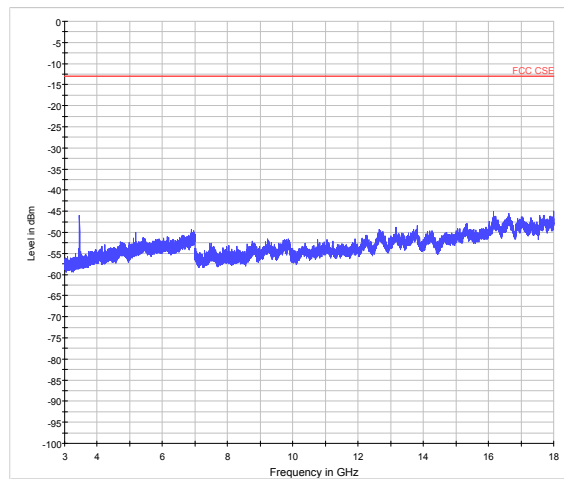

LTE Band 4 5MHz CH-High 30MHz~3GHz

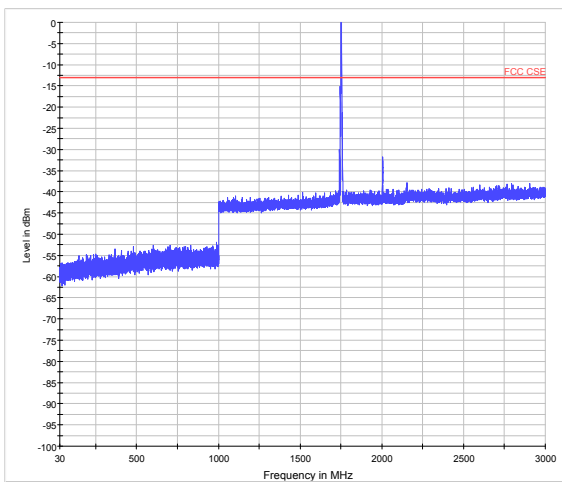

LTE Band 4 5MHz CH-High 3GHz~18GHz

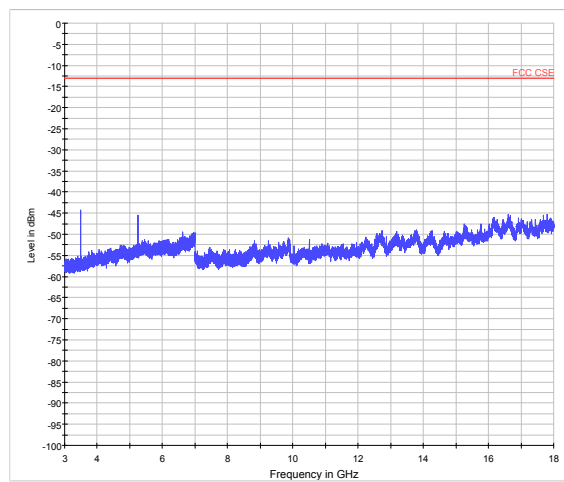



LTE Band 4 10MHz CH-Low 30MHz~3GHz

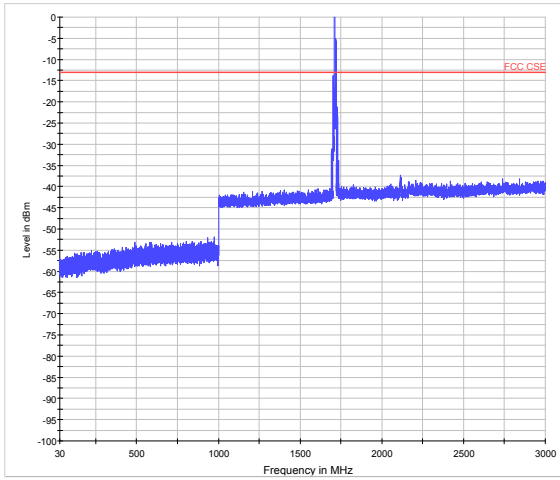

LTE Band 4 10MHz CH-Low 3GHz~18GHz

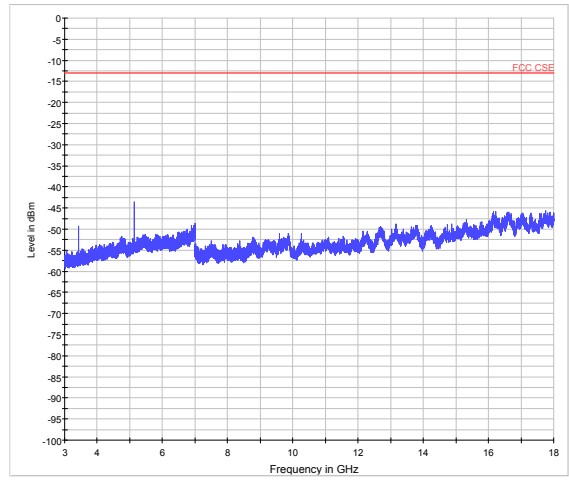

LTE Band 4 10MHz CH-Middle 30MHz~3GHz

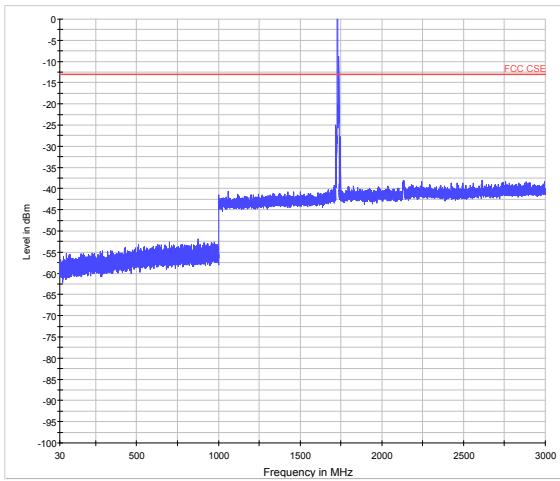

LTE Band 4 10MHz CH-Middle 3GHz~18GHz

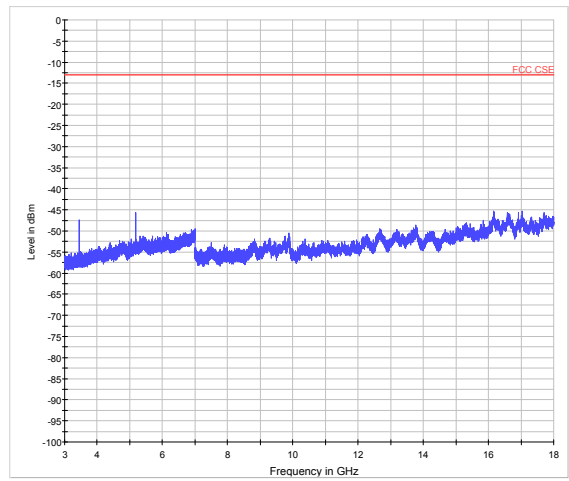

LTE Band 4 10MHz CH-High 30MHz~3GHz

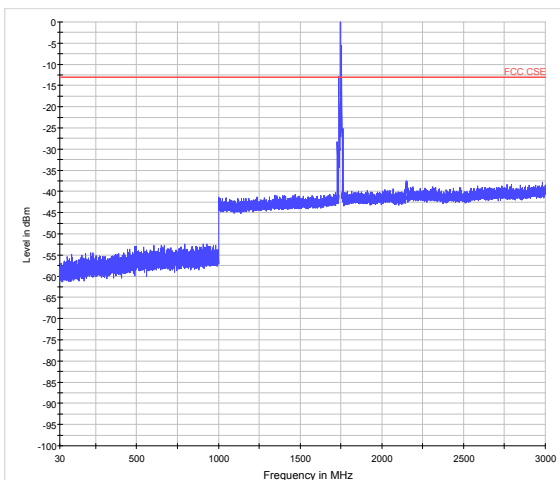

LTE Band 4 10MHz CH-High 3GHz~18GHz

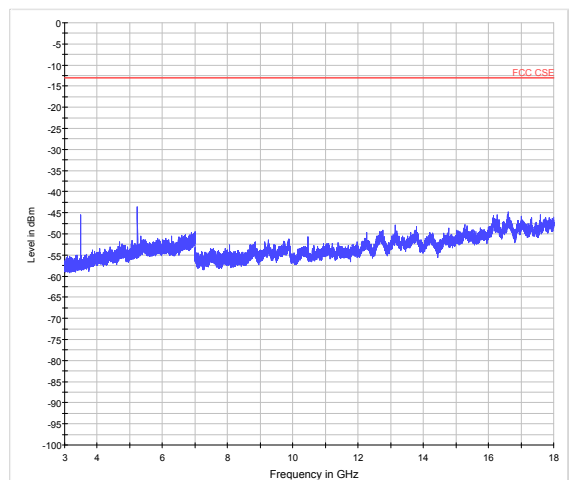



LTE Band 4 15MHz CH-Low 30MHz~3GHz

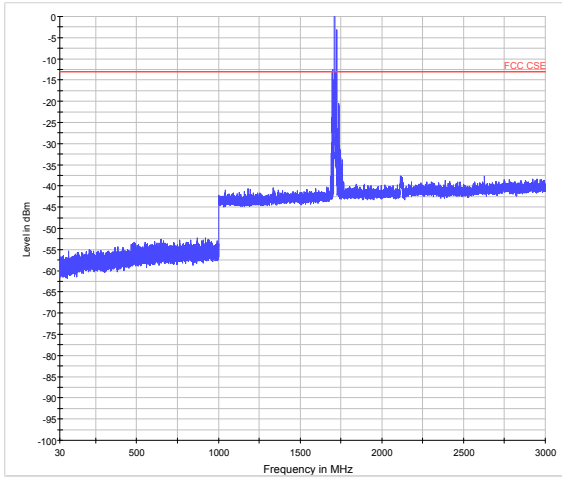

LTE Band 4 15MHz CH-Low 3GHz~18GHz

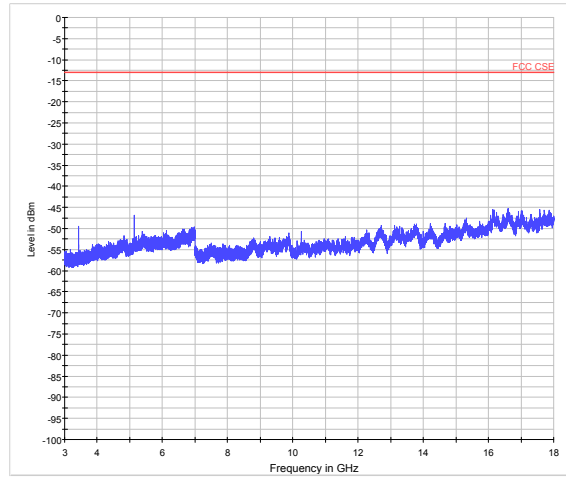

LTE Band 4 15MHz CH-Middle 30MHz~3GHz

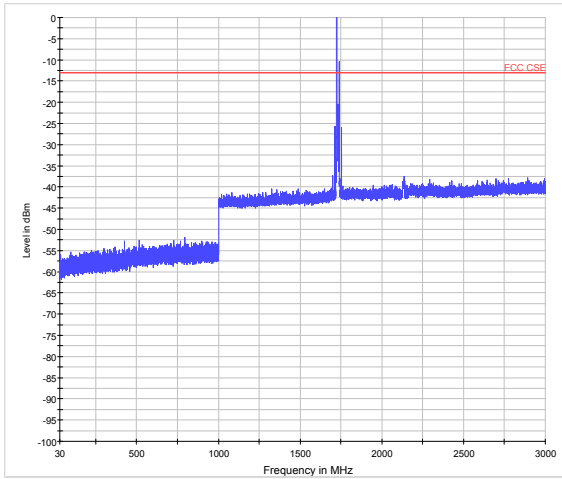

LTE Band 4 15MHz CH-Middle 3GHz~18GHz

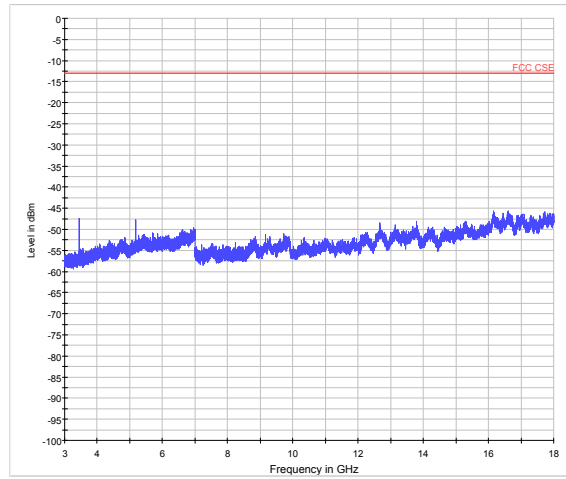

LTE Band 4 15MHz CH-High 30MHz~3GHz

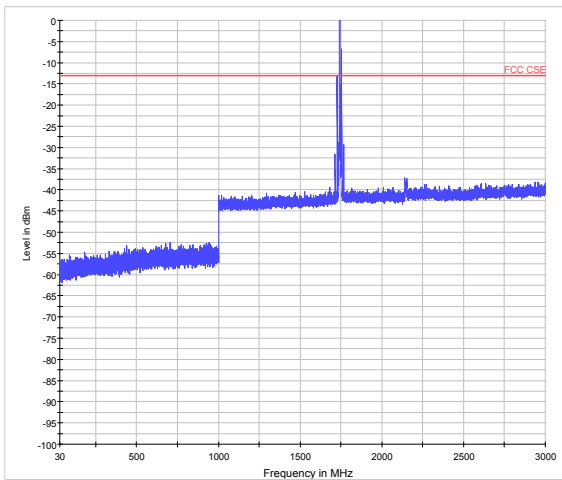

LTE Band 4 15MHz CH-High 3GHz~18GHz

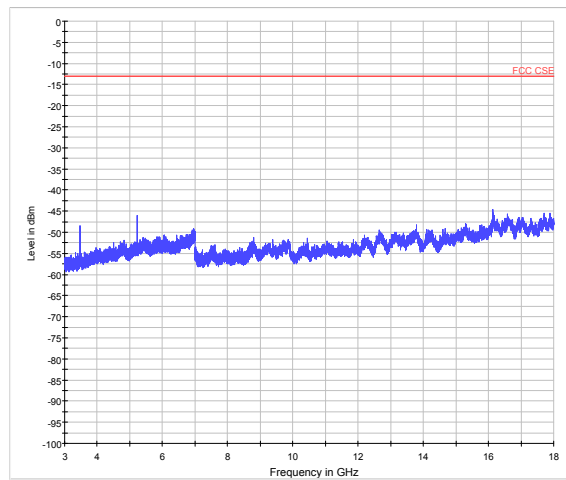



LTE Band 4 20MHz CH-Low 30MHz~3GHz

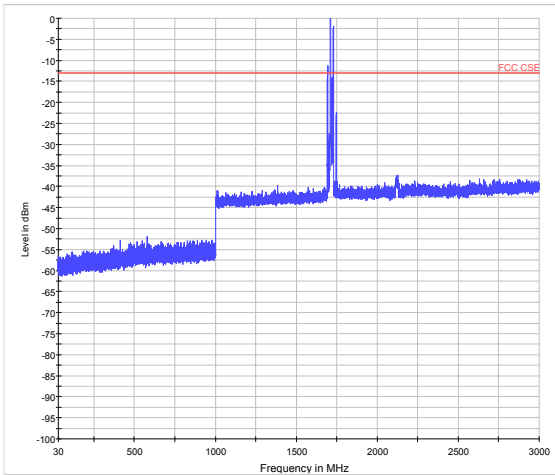

LTE Band 4 20MHz CH-Low 3GHz~18GHz

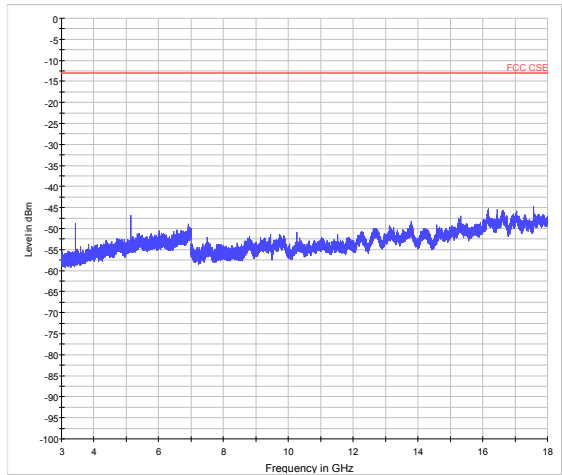

LTE Band 4 20MHz CH-Middle 30MHz~3GHz

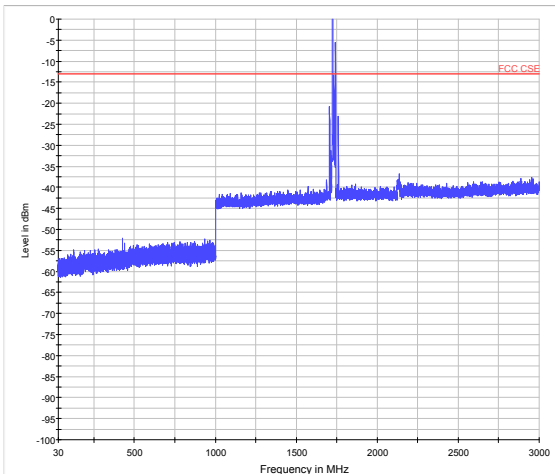

LTE Band 4 20MHz CH-Middle 3GHz~18GHz

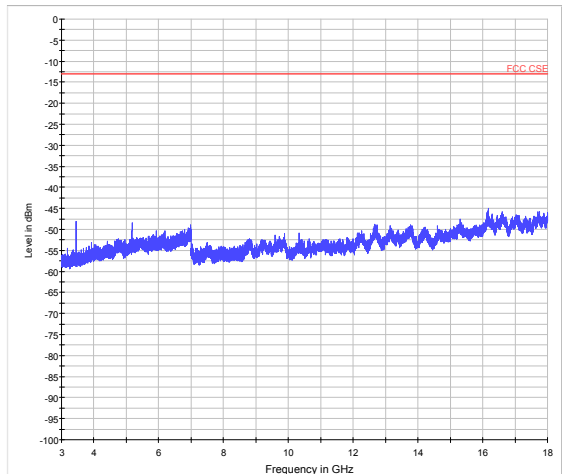

LTE Band 4 20MHz CH-High 30MHz~3GHz

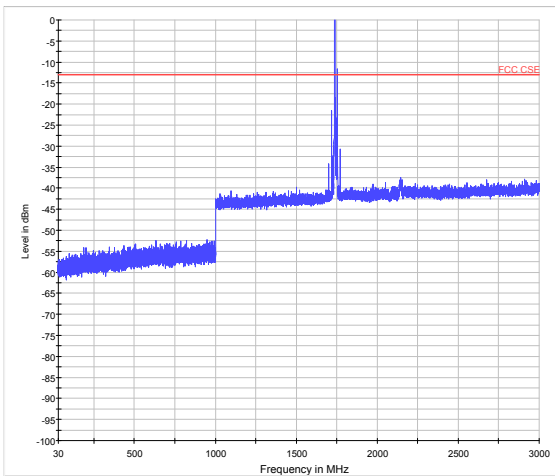

LTE Band 4 20MHz CH-High 3GHz~18GHz

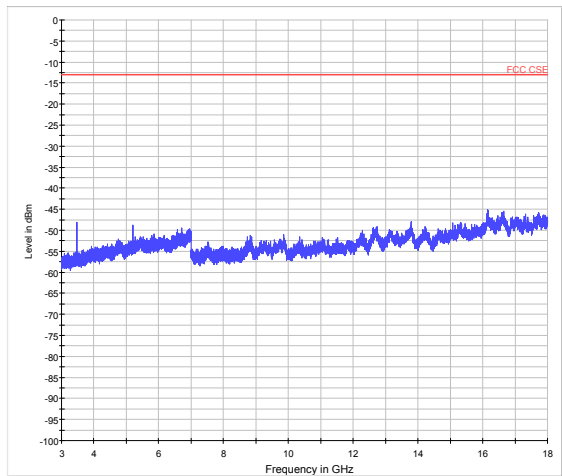



LTE Band 13 5MHz CH-Low 30MHz~1.5GHz

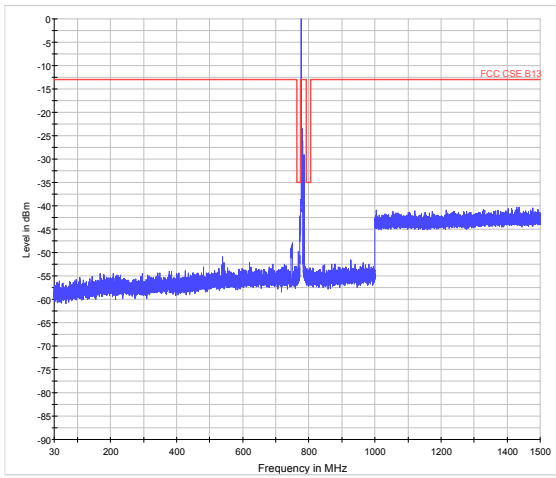

LTE Band 13 5MHz CH-Low 1.5GHz~9GHz

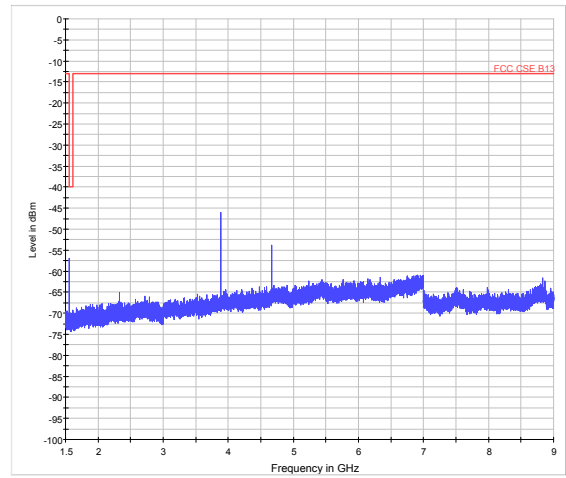

LTE Band 13 5MHz CH-Middle 30MHz~1.5GHz

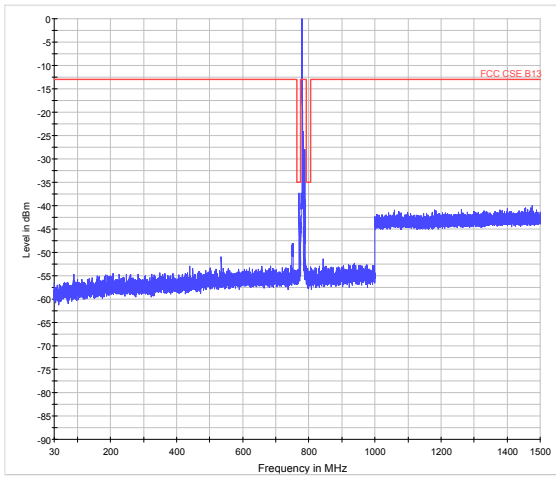

LTE Band 13 5MHz CH-Middle 1.5GHz ~9GHz

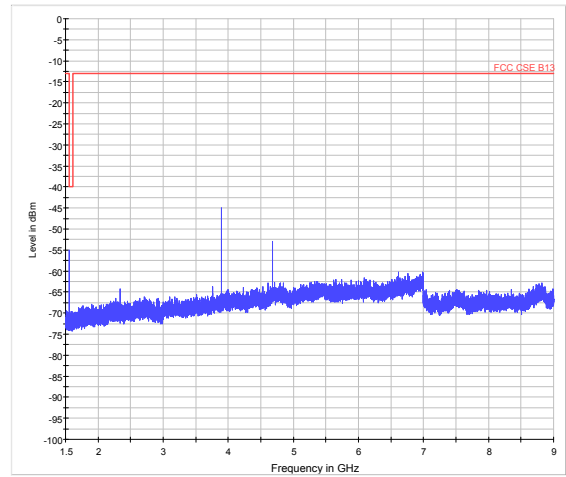

LTE Band 13 5MHz CH-High 30MHz~1.5GHz

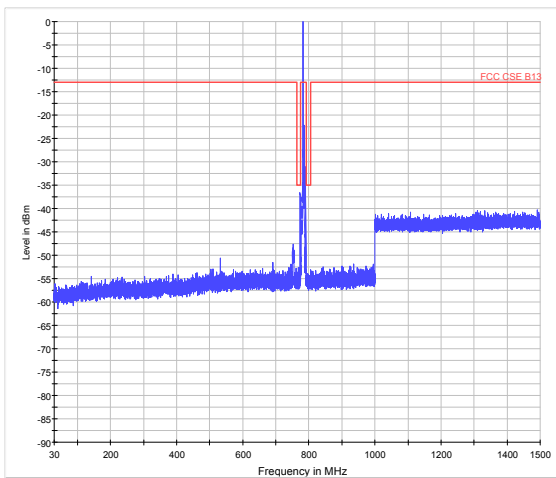

LTE Band 13 5MHz CH-High 1.5GHz~9GHz

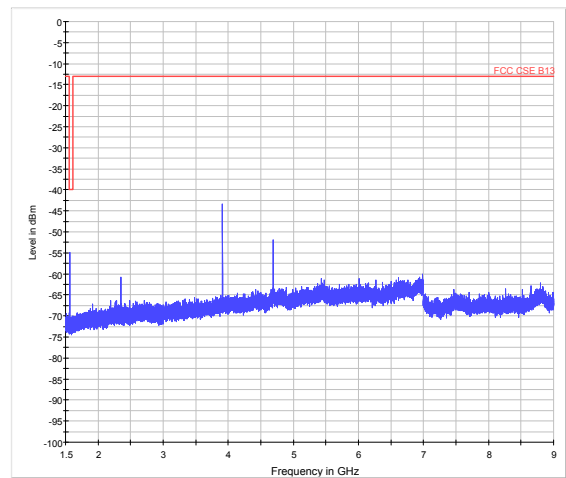



LTE Band 13 10MHz CH- Low 30MHz~1.5GHz

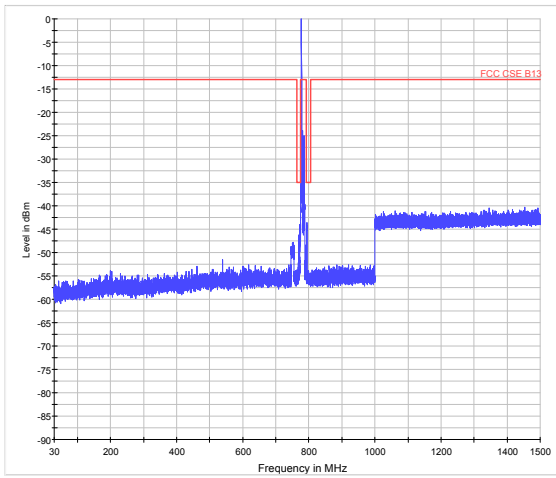

LTE Band 13 10MHz CH- Low 1.5GHz~9GHz

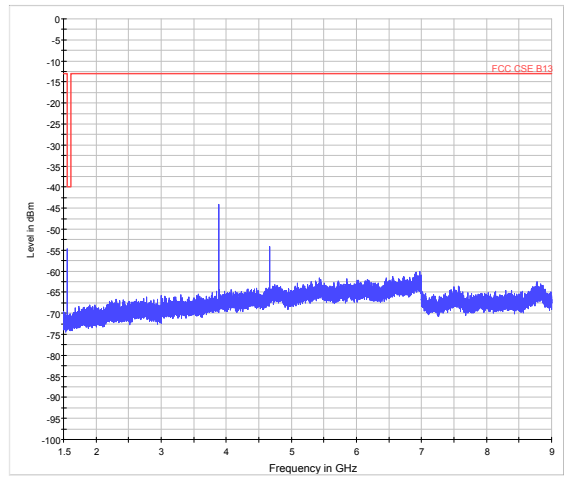

LTE Band 13 10MHz CH-Middle 30MHz~1.5GHz

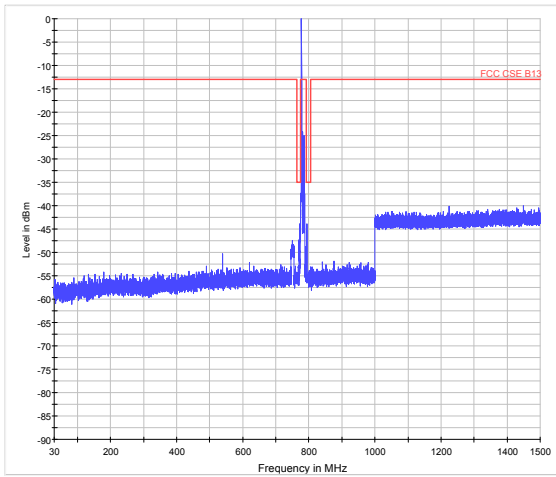

LTE Band 13 10MHz CH-Middle 1.5GHz~9GHz

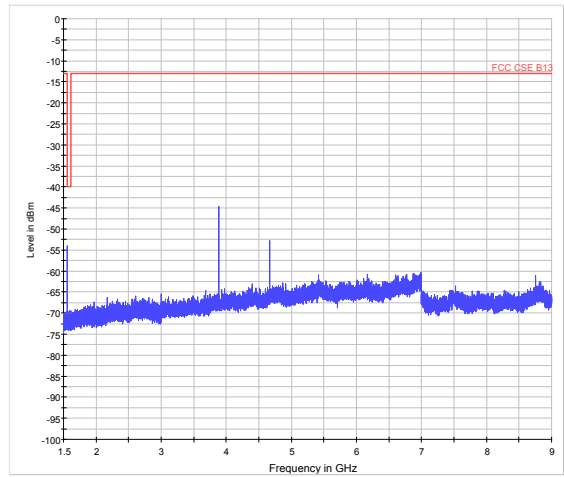

LTE Band 13 10MHz CH- High 30MHz~1.5GHz

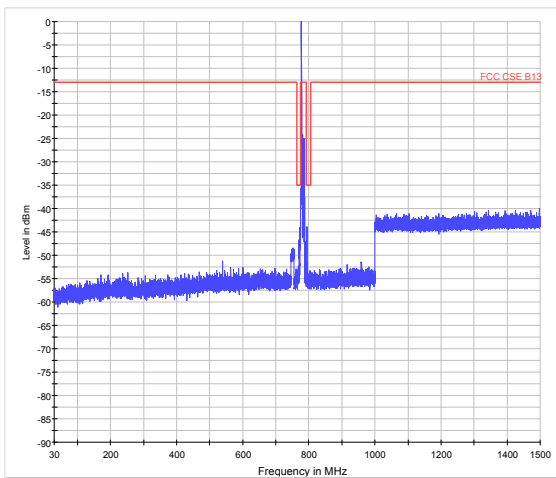

LTE Band 13 10MHz CH- High 1.5GHz~9GHz

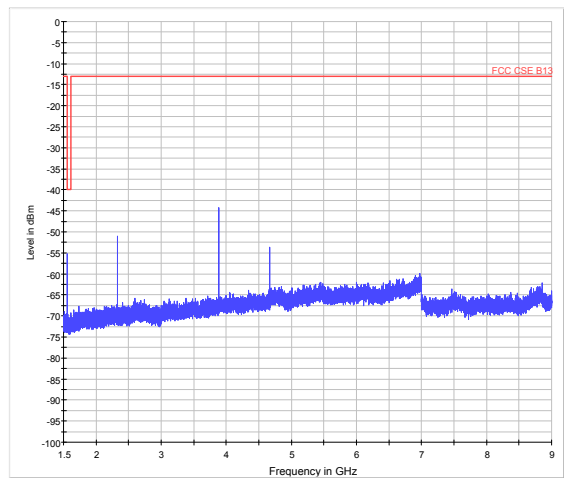

5.8 Radiates Spurious Emission

Ambient condition

Temperature	Relative humidity	Pressure
23°C ~25°C	45%~50%	101.5kPa

Method of Measurement

1. The testing follows FCC KDB 971168 v03 Section 5.8 and ANSI/TIA-603-D-2010.
2. The EUT is placed on a turntable 0.8 meters above the ground in the chamber, 3 meter away from the antenna. The maximal emission value is acquired by adjusting the antenna height, polarisation and turntable azimuth. Normally, the height range of antenna is 1 m to 4 m, the azimuth range of turntable is 0° to 360°, and the receive antenna has two polarizations Vertical (V) and Horizontal (H).
3. A log-periodic antenna or double-ridged waveguide horn antenna shall be substituted in place of the EUT. The log-periodic antenna will be driven by a signal generator and the level will be adjusted till the same power value on the spectrum analyzer or receiver. The level of the spurious emissions can be calculated through the level of the signal generator, cable loss, the gain of the substitution antenna and the reading of the spectrum analyzer or receiver.
4. The EUT is then put into continuously transmitting mode at its maximum power level during the test. Set Test Receiver or Spectrum RBW=1MHz, VBW=3MHz, And the maximum value of the receiver should be recorded as (Pr).
5. The EUT shall be replaced by a substitution antenna. In the chamber, an substitution antenna for the frequency band of interest is placed at the reference point of the chamber. An RF Signal source for the frequency band of interest is connected to the substitution antenna with a cable that has been constructed to not interfere with the radiation pattern of the antenna. A power (PMea) is applied to the input of the substitution antenna, and adjust the level of the signal generator output until the value of the receiver reach the previously recorded (Pr). The power of signal source (PMea) is recorded. The test should be performed by rotating the test item and adjusting the receiving antenna polarization.
6. A amplifier should be connected to the Signal Source output port. And the cable should be connect between the Amplifier and the Substitution Antenna. The cable loss (Pcl) ,the Substitution Antenna Gain (Ga) and the Amplifier Gain (PAg) should be recorded after test.
7. The measurement results are obtained as described below:

$$\text{Power(EIRP)} = \text{PMea} - \text{PAg} - \text{Pcl} + \text{Ga}$$
 The measurement results are amend as described below:

$$\text{Power(EIRP)} = \text{PMea} - \text{Pcl} + \text{Ga}$$
8. This value is EIRP since the measurement is calibrated using an antenna of known gain (2.15 dBi) and known input power. ERP can be calculated from EIRP by subtracting the gain of the dipole, $\text{ERP} = \text{EIRP} - 2.15\text{dBi}$.

Test setup

30MHz~~~ 1GHz

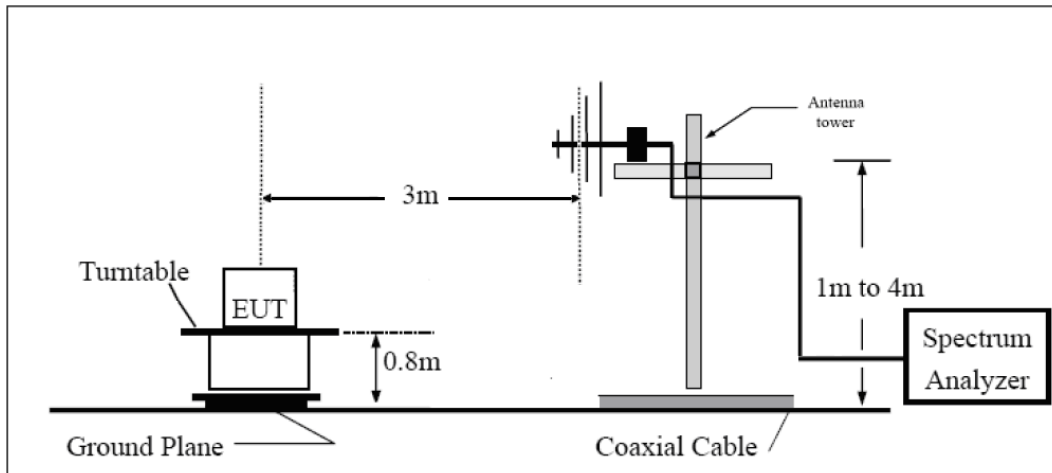

Above 1GHz

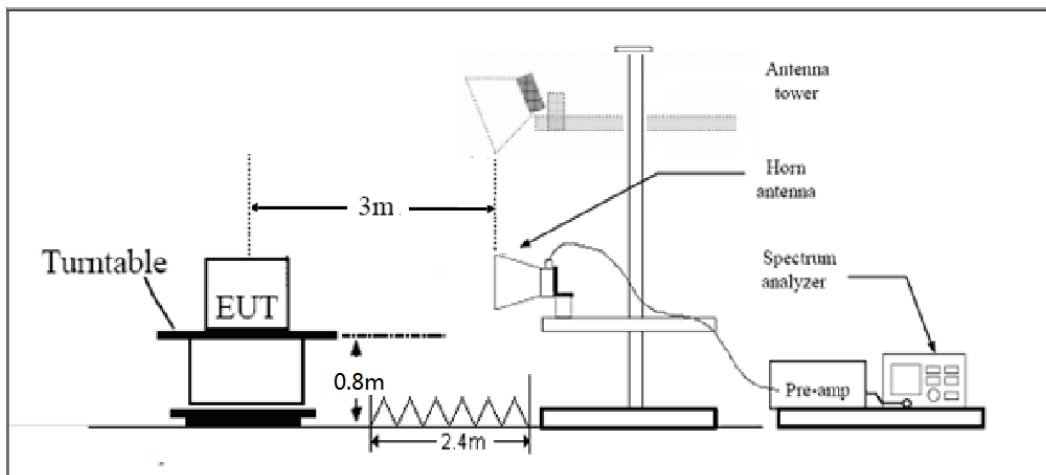

Note: Area side:2.4mX3.6m

The radiated emission was measured in the following position: EUT stand-up position (Z axis), lie-down position (X, Y axis). The worst emission was found in stand-up position (Z axis) and the worst case was recorded.

Limits

Rule Part 27.53(h) specifies that “for operations in the 1695-1710 MHz, 1710-1755 MHz, 1755-1780 MHz, 1915-1920 MHz, 1995-2000 MHz, 2000-2020 MHz, 2110-2155 MHz, 2155-2180 MHz, and 2180-2200 bands, the power of any emission outside a licensee's frequency block shall be attenuated below the transmitter power (P) in watts by at least $43 + 10 \log_{10} (P)$ dB..”

Rule Part 27.53 (g) For operations in the 600 MHz band and the 698-746 MHz band, the power of any emission outside a licensee's frequency band(s) of operation shall be attenuated below the transmitter power (P) within the licensed band(s) of operation, measured in watts, by at least $43 + 10 \log (P)$ dB. Compliance with this provision is based on the use of measurement instrumentation employing a resolution bandwidth of 100 kilohertz or greater. However, in the 100 kilohertz bands



immediately outside and adjacent to a licensee's frequency block, a resolution bandwidth of at least 30 kHz may be employed.

Rule Part 27.53(f) For operations in the 746-758 MHz, 775-788 MHz, and 805-806 MHz bands, emissions in the band 1559-1610 MHz shall be limited to -70 dBW/MHz equivalent isotropically radiated power (EIRP) for wideband signals, and -80 dBW EIRP for discrete emissions of less than 700 Hz bandwidth. For the purpose of equipment authorization, a transmitter shall be tested with an antenna that is representative of the type that will be used with the equipment in normal operation.

Part 27.53(h) Limit		-13 dBm
Part 27.53(f) Limit	Limit out of the band 1559-1610 MHz	-13 dBm
	Limit in the band 1559-1610 MHz	-40 dBm

Measurement Uncertainty

The assessed measurement uncertainty to ensure 95% confidence level for the normal distribution is with the coverage factor $k = \pm 1.96$, $U = \pm 3.55$ dB.

Test Result

LTE Band 4 QPSK 1.4MHz CH-Low, RB 1

Harmonic	Frequency (MHz)	SG (dBm)	Cable Loss (dB)	Gain (dBi)	Antenna Polarization	EIRP Level (dBm)	Limit (dBm)	Margin (dB)	Azimuth (deg)
2	3421.4	-29.75	2.6	10.15	Horizontal	-22.2	-13.0	9.2	45
3	5131.1	-37.95	2.4	11.35	Horizontal	-29.0	-13.0	16.0	90
4	6842.8	-46.15	4.5	10.85	Horizontal	-39.8	-13.0	26.8	45
5	8553.5	-47.45	5.1	11.35	Horizontal	-41.2	-13.0	28.2	270
6	10264.2	-45.55	5.3	11.95	Horizontal	-38.9	-13.0	25.9	90
7	11974.9	-46.25	5.5	13.55	Horizontal	-38.2	-13.0	25.2	225
8	13685.6	-43.45	6.3	13.75	Horizontal	-36.0	-13.0	23.0	180
9	15396.3	-46.55	6.7	13.85	Horizontal	-39.4	-13.0	26.4	90
10	17107.0	-42.35	6.8	14.25	Horizontal	-34.9	-13.0	21.9	45

Note: 1.The other Spurious RF Radiated emissions level is no more than noise floor.
2. The worst emission was found in the antenna is Horizontal position.

LTE Band 4 QPSK 1.4MHz CH-Middle, RB 1

Harmonic	Frequency (MHz)	SG (dBm)	Cable Loss (dB)	Gain (dBi)	Antenna Polarization	EIRP Level (dBm)	Limit (dBm)	Margin (dB)	Azimuth (deg)
2	3464.3	-28.45	2.6	10.75	Horizontal	-20.3	-13.0	7.3	180
3	5197.5	-42.15	2.4	11.05	Horizontal	-33.5	-13.0	20.5	225
4	6930.0	-47.85	4.5	11.15	Horizontal	-41.2	-13.0	28.2	45
5	8662.5	-47.45	5.1	11.35	Horizontal	-41.2	-13.0	28.2	90
6	10395.0	-44.95	5.3	11.95	Horizontal	-38.3	-13.0	25.3	45
7	12127.5	-46.65	5.5	13.55	Horizontal	-38.6	-13.0	25.6	180
8	13860.0	-43.85	6.3	13.75	Horizontal	-36.4	-13.0	23.4	135
9	15592.5	-44.45	6.7	13.85	Horizontal	-37.3	-13.0	24.3	90
10	17325.0	-44.35	6.8	14.25	Horizontal	-36.9	-13.0	23.9	225

Note: 1.The other Spurious RF Radiated emissions level is no more than noise floor.
2. The worst emission was found in the antenna is Horizontal position.

LTE Band 4 QPSK 1.4MHz CH-High, RB 1

Harmonic	Frequency (MHz)	SG (dBm)	Cable Loss (dB)	Gain (dBi)	Antenna Polarization	EIRP Level (dBm)	Limit (dBm)	Margin (dB)	Azimuth (deg)
2	3507.8	-26.95	2.6	10.15	Horizontal	-19.4	-13.0	6.4	0
3	5261.6	-39.95	2.4	11.05	Horizontal	-31.3	-13.0	18.3	45
4	7017.2	-49.85	4.5	11.15	Horizontal	-43.2	-13.0	30.2	90
5	8771.5	-46.85	5.1	11.35	Horizontal	-40.6	-13.0	27.6	90
6	10525.8	-44.35	5.3	11.95	Horizontal	-37.7	-13.0	24.7	225
7	12280.1	-46.95	5.5	13.55	Horizontal	-38.9	-13.0	25.9	135
8	14034.4	-44.25	6.3	13.75	Horizontal	-36.8	-13.0	23.8	270
9	15788.7	-44.85	6.7	13.85	Horizontal	-37.7	-13.0	24.7	0
10	17543.0	-44.45	6.8	14.25	Horizontal	-37.0	-13.0	24.0	45

Note: 1.The other Spurious RF Radiated emissions level is no more than noise floor.
2. The worst emission was found in the antenna is Horizontal position.

LTE Band 4 QPSK 3MHz CH-Low, RB 1

Harmonic	Frequency (MHz)	SG (dBm)	Cable Loss (dB)	Gain (dBi)	Antenna Polarization	EIRP Level (dBm)	Limit (dBm)	Margin (dB)	Azimuth (deg)
2	3423.0	-29.55	2.6	10.15	Horizontal	-22.0	-13.0	9.0	270
3	5134.5	-38.25	2.4	11.35	Horizontal	-29.3	-13.0	16.3	180
4	6846.0	-44.95	4.5	10.85	Horizontal	-38.6	-13.0	25.6	225
5	8557.5	-48.85	5.1	11.35	Horizontal	-42.6	-13.0	29.6	45
6	10269.0	-46.25	5.3	11.95	Horizontal	-39.6	-13.0	26.6	90
7	11980.5	-47.45	5.5	13.55	Horizontal	-39.4	-13.0	26.4	180
8	13692.0	-44.65	6.3	13.75	Horizontal	-37.2	-13.0	24.2	270
9	15403.5	-45.35	6.7	13.85	Horizontal	-38.2	-13.0	25.2	135
10	17115.0	-43.65	6.8	14.25	Horizontal	-36.2	-13.0	23.2	180

Note: 1.The other Spurious RF Radiated emissions level is no more than noise floor.
2. The worst emission was found in the antenna is Horizontal position.

LTE Band 4 QPSK 3MHz CH-Middle, RB 1

Harmonic	Frequency (MHz)	SG (dBm)	Cable Loss (dB)	Gain (dBi)	Antenna Polarization	EIRP Level (dBm)	Limit (dBm)	Margin (dB)	Azimuth (deg)
2	3465.0	-27.85	2.6	10.75	Horizontal	-19.7	-13.0	6.7	0
3	5197.5	-38.75	2.4	11.05	Horizontal	-30.1	-13.0	17.1	180
4	6930.0	-46.95	4.5	11.15	Horizontal	-40.3	-13.0	27.3	45
5	8662.5	-47.95	5.1	11.35	Horizontal	-41.7	-13.0	28.7	45
6	10395.0	-46.35	5.3	11.95	Horizontal	-39.7	-13.0	26.7	180
7	12127.5	-46.55	5.5	13.55	Horizontal	-38.5	-13.0	25.5	225
8	13860.0	-42.75	6.3	13.75	Horizontal	-35.3	-13.0	22.3	180
9	15592.5	-46.65	6.7	13.85	Horizontal	-39.5	-13.0	26.5	90
10	17325.0	-43.25	6.8	14.25	Horizontal	-35.8	-13.0	22.8	0

Note: 1.The other Spurious RF Radiated emissions level is no more than noise floor.
2. The worst emission was found in the antenna is Horizontal position.

LTE Band 4 QPSK 3MHz CH-High, RB 1

Harmonic	Frequency (MHz)	SG (dBm)	Cable Loss (dB)	Gain (dBi)	Antenna Polarization	EIRP Level (dBm)	Limit (dBm)	Margin (dB)	Azimuth (deg)
2	3504.8	-26.65	2.6	10.15	Horizontal	-19.1	-13.0	6.1	180
3	5256.8	-39.95	2.4	11.05	Horizontal	-31.3	-13.0	18.3	180
4	7014.0	-51.45	4.5	11.15	Horizontal	-44.8	-13.0	31.8	225
5	8767.5	-48.05	5.1	11.35	Horizontal	-41.8	-13.0	28.8	90
6	10521.0	-46.05	5.3	11.95	Horizontal	-39.4	-13.0	26.4	90
7	12274.5	-47.25	5.5	13.55	Horizontal	-39.2	-13.0	26.2	45
8	14028.0	-44.35	6.3	13.75	Horizontal	-36.9	-13.0	23.9	270
9	15781.5	-45.85	6.7	13.85	Horizontal	-38.7	-13.0	25.7	90
10	17535.0	-44.55	6.8	14.25	Horizontal	-37.1	-13.0	24.1	180

Note: 1.The other Spurious RF Radiated emissions level is no more than noise floor.
2. The worst emission was found in the antenna is Horizontal position.



LTE Band 4 QPSK 5MHz CH-Low, RB 1

Harmonic	Frequency (MHz)	SG (dBm)	Cable Loss (dB)	Gain (dBi)	Antenna Polarization	EIRP Level (dBm)	Limit (dBm)	Margin (dB)	Azimuth (deg)
2	3425.0	-28.55	2.6	10.15	Horizontal	-21.0	-13.0	8.0	45
3	5131.1	-38.45	2.4	11.35	Horizontal	-29.5	-13.0	16.5	90
4	6850.0	-47.15	4.5	10.85	Horizontal	-40.8	-13.0	27.8	135
5	8562.5	-48.25	5.1	11.35	Horizontal	-42.0	-13.0	29.0	45
6	10275.0	-47.05	5.3	11.95	Horizontal	-40.4	-13.0	27.4	180
7	11987.5	-47.35	5.5	13.55	Horizontal	-39.3	-13.0	26.3	45
8	13700.0	-45.05	6.3	13.75	Horizontal	-37.6	-13.0	24.6	225
9	15412.5	-46.45	6.7	13.85	Horizontal	-39.3	-13.0	26.3	270
10	17125.0	-44.55	6.8	14.25	Horizontal	-37.1	-13.0	24.1	90

Note: 1.The other Spurious RF Radiated emissions level is no more than noise floor.
2. The worst emission was found in the antenna is Horizontal position.

LTE Band 4 QPSK 5MHz CH-Middle, RB 1

Harmonic	Frequency (MHz)	SG (dBm)	Cable Loss (dB)	Gain (dBi)	Antenna Polarization	EIRP Level (dBm)	Limit (dBm)	Margin (dB)	Azimuth (deg)
2	3460.5	-26.95	2.6	10.75	Horizontal	-18.8	-13.0	5.8	45
3	5191.5	-38.65	2.4	11.05	Horizontal	-30.0	-13.0	17.0	180
4	6930.0	-45.35	4.5	11.15	Horizontal	-38.7	-13.0	25.7	90
5	8662.5	-47.55	5.1	11.35	Horizontal	-41.3	-13.0	28.3	0
6	10395.0	-45.95	5.3	11.95	Horizontal	-39.3	-13.0	26.3	225
7	12127.5	-46.95	5.5	13.55	Horizontal	-38.9	-13.0	25.9	180
8	13860.0	-44.15	6.3	13.75	Horizontal	-36.7	-13.0	23.7	90
9	15592.5	-46.65	6.7	13.85	Horizontal	-39.5	-13.0	26.5	90
10	17325.0	-43.15	6.8	14.25	Horizontal	-35.7	-13.0	22.7	180

Note: 1.The other Spurious RF Radiated emissions level is no more than noise floor.
2. The worst emission was found in the antenna is Horizontal position.

LTE Band 4 QPSK 5MHz CH-High, RB 1

Harmonic	Frequency (MHz)	SG (dBm)	Cable Loss (dB)	Gain (dBi)	Antenna Polarization	EIRP Level (dBm)	Limit (dBm)	Margin (dB)	Azimuth (deg)
2	3500.6	-26.45	2.6	10.15	Horizontal	-18.9	-13.0	5.9	45
3	5250.8	-39.95	2.4	11.05	Horizontal	-31.3	-13.0	18.3	45
4	7010.0	-50.75	4.5	11.15	Horizontal	-44.1	-13.0	31.1	135
5	8762.5	-47.85	5.1	11.35	Horizontal	-41.6	-13.0	28.6	180
6	10515.0	-45.35	5.3	11.95	Horizontal	-38.7	-13.0	25.7	225
7	12267.5	-46.05	5.5	13.55	Horizontal	-38.0	-13.0	25.0	45
8	14020.0	-44.35	6.3	13.75	Horizontal	-36.9	-13.0	23.9	90
9	15772.5	-45.35	6.7	13.85	Horizontal	-38.2	-13.0	25.2	270
10	17525.0	-44.05	6.8	14.25	Horizontal	-36.6	-13.0	23.6	180

Note: 1.The other Spurious RF Radiated emissions level is no more than noise floor.
2. The worst emission was found in the antenna is Horizontal position.

LTE Band 4 QPSK 10MHz CH-Low, RB 1

Harmonic	Frequency (MHz)	SG (dBm)	Cable Loss (dB)	Gain (dBi)	Antenna Polarization	EIRP Level (dBm)	Limit (dBm)	Margin (dB)	Azimuth (deg)
2	3420.8	-30.05	2.6	10.15	Horizontal	-22.5	-13.0	9.5	315
3	5131.9	-38.45	2.4	11.35	Horizontal	-29.5	-13.0	16.5	45
4	6860.0	-49.75	4.5	10.85	Horizontal	-43.4	-13.0	30.4	225
5	8575.0	-48.95	5.1	11.35	Horizontal	-42.7	-13.0	29.7	90
6	10290.0	-47.05	5.3	11.95	Horizontal	-40.4	-13.0	27.4	0
7	12005.0	-47.75	5.5	13.55	Horizontal	-39.7	-13.0	26.7	225
8	13720.0	-44.75	6.3	13.75	Horizontal	-37.3	-13.0	24.3	45
9	15435.0	-46.15	6.7	13.85	Horizontal	-39.0	-13.0	26.0	225
10	17150.0	-44.75	6.8	14.25	Horizontal	-37.3	-13.0	24.3	45

Note: 1.The other Spurious RF Radiated emissions level is no more than noise floor.
2. The worst emission was found in the antenna is Horizontal position.

LTE Band 4 QPSK 10MHz CH-Middle, RB 1

Harmonic	Frequency (MHz)	SG (dBm)	Cable Loss (dB)	Gain (dBi)	Antenna Polarization	EIRP Level (dBm)	Limit (dBm)	Margin (dB)	Azimuth (deg)
2	3456.0	-29.05	2.6	10.75	Horizontal	-20.9	-13.0	7.9	45
3	5184.4	-38.45	2.4	11.05	Horizontal	-29.8	-13.0	16.8	180
4	6930.0	-46.95	4.5	11.15	Horizontal	-40.3	-13.0	27.3	270
5	8662.5	-47.35	5.1	11.35	Horizontal	-41.1	-13.0	28.1	180
6	10395.0	-46.25	5.3	11.95	Horizontal	-39.6	-13.0	26.6	225
7	12127.5	-46.45	5.5	13.55	Horizontal	-38.4	-13.0	25.4	45
8	13860.0	-44.15	6.3	13.75	Horizontal	-36.7	-13.0	23.7	90
9	15592.5	-48.05	6.7	13.85	Horizontal	-40.9	-13.0	27.9	180
10	17325.0	-44.85	6.8	14.25	Horizontal	-37.4	-13.0	24.4	135

Note: 1.The other Spurious RF Radiated emissions level is no more than noise floor.
2. The worst emission was found in the antenna is Horizontal position.

LTE Band 4 QPSK 10MHz CH-High, RB 1

Harmonic	Frequency (MHz)	SG (dBm)	Cable Loss (dB)	Gain (dBi)	Antenna Polarization	EIRP Level (dBm)	Limit (dBm)	Margin (dB)	Azimuth (deg)
2	3490.9	-28.75	2.6	10.15	Horizontal	-21.2	-13.0	8.2	45
3	5236.9	-39.25	2.4	11.05	Horizontal	-30.6	-13.0	17.6	180
4	7000.0	-51.65	4.5	11.15	Horizontal	-45.0	-13.0	32.0	225
5	8750.0	-48.25	5.1	11.35	Horizontal	-42.0	-13.0	29.0	90
6	10500.0	-45.55	5.3	11.95	Horizontal	-38.9	-13.0	25.9	90
7	12250.0	-46.95	5.5	13.55	Horizontal	-38.9	-13.0	25.9	180
8	14000.0	-44.25	6.3	13.75	Horizontal	-36.8	-13.0	23.8	270
9	15750.0	-44.85	6.7	13.85	Horizontal	-37.7	-13.0	24.7	45
10	17500.0	-43.65	6.8	14.25	Horizontal	-36.2	-13.0	23.2	135

Note: 1.The other Spurious RF Radiated emissions level is no more than noise floor.
2. The worst emission was found in the antenna is Horizontal position.

LTE Band 4 QPSK 15MHz CH Low, RB 1

Harmonic	Frequency (MHz)	SG (dBm)	Cable Loss (dB)	Gain (dBi)	Antenna Polarization	EIRP Level (dBm)	Limit (dBm)	Margin (dB)	Azimuth (deg)
2	3448.1	-38.75	2.6	10.15	Horizontal	-31.2	-13.0	18.2	45
3	5132.6	-44.95	2.4	11.35	Horizontal	-36.0	-13.0	23.0	180
4	6870.0	-50.75	4.5	10.85	Horizontal	-44.4	-13.0	31.4	90
5	8587.5	-47.25	5.1	11.35	Horizontal	-41.0	-13.0	28.0	45
6	10305.0	-45.65	5.3	11.95	Horizontal	-39.0	-13.0	26.0	90
7	12022.5	-46.45	5.5	13.55	Horizontal	-38.4	-13.0	25.4	225
8	13740.0	-43.25	6.3	13.75	Horizontal	-35.8	-13.0	22.8	45
9	15457.5	-46.85	6.7	13.85	Horizontal	-39.7	-13.0	26.7	90
10	17175.0	-43.25	6.8	14.25	Horizontal	-35.8	-13.0	22.8	225

Note: 1.The other Spurious RF Radiated emissions level is no more than noise floor.
2. The worst emission was found in the antenna is Horizontal position.

LTE Band 4 QPSK 15MHz CH-Middle, RB 1

Harmonic	Frequency (MHz)	SG (dBm)	Cable Loss (dB)	Gain (dBi)	Antenna Polarization	EIRP Level (dBm)	Limit (dBm)	Margin (dB)	Azimuth (deg)
2	3478.1	-39.75	2.6	10.75	Horizontal	-31.6	-13.0	18.6	45
3	5217.8	-45.95	2.4	11.05	Horizontal	-37.3	-13.0	24.3	180
4	6930.0	-52.05	4.5	11.15	Horizontal	-45.4	-13.0	32.4	90
5	8662.5	-46.25	5.1	11.35	Horizontal	-40.0	-13.0	27.0	180
6	10395.0	-44.65	5.3	11.95	Horizontal	-38.0	-13.0	25.0	270
7	12127.5	-47.45	5.5	13.55	Horizontal	-39.4	-13.0	26.4	180
8	13860.0	-44.25	6.3	13.75	Horizontal	-36.8	-13.0	23.8	135
9	15592.5	-45.85	6.7	13.85	Horizontal	-38.7	-13.0	25.7	45
10	17325.0	-43.35	6.8	14.25	Horizontal	-35.9	-13.0	22.9	90

Note: 1.The other Spurious RF Radiated emissions level is no more than noise floor.
2. The worst emission was found in the antenna is Horizontal position.



LTE Band 4 QPSK 15MHz CH-High, RB 1

Harmonic	Frequency (MHz)	SG (dBm)	Cable Loss (dB)	Gain (dBi)	Antenna Polarization	EIRP Level (dBm)	Limit (dBm)	Margin (dB)	Azimuth (deg)
2	3508.1	-41.75	2.6	10.15	Horizontal	-34.2	-13.0	21.2	90
3	5262.8	-48.45	2.4	11.05	Horizontal	-39.8	-13.0	26.8	180
4	6990.0	-51.15	4.5	11.15	Horizontal	-44.5	-13.0	31.5	180
5	8737.5	-48.75	5.1	11.35	Horizontal	-42.5	-13.0	29.5	90
6	10485.0	-47.85	5.3	11.95	Horizontal	-41.2	-13.0	28.2	90
7	12232.5	-47.25	5.5	13.55	Horizontal	-39.2	-13.0	26.2	45
8	13980.0	-45.75	6.3	13.75	Horizontal	-38.3	-13.0	25.3	225
9	15727.5	-46.45	6.7	13.85	Horizontal	-39.3	-13.0	26.3	0
10	17475.0	-45.05	6.8	14.25	Horizontal	-37.6	-13.0	24.6	180

Note: 1.The other Spurious RF Radiated emissions level is no more than noise floor.
2. The worst emission was found in the antenna is Horizontal position.

LTE Band 4 QPSK 20MHz CH-Low, RB 1

Harmonic	Frequency (MHz)	SG (dBm)	Cable Loss (dB)	Gain (dBi)	Antenna Polarization	EIRP Level (dBm)	Limit (dBm)	Margin (dB)	Azimuth (deg)
2	3421.9	-37.85	2.6	10.15	Horizontal	-30.3	-13.0	17.3	45
3	5133.0	-44.95	2.4	11.35	Horizontal	-36.0	-13.0	23.0	180
4	6880.0	-50.25	4.5	10.85	Horizontal	-43.9	-13.0	30.9	45
5	8600.0	-47.85	5.1	11.35	Horizontal	-41.6	-13.0	28.6	90
6	10320.0	-45.35	5.3	11.95	Horizontal	-38.7	-13.0	25.7	90
7	12040.0	-45.95	5.5	13.55	Horizontal	-37.9	-13.0	24.9	135
8	13760.0	-42.05	6.3	13.75	Horizontal	-34.6	-13.0	21.6	225
9	15480.0	-43.85	6.7	13.85	Horizontal	-36.7	-13.0	23.7	135
10	17200.0	-45.05	6.8	14.25	Horizontal	-37.6	-13.0	24.6	90

Note: 1.The other Spurious RF Radiated emissions level is no more than noise floor.
2. The worst emission was found in the antenna is Horizontal position.

LTE Band 4 QPSK 20MHz CH-Middle, RB 1

Harmonic	Frequency (MHz)	SG (dBm)	Cable Loss (dB)	Gain (dBi)	Antenna Polarization	EIRP Level (dBm)	Limit (dBm)	Margin (dB)	Azimuth (deg)
2	3447.0	-39.55	2.6	10.75	Horizontal	-31.4	-13.0	18.4	45
3	5170.5	-46.05	2.4	11.05	Horizontal	-37.4	-13.0	24.4	180
4	6930.0	-47.55	4.5	11.15	Horizontal	-40.9	-13.0	27.9	90
5	8662.5	-48.95	5.1	11.35	Horizontal	-42.7	-13.0	29.7	225
6	10395.0	-45.25	5.3	11.95	Horizontal	-38.6	-13.0	25.6	0
7	12127.5	-46.35	5.5	13.55	Horizontal	-38.3	-13.0	25.3	45
8	13860.0	-42.75	6.3	13.75	Horizontal	-35.3	-13.0	22.3	225
9	15592.5	-45.35	6.7	13.85	Horizontal	-38.2	-13.0	25.2	90
10	17325.0	-41.65	6.8	14.25	Horizontal	-34.2	-13.0	21.2	90

Note: 1.The other Spurious RF Radiated emissions level is no more than noise floor.

2. The worst emission was found in the antenna is Horizontal position.

LTE Band 4 QPSK 20MHz CH-High, RB 1

Harmonic	Frequency (MHz)	SG (dBm)	Cable Loss (dB)	Gain (dBi)	Antenna Polarization	EIRP Level (dBm)	Limit (dBm)	Margin (dB)	Azimuth (deg)
2	3472.1	-39.85	2.6	10.15	Horizontal	-32.3	-13.0	19.3	45
3	5208.4	-47.25	2.4	11.05	Horizontal	-38.6	-13.0	25.6	180
4	6980.0	-44.15	4.5	11.15	Horizontal	-37.5	-13.0	24.5	45
5	8725.0	35.05	5.1	11.35	Horizontal	-41.3	-13.0	28.3	0
6	10470.0	31.85	5.3	11.95	Horizontal	-38.5	-13.0	25.5	225
7	12215.0	30.55	5.5	13.55	Horizontal	-38.6	-13.0	25.6	180
8	13960.0	29.85	6.3	13.75	Horizontal	-37.3	-13.0	24.3	45
9	15705.0	30.55	6.7	13.85	Horizontal	-37.7	-13.0	24.7	135
10	17450.0	-44.35	6.8	14.25	Horizontal	-36.9	-13.0	23.9	45

Note: 1.The other Spurious RF Radiated emissions level is no more than noise floor.

2. The worst emission was found in the antenna is Horizontal position.

LTE Band 13 QPSK 5MHz CH-Low, RB 1

Harmonic	Frequency (MHz)	SG (dBm)	Cable Loss (dB)	Gain (dBi)	Antenna Polarization	ERP Level (dBm)	Limit (dBm)	Margin (dB)	Azimuth (deg)
2	1554.4	-47.10	2.00	10.15	Horizontal	-41.1	-13.0	28.1	0
3	2338.5	-57.50	2.50	11.35	Horizontal	-50.8	-13.0	37.8	315
4	3118.0	-55.00	4.20	10.85	Horizontal	-50.5	-13.0	37.5	225
5	3897.5	-51.00	5.20	11.35	Horizontal	-47.0	-13.0	34.0	135
6	4677.0	-51.80	5.50	11.95	Horizontal	-47.5	-13.0	34.5	0
7	5456.5	-52.60	5.70	13.55	Horizontal	-46.9	-13.0	33.9	180
8	6236.0	-50.20	6.30	13.75	Horizontal	-44.9	-13.0	31.9	45
9	7015.5	-49.40	6.80	13.85	Horizontal	-44.5	-13.0	31.5	180
10	7795.0	-46.60	6.90	14.25	Horizontal	-41.4	-13.0	28.4	45

Note: 1.The other Spurious RF Radiated emissions level is no more than noise floor.
2. The worst emission was found in the antenna is Horizontal position.

LTE Band 13 QPSK 5MHz CH-Middle, RB 1

Harmonic	Frequency (MHz)	SG (dBm)	Cable Loss (dB)	Gain (dBi)	Antenna Polarization	ERP Level (dBm)	Limit (dBm)	Margin (dB)	Azimuth (deg)
2	1559.6	-47.60	2.00	10.75	Horizontal	-41.0	-40.0	1.0	0
3	2346.0	-58.89	2.51	11.05	Horizontal	-52.5	-13.0	39.5	225
4	3128.0	-54.10	4.20	11.15	Horizontal	-49.3	-13.0	36.3	90
5	3910.0	-47.10	5.20	11.15	Horizontal	-43.3	-13.0	30.3	90
6	4692.0	-51.30	5.50	11.95	Horizontal	-47.0	-13.0	34.0	135
7	5474.0	-54.40	5.70	13.55	Horizontal	-48.7	-13.0	35.7	225
8	6256.0	-51.10	6.30	13.75	Horizontal	-45.8	-13.0	32.8	135
9	7038.0	-47.60	6.80	13.85	Horizontal	-42.7	-13.0	29.7	0
10	7820.0	-47.00	6.90	14.25	Horizontal	-41.8	-13.0	28.8	180

Note: 1.The other Spurious RF Radiated emissions level is no more than noise floor.
2. The worst emission was found in the antenna is Horizontal position.

LTE Band 13 QPSK 5MHz CH-High, RB 1

Harmonic	Frequency (MHz)	SG (dBm)	Cable Loss (dB)	Gain (dBi)	Antenna Polarization	ERP Level (dBm)	Limit (dBm)	Margin (dB)	Azimuth (deg)
2	1564.7	-47.10	2.00	10.15	Horizontal	-41.1	-40.0	1.1	0
3	2353.5	-57.89	2.51	11.05	Horizontal	-51.5	-13.0	38.5	225
4	3138.0	-54.40	4.20	11.15	Horizontal	-49.6	-13.0	36.6	45
5	3922.5	-46.80	5.20	11.15	Horizontal	-43.0	-13.0	30.0	180
6	4707.0	-52.30	5.50	11.95	Horizontal	-48.0	-13.0	35.0	45
7	5491.5	-53.10	5.70	13.55	Horizontal	-47.4	-13.0	34.4	90
8	6276.0	-52.40	6.30	13.75	Horizontal	-47.1	-13.0	34.1	90
9	7060.5	-48.60	6.80	13.85	Horizontal	-43.7	-13.0	30.7	135
10	7845.0	-46.50	6.90	14.25	Horizontal	-41.3	-13.0	28.3	225

Note: 1.The other Spurious RF Radiated emissions level is no more than noise floor.
2. The worst emission was found in the antenna is Horizontal position.

LTE Band 13 QPSK 10MHz CH-Low, RB 1

Harmonic	Frequency (MHz)	SG (dBm)	Cable Loss (dB)	Gain (dBi)	Antenna Polarization	ERP Level (dBm)	Limit (dBm)	Margin (dB)	Azimuth (deg)
2	1555.1	-47.10	2.00	10.15	Horizontal	-41.1	-13.0	28.1	0
3	2346.0	-58.79	2.51	11.35	Horizontal	-52.1	-13.0	39.1	135
4	3128.0	-55.00	4.20	10.85	Horizontal	-50.5	-13.0	37.5	0
5	3910.0	-53.10	5.20	11.35	Horizontal	-49.1	-13.0	36.1	180
6	4692.0	-52.00	5.50	11.95	Horizontal	-47.7	-13.0	34.7	45
7	5474.0	-52.80	5.70	13.55	Horizontal	-47.1	-13.0	34.1	180
8	6256.0	-50.70	6.30	13.75	Horizontal	-45.4	-13.0	32.4	45
9	7038.0	-48.20	6.80	13.85	Horizontal	-43.3	-13.0	30.3	90
10	7820.0	-46.60	6.90	14.25	Horizontal	-41.4	-13.0	28.4	0

Note: 1.The other Spurious RF Radiated emissions level is no more than noise floor.
2. The worst emission was found in the antenna is Horizontal position.

LTE Band 13 QPSK 10MHz CH-Middle, RB 1

Harmonic	Frequency (MHz)	SG (dBm)	Cable Loss (dB)	Gain (dBi)	Antenna Polarization	ERP Level (dBm)	Limit (dBm)	Margin (dB)	Azimuth (deg)
2	1555.1	-47.60	2.00	10.75	Horizontal	-41.0	-13.0	28.0	0
3	2346.0	-58.49	2.51	11.05	Horizontal	-52.1	-13.0	39.1	135
4	3128.0	-55.30	4.20	11.15	Horizontal	-50.5	-13.0	37.5	180
5	3910.0	-52.80	5.20	11.15	Horizontal	-49.0	-13.0	36.0	45
6	4692.0	-52.00	5.50	11.95	Horizontal	-47.7	-13.0	34.7	180
7	5474.0	-52.80	5.70	13.55	Horizontal	-47.1	-13.0	34.1	45
8	6256.0	-50.80	6.30	13.75	Horizontal	-45.5	-13.0	32.5	90
9	7038.0	-48.30	6.80	13.85	Horizontal	-43.4	-13.0	30.4	90
10	7820.0	-46.60	6.90	14.25	Horizontal	-41.4	-13.0	28.4	135

Note: 1.The other Spurious RF Radiated emissions level is no more than noise floor.
2. The worst emission was found in the antenna is Horizontal position.

LTE Band 13 QPSK 10MHz CH-High, RB 1

Harmonic	Frequency (MHz)	SG (dBm)	Cable Loss (dB)	Gain (dBi)	Antenna Polarization	ERP Level (dBm)	Limit (dBm)	Margin (dB)	Azimuth (deg)
2	1555.1	-47.00	2.00	10.15	Horizontal	-41.0	-13.0	28.0	0
3	2346.0	-58.49	2.51	11.05	Horizontal	-52.1	-13.0	39.1	135
4	3128.0	-55.30	4.20	11.15	Horizontal	-50.5	-13.0	37.5	225
5	3910.0	-52.80	5.20	11.15	Horizontal	-49.0	-13.0	36.0	135
6	4692.0	-52.00	5.50	11.95	Horizontal	-47.7	-13.0	34.7	90
7	5474.0	-53.30	5.70	13.55	Horizontal	-47.6	-13.0	34.6	45
8	6256.0	-50.80	6.30	13.75	Horizontal	-45.5	-13.0	32.5	180
9	7038.0	-48.10	6.80	13.85	Horizontal	-43.2	-13.0	30.2	90
10	7820.0	-46.50	6.90	14.25	Horizontal	-41.3	-13.0	28.3	225

Note: 1.The other Spurious RF Radiated emissions level is no more than noise floor.
2. The worst emission was found in the antenna is Horizontal position.

6 Main Test Instruments

Name	Manufacturer	Type	Serial Number	Calibration Date	Expiration Date
Base Station Simulator	R&S	CMW500	113645	2017-05-14	2018-05-13
Power Splitter	Hua Xiang	SHX-GF2-2-13	10120101	2017-05-14	2018-05-13
Spectrum Analyzer	Agilent	N9010A	MY47191109	2017-05-14	2018-05-13
Signal Analyzer	R&S	FSV30	100815	2016-12-16	2017-12-15
Signal generator	R&S	SMB 100A	102594	2017-05-14	2018-05-13
EMI Test Receiver	R&S	ESCI	100948	2017-05-20	2018-05-19
TRILOG Broadband Antenna	Schwarzbeck	VULB 9163	9163-201	2014-12-06	2017-12-05
TRILOG Broadband Antenna	SCHWARZBECK	VUBL 9163	9163-201	2017-11-18	2020-11-17
Horn Antenna	R&S	HF907	100126	2014-12-06	2019-12-05
Horn Antenna	ETS-Lindgren	3160-09	00102643	2015-01-30	2018-01-29
Climatic Chamber	Re Ce	PT-30B	20101891	2015-07-18	2018-07-17
RF Cable	Agilent	SMA 15cm	0001	2017-08-04	2018-02-03
Preampfier	R&S	SCU18	102327	2017-06-18	2018-06-17
Software	R&S	EMC32	V 8.52.0	NA	NA