



RF TEST REPORT

Applicant UAB Teltonika
FCC ID 2AET4RUT240V
Product LTE Router
Brand Teltonika
Model RUT240
Report No. RXA1708-0301RF02R1
Issue Date December 20, 2017

TA Technology (Shanghai) Co., Ltd. tested the above equipment in accordance with the requirements in **FCC CFR47 Part 15C (2017)**. The test results show that the equipment tested is capable of demonstrating compliance with the requirements as documented in this report.

Performed by: Xianqing Li

Approved by: Kai Xu

TA Technology (Shanghai) Co., Ltd.

No.145, Jintang Rd, Tangzhen Industry Park, Pudong Shanghai, China

TEL: +86-021-50791141/2/3

FAX: +86-021-50791141/2/3-8000



TABLE OF CONTENT

1. Test Laboratory	4
1.1. Notes of the test report.....	4
1.2. Test facility	4
1.3. Testing Location.....	5
2. General Description of Equipment under Test.....	6
3. Applied Standards	7
4. Test Configuration	8
5. Test Case Results	9
5.1. Average Power Output –Conducted.....	9
5.2. 6dB Bandwidth	11
5.3. Band Edge	15
5.4. Power Spectral Density	17
5.5. Spurious RF Conducted Emissions.....	21
5.6. Radiated Emissions in the Restricted Band	27
5.7. Radiates Emission	32
5.8. Conducted Emission	60
6. Main Test Instruments.....	62
ANNEX A: EUT Appearance and Test Setup	63
A.1 EUT Appearance	63
A.2 Test Setup	64



Summary of measurement results

Number	Summary of measurements of results	Clause in FCC rules	Verdict
1	Maximum Average conducted output power	15.247(b)(3)	PASS
2	6 dB bandwidth	15.247(a)(2)	PASS
3	Power spectral density	15.247(e)	PASS
4	Band Edge	15.247(d)	PASS
5	Spurious RF Conducted Emissions	15.247(d)	PASS
6	Radiated Emissions in restricted frequency bands	15.247(d),15.205,15.209	PASS
7	Radiated Emissions	15.247(d),15.205,15.209	PASS
8	Conducted Emissions	15.207	PASS
Date of Testing: November 5, 2017~ November 29, 2017			



1. Test Laboratory

1.1. Notes of the test report

This report shall not be reproduced in full or partial, without the written approval of **TA technology (shanghai) co., Ltd.** The results documented in this report apply only to the tested sample, under the conditions and modes of operation as described herein .Measurement Uncertainties were not taken into account and are published for informational purposes only. This report is written to support regulatory compliance of the applicable standards stated above.

1.2. Test facility

CNAS (accreditation number: L2264)

TA Technology (Shanghai) Co., Ltd. has obtained the accreditation of China National Accreditation Service for Conformity Assessment (CNAS).

FCC (Designation number: CN1179, Test Firm Registration Number: 446626)

TA Technology (Shanghai) Co., Ltd. has been listed on the US Federal Communications Commission list of test facilities recognized to perform electromagnetic emissions measurements.

IC (recognition number is 8510A)

TA Technology (Shanghai) Co., Ltd. has been listed by industry Canada to perform electromagnetic emission measurement.

VCCI (recognition number is C-4595, T-2154, R-4113, G-10766)

TA Technology (Shanghai) Co., Ltd. has been listed by industry Japan to perform electromagnetic emission measurement.

A2LA (Certificate Number: 3857.01)

TA Technology (Shanghai) Co., Ltd. has been listed by American Association for Laboratory Accreditation to perform electromagnetic emission measurement.



1.3. Testing Location

Company: TA Technology (Shanghai) Co., Ltd.
Address: No.145, Jintang Rd, Tangzhen Industry Park, Pudong
City: Shanghai
Post code: 201201
Country: P. R. China
Contact: Xu Kai
Telephone: +86-021-50791141/2/3
Fax: +86-021-50791141/2/3-8000
Website: <http://www.ta-shanghai.com>
E-mail: xukai@ta-shanghai.com

2. General Description of Equipment under Test

Client Information

Applicant	UAB TELTONIKA
Applicant address	Saltoniskiu st. 10c, Vilnius, Lithuania
Manufacturer	UAB TELTONIKA
Manufacturer address	Saltoniskiu st. 10c, Vilnius, Lithuania

General information

EUT Description	
Model	RUT240
IMEI	861107031948582
Hardware Version	5
Software Version	RUT2XX_R_00.00.284
Power Supply	Adapter
Antenna Type	Sub or Retractable Antenna
Antenna Gain	5.00dBi
additional beamforming gain	0 dB
Test Mode	802.11b, 802.11g, 802.11n(HT20/HT40);
Modulation Type	802.11b: DSSS; 802.11g/n(HT20/HT40): OFDM
Max. Conducted Power	Wi-Fi 2.4G :8.96dBm
Operating Frequency Range(s)	802.11b/g/n(HT20): 2412 ~ 2462 MHz 802.11n(HT40): 2422 ~ 2452 MHz
EUT Accessory	
Adapter	Manufacturer: Shenzhen Shengji Mains CO., LTD Model: SJ-09010033
LTE antenna	Manufacturer: Beyondoor Model: BY-LTE-03-03-Silkscreen-LTE
WiFi antenna	Manufacturer: Beyondoor Model: BY-2400-05-05-01-Silkscreen-WiFi
Note: The information of the EUT is declared by the manufacturer.	



3. Applied Standards

According to the specifications of the manufacturer, it must comply with the requirements of the following standards:

Test standards

- **FCC CFR47 Part 15C (2017) Radio Frequency Devices**
- **ANSI C63.10 (2013)**
- **KDB 558074 D01 DTS Meas Guidance v04**

4. Test Configuration

Test Mode

The EUT has been associated with peripherals and configuration operated in a manner tended to maximize its emission characteristics in a typical application.

The radiated emission was measured in the following position: EUT stand-up position (Z axis), lie-down position (X, Y axis). The worst emission was found in lie-down position (X axis) and the worst case was recorded.

In order to find the worst case condition, Pre-tests are needed at the presence of different data rate. Preliminary tests have been done on all the configuration for confirming worst case. Data rate below means worst-case rate of each test item.

Worst-case data rates are shown as following table.

Band	Data Rate
802.11b	1 Mbps
802.11g	6 Mbps
802.11n HT20	MCS0
802.11n HT40	MCS0

5. Test Case Results

5.1. Average Power Output –Conducted

Ambient condition

Temperature	Relative humidity	Pressure
23°C ~25°C	45%~50%	101.5kPa

Methods of Measurement

During the process of the testing, The EUT was connected to Spectrum Analyzer with a known loss. The EUT is max power transmission with proper modulation. The Average detector is used. We use Maximum Average Conducted Output Power Level Method in KDB 558074 D01 for this test.

Test Setup

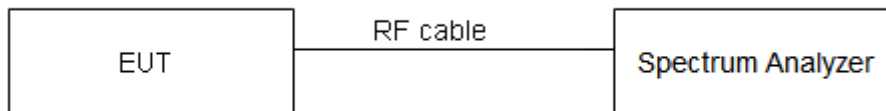

Limits

Rule Part 15.247 (b) (3) specifies that " For systems using digital modulation in the 902–928 MHz, 2400–2483.5 MHz: 1 Watt."

Average Output Power	$\leq 1W$ (30dBm)
----------------------	-------------------

Measurement Uncertainty

The assessed measurement uncertainty to ensure 95% confidence level for the normal distribution is with the coverage factor $k = 2$, $U = 0.44$ dB.



Test Results

Note: all measurement were performed with the EUT transmitting continuously (with the duty cycle of greater than 98%) , so duty cycle correction Factor is not required.

Network Standards	Carrier frequency (MHz)	Read Value (dBm)	Average Output Power (dBm)	Limit (dBm)	Conclusion
802.11b	2412	8.51	8.51	30	PASS
	2437	8.32	8.32	30	PASS
	2462	7.73	7.73	30	PASS
802.11g	2412	8.74	8.74	30	PASS
	2437	8.87	8.87	30	PASS
	2462	8.22	8.22	30	PASS
802.11n HT20	2412	8.96	8.96	30	PASS
	2437	8.76	8.76	30	PASS
	2462	8.50	8.50	30	PASS
802.11n HT40	2422	8.73	8.73	30	PASS
	2437	8.81	8.81	30	PASS
	2452	8.50	8.50	30	PASS

Note: Output Power= Read Value +Duty cycle correction factor

5.2. 6dB Bandwidth

Ambient condition

Temperature	Relative humidity	Pressure
23°C ~25°C	45%~50%	101.5kPa

Method of Measurement

The EUT was connected to the spectrum analyzer through an external attenuator (20dB) and a known loss cable. RBW is set to 100 kHz; VBW is set to 300 kHz on spectrum analyzer.

Test Setup

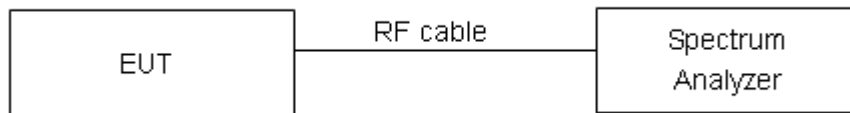

Limits

Rule Part 15.247 (a) (2) specifies that “Systems using digital modulation techniques may operate in the 902–928 MHz, 2400–2483.5 MHz bands. The minimum 6 dB bandwidth shall be at least 500 kHz.”

minimum 6 dB bandwidth	≥ 500 kHz
------------------------	-----------

Measurement Uncertainty

The assessed measurement uncertainty to ensure 95% confidence level for the normal distribution is with the coverage factor $k = 2$, $U = 936$ Hz.

**Test Results:**

Network Standards	Carrier frequency (MHz)	99% bandwidth (MHz)	Minimum 6 dB bandwidth (MHz)	Limit (kHz)	Conclusion
802.11b	2412	11.836	7.104	500	PASS
	2437	11.778	7.095	500	PASS
	2462	11.665	7.106	500	PASS
802.11g	2412	16.449	16.56	500	PASS
	2437	16.457	16.56	500	PASS
	2462	16.448	16.58	500	PASS
802.11n HT20	2412	17.652	17.80	500	PASS
	2437	17.638	17.77	500	PASS
	2462	17.636	17.81	500	PASS
802.11n HT40	2422	35.925	36.38	500	PASS
	2437	35.919	36.40	500	PASS
	2452	35.894	36.34	500	PASS

802.11b, Carrier frequency (MHz): 2412



802.11g, Carrier frequency (MHz): 2412



802.11b, Carrier frequency (MHz): 2437



802.11g, Carrier frequency (MHz): 2437



802.11b, Carrier frequency (MHz): 2462



802.11g, Carrier frequency (MHz): 2462





802.11n(HT20), Carrier frequency (MHz): 2412



802.11n(HT40), Carrier frequency (MHz): 2422



802.11n(HT20), Carrier frequency (MHz): 2437



802.11n(HT40), Carrier frequency (MHz): 2437



802.11n(HT20), Carrier frequency (MHz):2462



802.11n(HT40), Carrier frequency (MHz):2452



5.3. Band Edge

Ambient condition

Temperature	Relative humidity	Pressure
23°C ~25°C	45%~50%	101.5kPa

Method of Measurement

The EUT was connected to the spectrum analyzer through an external attenuator (20dB) and a known loss cable the band edge of the lowest and highest channels were measured. The peak detector is used and RBW is set to 100 kHz and VBW is set to 300 kHz on spectrum analyzer. Spectrum analyzer plots are included on the following pages.

Test Setup

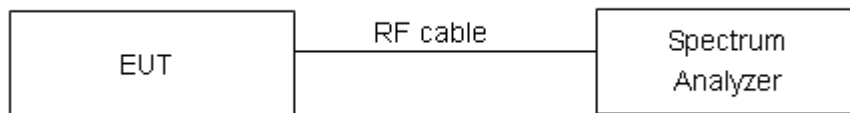

Limits

Rule Part 15.247(d) specifies that “In any 100 kHz bandwidth outside the frequency band in which the spread spectrum or digitally modulated intentional radiator is operating, the radio frequency power that is produced by the intentional radiator shall be at least 20 dB below that in the 100 kHz bandwidth within the band that contains the highest level of the desired power, based on either an RF conducted or a radiated measurement, provided the transmitter demonstrates compliance with the peak conducted power limits.”

Measurement Uncertainty

The assessed measurement uncertainty to ensure 95% confidence level for the normal distribution is with the coverage factor $k = 1.96$.

Frequency	Uncertainty
2GHz-3GHz	1.407 dB



Test Results: PASS

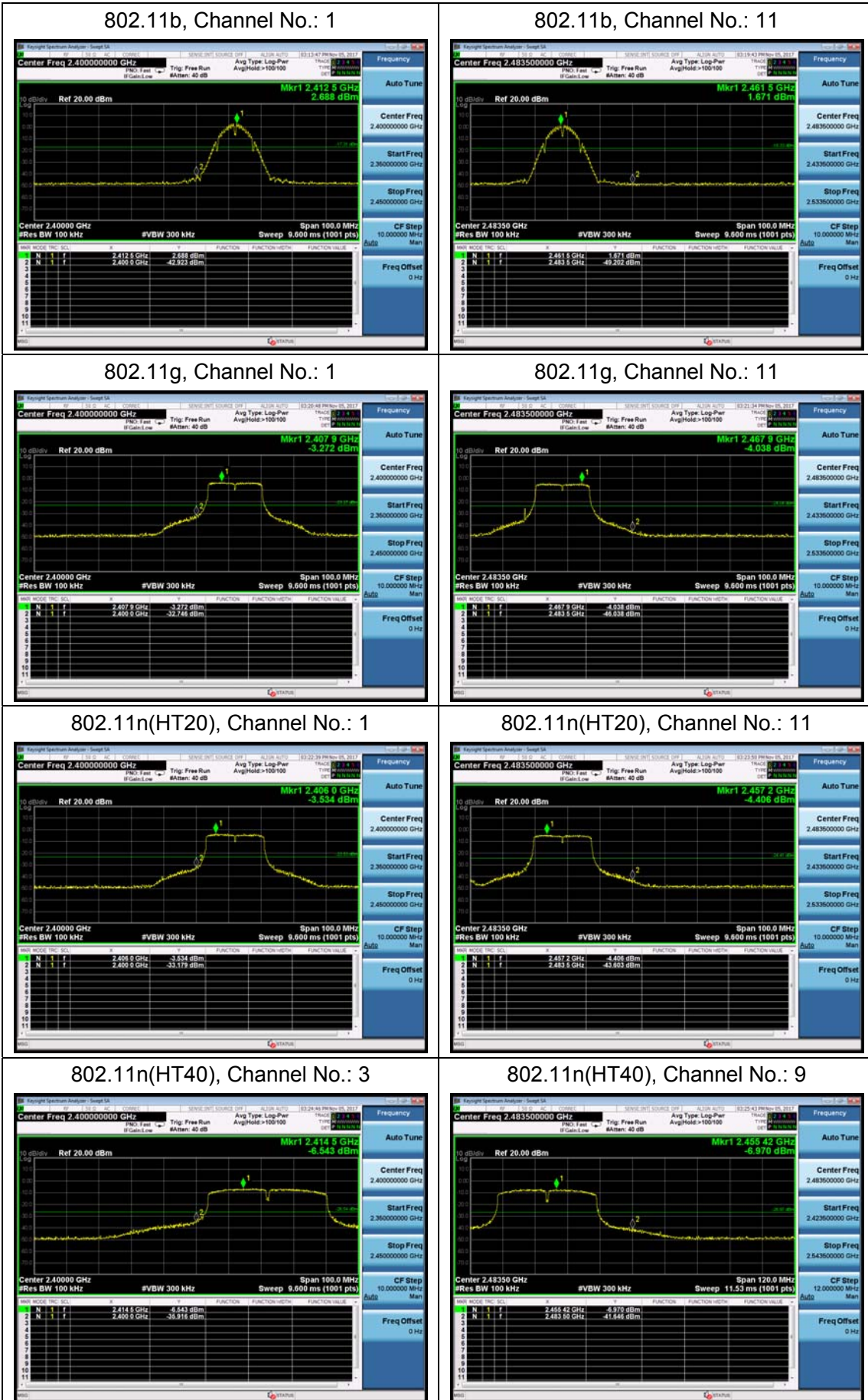

5.4. Power Spectral Density

Ambient condition

Temperature	Relative humidity	Pressure
23°C ~25°C	45%~50%	101.5kPa

Method of Measurement

The EUT was connected to the spectrum analyzer through an external attenuator (20dB) and a known loss cable.

RBW is set to 3 kHz and VBW is set to 10 kHz for Wi-Fi 2.4G on spectrum analyzer.

Set the span to 1.5 times the DTS channel bandwidth. Sweep time = auto couple. Trace mode = max hold. The Average power spectral density is recorded.

Test setup

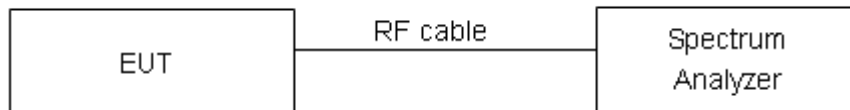

Limits

Rule Part 15.247(e) specifies that” For digitally modulated systems, the power spectral density conducted from the intentional radiator to the antenna shall not be greater than 8 dBm in any 3 kHz band during any time interval of continuous transmission. ”

Limits	≤ 8 dBm / 3kHz
--------	----------------

Measurement Uncertainty

The assessed measurement uncertainty to ensure 95% confidence level for the normal distribution is with the coverage factor $k = 2$, $U = 0.75\text{dB}$.

**Test Results:**

Note: all measurement were performed with the EUT transmitting continuously (with the duty cycle of greater than 98%) , so duty cycle correction Factor is not required.

Network Standards	Channel Number	Read Value (dBm)	Power Spectral Density (dBm / 3kHz)	Limit (dBm / 3kHz)	Conclusion
802.11b	1	-23.003	-23.003	8	PASS
	6	-23.894	-23.894	8	PASS
	11	-26.038	-26.038	8	PASS
802.11g	1	-26.492	-26.492	8	PASS
	6	-26.997	-26.997	8	PASS
	11	-27.306	-27.306	8	PASS
802.11n HT20	1	-27.539	-27.539	8	PASS
	6	-31.001	-31.001	8	PASS
	11	-27.967	-27.967	8	PASS
802.11n HT40	3	-30.174	-30.174	8	PASS
	6	-30.680	-30.680	8	PASS
	9	-30.609	-30.609	8	PASS
Note: Power Spectral Density =Read Value+Duty cycle correction factor					

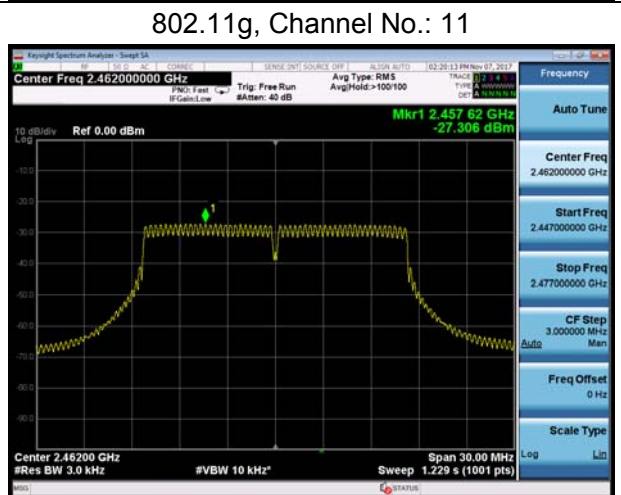
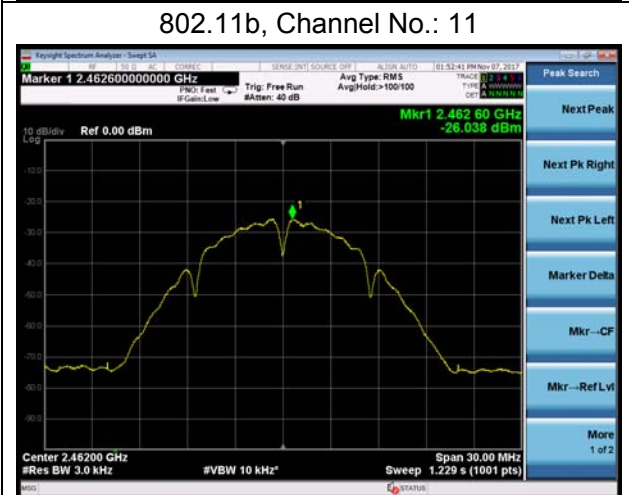
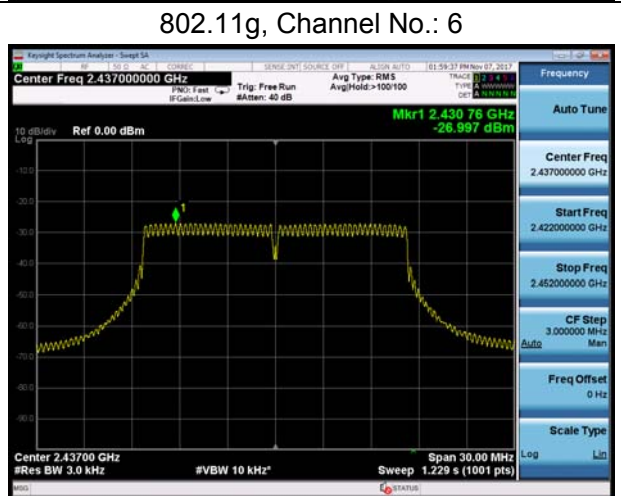
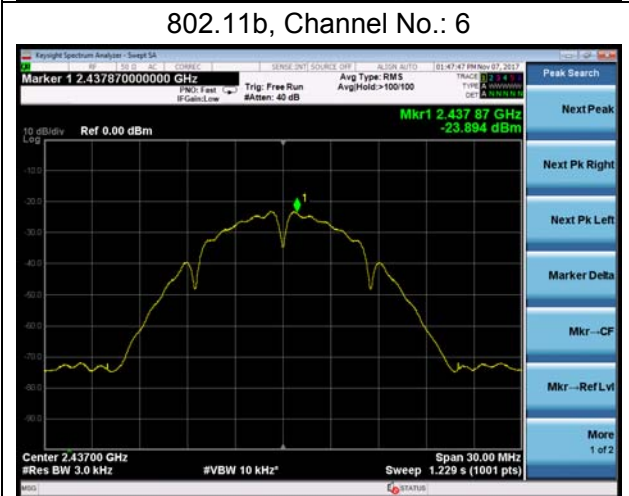
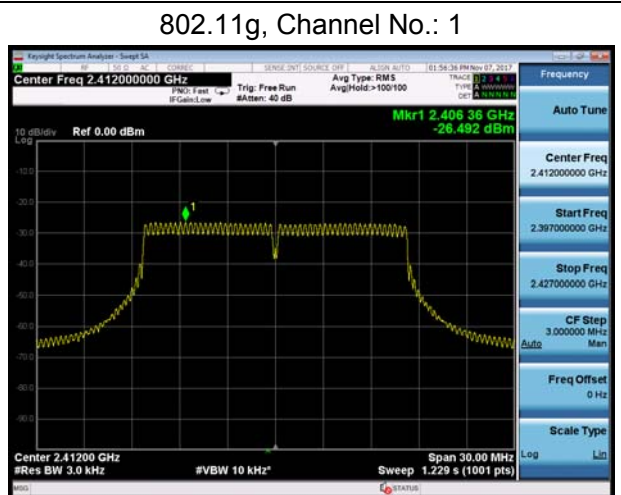



802.11n(HT20), Channel No. 1



802.11n(HT40), Channel No. 3

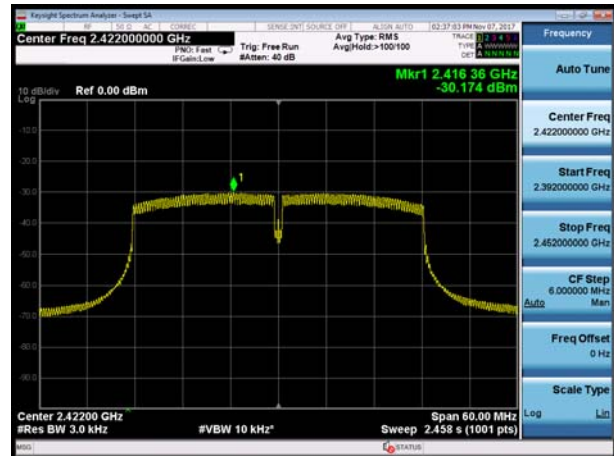

802.11n(HT20), Channel No. 6

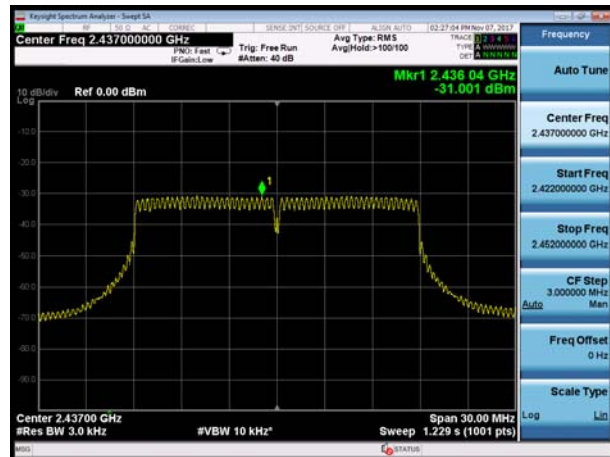

802.11n(HT40), Channel No. 6

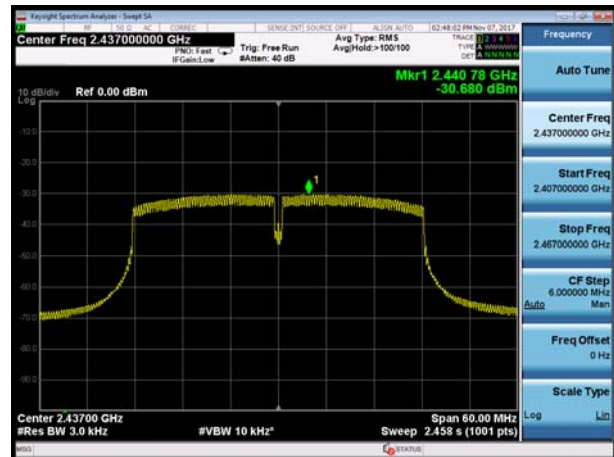

802.11n(HT20), Channel No. 11

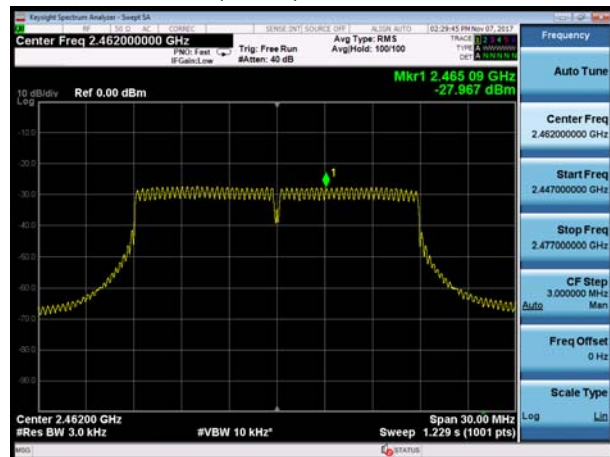

802.11n(HT40), Channel No. 9

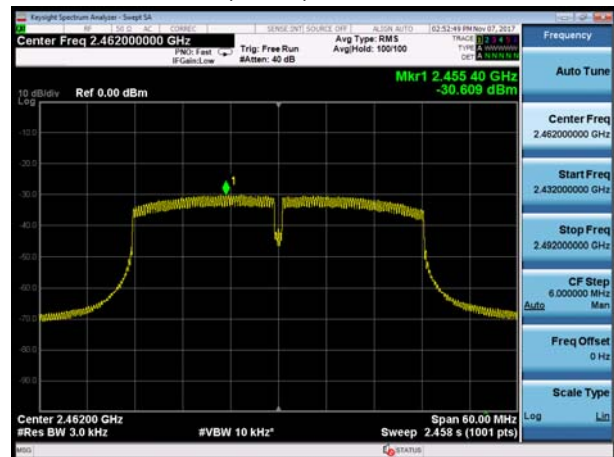

5.5. Spurious RF Conducted Emissions

Ambient condition

Temperature	Relative humidity	Pressure
23°C ~25°C	45%~50%	101.5kPa

Method of Measurement

The EUT was connected to the spectrum analyzer with a known loss. The spectrum analyzer scans from 30MHz to the 10th harmonic of the carrier. The peak detector is used. Set RBW to 100kHz and VBW to 300 kHz, Sweep is set to ATUO.

The test is in transmitting mode.

Test setup



Limits

Rule Part 15.247(d) pacifies that “In any 100 kHz bandwidth outside the frequency band in which the spread spectrum intentional radiator is operating, the radio frequency power that is produced by the intentional radiator shall be at least 20 dB below that in the 100 kHz bandwidth within the band that contains the highest level of the desired power.”

Network Standards	Carrier frequency (MHz)	Reference value (dBm)	Limit
802.11b	2412	-8.834	-28.834
	2437	-8.841	-28.841
	2462	-8.544	-28.544
802.11g	2412	-6.200	-26.200
	2437	-7.180	-27.180
	2462	-6.721	-26.721
802.11n HT20	2412	-7.615	-27.615
	2437	-6.572	-26.572
	2462	-7.382	-27.382
802.11n HT40	2422	-9.453	-29.453
	2437	-9.215	-29.215
	2452	-8.485	-28.485

Measurement Uncertainty

The assessed measurement uncertainty to ensure 95% confidence level for the normal distribution is with the coverage factor $k = 1.96$.



Frequency	Uncertainty
100kHz-2GHz	0.684 dB
2GHz-26GHz	1.407 dB



Test Results:

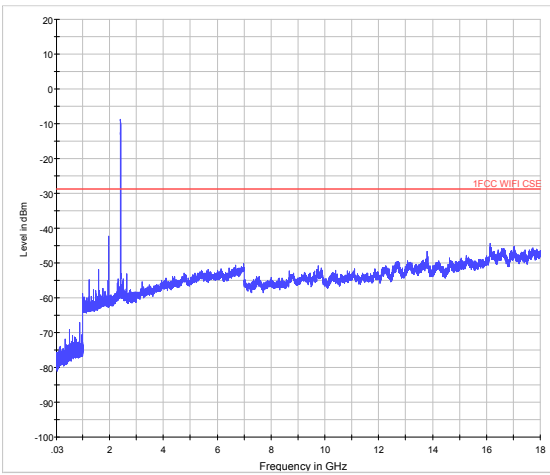

802.11b CH1 30MHz to 18GHz

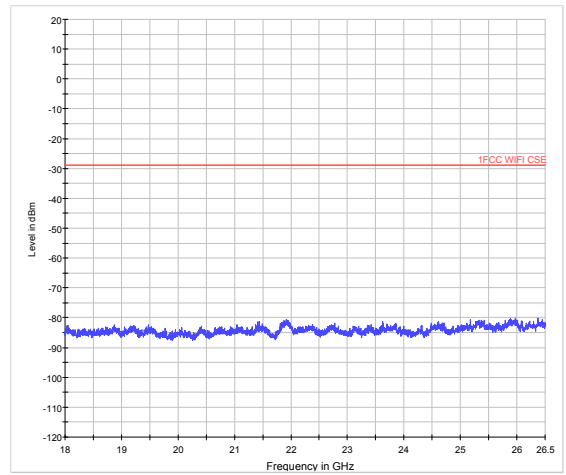

802.11b CH1 18GHz to 26.5GHz

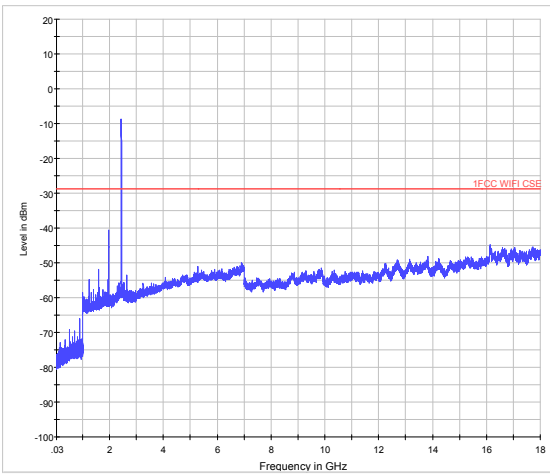

802.11b CH6 30MHz to 18GHz

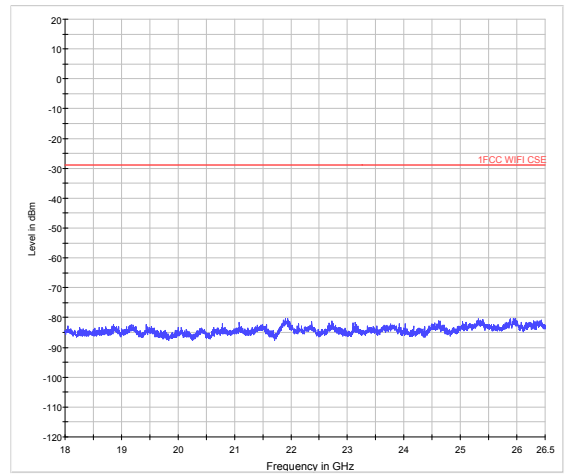

802.11b CH6 18GHz to 26.5GHz

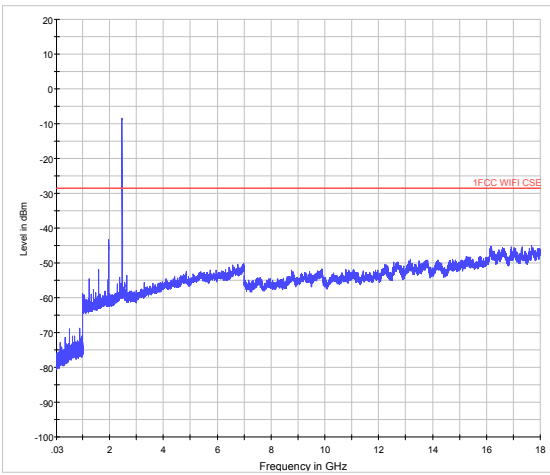

802.11b CH11 30MHz to 18GHz

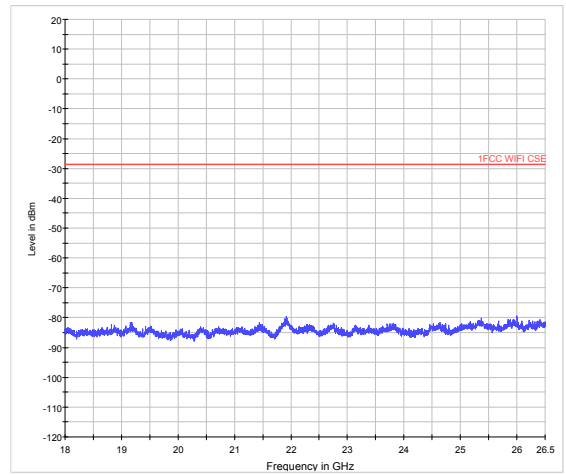

802.11b CH11 18GHz to 26.5GHz

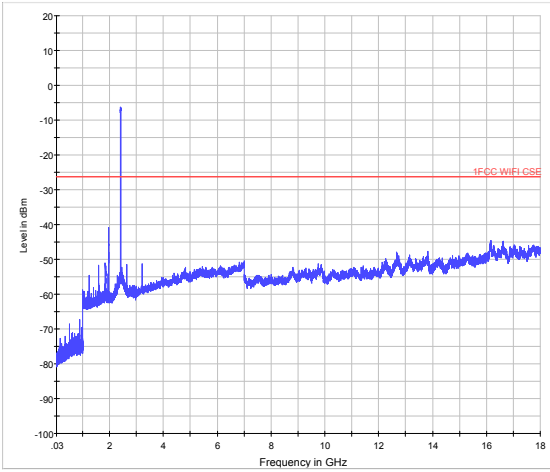

802.11g CH1 30MHz to 18GHz

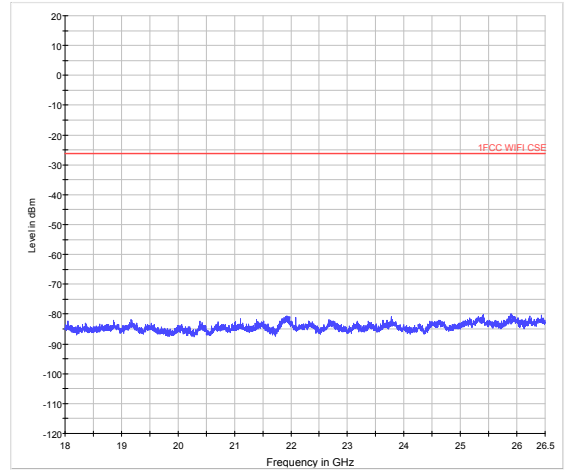

802.11g CH1 18GHz to 26.5GHz

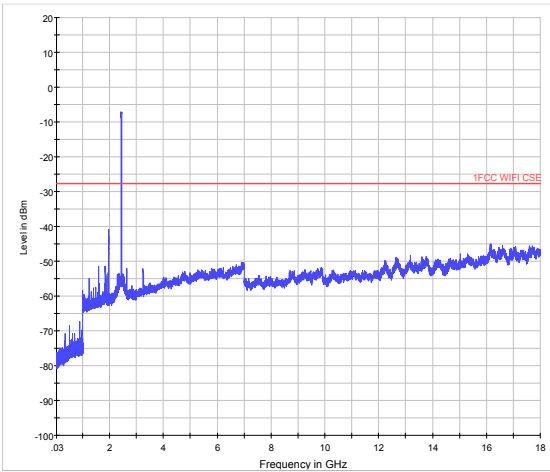

802.11g CH6 30MHz to 18GHz

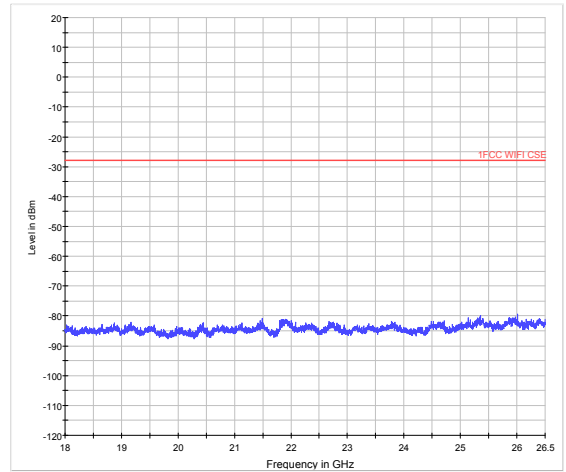

802.11g CH6 18GHz to 26.5GHz

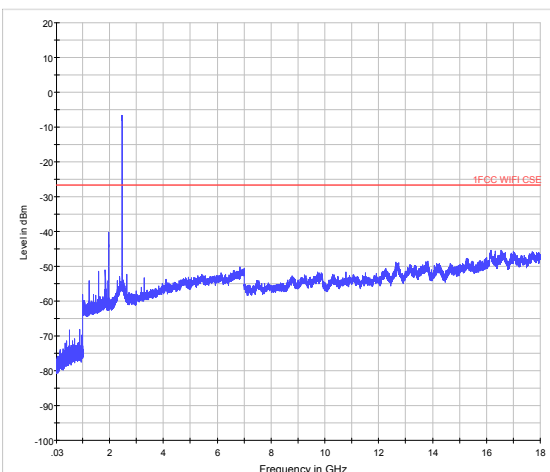

802.11g CH11 30MHz to 18GHz

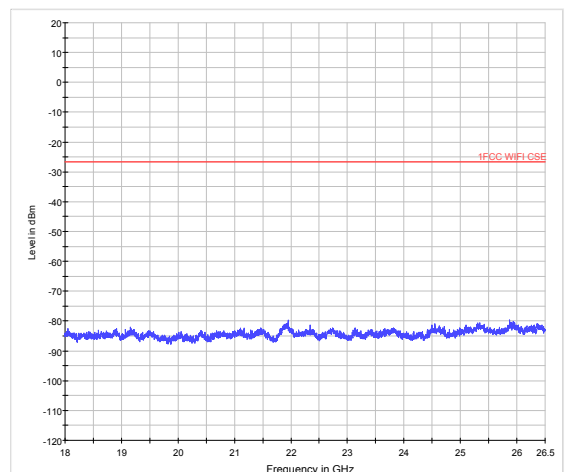

802.11g CH11 18GHz to 26.5GHz

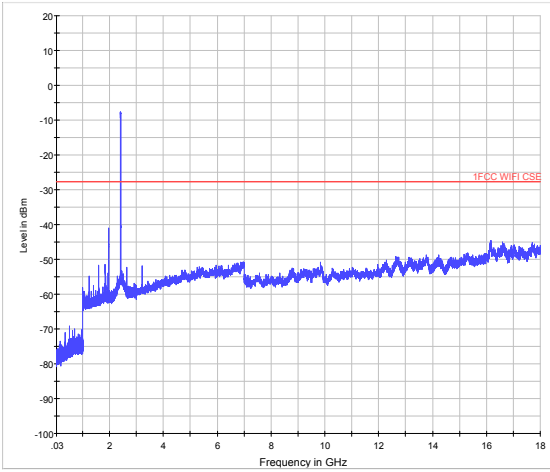

802.11n (HT20) CH1 30MHz to 18GHz

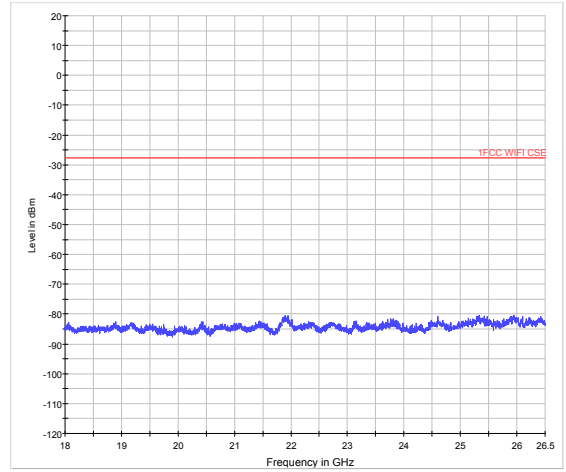

802.11n (HT20) CH1 18GHz to 26.5GHz

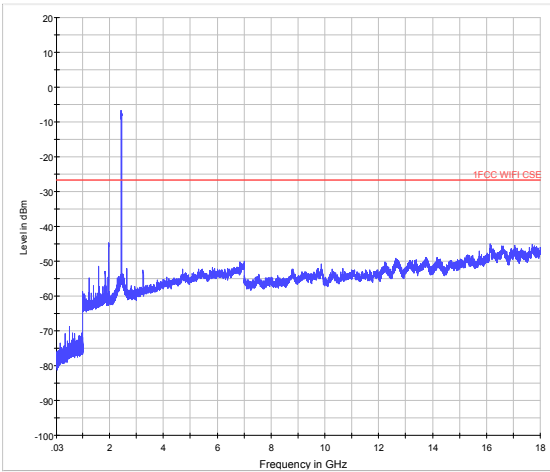

802.11n (HT20) CH6 30MHz to 18GHz

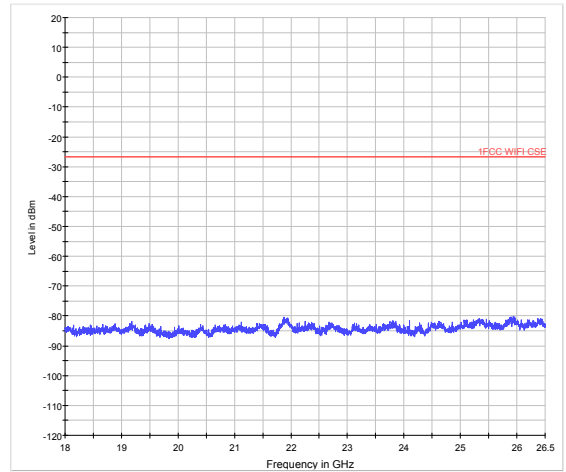

802.11n (HT20) CH6 18GHz to 26.5GHz

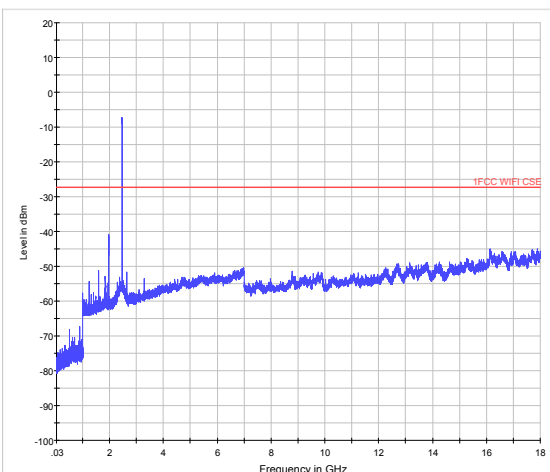

802.11n (HT20) CH11 30MHz to 18GHz

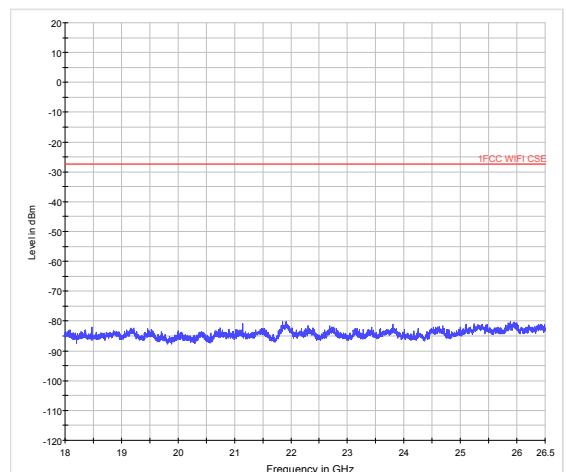

802.11n (HT20) CH11 18GHz to 26.5GHz

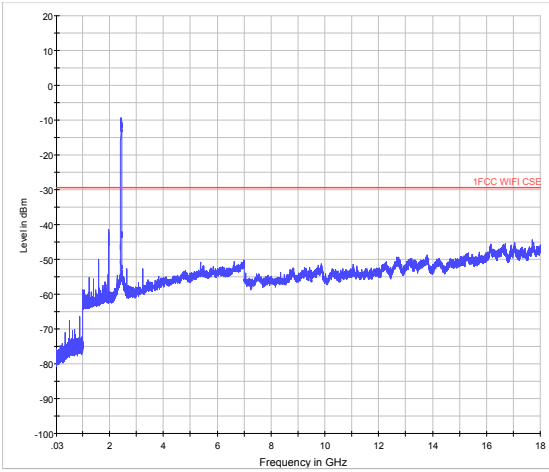

802.11n (HT40) CH3 30MHz to 18GHz

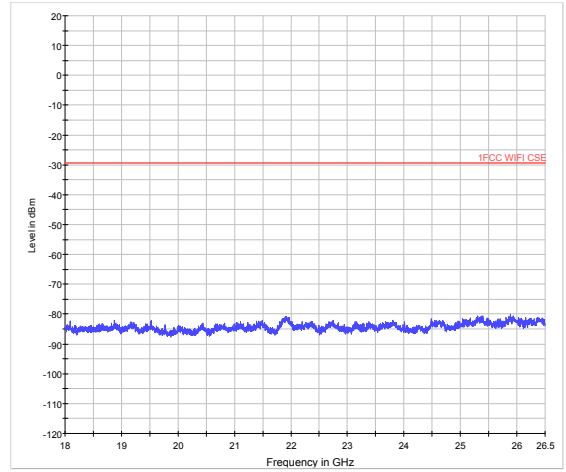

802.11n (HT40) CH3 18GHz to 26.5GHz

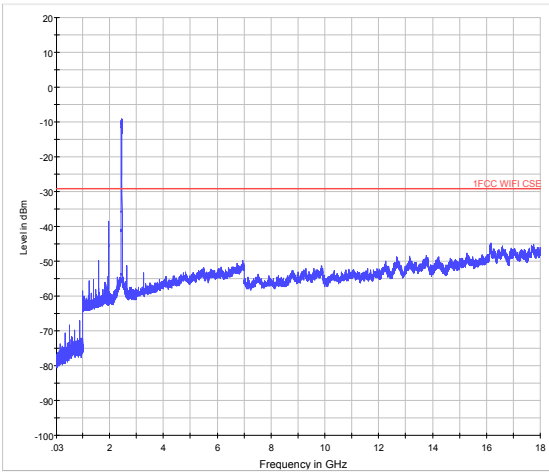

802.11n (HT40) CH6 30MHz to 18GHz

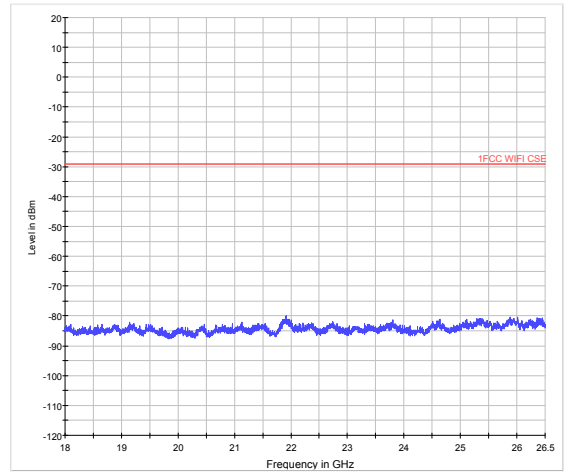

802.11n (HT40) CH6 18GHz to 26.5GHz

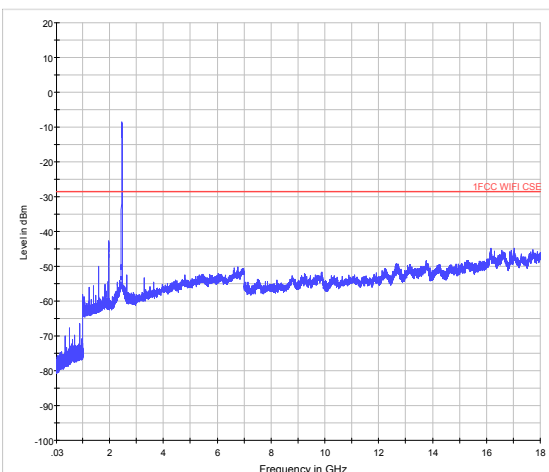

802.11n (HT40) CH9 30MHz to 18GHz

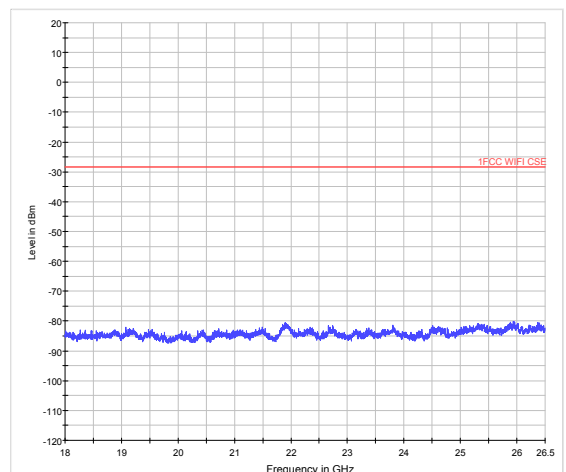

802.11n (HT40) CH9 18GHz to 26.5GHz

5.6. Radiated Emissions in the Restricted Band

Ambient condition

Temperature	Relative humidity	Pressure
23°C ~25°C	45%~50%	101.5kPa

Method of Measurement

The Equipment Under Test (EUT) was set up on a non-conductive table in the semi-anechoic chamber. The test was performed at the distance of 3 m between the EUT and the receiving antenna. The turntable shall be rotated from 0 to 360 degrees for detecting the maximum of radiated spurious signal level. The measurements shall be repeated with orthogonal polarization of the test antenna. The data of cable loss and antenna factor has been calibrated in full testing frequency range before the testing. Sweep the Restricted Band and the emissions less than 20 dB below the permissible value are reported.

This method refer to KDB 558074.

The procedure for peak unwanted emissions measurements above 1000 MHz is as follows:

I) Peak emission levels are measured by setting the instrument as follows:

- 1) RBW = 1 MHz.
- 2) VBW \geq [3 × RBW]
- 3) Detector = peak.
- 4) Sweep time = auto.
- 5) Trace mode = max hold.
- 6) Allow sweeps to continue until the trace stabilizes. Note that if the transmission is not continuous, then the time required for the trace to stabilize will increase by a factor of approximately 1 / D, where D is the duty cycle.

II) Average emission levels are measured by setting the instrument as follows:

- a) RBW = 1 MHz.
- b) VBW \geq [3 × RBW].
- c) Detector = RMS (power averaging), if [span / (# of points in sweep)] \leq RBW / 2. Satisfying this condition can require increasing the number of points in the sweep or reducing the span. If the condition is not satisfied, then the detector mode shall be set to peak.
- d) Averaging type = power (i.e., rms) (As an alternative, the detector and averaging type may be set for linear voltage averaging. Some instruments require linear display mode to use linear voltage averaging. Log or dB averaging shall not be used.)
- e) Sweep time = auto.
- f) Perform a trace average of at least 100 traces if the transmission is continuous. If the transmission is not continuous, then the number of traces shall be increased by a factor of 1 / D, where D is the duty cycle. For example, with 50% duty cycle, at least 200 traces shall be averaged. (If a specific emission is demonstrated to be continuous—i.e., 100% duty cycle—then rather than turning ON and OFF with the transmit cycle, at least 100 traces shall be averaged.)
- g) If tests are performed with the EUT transmitting at a duty cycle less than 98%, then a correction

factor shall be added to the measurement results prior to comparing with the emission limit, to compute the emission level that would have been measured had the test been performed at 100% duty cycle. The correction factor is computed as follows:

- 1) If power averaging (rms) mode was used in the preceding step e), then the correction factor is $[10 \log (1 / D)]$, where D is the duty cycle. For example, if the transmit duty cycle was 50%, then 3 dB shall be added to the measured emission levels.
- 2) If linear voltage averaging mode was used in the preceding step e), then the correction factor is $[20 \log (1 / D)]$, where D is the duty cycle. For example, if the transmit duty cycle was 50%, then 6 dB shall be added to the measured emission levels.
- 3) If a specific emission is demonstrated to be continuous (100% duty cycle) rather than turning ON and OFF with the transmit cycle, then no duty cycle correction is required for that emission.

The field strength of spurious emission was measured in the following position: EUT stand-up position (Z axis), lie-down position (X, Y axis). The worst emission was found in stand-up position (Z axis) and the antenna is vertical.

The test is in transmitting mode.

Test setup

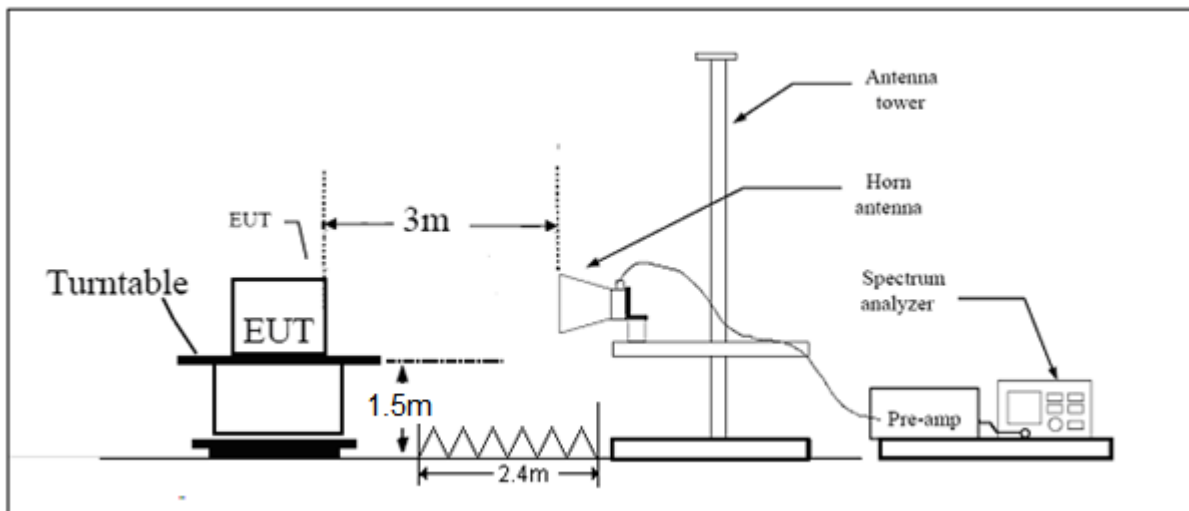

Note: Area side: 2.4mX3.6m

Limits

Spurious Radiated Emissions are permitted in any of the frequency bands listed below:



MHz	MHz	MHz	GHz
0.090 - 0.110	16.42 - 16.423	399.9 - 410	4.5 - 5.15
0.495 - 0.505	16.69475 - 16.69525	608 - 614	5.35 - 5.46
2.1735 - 2.1905	16.80425 - 16.80475	960 - 1240	7.25 - 7.75
4.125 - 4.128	25.5 - 25.67	1300 - 1427	8.025 - 8.5
4.17725 - 4.17775	37.5 - 38.25	1435 - 1626.5	9.0 - 9.2
4.20725 - 4.20775	73 - 74.6	1645.5 - 1646.5	9.3 - 9.5
6.215 - 6.218	74.8 - 75.2	1660 - 1710	10.6 - 12.7
6.26775 - 6.26825	108 - 121.94	1718.8 - 1722.2	13.25 - 13.4
6.31175 - 6.31225	123 - 138	2200 - 2300	14.47 - 14.5
8.291 - 8.294	149.9 - 150.05	2310 - 2390	15.35 - 16.2
8.362 - 8.366	156.52475 - 156.52525	2483.5 - 2500	17.7 - 21.4
8.37625 - 8.38675	156.7 - 156.9	2690 - 2900	22.01 - 23.12
8.41425 - 8.41475	162.0125 - 167.17	3260 - 3267	23.6 - 24.0
12.29 - 12.293	167.72 - 173.2	3332 - 3339	31.2 - 31.8
12.51975 - 12.52025	240 - 285	3345.8 - 3358	36.43 - 36.5
12.57675 - 12.57725	322 - 335.4	3600 - 4400	(²)
13.36 - 13.41			

Limit in restricted band

Frequency of emission (MHz)	Field strength(uV/m)	Field strength(dBuV/m)
30-88	100	40
88-216	150	43.5
216-960	200	46
Above960	500	54

§15.35(b)

There is also a limit on the radio frequency emissions, as measured using instrumentation with a peak detector function, corresponding to 20 dB above the maximum permitted average limit.

Peak Limit=74 dBuV/m

Average Limit=54 dBuV/m

Measurement Uncertainty

The assessed measurement uncertainty to ensure 95% confidence level for the normal distribution is with the coverage factor $k = 1.96$, $U = 3.55$ dB.

**Test Results:****PASS**

Note: all measurement were performed with the EUT transmitting continuously (with the duty cycle of greater than 98%) , so duty cycle correction Factor is not required.

802.11b-Channel 1

Frequency (MHz)	Peak (dBuV/m)	Average (dBuV/m)	Height (cm)	Polarization	Azimuth (deg)	Duty cycle correction Factor(dB)	conclusion value (dBuV/m)	Margin (dB)	Limit (dBuV/m)
2390	46.524	--	200.0	V	135	0	46.524	27.476	74
2390	--	32.069	200.0	V	135	0	32.069	21.931	54

802.11b-Channel 11

Frequency (MHz)	Peak (dBuV/m)	Average (dBuV/m)	Height (cm)	Polarization	Azimuth (deg)	Duty cycle correction Factor(dB)	conclusion value (dBuV/m)	Margin (dB)	Limit (dBuV/m)
2483.5	44.332	--	200.0	V	135	0	44.332	29.668	74
2483.5	--	31.590	200.0	V	135	0	31.590	22.410	54

802.11g-Channel 1

Frequency (MHz)	Peak (dBuV/m)	Average (dBuV/m)	Height (cm)	Polarization	Azimuth (deg)	Duty cycle correction Factor(dB)	conclusion value (dBuV/m)	Margin (dB)	Limit (dBuV/m)
2390	46.632	--	150	V	65	0	46.632	27.368	74
2390	--	32.099	150	V	65	0	32.099	21.901	54

802.11g-Channel 11

Frequency (MHz)	Peak (dBuV/m)	Average (dBuV/m)	Height (cm)	Polarization	Azimuth (deg)	Duty cycle correction Factor(dB)	conclusion value (dBuV/m)	Margin (dB)	Limit (dBuV/m)
2483.5	44.272	--	150	V	78	0	44.272	29.728	74
2483.5	--	32.266	150	V	78	0	32.266	21.734	54

**802.11n HT20-Channel 1**

Frequency (MHz)	Peak (dBuV/m)	Average (dBuV/m)	Height (cm)	Polarization	Azimuth (deg)	Duty cycle correction Factor(dB)	conclusion value (dBuV/m)	Margin (dB)	Limit (dBuV/m)
2390	47.053	--	200	V	90	0	47.053	26.947	74
2390	--	32.242	200	V	90	0	32.242	21.758	54

802.11n HT20-Channel 11

Frequency (MHz)	Peak (dBuV/m)	Average (dBuV/m)	Height (cm)	Polarization	Azimuth (deg)	Duty cycle correction Factor(dB)	conclusion value (dBuV/m)	Margin (dB)	Limit (dBuV/m)
2483.5	43.989	--	200	V	90	0	43.989	30.011	74
2483.5	--	31.894	200	V	90	0	31.894	22.106	54

802.11n HT40-Channel 3

Frequency (MHz)	Peak (dBuV/m)	Average (dBuV/m)	Height (cm)	Polarization	Azimuth (deg)	Duty cycle correction Factor(dB)	conclusion value (dBuV/m)	Margin (dB)	Limit (dBuV/m)
2390	46.756	--	150	V	46	0	46.756	27.244	74
2390	--	32.273	150	V	46	0	32.273	21.727	54

802.11n HT40-Channel 9

Frequency (MHz)	Peak (dBuV/m)	Average (dBuV/m)	Height (cm)	Polarization	Azimuth (deg)	Duty cycle correction Factor(dB)	conclusion value (dBuV/m)	Margin (dB)	Limit (dBuV/m)
2483.5	43.470	--	150	V	46	0	43.470	30.530	74
2483.5	--	31.859	150	V	46	0	31.859	22.141	54

5.7. Radiates Emission

Ambient condition

Temperature	Relative humidity	Pressure
23°C ~25°C	45%~50%	102.5kPa

Method of Measurement

The test set-up was made in accordance to the general provisions of ANSI C63.10-2013. The Equipment Under Test (EUT) was set up on a non-conductive table in the semi-anechoic chamber. The test was performed at the distance of 3 m between the EUT and the receiving antenna. The radiated emissions measurements were made in a typical installation configuration.

Sweep the whole frequency band through the range from 9 kHz to the 10th harmonic of the carrier, and the emissions less than 20 dB below the permissible value are reported.

During the test, below 30MHz, the center of the loop shall be 1 meters; above 30MHz, the height of receive antenna shall be moved from 1 to 4 meters, and the antenna shall be performed under horizontal and vertical polarization. The turntable shall be rotated from 0 to 360 degrees for detecting the maximum of radiated spurious signal level. The measurements shall be repeated with orthogonal polarization of the test antenna. The data of cable loss and antenna factor has been calibrated in full testing frequency range before the testing.

Set the spectrum analyzer in the following:

Below 1GHz (detector: Peak and Quasi-Peak)

RBW=100 kHz / VBW=300 kHz / Sweep=AUTO

Above 1GHz (detector: Peak):

(a) PEAK: RBW=1MHz / VBW=3MHz / Sweep=AUTO

(b) AVERAGE: RBW=1MHz / VBW=3MHz / Sweep=AUTO

The radiated emission was measured in the following position: EUT stand-up position (Z axis), lie-down position (X, Y axis). The worst emission was found in lie-down position (X axis) and the worst case was recorded.

The test is in transmitting mode.

Test setup

9KHz ~ 30MHz

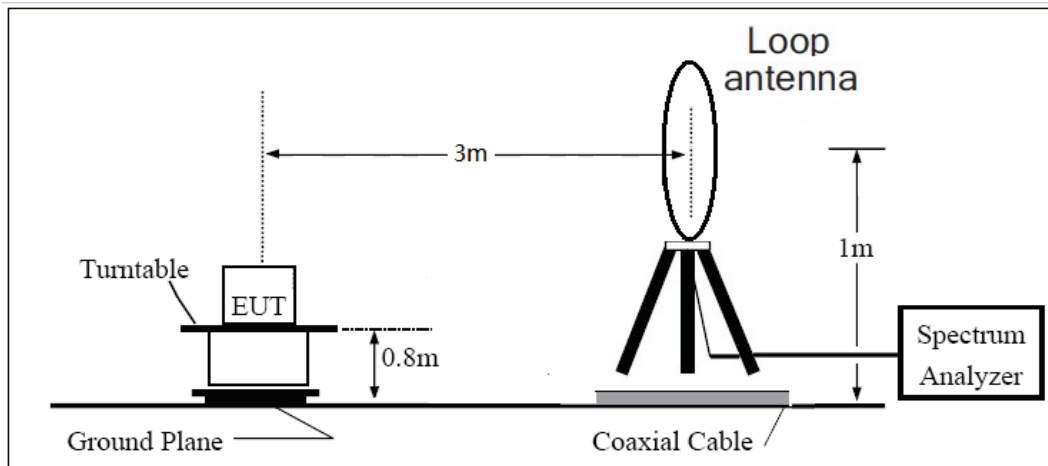

30MHz ~ 1GHz

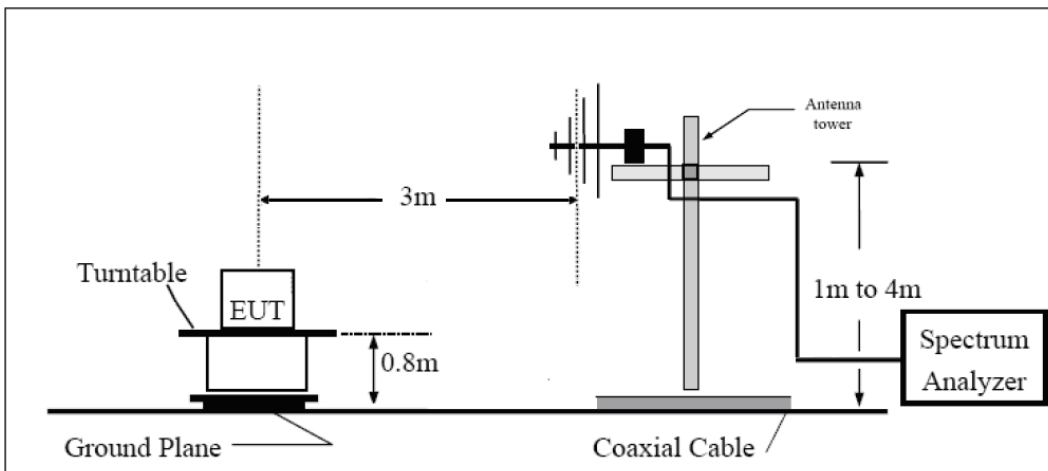

Above 1GHz

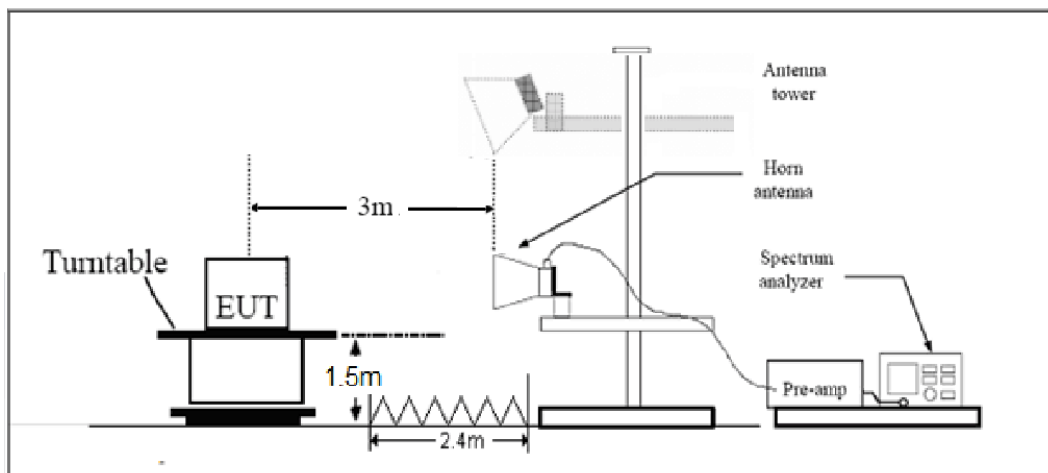

Note: Area side:2.4mX3.6m

**Limits**

Rule Part 15.247(d) specifies that “In addition, radiated emissions which fall in the restricted bands, as defined in § 15.205(a), must also comply with the radiated emission limits specified in § 15.209(a) (see § 15.205(c)).”

Limit in restricted band

Frequency of emission (MHz)	Field strength(uV/m)	Field strength(dBuV/m)
0.009–0.490	2400/F(kHz)	/
0.490–1.705	24000/F(kHz)	/
1.705–30.0	30	/
30-88	100	40
88-216	150	43.5
216-960	200	46
Above960	500	54

§15.35(b)

There is also a limit on the radio frequency emissions, as measured using instrumentation with a peak detector function, corresponding to 20 dB above the maximum permitted average limit.

Measurement Uncertainty

The assessed measurement uncertainty to ensure 95% confidence level for the normal distribution is with the coverage factor $k = 1.96$.

Frequency	Uncertainty
9KHz-30MHz	3.55 dB
30MHz-200MHz	4.19 dB
200MHz-1GHz	3.63 dB
Above 1GHz	3.68 dB

Test result

Sweep from 9 kHz to 30MHz, and the emissions more than 20 dB below the permissible value are not reported.

The following graphs display the maximum values of horizontal and vertical by software. For above 1GHz, Blue trace uses the peak detection, Green trace uses the average detection.

During the test, the Radiates Emission from 30MHz to 1GHz was performed in all modes with all channels, 802.11g, Channel 1 are selected as the worst condition. The test data of the worst-case condition was recorded in this report.

Continuous TX mode:

FCC RE 0.03-1GHz QP Class B

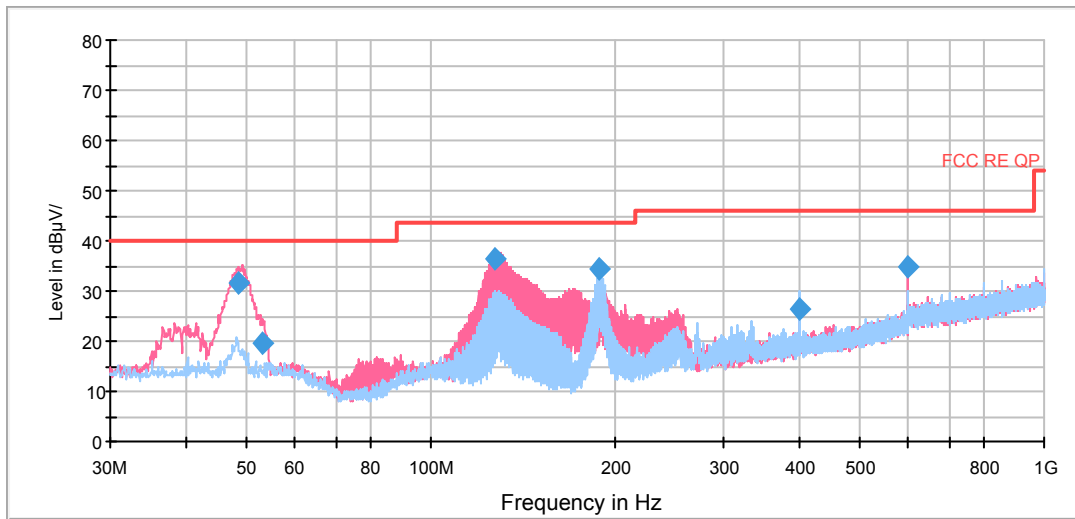

Radiates Emission from 30MHz to 1GHz

Frequency (MHz)	Quasi-Peak (dBuV/m)	Reading value (dBuV/m)	Height (cm)	Polarization	Azimuth (deg)	Correct Factor (dB)	Margin (dB)	Limit (dBuV/m)
48.703000	31.6	18.5	100.0	V	18.0	13.1	8.4	40.0
53.262000	19.6	6.8	100.0	V	339.0	12.8	20.4	40.0
127.468000	36.3	26.6	100.0	V	48.0	9.7	7.2	43.5
188.498000	34.5	23.1	100.0	H	81.0	11.4	9.0	43.5
399.998000	26.5	8.1	100.0	H	224.0	18.4	19.5	46.0
599.972000	34.6	11.7	100.0	V	306.0	22.9	11.4	46.0

- Remark:**
1. Quasi-Peak = Reading value + Correction factor
 2. Correction Factor = Antenna factor+ Insertion loss(cable loss+amplifier gain)
 3. Margin = Limit – Quasi-Peak

802.11b CH1

RE 1G-3GHz PK+AV

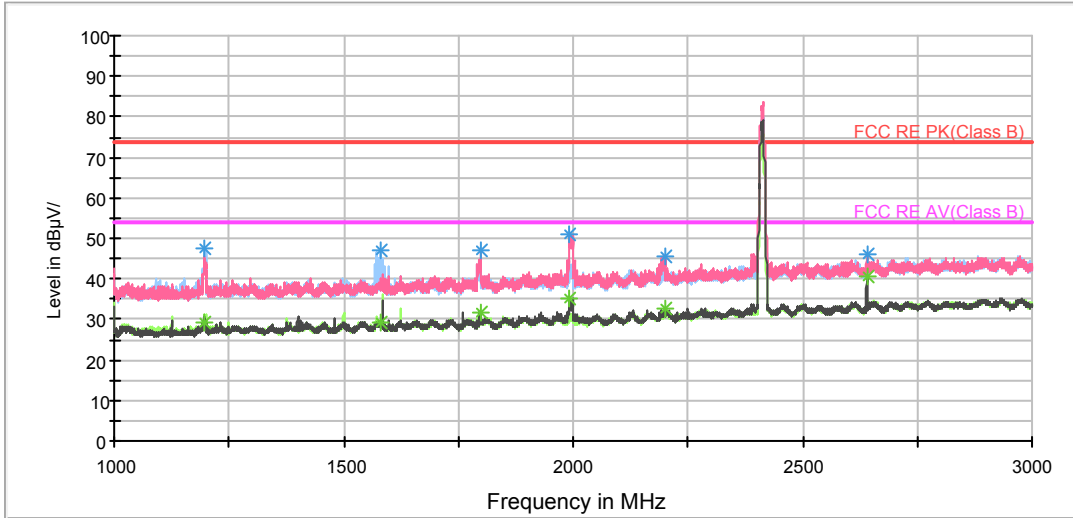

Note: The signal beyond the limit is carrier.
Radiates Emission from 1GHz to 3GHz

RE 3-18GHz PK+AV

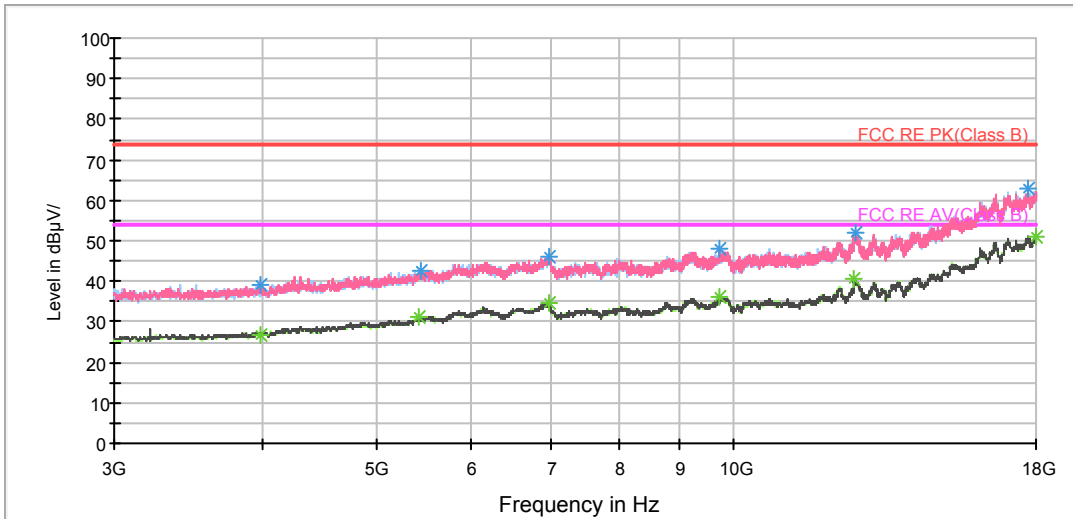

Radiates Emission from 3GHz to 18GHz

BELL_RE 18-26.5GHz PK+AV

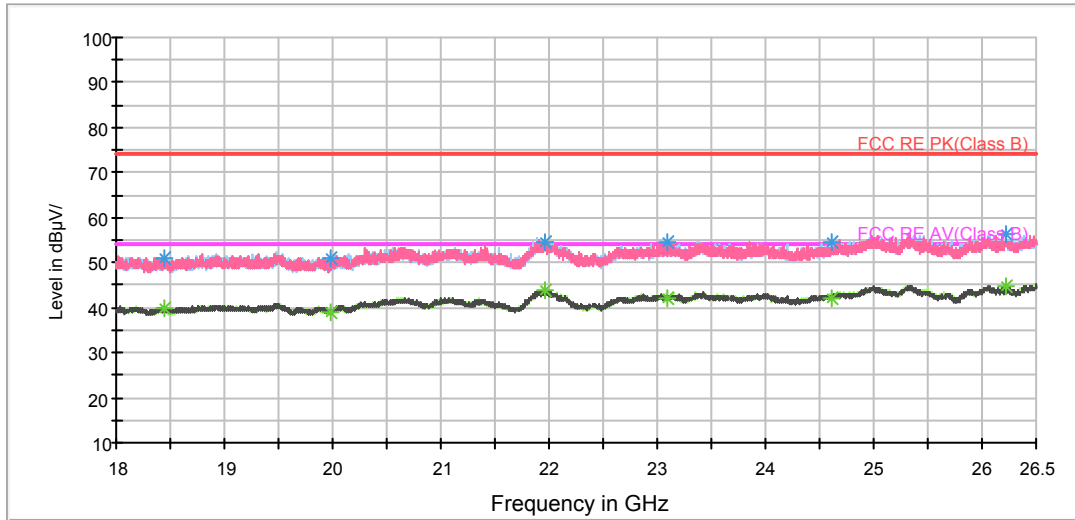

Radiates Emission from 18GHz to 26.5GHz

Frequency (MHz)	Peak (dBuV/m)	Height (cm)	Polarization	Azimuth (deg)	Reading value (dBuV/m)	Correct Factor (dB)	Margin (dB)	Limit (dBuV/m)
1197.000000	47.5	100.0	H	88.0	56.4	-8.9	26.5	74
1582.500000	47.1	100.0	H	97.0	54.8	-7.7	26.9	74
1800.000000	47.0	100.0	V	90.0	52.7	-5.7	27.0	74
1992.500000	51.0	100.0	V	0.0	56.5	-5.5	23.0	74
2199.000000	45.8	100.0	V	16.0	50.1	-4.3	28.2	74
2640.250000	46.0	100.0	V	135.0	48.3	-2.3	28.0	74

Remark: 1. Correction Factor = Antenna factor+ Insertion loss (cable loss + amplifier gain)

Frequency (MHz)	Average (dBuV/m)	Height (cm)	Polarization	Azimuth (deg)	Reading value (dBuV/m)	Correct Factor (dB)	Margin (dB)	Limit (dBuV/m)
1197.000000	29.2	100.0	H	88.0	38.1	-8.9	24.8	54
1582.500000	29.3	100.0	H	97.0	37.0	-7.7	24.7	54
1800.000000	31.8	100.0	V	90.0	37.5	-5.7	22.2	54
1992.500000	35.1	100.0	V	0.0	40.6	-5.5	18.9	54
2199.000000	32.8	100.0	V	16.0	37.1	-4.3	21.2	54
2640.000000	40.8	100.0	V	143.0	43.1	-2.3	13.2	54

Remark: 1. Correction Factor = Antenna factor+ Insertion loss (cable loss + amplifier gain)

802.11b CH6

RE 1G-3GHz PK+AV

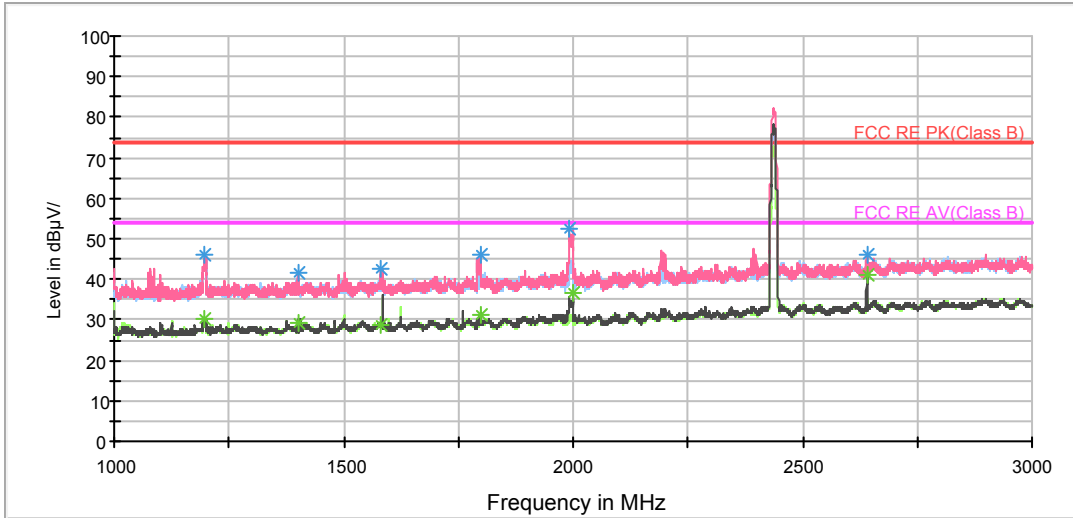

Note: The signal beyond the limit is carrier.
Radiates Emission from 1GHz to 3GHz

RE 3-18GHz PK+AV

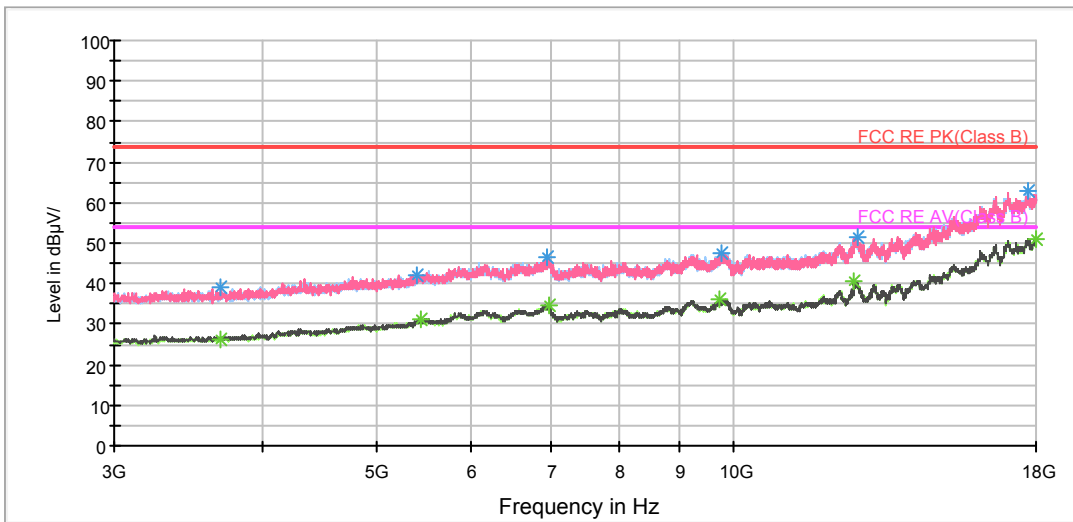

Radiates Emission from 3GHz to 18GHz

BELL_RE 18-26.5GHz PK+AV

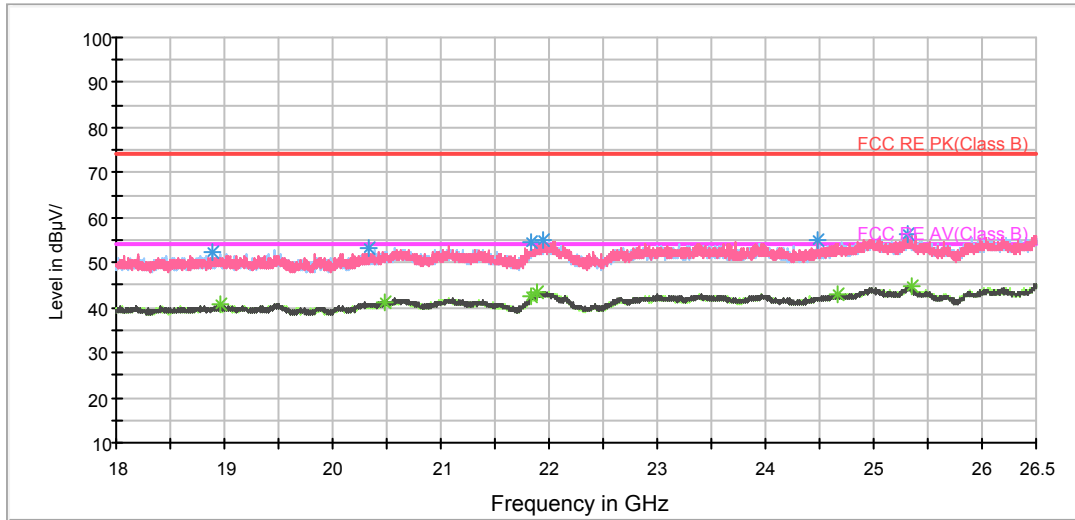

Radiates Emission from 18GHz to 26.5GHz

Frequency (MHz)	Peak (dBuV/m)	Height (cm)	Polarization	Azimuth (deg)	Reading value (dBuV/m)	Correct Factor (dB)	Margin (dB)	Limit (dBuV/m)
1196.750000	46.1	100.0	H	11.0	55.0	-8.9	27.9	74
1399.750000	41.3	100.0	V	0.0	49.5	-8.2	32.7	74
1580.250000	42.6	100.0	V	48.0	50.2	-7.6	31.4	74
1799.000000	46.0	100.0	H	32.0	51.8	-5.8	28.0	74
1991.500000	52.3	100.0	V	0.0	57.8	-5.5	21.7	74
2640.250000	46.1	100.0	V	117.0	48.4	-2.3	27.9	74

Remark: 1. Correction Factor = Antenna factor+ Insertion loss (cable loss + amplifier gain)

Frequency (MHz)	Average (dBuV/m)	Height (cm)	Polarization	Azimuth (deg)	Reading value (dBuV/m)	Correct Factor (dB)	Margin (dB)	Limit (dBuV/m)
1196.750000	30.4	100.0	H	11.0	39.3	-8.9	23.6	54
1399.750000	29.3	100.0	V	0.0	37.5	-8.2	24.7	54
1580.250000	28.7	100.0	V	48.0	36.3	-7.6	25.3	54
1799.000000	31.1	100.0	H	32.0	36.9	-5.8	22.9	54
1998.750000	36.8	100.0	V	0.0	42.4	-5.6	17.2	54
2640.250000	40.8	100.0	V	117.0	43.1	-2.3	13.2	54

Remark: 1. Correction Factor = Antenna factor+ Insertion loss (cable loss + amplifier gain)

802.11b CH11

RE 1G-3GHz PK+AV

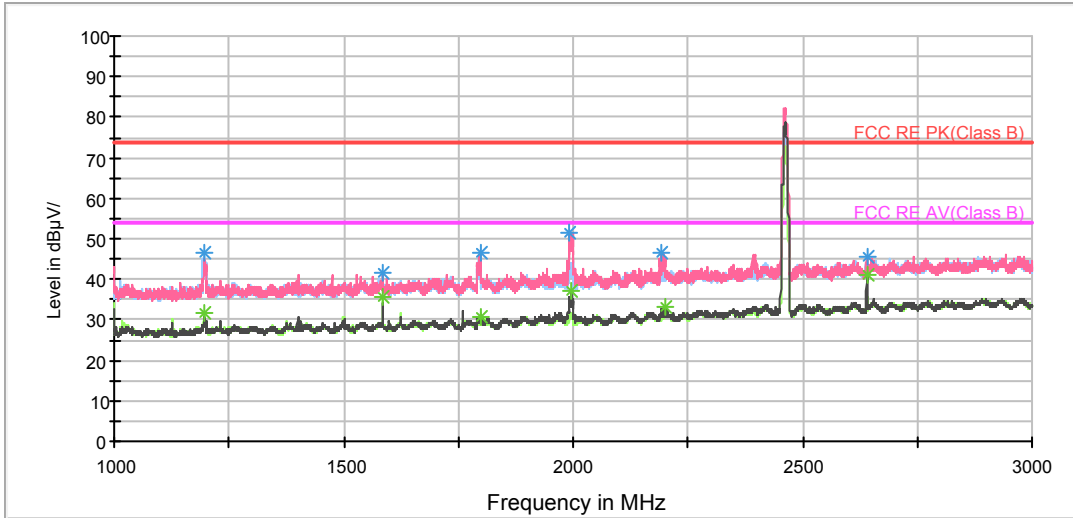

Note: The signal beyond the limit is carrier.
Radiates Emission from 1GHz to 3GHz

RE 3-18GHz PK+AV

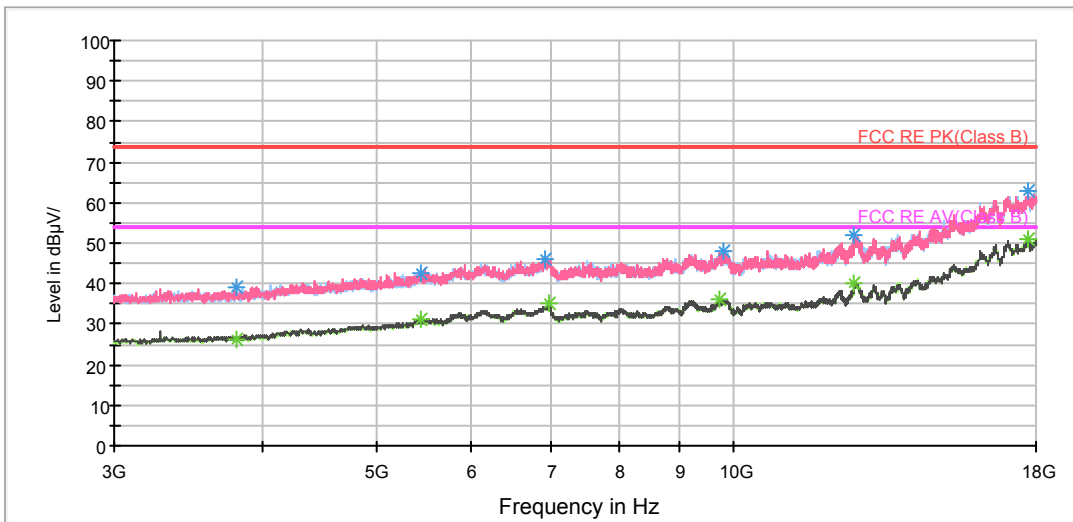

Radiates Emission from 3GHz to 18GHz

BELL_RE 18-26.5GHz PK+AV

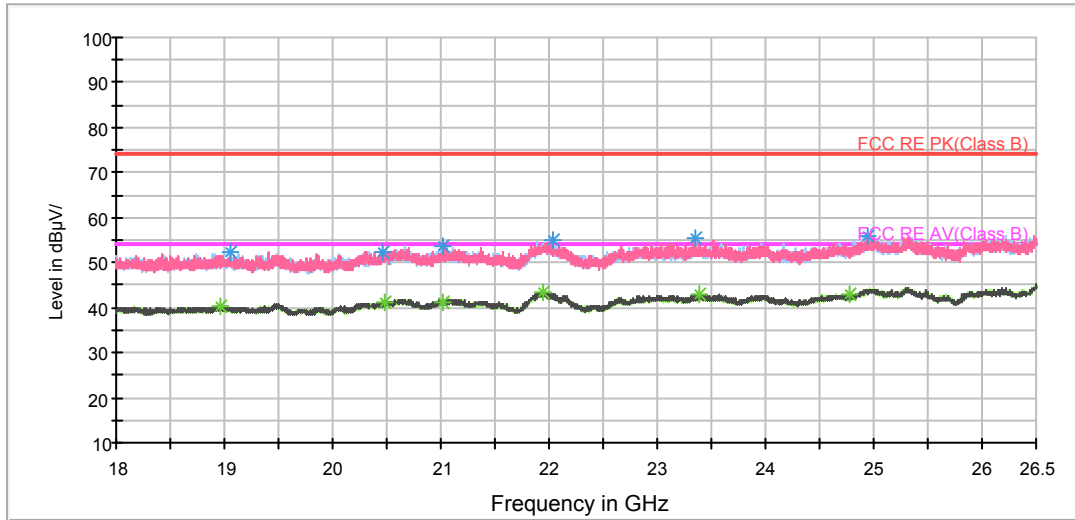

Radiates Emission from 18GHz to 26.5GHz

Frequency (MHz)	Peak (dBuV/m)	Height (cm)	Polarization	Azimuth (deg)	Reading value (dBuV/m)	Correct Factor (dB)	Margin (dB)	Limit (dBuV/m)
1197.000000	46.8	100.0	H	10.0	55.7	-8.9	27.2	74
1584.000000	41.5	100.0	H	310.0	49.2	-7.7	32.5	74
1798.500000	46.7	100.0	V	78.0	52.5	-5.8	27.3	74
1991.500000	51.6	100.0	V	17.0	57.1	-5.5	22.4	74
2194.250000	46.7	100.0	V	0.0	51.0	-4.3	27.3	74
2640.500000	45.8	100.0	V	139.0	48.1	-2.3	28.2	74

Remark: 1. Correction Factor = Antenna factor+ Insertion loss (cable loss + amplifier gain)

Frequency (MHz)	Average (dBuV/m)	Height (cm)	Polarization	Azimuth (deg)	Reading value (dBuV/m)	Correct Factor (dB)	Margin (dB)	Limit (dBuV/m)
1197.000000	31.5	100.0	H	10.0	40.4	-8.9	22.5	54
1584.000000	35.6	100.0	H	310.0	43.3	-7.7	18.4	54
1798.500000	30.7	100.0	V	78.0	36.5	-5.8	23.3	54
1996.250000	37.1	100.0	V	328.0	42.6	-5.5	16.9	54
2198.750000	33.2	100.0	V	338.0	37.5	-4.3	20.8	54
2640.000000	41.0	100.0	V	122.0	43.3	-2.3	13.0	54

Remark: 1. Correction Factor = Antenna factor+ Insertion loss (cable loss + amplifier gain)

802.11g CH1

RE 1G-3GHz PK+AV

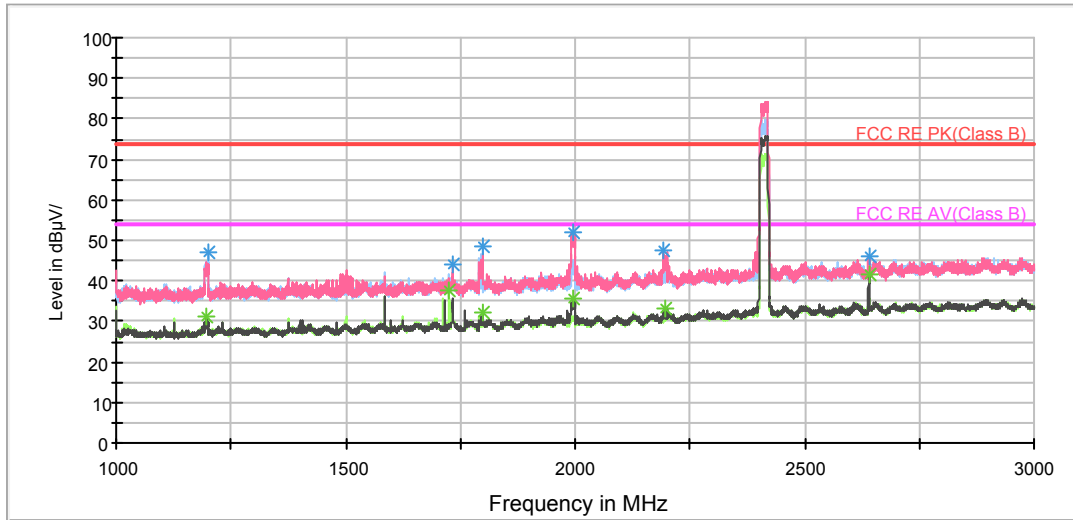

Note: The signal beyond the limit is carrier.
Radiates Emission from 1GHz to 3GHz

RE 3-18GHz PK+AV

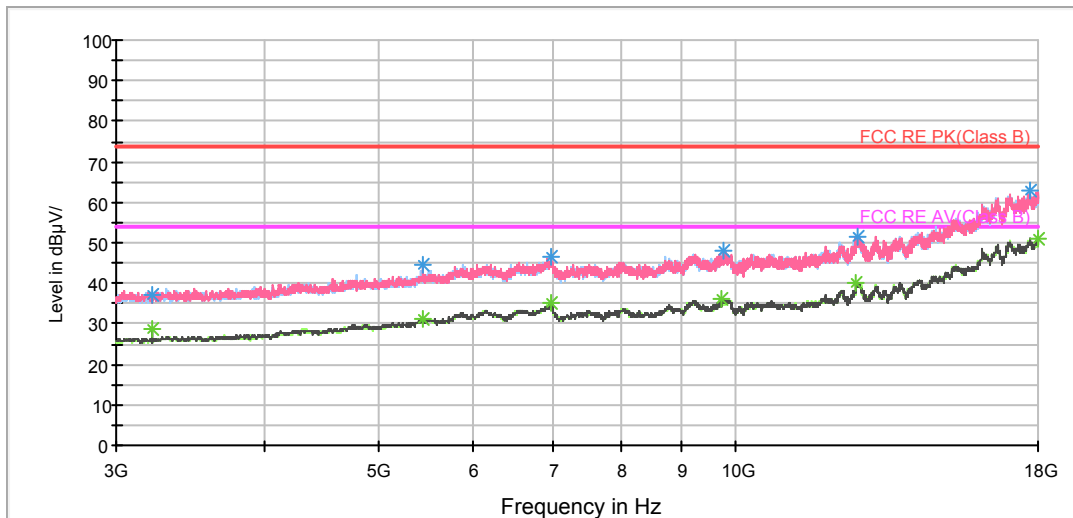

Radiates Emission from 3GHz to 18GHz

BELL_RE 18-26.5GHz PK+AV

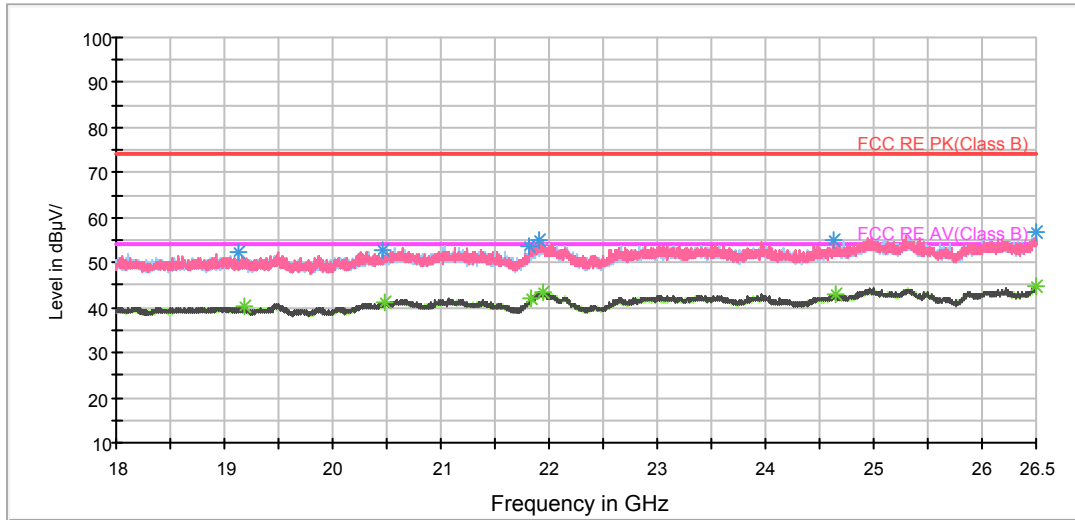

Radiates Emission from 18GHz to 26.5GHz

Frequency (MHz)	Peak (dBuV/m)	Height (cm)	Polarization	Azimuth (deg)	Reading value (dBuV/m)	Correct Factor (dB)	Margin (dB)	Limit (dBuV/m)
1199.000000	46.8	100.0	H	22.0	55.8	-9.0	27.2	74
1734.500000	44.3	100.0	V	299.0	50.6	-6.3	29.7	74
1799.750000	48.3	100.0	H	32.0	54.0	-5.7	25.7	74
1993.500000	52.0	100.0	V	0.0	57.4	-5.4	22.0	74
2191.000000	47.4	100.0	V	0.0	51.7	-4.3	26.6	74
2640.500000	46.3	100.0	V	124.0	48.6	-2.3	27.7	74

Remark: 1. Correction Factor = Antenna factor+ Insertion loss (cable loss + amplifier gain)

Frequency (MHz)	Average (dBuV/m)	Height (cm)	Polarization	Azimuth (deg)	Reading value (dBuV/m)	Correct Factor (dB)	Margin (dB)	Limit (dBuV/m)
1198.500000	31.2	100.0	V	191.0	40.2	-9.0	22.8	54
1726.500000	37.4	100.0	H	79.0	44.1	-6.7	16.6	54
1799.750000	32.3	100.0	H	32.0	38.0	-5.7	21.7	54
1995.750000	35.8	100.0	V	349.0	41.2	-5.4	18.2	54
2197.500000	33.2	100.0	V	0.0	37.5	-4.3	20.8	54
2640.250000	41.4	100.0	V	142.0	43.7	-2.3	12.6	54

Remark: 1. Correction Factor = Antenna factor+ Insertion loss (cable loss + amplifier gain)

802.11g CH6

RE 1G-3GHz PK+AV

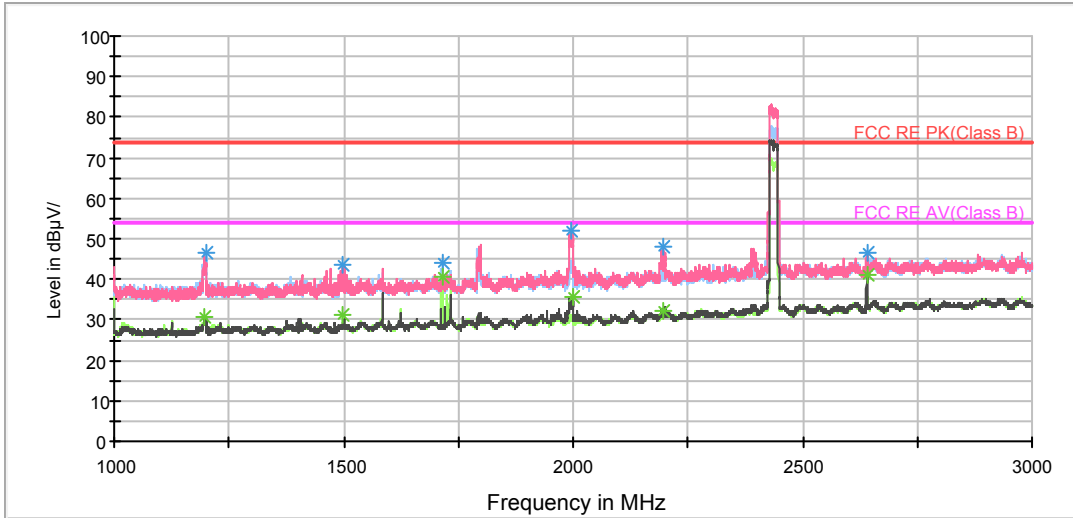

Note: The signal beyond the limit is carrier.
Radiates Emission from 1GHz to 3GHz

RE 3-18GHz PK+AV

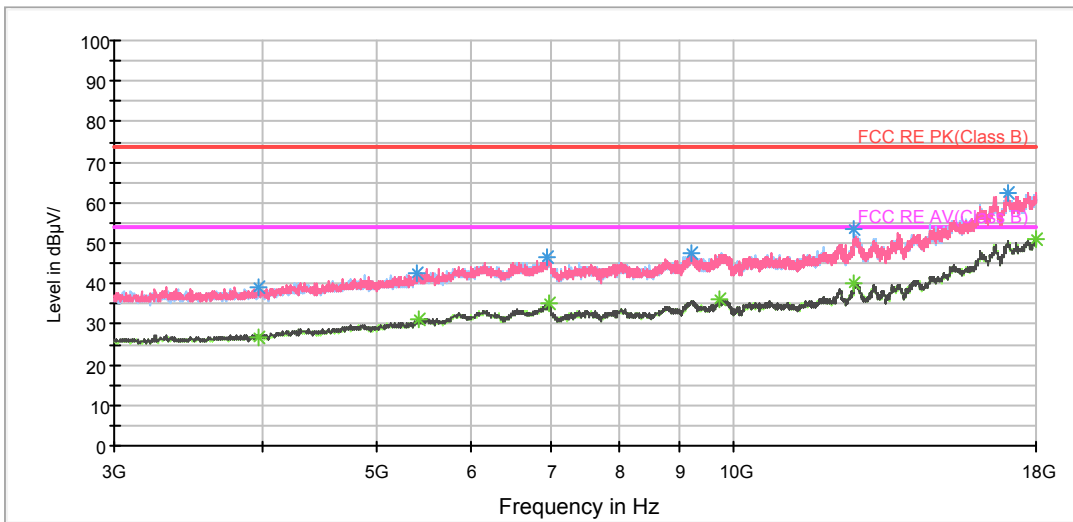

Radiates Emission from 3GHz to 18GHz

BELL_RE 18-26.5GHz PK+AV

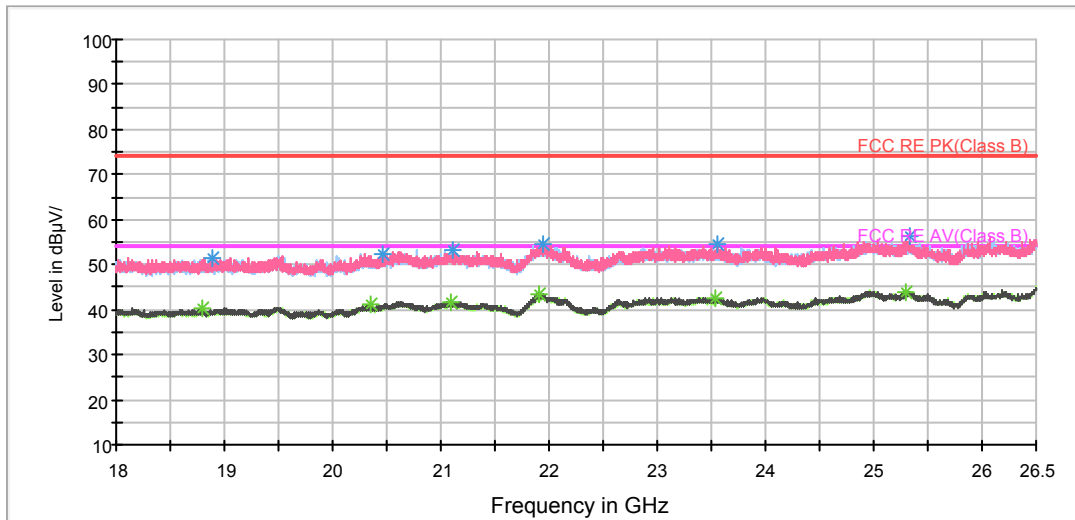

Radiates Emission from 18GHz to 26.5GHz

Frequency (MHz)	Peak (dBuV/m)	Height (cm)	Polarization	Azimuth (deg)	Reading value (dBuV/m)	Correct Factor (dB)	Margin (dB)	Limit (dBuV/m)
1199.500000	46.6	100.0	H	11.0	55.6	-9.0	27.4	74
1496.000000	43.7	100.0	V	16.0	51.6	-7.9	30.3	74
1716.000000	44.0	100.0	H	187.0	50.5	-6.5	30.0	74
1996.250000	52.2	100.0	V	0.0	57.7	-5.5	21.8	74
2197.000000	47.8	100.0	V	338.0	52.1	-4.3	26.2	74
2640.250000	46.6	100.0	V	68.0	48.9	-2.3	27.4	74

Remark: 1. Correction Factor = Antenna factor+ Insertion loss (cable loss + amplifier gain)

Frequency (MHz)	Average (dBuV/m)	Height (cm)	Polarization	Azimuth (deg)	Reading value (dBuV/m)	Correct Factor (dB)	Margin (dB)	Limit (dBuV/m)
1197.500000	30.5	100.0	H	80.0	39.5	-9.0	23.5	54
1499.750000	31.0	100.0	H	321.0	38.9	-7.9	23.0	54
1716.000000	40.6	100.0	H	187.0	47.1	-6.5	13.4	54
1998.750000	35.6	100.0	V	25.0	41.2	-5.6	18.4	54
2197.000000	32.3	100.0	V	338.0	36.6	-4.3	21.7	54
2640.250000	40.9	100.0	V	68.0	43.2	-2.3	13.1	54

Remark: 1. Correction Factor = Antenna factor+ Insertion loss (cable loss + amplifier gain)

802.11g CH11

RE 1G-3GHz PK+AV

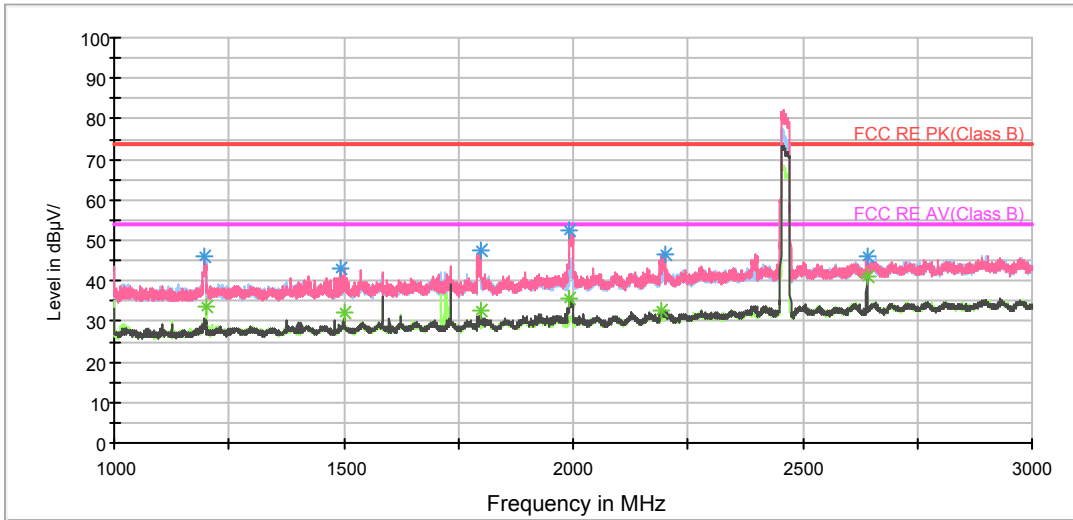

Note: The signal beyond the limit is carrier.
Radiates Emission from 1GHz to 3GHz

RE 3-18GHz PK+AV

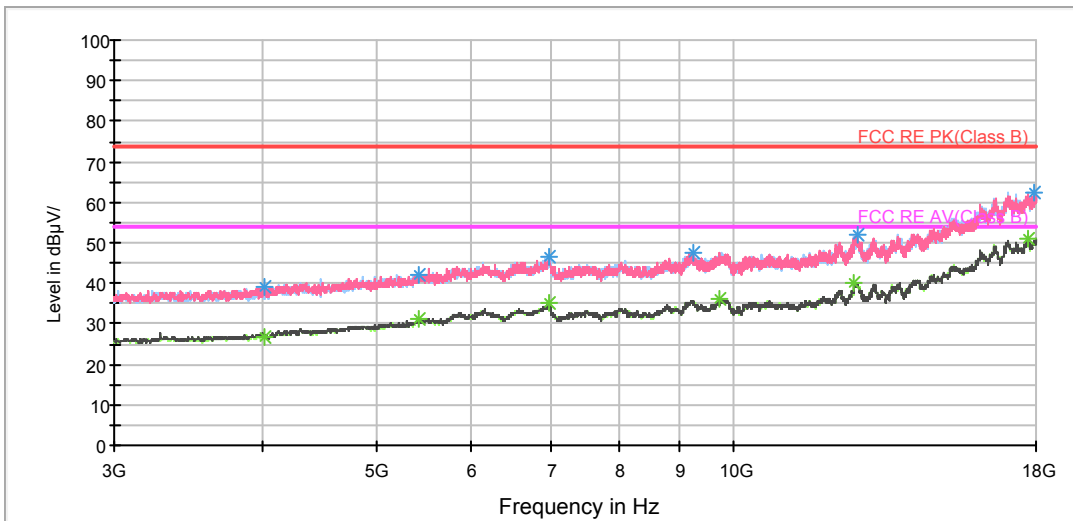

Radiates Emission from 3GHz to 18GHz

BELL_RE 18-26.5GHz PK+AV

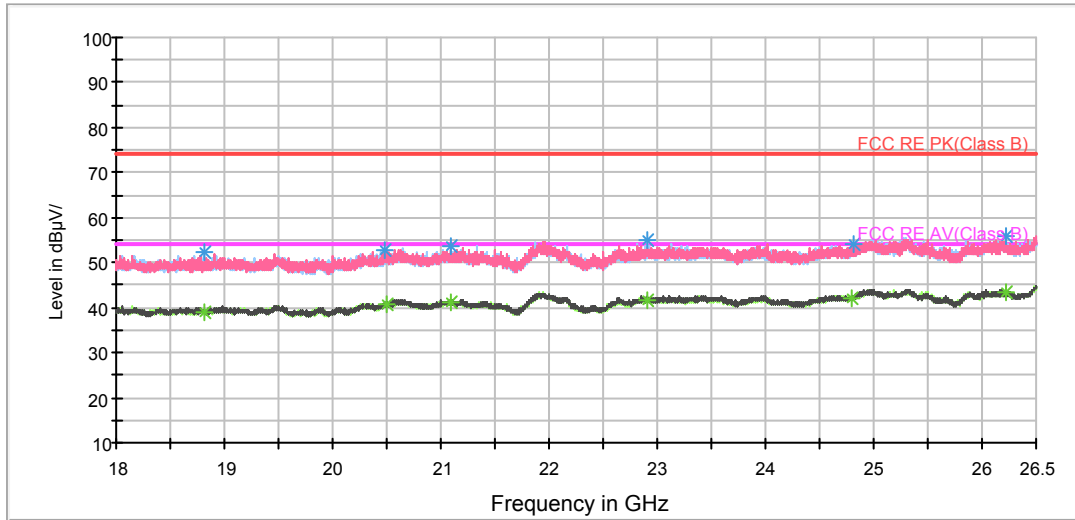

Radiates Emission from 18GHz to 26.5GHz

Frequency (MHz)	Peak (dBuV/m)	Height (cm)	Polarization	Azimuth (deg)	Reading value (dBuV/m)	Correct Factor (dB)	Margin (dB)	Limit (dBuV/m)
1198.000000	46.2	100.0	V	191.0	55.2	-9.0	27.8	74
1495.500000	43.3	100.0	V	17.0	51.2	-7.9	30.7	74
1799.750000	47.6	100.0	V	78.0	53.3	-5.7	26.4	74
1993.000000	52.6	100.0	V	0.0	58.1	-5.5	21.4	74
2200.000000	46.5	100.0	V	0.0	50.7	-4.2	27.5	74
2640.500000	45.9	100.0	V	138.0	48.2	-2.3	28.1	74

Remark: 1. Correction Factor = Antenna factor+ Insertion loss (cable loss + amplifier gain)

Frequency (MHz)	Average (dBuV/m)	Height (cm)	Polarization	Azimuth (deg)	Reading value (dBuV/m)	Correct Factor (dB)	Margin (dB)	Limit (dBuV/m)
1199.250000	33.7	100.0	H	78.0	42.7	-9.0	20.3	54
1500.250000	32.2	100.0	H	320.0	40.1	-7.9	21.8	54
1799.750000	32.7	100.0	V	78.0	38.4	-5.7	21.3	54
1992.000000	35.8	100.0	V	9.0	41.3	-5.5	18.2	54
2190.750000	32.9	100.0	V	349.0	37.3	-4.4	21.1	54
2640.000000	41.0	100.0	V	130.0	43.3	-2.3	13.0	54

Remark: 1. Correction Factor = Antenna factor+ Insertion loss (cable loss + amplifier gain)



802.11n (HT20) CH1

RE 1G-3GHz PK+AV

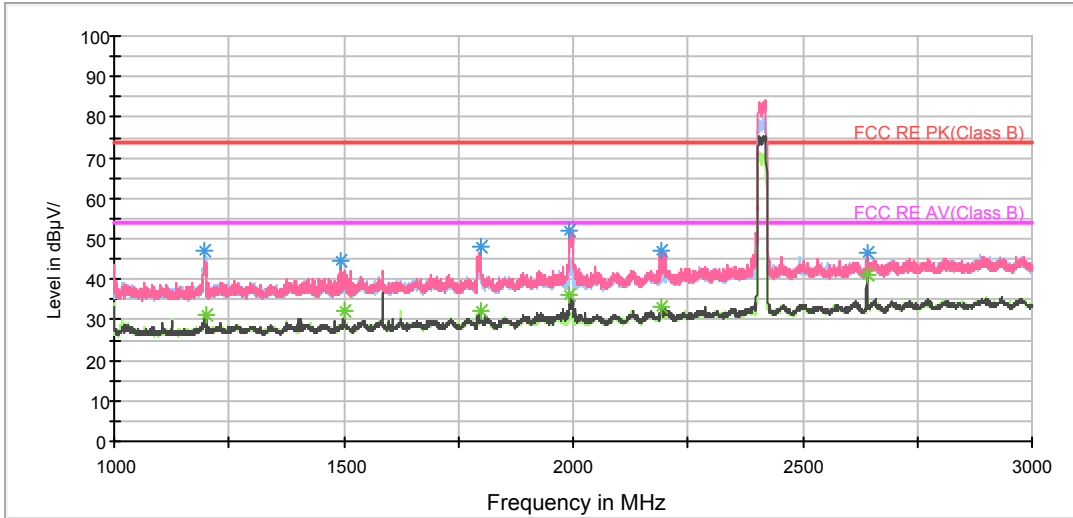

Note: The signal beyond the limit is carrier.
Radiates Emission from 1GHz to 3GHz

RE 3-18GHz PK+AV

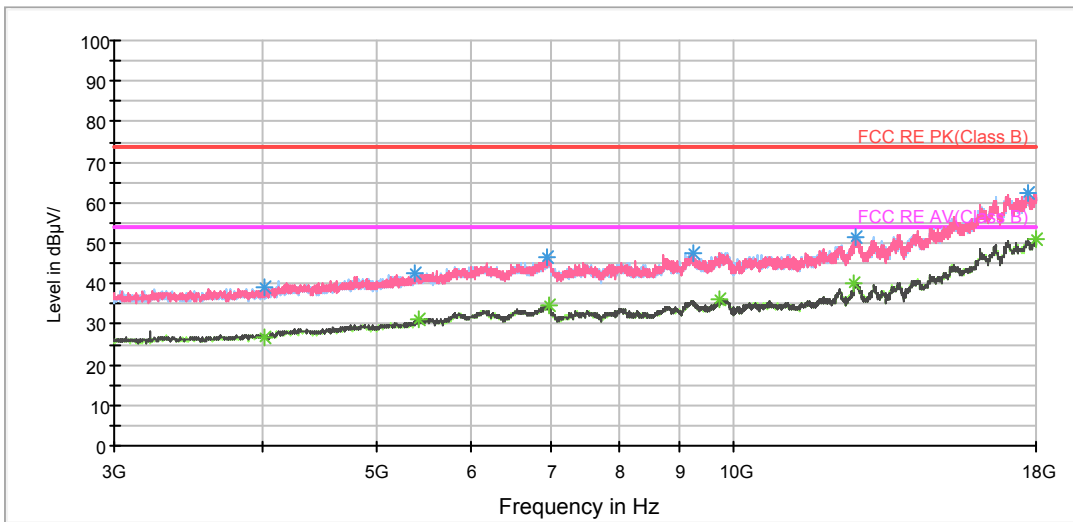

Radiates Emission from 3GHz to 18GHz

BELL_RE 18-26.5GHz PK+AV

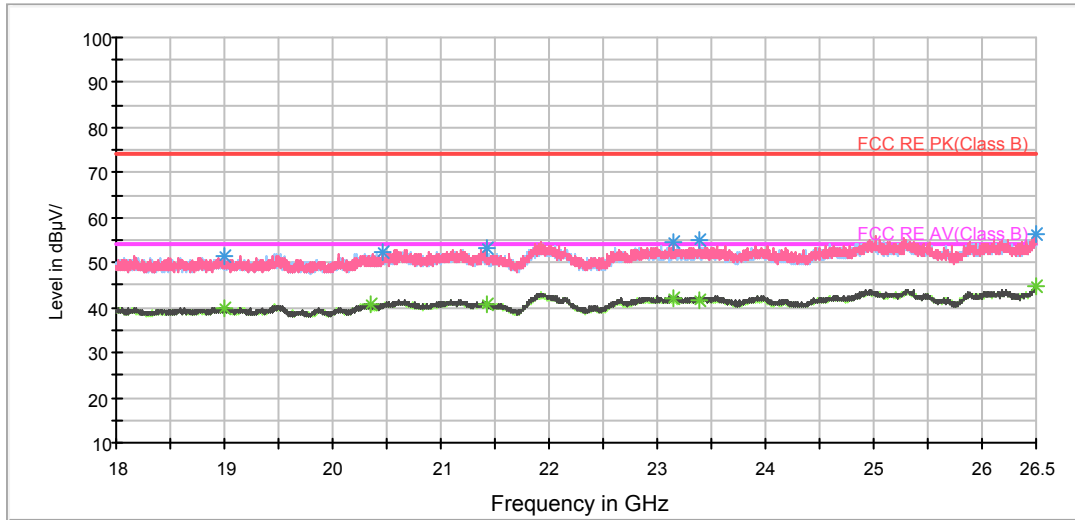

Radiates Emission from 18GHz to 26.5GHz

Frequency (MHz)	Peak (dBuV/m)	Height (cm)	Polarization	Azimuth (deg)	Reading value (dBuV/m)	Correct Factor (dB)	Margin (dB)	Limit (dBuV/m)
1196.250000	47.2	100.0	H	14.0	56.1	-8.9	26.8	74
1492.750000	44.4	100.0	V	39.0	52.3	-7.9	29.6	74
1799.500000	47.9	100.0	V	77.0	53.6	-5.7	26.1	74
1992.500000	52.0	100.0	V	0.0	57.5	-5.5	22.0	74
2192.500000	47.1	100.0	V	350.0	51.4	-4.3	26.9	74
2640.000000	46.5	100.0	V	121.0	48.8	-2.3	27.5	74

Remark: 1. Correction Factor = Antenna factor+ Insertion loss (cable loss + amplifier gain)

Frequency (MHz)	Average (dBuV/m)	Height (cm)	Polarization	Azimuth (deg)	Reading value (dBuV/m)	Correct Factor (dB)	Margin (dB)	Limit (dBuV/m)
1199.250000	31.4	100.0	H	14.0	40.4	-9.0	22.6	54
1500.000000	32.2	100.0	H	317.0	40.1	-7.9	21.8	54
1798.500000	32.0	100.0	V	77.0	37.8	-5.8	22.0	54
1990.500000	35.9	100.0	V	0.0	41.4	-5.5	18.1	54
2192.500000	33.1	100.0	V	350.0	37.4	-4.3	20.9	54
2640.000000	41.0	100.0	V	121.0	43.3	-2.3	13.0	54

Remark: 1. Correction Factor = Antenna factor+ Insertion loss (cable loss + amplifier gain)

802.11n (HT20) CH6

RE 1G-3GHz PK+AV

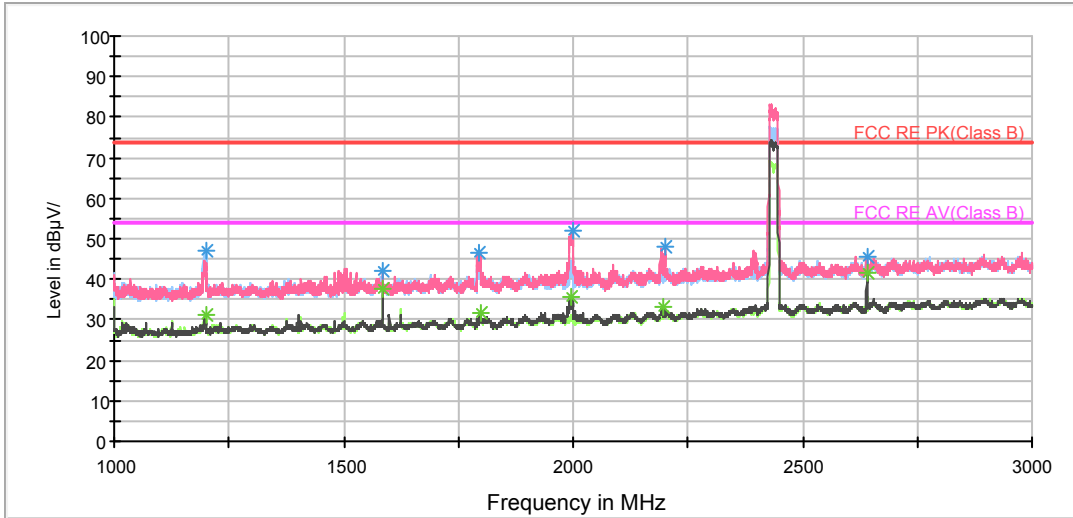

Note: The signal beyond the limit is carrier.
Radiates Emission from 1GHz to 3GHz

RE 3-18GHz PK+AV

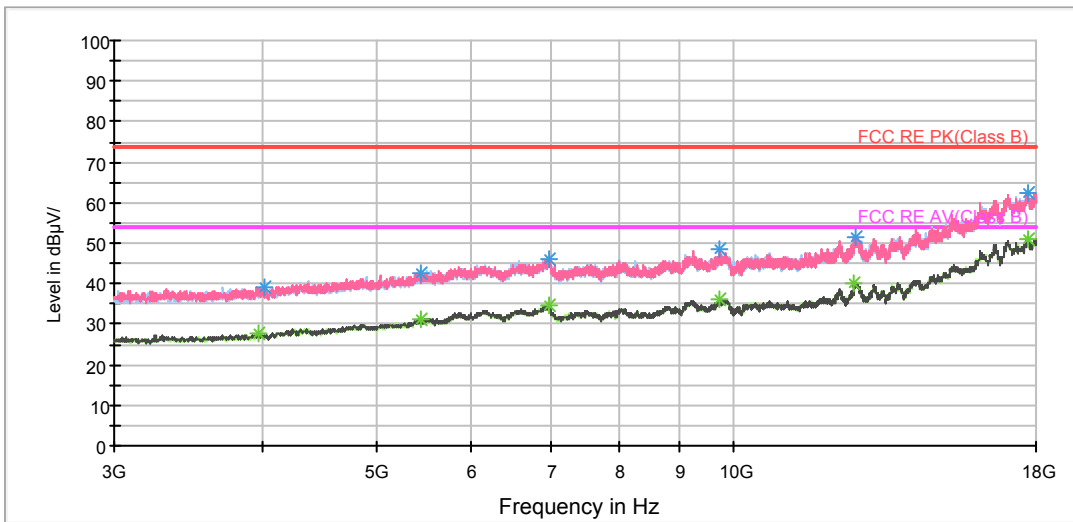

Radiates Emission from 3GHz to 18GHz

BELL_RE 18-26.5GHz PK+AV

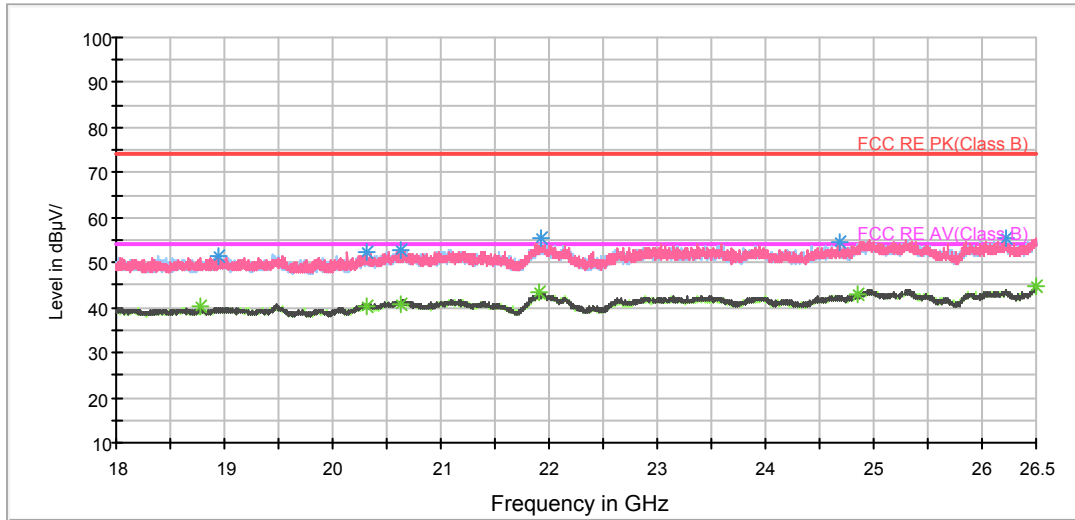

Radiates Emission from 18GHz to 26.5GHz

Frequency (MHz)	Peak (dBuV/m)	Height (cm)	Polarization	Azimuth (deg)	Reading value (dBuV/m)	Correct Factor (dB)	Margin (dB)	Limit (dBuV/m)
1199.750000	47.2	100.0	H	23.0	56.2	-9.0	26.8	74
1583.750000	42.0	100.0	V	264.0	49.7	-7.7	32.0	74
1793.500000	46.6	100.0	H	23.0	52.7	-6.1	27.4	74
1999.250000	51.9	100.0	V	350.0	57.5	-5.6	22.1	74
2200.000000	47.9	100.0	V	193.0	52.1	-4.2	26.1	74
2640.250000	45.8	100.0	V	121.0	48.1	-2.3	28.2	74

Remark: 1. Correction Factor = Antenna factor+ Insertion loss (cable loss + amplifier gain)

Frequency (MHz)	Average (dBuV/m)	Height (cm)	Polarization	Azimuth (deg)	Reading value (dBuV/m)	Correct Factor (dB)	Margin (dB)	Limit (dBuV/m)
1199.250000	31.2	100.0	H	72.0	40.2	-9.0	22.8	54
1583.750000	37.7	100.0	V	264.0	45.4	-7.7	16.3	54
1797.250000	31.8	100.0	V	69.0	37.7	-5.9	22.2	54
1997.250000	35.5	100.0	V	350.0	41.0	-5.5	18.5	54
2198.500000	33.1	100.0	V	338.0	37.4	-4.3	20.9	54
2640.000000	41.4	100.0	V	138.0	43.7	-2.3	12.6	54

Remark: 1. Correction Factor = Antenna factor+ Insertion loss (cable loss + amplifier gain)

802.11n (HT20) CH11

RE 1G-3GHz PK+AV

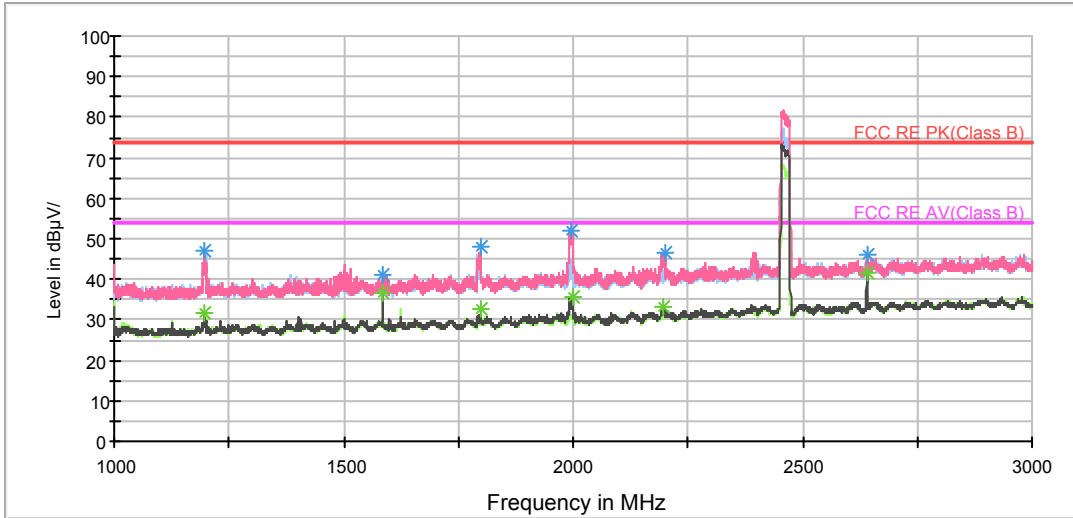

Note: The signal beyond the limit is carrier.
Radiates Emission from 1GHz to 3GHz

RE 3-18GHz PK+AV

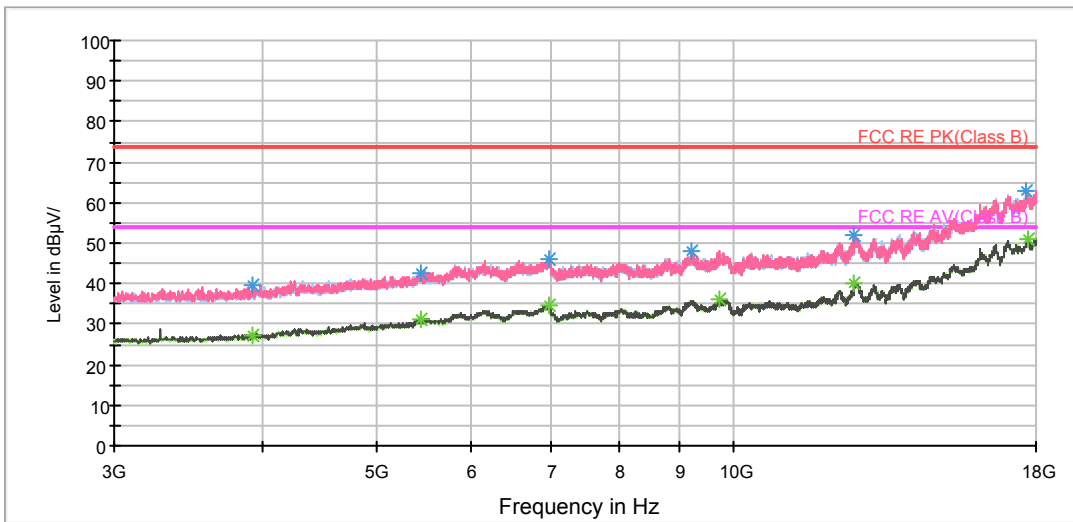

Radiates Emission from 3GHz to 18GHz

BELL_RE 18-26.5GHz PK+AV

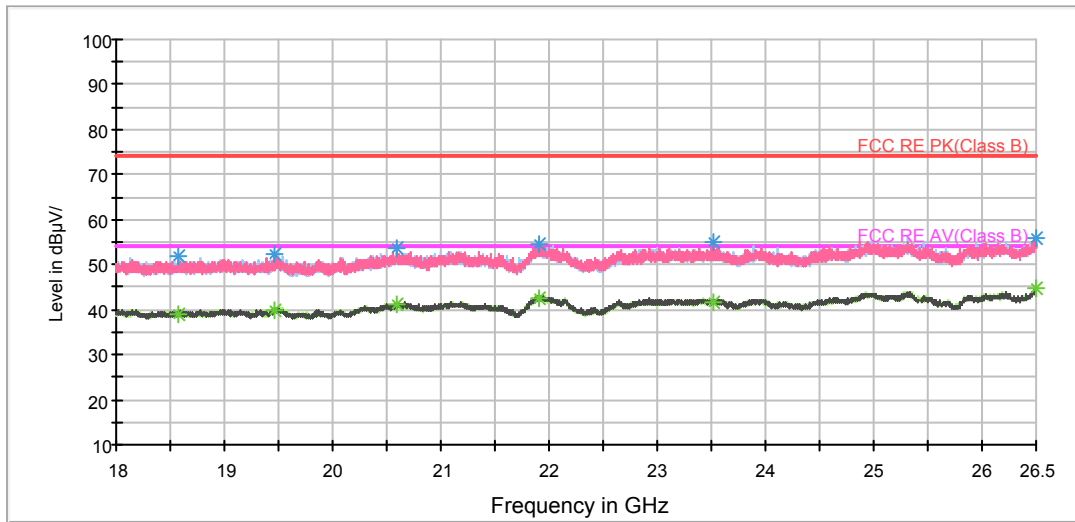

Radiates Emission from 18GHz to 26.5GHz

Frequency (MHz)	Peak (dBuV/m)	Height (cm)	Polarization	Azimuth (deg)	Reading value (dBuV/m)	Correct Factor (dB)	Margin (dB)	Limit (dBuV/m)
1196.250000	47.0	100.0	H	22.0	55.9	-8.9	27.0	74
1583.750000	41.3	100.0	V	270.0	49.0	-7.7	32.7	74
1798.000000	47.8	100.0	H	33.0	53.6	-5.8	26.2	74
1997.000000	52.2	100.0	V	349.0	57.7	-5.5	21.8	74
2198.750000	46.4	100.0	V	20.0	50.7	-4.3	27.6	74
2640.250000	46.2	100.0	V	146.0	48.5	-2.3	27.8	74

Remark: 1. Correction Factor = Antenna factor+ Insertion loss (cable loss + amplifier gain)

Frequency (MHz)	Average (dBuV/m)	Height (cm)	Polarization	Azimuth (deg)	Reading value (dBuV/m)	Correct Factor (dB)	Margin (dB)	Limit (dBuV/m)
1195.250000	31.5	100.0	H	33.0	40.4	-8.9	22.5	54
1584.000000	36.4	100.0	V	49.0	44.1	-7.7	17.6	54
1800.250000	32.5	100.0	H	22.0	38.2	-5.7	21.5	54
1999.000000	35.7	100.0	V	349.0	41.3	-5.6	18.3	54
2198.500000	33.0	100.0	V	349.0	37.3	-4.3	21.0	54
2640.250000	41.4	100.0	V	146.0	43.7	-2.3	12.6	54

Remark: 1. Correction Factor = Antenna factor+ Insertion loss (cable loss + amplifier gain)

802.11n (HT40) CH3

RE 1G-3GHz PK+AV

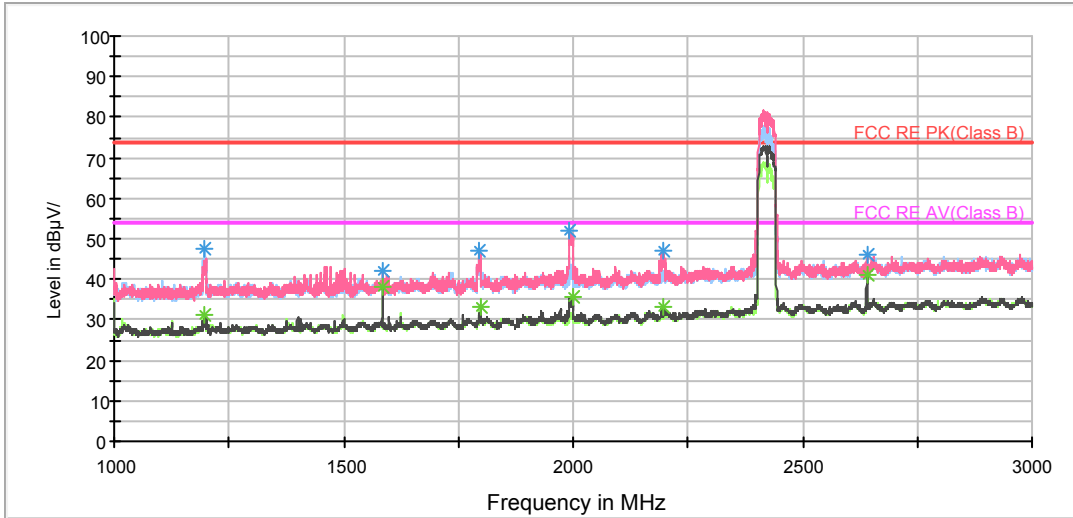

Note: The signal beyond the limit is carrier.
Radiates Emission from 1GHz to 3GHz

RE 3-18GHz PK+AV

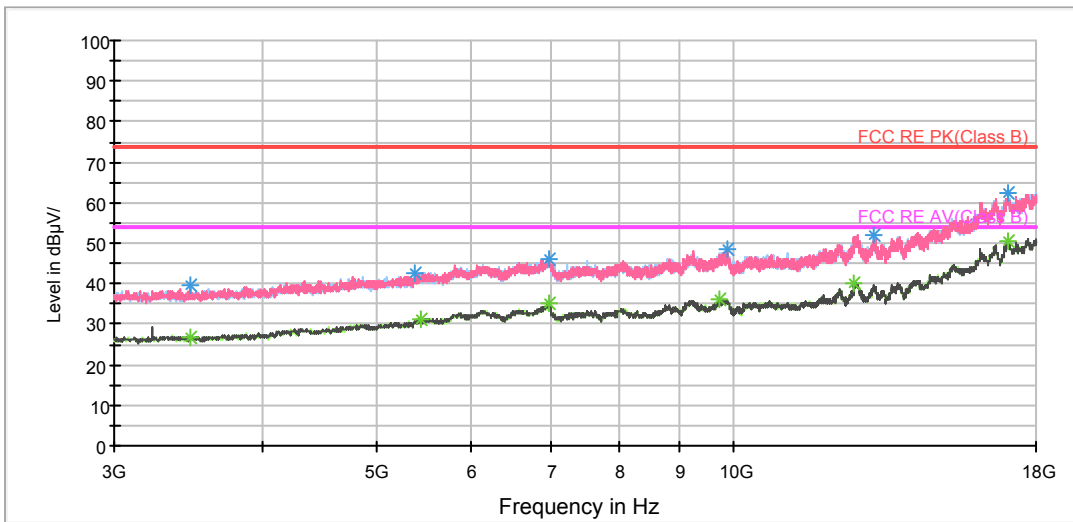

Radiates Emission from 3GHz to 18GHz

BELL_RE 18-26.5GHz PK+AV

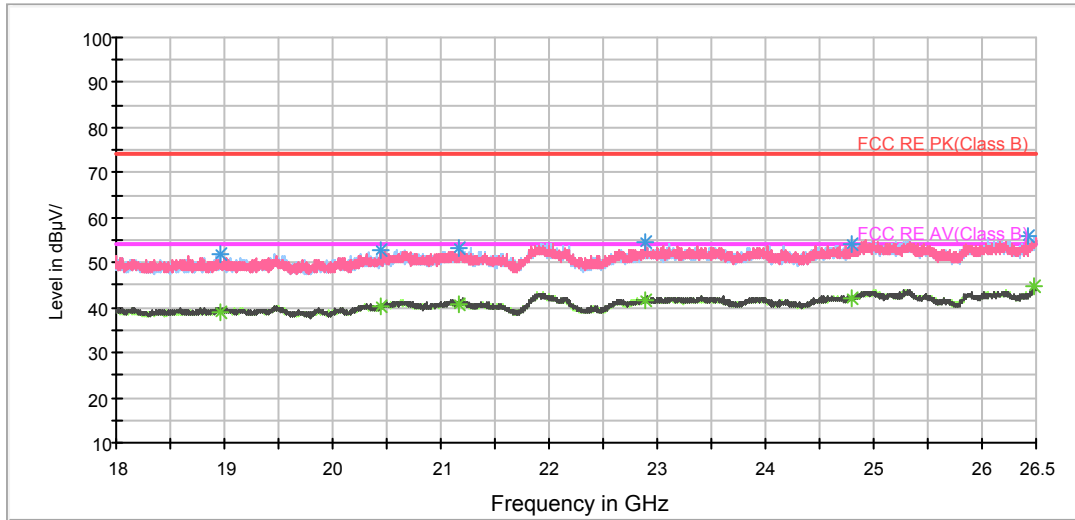

Radiates Emission from 18GHz to 26.5GHz

Frequency (MHz)	Peak (dBuV/m)	Height (cm)	Polarization	Azimuth (deg)	Reading value (dBuV/m)	Correct Factor (dB)	Margin (dB)	Limit (dBuV/m)
1195.750000	47.7	100.0	H	23.0	56.6	-8.9	26.3	74
1583.750000	42.3	100.0	V	269.0	50.0	-7.7	31.7	74
1796.750000	47.1	100.0	V	75.0	53.0	-5.9	26.9	74
1991.250000	51.9	100.0	V	338.0	57.4	-5.5	22.1	74
2195.750000	47.0	100.0	V	338.0	51.3	-4.3	27.0	74
2640.500000	46.0	100.0	V	118.0	48.3	-2.3	28.0	74

Remark: 1. Correction Factor = Antenna factor+ Insertion loss (cable loss + amplifier gain)

Frequency (MHz)	Average (dBuV/m)	Height (cm)	Polarization	Azimuth (deg)	Reading value (dBuV/m)	Correct Factor (dB)	Margin (dB)	Limit (dBuV/m)
1198.500000	31.4	100.0	H	23.0	40.4	-9.0	22.6	54
1584.000000	38.3	100.0	V	269.0	46.0	-7.7	15.7	54
1799.500000	33.1	100.0	V	57.0	38.8	-5.7	20.9	54
1999.000000	35.5	100.0	V	338.0	41.1	-5.6	18.5	54
2198.500000	33.3	100.0	V	338.0	37.6	-4.3	20.7	54
2640.250000	40.9	100.0	V	136.0	43.2	-2.3	13.1	54

Remark: 1. Correction Factor = Antenna factor+ Insertion loss (cable loss + amplifier gain)

802.11n (HT40) CH6

RE 1G-3GHz PK+AV

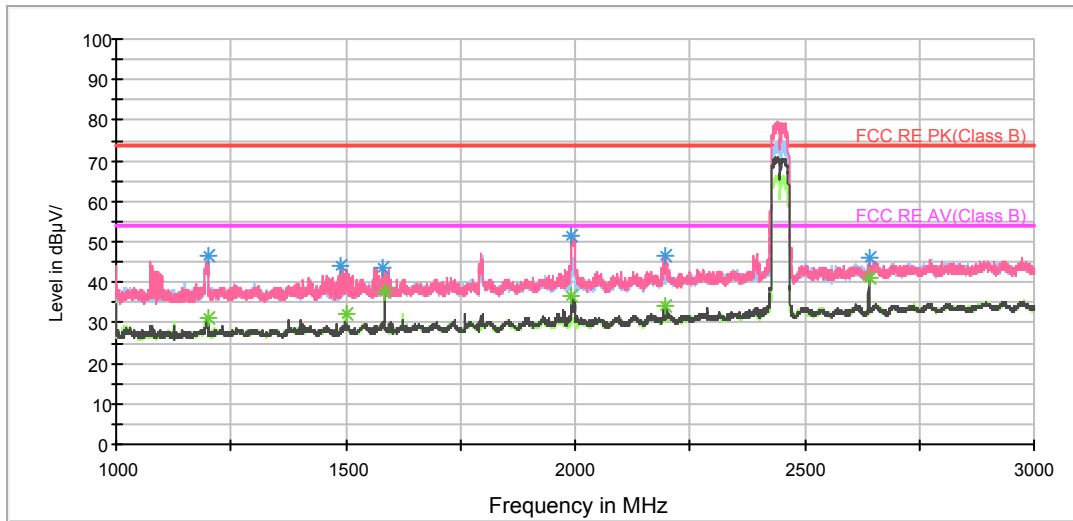

Note: The signal beyond the limit is carrier.
Radiates Emission from 1GHz to 3GHz

RE 3-18GHz PK+AV

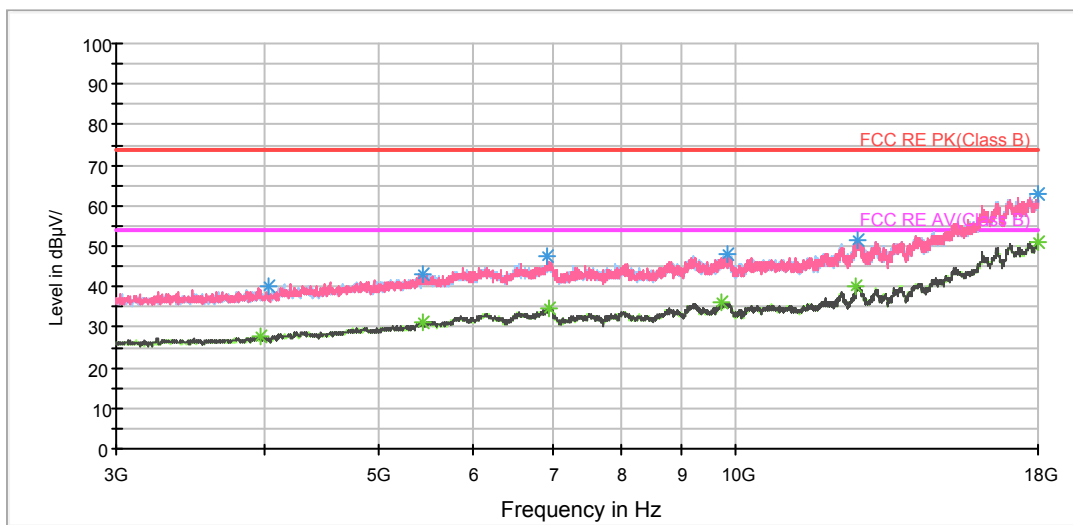

Radiates Emission from 3GHz to 18GHz

BELL_RE 18-26.5GHz PK+AV

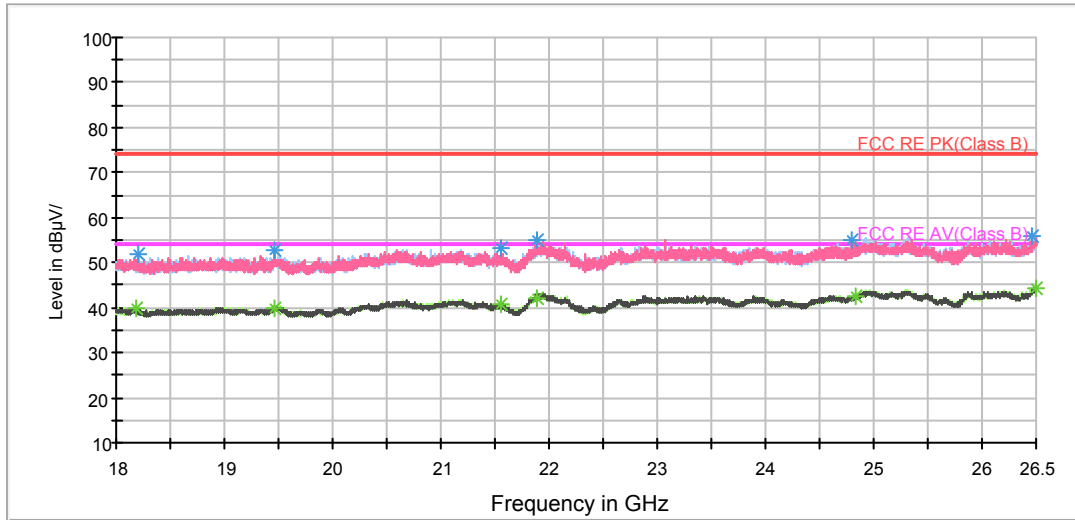

Radiates Emission from 18GHz to 26.5GHz

Frequency (MHz)	Peak (dBuV/m)	Height (cm)	Polarization	Azimuth (deg)	Reading value (dBuV/m)	Correct Factor (dB)	Margin (dB)	Limit (dBuV/m)
1200.000000	46.3	100.0	H	22.0	55.3	-9.0	27.7	74
1490.250000	44.3	100.0	V	20.0	52.2	-7.9	29.7	74
1579.750000	43.6	100.0	V	155.0	51.2	-7.6	30.4	74
1993.250000	51.5	100.0	V	2.0	57.0	-5.5	22.5	74
2198.250000	46.7	100.0	V	0.0	51.0	-4.3	27.3	74
2640.750000	46.2	100.0	V	0.0	48.5	-2.3	27.8	74

Remark: 1. Correction Factor = Antenna factor+ Insertion loss (cable loss + amplifier gain)

Frequency (MHz)	Average (dBuV/m)	Height (cm)	Polarization	Azimuth (deg)	Reading value (dBuV/m)	Correct Factor (dB)	Margin (dB)	Limit (dBuV/m)
1200.000000	31.2	100.0	H	22.0	40.2	-9.0	22.8	54
1500.000000	32.2	100.0	H	327.0	40.1	-7.9	21.8	54
1584.000000	37.8	100.0	V	263.0	45.5	-7.7	16.2	54
1993.250000	36.4	100.0	V	2.0	41.9	-5.5	17.6	54
2198.500000	34.4	100.0	V	0.0	38.7	-4.3	19.6	54
2640.250000	40.9	100.0	V	117.0	43.2	-2.3	13.1	54

Remark: 1. Correction Factor = Antenna factor+ Insertion loss (cable loss + amplifier gain)

802.11n (HT40) CH9

RE 1G-3GHz PK+AV

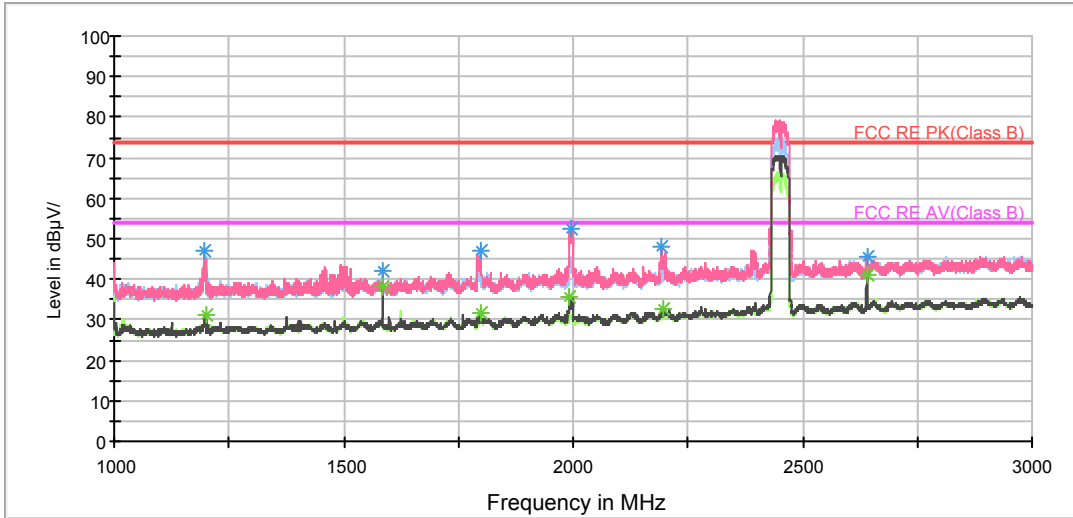

Note: The signal beyond the limit is carrier.
Radiates Emission from 1GHz to 3GHz

RE 3-18GHz PK+AV

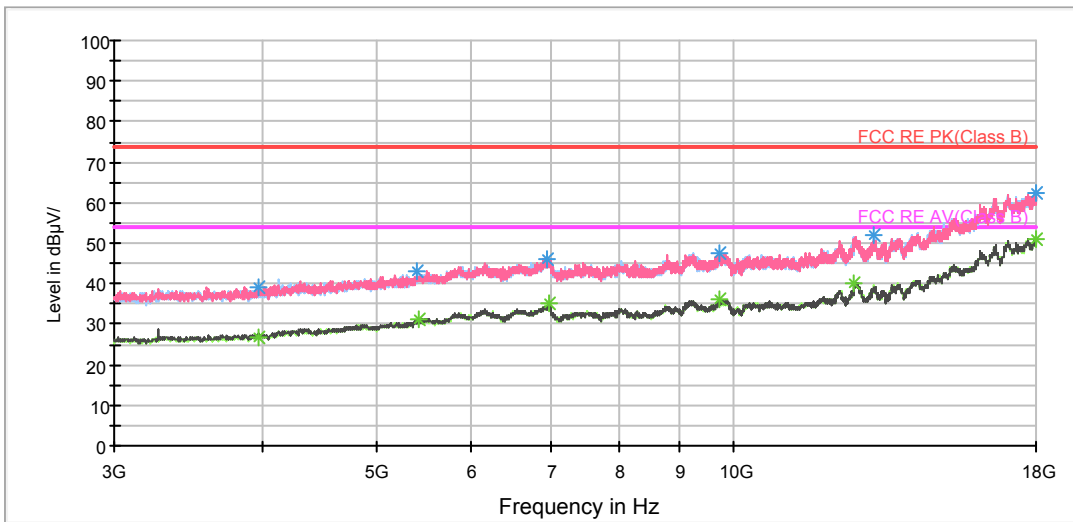

Radiates Emission from 3GHz to 18GHz

BELL_RE 18-26.5GHz PK+AV

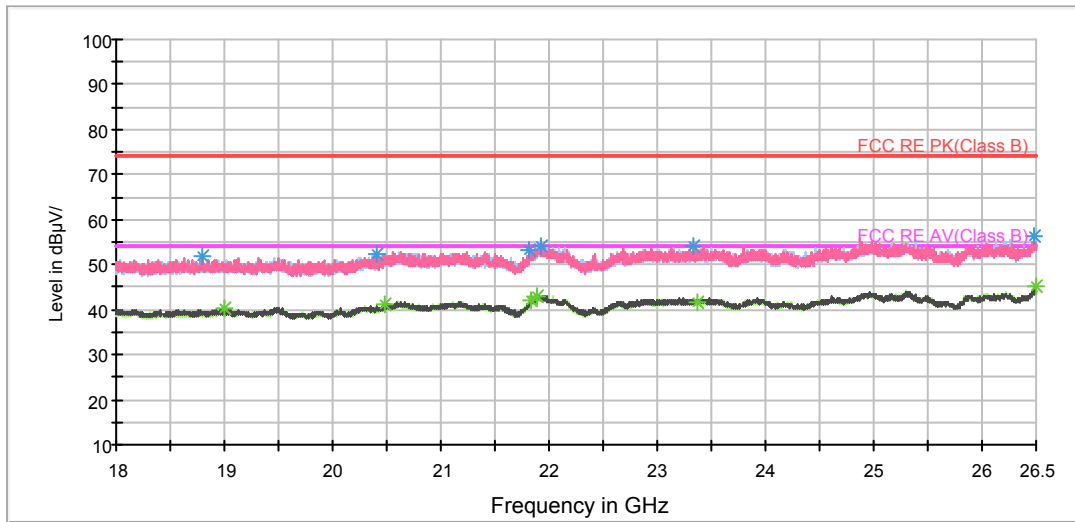

Radiates Emission from 18GHz to 26.5GHz

Frequency (MHz)	Peak (dBuV/m)	Height (cm)	Polarization	Azimuth (deg)	Reading value (dBuV/m)	Correct Factor (dB)	Margin (dB)	Limit (dBuV/m)
1197.250000	47.1	100.0	H	13.0	56.1	-9.0	26.9	74
1583.750000	42.0	100.0	H	173.0	49.7	-7.7	32.0	74
1798.250000	46.8	100.0	V	74.0	52.6	-5.8	27.2	74
1997.750000	52.5	100.0	V	356.0	58.0	-5.5	21.5	74
2194.000000	48.0	100.0	V	0.0	52.3	-4.3	26.0	74
2640.250000	45.7	100.0	V	147.0	48.0	-2.3	28.3	74

Remark: 1. Correction Factor = Antenna factor+ Insertion loss (cable loss + amplifier gain)

Frequency (MHz)	Average (dBuV/m)	Height (cm)	Polarization	Azimuth (deg)	Reading value (dBuV/m)	Correct Factor (dB)	Margin (dB)	Limit (dBuV/m)
1199.250000	31.4	100.0	H	25.0	40.4	-9.0	22.6	54
1584.000000	37.9	100.0	V	264.0	45.6	-7.7	16.1	54
1799.750000	31.9	100.0	V	66.0	37.6	-5.7	22.1	54
1991.000000	35.5	100.0	V	342.0	41.0	-5.5	18.5	54
2196.000000	32.8	100.0	V	342.0	37.1	-4.3	21.2	54
2640.250000	41.1	100.0	V	147.0	43.4	-2.3	12.9	54

Remark: 1. Correction Factor = Antenna factor+ Insertion loss (cable loss + amplifier gain)

5.8. Conducted Emission

Ambient condition

Temperature	Relative humidity	Pressure
23°C ~25°C	45%~50%	101.5kPa

Methods of Measurement

The EUT is placed on a non-metallic table of 80cm height above the horizontal metal reference ground plane. During the test, the EUT was operating in its typical mode. The test method is according to ANSI C63.10-2013. Connect the AC power line of the EUT to the L.I.S.N. Use EMI receiver to detect the average and Quasi-peak value. RBW is set to 9 kHz, VBW is set to 30kHz. The measurement result should include both L line and N line.

The test is in transmitting mode.

Test Setup

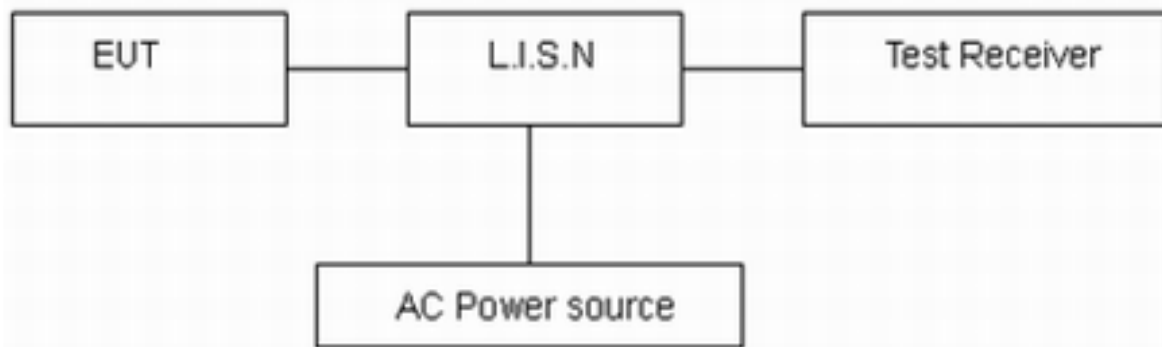

Note: AC Power source is used to change the voltage 110V/60Hz.

Limits

Frequency (MHz)	Conducted Limits(dBμV)	
	Quasi-peak	Average
0.15 - 0.5	66 to 56 *	56 to 46*
0.5 - 5	56	46
5 - 30	60	50

*: Decreases with the logarithm of the frequency.

Measurement Uncertainty

The assessed measurement uncertainty to ensure 95% confidence level for the normal distribution is with the coverage factor $k = 1.96$, $U = 2.69$ dB.

Test Results:

Following plots, Blue trace uses the peak detection and Green trace uses the average detection. During the test, the Conducted Emission was performed in all modes with all channels, 802.11g, Channel 11 are selected as the worst condition. The test data of the worst-case condition was recorded in this report.

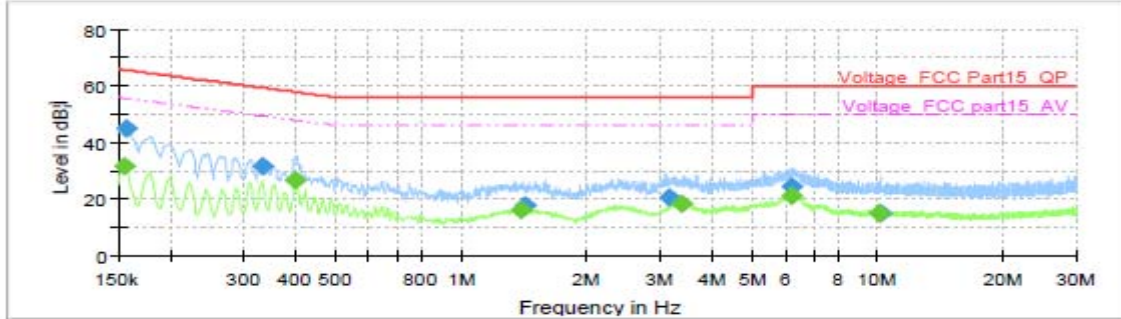

Frequency (MHz)	QuasiPeak (dB; μ V)	Average (dB; μ V)	Limit (dB; μ V)	Margin (dB)	Meas. Time (ms)	Bandwidth (kHz)	Line	Filter	Corr. (dB)
0.154500	---	31.52	55.75	24.24	1000.0	9.000	L1	ON	19.6
0.156750	45.24	---	65.63	20.39	1000.0	9.000	L1	ON	19.6
0.332250	31.85	---	59.40	27.55	1000.0	9.000	L1	ON	19.6
0.399750	---	26.83	47.86	21.03	1000.0	9.000	L1	ON	19.6
1.387500	---	15.89	46.00	30.11	1000.0	9.000	L1	ON	19.6
1.416750	17.92	---	56.00	38.08	1000.0	9.000	L1	ON	19.6
3.147000	20.59	---	56.00	35.41	1000.0	9.000	L1	ON	19.6
3.365250	---	18.07	46.00	27.93	1000.0	9.000	L1	ON	19.6
6.198000	24.61	---	60.00	35.39	1000.0	9.000	L1	ON	19.7
6.220500	---	21.23	50.00	28.77	1000.0	9.000	L1	ON	19.7
10.110750	---	14.79	50.00	35.21	1000.0	9.000	L1	ON	19.9
10.137750	15.08	---	60.00	44.92	1000.0	9.000	L1	ON	19.9

L Line

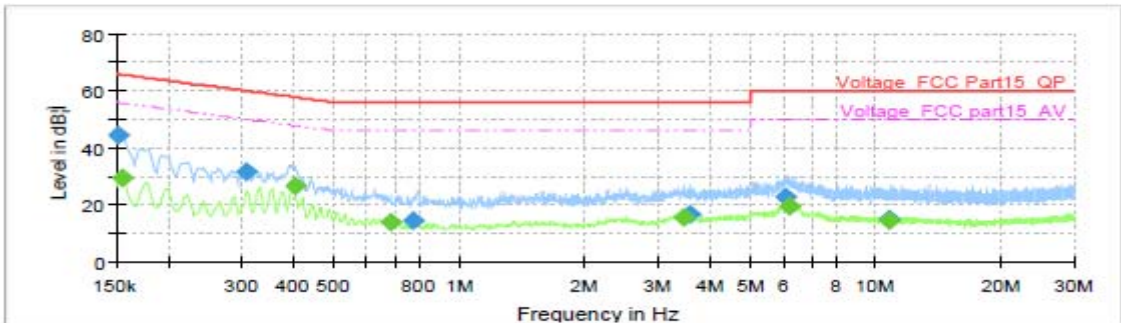

Frequency (MHz)	QuasiPeak (dB; μ V)	Average (dB; μ V)	Limit (dB; μ V)	Margin (dB)	Meas. Time (ms)	Bandwidth (kHz)	Line	Filter	Corr. (dB)
0.152250	44.53	---	65.88	21.35	1000.0	9.000	N	ON	19.7
0.154500	---	29.28	55.75	26.47	1000.0	9.000	N	ON	19.7
0.307500	31.47	---	60.04	28.57	1000.0	9.000	N	ON	19.6
0.402000	---	26.43	47.81	21.38	1000.0	9.000	N	ON	19.6
0.685500	---	13.79	46.00	32.21	1000.0	9.000	N	ON	19.6
0.777750	14.52	---	56.00	41.48	1000.0	9.000	N	ON	19.6
3.446250	---	15.41	46.00	30.59	1000.0	9.000	N	ON	19.6
3.572250	16.70	---	56.00	39.30	1000.0	9.000	N	ON	19.6
6.067500	22.61	---	60.00	37.39	1000.0	9.000	N	ON	19.7
6.186750	---	19.24	50.00	30.76	1000.0	9.000	N	ON	19.7
10.819500	---	14.68	50.00	35.32	1000.0	9.000	N	ON	19.9
10.835250	14.97	---	60.00	45.03	1000.0	9.000	N	ON	19.9

N Line



6. Main Test Instruments

Name	Manufacturer	Type	Serial Number	Calibration Date	Expiration Date
Spectrum Analyzer	R&S	FSV30	100815	2016-12-16	2017-12-15
EMI Test Receiver	R&S	ESCI	100948	2017-05-20	2018-05-19
TRILOG Broadband Antenna	SCHWARZBECK	VULB 9163	9163-201	2014-12-06	2017-12-05
TRILOG Broadband Antenna	SCHWARZBECK	VUBL 9163	9163-201	2017-11-18	2020-11-17
Double Ridged Waveguide Horn Antenna	R&S	HF907	100126	2014-12-06	2019-12-05
Loop Antenna	SCHWARZBECK	FMZB1519	1519-047	2017-02-18	2020-02-17
Standard Gain Horn	ETS-Lindgren	3160-09	00102644	2015-01-30	2018-01-29
EMI Test Receiver	R&S	ESCS30	100138	2016-12-16	2017-12-15
LISN	R&S	ENV216	101171	2016-12-16	2019-12-15
Spectrum Analyzer	Agilent	N9010A	MY47191109	2017-05-20	2018-05-19
RF Cable	Agilent	SMA 15cm	0001	2017-08-04	2018-02-03
Software (CE)	ROHDE&SCHW ARZ	EMC32	9.26.0	/	/
Software (RE/RSE)	ROHDE&SCHW ARZ	EMC32	8.52.0	/	/

*****END OF REPORT *****