

**aiwa<sup>®</sup>**

EXOS-9

Quick Start Guide

# THANK YOU.

We've resurrected the iconic Aiwa brand in the passionate pursuit of bringing people together around music. We do this with a simple formula; creating amazing speakers that deliver the music you love, the way it was meant to be heard.

We're thrilled that you've chosen the Exos-9 to enhance your listening experience. Welcome to the Aiwa family.

The Aiwa logo is rendered in a bold, black, lowercase serif font. The letters are thick and closely spaced, with a registered trademark symbol (®) positioned at the top right of the final 'a'.

**aiwa<sup>®</sup>**

# GETTING STARTED - BATTERY

Setting up your Exos-9 couldn't be easier. First, install the battery pack.

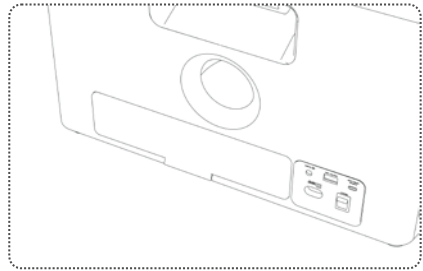
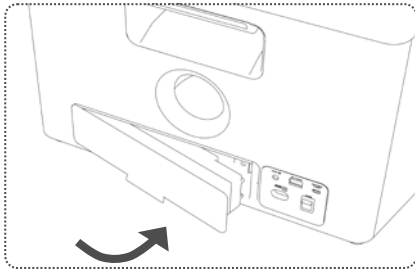

There is a small latch on the bottom of the unit that keeps the battery in place. When installing the battery, insert the tabs on the left first, and push the battery in until the latch clicks. To remove the battery, pull the catch on the latch outward.

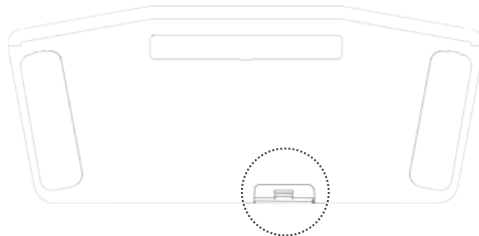

# GETTING STARTED - PAIRING

Connect the power cord to the back of the Exos-9 and turn the power on using the switch, located in the rear near the power cord. The screen will illuminate. Now you're ready to listen!

The Exos-9 is always available to pair - in other words, there is no need for "pairing mode." Just turn it on and search for it on your smartphone or other Bluetooth-capable device, or simply tap your phone to the NFC touch-point on top of the speaker.

The Exos-9 will remember the last 8 devices paired, and will automatically connect when in range and powered on.

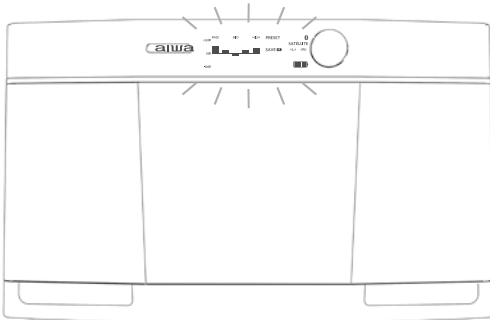

*Note: The LINK button is only for connecting two Exos-9 speakers in mirror or stereo mode. Since it's always in "pairing" mode, there is no need for an extra button to connect to your device.*

# GETTING STARTED - PAIRING

Make sure Bluetooth is active on your device. If your device supports NFC pairing, touch it to the NFC icon in the circle on top of the device, just to the right of the button panel.

Otherwise, search for nearby Bluetooth devices. The speaker will appear as "Aiwa Exos-9."

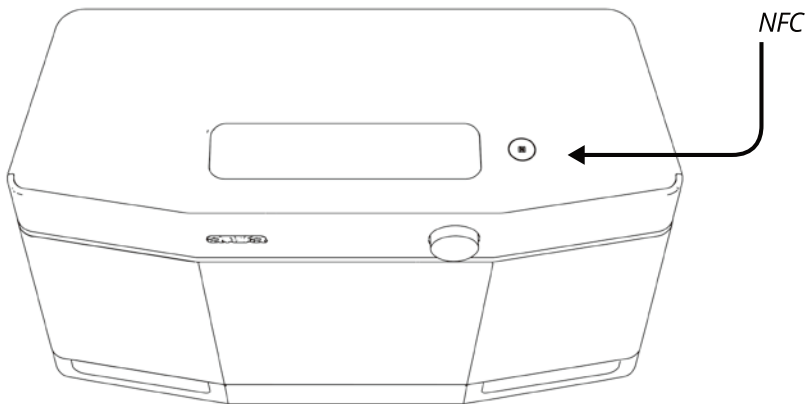

# GETTING STARTED - AUX-IN

The Exos-9 will automatically switch to Auxiliary input when you connect a device using the included 3.5mm cable.

However, this may be overridden if there is an active Bluetooth connection.

The screen will show "AUX IN" when this input is active. If it doesn't switch to the correct input automatically, hold the play/pause button on the speaker to switch inputs manually.

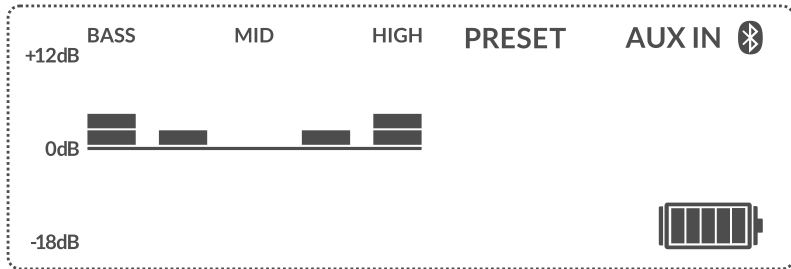

# GETTING STARTED - PLACEMENT

The Exos-9 will go anywhere you want great sound, but if you're looking for a more permanent spot to place the speaker, there are a couple things to keep in mind. Speakers with deep bass extension like the Exos-9 are affected by how close they are to the wall. Bass can be boosted if the back of the speaker is within a few feet of the wall, but if it's too close to the wall the bass may be dulled. If you would like to improve bass response, try moving the speaker, or adjust the bass using the equalizer.

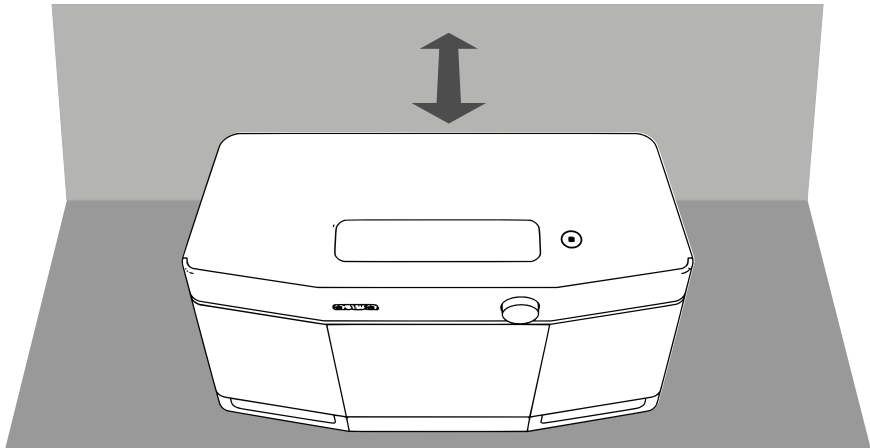

# AUXILIARY INPUT

Almost anything headphones can plug into can play through the Exos-9. MP3 players, CD players, radios, computers, televisions, phones, etc. can be connected with the included 3.5mm audio cable.

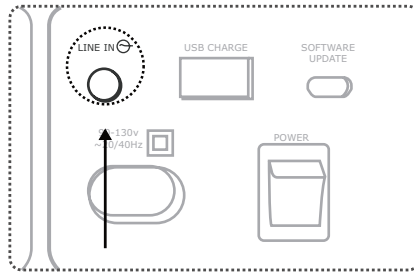



# BATTERY LIFE

The Exos-9 battery lasts for approximately 10 hours playing at moderate volume. Battery life varies with volume - as with all speakers, battery life decreases at a very high volumes.

To get more play time at very high volumes, use the Battery Save Mode. It targets and reduces audio frequencies that use the most power, and can increase battery life by up to 100%.



The screen turns off after 15 seconds of inactivity in order to save battery life. Press any button to light it up again.

# CHARGING / POWER

To charge the battery, connect the Exos-9 to AC power using the included power cord. The screen shows the charge level.

If you have a spare or extended battery, you can charge it when the Exos-9 is plugged in. You can swap a depleted battery with a previously charged one.

After 15 minutes of inactivity, the speaker will enter sleep mode to save power. While in sleep mode, it will not connect via Bluetooth or play audio. Connect via NFC or press one of the touch buttons on top of the speaker to wake it from sleep mode.

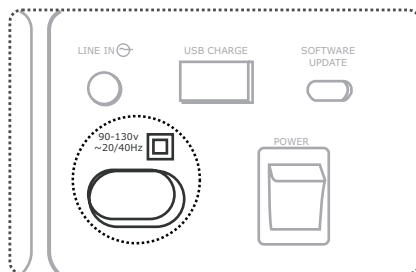

# USB PORTS

There are two USB ports on the Exos-9. The port labeled “USB Charge” can be used to charge your mobile device.

The Exos-9 firmware can be updated using the micro-USB port labeled “Software Update.” Check the Aiwa website ([www.aiwa.us.com](http://www.aiwa.us.com)) for instructions and new firmware versions.

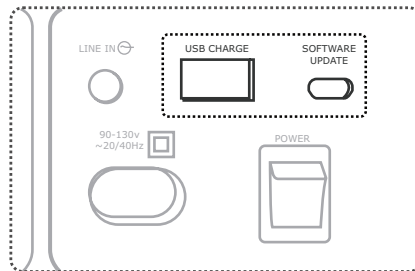

# EQUALIZER

The Exos-9 has a 5-band graphic equalizer so you can adjust the sound for your personal taste or room acoustics.

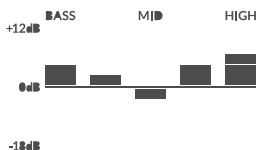

To adjust the equalizer, use the left and right arrows to select an EQ band. The currently selected band will blink. Press the up arrow to increase the gain on a given band, press the down arrow to decrease it.

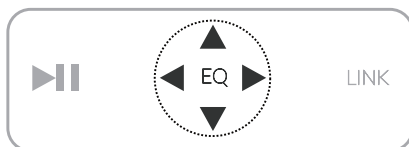

To select the EQ presets, Battery Save Mode, or to turn the EQ off, keep pressing the right arrow to make a selection.

**PRESET**

**1 2 3 4**

**SAVE** 

**EQ OFF**

*The Exos-9 has 4 built-in EQ presets to enhance your music. Preset 1 is for Rock, 2 is for Hip-Hop and Dance, 3 is for Jazz and 4 is for Classical.*

*Try them out and see what sounds best to you - these are only suggestions.*

# CONTROLS

## Play/Pause

*Controls playback of audio on your connected Bluetooth device. Does not affect playback through the auxiliary-in connection.*

## Link

*Two Exos-9 speakers can be wirelessly connected. Press LINK on both speakers within a few seconds to initiate the connection.*

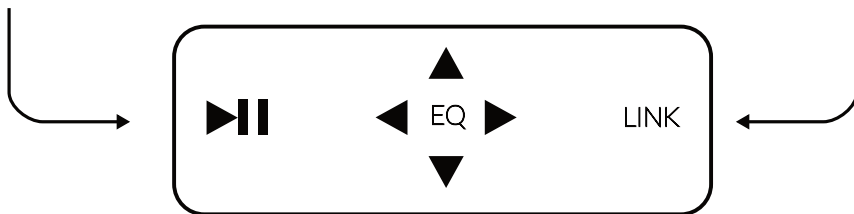

## EQ Controls

*Use the left/right arrows to select an EQ band or EQ preset. Use the up/down arrows to increase/decrease the gain when an EQ band is selected.*

# WIRELESSLY SYNC SPEAKERS

Simply press the LINK button on one Exos-9 and then press the LINK button on another Exos-9. As long as the two speakers are within about 20 feet of each other, you can listen to your favorite tunes in mirror or stereo mode.

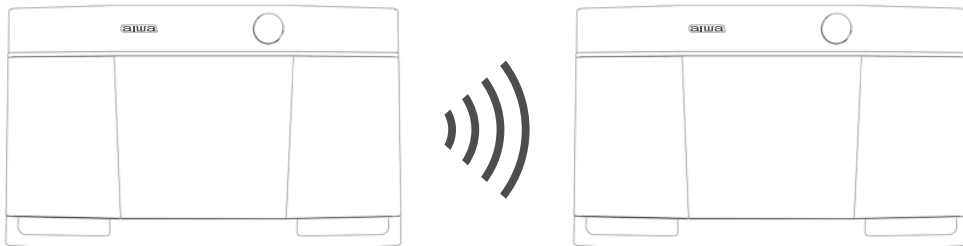

Once the two speakers are paired, press the LINK button to cycle through the channel modes. Choose from (L)(R), (L), or (R). Control the audio through the master speaker (the one without the SATELLITE icon illuminated) by using the onboard controls or the music source.

# CONTACT US

For more information about the warranty, and to find answers to frequently asked questions, please visit [www.aiwa.us.com](http://www.aiwa.us.com)

**Customer Service: [info@aiwa.us.com](mailto:info@aiwa.us.com)**

**Website: [aiwa.us.com](http://aiwa.us.com)**

**f [www.facebook.com/aiwa.us](http://www.facebook.com/aiwa.us)**

** [@Aiwa\\_US](https://twitter.com/Aiwa_US)**

** [@Aiwa\\_Audio](https://www.instagram.com/Aiwa_Audio)**

Bluetooth® and the Bluetooth® logo are registered trademarks of Bluetooth SIG, Inc.

Changes or modifications not expressly approved by the party responsible for compliance could void the user's authority to operate the equipment.

Model identification information:

Aiwa Exos-9 XXXX-XX

Model number: XXXX (X=blank, 0-9)

Power source country code: XX (X=blank, A-Z)

For example, Aiwa Exos-9 9001-US

# SAFETY GUIDELINES



1. Read all instructions
2. Do not use this apparatus near water.
3. Clean only with a dry cloth.
4. Do not use near any heat sources such as radiators, heat registers, stoves, or other apparatus that produce heat.
5. Unplug this device during lightning storms or when unused for long periods of time.
6. To completely disconnect the speaker from the AC mains, disconnect the power supply from the AC receptacle.

**WARNING:** To reduce the risk of fire or electrical shock, do not expose this device to rain or moisture. No naked flame sources, such as candles, should be placed on the product.

## FCC Statement

This equipment has been tested and found to comply with the limits for a Class B digital device, pursuant to part 15 of the FCC Rules. These limits are designed to provide reasonable protection against harmful interference in a residential installation. This equipment generates, uses and can radiate radio frequency energy and if not installed and used in accordance with the instructions, may cause harmful interference to radio communications. However, there is no guarantee that interference will not occur in a particular installation. If this equipment does cause harmful interference to radio or television reception, which can be determined by turning the equipment off and on, the user is encouraged to try and correct the interference by one or more of the following measures.

- Reorient or relocate the receiving antenna.
- Increase the separation between the equipment and receiver.
- Connect the equipment into an outlet on a circuit different from that to which the receiver is connected.
- Consult the dealer or an experienced radio/TV technician for help.

## FCC Radiation Exposure Statement

This device complies with FCC radiation exposure limits set forth for an uncontrolled environment and it also complies with Part 15 of the FCC RF Rules. This equipment must be installed and operated in accordance with provided instructions and the antenna(s) used for this transmitter must be installed to provide a separation distance of at least 20cm from all persons and must not be co-located or operating in conjunction with any other antenna or transmitter. End-users and installers must be provided with antenna installation instructions and consider removing the no-collocation statement.