

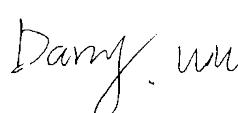

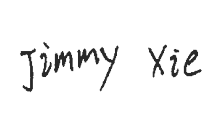

TEST REPORT

Report No.:	E20190710414501-1	Application No.:	E20190710414501
Applicant:	Huizhou Desay SV Automotive Co., Ltd.		
Address:	NO.103, Hechang 5th Road West, Zhongkai National Hi-tech Industrial Development Zone, Huizhou, Guangdong, P.R. China		
Sample Description:	Car Radio		
Model:	Radio Ultra Low Touch DAB		
Adding Model:	Radio Ultra Low Touch		
Test Specification:	FCC 47 CFR Part 15 Subpart C		
Test Date:	2019-08-16 to 2019-10-24		
Issue Date:	2019-11-05		
Test Result:	PASS		
Prepared By:	Reviewed By:	Approved By:	
Darry Wu / Test Engineer	Jimmy Xie / Technical Manager	Ryan Zhu / Manager	
			
Date:2019-11-05	Date:2019-11-05	Date:2019-11-05	
Other Aspects:			
/			
Abbreviations: ok / P = passed; fail / F = failed; n.a. / N = not applicable			
The test result in this test report refers exclusively to the presented test sample. This report shall not be reproduced except in full, without the written approval of GRGT.			

DIRECTIONS OF TEST

1. This company carries out test task according to the national regulation of verifications which can be traced to National Primary Standards and BIPM.
2. The test report merely corresponds to the test sample. It is not permitted to copy extracts of these test result without the written permission of the test laboratory.
3. If there is any objection concerning the test, the client should inform the laboratory within 15 days from the date of receiving the test report.

TABLE OF CONTENTS

1. TEST RESULT SUMMARY	5
2. GENERAL DESCRIPTION OF EUT.....	6
2.1. APPLICANT	6
2.2. MANUFACTURER	6
2.3. FACTORY	6
2.4. BASIC DESCRIPTION OF EQUIPMENT UNDER TEST	6
2.5. TEST OPERATION MODE	7
2.6. LOCAL SUPPORTIVE.....	8
3. LABORATORY AND ACCREDITATIONS	9
3.1. LABORATORY	9
3.2. ACCREDITATIONS	9
3.3. MEASUREMENT UNCERTAINTY	9
4. LIST OF USED TEST EQUIPMENT AT GRGT.....	10
5. TEST RESULTS	11
5.1. E.U.T. TEST CONDITIONS	11
5.2. ANTENNA REQUIREMENT	13
5.3. 20dB BANDWIDTH.....	14
5.3.1. LIMITS.....	14
5.3.2. TEST PROCEDURES.....	14
5.3.3. TEST SETUP	14
5.3.4. TEST RESULTS	15
5.4. CARRIER FREQUENCIES SEPARATED	19
5.4.1. LIMITS.....	19
5.4.2. TEST PROCEDURES.....	19
5.4.3. TEST SETUP	19
5.4.4. TEST RESULTS	19
5.5. HOPPING CHANNEL NUMBER	22
5.5.1. LIMITS.....	22
5.5.2. TEST PROCEDURES.....	22
5.5.3. TEST SETUP	22
5.5.4. TEST RESULTS	22
5.6. DWELL TIME.....	24
5.6.1. LIMITS.....	24
5.6.2. TEST PROCEDURES.....	24
5.6.3. TEST SETUP	24
5.6.4. TEST RESULTS	24
5.7. CONDUCTED EMISSION MEASUREMENT.....	29
5.7.1. LIMITS.....	29
5.7.2. TEST PROCEDURES.....	29
5.7.3. TEST SETUP	30
5.7.4. DATA SAMPLE	30
5.7.5. TEST RESULTS	31
5.8. MAXIMUM PEAK OUTPUT POWER	33
5.8.1. LIMITS.....	33
5.8.2. TEST PROCEDURES.....	33
5.8.3. TEST SETUP	33
5.8.4. TEST RESULTS	34
5.9. CONDUCTED BAND EDGES AND SPURIOUS EMISSIONS.....	35
5.9.1. LIMITS.....	35
5.9.2. TEST PROCEDURES.....	35
5.9.3. TEST SETUP	35
5.9.4. TEST RESULTS	35
5.10. RADIATED SPURIOUS EMISSIONS.....	43
5.10.1. LIMITS.....	43
5.10.2. TEST PROCEDURES.....	43
5.10.3. TEST SETUP.....	44
5.10.4. DATA SAMPLE.....	45
5.10.5. TEST RESULTS	46

5.11. RESTRICTED BANDS OF OPERATION52

 5.11.1. LIMITS.....52

 5.11.2. TEST PROCEDURES52

 5.11.3. TEST SETUP.....53

 5.11.4. TEST RESULTS54

APPENDIX A: PHOTOGRAPH OF THE TEST ARRANGEMENT.....62

APPENDIX B: THECUSTOMER STATEMENT64

1. TEST RESULT SUMMARY

FCC 47 CFR Part 15 Subpart C			
Standard	Item	Limit / Severity	Result
FCC Part 15,Subpart C (15.247)	Antenna Requirement	Section 15.247 (b)(1)	PASS
	20dB Bandwidth	Section 15.247(a)(1)	PASS
	Carrier Frequencies Separated	Section 15.247(a)(1)	PASS
	Hopping Channel Number	Section 15.247(a)(1)(ii)	PASS
	Dwell Time	Section 15.247(a)(1)(iii)	PASS
	Maximum Peak Output Power	Section 15.247(b)(1)	PASS
	Conducted Emission	Section 15.207	PASS
	Conducted band edges and Spurious Emission (30MHz to 25GHz)	Section 15.209 &15.247(d)	PASS
	Radiated Spurious Emission (30MHz to 25GHz)	Section 15.209 &15.247(d)	PASS
	Restricted bands of operation	Section 15.247 (d) &15.205	PASS

2. GENERAL DESCRIPTION OF EUT

2.1. APPLICANT

Name: Huizhou Desay SV Automotive Co., Ltd.
Address: NO.103, Hechang 5th Road West, Zhongkai National Hi-tech Industrial Development Zone, Huizhou, Guangdong, P.R. China

2.2. MANUFACTURER

Name: Huizhou Desay SV Automotive Co., Ltd.
Address: NO.103, Hechang 5th Road West, Zhongkai National Hi-tech Industrial Development Zone, Huizhou, Guangdong, P.R. China

2.3. FACTORY

Factory 1

Name : Huizhou Desay SV Automotive Co., Ltd.
Address : NO.103, Hechang 5th Road West, Zhongkai National Hi-tech Industrial Development Zone, Huizhou, Guangdong, P.R. China

Factory 2

Name : Shinwa Precision Hungary Kft.
Address : 3534, Miskolc, Muhi u. 2/A, HUNGARY

2.4. BASIC DESCRIPTION OF EQUIPMENT UNDER TEST

Equipment: Car Radio
Model No.: Radio Ultra Low Touch DAB
Adding Model: Radio Ultra Low Touch
FCC ID: 2AEQT-2K7035130A
Trade Name: Volkswagen, DESAY SV AUTOMOTIVE
Power supply: Typical Voltage: DC +12V
Frequency Range: 2402MHz~2480MHz
Transmit Power: GFSK: 6.39dBm
 $\pi/4$ -DQPSK: 4.22dBm
8DPSK: 4.78dBm
Type of Modulation: FHSS (GFSK for 1Mbps, $\pi/4$ -DQPSK for 2Mbps, 8DPSK for 3Mbps)
Antenna Specification: Internal antenna with 0dBi gain (Max)

Temperature Range: -40 °C ~ +70 °C
Hardware Version: X02
Software Version: X011
I/O Port:
Note: /

2.5. TEST OPERATION MODE

Test Item	Mode No.	Description of the modes
Conducted Emission	1	Continuously Transmitting
Radiated Emission	1	Continuously Transmitting

2.6. LOCAL SUPPORTIVE

Name of Equipment	Manufacturer	Model	Serial Number	Note
Notebook	LENOVO	Lenovo Tian Yi 310-14ISK	MP18DLC6	/
Adapter	LENOVO	ADLX65NCC3A	N/A	/
DC power supply	QJE	QJ3003XE	018398	/
Cable				
AC Cable	/	/	/	Unshielded 1.00m
DC Cable	/	/	/	Shielded 1.80m

Test software:

Software version	Test level
Blue Test3	/

3. LABORATORY AND ACCREDITATIONS

3.1. LABORATORY

The tests and measurements refer to this report were performed by EMC Laboratory of GRG METROLOGY & TEST (SHENZHEN) CO., LTD

Add.: No. 1301, Guanguang Road, Xinlan Community, Guanlan Street, Longhua District, Shenzhen, 518110, People's Republic of China

Telephone: +86-755-61180008

Fax: /

3.2. ACCREDITATIONS

Our laboratories are accredited and approved by the following approval agencies.

A2LA	Certificate Number 2861.01
------	----------------------------

3.3. MEASUREMENT UNCERTAINTY

Where relevant, the following measurement uncertainty levels have been estimated for tests performed on the EUT as specified in CISPR 16-4-2:

Parameter	Uncertainty
Radiated Emission, 30 to 200 MHz Test Site : 966(2)	+/-3.6880dB
Radiated Emission, 200 to 1000 MHz Test Site : 966(2)	+/-3.6695dB
Radiated Emission, 1 to 8 GHz	+/-5.1782dB
Radiated Emission, 8 to 18 GHz	+/-5.2173dB
Conducted Emissions	+/-3.6836dB
Band Width	178kHz
Peak Output Power MU	+/-1.906dB
Band Edge MU	+/-0.182dB
Channel Separation MU	416.178Hz
Duty Cycle MU	0.054ms
Frequency Stability MU	226Hz

This uncertainty represents an expanded uncertainty factor of $k=2$.

4. LIST OF USED TEST EQUIPMENT AT GRGT

Name of Equipment	Manufacturer	Model	Serial Number	Calibration Due
Conducted Emissions				
EMI TEST Receiver	ROHDE&SCHWARZ	ESCI	100783	2020-01-10
LISN(EUT)	ROHDE&SCHWARZ	ENV216	101543	2020-01-10
Hygrothermograph	VICTOR	HTC-1	N/A	2019-12-25
Test S/W	FARAD	EZ-EMC/ CCS-3A1-CE		
Hopping Channel Number				
Spectrum Analyzer	Agilent	N9010A	MY52221469	2020-01-10
Dwell Time				
Spectrum Analyzer	Agilent	N9010A	MY52221469	2020-01-10
Radiated Spurious Emission& Restricted bands of operation				
ESPI Test Receiver	ROHDE&SCHWARZ	ESPI	101026	2020-01-09
Spectrum Analyzer	Agilent	N9010A	MY52221469	2020-01-10
Bilog Antenna	Schwarzbeck	VULB 9160	9160-3401	2019-12-21
Horn Antenna	Schwarzbeck	BBHA9120	D286	2019-12-21
Board-Band Horn Antenna	Schwarzbeck	BBHA 9170	9170-497	2020-01-15
Amplifier	EM Electronics Corporation	EM330	060661	2019-12-21
High Noise Amplifier	Agilent	8449B	3008A02060	2019-12-21
20 dB Bandwidth				
Spectrum Analyzer	Agilent	N9010A	MY52221469	2020-01-10
Maximum Peak Output Power				
Spectrum Analyzer	Agilent	N9010A	MY52221469	2020-01-10
Conducted band edges and Spurious Emission				
Spectrum Analyzer	Agilent	N9010A	MY52221469	2020-01-10
Carrier Frequencies Separated				
Spectrum Analyzer	Agilent	N9010A	MY52221469	2020-01-10

5. TEST RESULTS

5.1. E.U.T. TEST CONDITIONS

Type of antenna: Internal

Test frequencies: According to the 15.31(m) Measurements on intentional radiators or receivers, other than TV broadcast receivers, shall be performed and, if required, reported for each band in which the device can be operated with the device operating at the number of frequencies in each band specified in the following table:

Frequency range over which device operates	Number of frequencies	Location in the range of operation
1 MHz or less	1	Middle
1 to 10 MHz	2	1 near top and 1 near bottom
More than 10 MHz	3	1 near top, 1 near middle and 1 near bottom

EUT channels and frequencies list:

Channel	Frequency (MHz)	Channel	Frequency (MHz)	Channel	Frequency (MHz)
0	2402	14	2416	28	2430
1	2403	15	2417	29	2431
2	2404	16	2418	30	2432
3	2405	17	2419	31	2433
4	2406	18	2420	32	2434
5	2407	19	2421	33	2435
6	2408	20	2422	34	2436
7	2409	21	2423	35	2437
8	2410	22	2424	36	2438
9	2411	23	2425	37	2439
10	2412	24	2426	38	2440
11	2413	25	2427	39	2441
12	2414	26	2428	40	2442
13	2415	27	2429	41	2443

Channel	Frequency (MHz)	Channel	Frequency (MHz)	Channel	Frequency (MHz)
42	2444	55	2457	68	2470
43	2445	56	2458	69	2471
44	2446	57	2459	70	2472
45	2447	58	2460	71	2473
46	2448	59	2461	72	2474
47	2449	60	2462	73	2475
48	2450	61	2463	74	2476
49	2451	62	2464	75	2477
50	2452	63	2465	76	2478
51	2453	64	2466	77	2479
52	2454	65	2467	78	2480
53	2455	66	2468		
54	2456	67	2469		

Test frequency is the lowest channel: 0 channel(2402MHz), middle channel: 39 channel(2441MHz) and highest channel: 78 channel(2480MHz)

5.2. ANTENNA REQUIREMENT

The EUT antenna is internal antenna. Max Antenna gain is 0dBi .which accordance 15.203.is considered sufficient to comply with the provisions of this section

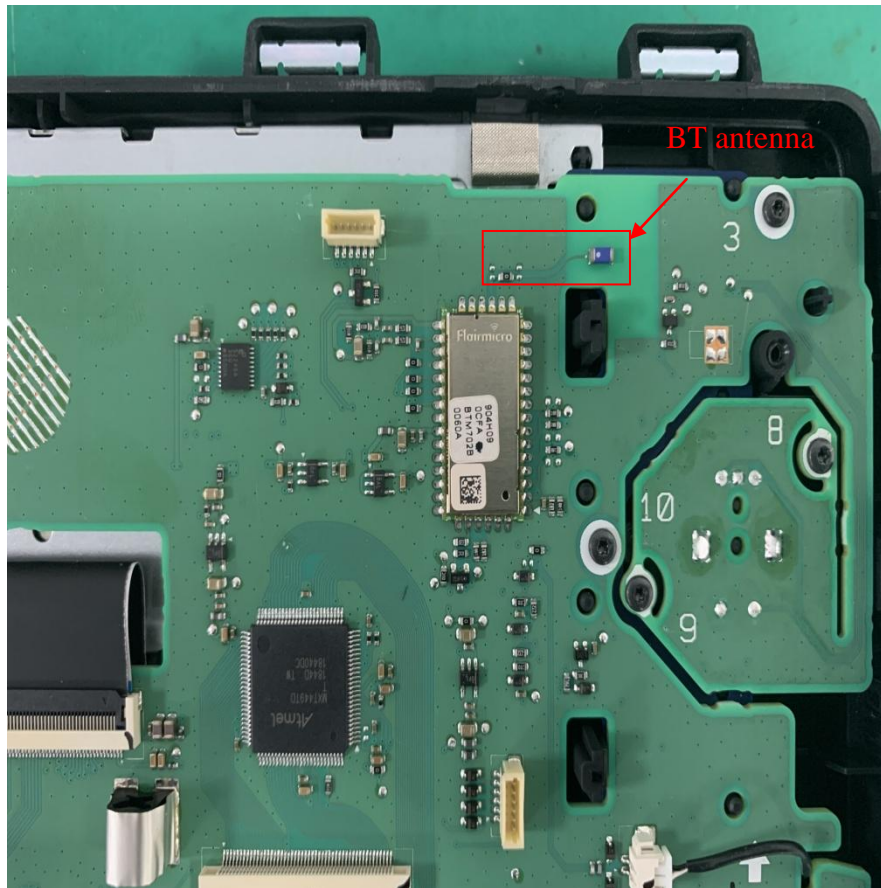

5.3. 20dB BANDWIDTH

5.3.1. LIMITS

Frequency hopping systems operating in the 2400-2483.5 MHz band may have hopping channel carrier frequencies that are separated by 25 kHz or two-thirds of the 20 dB bandwidth of the hopping channel, whichever is greater, provided the systems operate with an output power no greater than 125 mW.

5.3.2. TEST PROCEDURES

- 1) Remove the antenna from the EUT, and then connect a low loss RF cable from antenna port to the spectrum analyzer.
- 2) Set the spectrum analyzer as RBW=30 kHz, VBW=100 kHz, Span=3MHz, Sweep = auto. Allow the trace to stabilize, record 20dB bandwidth value
- 3) Repeat until all the test channels are investigated.

Remark:

Pre-test the 3 modulation to find GFSK and 8DPSK is worse case, so only record GFSK and 8DPSK test data.

5.3.3. TEST SETUP

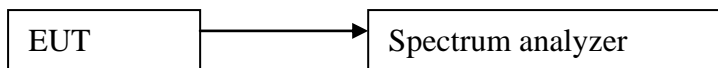

5.3.4. TEST RESULTS

Test mode	Channel	Frequency (MHz)	20 dB Bandwidth (kHz)
GFSK	Low	2402	944.8
	Mid	2441	944.9
	High	2480	944.4

Test mode	Channel	Frequency (MHz)	20 dB Bandwidth (kHz)
8DPSK	Low	2402	1255
	Mid	2441	1255
	High	2480	1255

Result plot as follows:

GFSK
Low Channel

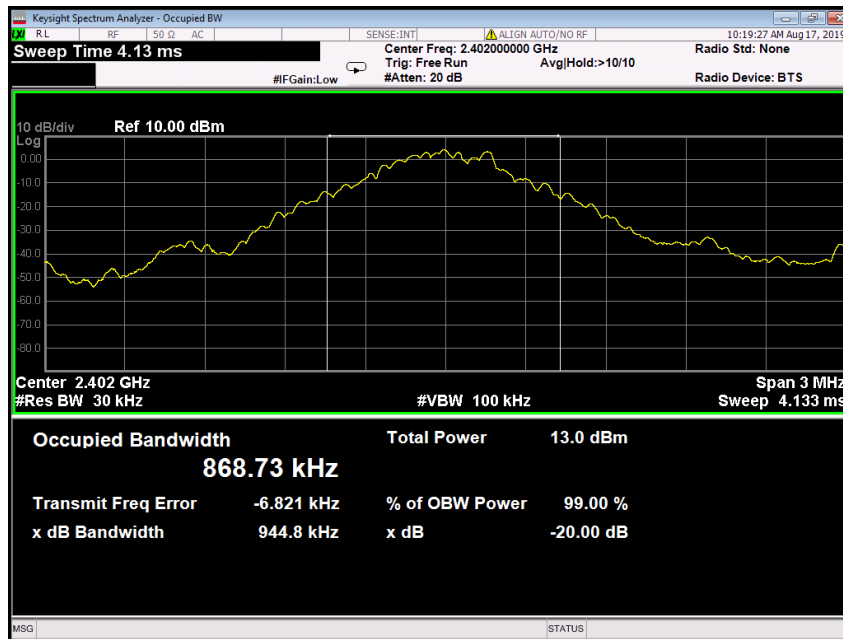

Mid Channel

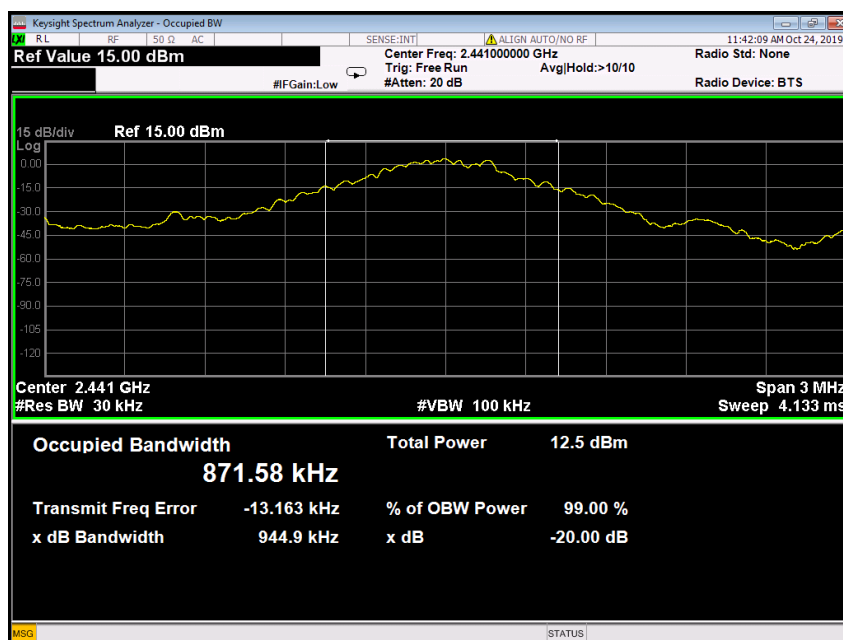

High Channel

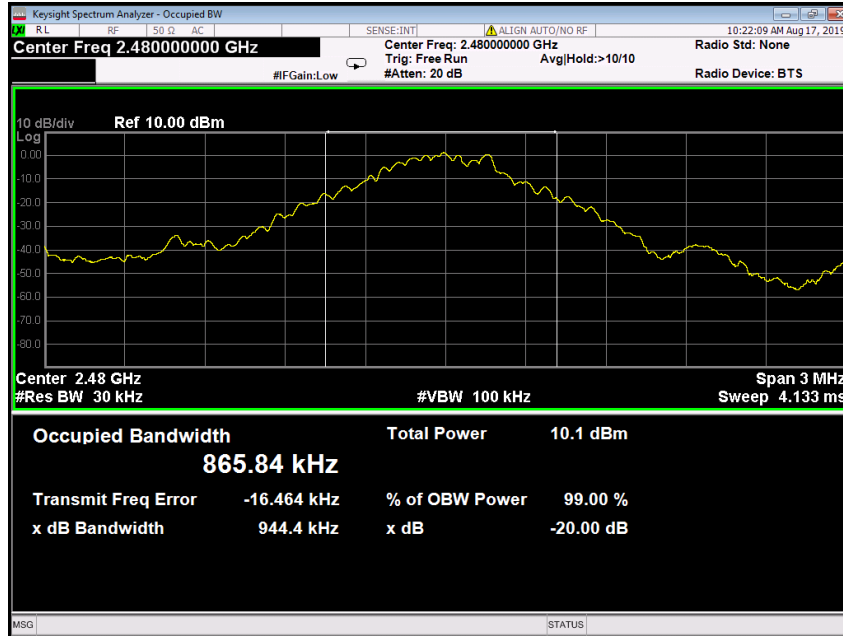

8DPSK

Low Channel

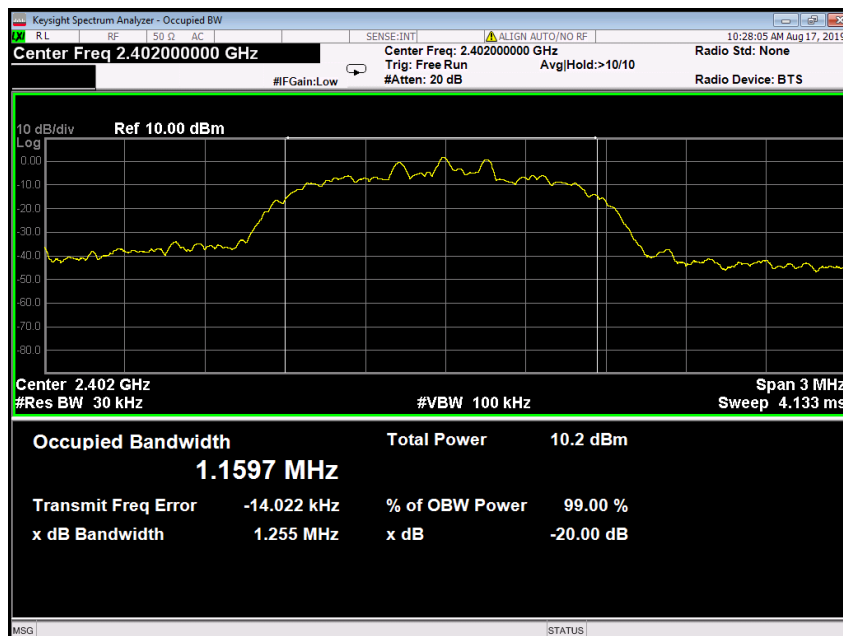

Mid Channel

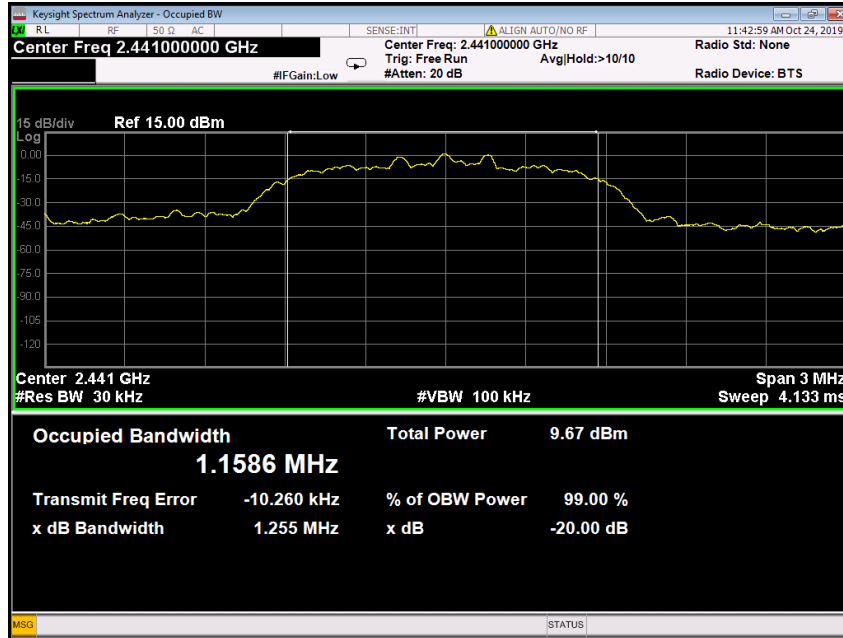

High Channel

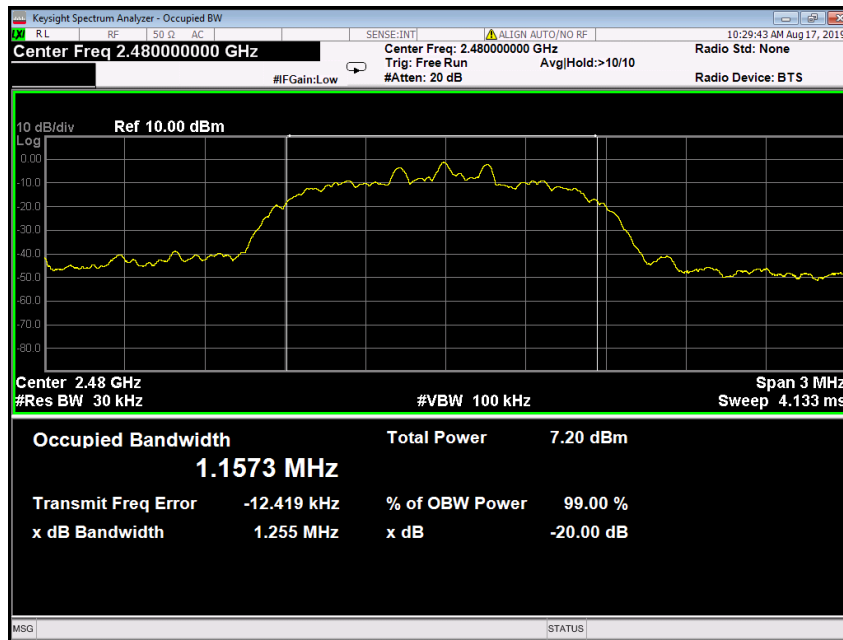

5.4. CARRIER FREQUENCIES SEPARATED

5.4.1. LIMITS

Frequency hopping systems operating in the 2400-2483.5 MHz band may have hopping channel carrier frequencies that are separated by 25 kHz or two-thirds of the 20 dB bandwidth of the hopping channel, whichever is greater, provided the systems operate with an output power no greater than 125 mW.

5.4.2. TEST PROCEDURES

- 1) Remove the antenna from the EUT and then connect a low loss RF cable from the antenna port to the spectrum analyzer.
- 2) Set center frequency of spectrum analyzer = middle of hopping channel.
- 3) Set the spectrum analyzer as RBW=30kHz, VBW=30kHz, Adjust Span to 3 MHz, Sweep = auto
- 4) Max hold. Mark 3 Peaks of hopping channel and record the 3 peaks frequency.

Remark :

Pre-test the 3 modulation to find GFSK and 8DPSK is worse case, so only record GFSK and 8DPSK test data.

5.4.3. TEST SETUP

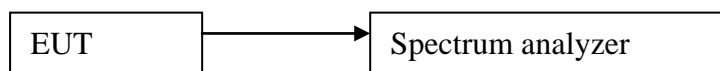

5.4.4. TEST RESULTS

GFSK

Channel Separation (MHz)	Two-thirds of the 20 dB Bandwidth (kHz)	Channel Separation Limit	Result
1.000	629.93	> Two-thirds of the 20 dB Bandwidth	Pass

8DPSK

Channel Separation (MHz)	Two-thirds of the 20 dB Bandwidth (kHz)	Channel Separation Limit	Result
1.000	836.67	> Two-thirds of the 20 dB Bandwidth	Pass

Result plot as follows:

GFSK Measurement of Channel Separation

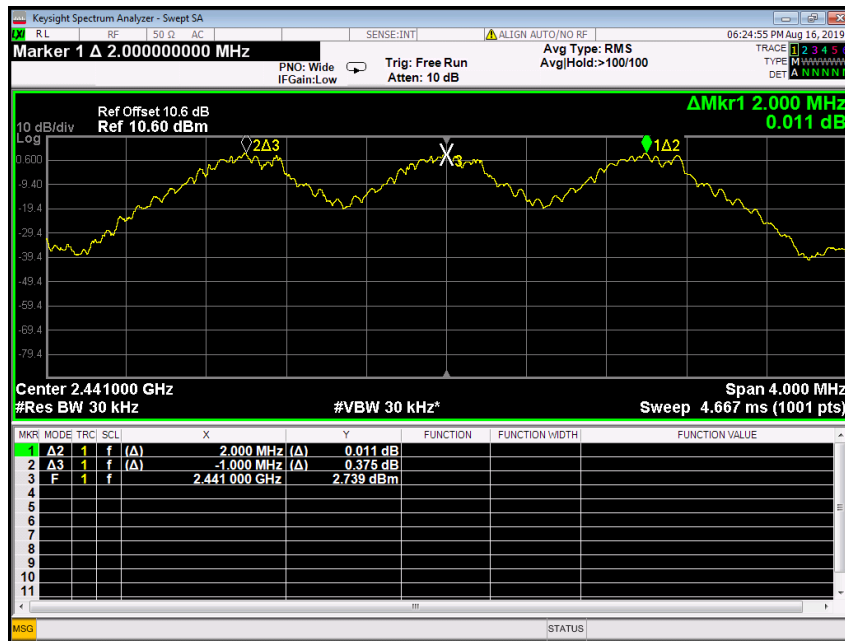

20 dB bandwidth(Middle channel)

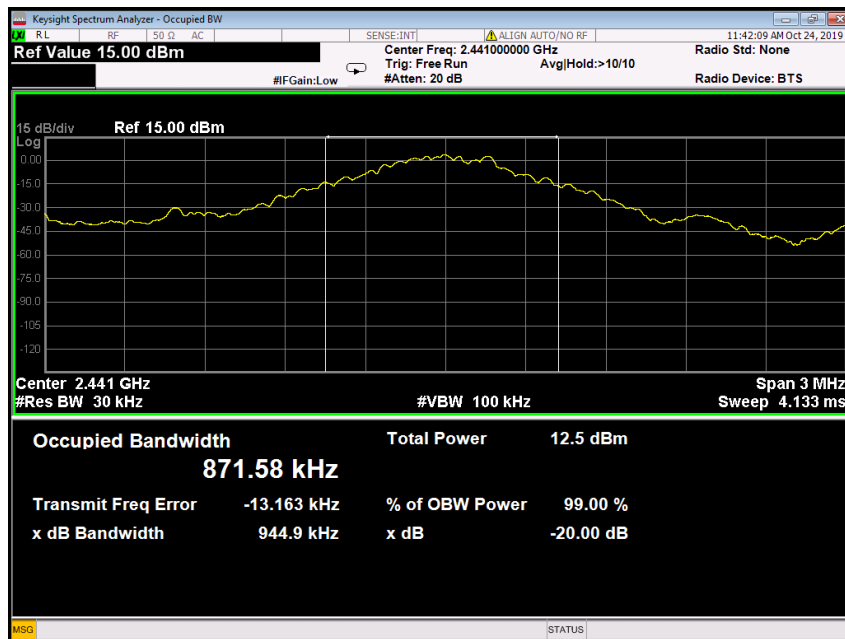

8DPSK

Measurement of Channel Separation

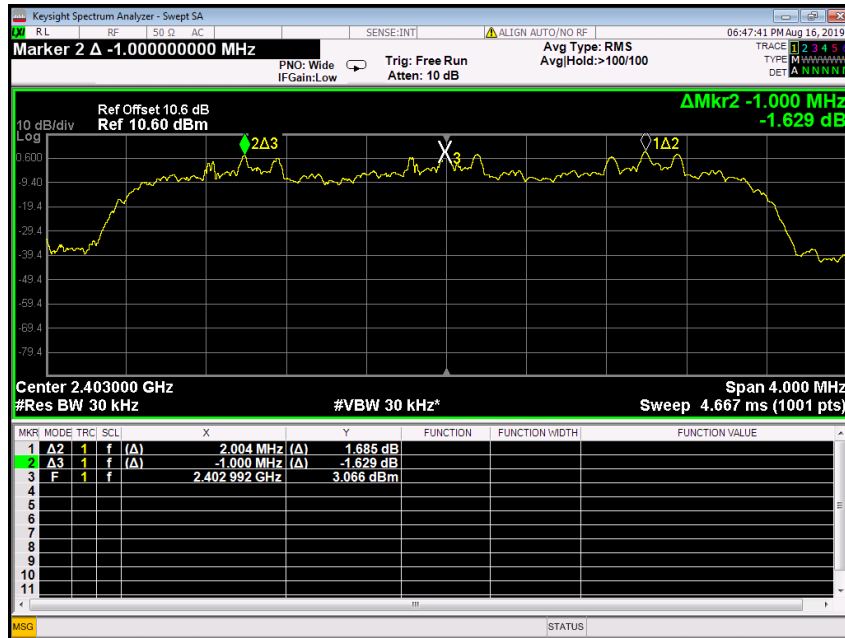

20 dB bandwidth(Lowest channel)

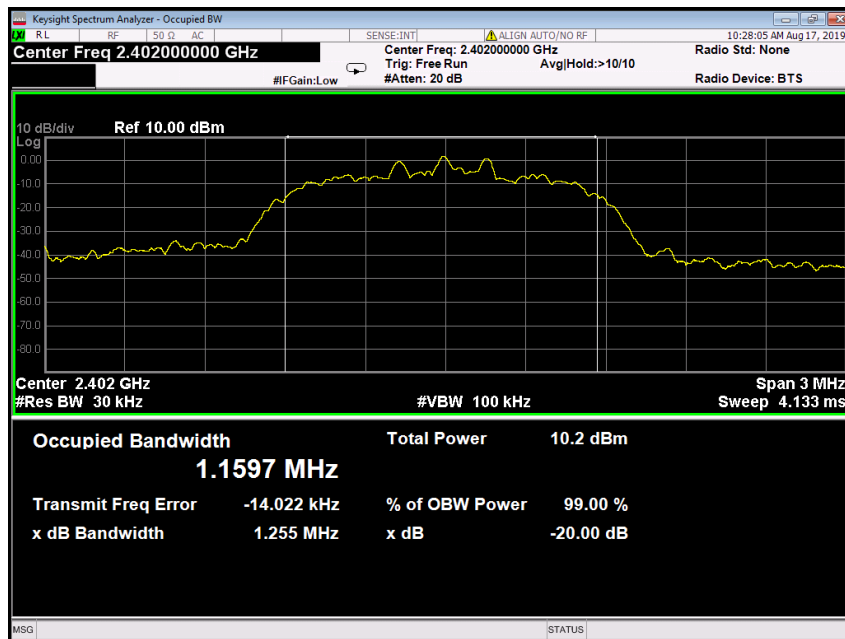

Test result: The unit does meet the FCC requirements.

5.5. HOPPING CHANNEL NUMBER

5.5.1. LIMITS

Regulation 15.247 (a) (1)(iii) Frequency hopping systems in the 2400-2483.5 MHz band shall use at least 15 channels.

5.5.2. TEST PROCEDURES

- 1) Remove the antenna from the EUT and then connect a low loss RF cable from the antenna port to the spectrum analyzer.
- 2) Set the spectrum analyzer as RBW, VBW=300kHz,
- 3) Set the spectrum analyzer: start frequency = 2400MHz. stop frequency = 2483.5MHz. Submit the test result graph.

5.5.3. TEST SETUP

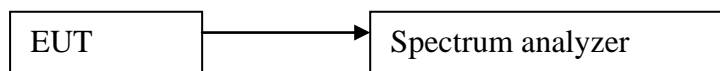

5.5.4. TEST RESULTS

Test result

Result (No. of CH)	Limit (No. of CH)	Result
79	>15	PASS

Result plot as follows:

GFSK

2.400 GHz – 2.4835 GHz

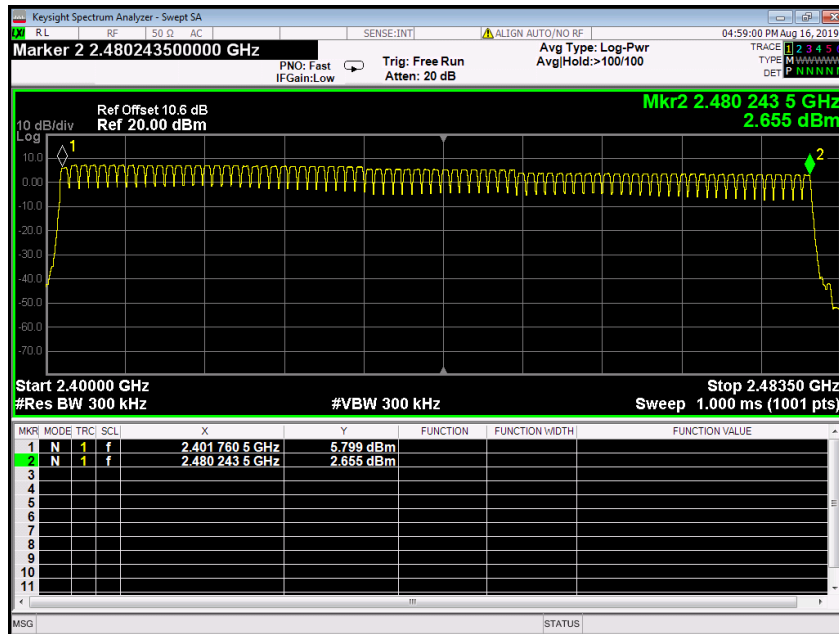

8DPSK

2.400 GHz – 2.4835 GHz

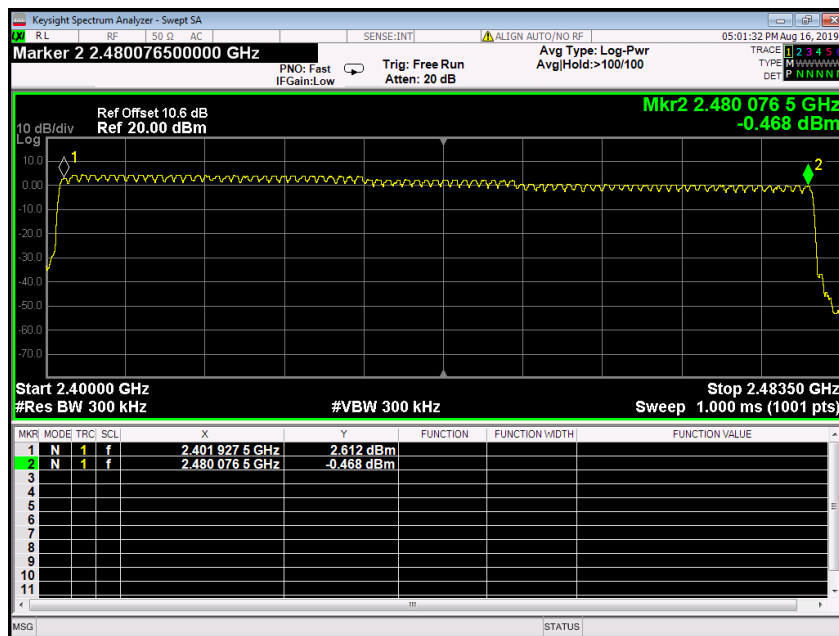

Test result: The unit does meet the FCC requirements.

5.6. DWELL TIME

5.6.1. LIMITS

Regulation 15.247(a)(1)(iii) Frequency hopping systems in the 2400-2483.5 MHz band shall use at least 15 channels. The average time of occupancy on any channel shall not be greater than 0.4 seconds within a period of 0.4 seconds multiplied by the number of hopping channels employed. Frequency hopping systems may avoid or suppress transmissions on a particular hopping frequency provided that a minimum of 15 channels are used.

5.6.2. TEST PROCEDURES

- 1) Remove the antenna from the EUT and then connect a low RF cable from the antenna port to the spectrum.
- 2) Set spectrum analyzer span = 0. centered on a hopping channel;
- 3) Set RBW = 1MHz and VBW = 3MHz. Sweep = as necessary to capture the entire dwell time per hopping channel. Detector Function = Peak. Trace = Max hold;
- 4) Use the marker-delta function to determine the dwell time. If this value varies with different modes of operation (e.g.. data rate. modulation format. etc.). Repeat this test for each variation. The limit is specified in one of the subparagraphs of this Section. Submit this plot(s). An oscilloscope may be used instead of a spectrum analyzer.

5.6.3. TEST SETUP

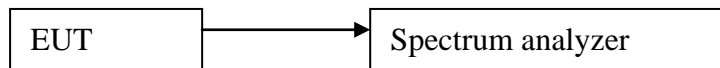

5.6.4. TEST RESULTS

The test period: $T = 0.4 \text{ Second/Channel} \times 79 \text{ Channel} = 31.6 \text{ s}$

GFSK: Mid Channel (2.441GHz)

DH1	time slot=	0.426	(ms)*	(1600/(2*79))	*	31.6	=	136.32	ms
DH3	time slot=	1.683	(ms)*	(1600/(4*79))	*	31.6	=	269.28	ms
DH5	time slot=	2.936	(ms)*	(1600/(6*79))	*	31.6	=	313.17	ms

8DPSK: Mid Channel (2.441GHz)

3DH1	time slot=	0.436	(ms)*	(1600/(2*79))	*	31.6	=	139.52	ms
3DH3	time slot=	1.686	(ms)*	(1600/(4*79))	*	31.6	=	269.76	ms
3DH5	time slot=	2.940	(ms)*	(1600/(6*79))	*	31.6	=	313.60	ms

The results are not greater than 0.4 seconds.

The unit does meet the requirements.

Please refer the graph as below:

GFSK
Mid Channel (2.441GHz)
DH1

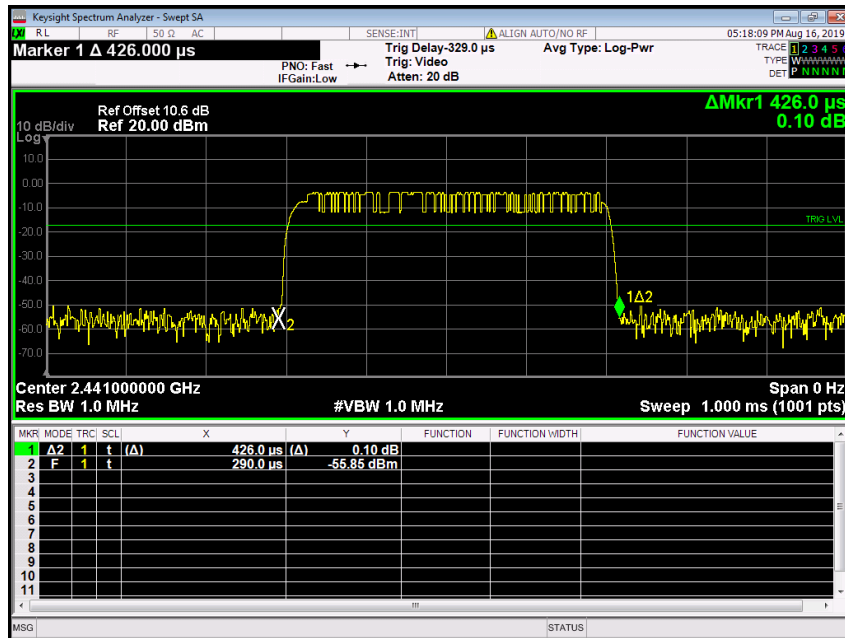

DH3

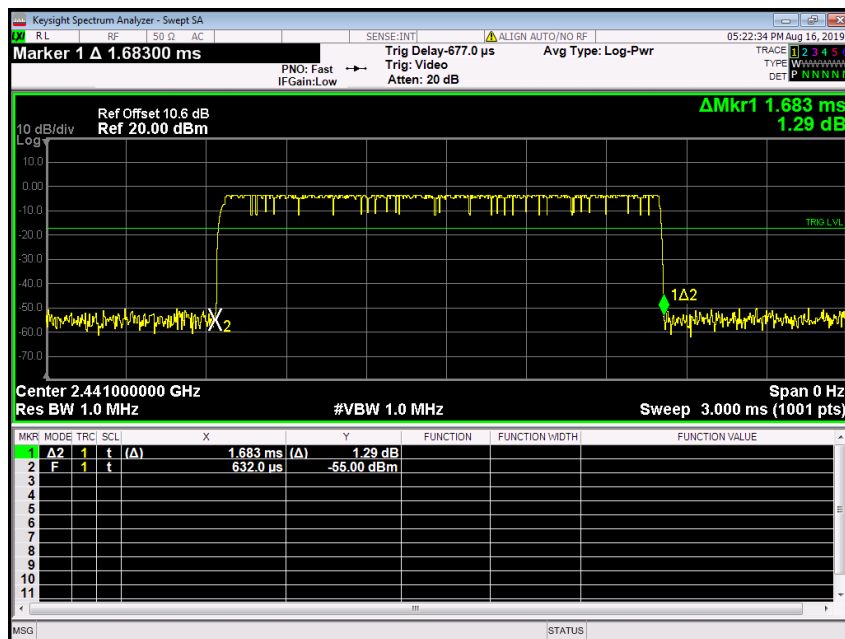

DH5

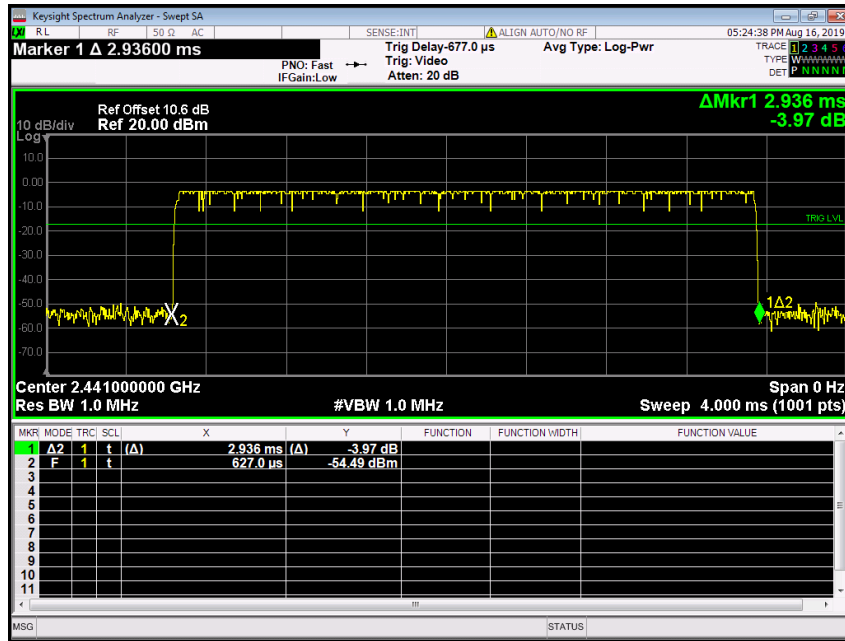

8DPSK
Mid Channel (2.441GHz)
3DH1

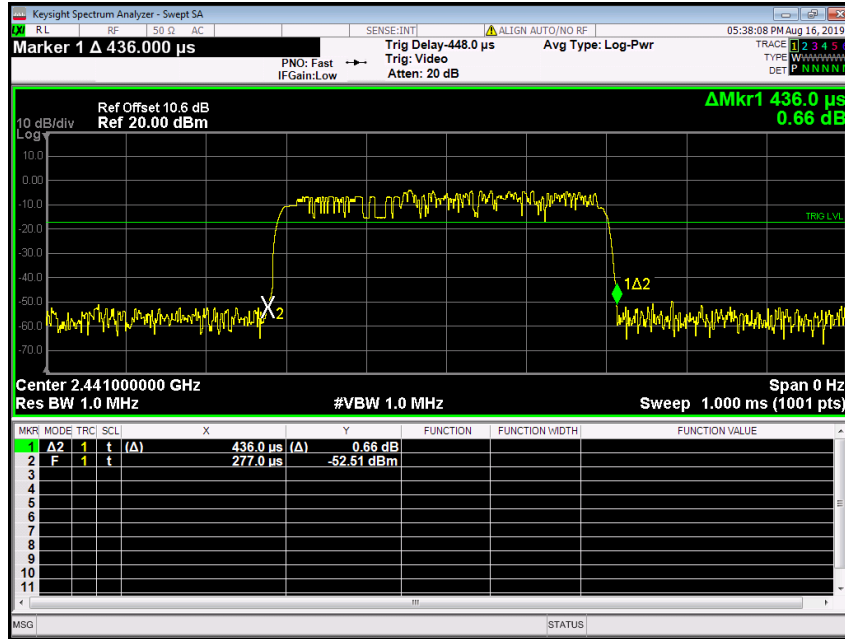

3DH3

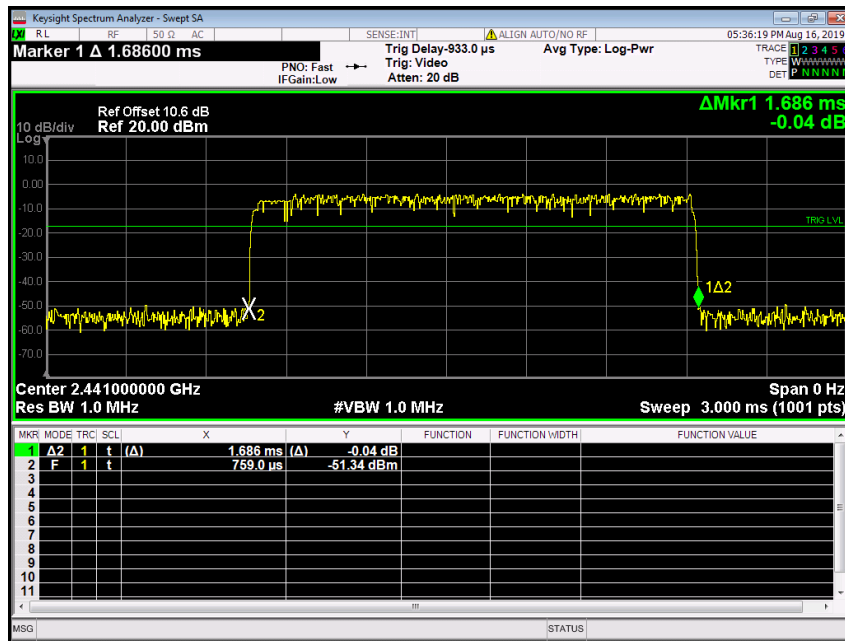

3DH5

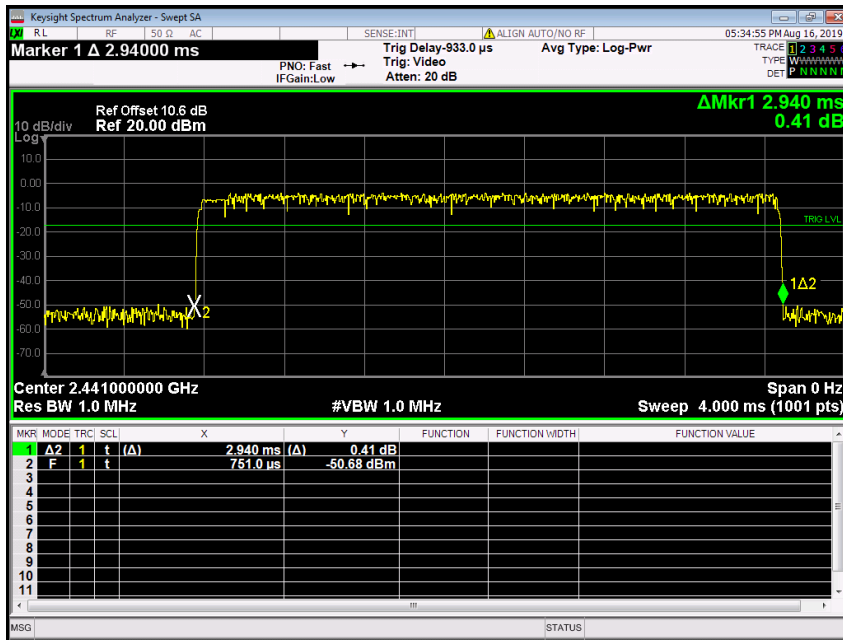

5.7. CONDUCTED EMISSION MEASUREMENT

5.7.1. LIMITS

Frequency range	Limits (dB μ V)	
	Quasi-peak	Average
150kHz ~ 0.5MHz	66~56	56~46
0.5 MHz ~ 5 MHz	56	46
5 MHz ~ 30 MHz	60	50

5.7.2. TEST PROCEDURES

Procedure of Preliminary Test

For measurement of the disturbance voltage the equipment under test (EUT) is connected to the power supply mains and any other extended network via one or more artificial network(s). An EUT, whether intended to be grounded or not, and which is to be used on a table is configured as follows:

- Either the bottom or the rear of the EUT shall be at a controlled distance of 40 cm from a reference ground plane. This ground plane is normally the wall or floor of a shielded room. It may also be a grounded metal plane of at least 2 m by 2 m. This is physically accomplished as follows:
 - 1) Place the EUT on a table of non-conducting material which is at least 80 cm high. Place the EUT so that it is 40 cm from the wall of the shielded room, or
 - 2) place the EUT on a table of non-conducting material which is 40 cm high so that the bottom of the EUT is 40 cm above the ground plane;
- All other conductive surfaces of the EUT shall be at least 80 cm from the reference ground plane;
- The EUT are placed on the floor that one side of the housings is 40 cm from the vertical reference ground plane and other metallic parts;
- Interconnecting cables that hang closer than 40 cm to the ground plane shall be folded back and forth forming a bundle 30 cm to 40 cm long, hanging approximately in the middle between the ground plane and the table.
- I/O cables that are connected to a peripheral shall be bundled in the centre. The end of the cable may be terminated if required using correct terminating impedance. The total length shall not exceed 1 m.

The test mode(s) described in Item 2.4 were scanned during the preliminary test. After the preliminary scan, we found the test mode described in Item 2.4 producing the highest emission level. The EUT configuration and cable configuration of the above highest emission levels were recorded for reference of the final test.

Procedure of Final Test

EUT and support equipment were set up on the test bench as per the configuration with highest emission level in the preliminary test. A scan was taken on both power lines, recording at least the six highest emissions. Emission frequency and amplitude were recorded into a computer in which correction factors were used to calculate the emission level and compare reading to the applicable limit. The test data of the worst-case condition(s) was recorded.

5.7.3. TEST SETUP

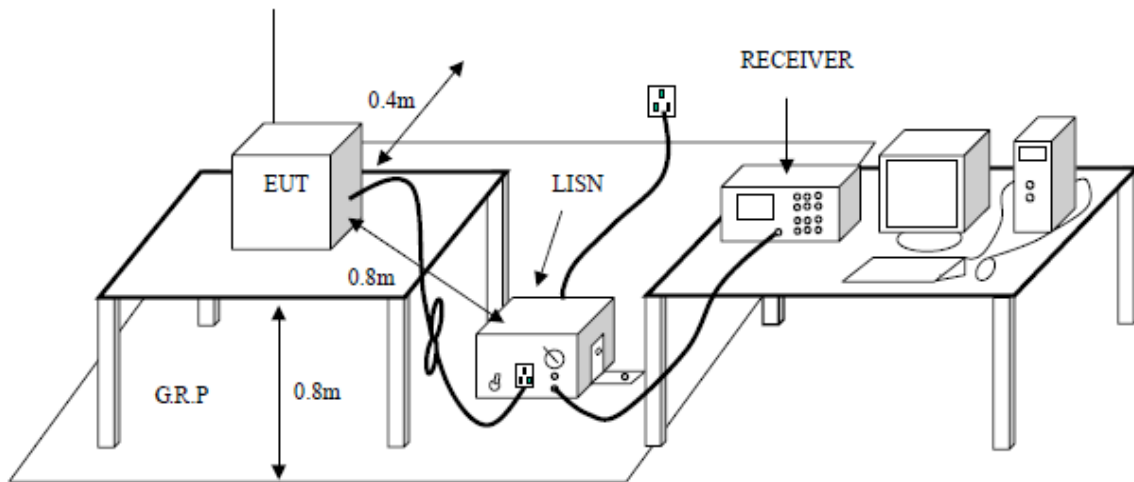

5.7.4. DATA SAMPLE

Frequency (MHz)	QuasiPeak Reading (dBuV)	Average Reading (dBuV)	Correction Factor (dB)	QuasiPeak Result (dBuV)	Average Result (dBuV)	QuasiPeak Limit (dBuV)	Average Limit (dBuV)	QuasiPeak Margin (dB)	Average Margin (dB)	Remark (Pass/Fail)
X.XXXX	32.69	25.65	11.52	44.21	37.17	65.78	55.79	-21.57	-18.62	Pass

- Factor = Insertion loss of LISN + Cable Loss
- Result = Quasi-peak Reading/ Average Reading + Factor
- Limit = Limit stated in standard
- Margin = Result (dBuV) – Limit (dBuV)

5.7.5. TEST RESULTS

Model No.	Radio Ultra Low Touch DAB	RBW,VBW	9 kHz
Environmental Conditions	26°C, 60% RH	Test Mode	Mode 1
Tested By	Luke Zhu	Line	L
Tested Date	2019-10-17	Test Voltage	DC12V

(The chart below shows the highest readings taken from the final data.)

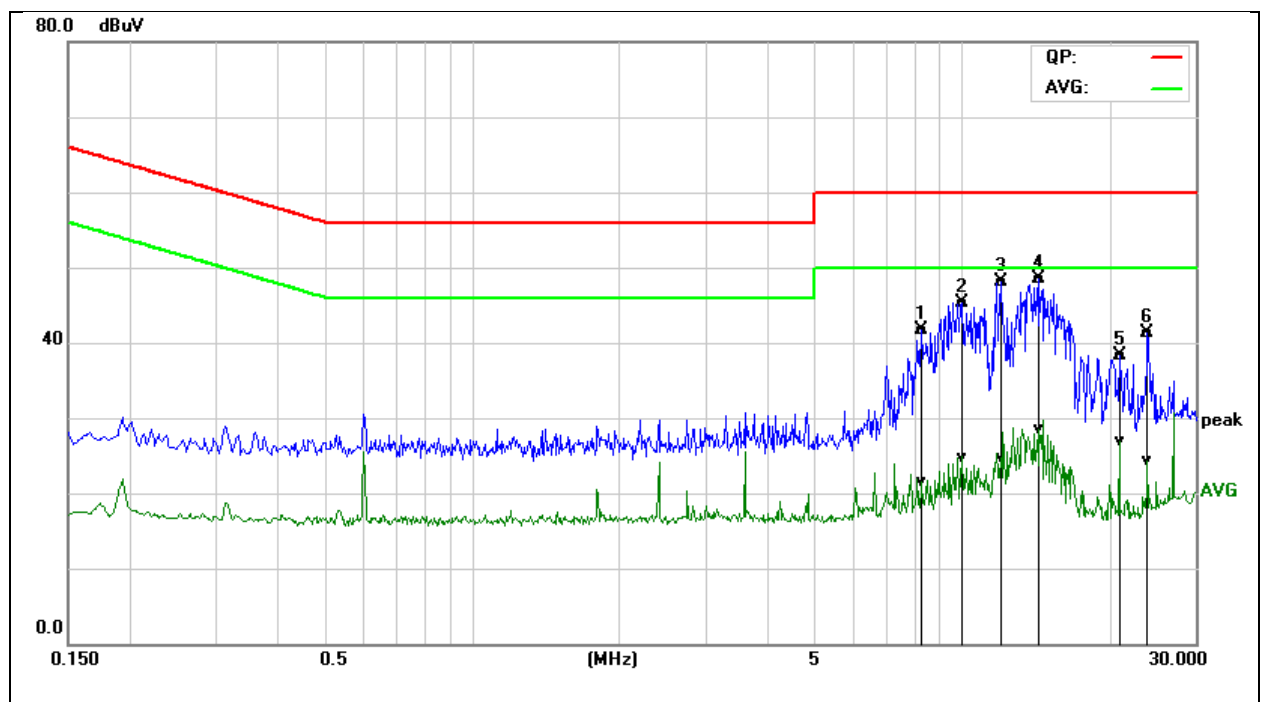

Frequency (MHz)	QuasiPeak Reading (dBuV)	Average Reading (dBuV)	Correction Factor (dB)	QuasiPeak Result (dBuV)	Average Result (dBuV)	QuasiPeak Limit (dBuV)	Average Limit (dBuV)	QuasiPeak Margin (dB)	Average Margin (dB)	Remark (Pass/Fail)
8.3220	21.69	1.53	20.06	41.75	21.59	60.00	50.00	-18.25	-28.41	Pass
9.9980	25.17	4.54	20.22	45.39	24.76	60.00	50.00	-14.61	-25.24	Pass
12.0020	27.96	4.58	20.09	48.05	24.67	60.00	50.00	-11.95	-25.33	Pass
14.3980	28.57	8.52	19.95	48.52	28.47	60.00	50.00	-11.48	-21.53	Pass
21.0020	18.45	6.98	19.93	38.38	26.91	60.00	50.00	-21.62	-23.09	Pass
24.0020	21.40	4.49	19.87	41.27	24.36	60.00	50.00	-18.73	-25.64	Pass

REMARKS: L = Live Line

Model No.	Radio Ultra Low Touch DAB	RBW,VBW	9 kHz
Environmental Conditions	26°C, 60% RH	Test Mode	Mode 1
Tested By	Luke Zhu	Line	N
Tested Date	2019-10-17	Test Voltage	DC12V

(The chart below shows the highest readings taken from the final data.)

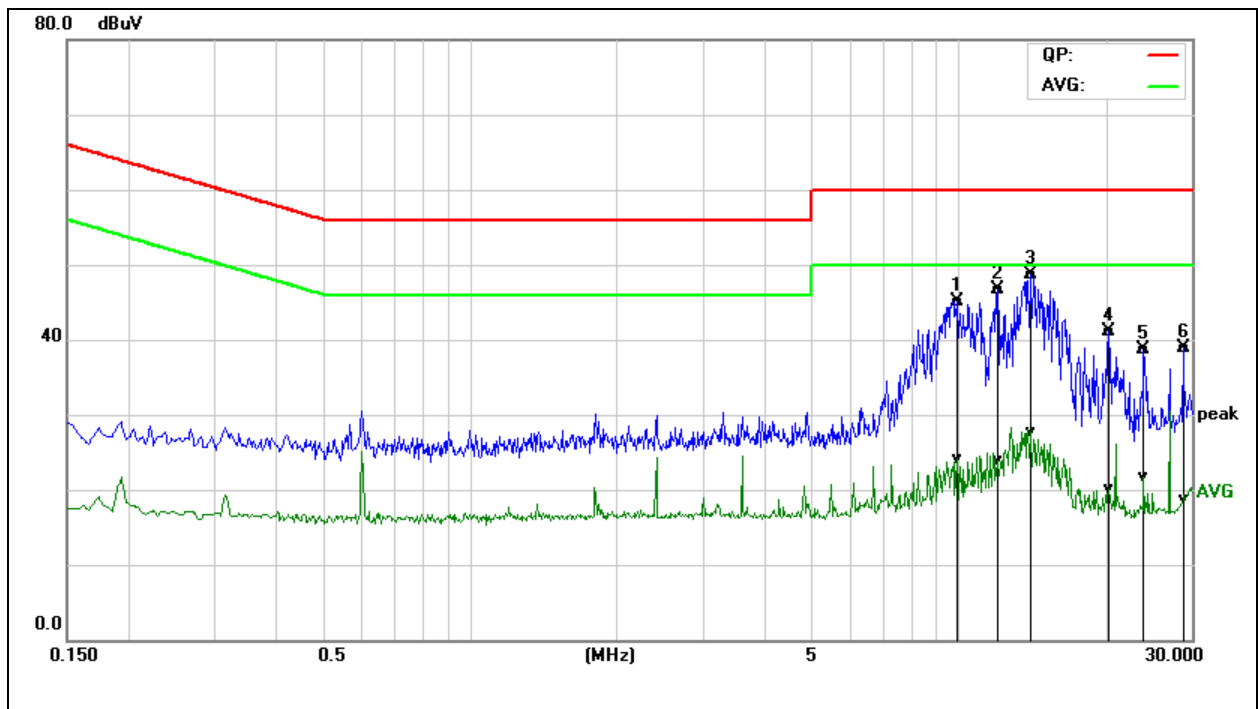

Frequency (MHz)	QuasiPeak Reading (dBuV)	Average Reading (dBuV)	Correction Factor (dB)	QuasiPeak Result (dBuV)	Average Result (dBuV)	QuasiPeak Limit (dBuV)	Average Limit (dBuV)	QuasiPeak Margin (dB)	Average Margin (dB)	Remark (Pass/Fail)
9.9180	24.90	3.98	20.22	45.12	24.20	60.00	50.00	-14.88	-25.80	Pass
12.0380	26.59	3.85	20.10	46.69	23.95	60.00	50.00	-13.31	-26.05	Pass
14.0020	28.63	7.77	19.98	48.61	27.75	60.00	50.00	-11.39	-22.25	Pass
20.2820	21.13	0.19	19.91	41.04	20.10	60.00	50.00	-18.96	-29.90	Pass
24.0020	18.79	1.88	19.88	38.67	21.76	60.00	50.00	-21.33	-28.24	Pass
28.8340	18.97	-1.15	19.84	38.81	18.69	60.00	50.00	-21.19	-31.31	Pass

REMARKS: N = Neutral Line.

5.8. MAXIMUM PEAK OUTPUT POWER

5.8.1. LIMITS

Regulation 15.247 (b)(1) For frequency hopping systems operating in the 2400-2483.5 MHz band employing at least 75 non-overlapping hopping channels, and all frequency hopping systems in the 5725-5850 MHz band: 1 watt. For all other frequency hopping systems in the 2400-2483.5 MHz band: 0.125 watts. Refer to the result "Hopping channel number" of this document. The 1 watt (30.0dBm) limit applies.

5.8.2. TEST PROCEDURES

- 1) Remove the antenna from the EUT and then connect a low RF cable from the antenna port to the spectrum.
- 2) Set the spectrum analyzer: RBW = 3 MHz. VBW = 3 MHz. Sweep = auto; Detector Function = Peak.
- 3) Keep the EUT in transmitting at lowest, medium and highest channel individually. Record the max value.

Remark: /

5.8.3. TEST SETUP

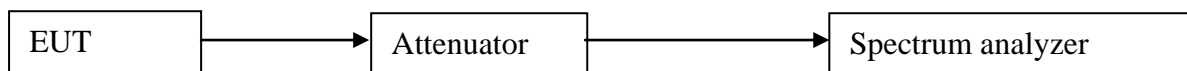

5.8.4. TEST RESULTS

GFSK

Test Channel	Fundamental Frequency (GHz)	Max Output Power(dBm)	Limit (dBm)	Peak/Average	Pass/Fail
Lowest	2.402	6.39	30	Peak	Pass
Middle	2.441	5.69			Pass
Highest	2.480	3.34			Pass
Lowest	2.402	4.89		Average	Pass
Middle	2.441	4.13			Pass
Highest	2.480	1.80			Pass

$\pi/4$ -DQPSK

Test Channel	Fundamental Frequency (GHz)	Max Output Power(dBm)	Limit (dBm)	Peak/Average	Pass/Fail
Lowest	2.402	4.22	30	Peak	Pass
Middle	2.441	3.47			Pass
Highest	2.480	1.07			Pass
Lowest	2.402	0.50		Average	Pass
Middle	2.441	-0.29			Pass
Highest	2.480	-2.73			Pass

8DPSK

Test Channel	Fundamental Frequency (GHz)	Max Output Power(dBm)	Limit (dBm)	Peak/Average	Pass/Fail
Lowest	2.402	4.78	30	Peak	Pass
Middle	2.441	4.11			Pass
Highest	2.480	1.69			Pass
Lowest	2.402	0.65		Average	Pass
Middle	2.441	-0.02			Pass
Highest	2.480	-2.49			Pass

Test result: The unit does meet the FCC requirements.

5.9. CONDUCTED BAND EDGES AND SPURIOUS EMISSIONS

5.9.1. LIMITS

(d) In any 100 kHz bandwidth outside the frequency band in which the spread spectrum or digitally modulated intentional radiator is operating, the radio frequency power that is produced by the intentional radiator shall be at least 20 dB below that in the 100 kHz bandwidth within the band that contains the highest level of the desired power, based on either an RF conducted or a radiated measurement, provided the transmitter demonstrates compliance with the peak conducted power limits. If the transmitter complies with the conducted power limits based on the use of RMS averaging over a time interval, as permitted under paragraph (b)(3) of this section, the attenuation required under this paragraph shall be 30 dB instead of 20 dB.

5.9.2. TEST PROCEDURES

- 1) Remove the antenna from the EUT and then connect a low attenuation cable from the antenna port to the spectrum.
- 2) Set the spectrum analyzer: RBW =100KHz; VBW =300KHz, Span = 10MHz to 26GHz; Sweep = auto; Detector Function = Peak. Trace = Max, hold.
- 3) Measure and record the results in the test report.
- 4) The RF fundamental frequency should be excluded against the limit line in the operating frequency band.

5.9.3. TEST SETUP

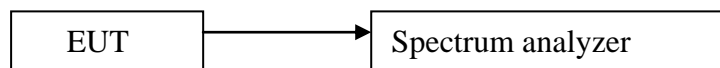

5.9.4. TEST RESULTS

The unit does meet the FCC requirements.

Test result plot as follows:

Hopping Off GFSK CH Low (10MHz ~26.5GHz)

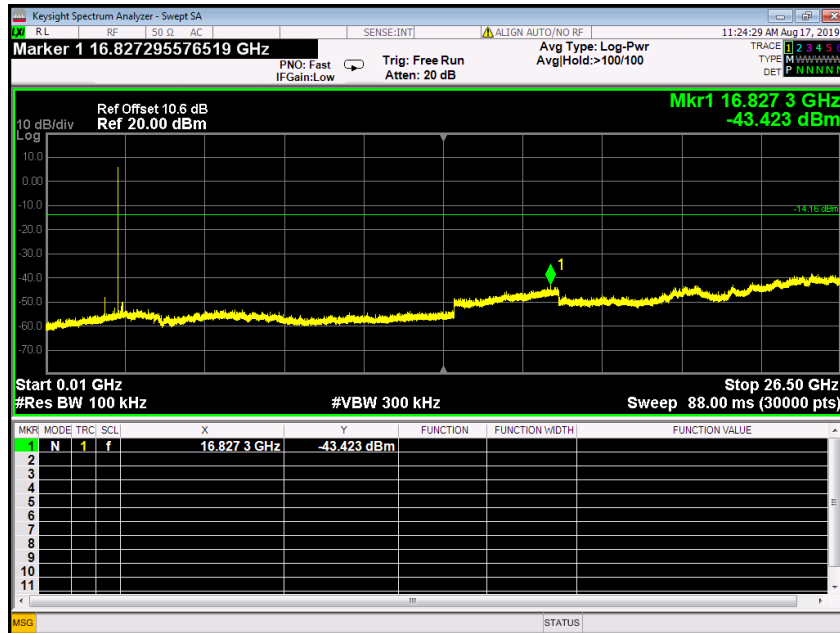

CH Low (2.31GHz ~2.41GHz)

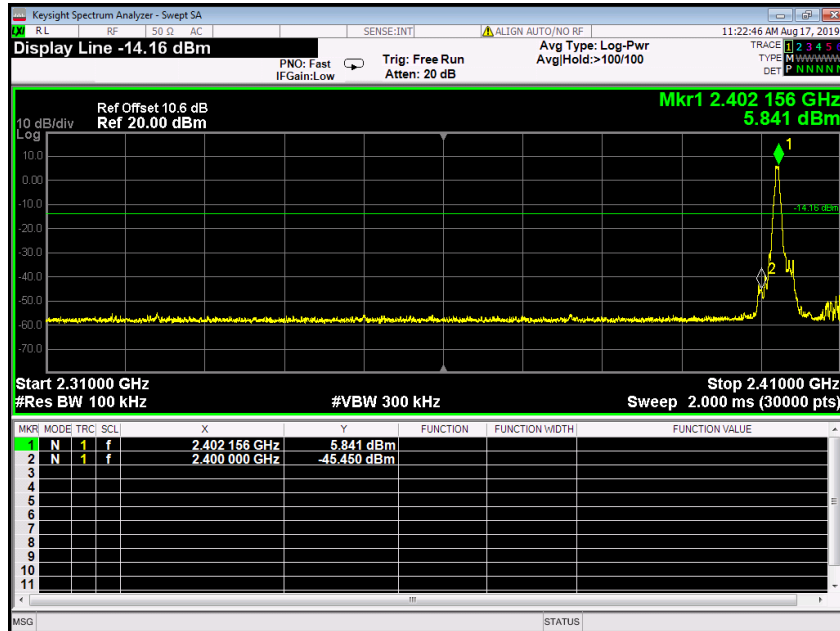

CH Mid (10MHz ~26.5GHz)

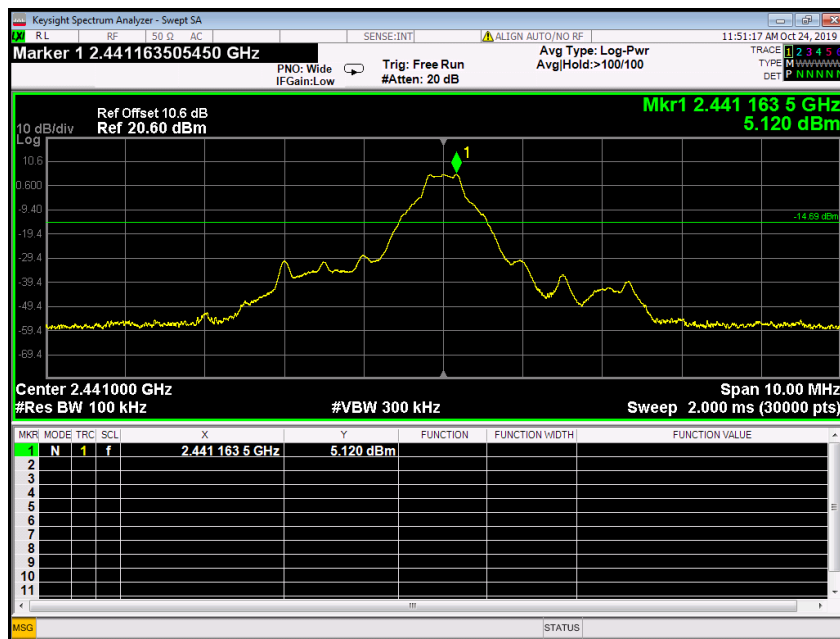
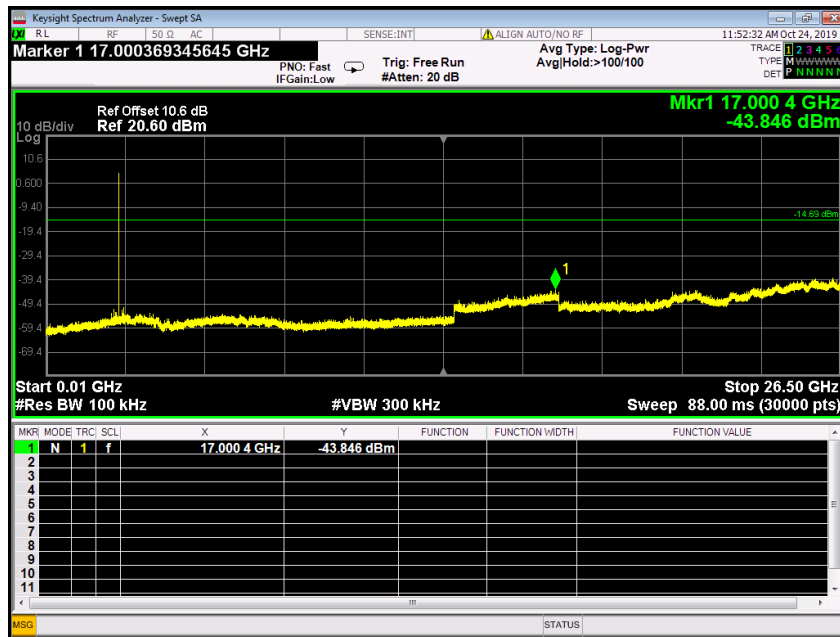

CH High (10MHz ~26.5GHz)

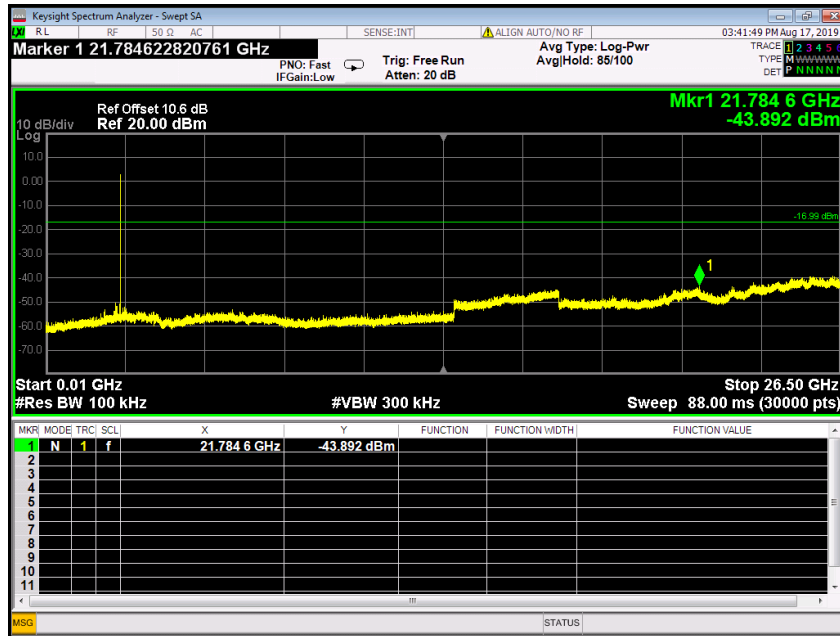

CH High (2.475GHz ~ 2.5GHz)

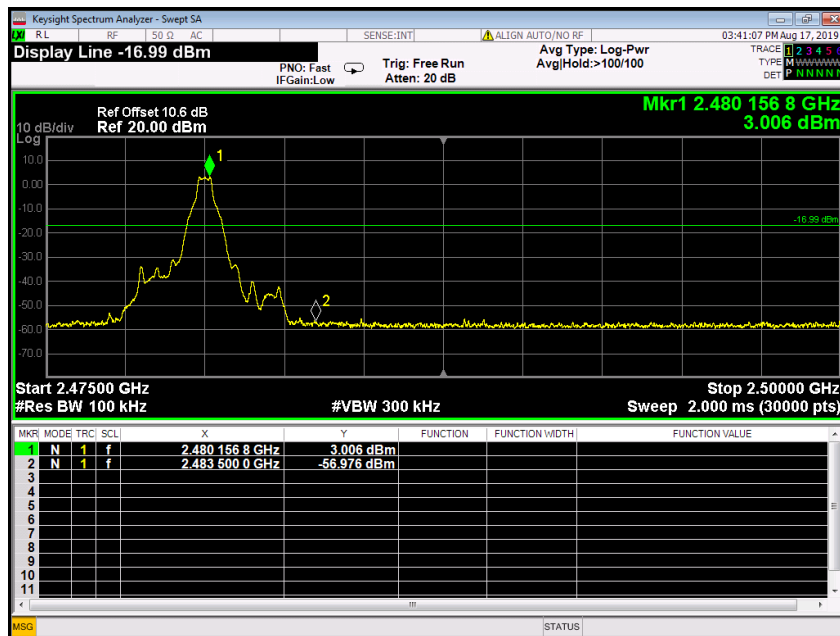

8DPSK

CH Low (10MHz ~26.5GHz)

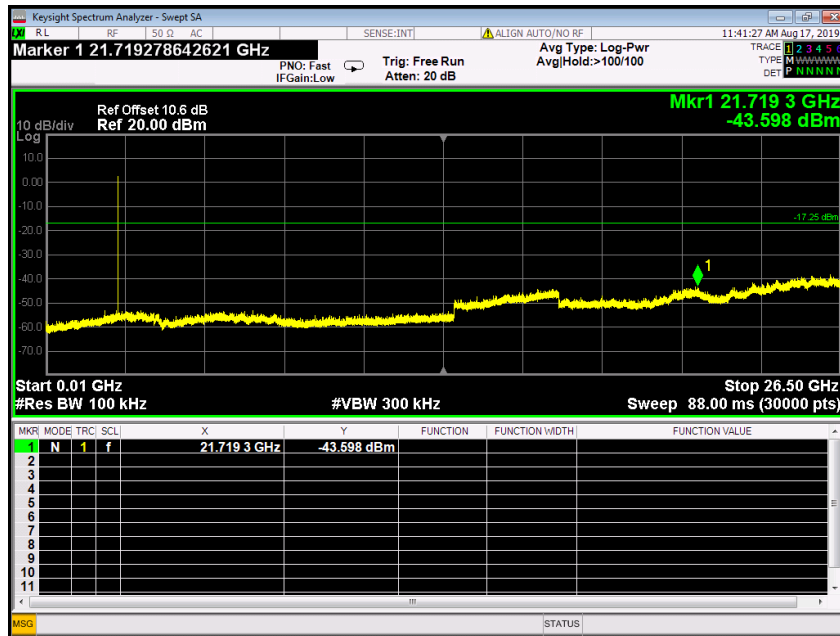

CH Low (2.31GHz ~2.41GHz)

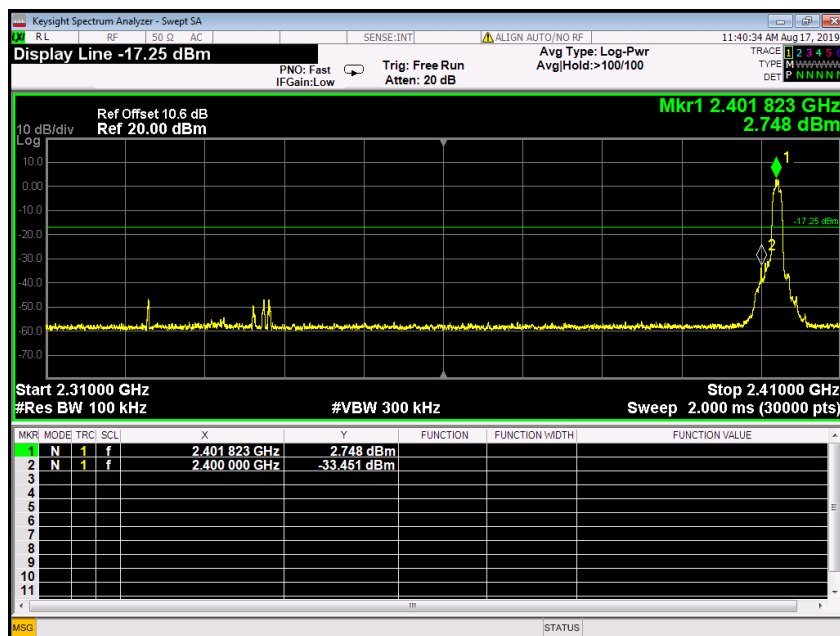

CH Mid (10MHz ~26.5GHz)

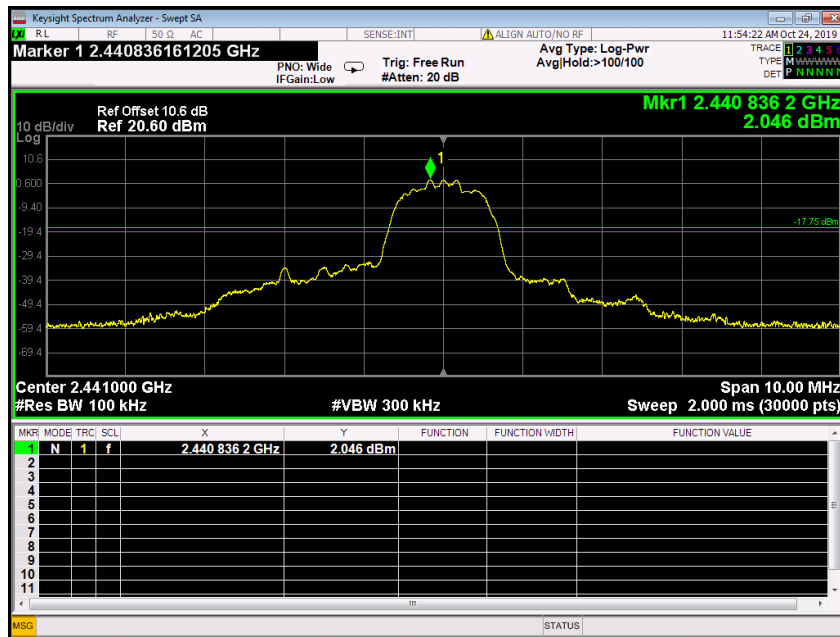
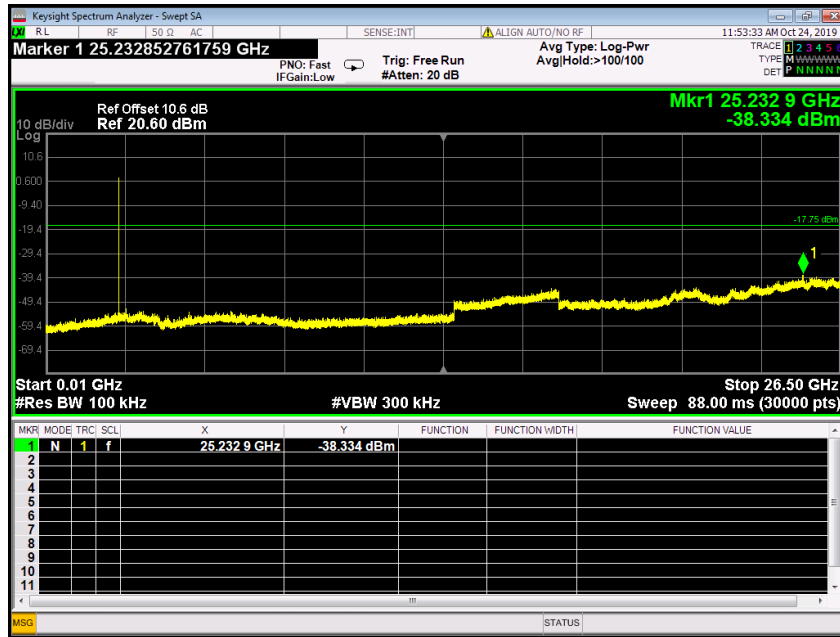

CH High (10MHz ~26.5GHz)

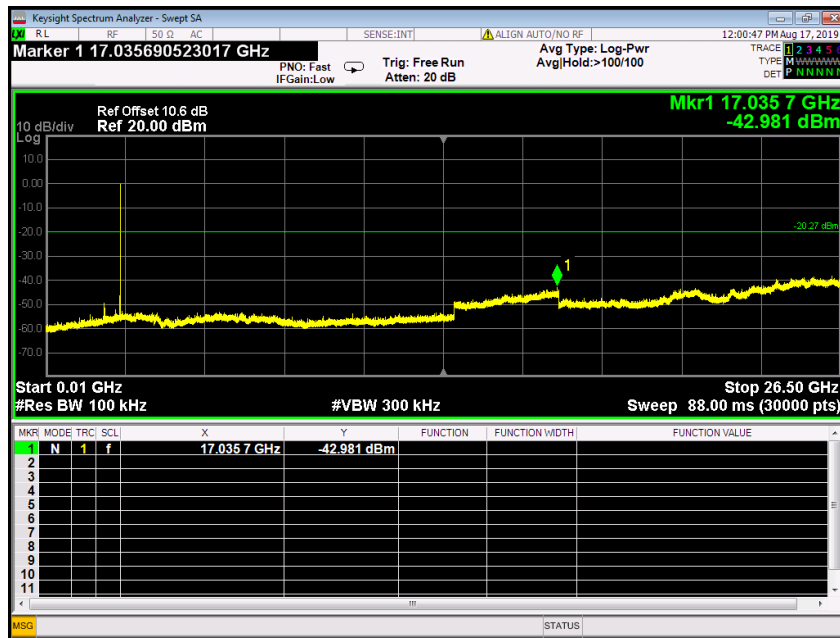

CH High (2.475GHz ~ 2.5GHz)

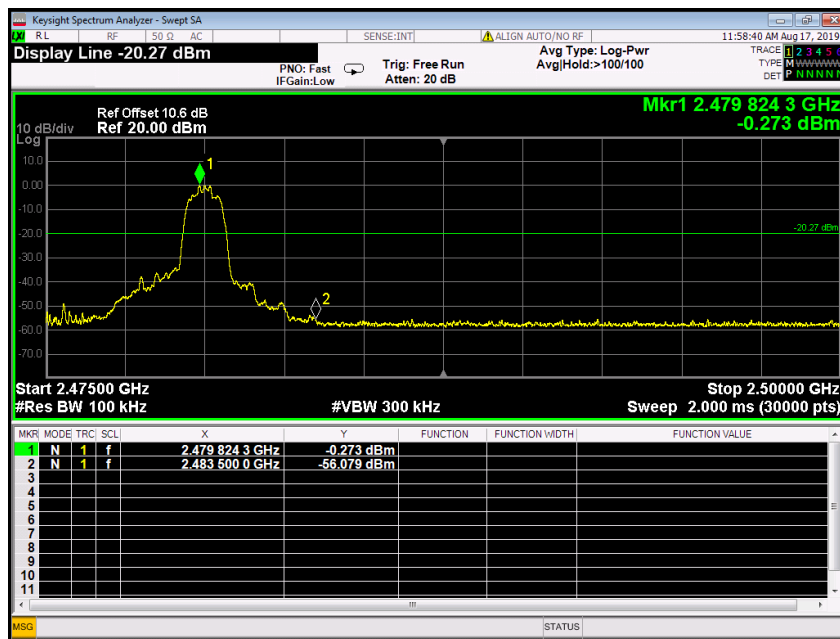

Hopping On

GFSK

CH Low (2.31GHz ~2.5GHz)

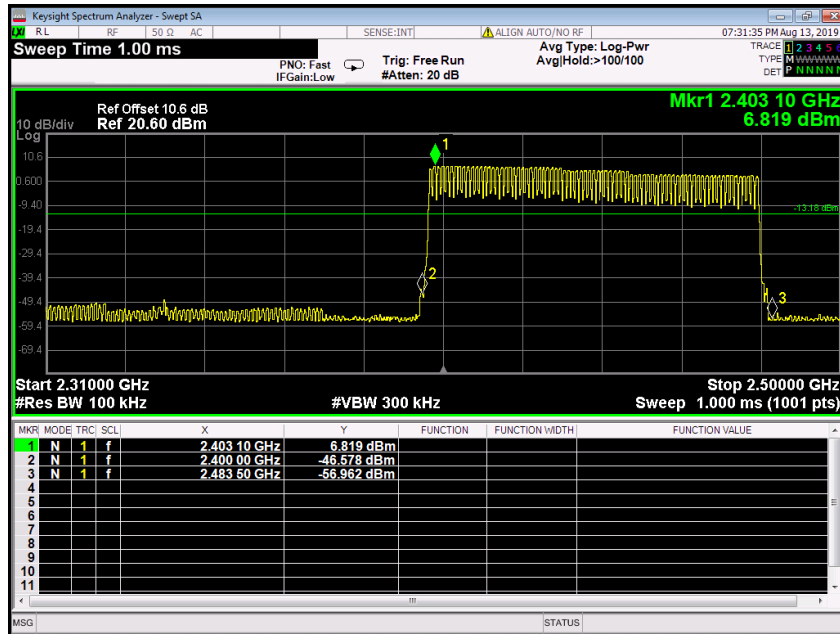

8DPSK

CH Low (2.31GHz ~2.5GHz)

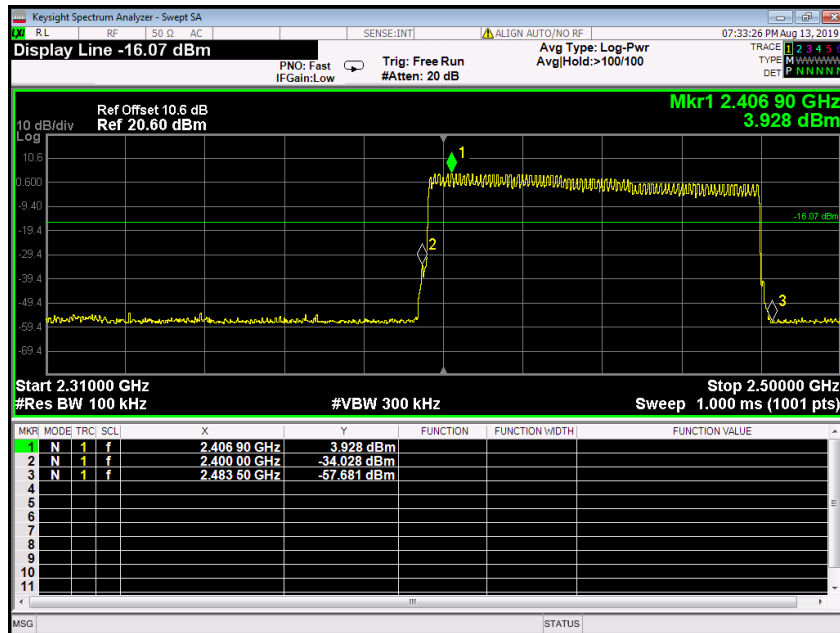

5.10. RADIATED SPURIOUS EMISSIONS

5.10.1. LIMITS

In any 100 kHz bandwidth outside the frequency band in which the spread spectrum or digitally modulated intentional radiator is operating, the radio frequency power that is produced by the intentional radiator shall be at least 20 dB below that in the 100 kHz bandwidth within the band that contains the highest level of the desired power, based on either an RF conducted or a radiated measurement, provided the transmitter demonstrates compliance with the peak conducted power limits. If the transmitter complies with the conducted power limits based on the use of RMS averaging over a time interval, as permitted under paragraph (b)(3) of this section, the attenuation required under this paragraph shall be 30 dB instead of 20 dB. Attenuation below the general limits specified in §15.209(a) is not required.

Frequency (MHz)	Quasi-peak($\mu\text{V}/\text{m}$)	Measurement distance(m)	Quasi-peak($\text{dB}\mu\text{V}/\text{m}$)@distance 3m
0.009-0.490	2400/F(kHz)	300	53.8~88.5
0.490-1.705	24000/F(kHz)	30	43~53.8
1.705-30.0	30	30	49.5
30 ~ 88	100	3	40
88~216	150	3	43.5
216 ~ 960	200	3	46
Above 960	500	3	54

NOTE: (1) The lower limit shall apply at the transition frequencies.

5.10.2. TEST PROCEDURES

- 1) The EUT was placed on the top of a rotating table 0.8 meters (for below 1GHz) / 1.5 meters (for above 1GHz) above the ground at a 3 meters semi-anechoic chamber. The table was rotated 360 degrees to determine the position of the highest radiation.
- 2) The EUT was set 3 meters away from the interference-receiving antenna, which was mounted on the top of a variable-height antenna tower.
- 3) Height of receiving antenna is varied from one meter to four meters above the ground to determine the maximum value of the field strength. Both horizontal and vertical polarizations of the antenna are set to make the measurement.
- 4) The test-receiver system was set to Peak Detect Function and Specified Bandwidth with Maximum Hold Mode.
- 5) The test-receiver system was set to Peak Detect Function and Specified Bandwidth with Maximum Hold Mode.
- 6) If the emission level of the EUT in peak mode was lower than the limit specified, then testing could be stopped and the peak values of the EUT would be reported.
Otherwise the emissions would be re-tested one by one using peak, quasi-peak or average method as specified and then reported in a data sheet.

Pre-test for normal mode and EDR mode, to find the EDR is the worst case. Pre-test for EUT in three axes and find the X axis is the worst case.
The worst case emissions were reported.

5.10.3. TEST SETUP

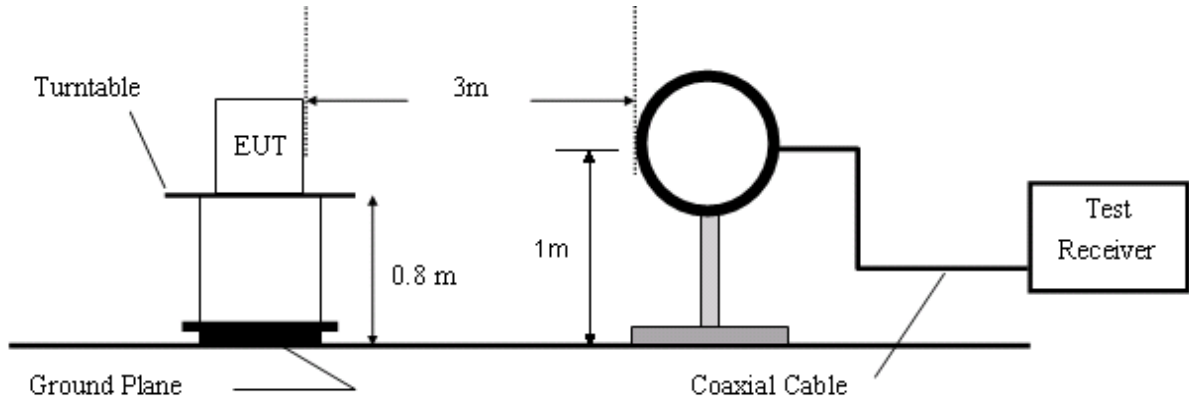

Figure 1. 9 KHz to 30MHz radiated emissions test configuration

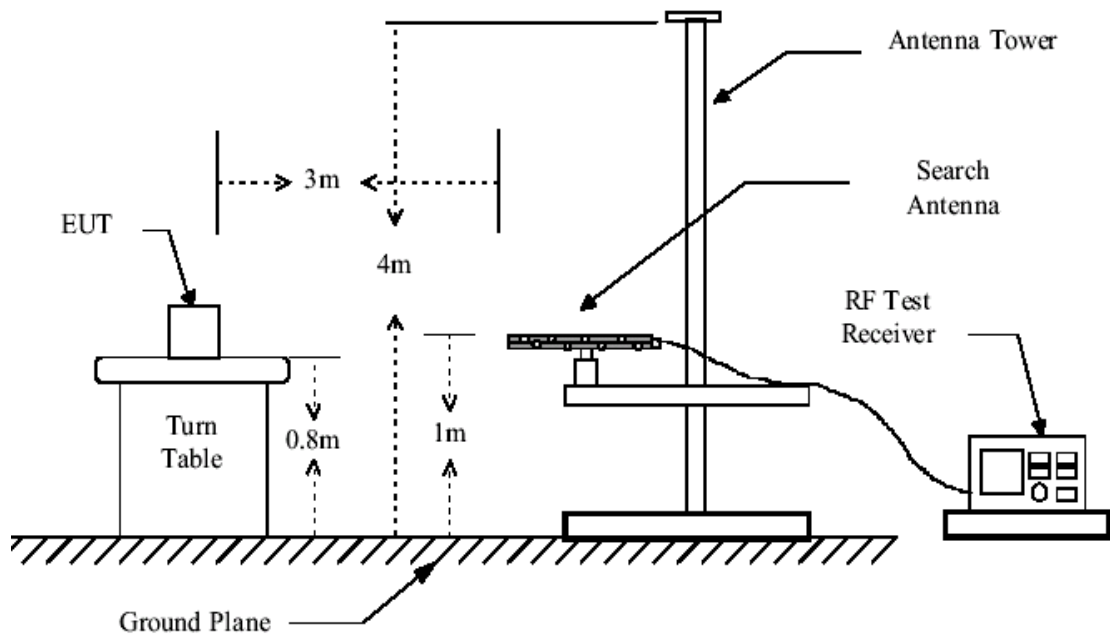

Figure 2. 30MHz to 1GHz radiated emissions test configuration

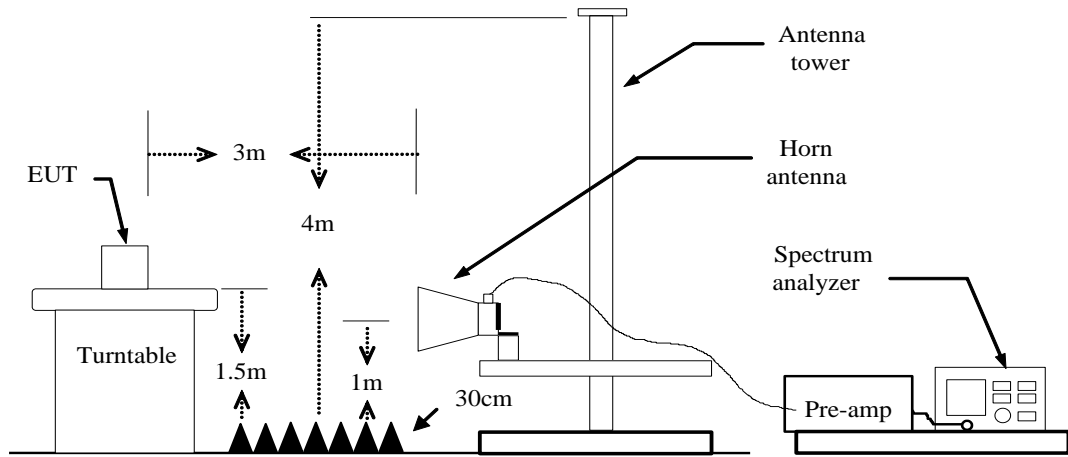

Figure 3. Above 1GHz radiated emissions test configuration

5.10.4. DATA SAMPLE

30MHz to 1GHz

No.	Frequency	Reading	Correct	Result	Limit	Margin	Remark	Pole
	(MHz)	(dBuV/m)	Factor(dB/m)	(dBuV/m)	(dBuV/m)	(dB)		
xxx	xxx	37.06	-15.48	21.58	40.00	-18.42	QP	Vertical

Above 1 GHz

No.	Frequency	Reading	Correct	Result	Limit	Margin	Remark	Pole
	(MHz)	(dBuV/m)	Factor(dB/m)	(dBuV/m)	(dBuV/m)	(dB)		
xxx	xxx	65.45	-11.12	54.33	74.00	-19.67	peak	Vertical
xxx	xxx	63.00	-11.12	51.88	54.00	-2.12	AVG	Vertical

- Frequency (MHz) = Emission frequency in MHz
- Ant.Pol. (H/V) = Antenna polarization
- Reading (dBuV) = Uncorrected Analyzer / Receiver reading
- Correction Factor (dB/m) = Antenna factor + Cable loss – Amplifier gain
- Result (dBuV/m) = Reading (dBuV) + Correction Factor (dB/m)
- Limit (dBuV/m) = Limit stated in standard
- Margin (dB) = Remark Result (dBuV/m) – Limit (dBuV/m)
- Peak = Peak Reading
- QP = Quasi-peak Reading
- AVG = Average Reading

5.10.5. TEST RESULTS

30MHz to 1GHz:

Mode: TX/GFSK

middle channel (2441MHz)

Date: 2019-10-15

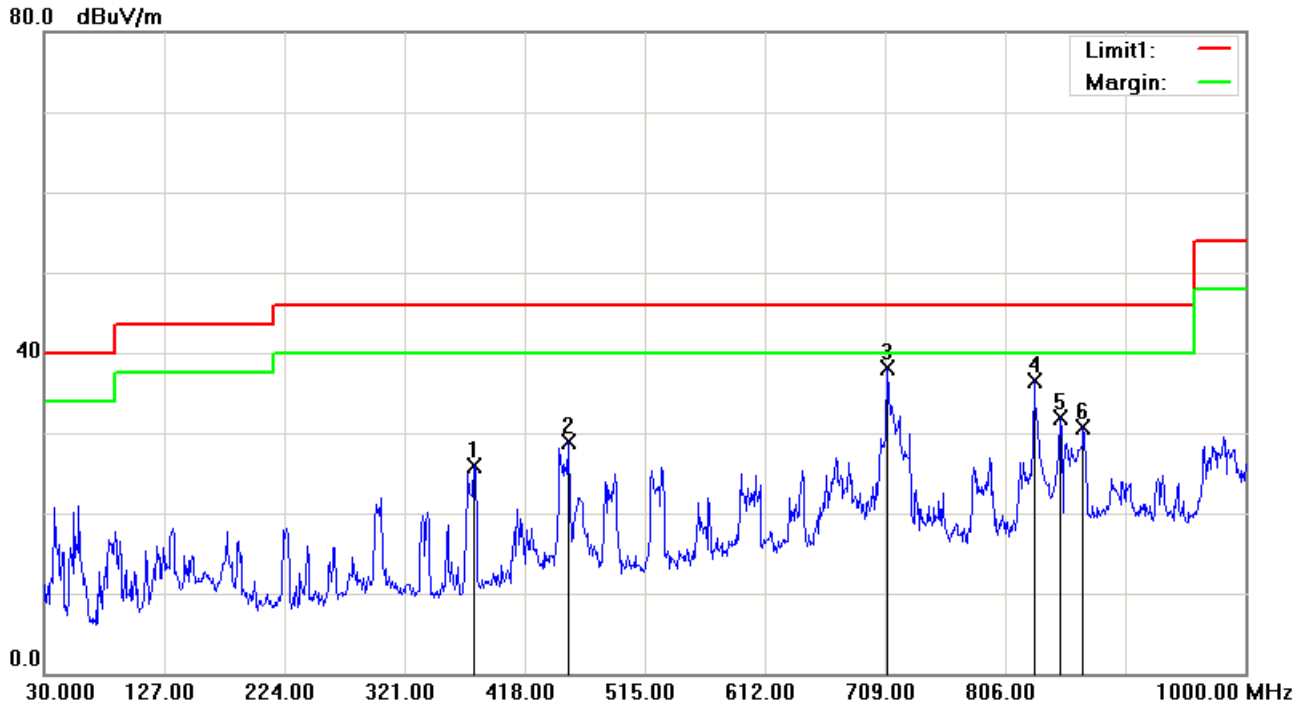

No.	Frequency (MHz)	Reading (dBuV/m)	Correct Factor(dB/m)	Result (dBuV/m)	Limit (dBuV/m)	Margin (dB)	Remark	Pole
1	377.2600	50.16	-24.29	25.87	46.00	-20.13	QP	Vertical
2	453.8900	50.92	-22.10	28.82	46.00	-17.18	QP	Vertical
3	710.9400	55.59	-17.44	38.15	46.00	-7.85	QP	Vertical
4	829.2800	53.59	-17.17	36.42	46.00	-9.58	QP	Vertical
5	850.6200	48.36	-16.54	31.82	46.00	-14.18	QP	Vertical
6	869.0500	46.97	-16.20	30.77	46.00	-15.23	QP	Vertical

Mode: TX/GFSK
middle channel (2441MHz)

Date: 2019-10-15

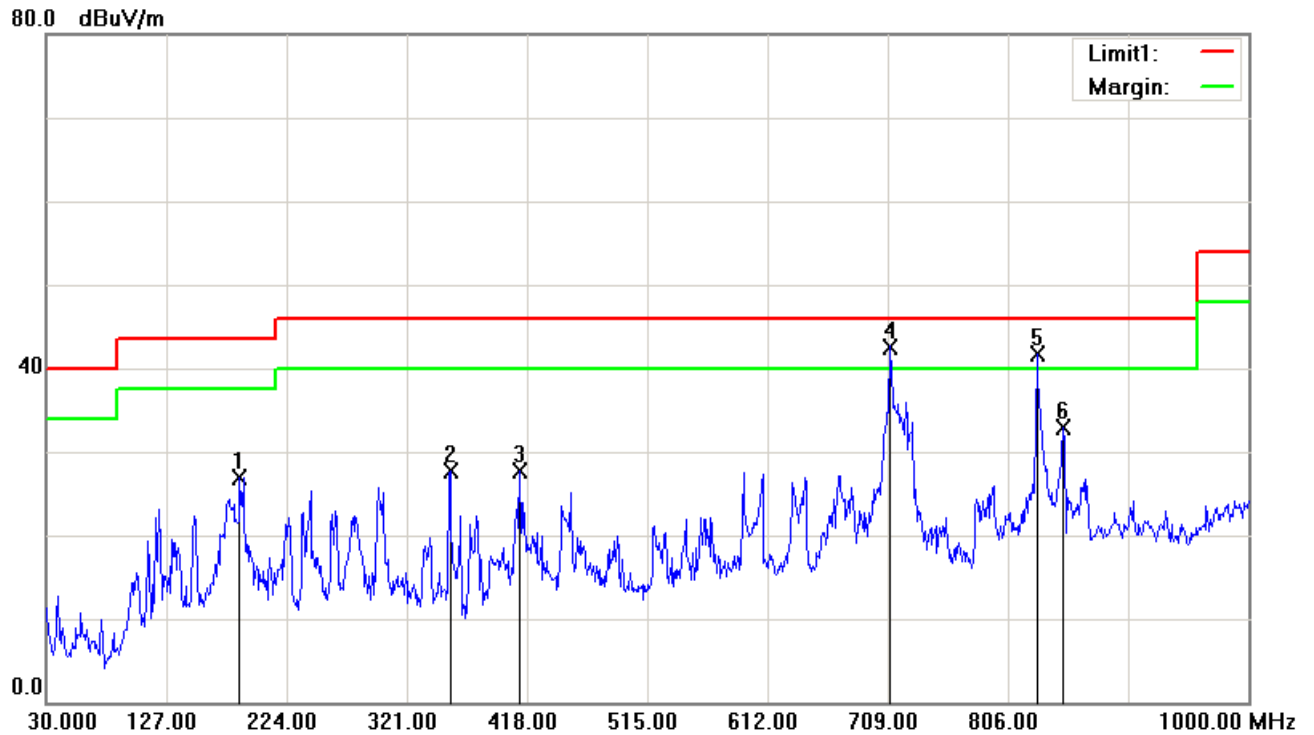

No.	Frequency (MHz)	Reading (dBuV/m)	Correct Factor(dB/m)	Result (dBuV/m)	Limit (dBuV/m)	Margin (dB)	Remark	Pole
1	186.1700	54.80	-27.94	26.86	43.50	-16.64	QP	Horizontal
2	355.9200	52.41	-24.77	27.64	46.00	-18.36	QP	Horizontal
3	412.1800	51.08	-23.37	27.71	46.00	-18.29	QP	Horizontal
4	710.9400	60.04	-17.44	42.60	46.00	-3.40	QP	Horizontal
5	829.2800	58.83	-17.17	41.66	46.00	-4.34	QP	Horizontal
6	850.6200	49.53	-16.54	32.99	46.00	-13.01	QP	Horizontal

Remark:

- 1 No emission found between lowest internal used/generated frequency to 30MHz.
- 2 Pre-scan all mode and recorded the worst case results in this report (TX-Low Channel(1Mbps)
- 3 Measuring frequencies from 9kHz to the 1GHz.
- 4 Radiated emissions measured in frequency range from 30MHz to 1GHz were made with an instrument using Peak/Quasi-peak detector mode.
- 5 Data of measurement within this frequency range shown " --- " in the table above means the reading of emissions are attenuated more than 20dB below the permissible limits or the field strength is too small to be measured.
- 6 The IF bandwidth of SPA between 30MHz to 1GHz was 120kHz.

Above 1GHz:**GFSK**

Mode: TX

Lowest channel (2402MHz)

Date: 2019-10-15

No.	Frequency	Reading	Correct	Result	Limit	Margin	Remark	Pole
	(MHz)	(dBuV/m)	Factor(dB/m)	(dBuV/m)	(dBuV/m)	(dB)		
1	1594.000	48.93	-4.77	44.16	74.00	-29.84	peak	Vertical
2	1900.000	50.98	-2.95	48.03	74.00	-25.97	AVG	Vertical
3	2521.000	45.89	-1.15	44.74	74.00	-29.26	peak	Vertical
4	4411.000	44.43	2.38	46.81	74.00	-27.19	peak	Vertical
5	5761.000	42.77	4.50	47.27	74.00	-26.73	peak	Vertical
6	6013.000	41.93	5.28	47.21	74.00	-26.79	peak	Vertical
7	1324.000	48.50	-7.35	41.15	74.00	-32.85	peak	Horizontal
8	1900.000	50.12	-4.57	45.55	74.00	-28.45	peak	Horizontal
9	2548.000	45.44	-3.05	42.39	74.00	-31.61	peak	Horizontal
10	3214.000	43.65	-1.20	42.45	74.00	-31.55	peak	Horizontal
11	4411.000	42.81	0.73	43.54	74.00	-30.46	peak	Horizontal
12	7192.000	42.01	5.88	47.89	74.00	-26.11	peak	Horizontal

Mode: TX

Middle channel (2441MHz)

Date: 2019-10-15

No.	Frequency	Reading	Correct	Result	Limit	Margin	Remark	Pole
	(MHz)	(dBuV/m)	Factor(dB/m)	(dBuV/m)	(dBuV/m)	(dB)		
1	1594.000	49.23	-4.77	44.46	74.00	-29.54	peak	Vertical
2	1900.000	50.67	-2.95	47.72	74.00	-26.28	peak	Vertical
3	2827.000	44.70	0.16	44.86	74.00	-29.14	peak	Vertical
4	4411.000	42.78	2.38	45.16	74.00	-28.84	peak	Vertical
5	5761.000	41.99	4.50	46.49	74.00	-27.51	peak	Vertical
6	6013.000	42.00	5.28	47.28	74.00	-26.72	peak	Vertical
7	1333.000	49.96	-7.33	42.63	74.00	-31.37	peak	Horizontal
8	1891.000	47.22	-4.62	42.60	74.00	-31.40	peak	Horizontal
9	2242.000	46.33	-3.64	42.69	74.00	-31.31	peak	Horizontal
10	2827.000	44.42	-1.97	42.45	74.00	-31.55	peak	Horizontal
11	3061.000	44.31	-1.26	43.05	74.00	-30.95	peak	Horizontal
12	4411.000	42.74	0.73	43.47	74.00	-30.53	peak	Horizontal

Mode: TX

Highest channel (2480MHz)

Date: 2019-10-15

No.	Frequency (MHz)	Reading (dBuV/m)	Correct Factor(dB/m)	Result (dBuV/m)	Limit (dBuV/m)	Margin (dB)	Remark	Pole
1	1342.000	50.18	-5.76	44.42	74.00	-29.58	peak	Vertical
2	1891.000	53.91	-3.00	50.91	74.00	-23.09	peak	Vertical
3	4411.000	43.21	2.38	45.59	74.00	-28.41	peak	Vertical
4	4960.000	44.94	2.26	47.20	74.00	-26.80	peak	Vertical
5	5761.000	41.94	4.50	46.44	74.00	-27.56	peak	Vertical
6	6022.000	41.73	5.30	47.03	74.00	-26.97	peak	Vertical
7	1369.000	49.55	-7.19	42.36	74.00	-31.64	peak	Horizontal
8	1900.000	46.69	-4.57	42.12	74.00	-31.88	peak	Horizontal
9	3070.000	44.95	-1.27	43.68	74.00	-30.32	peak	Horizontal
10	3241.000	43.55	-1.20	42.35	74.00	-31.65	peak	Horizontal
11	4411.000	42.55	0.73	43.28	74.00	-30.72	peak	Horizontal
12	4960.000	45.99	0.99	46.98	74.00	-27.02	peak	Horizontal

8DPSK

Mode: TX

Lowest channel (2402MHz)

Date: 2019-10-15

No.	Frequency	Reading	Correct	Result	Limit	Margin	Remark	Pole
	(MHz)	(dBuV/m)	Factor(dB/m)	(dBuV/m)	(dBuV/m)	(dB)		
1	1891.000	51.28	-3.00	48.28	74.00	-25.72	peak	Vertical
2	2233.000	46.36	-1.83	44.53	74.00	-29.47	peak	Vertical
3	3061.000	44.54	0.92	45.46	74.00	-28.54	peak	Vertical
4	4411.000	42.73	2.38	45.11	74.00	-28.89	peak	Vertical
5	5761.000	42.72	4.50	47.22	74.00	-26.78	peak	Vertical
6	6022.000	42.50	5.30	47.80	74.00	-26.20	peak	Vertical
7	1342.000	49.03	-7.29	41.74	74.00	-32.26	peak	Horizontal
8	1900.000	46.79	-4.57	42.22	74.00	-31.78	peak	Horizontal
9	3241.000	43.50	-1.20	42.30	74.00	-31.70	peak	Horizontal
10	4411.000	42.26	0.73	42.99	74.00	-31.01	peak	Horizontal
11	5239.000	41.25	1.58	42.83	74.00	-31.17	peak	Horizontal
12	6382.000	40.76	4.45	45.21	74.00	-28.79	peak	Horizontal

Mode: TX

Middle channel (2441 MHz)

Date: 2019-10-15

No.	Frequency	Reading	Correct	Result	Limit	Margin	Remark	Pole
	(MHz)	(dBuV/m)	Factor(dB/m)	(dBuV/m)	(dBuV/m)	(dB)		
1	1900.000	50.93	-2.95	47.98	74.00	-26.02	peak	Vertical
2	2800.000	44.77	0.05	44.82	74.00	-29.18	peak	Vertical
3	4411.000	42.69	2.38	45.07	74.00	-28.93	peak	Vertical
4	5761.000	42.13	4.50	46.63	74.00	-27.37	peak	Vertical
5	6022.000	42.79	5.30	48.09	74.00	-25.91	peak	Vertical
6	7849.000	41.53	8.92	50.45	74.00	-23.55	peak	Vertical
7	1315.000	50.57	-7.39	43.18	74.00	-30.82	peak	Horizontal
8	1900.000	46.93	-4.57	42.36	74.00	-31.64	peak	Horizontal
9	2548.000	45.72	-3.05	42.67	74.00	-31.33	peak	Horizontal
10	2818.000	44.91	-2.00	42.91	74.00	-31.09	peak	Horizontal
11	3835.000	42.30	-0.44	41.86	74.00	-32.14	peak	Horizontal
12	4411.000	43.82	0.73	44.55	74.00	-29.45	peak	Horizontal

Mode: TX

Highest channel (2480MHz)

Date: 2019-10-15

No.	Frequency (MHz)	Reading (dBuV/m)	Correct Factor(dB/m)	Result (dBuV/m)	Limit (dBuV/m)	Margin (dB)	Remark	Pole
1	1333.000	48.93	-5.78	43.15	74.00	-30.85	peak	Vertical
2	1900.000	50.30	-2.95	47.35	74.00	-26.65	peak	Vertical
3	3079.000	43.08	0.91	43.99	74.00	-30.01	peak	Vertical
4	4411.000	43.79	2.38	46.17	74.00	-27.83	peak	Vertical
5	5761.000	43.49	4.50	47.99	74.00	-26.01	peak	Vertical
6	6022.000	41.27	5.30	46.57	74.00	-27.43	peak	Vertical
7	1900.000	47.53	-4.57	42.96	74.00	-31.04	peak	Horizontal
8	2602.000	45.79	-2.83	42.96	74.00	-31.04	peak	Horizontal
9	3070.000	43.54	-1.27	42.27	74.00	-31.73	peak	Horizontal
10	4411.000	43.66	0.73	44.39	74.00	-29.61	peak	Horizontal
11	4960.000	42.18	0.99	43.17	74.00	-30.83	peak	Horizontal
12	6085.000	40.58	3.95	44.53	74.00	-29.47	peak	Horizontal

Remark:

- 1 Measuring frequencies from 1 GHz to the 10th harmonic of highest fundamental frequency.
- 2 Measurements above show only up to 6 maximum emissions noted, or would be lesser if no specific emissions from the EUT are recorded (ie: margin>20dB from the applicable limit) and considered that's already beyond the background noise floor.
- 3 Radiated emissions measured in frequency above 1000MHz were made with an instrument using Peak detector mode and average detector mode of the emission shown in Actual FS column.
- 4 Spectrum setting:
 - a. Peak Setting 1GHz - 26GHz, RBW = 1MHz, VBW = 1MHz, Sweep time = auto.
 - b. AV Setting 1GH z- 26GHz, RBW = 1MHz, VBW = 10Hz, Sweep time = auto.

Test result: The unit does meet the requirements.

5.11. RESTRICTED BANDS OF OPERATION

5.11.1. LIMITS

Section 15.247(d) In addition, Radiated emissions which fall in the restricted bands, as defined in §15.205(a), must also comply with the radiated emission limits specified in §15.209(a) (see §15.205(c)).

MHz	MHz	MHz	GHz
0.090 - 0.110	16.42 - 16.423	399.9 - 410	4.5 - 5.15
¹ 0.495 - 0.505	16.69475 -	608 - 614	5.35 - 5.46
2.1735 - 2.1905	16.69525	960 - 1240	7.25 - 7.75
4.125 - 4.128	16.80425 -	1300 - 1427	8.025 - 8.5
4.17725 - 4.17775	16.80475	1435 - 1626.5	9.0 - 9.2
4.20725 - 4.20775	25.5 - 25.67	1645.5 - 1646.5	9.3 - 9.5
6.215 - 6.218	37.5 - 38.25	1660 - 1710	10.6 - 12.7
6.26775 - 6.26825	73 - 74.6	1718.8 - 1722.2	13.25 - 13.4
6.31175 - 6.31225	74.8 - 75.2	2200 - 2300	14.47 - 14.5
8.291 - 8.294	108 - 121.94	2310 - 2390	15.35 - 16.2
8.362 - 8.366	123 - 138	2483.5 - 2500	17.7 - 21.4
8.37625 - 8.38675	149.9 - 150.05	2655 - 2900	22.01 - 23.12
8.41425 - 8.41475	156.52475 -	3260 - 3267	23.6 - 24.0
12.29 - 12.293	156.52525	3332 - 3339	31.2 - 31.8
12.51975 -	156.7 - 156.9	3345.8 - 3358	36.43 - 36.5
12.52025	162.0125 - 167.17	3600 - 4400	
12.57675 -	167.72 - 173.2		
12.57725	240 - 285		
13.36 - 13.41	322 - 335.4		

5.11.2. TEST PROCEDURES

- 1) The EUT is placed on a turntable, which is 1.5m above the ground plane.
- 2) The turntable shall be rotated for 360 degrees to determine the position of maximum emission level.
- 3) EUT is set 3m away from the receiving antenna, which is varied from 1m to 4m to find out the highest emission.
- 4) Set the spectrum analyzer in the following setting in order to capture the lower and upper band-edges of the emission:
 - a) PEAK: RBW=1MHz / VBW=1MHz / Sweep=AUTO
 - b) AVERAGE: RBW=1MHz / VBW=1/T / Sweep=AUTO
- 5) Repeat the procedures until all the PEAK and AVERAGE versus POLARIZATION are measured.

5.11.3. TEST SETUP

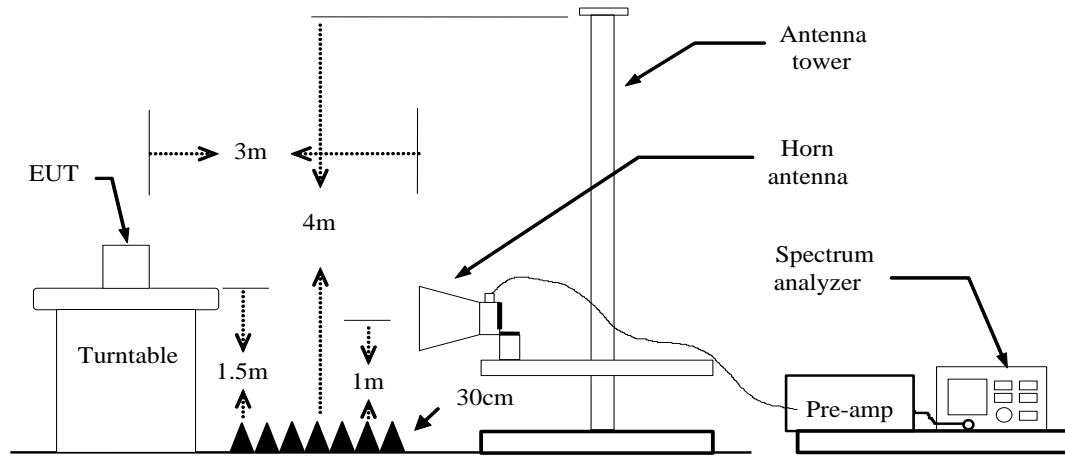

5.11.4. TEST RESULTS

GFSK

Channel Low

Detector mode: Peak

Polarity: Vertical

110.0 dBuV/m

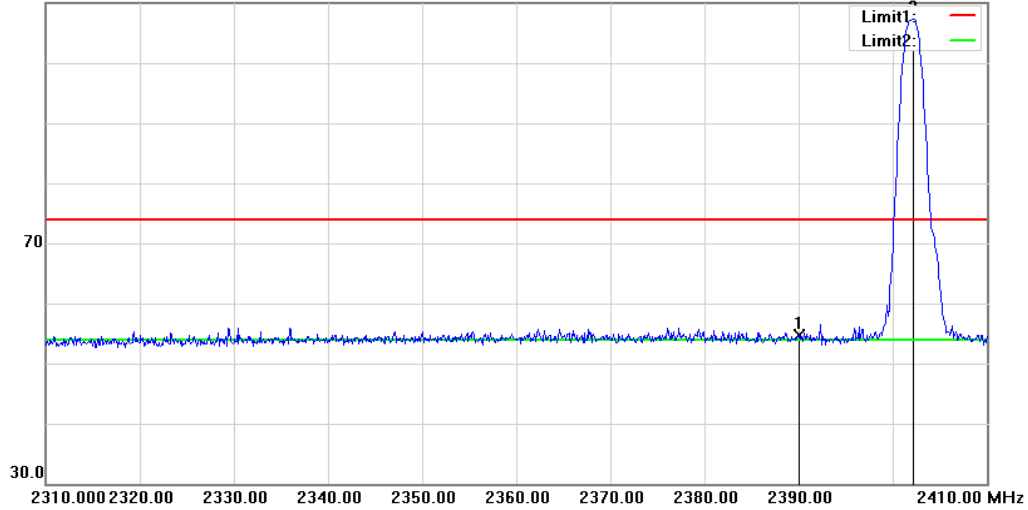

Detector mode: Average

Polarity: Vertical

110.0 dBuV/m

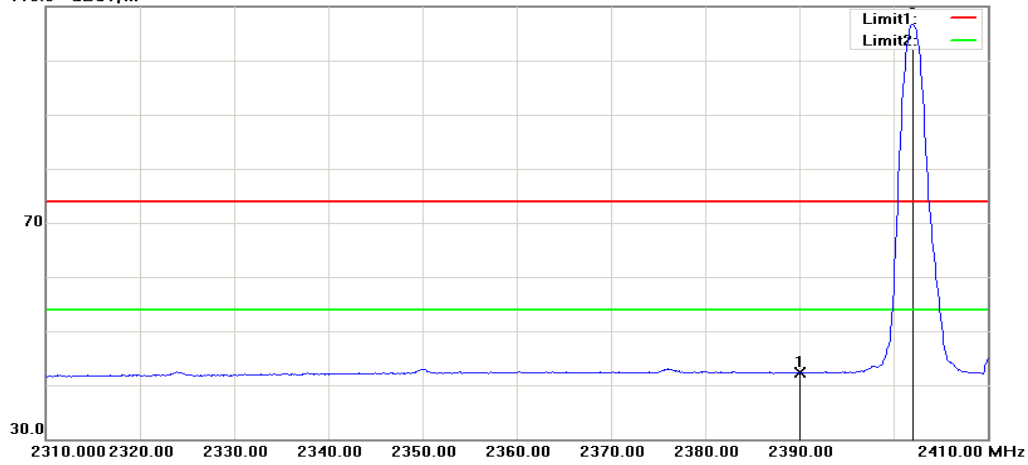

No.	Frequency MHz	Reading dBuV	Factor dB	Result dBuV/m	Limit dBuV/m	Margin dB	Remark	Pole
1	2390.000	56.09	-1.48	54.61	74.00	-19.39	Peak	Vertical
2	2402.200	108.81	-1.45	107.36	---	---	Peak	Vertical
1	2390.000	43.86	-1.48	42.38	54.00	-11.62	Average	Vertical
2	2402.000	108.20	-1.46	106.74	---	---	Average	Vertical

Channel Low

Detector mode: Peak

Polarity: Horizontal

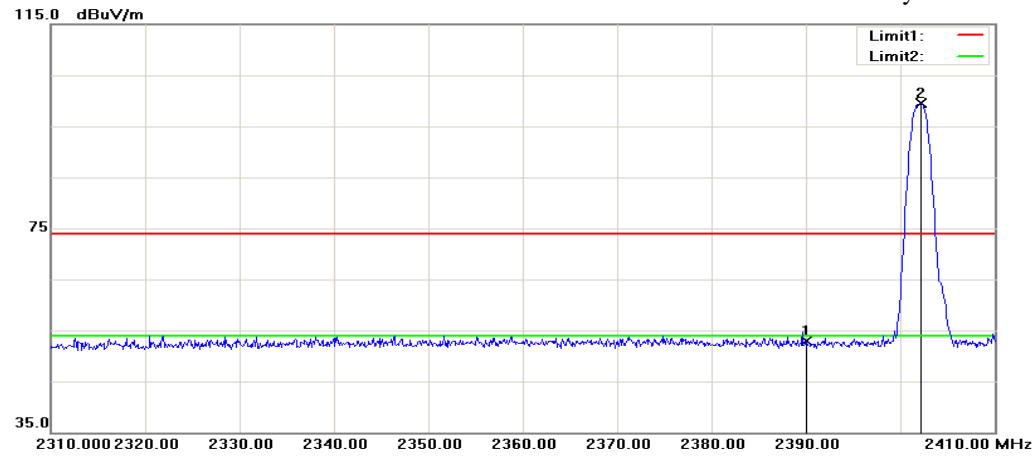

Detector mode: Average

Polarity: Horizontal

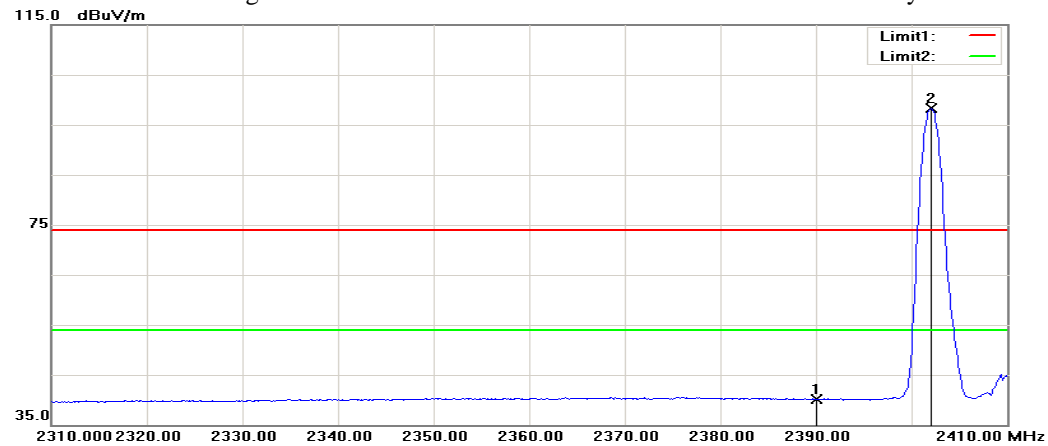

No.	Frequency MHz	Reading dBuV	Factor dB	Result dBuV/m	Limit dBuV/m	Margin dB	Remark	Pole
1	2390.000	56.39	-3.41	52.98	74.00	-21.02	Peak	Horizontal
2	2402.200	102.93	-3.39	99.54	---	---	Peak	Horizontal
1	2390.000	43.50	-3.41	40.09	54.00	-13.91	Average	Horizontal
2	2402.000	101.61	-3.39	98.22	---	---	Average	Horizontal

Channel High

Detector mode: Peak

Polarity: Vertical

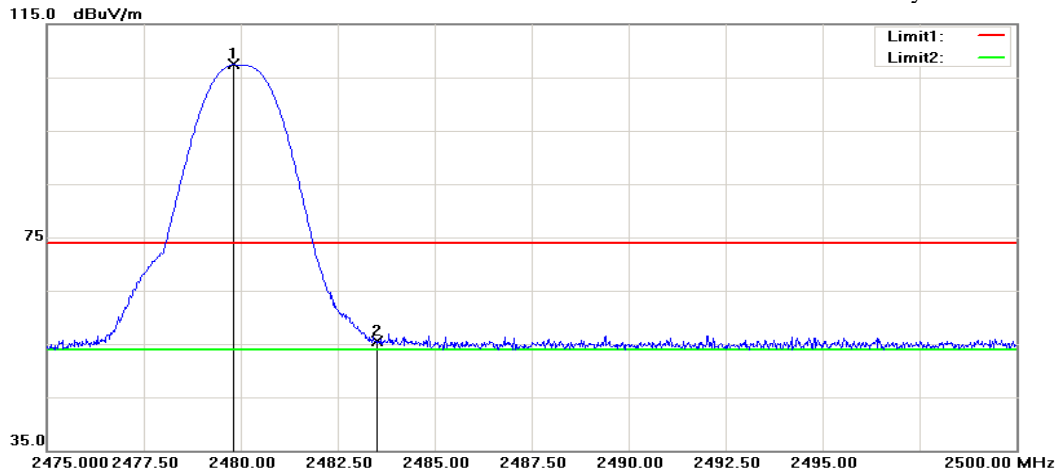

Detector mode: Average

Polarity: Vertical

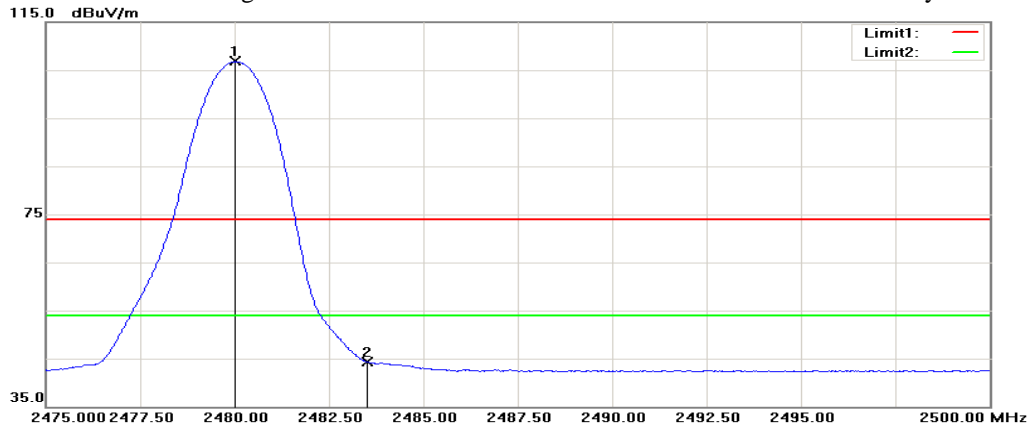

No.	Frequency MHz	Reading dBuV	Factor dB	Result dBuV/m	Limit dBuV/m	Margin dB	Remark	Pole
1	2479.825	108.72	-1.28	107.44	---	---	Peak	Vertical
2	2483.500	56.74	-1.27	55.47	74.00	-18.53	Peak	Vertical
1	2480.025	108.09	-1.28	106.81	---	---	Average	Vertical
2	2483.500	45.59	-1.27	44.32	54.00	-9.68	Average	Vertical

Channel High

Detector mode: Peak

Polarity: Horizontal

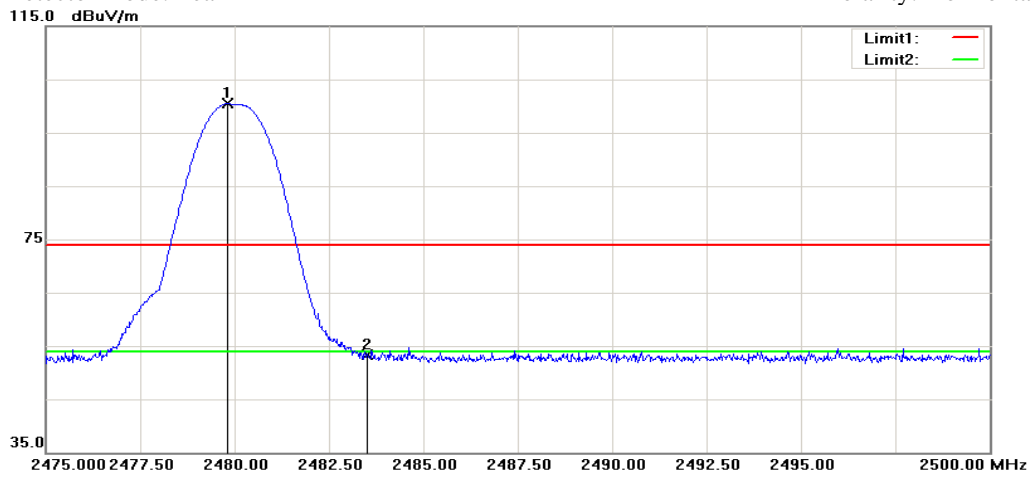

Detector mode: Average

Polarity: Horizontal

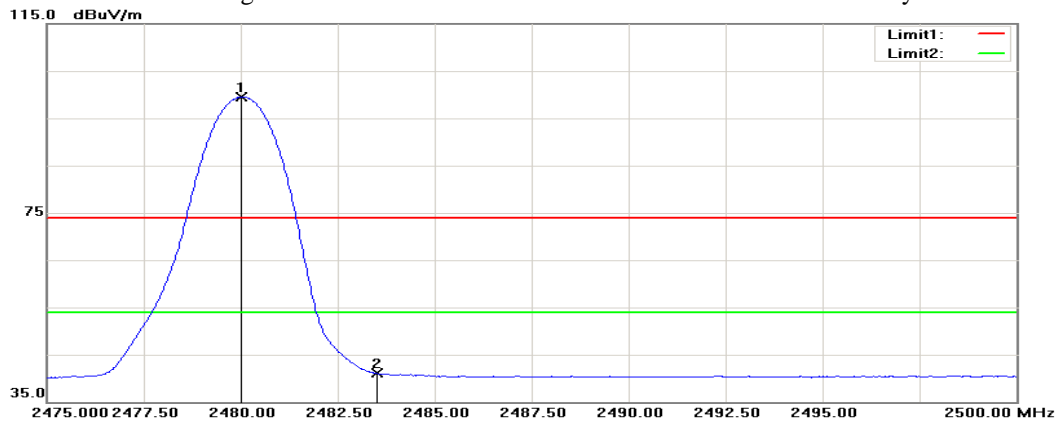

No.	Frequency MHz	Reading dBuV	Factor dB	Result dBuV/m	Limit dBuV/m	Margin dB	Remark	Pole
1	2479.825	103.73	-3.26	100.47	---	---	Peak	Vertical
2	2483.500	56.47	-3.25	53.22	74.00	-20.78	Peak	Vertical
1	2480.025	102.81	-3.26	99.55	---	---	Average	Vertical
2	2483.500	44.32	-3.25	41.07	54.00	-12.93	Average	Vertical

8DPSK

Channel Low

Detector mode: Peak
115.0 dBuV/m

Polarity: Vertical

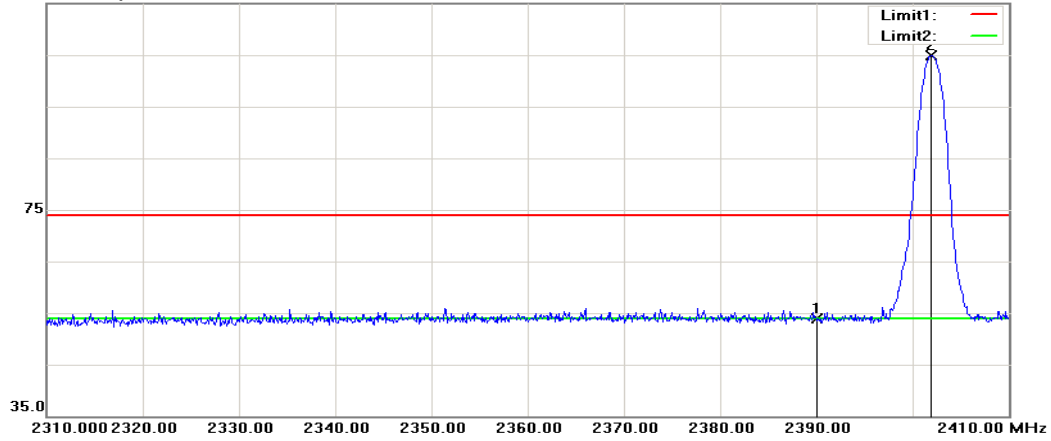

Detector mode: Average

115.0 dBuV/m

Polarity: Vertical

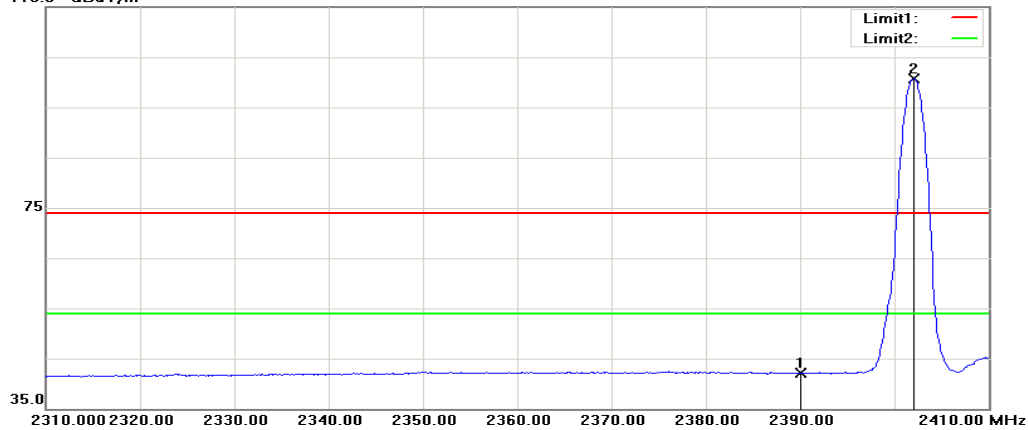

No.	Frequency MHz	Reading dBuV	Factor dB	Result dBuV/m	Limit dBuV/m	Margin dB	Remark	Pole
1	2390.000	55.46	-1.48	53.98	74.00	-20.02	Peak	Vertical
2	2401.900	106.45	-1.46	104.99	---	---	Peak	Vertical
1	2390.000	43.54	-1.48	42.06	54.00	-11.94	Average	Vertical
2	2402.000	102.22	-1.46	100.76	---	---	Average	Vertical

Channel Low

Detector mode: Peak

Polarity: Horizontal

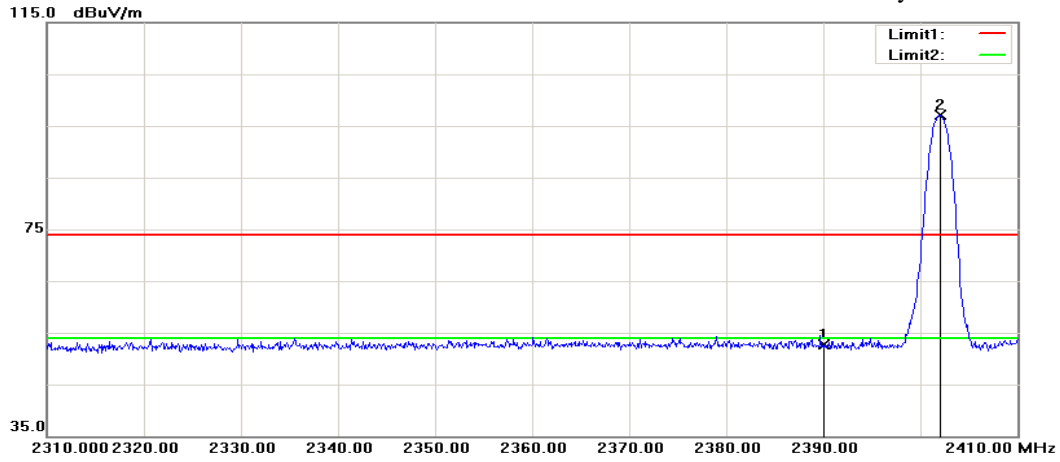

Detector mode: Average

Polarity: Horizontal

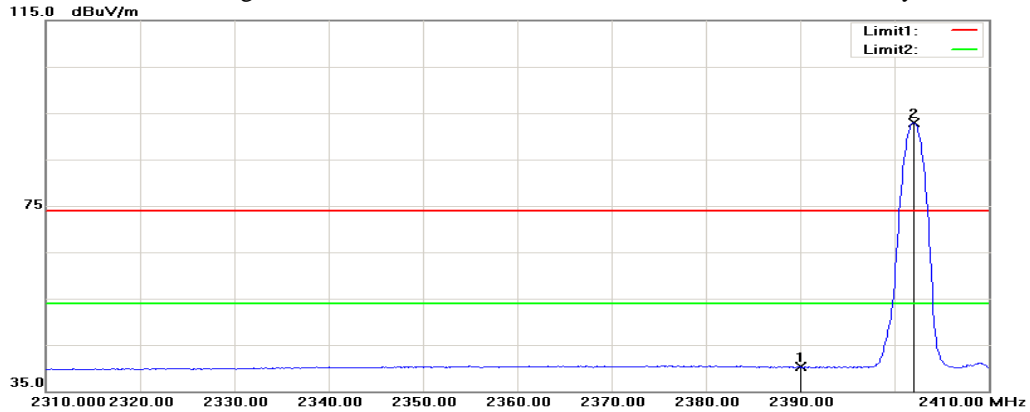

No.	Frequency MHz	Reading dBuV	Factor dB	Result dBuV/m	Limit dBuV/m	Margin dB	Remark	Pole
1	2390.000	56.13	-3.41	52.72	74.00	-21.28	Peak	Horizontal
2	2402.000	100.48	-3.39	97.09	---	---	Peak	Horizontal
1	2390.000	43.79	-3.41	40.38	54.00	-13.62	Average	Horizontal
2	2402.000	96.29	-3.39	92.90	---	---	Average	Horizontal

Channel High

Detector mode: Peak

Polarity: Vertical

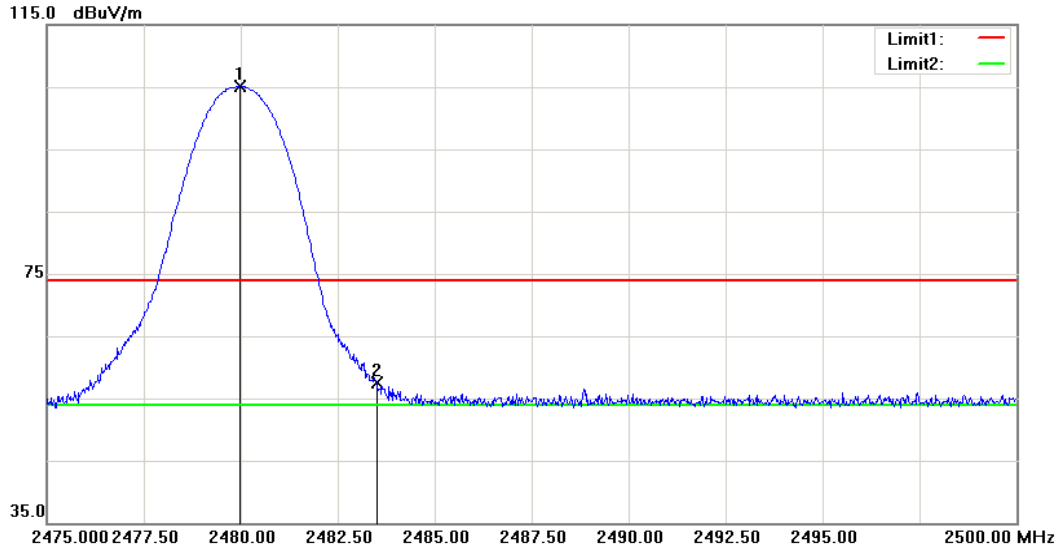

Detector mode: Average

Polarity: Vertical

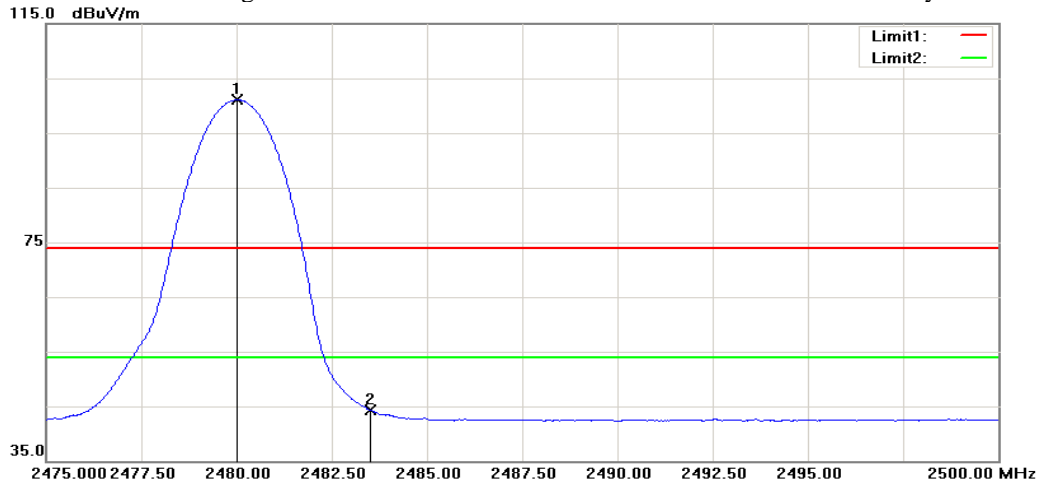

No.	Frequency MHz	Reading dBuV	Factor dB	Result dBuV/m	Limit dBuV/m	Margin dB	Remark	Pole
1	2479.975	106.48	-1.28	105.20	---	---	Peak	Vertical
2	2483.500	58.85	-1.27	57.58	74.00	-16.42	Peak	Vertical
1	2480.025	102.34	-1.28	101.06	---	---	Average	Vertical
2	2483.500	45.59	-1.27	44.32	54.00	-9.68	Average	Vertical

Channel High

Detector mode: Peak

Polarity: Horizontal

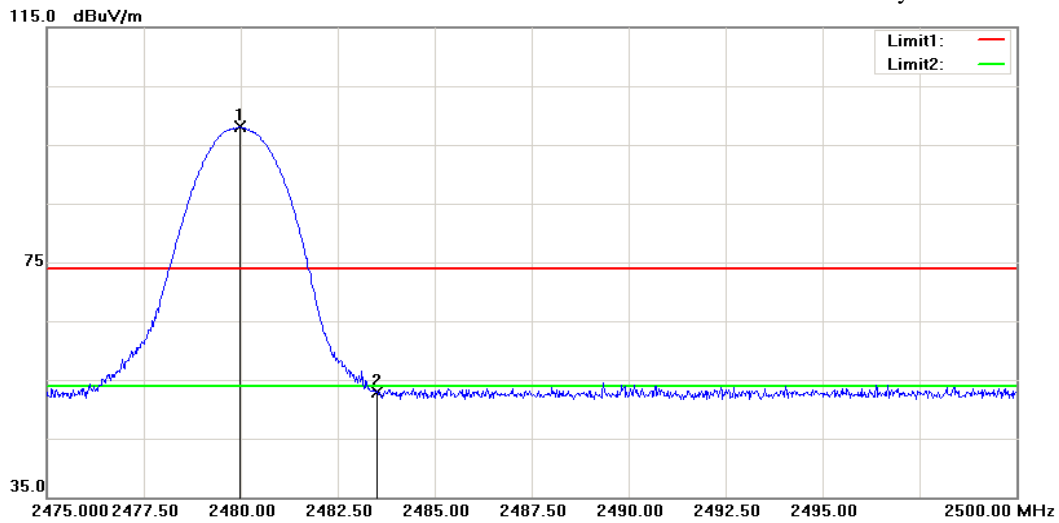

Detector mode: Average

Polarity: Horizontal

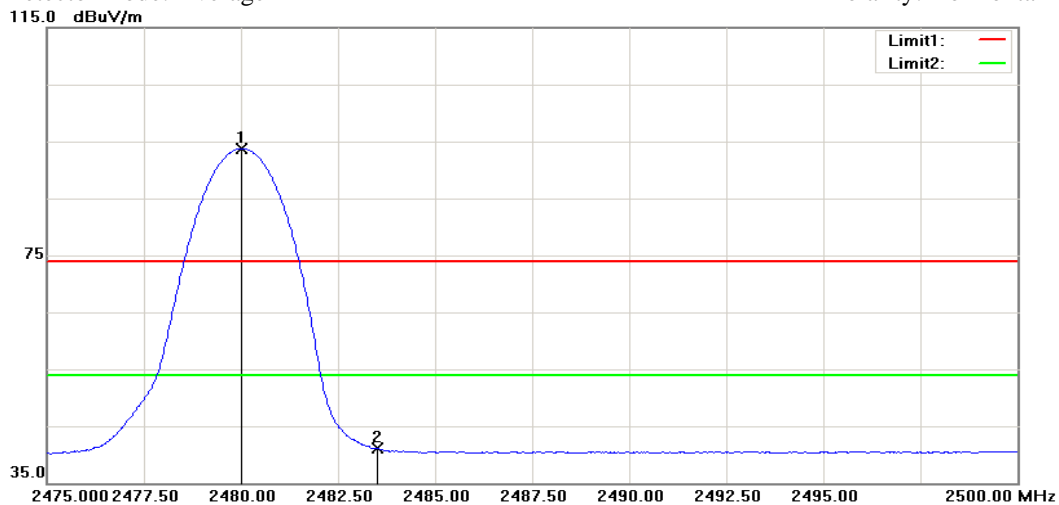

No.	Frequency MHz	Reading dBuV	Factor dB	Result dBuV/m	Limit dBuV/m	Margin dB	Remark	Pole
1	2479.975	101.32	-3.26	98.06	---	---	Peak	Vertical
2	2483.500	56.09	-3.25	52.84	74.00	-21.16	Peak	Vertical
1	2480.000	97.02	-3.26	93.76	---	---	Average	Vertical
2	2483.500	44.39	-3.25	41.14	54.00	-12.86	Average	Vertical

Remark: Max field strength in 3m distance. No any other emission which falls in restricted bands can be detected and be reported.

APPENDIX A: PHOTOGRAPH OF THE TEST ARRANGEMENT



CE-Power Line

RSE (Below 1GHz)

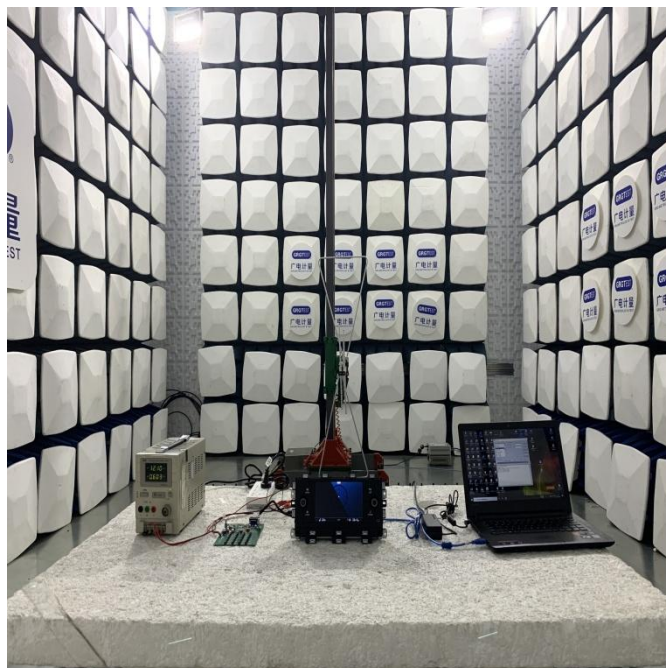

RSE (Above 1GHz)

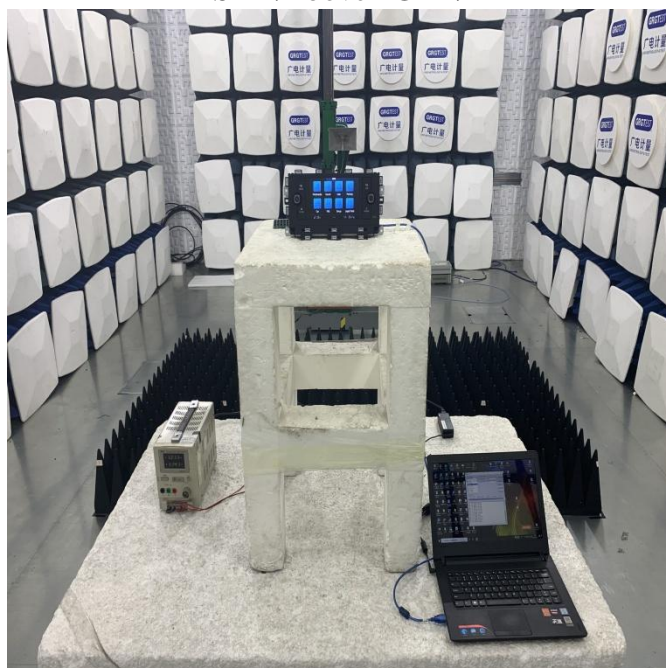

APPENDIX B: THECUSTOMER STATEMENT

Declaration Letter

We, Huizhou Desay SV Automotive Co., Ltd., certify the product:

Type or model: Radio Ultra Low Touch DAB

Series Model: Radio Ultra Low Touch

Models Radio Ultra Low Touch DAB and Radio Ultra Low Touch have the same circuit schematic, components, critical components and also the same construction. The difference between models is that model Radio Ultra Low Touch DAB with DAB function.

Below shows different appearance design:

MODEL 1:Radio Ultra Low Touch DAB



With AM/FM, With DAB Function

MODEL 2:Radio Ultra Low Touch



With AM/FM, Without DAB Function

Signature:

Title: Certification Manager

Name: Li Cheng

Company Name: Huizhou Desay SV Automotive Co., Ltd.,

Telephone: (86)752 2638 364

Li Cheng



-----This is the last page of the report. -----