

USER'S MANUAL

Mobile Printer BTP-P35



Shandong New Beiyang Information Technology Co., Ltd.

Contents

1 Introduction.....	- 1 -
1.1 Outline.....	- 1 -
1.2 Main features.....	- 2 -
2 Main technical specification.....	- 3 -
2.1 Technical specification.....	- 3 -
2.2 Paper specification.....	- 5 -
2.2.1 Parameters of continuous paper.....	- 5 -
2.2.2 Parameters of black marked paper.....	- 6 -
2.2.3 Recommended paper.....	- 7 -
2.3 Print and tear-off position.....	- 7 -
2.3.1 Print position.....	- 7 -
2.3.2 Tear off position.....	- 8 -
3 Appearance and components.....	- 9 -
3.1 Appearance and components.....	- 9 -
3.2 Accessories introduction.....	- 10 -
4 System function and settings.....	- 15 -
4.1 Explanation of panel.....	- 15 -
4.1.1 Appearance panel.....	- 15 -
4.1.2 Button function.....	- 15 -
4.2 System menu.....	- 16 -
4.3 Main parameter setup.....	- 20 -
4.4 Buzzer function.....	- 24 -
4.5 Swipe card function.....	- 25 -
5 Printer communication interface.....	- 26 -
5.1 USB interface.....	- 26 -
5.2 Bluetooth 4.0 interface.....	- 26 -

6	Installation printer.....	- 28 -
6.1	The host accessories.....	- 28 -
6.2	Precautions for using the printer.....	- 28 -
6.3	Power cable connection.....	- 29 -
6.4	Paper roll installation.....	- 31 -
6.4.1	Confirmation of printing paper.....	- 31 -
6.4.2	Install / replace the paper roll.....	- 31 -
6.5	Printer connecting installation.....	- 33 -
6.5.1	Printer belt clip installation.....	- 33 -
6.5.2	Shoulder strap connection (optional configuration).....	- 34 -
6.6	Printer power on and self-test.....	- 34 -
6.6.1	Power on the printer.....	- 34 -
6.6.2	Print the self-test page.....	- 34 -
6.7	Connect the communication interface.....	- 35 -
6.7.1	USB interface connection.....	- 35 -
6.7.2	Bluetooth connection.....	- 35 -
7	Routine maintenance.....	- 36 -
7.1	Cleaning print head and platen roller.....	- 36 -
7.2	Cleaning marked sensor.....	- 37 -
7.3	Remove paper jam.....	- 37 -
8	Troubleshooting.....	- 38 -
8.1	Printer doesn't work.....	- 38 -
8.2	LCD alarm and buzzer alarm.....	- 38 -
8.3	Problems during printing.....	- 39 -
9	Appendix.....	- 40 -
9.1	Printer driver installation on windows.....	- 40 -
9.2	Bluetooth connection.....	- 40 -
9.3	FCC STATEMENT.....	- 44 -

Declaration

Information in this document is subject to change without notice. SHANDONG NEW BEIYANG INFORMATION TECHNOLOGY CO., LTD. (hereinafter referred to as "SNBC") reserves the right to improve product as new technology, components, software, and firmware become available. If users need further data about this product, please feel free to contact your dealer or the manufacturer.

No part of this document may be reproduced or transmitted in any form or by any means, electronic or mechanical, for any purpose without the express written permission of SNBC.

Copyright

Copyright © 2016 by SNBC.

Printed in China.

Version 1.0.

Trademark

Our registered trademark: .

Warning and caution



Warning: Items shall be strictly followed to avoid any damages to body and equipment;



Caution: Items with important information and prompts for operating the printer.

SNBC has passed the following certifications:

ISO9001 Quality Control System Certification

ISO14001 Environmental Management System Certification

OHSAS18001 Occupational Health and Safety Management System Certification

IECQ QC 080000 Hazardous Substance Process Management System Certification

BTP-P35 has passed the following certifications:**Warning**

This is class A product. The product may cause radio interference in the working environment. Users need to take feasible measures

General Safety Information

Before installing and using the printer, please read the following items carefully.

➤ Safety instructions

Warning: Don't touch the tear bar of printer.

Warning: The print head is a thermal element and it is at high temperature during printing or just after operation. Therefore please do not touch it and its peripherals for safety reasons.

Warning: To prevent static electricity damages print head, do not touch either print head or connecting parts.

Warning: Replace the battery with the wrong type. There is a danger of explosion. Dispose of the battery in accordance with the instructions.

➤ Caution

- 1) There are reserved space around the printer for operation and maintenance;
- 2) Keep the printer away from water source, and avoid direct exposure to sun light, strong light and heat of fire.
- 3) Do not use or store the printer in a place exposed to high temperature, moisture and serious pollution.
- 4) Do not place the printer on a place exposed to vibration or impact.
- 5) No dew condensation is allowed to the printer. In case of such condensation, do not turn on the power until it has completely evaporated.
- 6) Connect the power adapter to an appropriate grounding outlet. Avoid

sharing a single electrical with large power motors and other devices that may cause the fluctuation in voltage.

- 7) The power outlet should be close to the printer for easy connection
- 8) Do not let the water or the electric materials (like metal) go into the printer. If this happen, turn off the power.
- 9) The printer cannot print in the state without paper, otherwise it will seriously damage the print head.
- 10) In order to ensure the print quality and lifetime, you should use recommended paper or its equivalents.
- 11) When inserting or disconnecting each interface, you must turn off the power, otherwise it may cause damage to the printer control circuit.
- 12) The printer should only be disassembled or repaired by a technician, who is certified by the manufacturer.
- 13) Do not use the battery soaking in water. Do not disassemble squeezing, strike or put it into the fire. In case of serious bulging, do not continue to use. Do not put it in high temperature environment.
- 14) Keep this manual safe and at hand for ready reference.

1 Introduction

1.1 Outline

BTP-P35 is a thermal mobile receipt printer with high print quality, fast speed, stable performance, long standby time and small portability. It is widely used in retail, government, law enforcement, insurance, logistics and other fields.

The product is mobile printer supporting for POS, BPLC command sets, and provide characters, graphics, barcode and other printing functions. The printer supports continuous paper, black marked paper (you need to configurate with optional transmissive sensor) and other consumables. The width of consumables is 60mm or 80mm. The printer supports automatic calibration, standard configuration USB interface. You can select two kinds of communication interfaces like Bluetooth4.0. We provide man-machine interaction interface composed of OLED screen, four buttons and buzzer. The printer supports firmware updating. Software supports Windows, Android, IOS, Linux, OPOS, JPOS and other system applications.

This product provides 2600mAh large capacity battery, and have power-saving mode. This product supports automatic sleep, wake-up and auto power off function.

This product loads paper easily on structure design, the appearance of modules using double material injection molding process. The housing is rubberization for resisting vibration and dropping.

This product configurates with power adapter, belt clip, USB cable and other accessories, and optional magnetic card/IC POS machine point of sale machine, battery charger, vehicle-bone charger, IP54 protection case

(Waist bag) shoulder strap, and other accessories.

1.2 Main features

- Easy paper loading
- Simple operation and easy maintenance
- Printing supports continuous paper and marked paper
- Compatible with a variety of width paper
- Alarm when paper end
- Communication interface is optional
- The printer firmware program can be upgraded online

2 Main technical specification

2.1 Technical specification

The parameters are under the standard test paper conditions.

Model	BTP-P35 mobile printer
Print method	Thermal
Print resolution	203dpi
Print width (Max.)	72mm
Print speed	Max.102mm/s. Factory default value is 76.2mm/s
Print length	10-1000mm
Paper out method	Tear-off mode
Memory	64MB RAM, 4MB Flash
Communication interface	Standard configuration : USB 2.0 (12Mbit/s) Optional configuration: Bluetooth 4.0&
IC card/magnetic card reader	Optional configuration
CPU	RISC CPU of 32 bits
Anomaly detection	Paper end detection, power shortage detection, open cover detection, print head high temperature protection
Electricity saving mode	Automatic sleep mode, automatic wake-up mode
Operation panel	4 buttons, standard configuration OLED screen, buzzer
Character support (ESC/POS command)	Character Set (ESC/POS): built-in standard ASCII character (9X17,12X24), user-defined characters, standard configuration of Chinese (24 × 24) supports simplified Chinese (2312), English (ASCII), optional configuration supports simplified Chinese (18030 or GBK), traditional Chinese, the United States, Britain, Japan and Korea. Users can download fonts to FLASH or RAM

1D barcode (ESC/POS command)		UPC-A, UPC-E, JAN13 (EAN13), JAN 8 (EAN8), CODE39, ITF, CODABAR, CODE93, CODE128
2D barcode (ESC/POS command)		PDF417, QRCODE, MAXICODE, GS1
Graphic format		Plain bitmap in binary system. HEX, PCX, BMP and IMG. Image files can be downloaded to FLASH, RAM
Command set		ESC/POS, BPLC
Application software	Driver	Windows, OPOS, JPOS, Linux CUPS
	Tool	Printer configuration tool, supports Windows system, POS command, Bluetooth / USB, configuration tool
Paper specification	Paper type	black marked paper, continuous paper
	Paper thickness	0.06mm ~ 0.16mm
	paper roll ID	12.5mm
	paper roll OD	Max. 50mm
	Paper width	60mm/80mm+0.5mm
Battery	Battery capacity	2600mAh, lithium battery
	Charging method	Can be charged without take out the battery
	Charging time	3.5 hours
	Continuous printing time	Not less than 30min
	Full-power printing distance	190 meters
Power adapter	Input voltage	AC100-240VAC/50~60Hz

	Output voltage	12VDC±5%, 2.0A
Environmental condition	Working temperature	Temperature:-20~50℃, Humidity:10~90% non-condensation
	Storage temperature	Temperature:-20~60℃, Humidity: 10~90% non-condensation
Accessory	Standard configuration	Battery, power adapter, operation guide, test paper roll, USB data cable, belt bag
	Optional configuration	Single battery charger, vehicle-bone charger, sheath, shoulder strap and so on
Protection standard	Ratings dust and water resistance	IP54 (With waist bag)
	Ratings dropping resistance	1.5 meters (bare printer)
	ESD	Air discharge 10KV Contact discharge 8KV
	Vibration resistance	can work normally under vibration condition (carry-on or vehicle travel may have vibration)
Physical features	Reference size	113.5mm×165.5mm×61.5mm (W×L×H)
	Reference weight	About 500g (contain battery)

2.2 Paper specification

2.2.1 Parameters of continuous paper

- Paper width: 80±0.5mm/60±0.5mm
- Maximum paper roll OD: Φ 50mm

- Paper thickness: 0.06—0.1mm

2.2.2 Parameters of black marked paper

The marked paper should meet the following requirements:

1) Mark position

- There are nine positions installed mark sensors which can detect the mark on the front or back of the paper. A to D position of sensor to detect the inner mark of the paper roll. 1 to 5 position of sensor detect the outer mark of the paper roll. The position of the sensor is shown in the figure.
- When the printer leave the factory, we can add the mark sensor and position configuration according to the requirement. The mark sensor is located on the left side (paper feed direction) of the paper by default, and is used to detect the mark of paper front with width of 80 mm, Figure 1 shows the position.

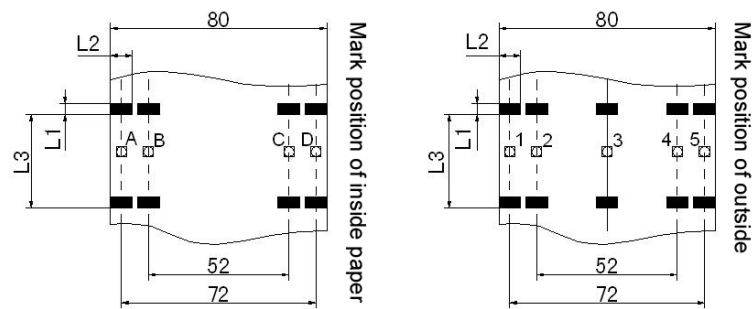

2)

When select the mark paper, we recommended following parameter:

- L1 mark height: $2\text{mm} \leq L1 \leq 8\text{mm}$
- L2 mark width: $8\text{mm} \leq L2 \leq \text{paper width}$

➤ L3 space between marks: $10\text{mm} \leq L3 \leq 1000\text{mm}$

3) The reflectivity of the mark part is less or equal to 15%, and the reflectivity of the other part of the paper in the direction of the paper feeding mark width is more than or equal to 85%. There should be no any pattern in the area between the two marks like advertisement.

Caution:

- ◇ Please use the same quality paper, otherwise it will affect the print quality and even reduce the lifetime of the print head and tear-off bar;
- ◇ Do not stick paper to the paper roll core.

2.2.3 Recommended paper

Use paper of the same quality or higher quality as the random paper roll, otherwise this may affect print quality and even reduce the lifetime of the print head and tear-off bar.

2.3 Print and tear-off position

2.3.1 Print position

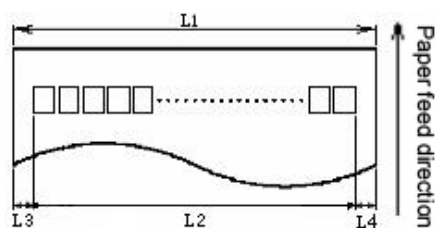

L1: Paper width

L2: Print width

L3: Distance from the print content to the left edge

L4: Distance from the print content to the right edge

For different paper width (L1), the print width (L2) and the distance from print content to left and right edges (L3 / L4) will change according to the

following table:

Paper width (L1)	Print width (L2)	Distance from the print content to the left edge(L3)	Distance from the print content to the right edge(L4)
80mm	72mm	4mm	4mm
60mm	52mm	4mm	4mm

2.3.2 Tear off position

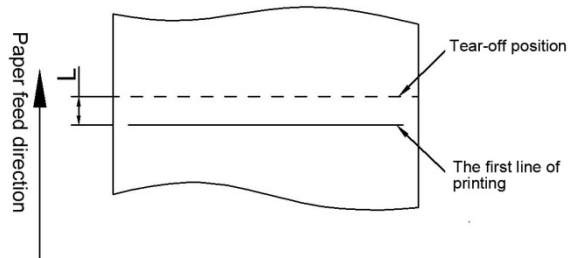

3 Appearance and components

3.1 Apperance and components

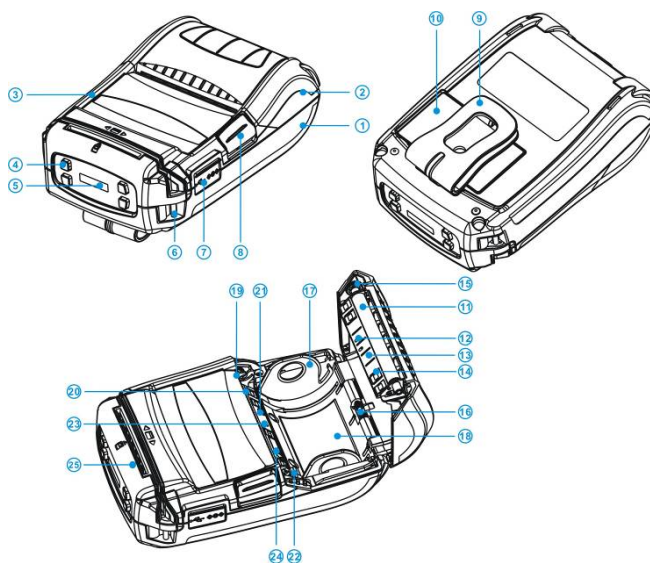

- | | | |
|--|--|--------------------------|
| 1—Bottom cover | 2—Top cover of paper cabinet | 3—Top cover |
| 4—Liquid crystal button | 5—LCD | 6—Shoulder strap |
| 7—Communication interface sealed cover | 8—Paper cabinet button | 9—Belt clip |
| 10—Battery | 11—Print platen roller | 12—Transmissive sensor 1 |
| 13—Print channel board | 14—Reflective sensor(optional configuration) | 15—Print module |
| 16—Paper cabinet torque spring | 17—Paper guide | 18—Paper cabinet |

- 19—Tear-off bar
- 20—Reflective sensor(standard configuration)
- 21—Mechanism bracket
- 22—Platen roller pothook
- 23—Transmissive sensor 2
- 24—Print head
- 25—Swipe card module (optional configuration)



⚠ Caution:



- ✧ Paper guide is an indispensable part which adjusts the width of paper. You should pay attention to the proper use.





3.2 Accessories introduction



The following contents are introduction and pictures of accessories like battery, power cable, power adapter, battery charger, vehicle-bone charger, IP54 protective cover, shoulder strap.

Name	Picture	Explanation
Lithium battery		Power supply

<p>2A Power adapter (Chinese standard)</p>		<ol style="list-style-type: none"> 1. Chinese standard area use 2. Charge the printer 3. Match up a lithium battery charging cradle to charge a single lithium battery
<p>2A Power adapter (US standard)</p>		<ol style="list-style-type: none"> 1. US standard area use 2. Charge the printer 3. Match up a lithium battery charging stand to charge a single lithium battery
<p>2A Power adapter (UK standard)</p>		<ol style="list-style-type: none"> 1. UK standard areas use 2. Charge the printer 3. Match up a lithium battery charging cradle to charge a single

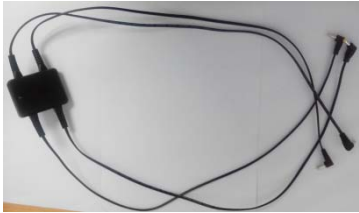
		lithium battery
2A Power adapter (EU standard)		<ol style="list-style-type: none"> 1. EU standard area use 2. Charge the printer 3. Match up a lithium battery charging cradle to charge a single lithium battery
Lithium battery charging cradle		Use for charging a lithium battery
5A Power adapter		Connect power connector and lithium battery charging cradle and charge four lithium batteries at the same time

<p>AC power cord (Chinese standard)</p>		<ol style="list-style-type: none"> 1. Chinese standard area use 2. 5A Power adapter AC power cord
<p>AC power cord (US standard)</p>		<ol style="list-style-type: none"> 1. US standard area use 2. 5A Power adapter AC power cord
<p>AC power cord (UK standard)</p>		<ol style="list-style-type: none"> 1. UK standard areas use 2. 5A Power adapter AC power cord
<p>AC power cord (EU standard)</p>		<ol style="list-style-type: none"> 1. EU standard area use 2. 5A Power adapter AC power cord
<p>One pin transfers into four pins power connector</p>		<p>Connect 5A power adapter and lithium battery charging cradle and charge four lithium batteries at the</p>

		same time
Vehicle-bone charger		<ol style="list-style-type: none"> 1. Charge the printer 2. Match up a lithium battery charging stand to charge a single lithium battery
Protection case(waist bag)		This is optional accessory used for BTP-P35 mobile printer
Shoulder strap		This is optional accessory used for BTP-P35



4 System function and settings

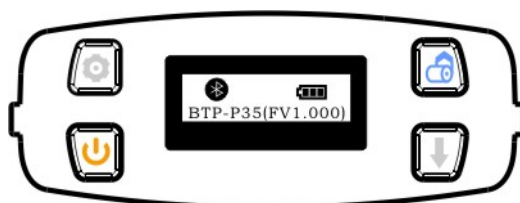

4.1 Explanation of panel

4.1.1 Appearance panel



4.1.2 Button function

Button	Function	Explanation
 Power button	1. On / off 2. Sleep / wake-up state	In the power on state, press [Power] button for a long time to turn off the printer. In the power off state, press the [Power] button for a long time to turn on the printer. In the working stat, press [Power] button for a short time to enter the sleep mode. In the sleep state, press the [Power] button for a short time to exit the sleep mode. In the power off state, press the [Power] button for a short time for no response.
 Configuration button	1. Enter the configuration 1. Go to the submenu 2. Enter parameter configuration 3. Switch the parameter position 4. Confirm the configuration 5. Execute menu operation	Press [Configuration] button in the idle or pause state The printer enters the configuration state and allows menu configuration Press [Configuration] button in configuration state 1. When the current menu has sub-menu, select it and enter the current sub-menu 2. The current menu has no sub-menu but there is parameter adjustment, enter the parameter configuration 3. You need to adjust the cursor position when the parameters to be adjusted have many bits 4. Confirm the current parameter configuration and return to the parent menu

		5. When the current menu has no submenu and no parameter adjustment, the current menu operation is selected and executed
 Paper feed button/ up button	Paper feed	Press the [Feed] button in the idle state: paper feed
	Pause printing	Press the [Feed] button in the working state: pause printing
	Resume printing	Press the [Feed] button in the pause state: 1. If you paused a print job before, resume printing 2. If there is no pause print job, return to the main page
	1. Page up 2. Adjust parameter up	Press the [UP] button in the configuration state: 1. Select the previous menu 2. Increase the adjustment parameter by degree when the parameter is adjusted
 Pause button/Down button	Pause	Press the [Pause] button in the non-configuration state The printer enters pause state
	1. Page down 2. The parameter is adjusted downward.	Press the [Down] button in the configuration state 1. Select the next menu when select the menu 2. Decrease the adjustment parameter by degree when the parameter is adjusted

4.2 System menu:

First class menu		Second class menu		Third class menu		Fourth class menu
Number	Content	Number	Content	Number	Content	Content
1	Setup	1	Print setup	1	Print mode	Rewind mode, tear-off mode,
				2	Sensor selection	Standard configuration reflective sensor,

						optional configuration reflective sensor, optional transmissive sensor
				3	Print darkness	00~30
				4	Print speed	02~04 IPS
				5	Paper feed when start up	No feeding. Start calibration. Fix position to label
				6	Close cover and feed paper	No feeding. Start calibration. Fix position to label
				7	retract paper setup	Enabled; Disabled
					Back to second class menu	
		2	Paper setup	1	Paper type	Continuous paper;

						marked paper; continuous paper
				2	Left margin	0~49mm
				3	Right margin	0~49mm
				4	Label length	0~8000
				5	Label width	0~5000
				6	Horizontal offset	0~800
				7	Vertical offset	0~199
				8	Tear-off position	0~199
				9	Detect paper when idle	Enabled; Disabled
				10	Back to previous level	
		3	Sensor setup Code setup	1	Paper sensor threshold	0~255
				2	Mark sensor threshold	0~255

				3	Label light strength	0~255		
				4	Mark light strength	0~255		
				5	Sensor information	Display the information of sensor		
				6	Back to previous level			
		4	WLAN configuration			1	IP address	IP address
						2	Subnet mask	Subnet mask
						3	Gateway	Gateway
						4	IP protocol	TCP UDP
						5	WLAN port	WLAN port setup
						6	WLAN information	Port information
						7	BT code	
						8	BT information	
		5	Other configurations			1	Sleep time	Not sleep 10~60s
						2	The time of automatic power off	Not power off 5~40min
		9	Back to previous level					

				3	Language setup	Chinese English
				4	Command language	ESC/POS BPLZ/BPLE
				5	Buzzer volume	High Low
				6	Button buzzer	On Off
				7	USB mode	API mode Class mode
		6	Factory reset	Reset outgoing parameter		
		7	Save /Exit	Whether save the current setup or not		
2	Print self-test	Printer information output				
3	Print calibration	Calibrate the current light strength of sensor				
4	Cancel print	Cancel caching data of printing				
5	Exit	Exit menu				

4.3 Main parameter setup

1) The display when start up

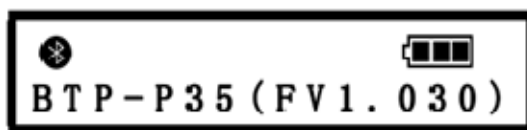

Indicating the printer is ready for task (Firmware version is according to outgoing printer configuration)

2) Main parameter setup

When the printer is ready for task, please press [Setup] button, the interface will display:



1. SETUP
2. SELFTEST

Use the “Up / Down” button to select the “Setup” menu item.

- Print mode

Set the print mode in the “Setup / Print setup / Print mode Setup” menu item.



1. PRINT MODE
PEEL OFF

Use the “Up / Down” button to select the mode. Optional modes are “tear-off mode”, “rewind mode”.

- Print darkness setup

Set the print darkness in the “Setup / Print Setup / Print darkness” item.



3. DARKNESS
30

Use the “Setup” button to select the ones place and the tens place. The Up / Down button to increases or decreases the darkness value. The maximum value is 30 and the minimum value is 0.

- Print speed setup

Set the print speed in the “Setup / Print Setup / Print Speed” menu item.

Optional speed: 2 IPS~4IPS



4. PRINT SPEED
03 IPS

- Paper type selection

In the menu "Setup / Paper setup / Paper type", set the current paper type. The optional type: "continuous paper", "marked paper".

1. MEDIA TYPE
CONTINUOUS

- Wireless configuration

3. SENSOR SETUP
4. BT&WLAN SETUP

In the "Setup" menu item, select "Setup / Wireless configuration", you can set the printer's network configuration. Such as a protocol type, IP address configuration, gateway configuration, and port configuration.

1. IP ADDRESS
192.168.010.001

2. SUBNET MASK
255.255.255.000

3. GATEWAY
192.168.010.001

4. IP PROTOCOL
TCP

- System language type setup

In the "Configuration / Other Configuration / Language Setup" menu item, set the system language type



3 . LANGUAGE
ENGLISH

- Command set type selection

In the "Configuration / Other Configuration / Command Language" menu item, set the command language type



4 . CMD LANGUAGE
ESC/POS

- System sleep time setup

In the "Configuration / Other configuration / Sleep time" menu item, set sleep status. When enabling sleep, enter the sleep delay time. Delay time is 10m~60m.



1 . SLEEP SET
NEVER

- Print self-test

Press "Setup" button to enter the first level menu, select "Print self-test", you can print out the system configuration information.









1 . SETUP
2 . SELFTEST

- Print calibration

When the paper roll is loaded in the paper cabinet, a print calibration is made. The paper and sensor calibration are made. Press the "Setup" button to enter the first level menu, and select "print calibration" to set.



- Status explanation of the printer

Status explanation	LCD
Print status	
Charging status	
	
Open the paper cabinet	
Paper end status	
NO print head	

4.4 Buzzer function

Status	Explanation
Music when starts up	Prompt music of on and off
Ring for a long time	The printer has a fatal error.
Ring for a short time	1. The printer has a general error or an alert 2. The button prompt sound

Caution:

- ✧ The printer adopts thermal resistor to detect the temperature of print head. If the print head temperature is too high, the printer will stop printing.

4.5 Swipe card function

The BTP-P35 supports magnetic card and IC card swipe function. When the device receives the swipe card command via the communication interface, slide the magnetic card or insert the IC card according to the directions of the magnetic card and the IC card on the device. Then it sends the reading data command to the device.

Caution:

1. Ensure that the IC card chip is outward when insert the IC card (Face one side that someone swipes card).
2. Related commands of magnetic card and IC card refer to software command set of BTP-P35

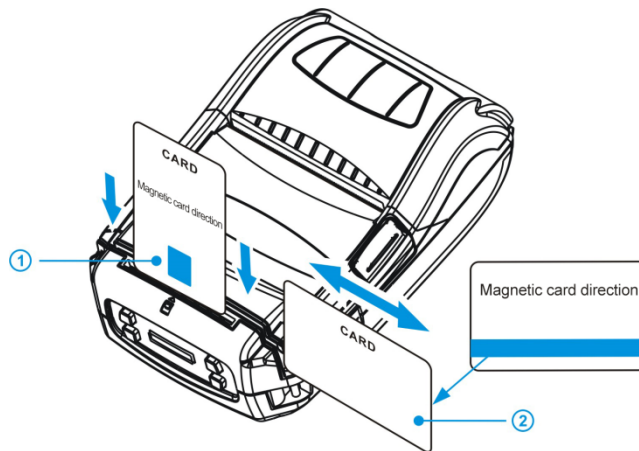

5 Printer communication interface

This BTP-P35 can be connected via USB, Bluetooth4.0 interface and other devices.

5.1 USB interface

USB interface supports USB1.1 protocol.

The interface socket using MINI USB B-type standard socket:

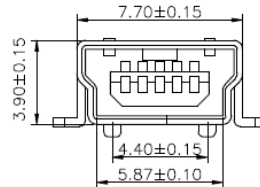

Interface signal definition:

Pin	Cable
1	VCC
2	DATA-
3	DADA+
4	ID
5	GND

5.2 Bluetooth 4.0 interface

1) Features

- Compatible with Bluetooth3.0 / 4.0 + EDR
- 1.8V or 3.3V operating voltage
- UART interface
- Support parameter configuration

2) Support protocols

- BLE data communication protocol.
- 3.0 SPP.

6 Installation printer

6.1 The host accessories

This product configures with standard power adapter, belt clip, USB cable and other accessories, and optional configuration is magnetic card/IC POS machine point of sale machine, battery charger, vehicle-bone charger, IP54 protective cover, shoulder strap and other accessories.

When unpacking, check the packing list whether has the missing or damaged items. If any of the above phenomena occurs, please contact your dealer or manufacturers.

6.2 Precautions for using the printer

When the battery leaves factory, the battery is not installed in the printer. Please insert the battery into the battery cabinet as shown below.

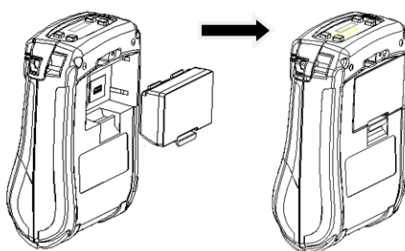

Remarks

For the first time, it needs to be fully charged. After long-term storage of the battery, it needs to be fully charged. And the battery will achieve the best results.



Caution:

- ✧ When install the battery, ensure that the battery is inserted into the cabinet correctly to avoid falling down.

6.3 Power cable connection

1) Pin definition

- 1: Positive (+12V)
- 2: Negative (GND)
- 3: Negative (GND)

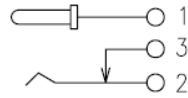

CIRCUIT DIAGRAM

2) Interface type

Printer usage: socket in the following figure in the left

User usage: socket in the following figure in the right

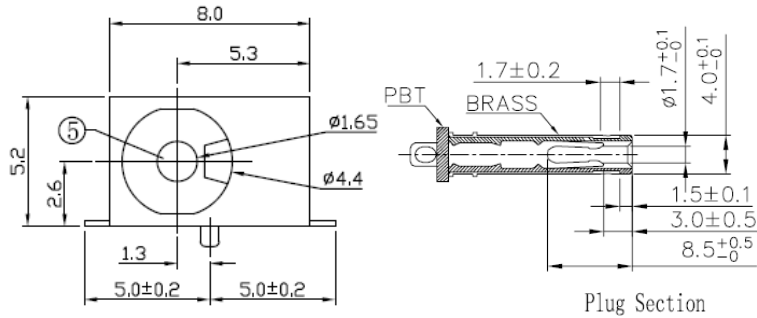

As shown in the figure, insert the power adapter plug into the power socket, DC plug into the printer's charging interface.

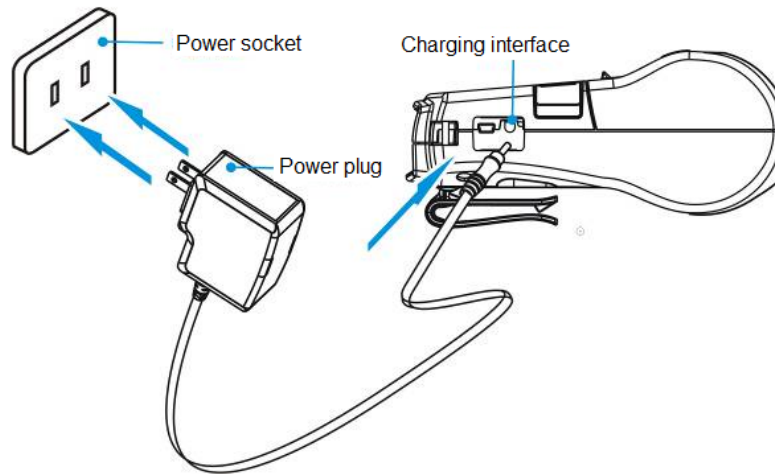

Input voltage: AC100-240VAC / 50 ~ 60Hz

⚠ Caution:

- ✧ Do not remove the battery during charging; When charge the battery, the printer can print task.
- ✧ Should use the manufacturer recommended power adapter or its equivalents;
- ✧ When plugging the plug of power adapter, you should hold the connector cover of the plug, do not pull the cable;
- ✧ Avoid dragging the power adapter cable, or it will damage the cable and cause fire disaster and electric shock.
- ✧ Avoid placing the power adapter around an overheated device, or the cable surface will melt causing fire disaster and electric shock.
- ✧ If the printer is not used for a long time, disconnect the printer power adapter.

6.4 Paper roll installation

6.4.1 Confirmation of printing paper

Before installing the paper roll, you should first check the paper type used by the printer. The default paper type is continuous paper. If you need to set marked paper, please calibrate it.

6.4.2 Install / replace the paper roll

- 1) Press the [Open] button of paper top cover, open the top cover.

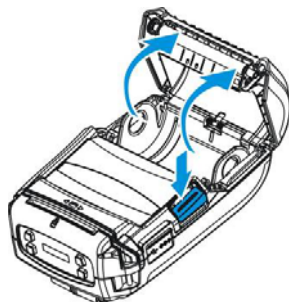

- 2) Hold the paper guide and rotate it upward and forward, then uninstall it .

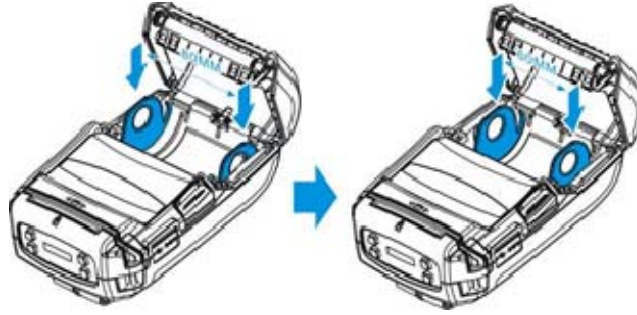

- 3) When the printer is leaving factory, the left and right paper guide is located at the outermost slot of the paper cabinet to fit the 80mm width paper roll. When using 60mm width paper roll, insert the left and right paper guide vertically into the inner slot of paper cabinet.

**Remarks:**

When the printer is printing, the paper guide should center the paper roll in the paper cabinet.

- 4) Make sure the paper head is flush and place the paper roll in the paper cabinet as shown in the figure below. After pulling out the paper head for a distance along the direction of paper out, close the back cover and tear off the excess paper head. Then finish installing paper roll.

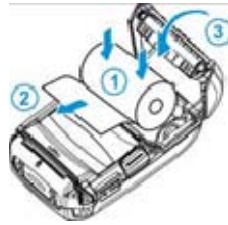
**Caution:**

- ◇ Adjust the paper guide according to the width of paper roll
- ◇ The paper roll should meet the requirements shown below:

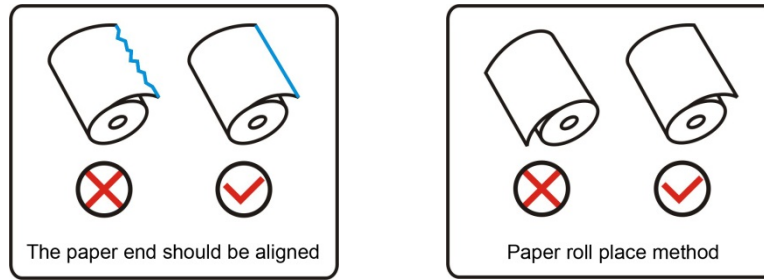

- ✧ The paper roll should be wrapped tightly. Otherwise, it may cause paper jam or other errors.
- ✧ The paper roll should be placed in the paper house smoothly, avoid tilt, otherwise it may affect the printing and paper feeding;
- ✧ The edge of the paper head cannot deviate from the paper out exit.

6.5 Printer connecting installation

When the printer is leaving the factory, the default connection is the belt clip. If you need to attach the shoulder strap, consult your dealer or factory manufacturer.

6.5.1 Printer belt clip installation

When the printer is leaving the factory, the belt clip is not installed in the printer. Please install the belt clip in the printer according to the figure.



Remarks

- ✧ When fastening screw, rotate the belt clip to one side so as not to block the screw mounting hole.
 - ✧ The mounting screws are supplied with the belt clip package.
- ① belt clip cradle 2 ② belt clip ③ ST2.9 × 8-F-Hpan head self-tapping screw



6.5.2 Shoulder strap connection (optional configuration)

When the printer is leaving the factory, the shoulder strap is not installed in the printer. Please install the shoulder strap in the printer according to the figure.

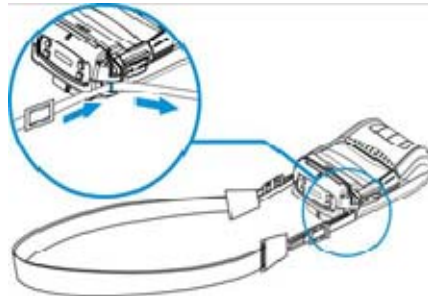

6.6 Printer power on and self-test

6.6.1 Power on the printer

- 1) Make sure the printer battery is fully charged and install in place;
- 2) Press the [power] button for more than two seconds. The printer will turn on and initialize.

6.6.2 Print the self-test page

- 1) Make sure the printer battery is fully charged and installed in place, and install the paper roll;
- 2) Press the "configuration" button while the printer is idle. The printer enters the configuration menu.

- 3) Press "Up" or "Down" to select "2. SELFTEST" or "2.SELFTEST" and press CONFIRM to confirm;
- 4) The printer begins printing the self-test page.

6.7 Connect the communication interface

BTP-P35 has two communication modes:

- Wired communication: USB interface
- Wireless communication: Bluetooth;

6.7.1 USB interface connection

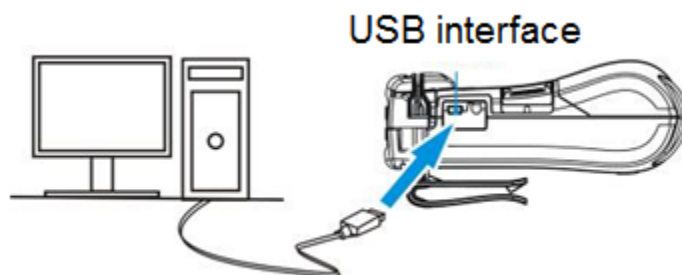

- 1) Insert the USB interface cable into the suitable interface;
- 2) Connect the other end of the interface cable to the host.

6.7.2 Bluetooth connection

Provide Bluetooth4.0 version, communication distance ≤ 10 meters.
See appendix 9.2 for the detailed operation of Bluetooth connection.

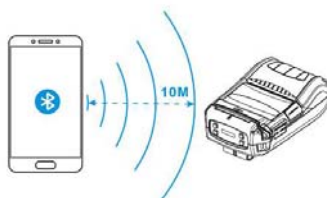

7 Routine maintenance

Caution:

- ◇ Before starting routine maintenance, ensure that turn off the printer
- ◇ Do not use organic solvents like gasoline or acetone.
- ◇ When cleaning the sensors, do not turn on the printer power until the pure alcohol has completely evaporated.
- ◇ It is recommended that the maintenance cycle should not be longer than one month.

7.1 Cleaning print head and platen roller

When any of the following cases occur, the print head and platen roller should be cleaned.

- 1) Printout is not clear;
- 2) Paper feeds or retracts with big noises;
- 3) Other objects on the print head and platen roller.

To clean the print head and platen roller, follow steps given below.

- 1) Turn off the power;
- 2) Press the cover open button to open the top cover of printer. Refer to following Figure;

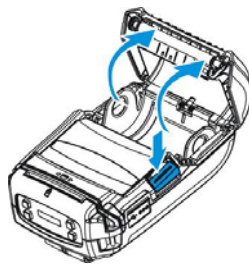

- 3) Use soft cotton cloth dipped with neutral cleaner (it should be wrung out)

to wipe off the dust and stains on the surface of the print head and platen roller when the top cover of the paper cabinet is open;

- 4) Close the top cover of paper cabinet after the neutral cleaner evaporates completely.

7.2 Cleaning marked sensor

When any of the following cases occur, the marked sensor should be cleaned.

- 1) The printer alarms the paper end during printing.
- 2) The printer does not alarm when paper end.
- 3) The printer cannot read the mark effectively.

The cleaning steps are as follows:

- 1) Turn off the power.
- 2) Press the cover open button to open the top cover of printer.
- 3) Wipe off the dust and stains on the surface of the print head and platen roller with alcohol cotton ball (it should be wrung out);
- 4) Close the top cover of printer until the alcohol evaporates completely.

7.3 Remove paper jam

When any of the following cases occur, remove paper jam.

- 1) The printer cannot paper out normally.
- 2) Paper feeds with big noises

To remove paper jam, follow steps given below:

- 1) Turn off the power.
- 2) Press the cover open button to open the top cover of printer.
- 3) Check if there is any jammed paper in the paper path. If it exists, please remove the paper folds, and cut the paper head.
- 4) Close the paper cover of the printer and remove the jammed paper.

8 Troubleshooting

When the printer has any problem, refer to this chapter for solution. If the problem still cannot be solved, please contact your local dealer or manufacturer for assistance.

8.1 Printer doesn't work

Problem	Possible causes	Solution
The printer does not work.	The battery has no power.	Please charge the battery or replace the battery.
	The battery does not connect well.	Take out the battery and re-install it.
	Circuit board is damaged.	Contact your local dealer or manufacturer.

8.2 LCD alarm and buzzer alarm

LCD prompt information	Causes	Solution
Print head voltage is abnormal	Print head voltage is abnormal	Close the printer, check the battery voltage
Print head is abnormal	The print head is too heat	Wait for the temperature of print head to come down.
Printer head bad dot	Printer head bad dot	Contact your local dealer or manufacturer.
Paper end	Paper end	Replace with new paper roll.
Paper cabinet is not closed.	Uplift the top cover	Close the top cover.
Power is low.	Power is low.	Replace with new battery or charge the battery.
Mark check failed	Cannot find the mark. Wrong paper type	Replace with matched paper roll or start the forcing calibration
Calibration fails	Calibration fails Wrong paper type	Replace with matched paper roll or start the forcing calibration
The printer is busy	The printer is busy	Wait for idle status
System updates	The printer is updating system	Wait for completing System updating
Pause	The printer is in pause status	Press the feed paper button, recover normal status

8.3 Problems during printing

Problem	Possible causes	Solution
Paper feed continuously when printing	Wrong paper type	Replace with matched paper roll
	Marked sensor errors	Contact your local dealer or manufacturer.
Paper cannot be sent out normally.	Paper jam	Open the top cover, check the paper feeding path and clear the jammed paper.
Vertical print content is missing.	Print head error	Contact your local dealer or manufacturer.

9 Appendix

9.1 Printer driver installation on windows

BTP-P35 provides Windows 2000/Windows XP/Windows Server 2003/Windows Vista/Windows Server 2008/2012/Windows 7/Windows 8/Windows 10 operating systems drivers.

9.2 Bluetooth connection

1. Local printer Bluetooth interface and WINDOWS XP system connection
 - 1) The Bluetooth receiver is plugged into the USB port on the PC and the Bluetooth icon is displayed at the bottom right of the Windows. Double click the Bluetooth icon to display the following screen
 - 2) Click the “add”; Click “next” to search the Bluetooth device
 - 3) Click “next” and input the code: 1234
 - 4) Next
 - 5) Complete the connection

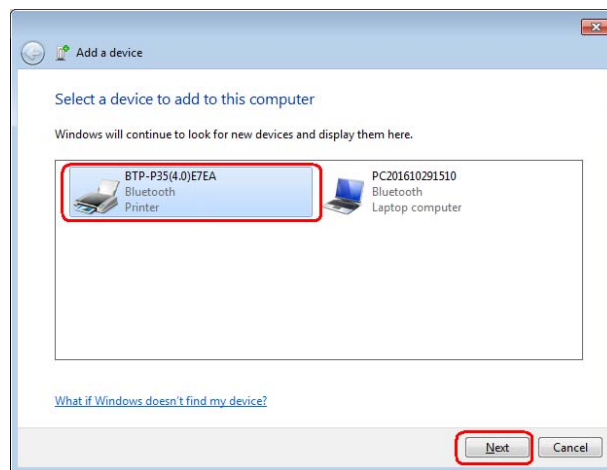

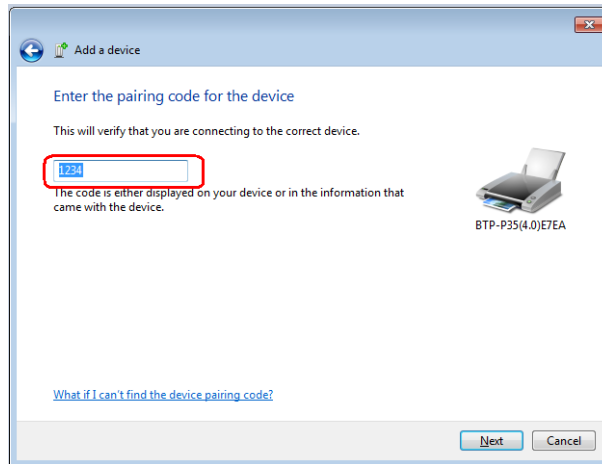
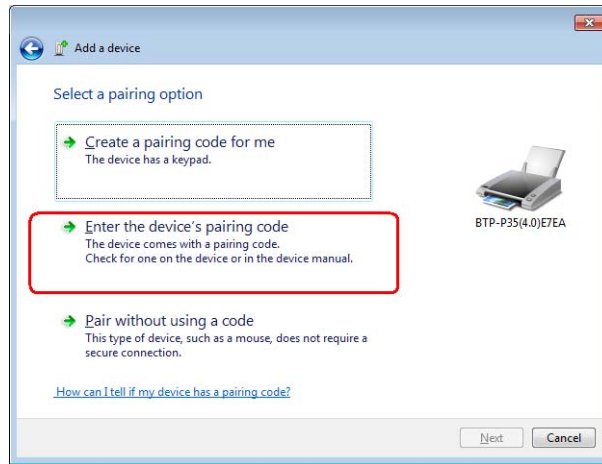

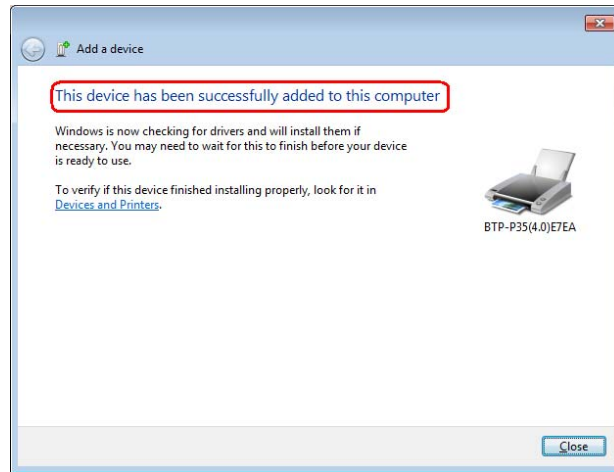

2. BTP-P35 printer Bluetooth interface and Android system connection
 - 1) Bluetooth printer is on, turn on the Bluetooth of Android system.
Scan to search device, and select printer "BTP-P35-4.0".
 - 2) Match "BTP-P35-4.0"
 - 3) Match successfully

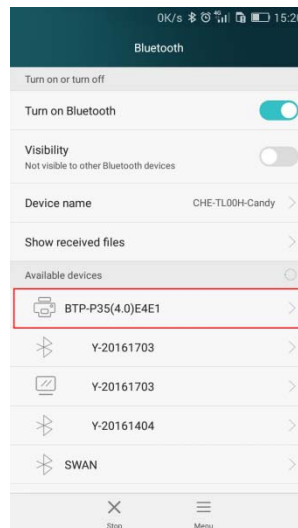

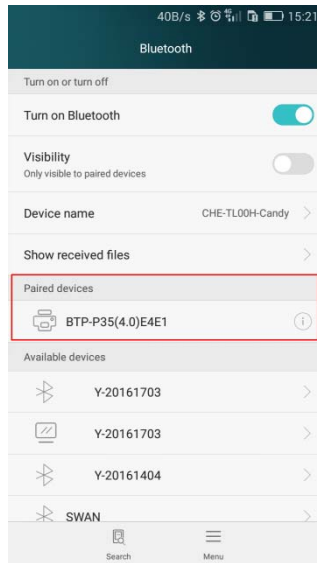
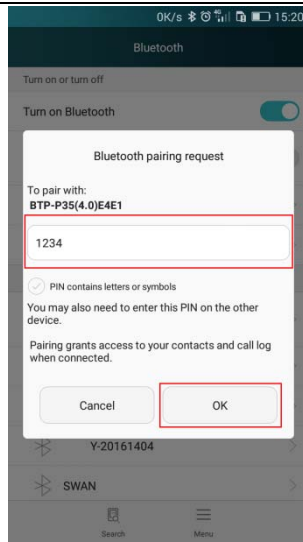

9.3 FCC STATEMENT

This device complies with Part 15 of the FCC Rules. Operation is subject to the following two conditions:

(1) This device may not cause harmful interference, and (2) This device must accept any interference received, including interference that may cause undesired operation.

Warning: Changes or modifications not expressly approved by the party responsible for compliance could void the user's authority to operate the equipment.

NOTE: This equipment has been tested and found to comply with the limits for a Class B digital device, pursuant to Part 15 of the FCC Rules. These limits are designed to provide reasonable protection against harmful interference in a residential installation. This equipment generates uses and can radiate radio frequency energy and, if not installed and used in accordance with the instructions, may cause harmful interference to radio communications. However, there is no guarantee that interference will not occur in a particular installation. If this equipment does cause harmful interference to radio or television reception, which can be determined by turning the equipment off and on, the user is encouraged to try to correct the interference by one or more of the following measures:

- Reorient or relocate the receiving antenna.

- Increase the separation between the equipment and receiver.

- Connect the equipment into an outlet on a circuit different from that to which the receiver is connected.

- Consult the dealer or an experienced radio/TV technician for help.

RF warning statement:

The device has been evaluated to meet general RF exposure requirement. The device can be used in portable exposure condition without restriction.