

USER'S MANUAL

Portable Printer BTP-P33



Shandong New Beiyang Information Technology Co., Ltd.

Contents

1 INTRODUCTION.....	- 1 -
1.1 OUTLINE.....	- 1 -
1.2 MAIN FEATURES.....	- 1 -
2 MAIN TECHNICAL SPECIFICATION.....	- 2 -
2.1 TECHNICAL SPECIFICATION.....	- 2 -
2.2 PAPER SPECIFICATION.....	- 4 -
2.3 PRINT AND TEAR-OFF POSITION.....	- 7 -
3 APPEARANCE AND COMPONENTS.....	- 9 -
3.1 APPEARANCE AND COMPONENTS.....	- 9 -
4 INSTALLATION.....	- 11 -
4.1 UNPACKING.....	- 11 -
4.2 BATTERY INSTALLATION.....	- 12 -
4.3 INTERFACE CABLE CONNECTION.....	- 12 -
4.4 PAPER ROLL INSTALLATION.....	- 13 -
4.5 PRINT SELF-TEST PAGE AND DUMP MODE.....	- 15 -
5 ROUTINE MAINTENANCE.....	- 16 -
5.1 CLEANING PRINT HEAD AND PLATEN ROLLER.....	- 16 -
5.2 CLEANING SENSOR.....	- 16 -
6 INTERFACE SIGNAL.....	- 17 -
6.4 USB INTERFACE.....	- 17 -

7TROUBLESHOOTING..... - 18 -

7.1 PRINTER DOESN'T WORK..... - 18 -

7.2 OLED ALARM..... - 18 -

7.3 PROBLEMS DURING PRINTING..... - 18 -

Declaration

Information in this document is subject to change without notice. SHANDONG NEW BEIYANG INFORMATION TECHNOLOGY CO., LTD. (hereinafter referred to as "SNBC") reserves the right to improve product as new technology, components, software, and firmware become available. If users need further data about this product, please feel free to contact your dealer or the manufacturer.

No part of this document may be reproduced or transmitted in any form or by any means, electronic or mechanical, for any purpose without the express written permission of SNBC.

Copyright

Copyright © 2017 by SNBC.

Printed in China.

Version 1.0.

Trademark

Our registered trademark: .

Warning and caution



Warning: Items shall be strictly followed to avoid any damages to body and equipment;



Caution: Items with important information and prompts for operating the printer.

SNBC has passed the following certifications:

ISO9001 Quality Control System Certification

ISO14001 Environmental Management System Certification

OHSAS18001 Occupational Health and Safety Management System Certification

IECQ QC 080000 Hazardous Substance Process Management System Certification

Contact us:

Address: No.169 huojia road, high-tech zone, Weihai, China

Hot line: 400-618-1368 800-860-1368

Fax: +86-631-5656098

PC: 264209

Website: www.newbeiyang.com.cn

BTP-P33 has passed the following certifications:

General Safety Information

Before installing and using the printer, please read the following items carefully.

1. Safety instructions



Warning: Don't touch the tear bar of printer..



Warning:The print head is a thermal element and it is at high temperature during printing or just after operation, therefore please do not touch it and its peripherals for safety reasons.



Warning: The thermal head is an ESD-sensitive device. To prevent damage, do not touch either its printing part or connecting parts.

2. Caution

- 1) Keep the printer away from water source, and avoid direct exposure to sun light, strong light and heat of fire.
- 2) Do not use or store the printer in a place exposed to high temperature, moisture and serious pollution.
- 3) Do not place the printer on a place exposed to vibration or impact.
- 4) No dew condensation is allowed to the printer. In case of such condensation, do not turn on the power until it has completely evaporated.
- 5) Connect the charger to an appropriate grounding outlet. Avoid sharing a single electrical with large power motors and other devices that may cause the fluctuation in voltage.
- 6) Take out the battery of printer when the printer is not used for a long time.

- 7) Do not let the water or electric materials (like metal) go into the printer. If this happens, take out the battery immediately.
- 8) Do not allow the printer to start printing when there is no recording paper installed; otherwise the print head and platen roller will be seriously damaged.
- 9) To ensure the print quality and normal lifetime, use recommended or good quality paper.
- 10) The printer should only be disassembled or repaired by a technician, who is certified by the manufacturer.
- 11) Keep this manual safe and at hand for ready reference.

1 Introduction

1.1 Outline

BTP-P33 is a mobile receipt / label printer, mainly used for indoor and outdoor mobile receipt and label printing, with following characteristics like good protection performance, long working hours of battery, compact, easy to operate, etc.

1.2 Main features

- 1.5meters anti-drop design, which guarantee the outdoor work demand
- OLED display screen, visual key operation, easy to use
- Small size, light weight, easy to carry
- Support USB and Bluetooth wireless communication mode, which meet different application requirements
- Can adapt to -10℃ low temperature working environment, with wide applicationareas
- Support three different paper widths of 44/60/80mm, while supporting the label paper, black marked paper, continuous paper, with goodconsumables adaptability
- Support Windows/CE/Mobile/Android/IOS mainstream mobile operating system, with strong compatibility

2 Main technical specification

2.1 Technical specification

Item	Parameters
Printmethod	Thermal
Print resolution	203DPI×203DPI
Print speed	Label: Max.50mm/s Receipt: Max.76mm/s Note: Factory default value is 50mm/s
Print width	Max.72mm
Paper type	Sticky label paper, black marked paper, continuous paper
Paper width	Continuous paper: 44±0.5mm, 60±0.5mm, 80±0.5mm Marked paper: 44±0.5mm, 60±0.5mm, 80±0.5mm Label paper: 80±0.5mm Note: To support different paper widths via installing corresponding sensors at different positions. Default to support 80mm.
Paper thickness	Label paper: 0.06-0.16mm; Marked paper and continuous paper: 0.06-0.10mm
Barcode support	1D barcode: ESC/POS commands: UPC-A, UPC-E, JAN13 (EAN13), JAN 8 (EAN8), CODE39, ITF, CODABAR, CODE93, CODE128 1D barcode (CPCL): UPC-A, UPC-E, JAN13 (EAN13), JAN8(EAN8), CODE39, CODE93, Interleaved 2 of 5, Interleaved 2 of 5 with checksum, CODE128, UCC EAN 128, CODABAR, MSI 2D barcode (ESC/POS): PDF417, QRCODE, MAXICODE, GS1 2D barcode (CPCL): PDF417, QRCODE

<p>Character support</p>	<p>Character Set (ESC/POS): built-in standard ASCII character (9X17,12X24), user-defined characters, standard configuration of Chinese (24 × 24) supports simplified Chinese (2312), English (ASCII), optional configuration supports simplified Chinese (18030 or GBK), traditional Chinese, the United States, Britain, Japan and Korea. Users can download fonts to FLASH or RAM Character set (CPCL): 8×16, 16×16, 20×12, 12×24, 24×24, 28×27, 34×48, 42×46, 48×47, 74×45, support simplified Chinese GB18030/BIG5</p>	
<p>Character handling</p>	<p>All characters can be enlarged 1-6 times horizontally and vertically</p>	
	<p>Support rotation printing in four directions (0°, 90°, 180°, 270°)</p>	
<p>Paper detection</p>	<p>Photoelectric sensors (paper end), photoelectric sensor (label paper position)</p>	
<p>Top cover position detection</p>	<p>Micro switch</p>	
<p>Print head temperature detection</p>	<p>Thermistor</p>	
<p>Graphic handling</p>	<p>Bitmap downloading</p>	<p>Direct bitmap printing</p>
	<p>Can download max. 255 FLASH bitmaps or 8 RAM bitmaps; download buffer size: 64 KB FLASH bitmap, 128k RAM bitmap.</p>	<p>Support bitmap mode, can realize fast graphics printing</p>
<p>Communication interface</p>	<p>Bluetooth, USB interface</p>	
<p>Cash drawer interface</p>	<p>None</p>	
<p>Memory</p>	<p>RAM: 8MB, FLASH: 4MB/8MB(option)</p>	

Power adapter	Input voltage: AC100-240VAC/50~60Hz Output voltage: 12V±0.6V DC, 1A
Print head life	≥50Km(standard test conditions)
Working temperature and humidity	Temperature: -10 ~ 50 °C, Humidity: 10 ~ 90%, non-condensation
Storage temperature and humidity	Temperature: -20 ~ 60 °C, Humidity: 10 ~ 90%, non-condensation
Overall size	109(L)×105(W)×51(H)mm

2.2 Paper specification

- Paper type: label paper, black marked paper, continuous paper, external thermal paper roller
- Paper roll OD: Max. 40mm
- Paper roll ID: Min. 12.5mm

2.2.1 Parameters of continuous paper

Description	Parameters (mm)
Paper width	44/60/80±0.5
Paper thickness	0.06-0.10

2.2.2 Parameters of marked paper

The black marks can be on the print side or the non-print side. When the black marks are on the print side, refer to Fig. 2.2.2-1; when the black marks are on the non-print side, refer to Fig. 2.2.2-2.

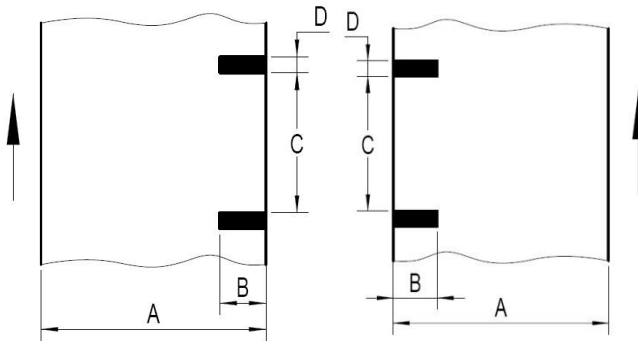

Fig. 2.2.2-1 Black marks on print side Fig.2.2.2-2 Black marks on non-print side

The arrow directions in the figures are the paper feeding directions.

Mark	Description	Parameters (mm)
A	Paper width	44±0.5
B	Length of black mark	13~44
C	Space between black marks	10~1000
D	Height of black marks	2~8
//	Paper thickness	0.06-0.10
//	Mark reflectivity	<15%

Mark	Description	Parameters (mm)
A	Paper width	60±0.5
B	Length of black mark	10~60(left)21~60(right)
C	Space between black marks	10~1000
D	Height of black marks	2~8
//	Paper thickness	0.06-0.10
//	Mark reflectivity	<15%

Mark	Description	Parameters (mm)
A	Paper width	80±0.5
B	Length of black mark	20~80(left)13~80(right)
C	Space between black marks	10~1000
D	Height of black marks	2~8
//	Paper thickness	0.06-0.10
//	Mark reflectivity	<15%

2.2.3 Parameters of label paper

Label gap: the transmission sensor (standard configuration) is located at the centerleft position

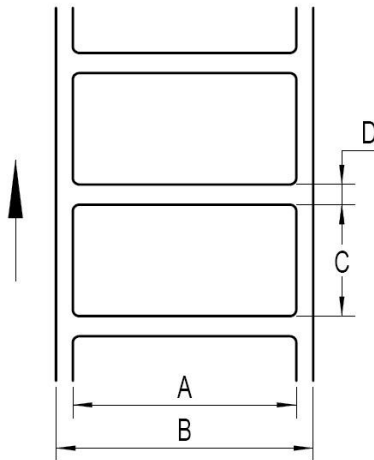

Fig. 2.2.3-1 Label paper type

The arrow direction in the figure is the paper feeding direction.

Mark	Description	Parameters (mm)
A	Label width	$\leq B$
B	Liner width	80 ± 0.5
C	Label length	10~1000
D	Label gap	2~5
//	Paper thickness	0.06-0.16
//	Liner transmittance	50%-75%

2.3 Print and tear-off position

2.3.1 Print position

Print length: Max.1000mm,Min.25mm(Label paper type)

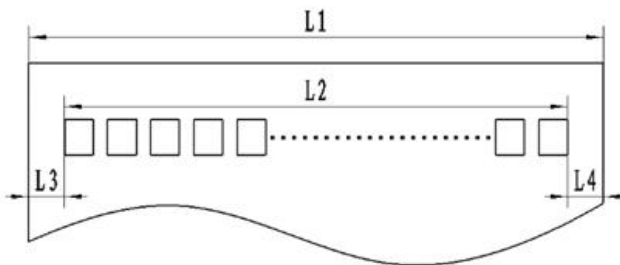

L1: Paper width

L2: Print width

L3: Distance from the print content to the left edge

L4: Distance from the print content to the right edge

For different paper width (L1), the print width(L2) and the distance from print content to left and right edges L3 / L4) will change according to the following table:

Paper width (L1)	Print width (L2)	Distance from the print content to the left edge(L3)	Distance from the print content to the right edge(L4)
80mm	72mm	4mm	4mm
60mm	58mm	1mm	1mm
44mm	42mm	1mm	1mm

2.3.2 Tear off position

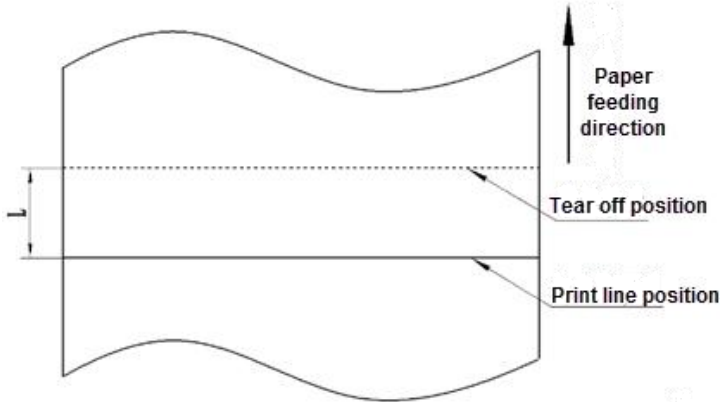

L: About 8mm

3 Appearance and components

3.1 Appearance and components

- 1 — Middle cover
- 2 — Dust-proof rubber
- 3 — Top cover
- 4 — Cover open button
- 5 — Power/Serial/USB interface
- 6 — Button
- 7 — LCD
- 8 — Platen roller
- 9 — Black mark sensor
- 10 — Print head
- 11 — Tear off bar
- 12 — Paper guide
- 13 — Paper end/Label sensor
- 14 — Bottom cover

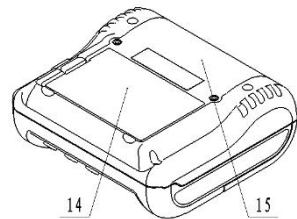
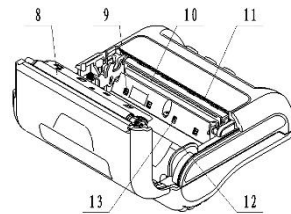
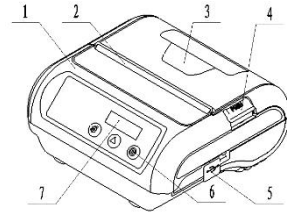

Button and component function:

➤ Power button

Press the power button for a long time can turn on/off the printer; under sleep mode, press the button can wake the printer.

➤ Set button

Press the button under standby status to enter configuration mode; press the button to switch configuration items under configuration

mode; press the button to wake the printer under sleep status.

➤ FEED button

Under standby status, press the button for a short time to feed the paper for a small distance, while press the button for a long time to feed the paper for a long distance or positioning; after entering configuration mode, press the button for configuration change; under sleep mode, press the button to wake the printer.

➤ Paper end sensor

Under continuous paper status, the sensor is used to detect paper presence/paper absence; under marked paper status, the sensor is used to detect the marks of paper.

➤ Paper guide

There are three slots at the bottom of the paper cabinet, insert the paper guide in different slots can adapt to different paper width of 80 ± 0.5 mm, 60 ± 0.5 mm and 44 ± 0.5 mm.

 **ion:**

The paper guides are essential parts for adjusting the print width, thus please take care of the paper guides. The temperature of print head is detected by a thermal resistor. If the print head is overheating, the protective circuit will shut off the power and force the printer to stop printing; The temperature of print head is 65°C when the printer stops printing.

4 Installation

4.1 Unpacking

Check whether all items, which are listed on the packing list, are present and in a good condition. If any item is damaged or missing, please contact your dealer or the manufacturer.

Packed items for standard configuration are as following:

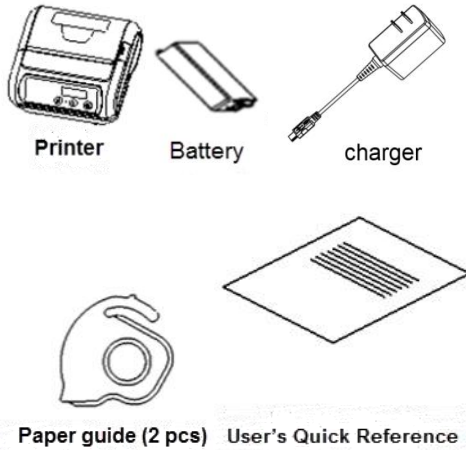

According to different customer's options, the packed accessories may include:

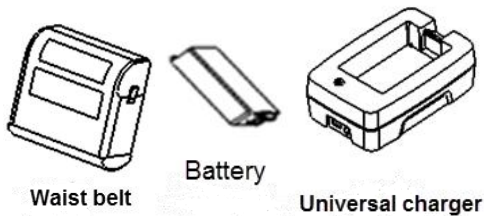

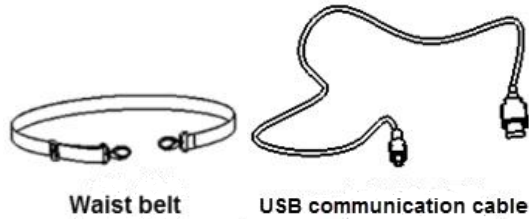

- Waist bag: pack the printer in a waist bag and hang it to the waist by using a waist belt.
- Shoulder belt: pack the printer in a waist bag and hang it to the shoulder by using a shoulder belt.

4.2 Battery installation

Install the battery into the battery cabinet in place as shown in the figure and press it down to fully fit the printer.

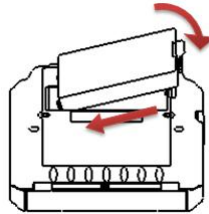

Caution:

- If the printer will be not used for a long time, please take out the battery.
- Replace the battery with a wrong type may cause an explosion, please make sure the battery is well disposed after use.

4.3 Interface cable connection

Connect the charger / USB connector to the USB interface as shown in the figure.

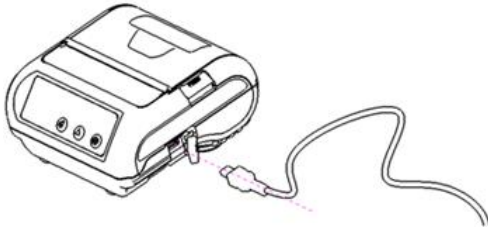

4.4 Paper roll installation

- 1) Press the spanner to open the top cover of printer;
- 2) Install the paper roll as shown in the label affixed inside the paper cabinet.
Different width of paper roll can be adjusted by the paper guide;
- 3) Press down the top cover of printer until it snaps the body in place.

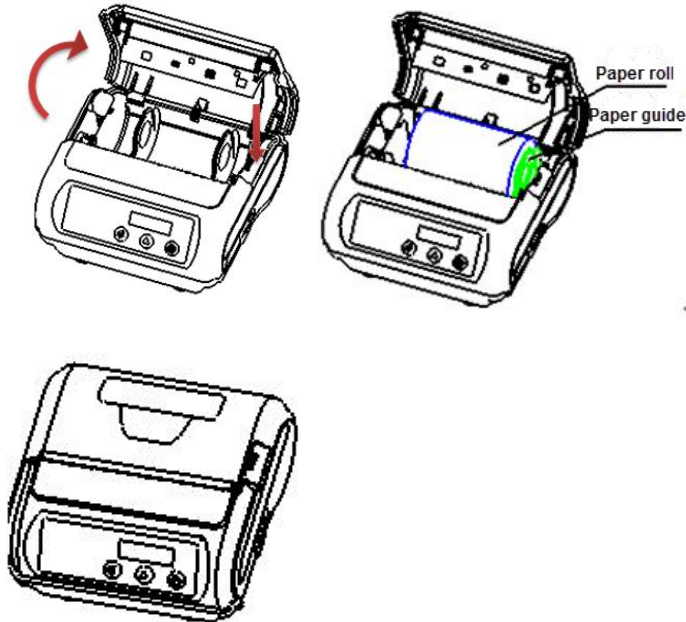

 **Caution:**

- ◇ Adjust the position of paper guide to adjust the width of paper cabinet according to the papersizeused: grasp the round hole on the back of paper guide and press down the lock claw of paper guide, rotate it upward and remove it; select appropriate position to insert the paper guide according to the paper width; note that the paper winding direction of paper roll should meet therequirements of printer;
- ◇ Ensure thatthe paper is wound tightly on the paper roll, otherwise it maycausepaper jamorother faults;
- ◇ The paper roll should be placed smoothly in the paper cabinet without tilt; otherwise it will affectthe printing.

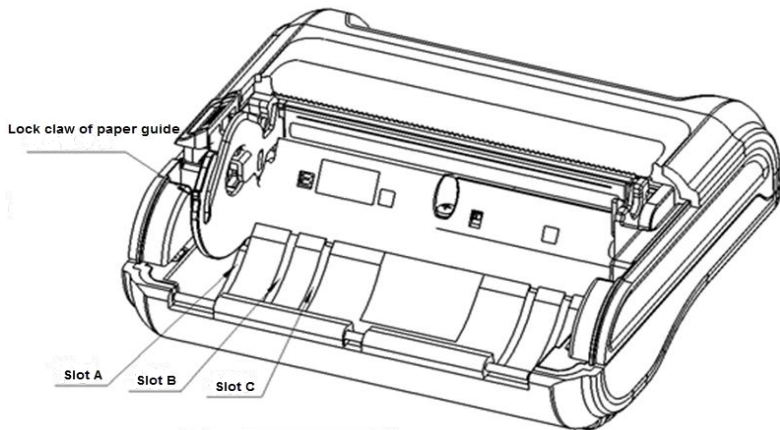

Notes:

- Paper guide is inserted in slot A: $80\pm 0.5\text{mm}$
- Paper guide is inserted in slot B: $60\pm 0.5\text{mm}$
- Paper guide is inserted in slot C: $44\pm 0.5\text{mm}$

4.5 Print self-test page and Dump mode

4.5.1 Print self-test page

- 1) Install the paper roll;
- 2) Press the FEED button when the battery has power;
- 3) Press the power button to turn on the power, and the printer will print the self-test page.

4.5.2 Dump mode

- 1) Press the FEED button 1s after printing the self-test page, and the printer will enter Dump mode. After entering Hexadecimal dumping mode, the printer will print out the data transmitted from the host computer in hexadecimal and their corresponding ASCII characters.

The sample printed under Hexadecimal dumping mode is as follows:

```

Hexadecimal Dump
To terminate hexadecimal dump,
press FEED button three times.

1B 21 00 1B 26 02 40 40 1B 69      . ! . . & . @ . . i
1B 25 01 1B 63 34 00 1B 30 31      . % . . c 4 . . 0 1
41 42 43 44 45 46 47 48 49 4A      A B C D E F G H I J

*** completed ***
    
```

- 2) Exiting from Hexadecimal dumping mode in the following ways:
 - a. Turn off the power, and then restart the printer.
 - b. Press the FEED button for three times.

5 Routine maintenance

Caution:

- ✧ Before starting routine maintenance, ensure that the battery of printer is taken out.
- ✧ Do not use organic solvents like gasoline or acetone.
- ✧ When cleaning the sensors, do not turn on the printer power until the pure alcohol has completely evaporated.
- ✧ It is recommended that the maintenance cycle should not be longer than one month.

5.1 Cleaning print head and platen roller

- 1) Remove the battery of printer and open the top cover;
- 2) Wait for the print head to cool down completely if it has just finished the printing;
- 3) Wipe off the dust and stains on the surface of the print head and platen roller with alcohol cotton ball (it should be wrung out);
- 4) Close the top cover of printer until the alcohol evaporates completely.

5.2 Cleaning sensor

When the printer cannot identify the marks and paper end status effectively, the marksensors should be cleaned. The cleaning steps are as follows:

- 1) Remove the battery of printer;
- 2) Press the cover open button to open the top cover of printer;
- 3) Wipe off the dust and stains on the surface of the sensors with soft alcohol cotton cloth (it should be wrung out);
- 4) Close the top cover of printer until the alcohol evaporates completely.

6Interface signal

BTP-P33 can connect with other devices via USB interface and wireless transmission.

6.4 USB interface

USB interface supports USB2.0 standard protocol and can be connected directly to the computer for communication, also it can realize the printer commissioning, upgrading and other functions.

The socket is the Mini USB 10P standard socket.

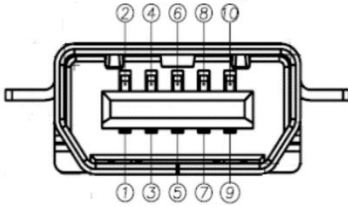

Interface signal definition is as following:

Pin	Wire
1	/
2	VBUS
3	VIN
4	USB-D-
5	VIN
6	USB-D+
7	/
8	/
9	charger-test
10	GND

7 Troubleshooting

When the printer has any problem, refer to this chapter for solution.

If the problem still cannot be solved, please contact your local dealer or manufacturer for assistance.

7.1 Printer doesn't work

Problem	Possible causes	Solution
The LCD is off and the printer does not work.	The battery has no power.	Please charge the battery or replace the battery.
	The battery does not connect well.	Take out the battery and re-install it.
	Circuit board is damaged.	Contact your local dealer or manufacturer.

7.2 OLED alarm

LED display	Solution
Paper end	Replace with new paper roll.
Paper cabinet is not closed.	Close the top cover.
Power is low.	Replace with new battery or charge the battery.
Print head is abnormal	Wait for the temperature of print head to come down.
Wrong paper type	Replace with marked paper or label paper with better quality, or contact with the manufacturer.

7.3 Problems during printing

Problem	Possible causes	Solution
Paper cannot be sent out normally.	Paper jam	Open the top cover, check the paper feeding path and clear the jammed paper.
Printer starts printing but stops suddenly during printing.	Paper end	Re-load the paper.

Printout is not clear or has stains.	Paper roll is not installed correctly.	Check whether the paper roll is installed correctly or not.
	Paper is out of specification.	Use the recommended thermal paper.
	Dirty print head or platen roller	Clean the print head or the platen roller.
	Print darkness is too low.	Increase the print darkness in the button configuration.
Vertical print content is missing.	Dirty print head or platen roller	Clean the print head or the platen roller.
	Print head error	Contact your local dealer or manufacturer.

FCC STATEMENT :

This device complies with Part 15 of the FCC Rules. Operation is subject to the following two conditions:

- (1) This device may not cause harmful interference, and
- (2) This device must accept any interference received, including interference that may cause undesired operation.

Warning: Changes or modifications not expressly approved by the party responsible for compliance could void the user's authority to operate the equipment.

NOTE: This equipment has been tested and found to comply with the limits for a Class B digital device, pursuant to Part 15 of the FCC Rules. These limits are designed to provide reasonable protection against harmful interference in a residential installation. This equipment generates uses and can radiate radio frequency energy and, if not installed and used in accordance with the instructions, may cause harmful interference to radio communications. However, there is no guarantee that interference will not occur in a particular installation. If this equipment does cause harmful interference to radio or television reception, which can be determined by turning the equipment off and on, the user is encouraged to try to correct the interference by one or more of the following measures:

- Reorient or relocate the receiving antenna.

- Increase the separation between the equipment and receiver.

- Connect the equipment into an outlet on a circuit different from that to which the receiver is connected.

- Consult the dealer or an experienced radio/TV technician for help.

RF warning statement:

The device has been evaluated to meet general RF exposure requirement. The device can be used in portable exposure condition without restriction.