

FCC TEST REPORT
for
Shandong New Beiyang Information Technology Co., Ltd.

WLAN Interface Module
Model No.: JK-W03

Prepared for : Shandong New Beiyang Information Technology Co., Ltd.
Address : 169 Huoju Road, HDZ, Weihai, Shandong, 264209, China

Prepared By : Shenzhen Anbotek Compliance Laboratory Limited
Address : 1/F., Building 1, SEC Industrial Park, No.0409 Qianhai Road,
Nanshan District, Shenzhen, Guangdong, China
Tel: (86) 755-26066544
Fax: (86) 755-26014772

Report Number : R011504578I
Date of Test : Apr. 21~ May 07, 2015
Date of Report : May 08, 2015

TABLE OF CONTENT

Description

Page

Test Report

1. GENERAL INFORMATION.....	4
1.1. Description of Device (EUT).....	4
1.2. Auxiliary Equipment Used during Test.....	5
1.3. Description of Test Facility.....	6
1.4. Measurement Uncertainty.....	6
2. TEST METHODOLOGY.....	7
2.1. Summary of Test Results.....	7
2.2. Description of Test Modes.....	7
2.3. List of channels:.....	8
3. CONDUCTED EMISSION TEST.....	9
3.1. Block Diagram of Test Setup.....	9
3.2. Power Line Conducted Emission Measurement Limits (15.207).....	9
3.3. Configuration of EUT on Measurement.....	9
3.4. Operating Condition of EUT.....	9
3.5. Test Procedure.....	10
3.6. Test equipment.....	10
3.7. Power Line Conducted Emission Measurement Results.....	10
4. FCC PART 15.247 REQUIREMENTS FOR DSSS & OFDM MODULATION.....	13
4.1 Test Setup.....	13
4.2 6dB Bandwidth.....	13
4.3. Maximum Output Power Test.....	29
4.4. Band Edges Measurement.....	37
4.5. Peak Power Spectral Density.....	75
4.6. Radiated Emissions.....	83
5. ANTENNA APPLICATION.....	94
5.1. Antenna requirement.....	94
5.2. Result.....	94
6. PHOTOGRAPH.....	95
6.1. Photo of Conducted Emission Measurement.....	95
6.2. Photo of Radiation Emission Test.....	95
APPENDIX I (EXTERNAL PHOTOS).....	97
APPENDIX II (INTERNAL PHOTOS).....	101

TEST REPORT

Applicant : Shandong New Beiyang Information Technology Co., Ltd.
Manufacturer : Shandong New Beiyang Information Technology Co., Ltd.
EUT : WLAN Interface Module
Model No. : JK-W03
Serial No. : N.A.
Trade Mark : N.A.
Rating : DC 3.3V

Measurement Procedure Used:
FCC Part15 Subpart C, Paragraph 15.247

The device described above is tested by Shenzhen Anbotek Compliance Laboratory Limited to determine the maximum emission levels emanating from the device and the severe levels of the device can endure and its performance criterion. The measurement results are contained in this test report and Shenzhen Anbotek Compliance Laboratory Limited is assumed full of responsibility for the accuracy and completeness of these measurements. Also, this report shows that the EUT (Equipment Under Test) is technically compliant with the FCC Part 15 Subpart C requirements.

This report applies to above tested sample only and shall not be reproduced in part without written approval of Shenzhen Anbotek Compliance Laboratory Limited.

Date of Test : Apr. 21~ May 07, 2015

Prepared by :

Kebo Zhang

(Tested Engineer / Kebo Zhang)

Reviewer :

Amy Ding

(Project Manager / Amy Ding)

Approved & Authorized Signer :

Tom Chen

(Manager / Tom Chen)

1. GENERAL INFORMATION

1.1. Description of Device (EUT)

EUT : WLAN Interface Module

Model Number : JK-W03

Test Power Supply : AC 120V, 60Hz for host

RF Transmission : 2412MHz~2462MHz (802.11b/802.11g/802.11n(HT20))
Frequency : 2422MHz~2452MHz (802.11n(HT40))

Channels : 11 For (802.11b/802.11g/802.11n(HT20))
7 For (802.11n(HT40))

Modulation : 802.11b CCK
802.11g OFDM
802.11n MCS

Antenna Gain: : 2.5dBi

Applicant : Shandong New Beiyang Information Technology Co., Ltd.
Address : 169 Huoju Road, HDZ, Weihai, Shandong, 264209, China

Manufacturer : Shandong New Beiyang Information Technology Co., Ltd.
Address : 169 Huoju Road, HDZ, Weihai, Shandong, 264209, China

Factory : Shandong New Beiyang Information Technology Co., Ltd.
Address : No.6, Chuhe North Road, Huoju Hi-Tech Zone, Weihai, Shandong,
264209, China

Date of receipt : Apr. 21, 2015

Date of Test : Apr. 21~ May 07, 2015

1.2. Auxiliary Equipment Used during Test

Receipt Printer (Host)	: Model: BTP-R180
Adapter	: Model: DA-36H24 Input: AC 100-240V, 50-60Hz, 1.0A Max. Output: DC 24V, 1.5A
PC	: Manufacturer: DELL M/N: OPTIPLEX 380 S/N: 1J63X2X CE , FCC: DOC
MONITOR	: Manufacturer: DELL M/N: E170Sc S/N: CN-00V539-64180-055-0UPS CE , FCC: DOC
KEYBOARD	: Manufacturer: DELL M/N: SK-8115 S/N: CN-0DJ313-71616-06C-02XN CE , FCC: DOC Cable: 1m, unshielded
MOUSE	: Manufacturer: DELL M/N: M-UARDEL7 S/N: N/A CE , FCC: DOC Cable: 1m, unshielded
Printer	: Manufacturer: Brother M/N: MFC-3360C S/N: N/A CE, FCC: DOC
Power Line	: Non-Shielded, 1.5m
VGA Cable	: Non-Shielded, 1.5m
Network Cable	: Non-Shielded, 1.5m

1.3. Description of Test Facility

The test facility is recognized, certified, or accredited by the following organizations:

CNAS - LAB Code: L3503

Shenzhen Anbotek Compliance Laboratory Limited., Laboratory has been assessed and in compliance with CNAS/CL01: 2006 accreditation criteria for testing laboratories (identical to ISO/IEC 17025:2005 General Requirements) for the Competence of Testing Laboratories.

FCC-Registration No.: 752021

Shenzhen Anbotek Compliance Laboratory Limited, EMC Laboratory has been registered and fully described in a report filed with the (FCC) Federal Communications Commission. The acceptance letter from the FCC is maintained in our files. Registration 752021, July 10, 2013.

IC-Registration No.: 8058A-1

Shenzhen Anbotek Compliance Laboratory Limited., EMC Laboratory has been registered and fully described in a report filed with the (IC) Industry Canada. The acceptance letter from the IC is maintained in our files. Registration 8058A, February 22, 2013.

Test Location

All Emissions tests were performed at Shenzhen Anbotek Compliance Laboratory Limited. at 1/F., Building 1, SEC Industrial Park, No.0409 Qianhai Road, Nanshan District, Shenzhen, Guangdong, China

1.4. Measurement Uncertainty

Radiation Uncertainty : Ur = 4.1 dB (Horizontal)
Ur = 4.3 dB (Vertical)

Conduction Uncertainty : Uc = 3.4dB

2. TEST METHODOLOGY

The tests documented in this report were performed in accordance with ANSI C63.10: 2013 and FCC Part 15, Paragraph 15.247.

2.1. Summary of Test Results

The EUT has been tested according to the following specifications:

Standard	Test Type	Result	Notes
FCC Part 15, Paragraph 15.107, 15.207	Conducted Emission Test	PASS	Complies
FCC Part 15, Paragraph 15.247(b)(1)	Maximum Output Power	PASS	Complies
FCC Part 15, Paragraph 15.247(a)(2)	6dB Bandwidth	PASS	Complies
FCC Part 15, Paragraph 15.247(c)	100kHz Bandwidth of Frequency Band Edges	PASS	Complies
FCC Part 15, Paragraph 15.209(a)(f)	Spurious Emission	PASS	Complies
FCC Part 15, Paragraph 15.247(a)(1)	Frequency Separation	-	N/A
FCC Part 15, Paragraph 15.247(a)(1)(iii)	Number of Hopping Frequency	-	N/A
FCC Part 15, Paragraph 15.247(a)(1)(iii)	Time of Occupancy	-	N/A
FCC Part 15, Paragraph 15.247(c)	Peak Power Density	PASS	Complies

2.2. Description of Test Modes

The EUT has been tested under operating condition.

Software used to control the EUT for staying in continuous transmitting and receiving mode is programmed.

IEEE802.11b: Channel 1(2412MHz), Channel 6(2437MHz) and Channel 11(2462MHz) with 1 Mbps lowest data rate (worst case) are chosen for the final testing.

IEEE802.11g: Channel 1(2412MHz), Channel 6(2437MHz) and Channel 11(2462MHz) with 6 Mbps lowest data rate (the worst case) are chosen for the final testing.

IEEE802.11n (HT20): Channel 1(2412MHz), Channel 6(2437MHz) and Channel 11(2462MHz) with MCS 0 Mbps lowest data rate (the worst case) are chosen for the final testing.

IEEE802.11n (HT40): Channel 3(2422MHz), Channel 6(2437MHz) and Channel 9(2452MHz) with MCS 0 Mbps lowest data rate (the worst case) are chosen for the final testing.

2.3. List of channels:

√ - available

X - tested

Number	Frequency(MHz)		802.11 b/g/n (HT20)	802.11 b/g/n (HT40)
1	2412	√	X	
2	2417	√		
3	2422	√		X
4	2427	√		
5	2432	√		
6	2437	√	X	X
7	2442	√		
8	2447	√		
9	2452	√		X
10	2457	√		
11	2462	√	X	

3. Conducted Emission Test

3.1. Block Diagram of Test Setup

3.1.1. Block diagram of connection between the EUT and simulators

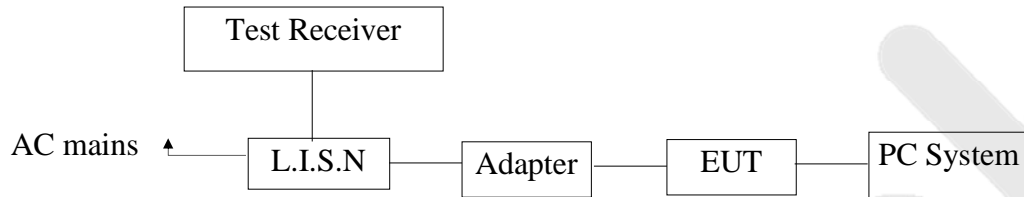

3.2. Power Line Conducted Emission Measurement Limits (15.207)

Frequency MHz	Limits dB(μV)	
	Quasi-peak Level	Average Level
0.15 ~ 0.50	66 ~ 56*	56 ~ 46*
0.50 ~ 5.00	56	46
5.00 ~ 30.00	60	50

- Notes: 1. *Decreasing linearly with logarithm of frequency.
2. The lower limit shall apply at the transition frequencies.

3.3. Configuration of EUT on Measurement

The following equipments are installed on Power Line Conducted Emission Measurement to meet the commission requirement and operating regulations in a manner which tends to maximize its emission characteristics in a normal application.

3.4. Operating Condition of EUT

- 3.4.1. Setup the EUT and simulator as shown as Section 3.1.
- 3.4.2. Turn on the power of all equipment.
- 3.4.3. Let the EUT work in test mode (On) and measure it.

3.5. Test Procedure

The EUT system is connected to the power mains through a line impedance stabilization network (L.I.S.N.). This provides a 50ohm coupling impedance for the EUT system. Please refer the block diagram of the test setup and photographs. Both sides of AC line are checked to find out the maximum conducted emission. In order to find the maximum emission levels, the relative positions of equipment and all of the interface cables shall be changed according to FCC ANSI C63.10-2013 on Conducted Emission Measurement.

The bandwidth of test receiver (ESCI) set at 9KHz.

The frequency range from 150KHz to 30MHz is checked.

The test results are reported on Section 3.6.

3.6. Test equipment

Item	Equipment	Manufacturer	Model No.	Serial No.	Last Cal.	Cal. Interval
1.	Two-Line V-network	Rohde & Schwarz	ENV216	100055	Apr. 17, 2015	1 Year
2.	EMI Test Receiver	Rohde & Schwarz	ESCI	100627	Apr. 17, 2015	1 Year
3.	RF Switching Unit	Compliance Direction	RSU-M2	38303	Apr. 17, 2015	1 Year

3.7. Power Line Conducted Emission Measurement Results

PASS.

The frequency range from 150KHz to 30 MHz is investigated.

Please refer the following pages.

CONDUCTED EMISSION TEST DATA

Test Site: 1# Shielded Room
 Operating Condition: On
 Test Specification: AC 120V, 60Hz for host
 Comment: Live Line
 Tem.:25°C Hum.:50%

SCAN TABLE: "Voltage (150K~30M) FIN"

Short Description: 150K-30M Disturbance Voltages

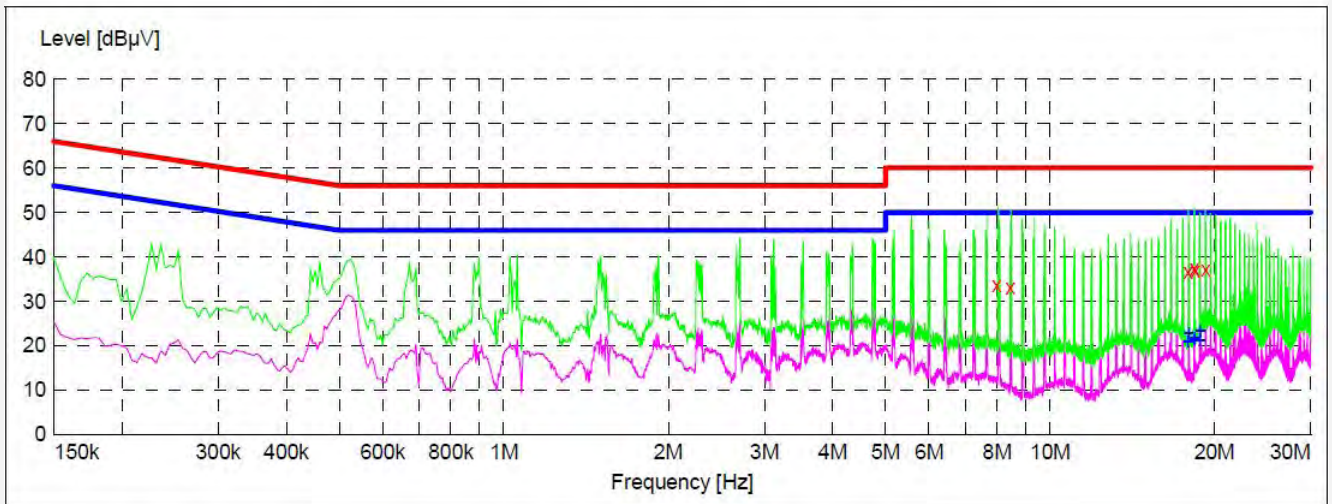

Frequency MHz	Level dBµV	Transd dB	Limit dBµV	Margin dB	Detector	Line	PE
7.993000	33.80	20.5	60	26.2	QP	L1	GND
8.456500	33.30	20.6	60	26.7	QP	L1	GND
17.897500	36.70	20.8	60	23.3	QP	L1	GND
18.379000	37.40	20.8	60	22.6	QP	L1	GND
18.424000	36.80	20.8	60	23.2	QP	L1	GND
19.252000	37.30	20.8	60	22.7	QP	L1	GND

Frequency MHz	Level dBµV	Transd dB	Limit dBµV	Margin dB	Detector	Line	PE
17.897500	21.00	20.8	50	29.0	AV	L1	GND
17.947000	22.70	20.8	50	27.3	AV	L1	GND
18.379000	21.20	20.8	50	28.8	AV	L1	GND
18.415000	21.90	20.8	50	28.1	AV	L1	GND
18.788500	21.30	20.8	50	28.7	AV	L1	GND
18.815500	23.50	20.8	50	26.5	AV	L1	GND

CONDUCTED EMISSION TEST DATA

Test Site: 1# Shielded Room
 Operating Condition: On
 Test Specification: AC 120V, 60Hz for host
 Comment: Neutral Line
 Tem.:25°C Hum.:50%

SCAN TABLE: "Voltage (150K~30M) FIN"

Short Description: 150K-30M Disturbance Voltages

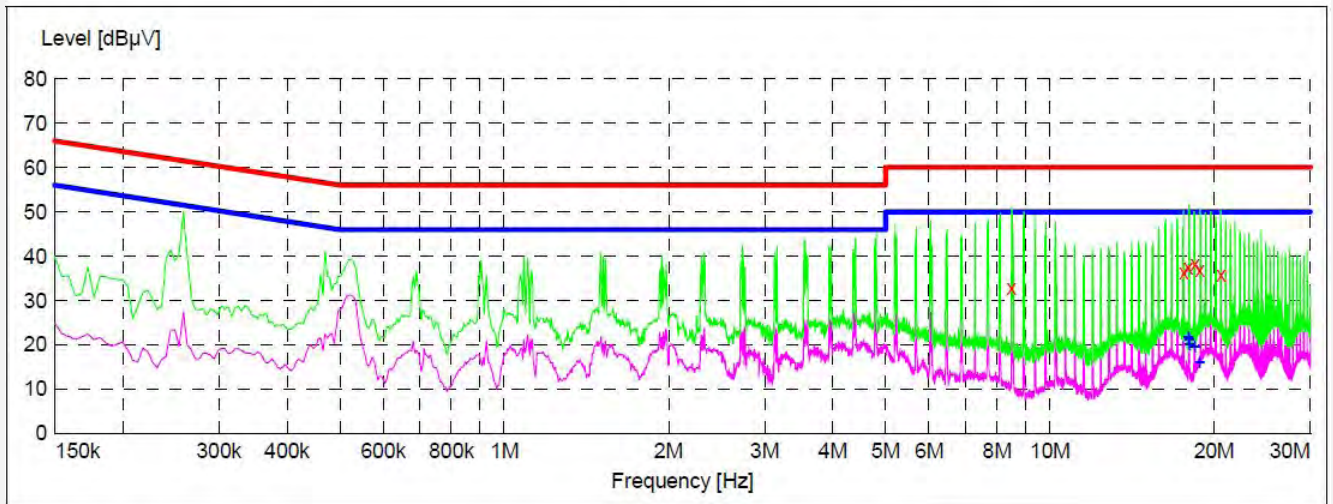

Frequency MHz	Level dBµV	Transd dB	Limit dBµV	Margin dB	Detector	Line	PE
8.497000	32.90	20.6	60	27.1	QP	N	GND
17.587000	36.30	20.8	60	23.7	QP	N	GND
17.947000	37.60	20.8	60	22.4	QP	N	GND
18.428500	38.20	20.8	60	21.8	QP	N	GND
18.820000	37.10	20.8	60	22.9	QP	N	GND
20.579500	35.70	20.8	60	24.3	QP	N	GND

Frequency MHz	Level dBµV	Transd dB	Limit dBµV	Margin dB	Detector	Line	PE
17.947000	21.90	20.8	50	28.1	AV	N	GND
18.014500	20.10	20.8	50	29.9	AV	N	GND
18.019000	21.30	20.8	50	28.7	AV	N	GND
18.428500	19.50	20.8	50	30.5	AV	N	GND
18.793000	16.10	20.8	50	33.9	AV	N	GND

4. FCC Part 15.247 Requirements for DSSS & OFDM Modulation

4.1 Test Setup

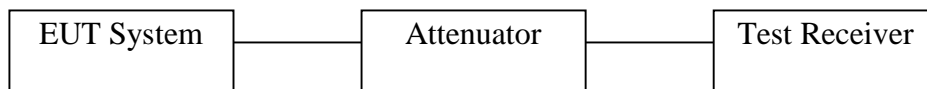

4.2 6dB Bandwidth

a. Limit

For the direct sequence systems, the minimum 6dB bandwidth shall be at least 500kHz.

b. Test Procedure

1. Place the EUT on the table and set it in the transmitting mode.
2. Remove the antenna from the EUT and then connect a low loss RF cable from the antenna port to the spectrum analyzer.
3. Set the spectrum analyzer as:
RBW = 100kHz, VBW $\geq 3 \times$ RBW = 300kHz,
Detector= Peak
Trace mode= Max hold.
Sweep- auto couple.
4. Mark the peak frequency and -6dB (upper and lower) frequency.
5. Repeat until all the rest channels are investigated.

20dB Bandwidth:

C63.10

Occupied Bandwidth (OBW=20dB Bandwidth)

1. Set RBW=1%~5% OBW
2. Set the VBW $\geq 3 \times$ RBW
3. Set the span range between 2 times and 5 times of the OBW
4. Sweep Time= Auto
Detector= Peak
Trace= Max hold
5. Once the reference level is established, the equipment is conditioned with typical modulating signals to produce the worst case (i.e. the widest) bandwidth. Unless otherwise specified for an unlicensed wireless device, measure the bandwidth at the -20dB levels with respect to the reference level.

c. Test Setup See 4.1**d. Test Equipment**

Item	Equipment	Manufacturer	Model No.	Serial No.	Last Cal.	Cal. Interval
1.	Spectrum Analysis	Agilent	E4407B	US39390582	Apr. 17, 2015	1 Year
2.	Preamplifier	Instruments corporation	EMC011830	980100	Apr. 17, 2015	1 Year
3.	EMI Test Receiver	Rohde & Schwarz	ESPI	101604	Apr. 17, 2015	1 Year
4.	Double Ridged Horn Antenna	Instruments corporation	GTH-0118	351600	Apr. 20, 2015	1 Year
5.	Bilog Broadband Antenna	Schwarzbeck	VULB9163	VULB 9163-289	Apr. 20, 2015	1 Year
6.	Pre-amplifier	SONOMA	310N	186860	Apr. 17, 2015	1 Year
7.	EMI Test Software EZ-EMC	SHURPLE	N/A	N/A	N/A	N/A

e. Test Results

Pass.

f. Test Data**6dB Bandwidth**

Test mode: IEEE 802.11b

Channel	Frequency (MHz)	Bandwidth (MHz)	Limit (kHz)	Results
Low	2412	11.72		Pass
Mid	2437	11.72	>500	Pass
High	2462	11.72		Pass

Test mode: IEEE 802.11g

Channel	Frequency (MHz)	Bandwidth (MHz)	Limit (kHz)	Results
Low	2412	16.48		Pass
Mid	2437	16.48	>500	Pass
High	2462	16.48		Pass

Test mode: IEEE 802.11n (HT20)

Channel	Frequency (MHz)	Bandwidth (MHz)	Limit (kHz)	Results
Low	2412	17.64		Pass
Mid	2437	17.64	>500	Pass
High	2462	17.64		Pass

Test mode: IEEE 802.11n (HT40)

Channel	Frequency (MHz)	Bandwidth (MHz)	Limit (kHz)	Results
Low	2422	36.48		Pass
Mid	2437	36.48	>500	Pass
High	2452	36.48		Pass

Test Plots See the following page.

Test Mode: 802.11b---Low

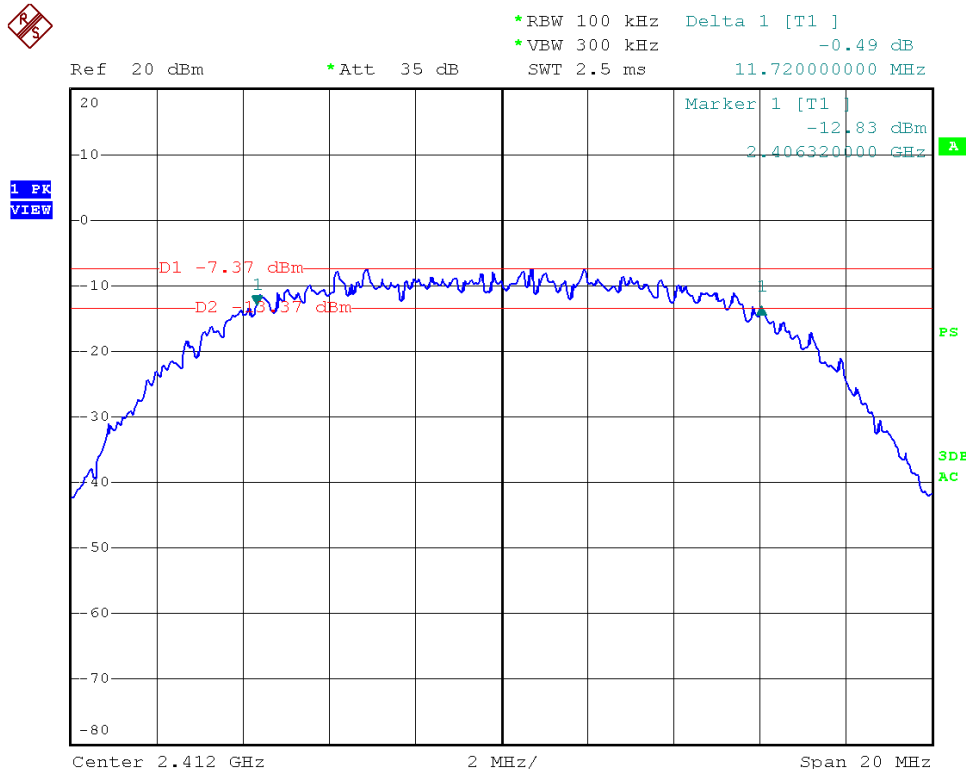

Test Mode: 802.11b---Mid

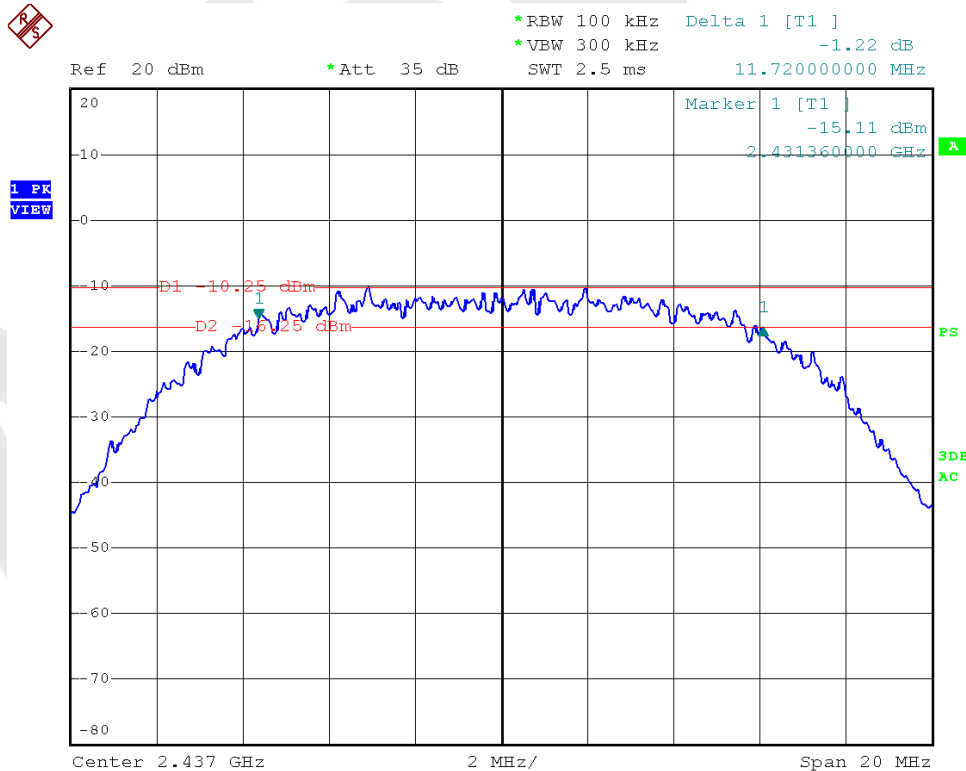

Test Mode: 802.11b---High



*RBW 100 kHz Delta 1 [T1]
*VBW 300 kHz -1.31 dB
SWT 2.5 ms 11.720000000 MHz

Ref 20 dBm *Att 35 dB

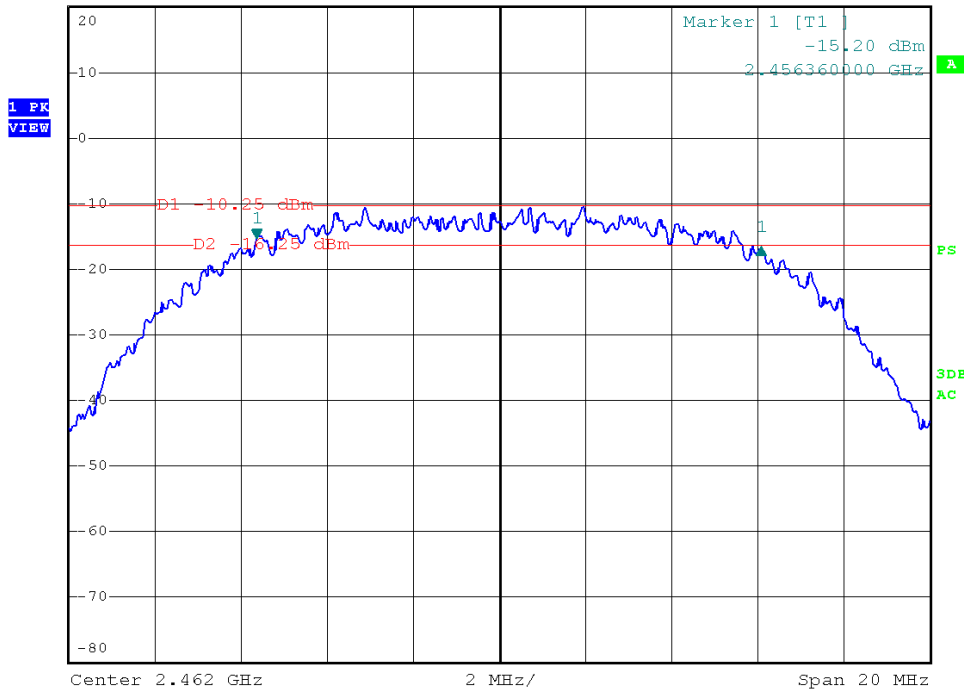

Test Mode: 802.11g---Low



*RBW 100 kHz Delta 1 [T1]
*VBW 300 kHz 0.83 dB
SWT 2.5 ms 16.480000000 MHz

Ref 20 dBm *Att 35 dB

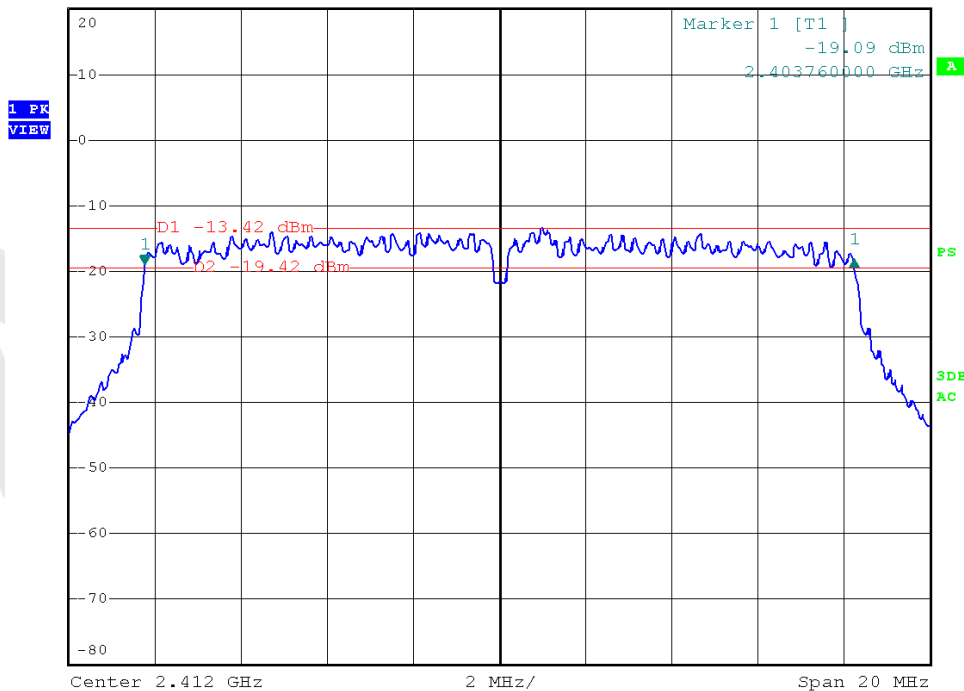

Test Mode: 802.11g---Mid

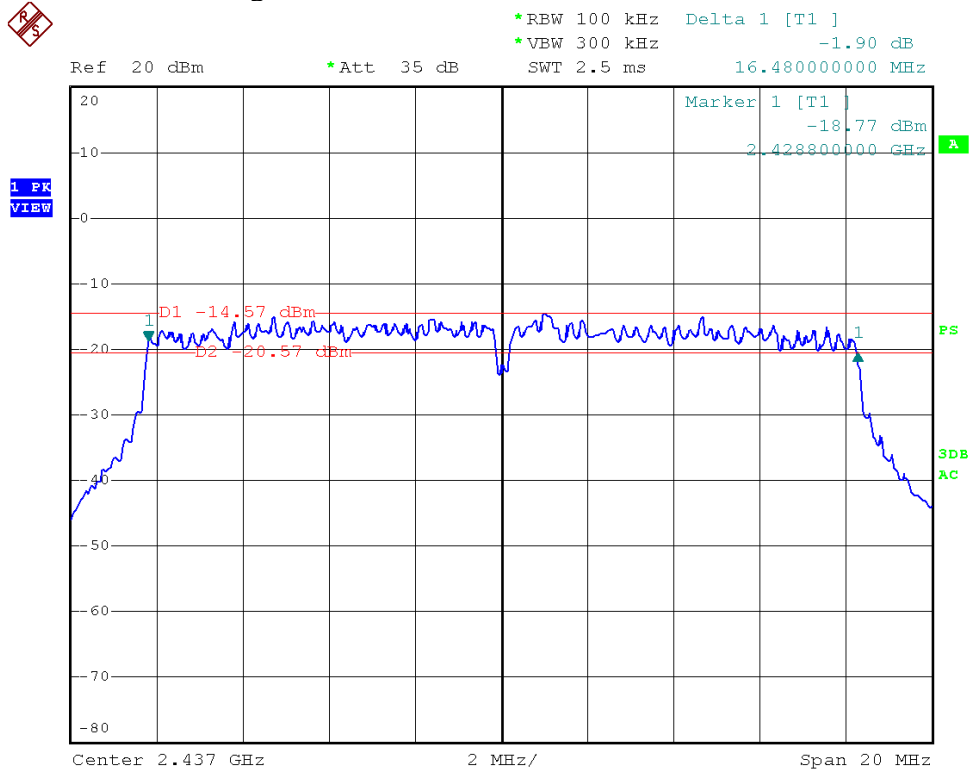

Test Mode: 802.11g---High

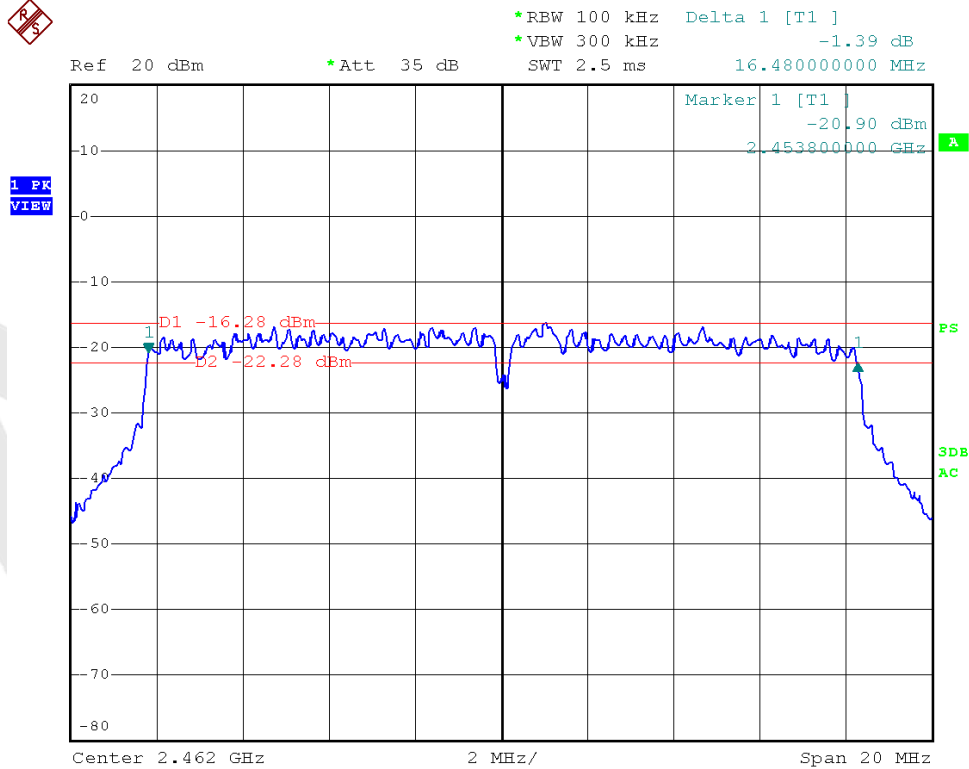

Test Mode: 802.11n (HT20)---Low

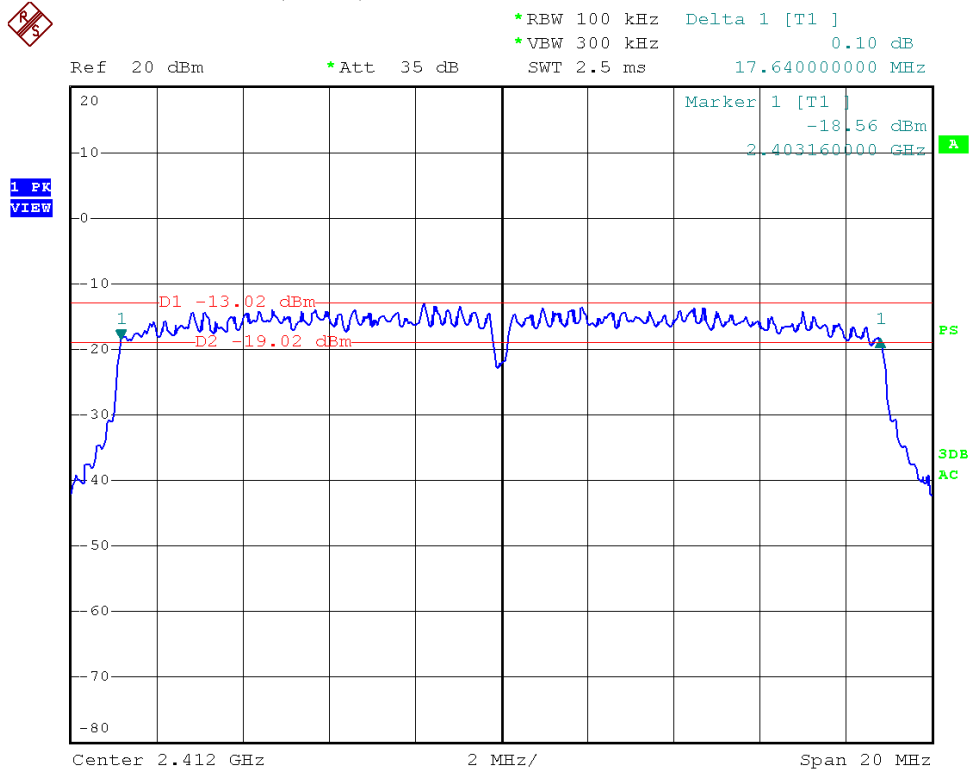

Test Mode: 802.11n (HT20)---Mid

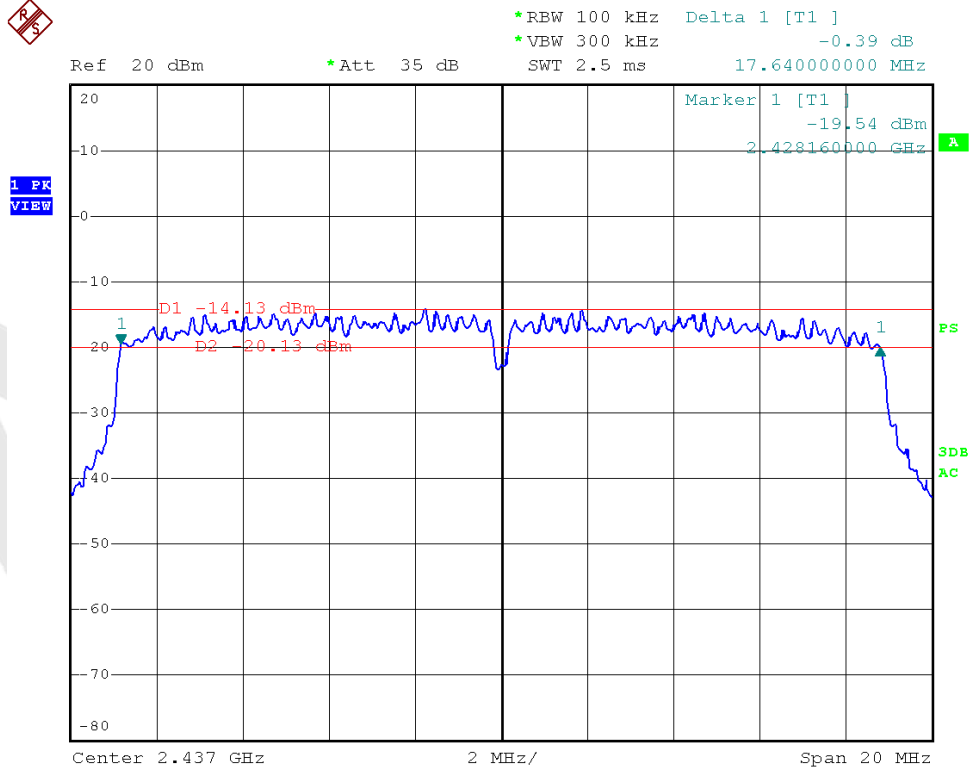

Test Mode: 802.11n (HT20)---High

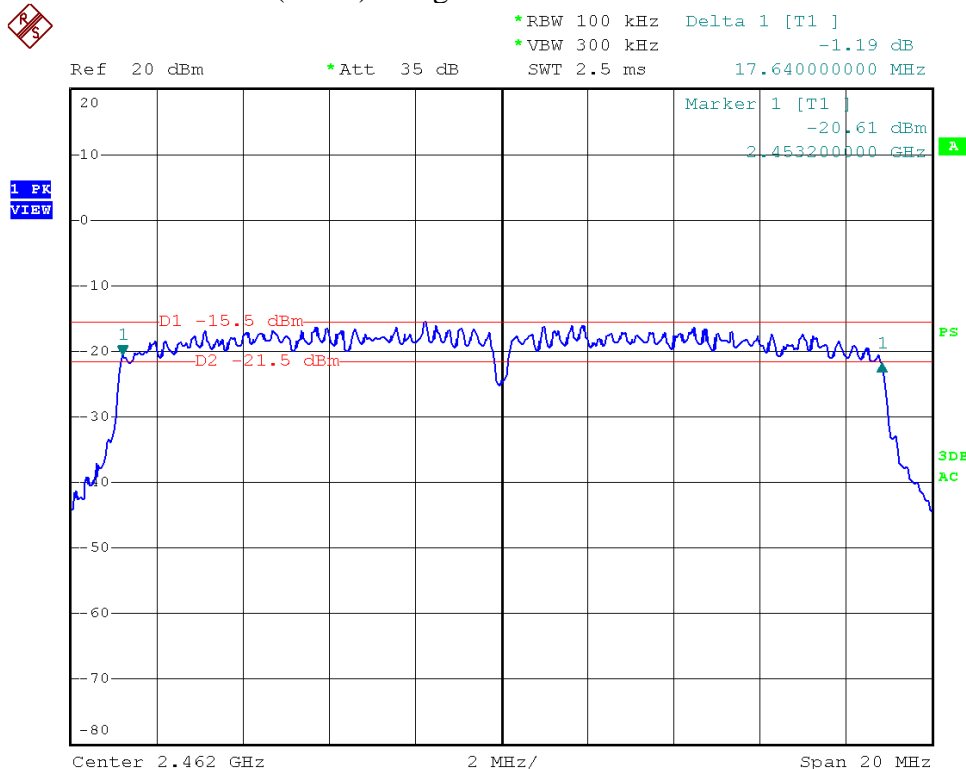

Test Mode: 802.11n (HT40)---Low

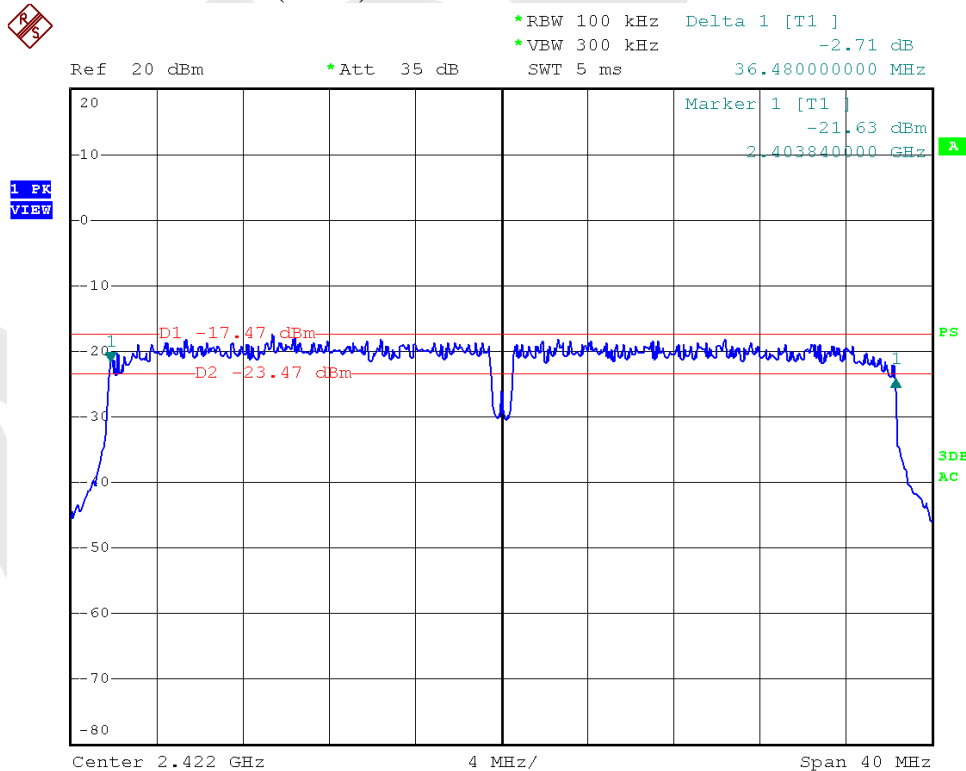

Test Mode: 802.11n (HT40)---Mid

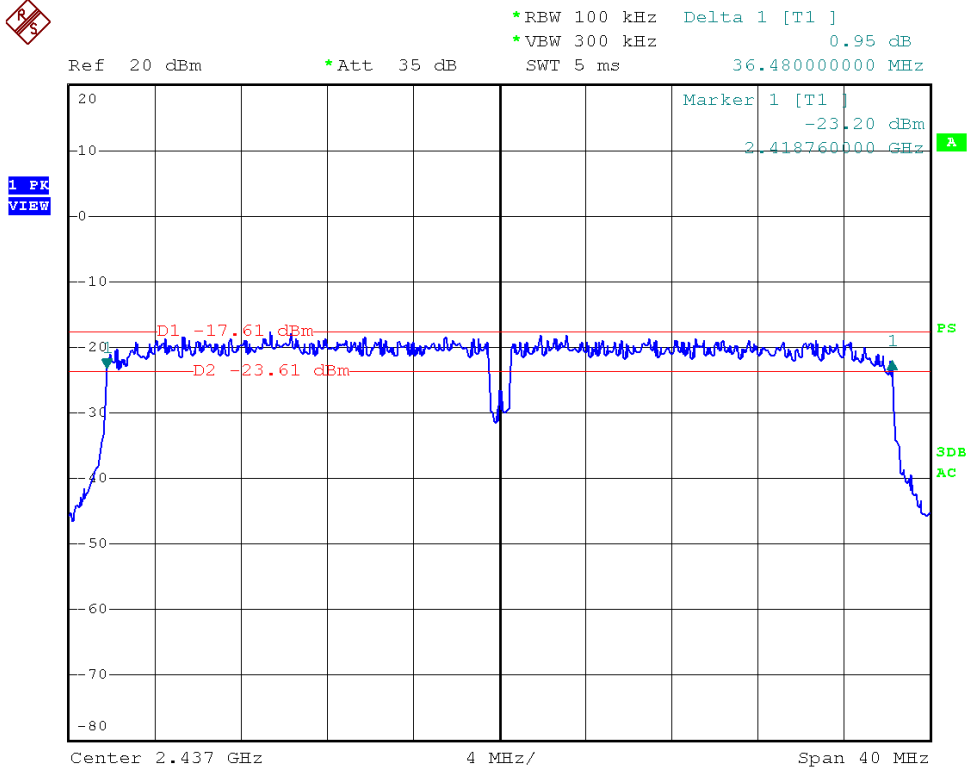

Test Mode: 802.11n (HT40)---High

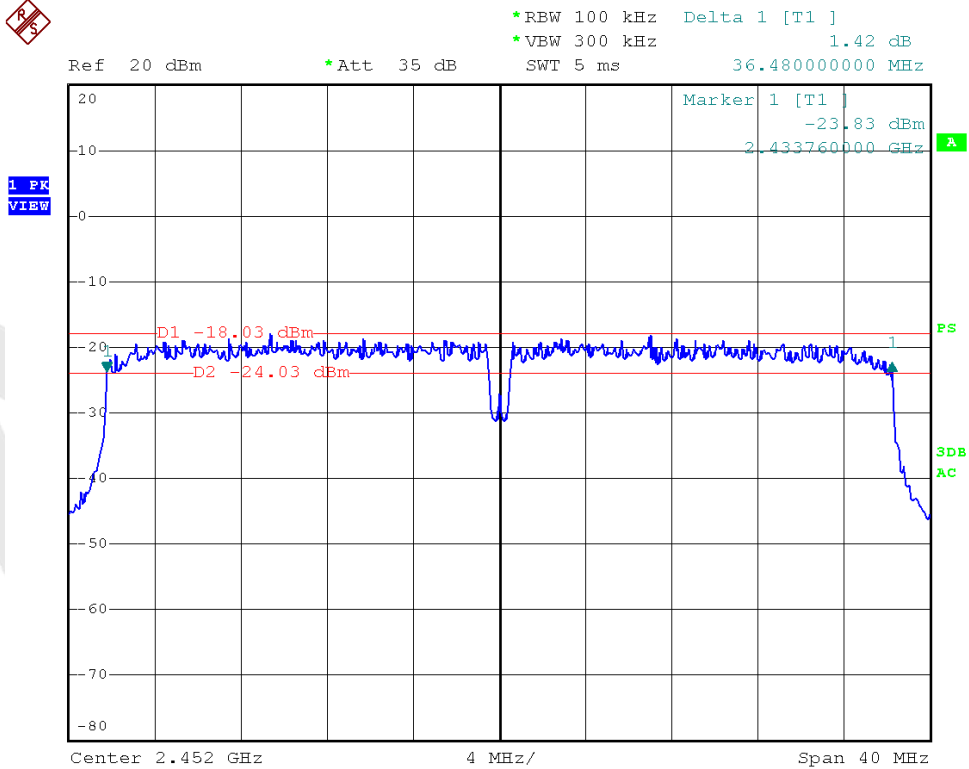

20dB Bandwidth

Test mode: IEEE 802.11b

Channel	Frequency (MHz)	Bandwidth (MHz)	Results
Low	2412	18.96	Pass
Mid	2437	18.88	Pass
High	2462	18.80	Pass

Test mode: IEEE 802.11g

Channel	Frequency (MHz)	Bandwidth (MHz)	Results
Low	2412	21.76	Pass
Mid	2437	21.92	Pass
High	2462	21.76	Pass

Test mode: IEEE 802.11n (HT20)

Channel	Frequency (MHz)	Bandwidth (MHz)	Results
Low	2412	22.72	Pass
Mid	2437	22.64	Pass
High	2462	21.80	Pass

Test mode: IEEE 802.11n (HT40)

Channel	Frequency (MHz)	Bandwidth (MHz)	Results
Low	2422	41.92	Pass
Mid	2437	41.76	Pass
High	2452	41.76	Pass

Test Plots See the following page.

Test Mode: 802.11b---Low

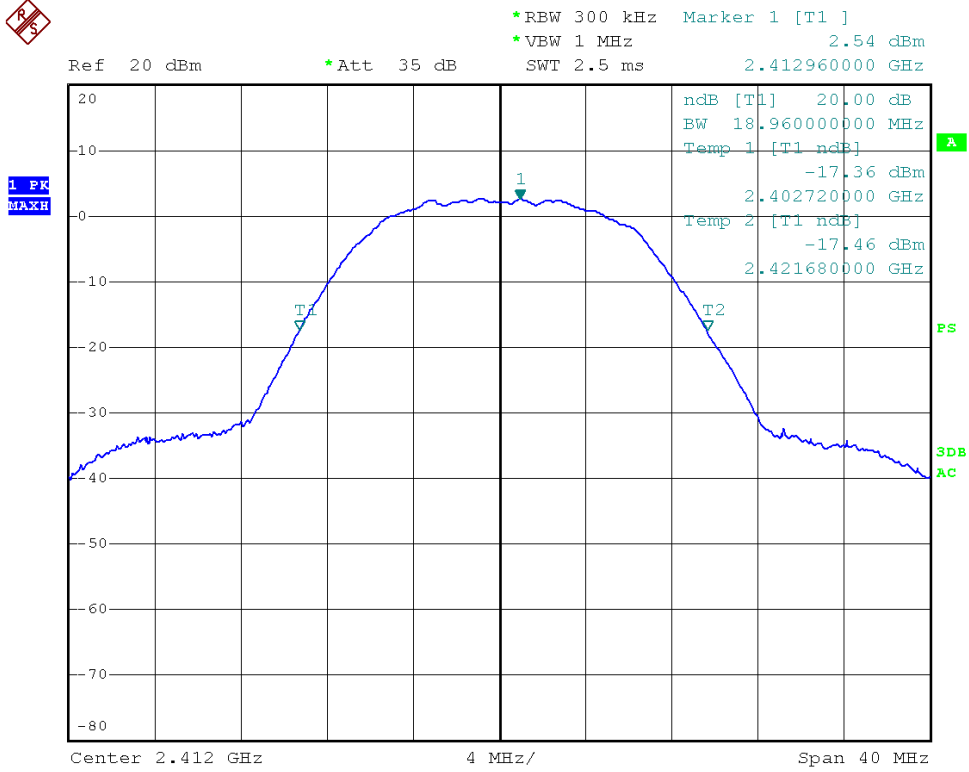

Test Mode: 802.11b---Mid

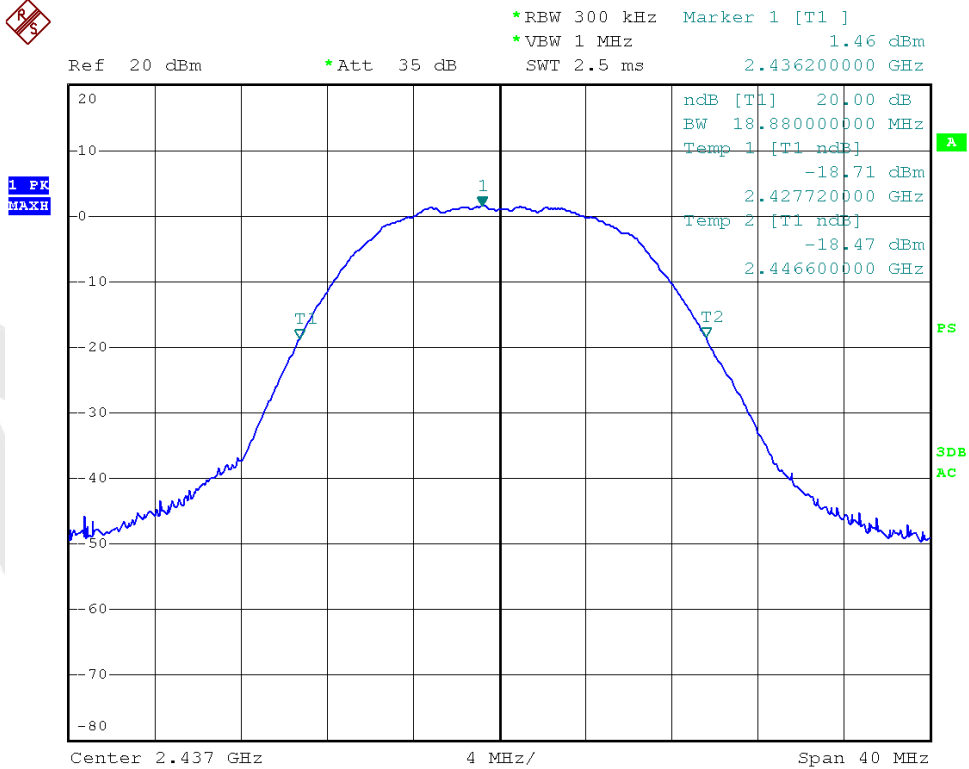

Test Mode: 802.11b---High



*RBW 300 kHz Marker 1 [T1]
*VBW 1 MHz 1.06 dBm
SWT 2.5 ms 2.461120000 GHz

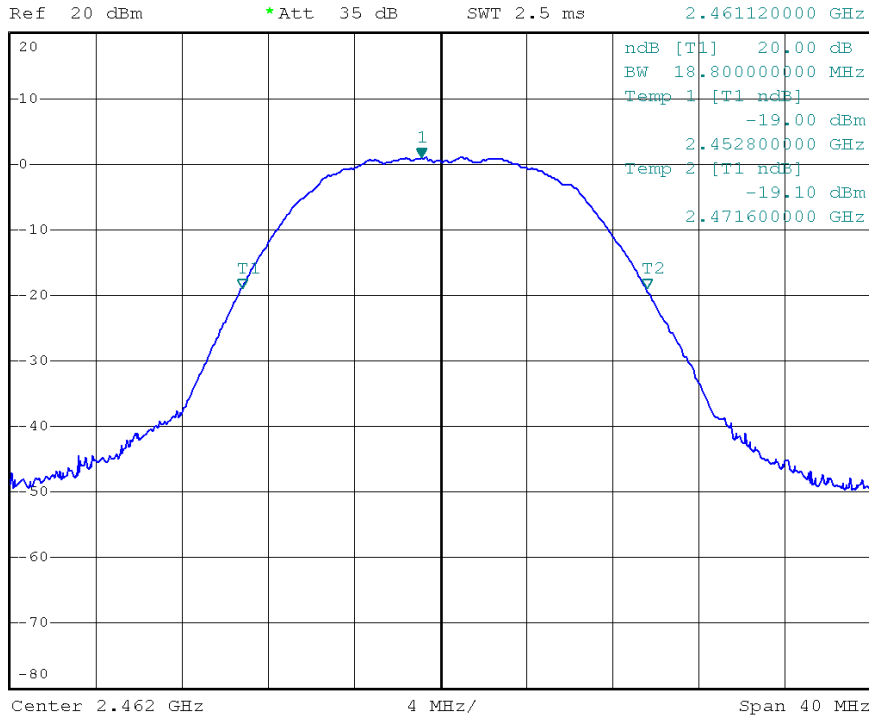

Test Mode: 802.11g---Low



*RBW 300 kHz Marker 1 [T1]
*VBW 1 MHz 0.84 dBm
SWT 2.5 ms 2.414960000 GHz

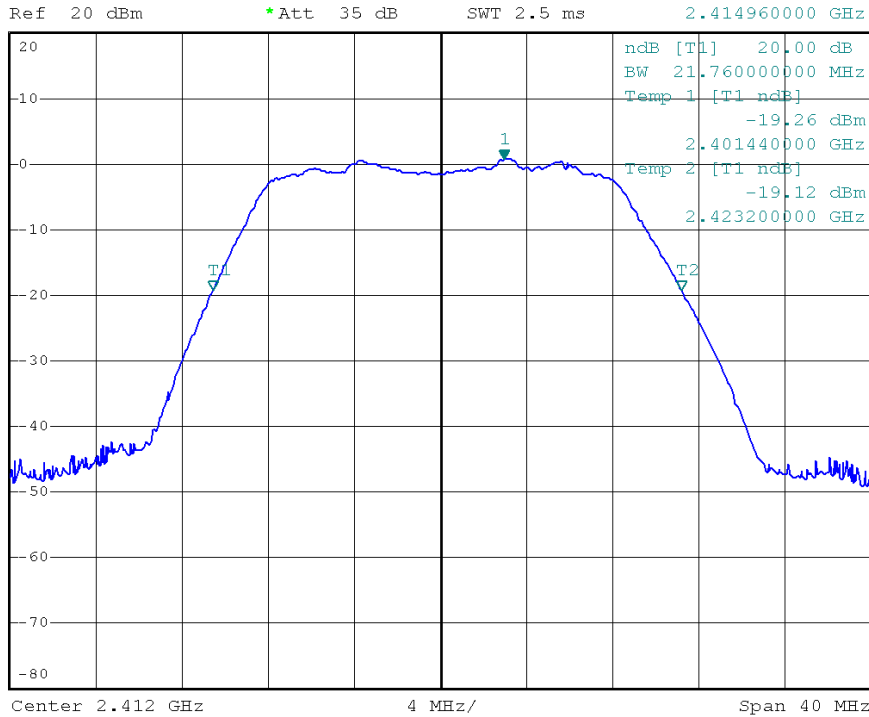

Test Mode: 802.11g---Mid



*RBW 300 kHz Marker 1 [T1] 0.11 dBm
*VBW 1 MHz
SWT 2.5 ms 2.442520000 GHz

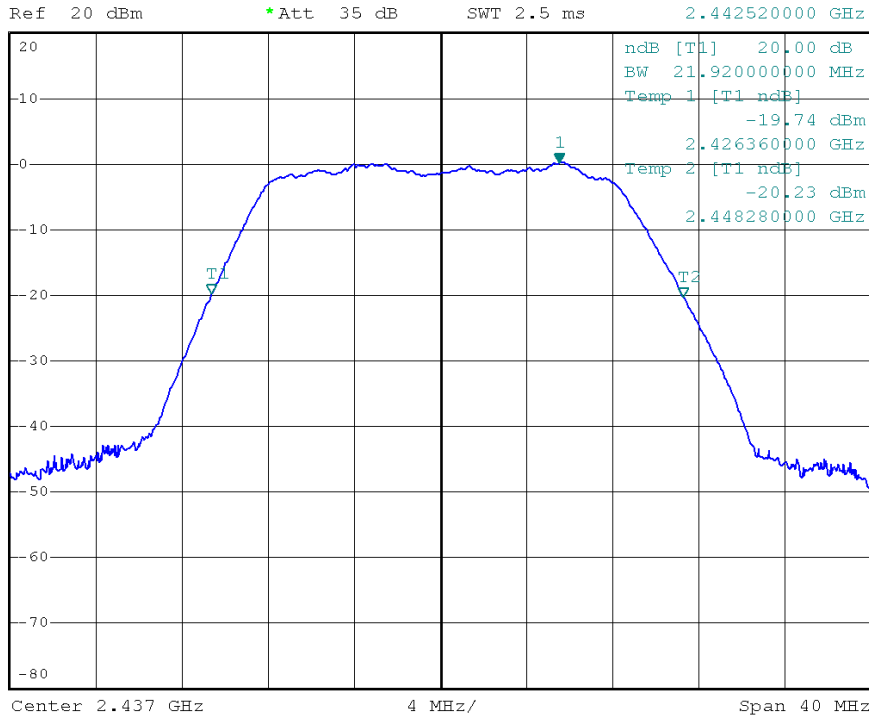

Test Mode: 802.11g---High



*RBW 300 kHz Marker 1 [T1] 1.33 dBm
*VBW 1 MHz
SWT 2.5 ms 2.464960000 GHz

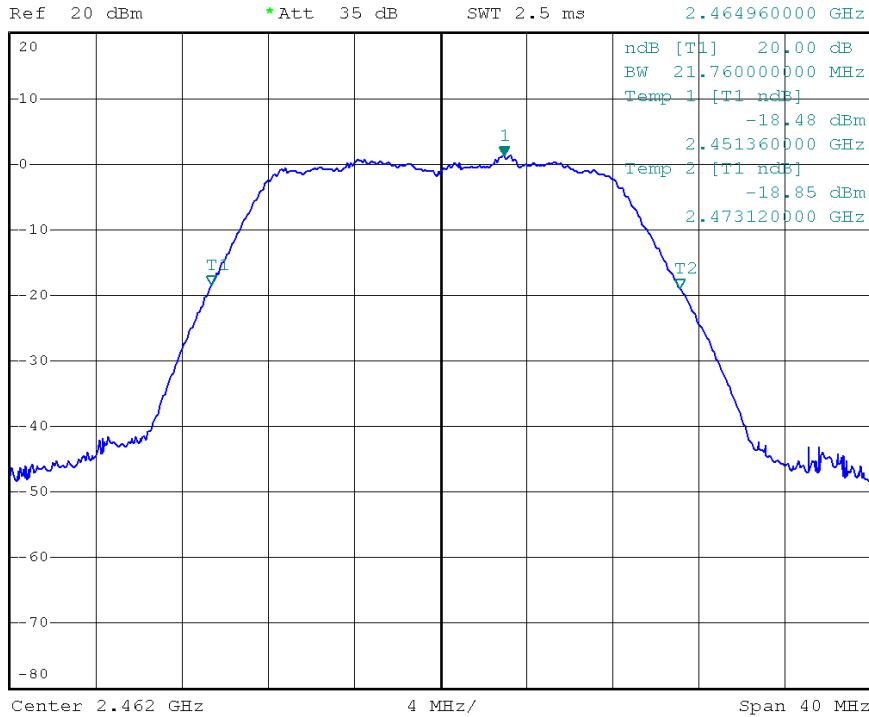

Test Mode: 802.11n (HT20)---Low



*RBW 300 kHz Marker 1 [T1]
*VBW 1 MHz -2.83 dBm
SWT 2.5 ms 2.413840000 GHz

Ref 20 dBm *Att 35 dB

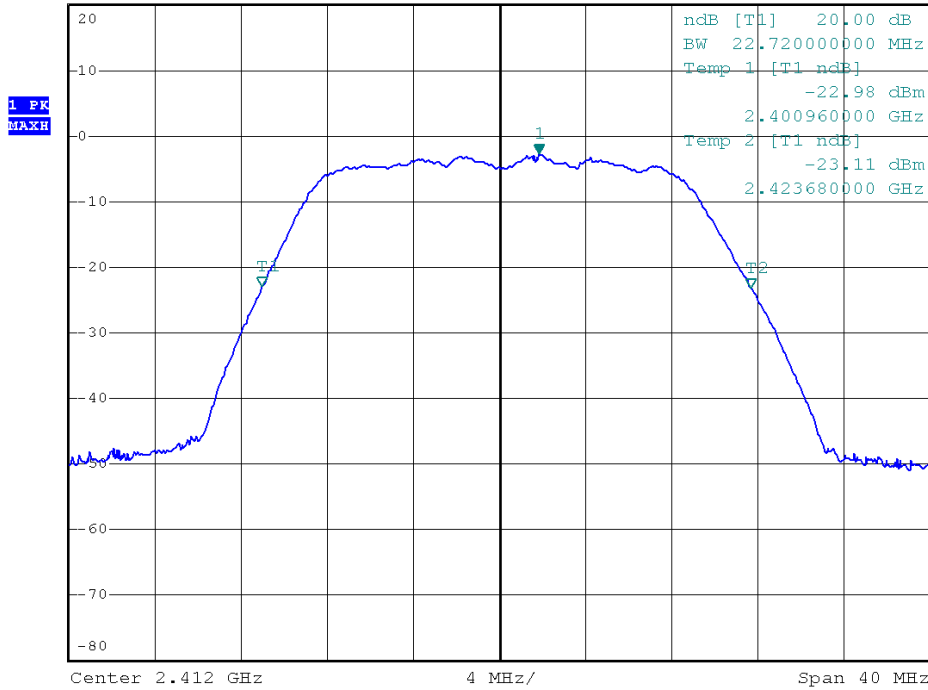

Test Mode: 802.11n (HT20)---Mid



*RBW 300 kHz Marker 1 [T1]
*VBW 1 MHz -4.58 dBm
SWT 2.5 ms 2.438680000 GHz

Ref 20 dBm *Att 35 dB

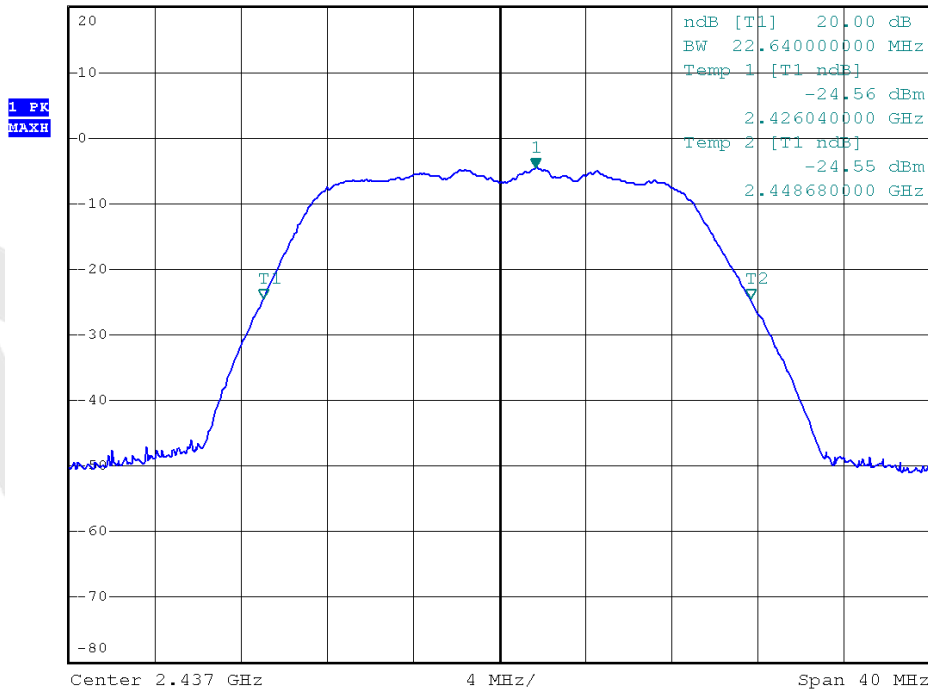

Test Mode: 802.11n (HT20)---High



*RBW 300 kHz Marker 1 [T1]
*VBW 1 MHz -5.70 dBm
SWT 2.5 ms 2.455120000 GHz

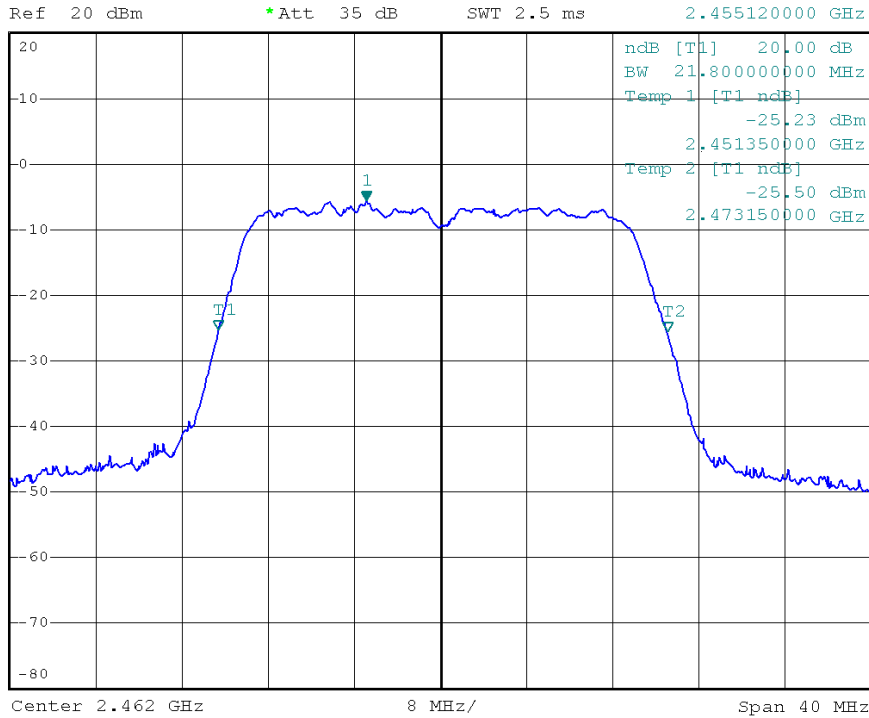

Test Mode: 802.11n (HT40)---Low



*RBW 300 kHz Marker 1 [T1]
*VBW 1 MHz -5.36 dBm
SWT 2.5 ms 2.411600000 GHz

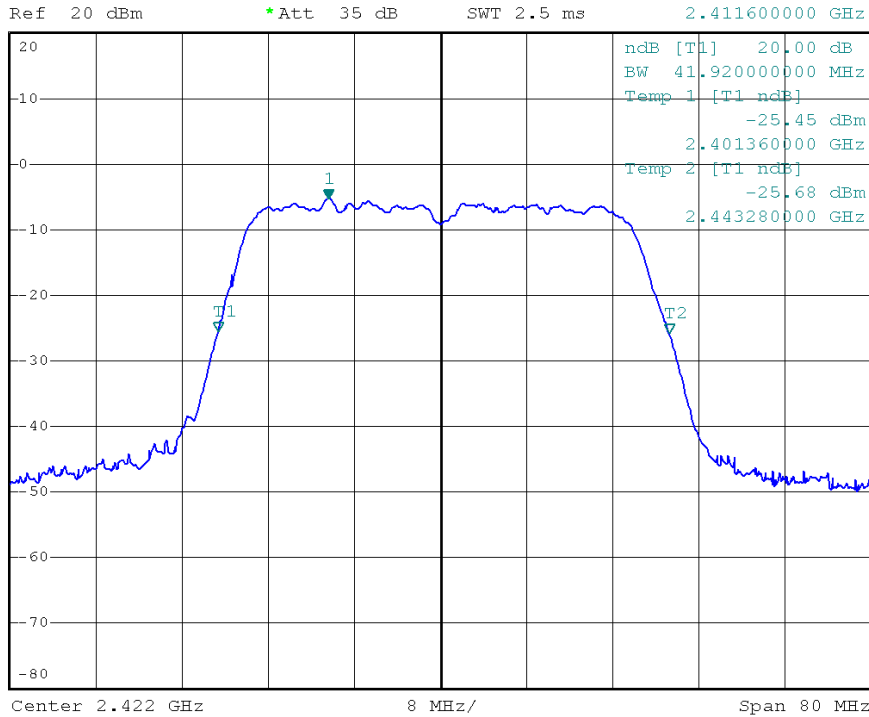

Test Mode: 802.11n (HT40)---Mid



*RBW 300 kHz Marker 1 [T1]
*VBW 1 MHz -4.74 dBm
SWT 2.5 ms 2.429960000 GHz

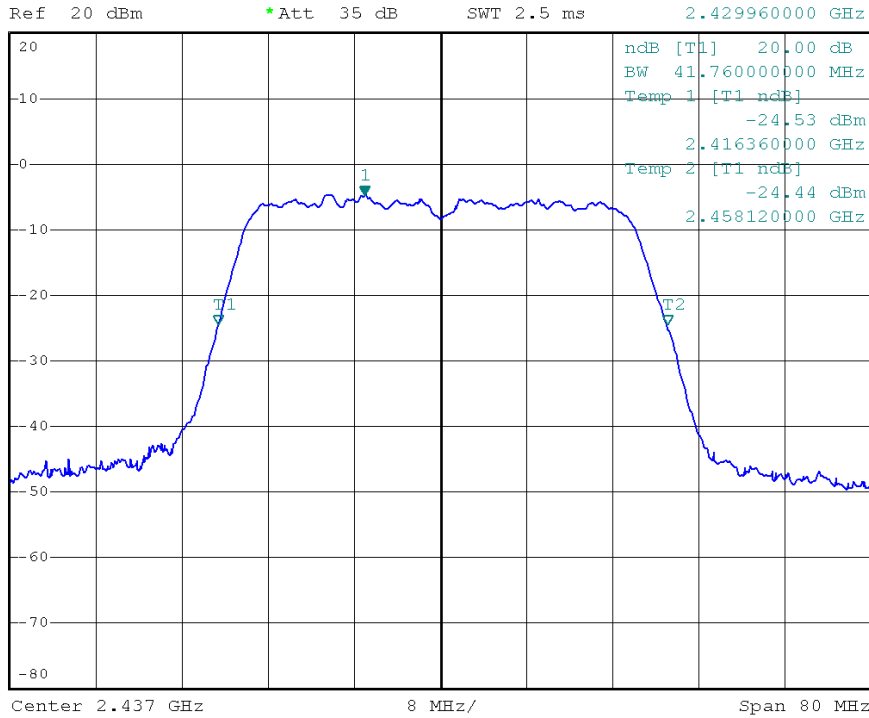

Test Mode: 802.11n (HT40)---High



*RBW 300 kHz Marker 1 [T1]
*VBW 1 MHz -4.32 dBm
SWT 2.5 ms 2.444960000 GHz

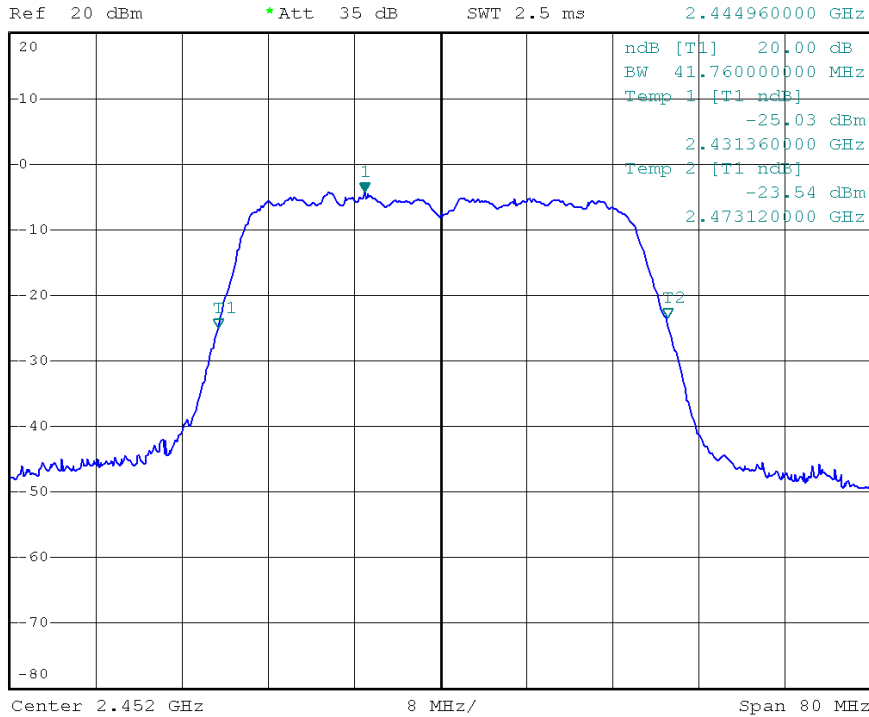

4.3. Maximum Output Power Test

a. Limit

The maximum output power of the intentional radiator shall not exceed the following:

1. For systems using digital modulation in the bands of 902-928 MHz, 2400-2483.5 MHz, and 5725-5850 MHz: 1 watt (30dBm).
2. Except as shown in paragraphs (b)(3) (i), (ii) and (iii) of this section, if transmitting antenna of directional gain greater than 6 dBi are used the peak output power from the intentional radiator shall be reduced below the stated values in paragraphs (b)(1) or (b)(2) of this section, as appropriate, by the amount in dB that the directional gain of the antenna exceeds 6 dBi.

b. Configuration of Measurement

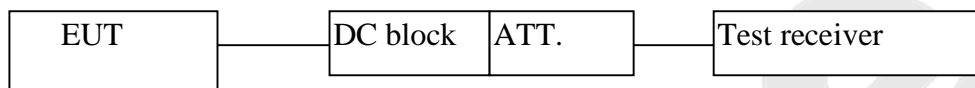

c. Data Rates

IEEE802.11b: Channel 1(2412MHz), Channel 6(2437MHz) and Channel 11(2462MHz) with 1 Mbps data rate (worst case) are chosen for the final testing.

IEEE802.11g: Channel 1(2412MHz), Channel 6(2437MHz) and Channel 11(2462MHz) with 6 Mbps data rate (the worst case) are chosen for the final testing.

IEEE802.11n (HT20: Channel 1(2412MHz), Channel 6(2437MHz) and Channel 11(2462MHz) with 6.5Mbps data rate (the worst case) are chosen for the final testing.

IEEE802.11n (HT40: Channel 3(2422MHz), Channel 6(2437MHz) and Channel 9(2452MHz) with 13.5Mbps data rate (the worst case) are chosen for the final testing.

d. Test Procedure

This test was according the kDB 558074 9.2.2:

1. Set span to at least 1.5 times the OBW.
2. Set the RBW =1~5% of the OBW, not to exceed 1MHz.
3. Set VBW $\geq 3 \times$ RBW.
4. Detector = Average.
5. Sweep time = auto couple.
6. Trace mode = max hold.
7. Allow trace to fully stabilize.

e. Test Equipment

Same as the equipment listed in 4.2.

f. Test Results

Pass.

g. Test Data

Test mode: IEEE 802.11b

Channel	Frequency (MHz)	Maximum transmit power (dBm)	Limit		Result
			(dBm)	(watts)	
Low	2412	12.27	30	1	Pass
Mid	2437	10.95			Pass
High	2462	9.68			Pass

Test mode: IEEE 802.11g

Channel	Frequency (MHz)	Maximum transmit power (dBm)	Limit		Result
			(dBm)	(watts)	
Low	2412	9.40	30	1	Pass
Mid	2437	8.44			Pass
High	2462	8.14			Pass

Test mode: IEEE 802.11n (HT20)

Channel	Frequency (MHz)	Maximum transmit power (dBm)	Limit		Result
			(dBm)	(watts)	
Low	2412	9.78	30	1	Pass
Mid	2437	8.85			Pass
High	2462	8.41			Pass

Test mode: IEEE 802.11n (HT40)

Channel	Frequency (MHz)	Maximum transmit power (dBm)	Limit		Result
			(dBm)	(watts)	
Low	2422	7.50	30	1	Pass
Mid	2437	7.72			Pass
High	2452	8.12			Pass

Test Mode: 802.11b---Low

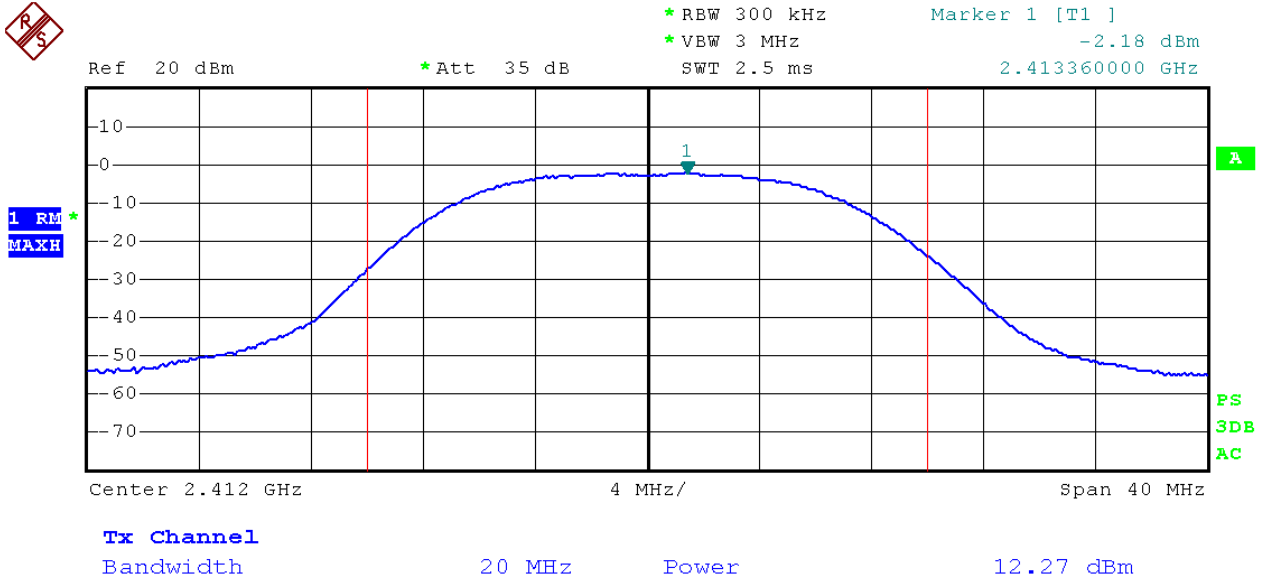

Test Mode: 802.11b---Mid

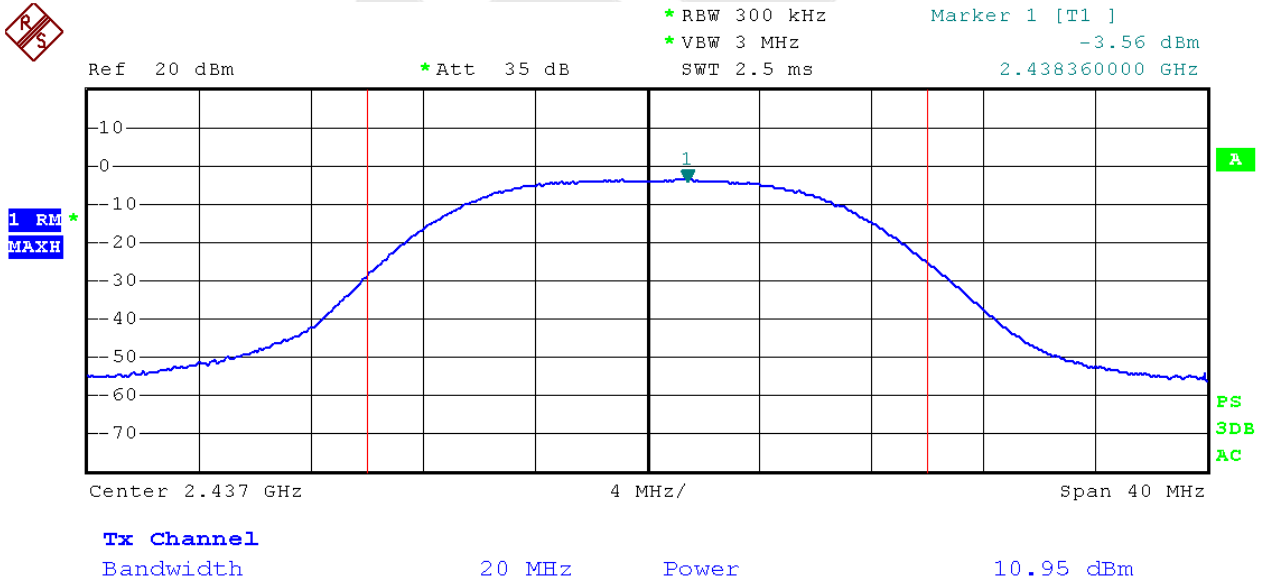

Test Mode: 802.11b---High



1 RM*
MAXH

Ref 20 dBm *Att 35 dB *RBW 300 kHz *VBW 3 MHz SWT 2.5 ms Marker 1 [T1] -4.76 dBm 2.463520000 GHz

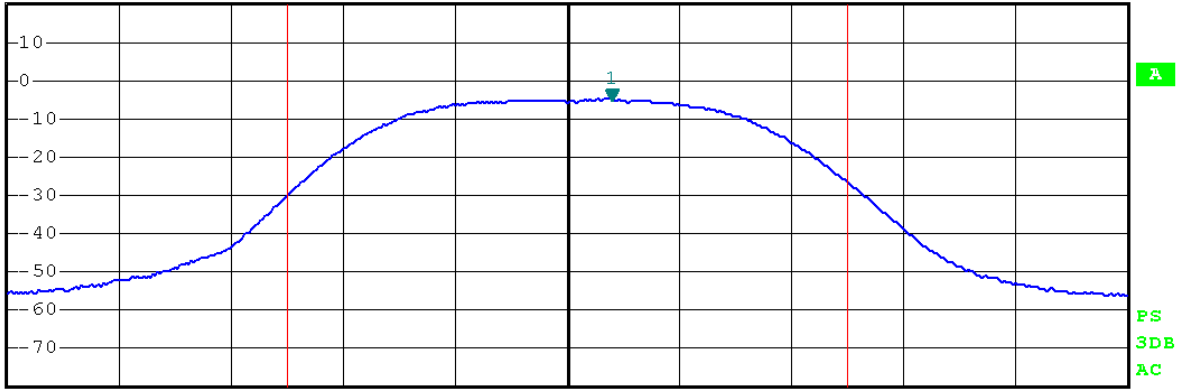

Tx Channel
Bandwidth 20 MHz Power 9.68 dBm

Test Mode: 802.11g---Low



1 RM*
MAXH

Ref 20 dBm *Att 35 dB *RBW 300 kHz *VBW 3 MHz SWT 2.5 ms Marker 1 [T1] -6.49 dBm 2.413200000 GHz

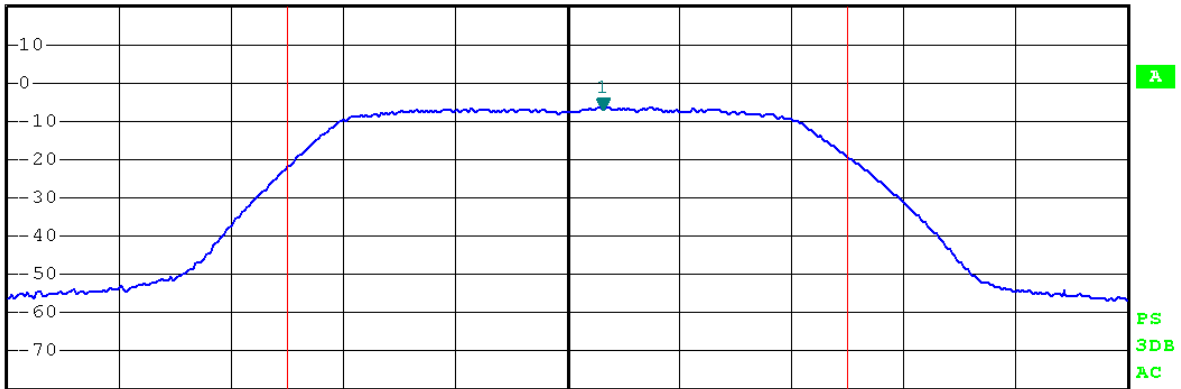

Tx Channel
Bandwidth 20 MHz Power 9.40 dBm

Test Mode: 802.11g---Mid



Ref 20 dBm *Att 35 dB *RBW 300 kHz *VBW 3 MHz SWT 2.5 ms Marker 1 [T1] -7.31 dBm 2.434120000 GHz

1 RM *
MAXH

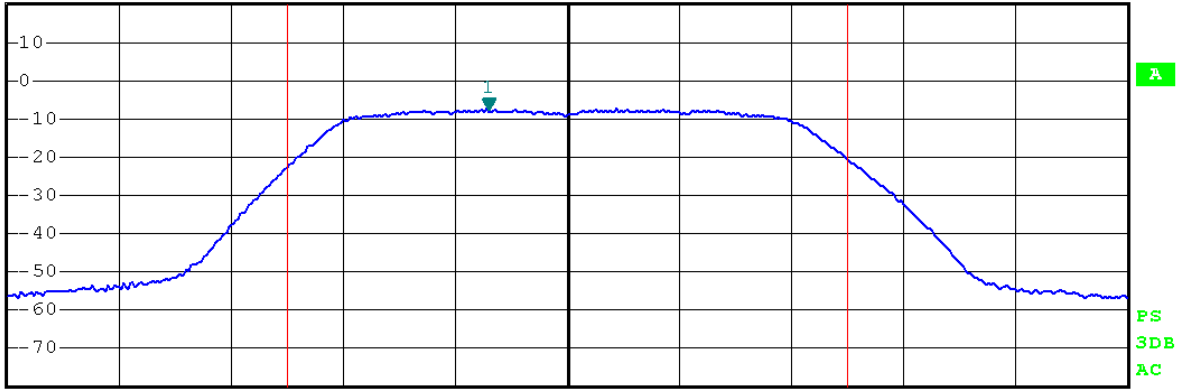

Center 2.437 GHz 4 MHz/ Span 40 MHz

Tx Channel

Bandwidth

20 MHz

Power

8.44 dBm

Test Mode: 802.11g---High



Ref 20 dBm *Att 35 dB *RBW 300 kHz *VBW 3 MHz SWT 2.5 ms Marker 1 [T1] -7.64 dBm 2.462960000 GHz

1 RM *
MAXH

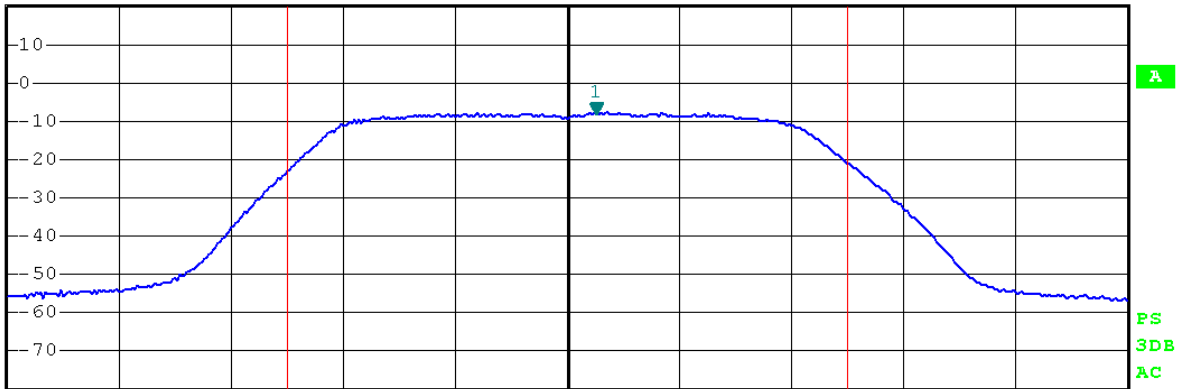

Center 2.462 GHz 4 MHz/ Span 40 MHz

Tx Channel

Bandwidth

20 MHz

Power

8.14 dBm

Test Mode: 802.11n(HT20)---Low



*RBW 300 kHz
*VBW 3 MHz
SWT 2.5 ms

Marker 1 [T1]
-6.46 dBm
2.410240000 GHz

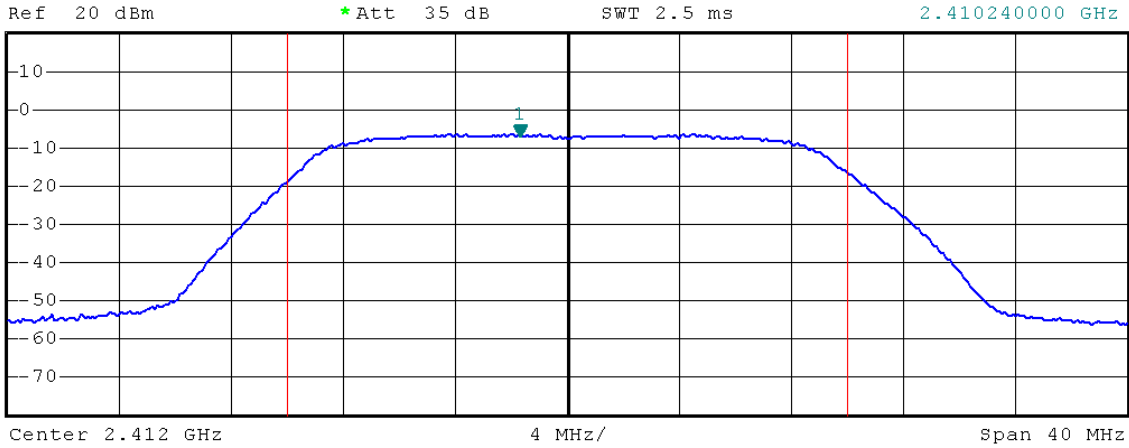

1 RM *
MAXH

A
PS
3DB
AC

Tx Channel
Bandwidth 20 MHz Power 9.78 dBm

Test Mode: 802.11n(HT20)---Mid



*RBW 300 kHz
*VBW 3 MHz
SWT 2.5 ms

Marker 1 [T1]
-7.37 dBm
2.435320000 GHz

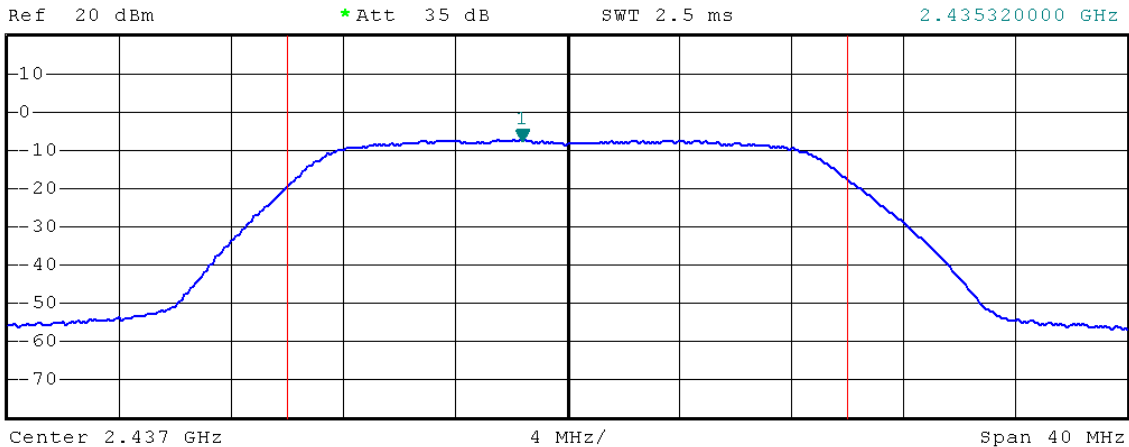

1 RM *
MAXH

A
PS
3DB
AC

Tx Channel
Bandwidth 20 MHz Power 8.85 dBm

Test Mode: 802.11n(HT20)---High



Ref 20 dBm *Att 35 dB *RBW 300 kHz *VBW 3 MHz SWT 2.5 ms Marker 1 [T1]
-7.73 dBm
2.460160000 GHz

1 RM *
MAXH

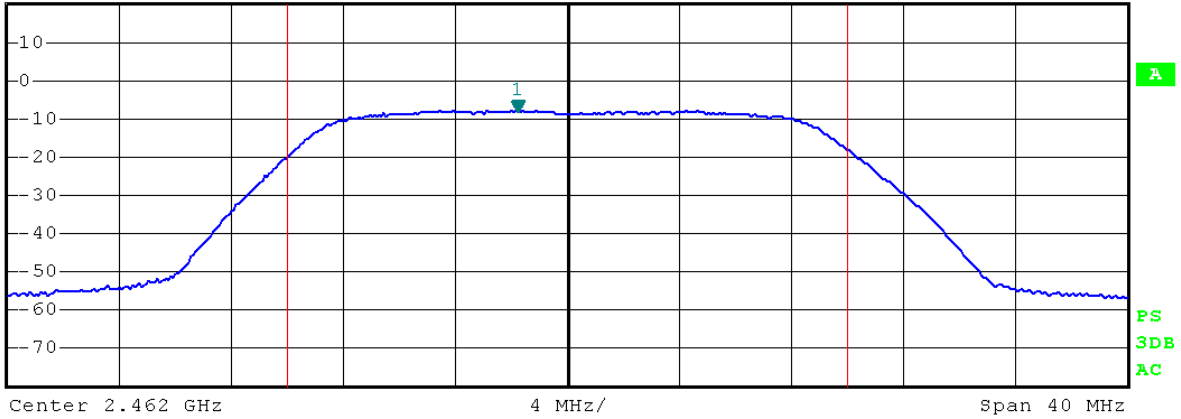

Tx Channel

Bandwidth

20 MHz

Power

8.41 dBm

Test Mode: 802.11n(HT40)---Low



Ref 20 dBm *Att 35 dB *RBW 1 MHz *VBW 10 MHz SWT 2.5 ms Marker 1 [T1]
-11.95 dBm
2.411600000 GHz

1 RM *
MAXH

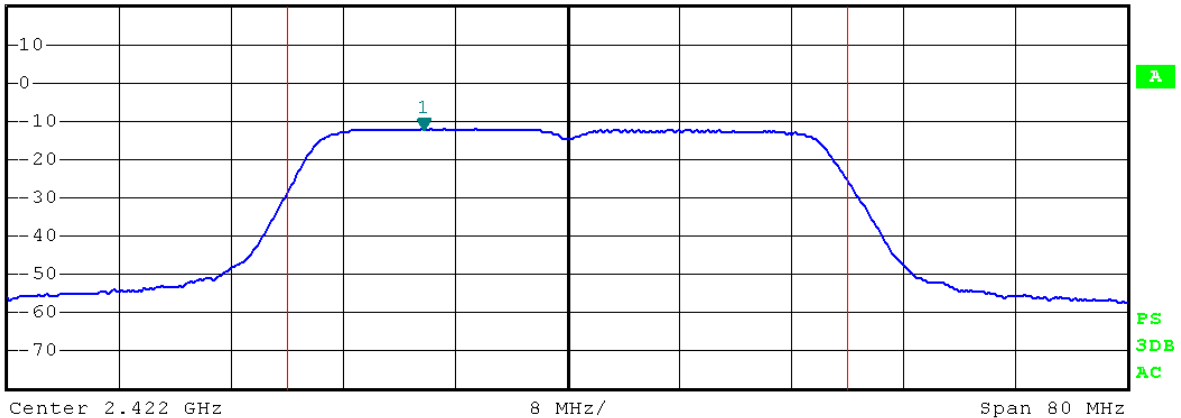

Tx Channel

Bandwidth

40 MHz

Power

7.50 dBm

Test Mode: 802.11n(HT40)---Mid



Ref 20 dBm *Att 35 dB *RBW 1 MHz *VBW 10 MHz SWT 2.5 ms Marker 1 [T1] -11.83 dBm 2.430440000 GHz

1 RM * MAXH

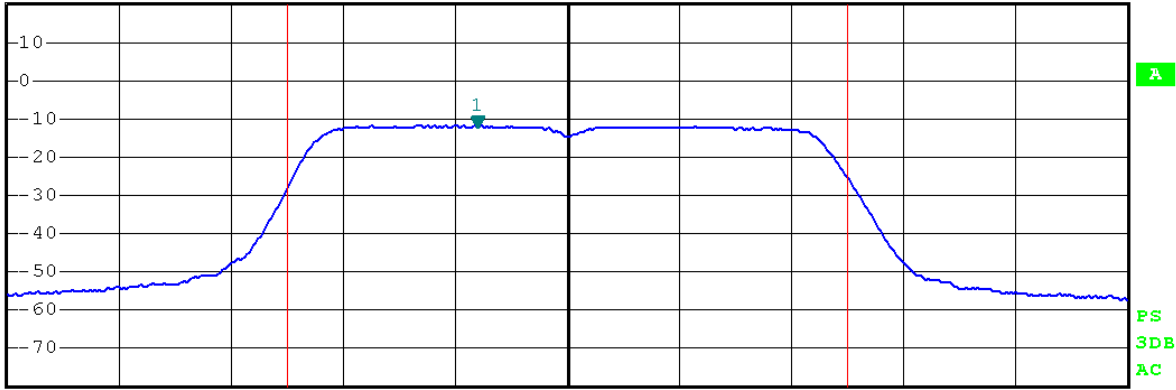

Center 2.437 GHz 8 MHz/ Span 80 MHz

Tx Channel

Bandwidth 40 MHz Power 7.72 dBm

Test Mode: 802.11n(HT40)---High



Ref 20 dBm *Att 35 dB *RBW 1 MHz *VBW 10 MHz SWT 2.5 ms Marker 1 [T1] -11.37 dBm 2.441280000 GHz

1 RM * MAXH

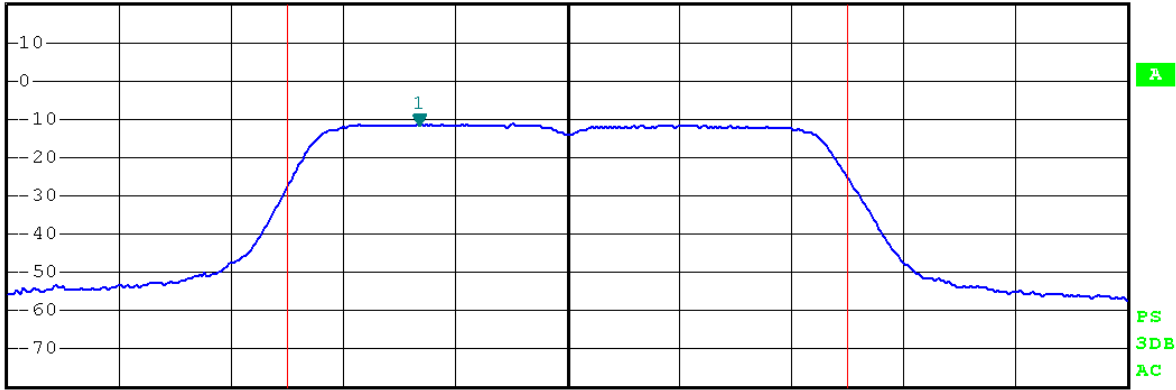

Center 2.452 GHz 8 MHz/ Span 80 MHz

Tx Channel

Bandwidth 40 MHz Power 8.12 dBm

4.4. Band Edges Measurement

a. Limit

According to §15.247(c), in any 100 kHz bandwidth outside the frequency bands in which the spread spectrum intentional radiator is operating, the radio frequency power that is produced by the intentional radiator shall be at least 20dB below that in the 100kHz bandwidth within the band that contains the highest level of the desired power, In addition, radiated emissions which fall in the restricted bands, as defined in §15.205(a), must also comply with the radiated emission limits specified in 15.209(a).

b. Test Procedure

1. Conducted Method:

- 1) Set RBW=100KHz, VBW=300KHz
- 2) Detector=peak
- 3) Sweep time= auto
- 4) Trace mode=max hold.

2. Radiated Method:

- 1) For below 1GHz: The EUT is placed on a turntable, which is 0.8m above the ground plane. The EUT is tested in 9*6*6 Chamber.
For above 1GHz: The EUT is placed on a turntable, which is 1.5m above the ground plane. The EUT is tested in 9*6*6 Chamber.
- 2) The turntable shall be rotated for 360 degrees to determine the position of maximum emission level.
- 3) EUT is set 3m away from the receiving antenna, which is varied from 1m to 4m to find out the highest emission.
- 4) Peak detector: RBW=1MHz, VBW=3MHz, SWT=AUTO
Average detector: RBW=1MHz, VBW=10Hz, SWT=AUTO
The EUT is tested in 9*6*6 Chamber.
- 5) Repeat the procedures until all the PEAK and AVERAGE versus POLARIZATION are measured.

30M to 1G emissions:

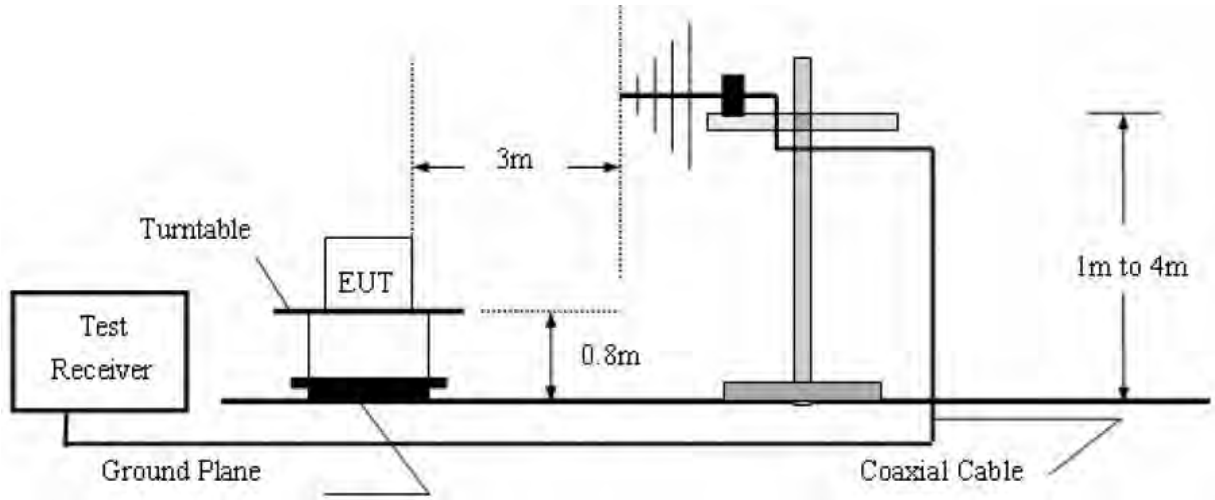

1G to 40G emissions:

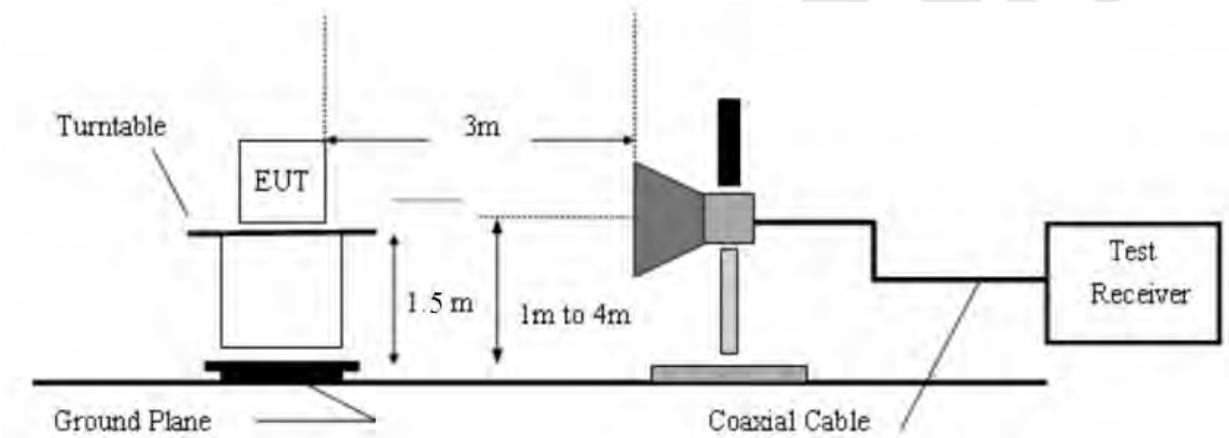

c. Test Equipment

Same as the equipment listed in 4.2.

d. Test Results

Pass.

e. Test Plots

See the following page.

Test Mode: 802.11b ---Low

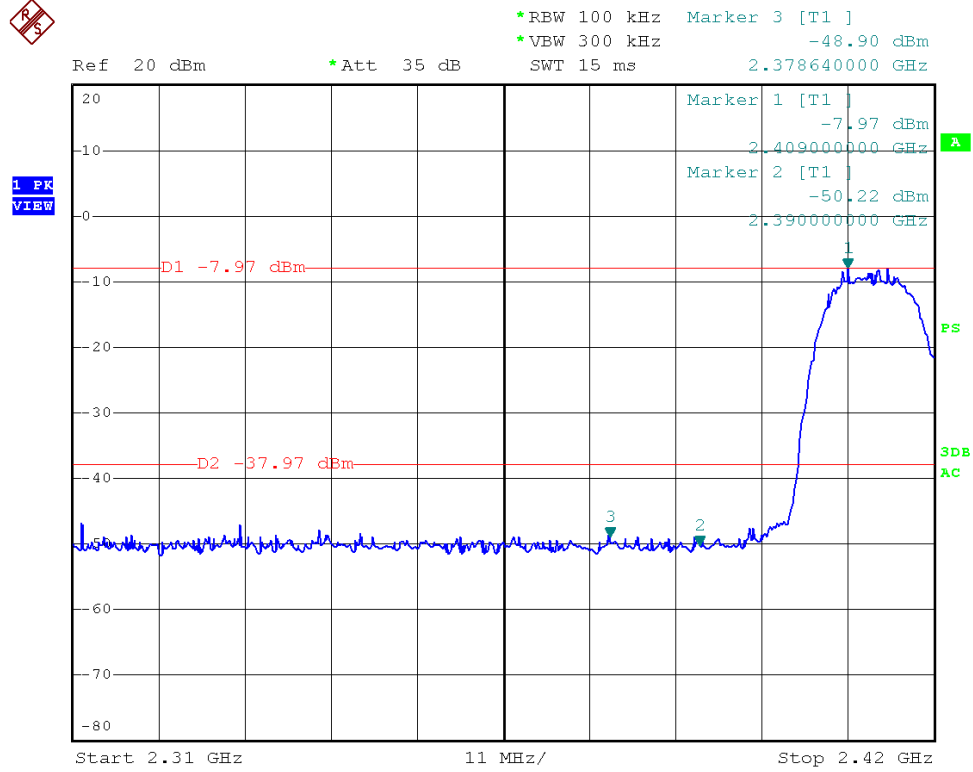

Test Mode: 802.11b ---High

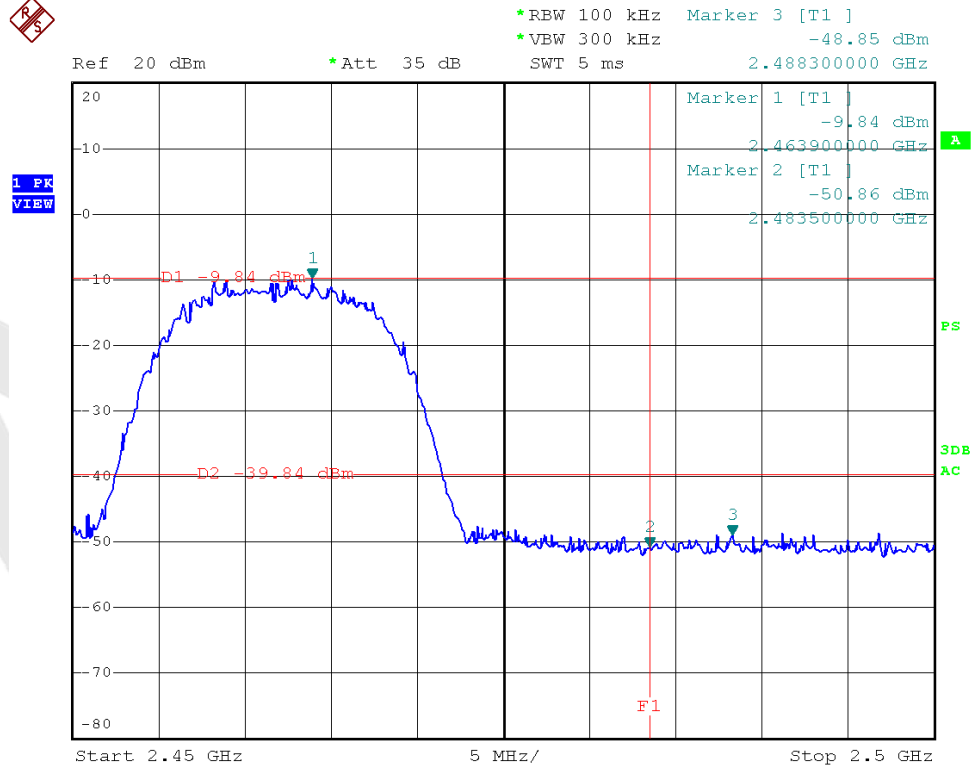

Test Mode: 802.11g ---Low

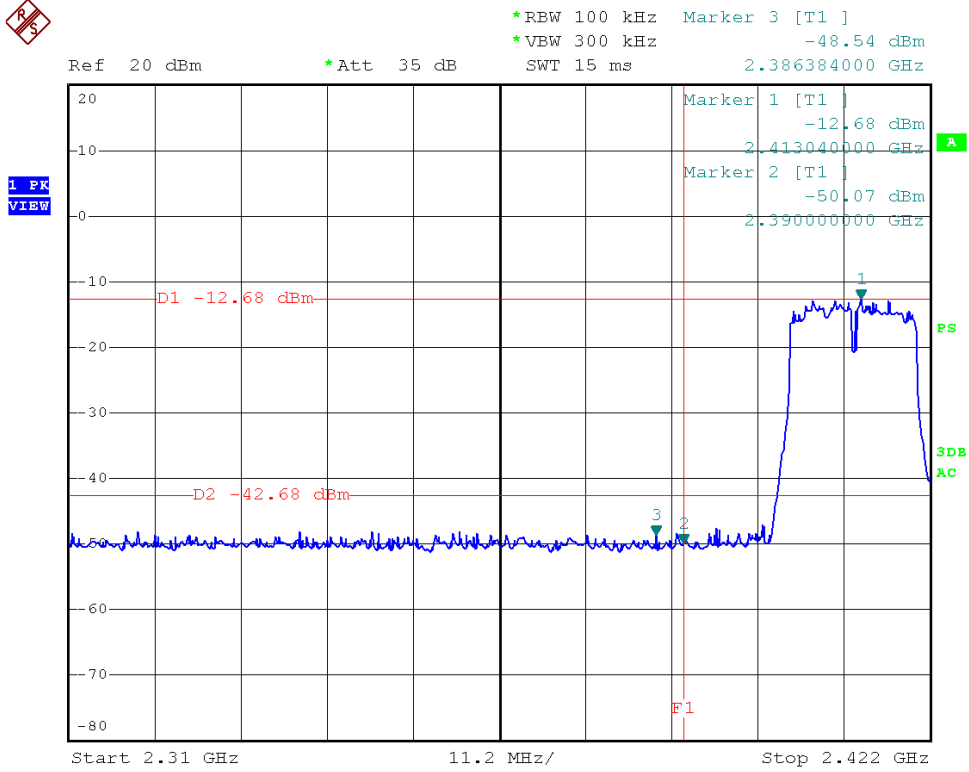

Test Mode: 802.11g ---High

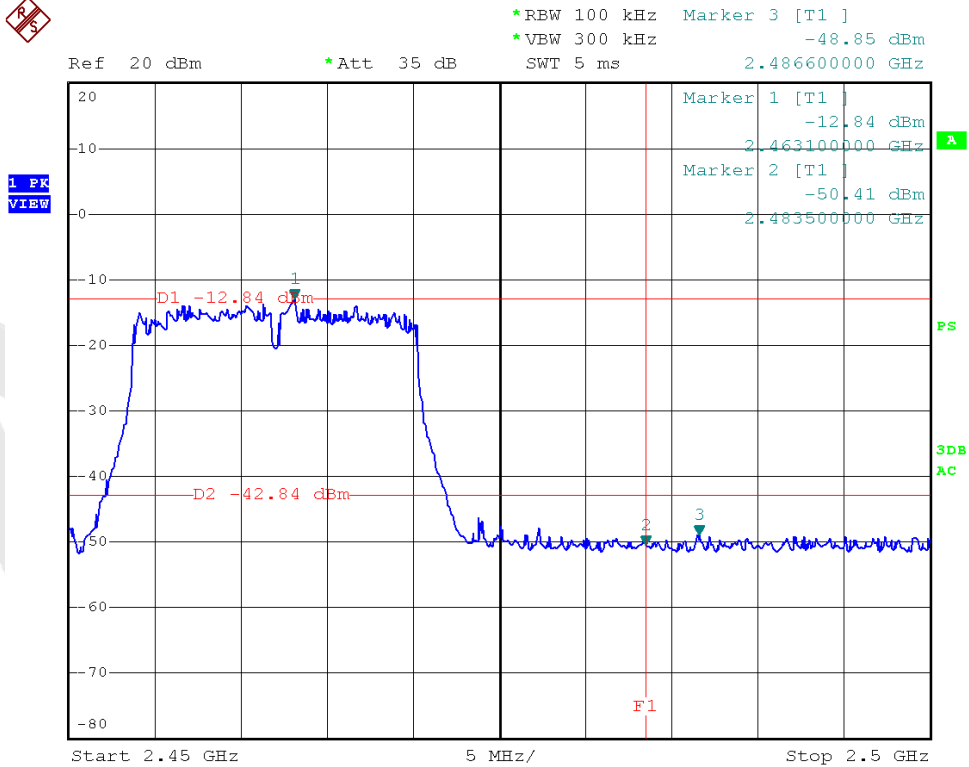

Test Mode: 802.11n (HT20) ---Low

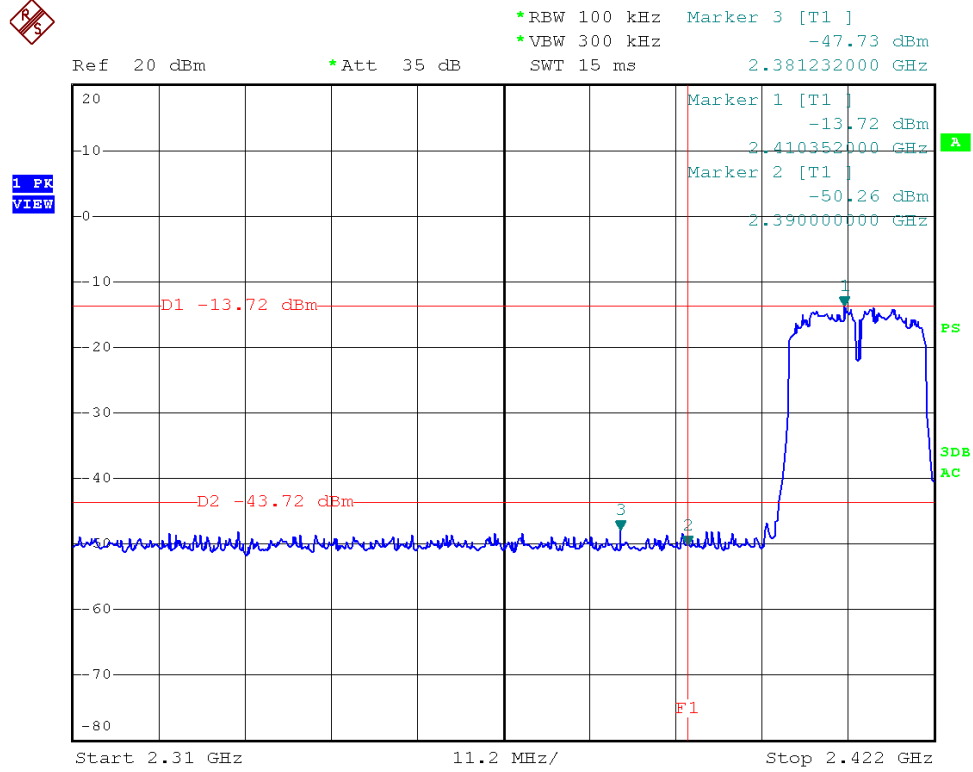

Test Mode: 802.11n (HT20)---High

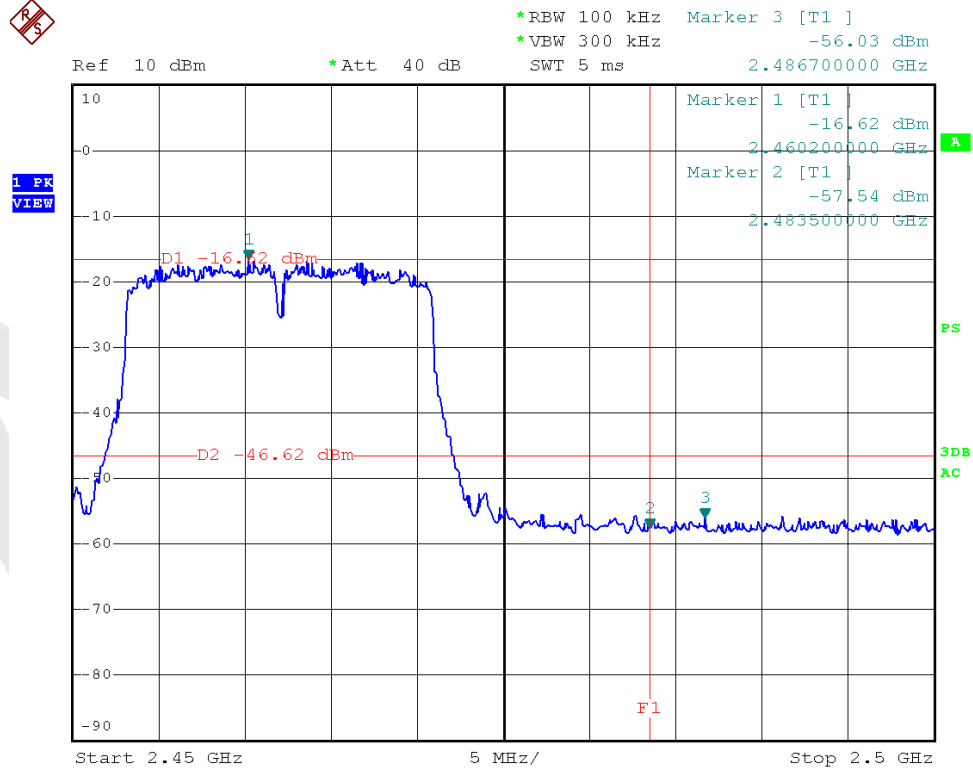

Test Mode: 802.11n (HT40) ---Low

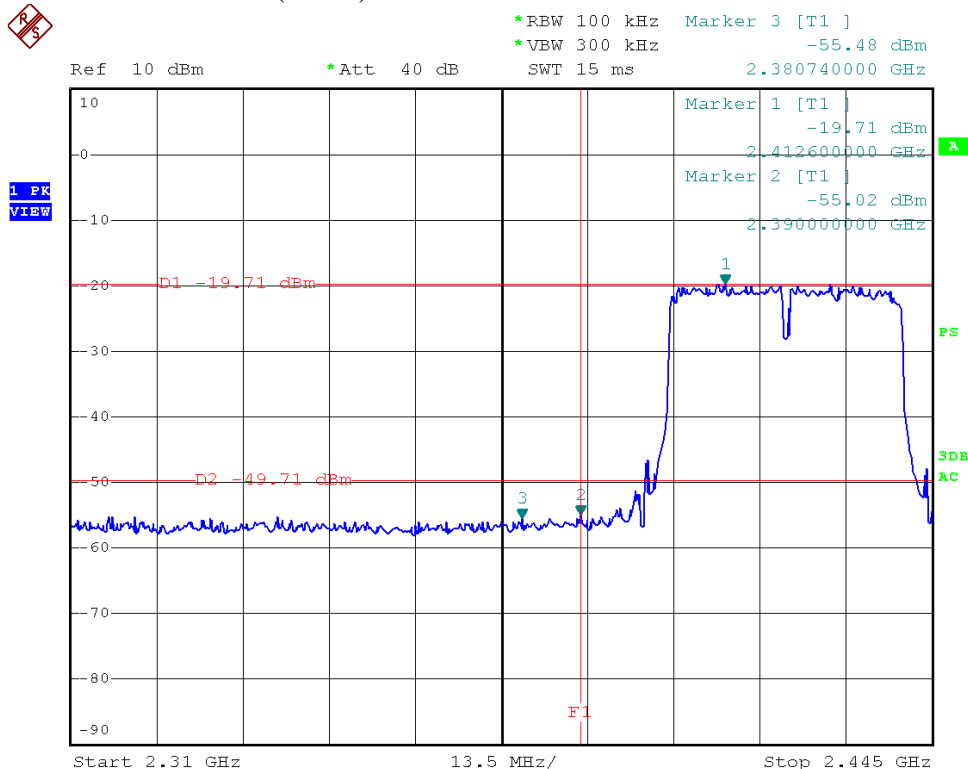

Test Mode: 802.11n (HT40) ---High

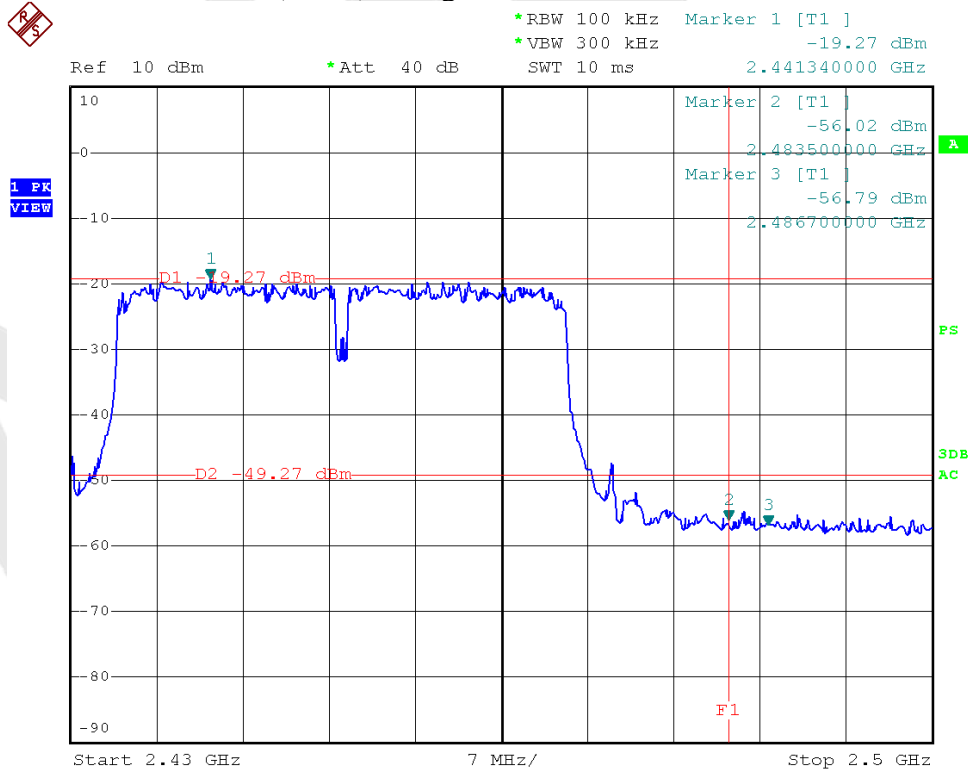

Test Mode: 802.11b
2412MHz
Horizontal-PEAK:

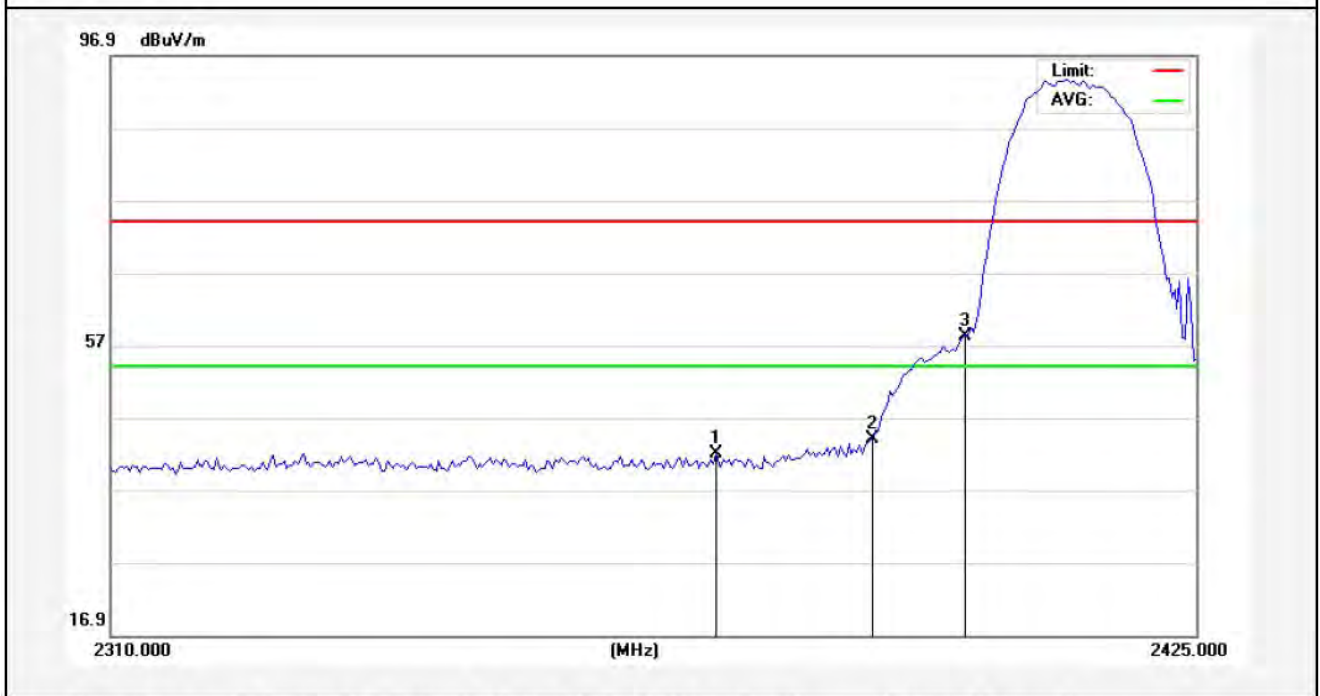

No.	Freq. (MHz)	Reading (dBuV/m)	Factor (dB/m)	Result (dBuV/m)	Limit (dBuV/)	Over Limit (dB)	Detector	Height (cm)	degree (deg)	Remark
1	2373.537	44.59	-2.55	42.04	74.00	-31.96	peak			
2	2390.000	46.57	-2.51	44.06	74.00	-29.94	peak			
3	2400.000	60.77	-2.49	58.28	74.00	-15.72	peak			

AMB

Horizontal-AV:

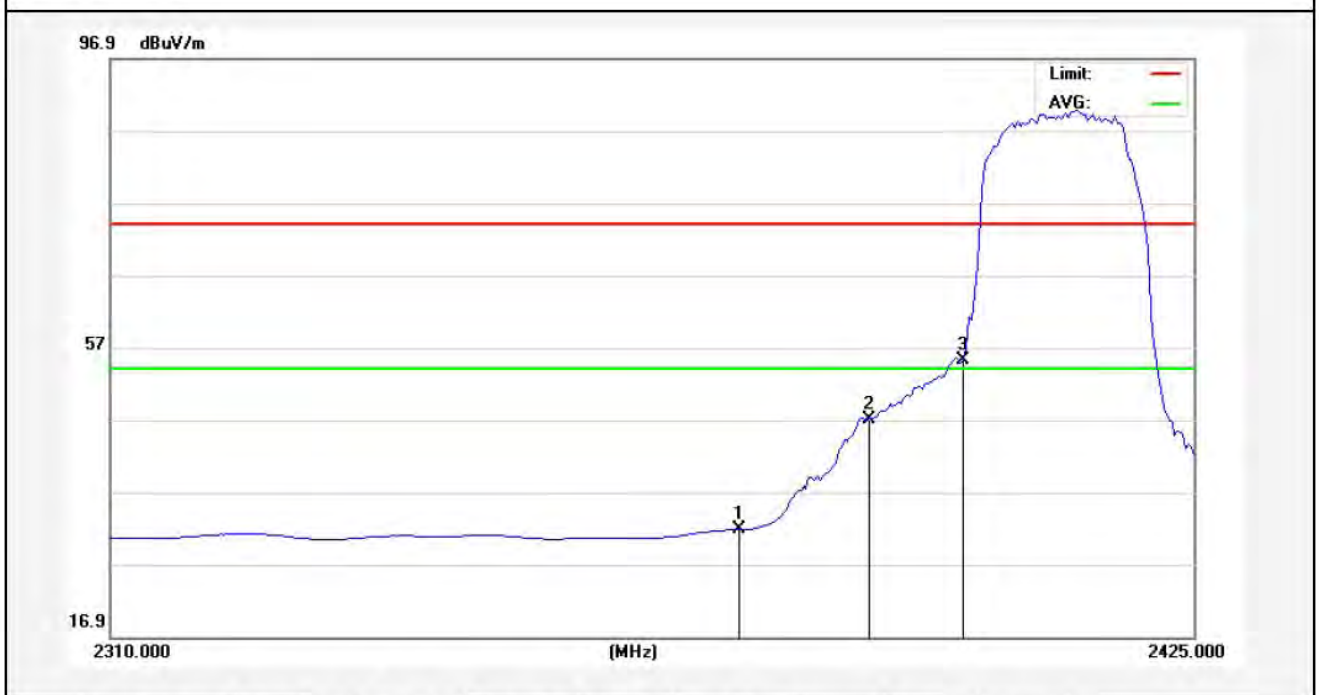

No.	Freq. (MHz)	Reading (dBuV/m)	Factor (dB/m)	Result (dBuV/m)	Limit (dBuV/)	Over Limit (dB)	Detector	Height (cm)	degree (deg)	Remark
1	2375.838	34.31	-2.55	31.76	54.00	-22.24	AVG			
2	2390.000	49.56	-2.51	47.05	54.00	-6.95	AVG			
3	2400.000	57.60	-2.49	55.11	54.00	1.11	AVG			

Anbotek

Test Mode: 802.11b
2412MHz
Vertical-PEAK:

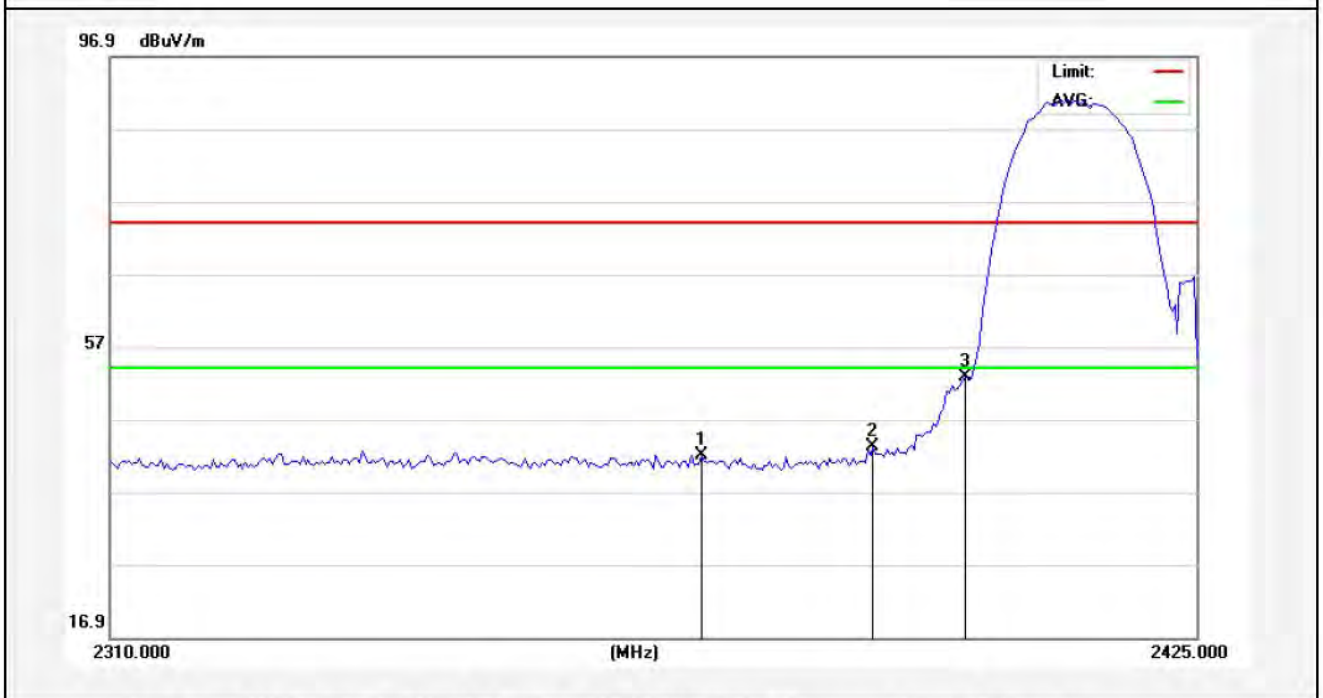

No.	Freq. (MHz)	Reading (dBuV/m)	Factor (dB/m)	Result (dBuV/m)	Limit (dBuV/)	Over Limit (dB)	Detector	Height (cm)	degree (deg)	Remark
1	2372.100	44.52	-2.55	41.97	74.00	-32.03	peak			
2	2390.000	45.62	-2.51	43.11	74.00	-30.89	peak			
3	2400.000	55.32	-2.49	52.83	74.00	-21.17	peak			

AMB

Vertical-AV:

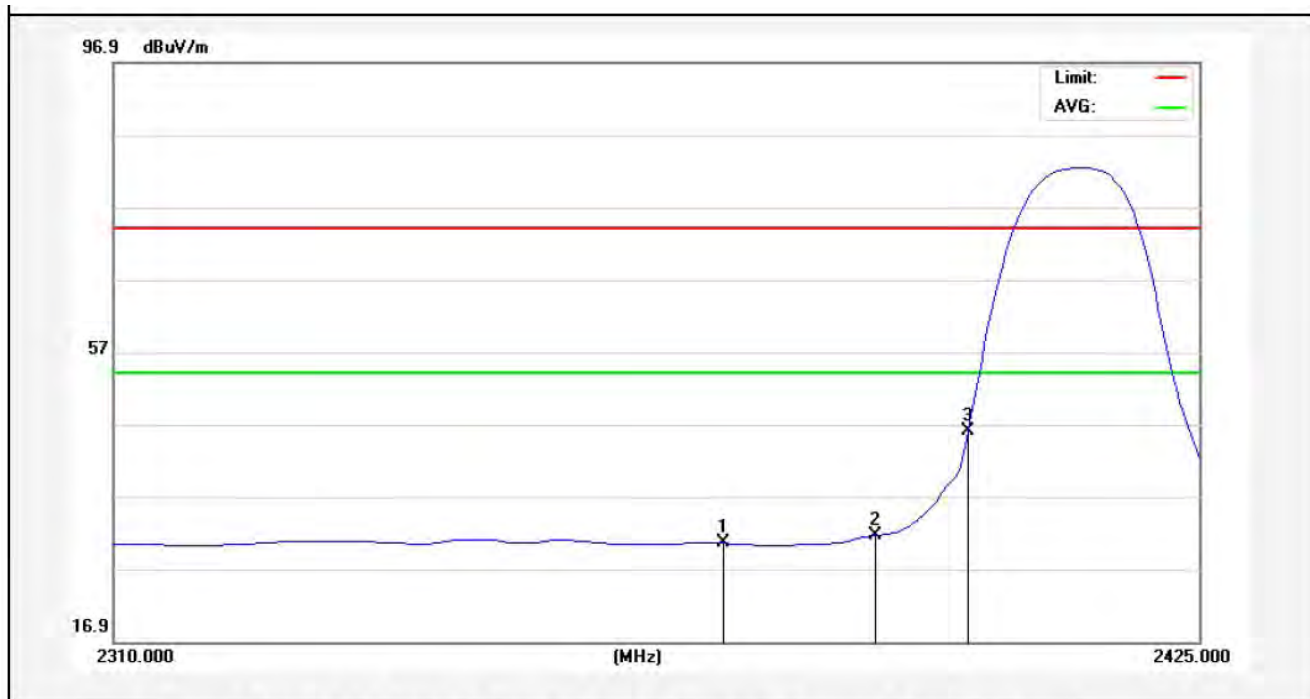

No.	Freq. (MHz)	Reading (dBuV/m)	Factor (dB/m)	Result (dBuV/m)	Limit (dBuV/)	Over Limit (dB)	Detector	Height (cm)	degree (deg)	Remark
1	2374.113	33.08	-2.55	30.53	54.00	-23.47	AVG			
2	2390.000	34.13	-2.51	31.62	54.00	-22.38	AVG			
3	2400.000	48.48	-2.49	45.99	54.00	-8.01	AVG			

Anbotek

Test Mode: 802.11b
2462MHz
Horizontal-PEAK:

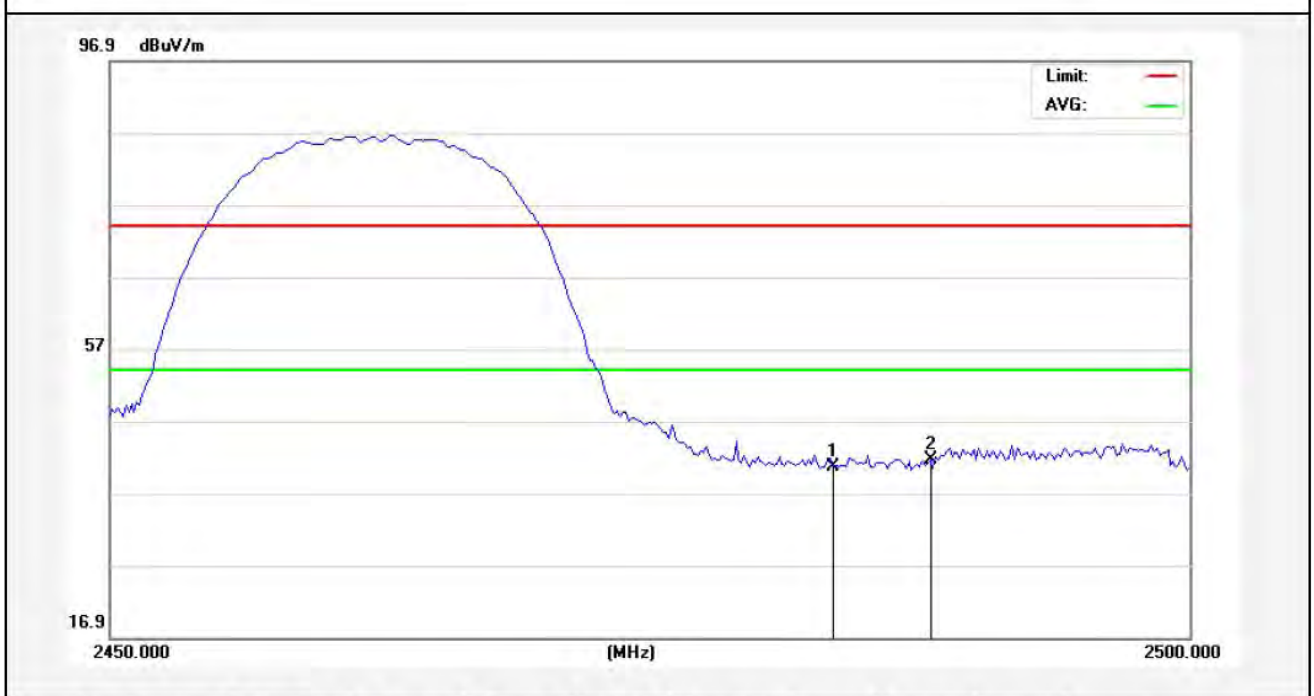

No.	Freq. (MHz)	Reading (dBuV/m)	Factor (dB/m)	Result (dBuV/m)	Limit (dBuV/)	Over Limit (dB)	Detector	Height (cm)	degree (deg)	Remark
1	2483.500	42.99	-2.31	40.68	74.00	-33.32	peak			
2	2488.000	43.94	-2.30	41.64	74.00	-32.36	peak			

Anbotek

Horizontal-AV:

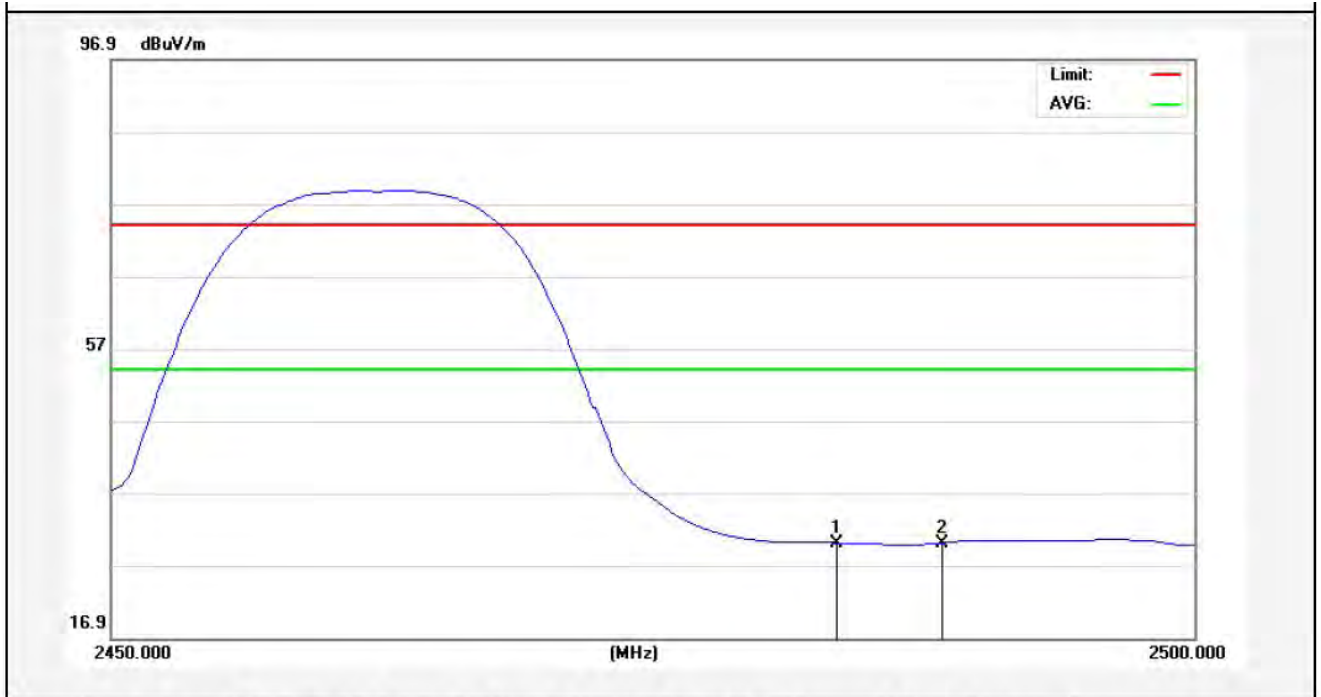

No.	Freq. (MHz)	Reading (dBuV/m)	Factor (dB/m)	Result (dBuV/m)	Limit (dBuV/)	Over Limit (dB)	Detector	Height (cm)	degree (deg)	Remark
1	2483.500	32.38	-2.31	30.07	54.00	-23.93	AVG			
2	2488.375	32.38	-2.30	30.08	54.00	-23.92	AVG			

Anbotek

Test Mode: 802.11b
2462MHz
Vertical-PEAK:

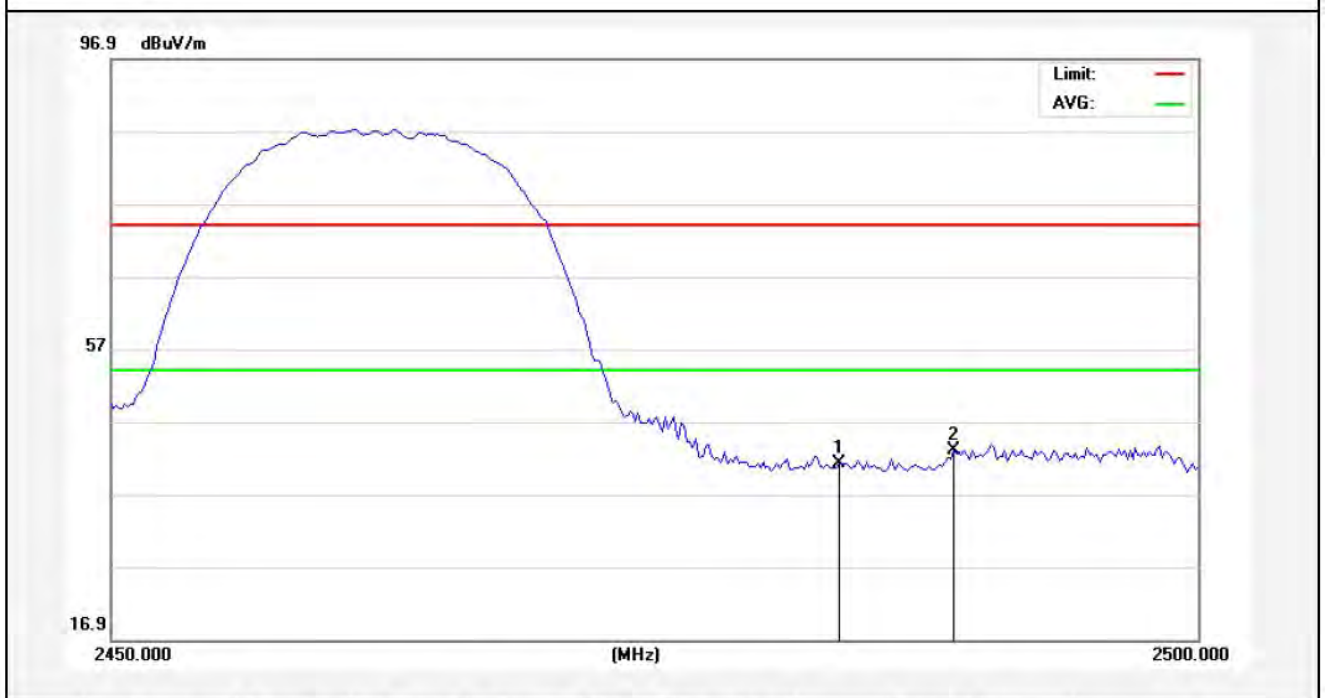

No.	Freq. (MHz)	Reading (dBuV/m)	Factor (dB/m)	Result (dBuV/m)	Limit (dBuV/)	Over Limit (dB)	Detector	Height (cm)	degree (deg)	Remark
1	2483.500	43.50	-2.31	41.19	74.00	-32.81	peak			
2	2488.750	45.33	-2.29	43.04	74.00	-30.96	peak			

Anbotek

Vertical-AV:

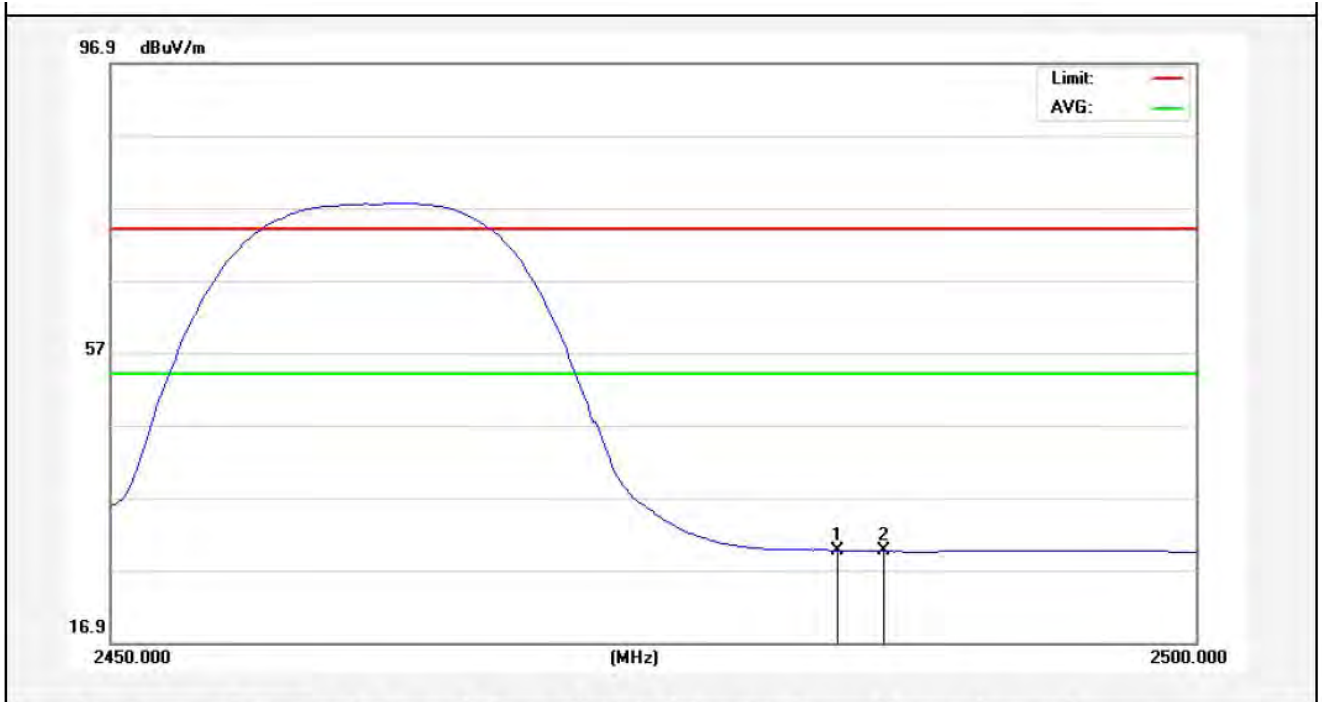

No.	Freq. (MHz)	Reading (dBuV/m)	Factor (dB/m)	Result (dBuV/m)	Limit (dBuV/)	Over Limit (dB)	Detector	Height (cm)	degree (deg)	Remark
1	2483.500	31.97	-2.31	29.66	54.00	-24.34	AVG			
2	2485.625	31.88	-2.30	29.58	54.00	-24.42	AVG			

Anbotek

Test Mode: 802.11g
2412MHz
Horizontal-PEAK:

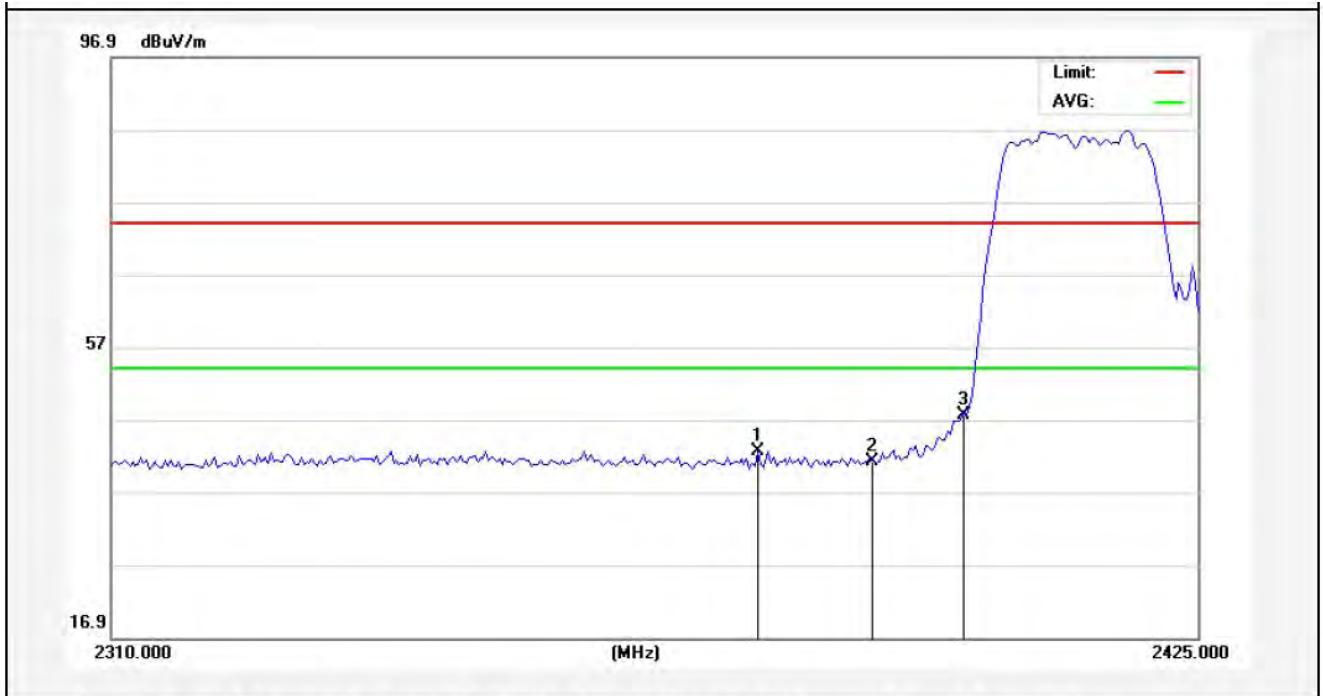

No.	Freq. (MHz)	Reading (dBuV/m)	Factor (dB/m)	Result (dBuV/m)	Limit (dBuV)	Over Limit (dB)	Detector	Height (cm)	degree (deg)	Remark
1	2377.850	45.20	-2.54	42.66	74.00	-31.34	peak			
2	2390.000	43.76	-2.51	41.25	74.00	-32.75	peak			
3	2400.000	50.11	-2.49	47.62	74.00	-26.38	peak			

AMB

Horizontal-AV:

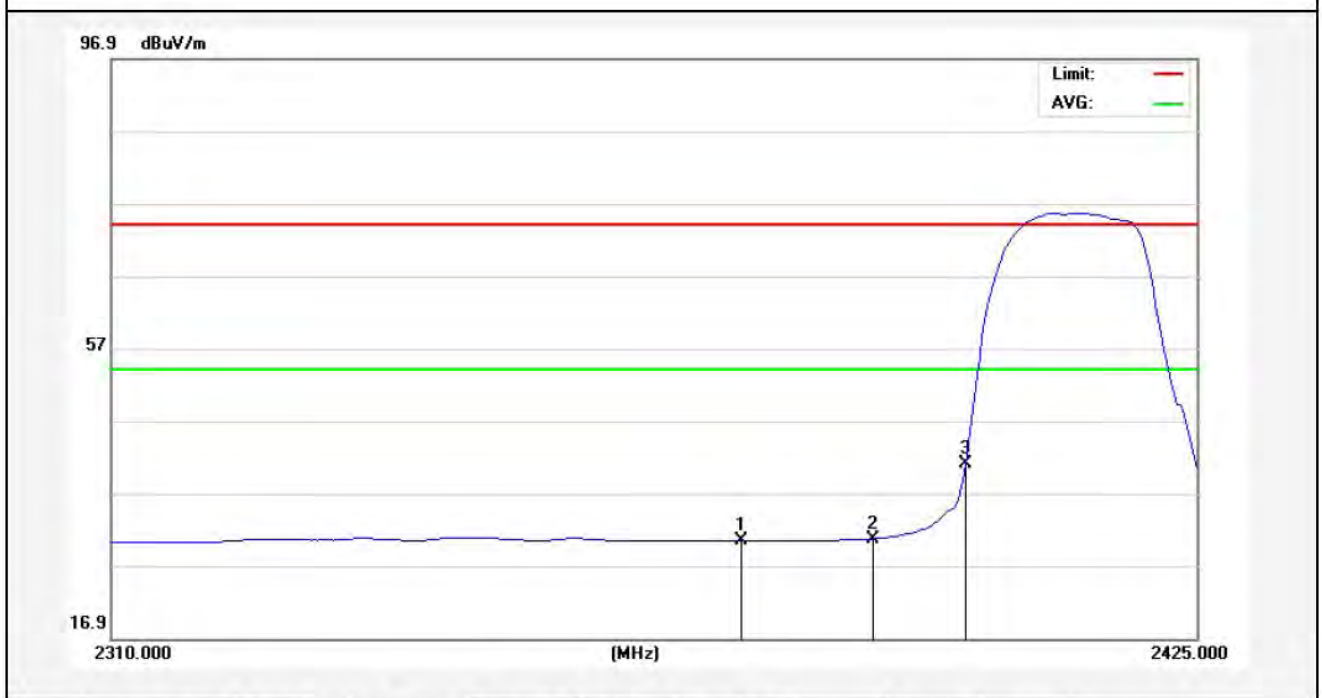

No.	Freq. (MHz)	Reading (dBuV/m)	Factor (dB/m)	Result (dBuV/m)	Limit (dBuV/)	Over Limit (dB)	Detector	Height (cm)	degree (deg)	Remark
1	2376.125	32.94	-2.54	30.40	54.00	-23.60	AVG			
2	2390.000	33.19	-2.51	30.68	54.00	-23.32	AVG			
3	2400.000	43.41	-2.49	40.92	54.00	-13.08	AVG			

Anbotek

Test Mode: 802.11g
2412MHz
Vertical-PEAK:

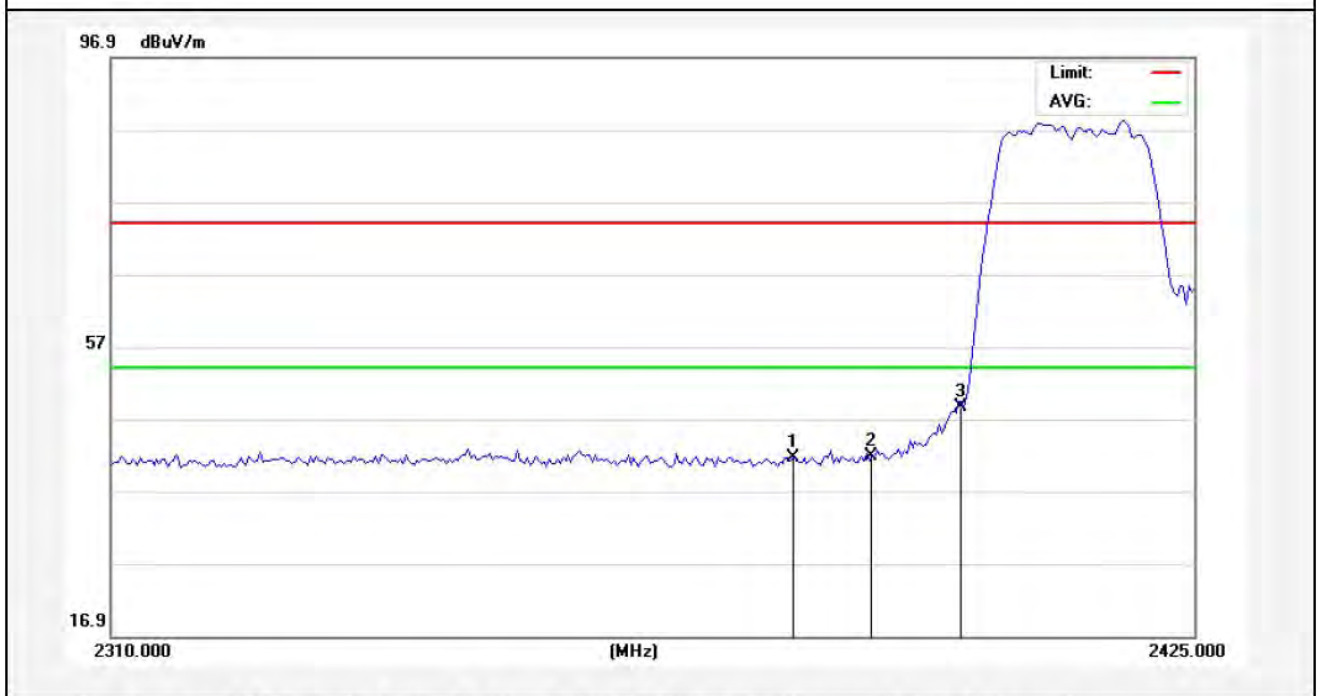

No.	Freq. (MHz)	Reading (dBuV/m)	Factor (dB/m)	Result (dBuV/m)	Limit (dBuV/)	Over Limit (dB)	Detector	Height (cm)	degree (deg)	Remark
1	2381.875	44.20	-2.53	41.67	74.00	-32.33	peak			
2	2390.000	44.37	-2.51	41.86	74.00	-32.14	peak			
3	2400.000	51.05	-2.49	48.56	74.00	-25.44	peak			

AMB

Vertical-AV:

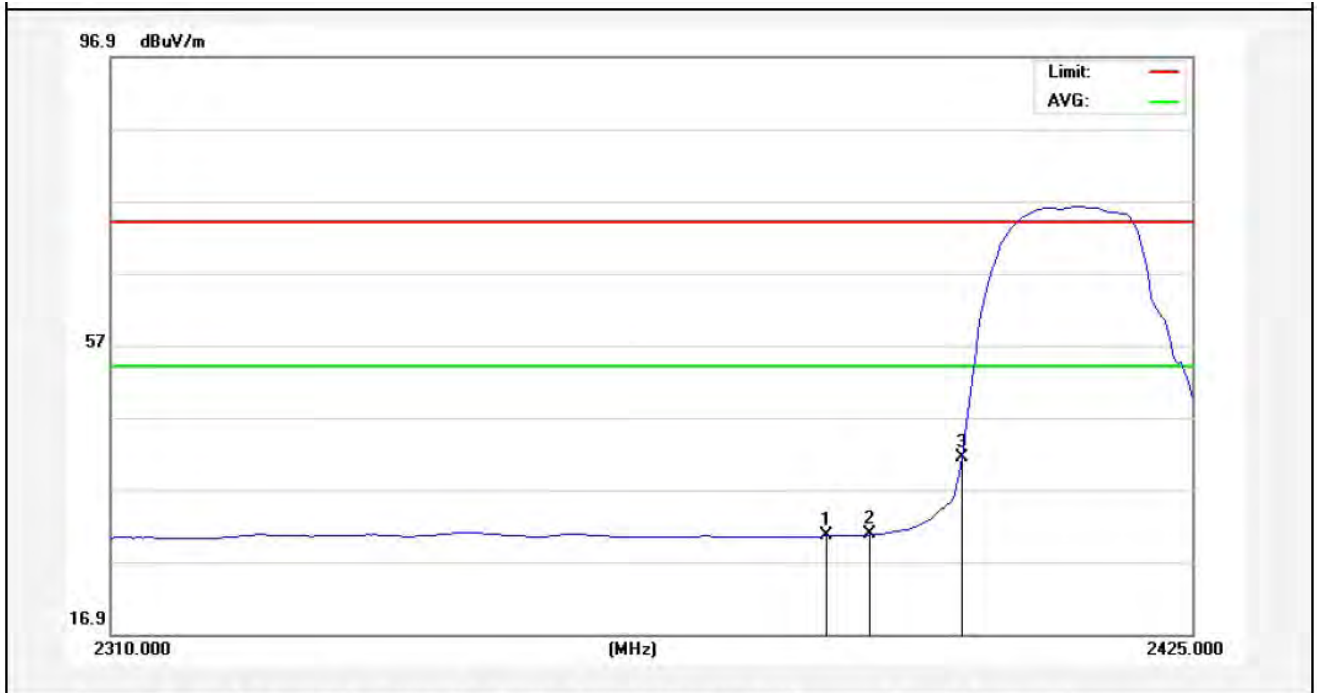

No.	Freq. (MHz)	Reading (dBuV/m)	Factor (dB/m)	Result (dBuV/m)	Limit (dBuV/)	Over Limit (dB)	Detector	Height (cm)	degree (deg)	Remark
1	2385.325	33.05	-2.52	30.53	54.00	-23.47	AVG			
2	2390.000	33.23	-2.51	30.72	54.00	-23.28	AVG			
3	2400.000	43.86	-2.49	41.37	54.00	-12.63	AVG			

Anbotek

Test Mode: 802.11g
2462MHz
Horizontal-PEAK:

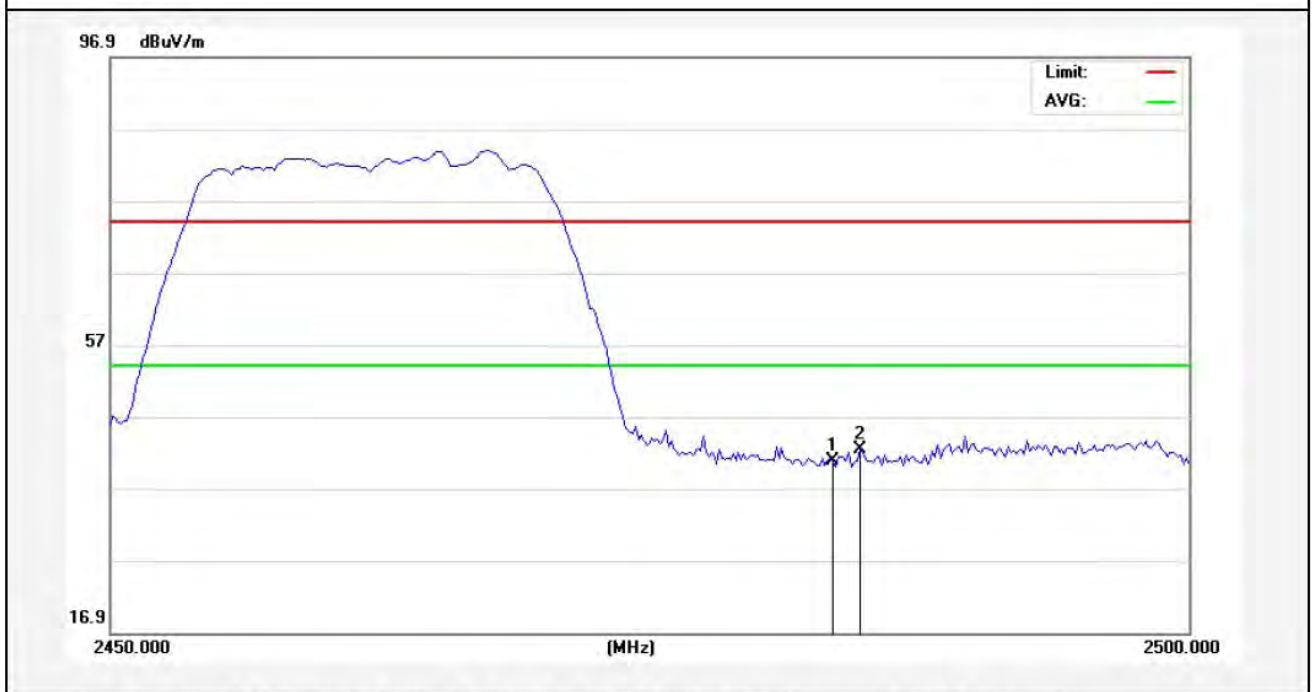

No.	Freq. (MHz)	Reading (dBuV/m)	Factor (dB/m)	Result (dBuV/m)	Limit (dBuV/)	Over Limit (dB)	Detector	Height (cm)	degree (deg)	Remark
1	2483.500	43.07	-2.31	40.76	74.00	-33.24	peak			
2	2484.750	44.70	-2.30	42.40	74.00	-31.60	peak			

Anbotek

Horizontal-AV:

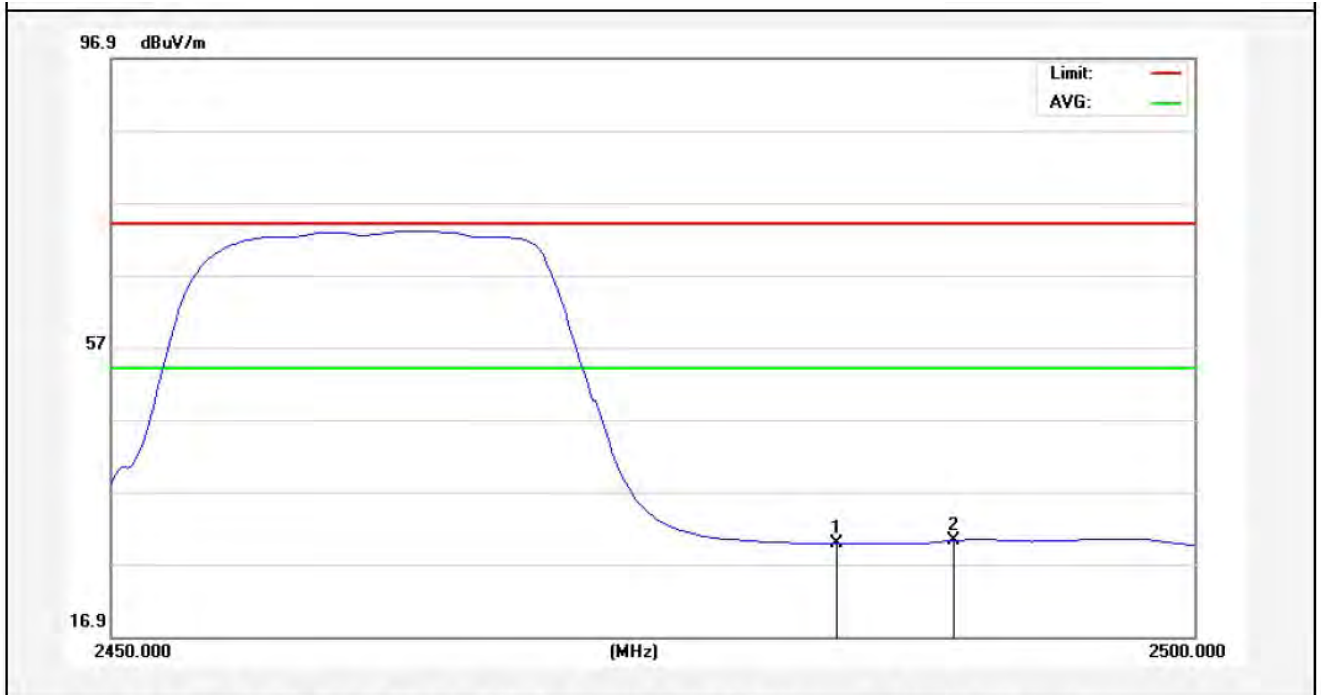

No.	Freq. (MHz)	Reading (dBuV/m)	Factor (dB/m)	Result (dBuV/m)	Limit (dBuV/)	Over Limit (dB)	Detector	Height (cm)	degree (deg)	Remark
1	2483.500	32.12	-2.31	29.81	54.00	-24.19	AVG			
2	2488.875	32.53	-2.29	30.24	54.00	-23.76	AVG			

Anbotek

Test Mode: 802.11g
2462MHz
Vertical-PEAK:

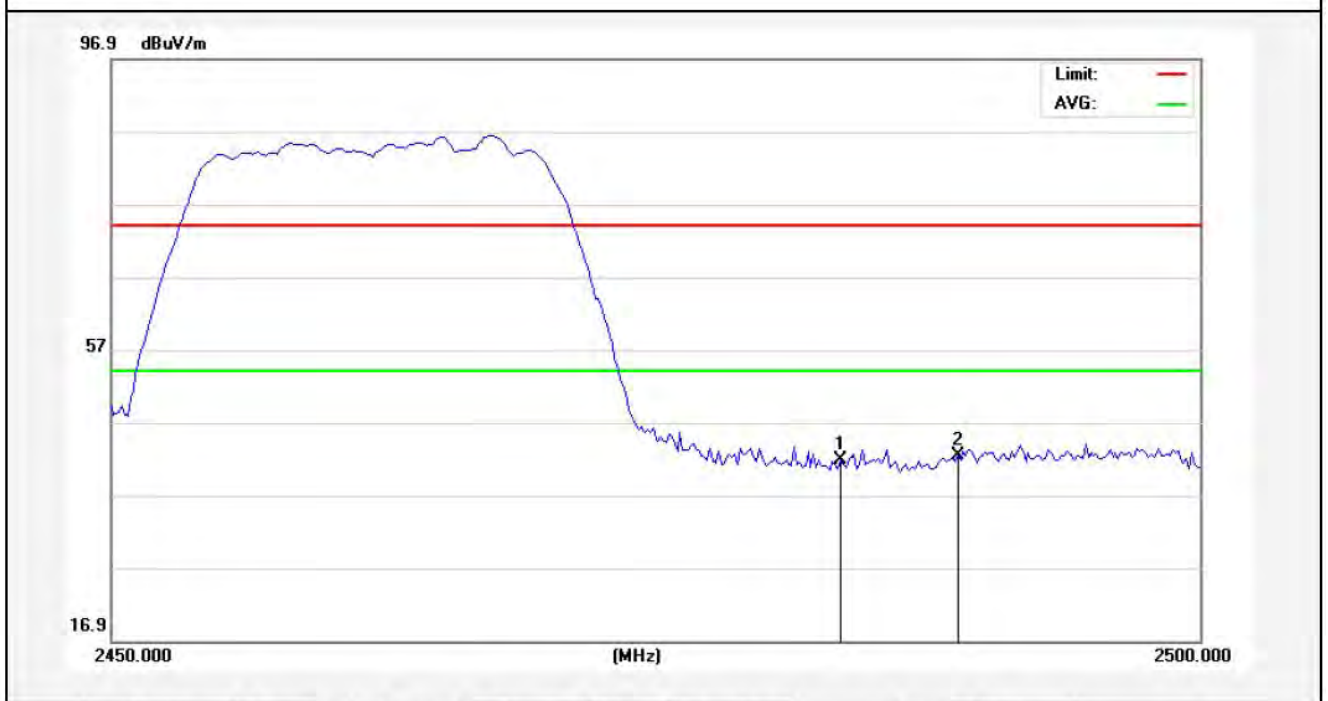

No.	Freq. (MHz)	Reading (dBuV/m)	Factor (dB/m)	Result (dBuV/m)	Limit (dBuV/)	Over Limit (dB)	Detector	Height (cm)	degree (deg)	Remark
1	2483.500	44.11	-2.31	41.80	74.00	-32.20	peak			
2	2488.875	44.76	-2.29	42.47	74.00	-31.53	peak			

Anbotek

Vertical-AV:

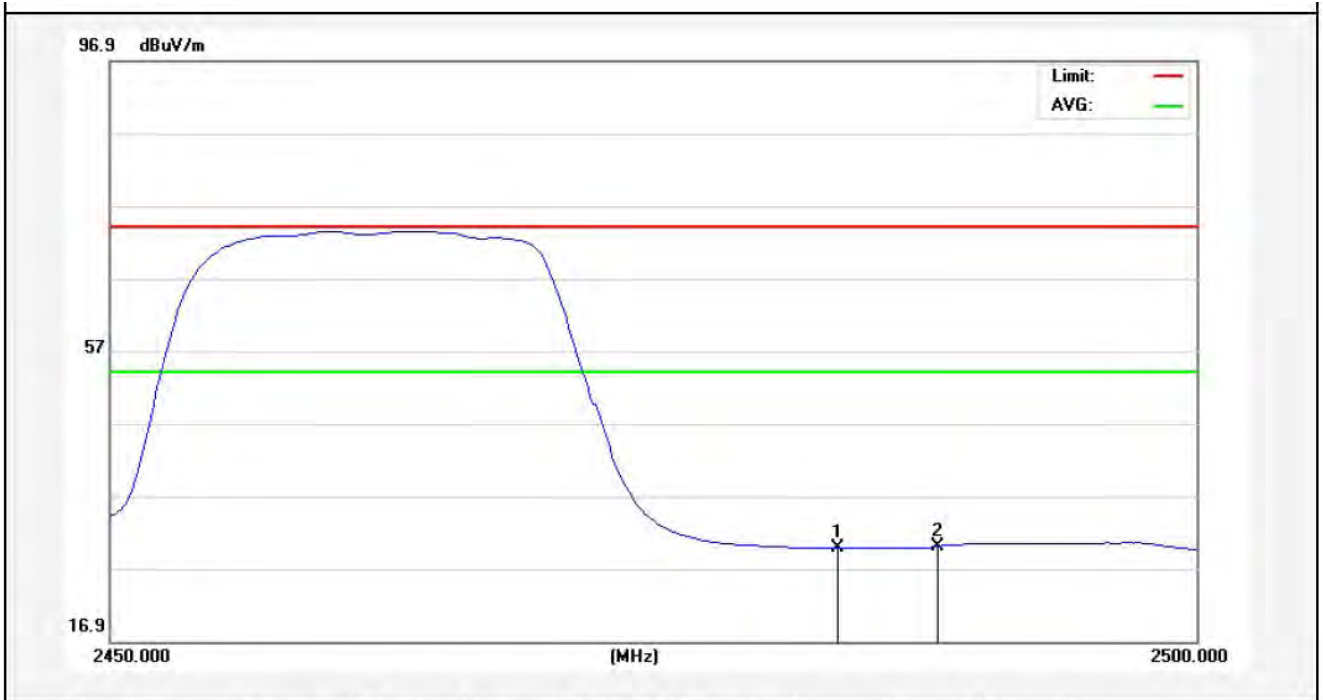

No.	Freq. (MHz)	Reading (dBuV/m)	Factor (dB/m)	Result (dBuV/m)	Limit (dBuV/)	Over Limit (dB)	Detector	Height (cm)	degree (deg)	Remark
1	2483.500	32.13	-2.31	29.82	54.00	-24.18	AVG			
2	2488.125	32.33	-2.30	30.03	54.00	-23.97	AVG			

Anbotek

Test Mode: 802.11n (HT20)
2412MHz
Horizontal-PEAK:

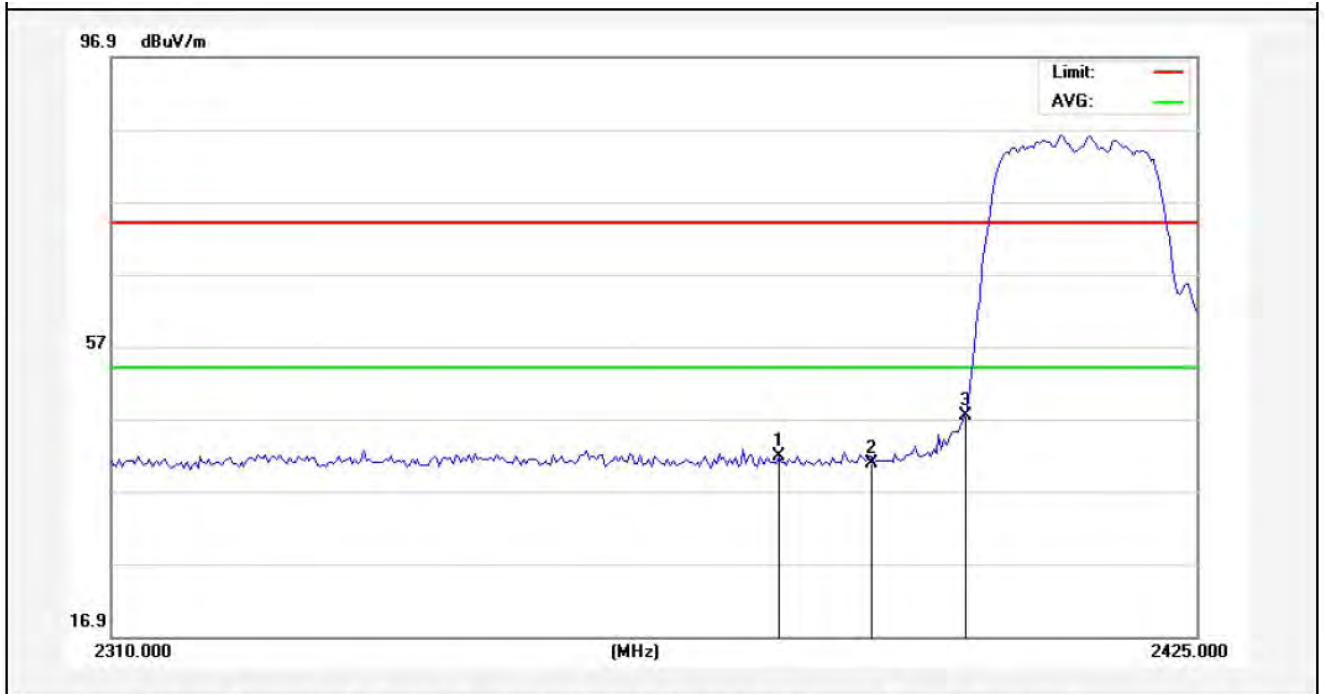

No.	Freq. (MHz)	Reading (dBuV/m)	Factor (dB/m)	Result (dBuV/m)	Limit (dBuV/)	Over Limit (dB)	Detector	Height (cm)	degree (deg)	Remark
1	2380.150	44.40	-2.54	41.86	74.00	-32.14	peak			
2	2390.000	43.34	-2.51	40.83	74.00	-33.17	peak			
3	2400.000	49.99	-2.49	47.50	74.00	-26.50	peak			

AMB

Horizontal-AV:

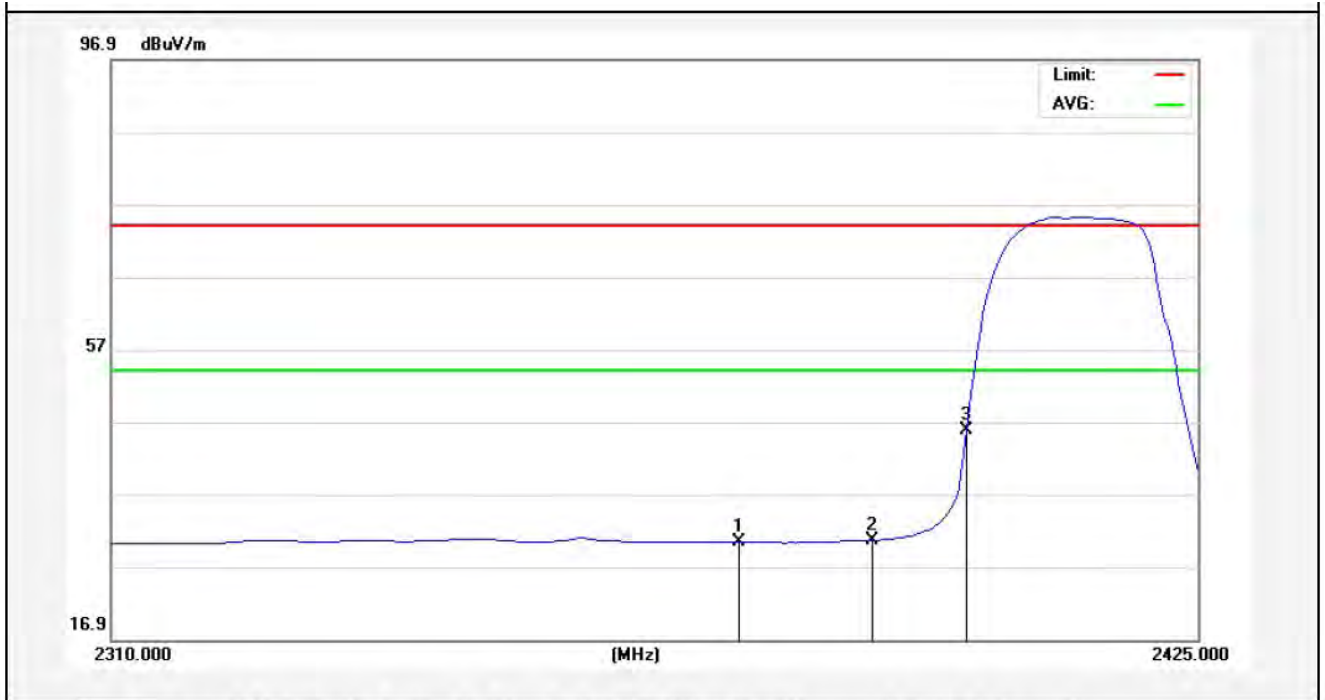

No.	Freq. (MHz)	Reading (dBuV/m)	Factor (dB/m)	Result (dBuV/m)	Limit (dBuV/)	Over Limit (dB)	Detector	Height (cm)	degree (deg)	Remark
1	2375.838	32.95	-2.55	30.40	54.00	-23.60	AVG			
2	2390.000	33.16	-2.51	30.65	54.00	-23.35	AVG			
3	2400.000	48.31	-2.49	45.82	54.00	-8.18	AVG			

Anbotek

Test Mode: 802.11n (HT20)
2412MHz
Vertical-PEAK:

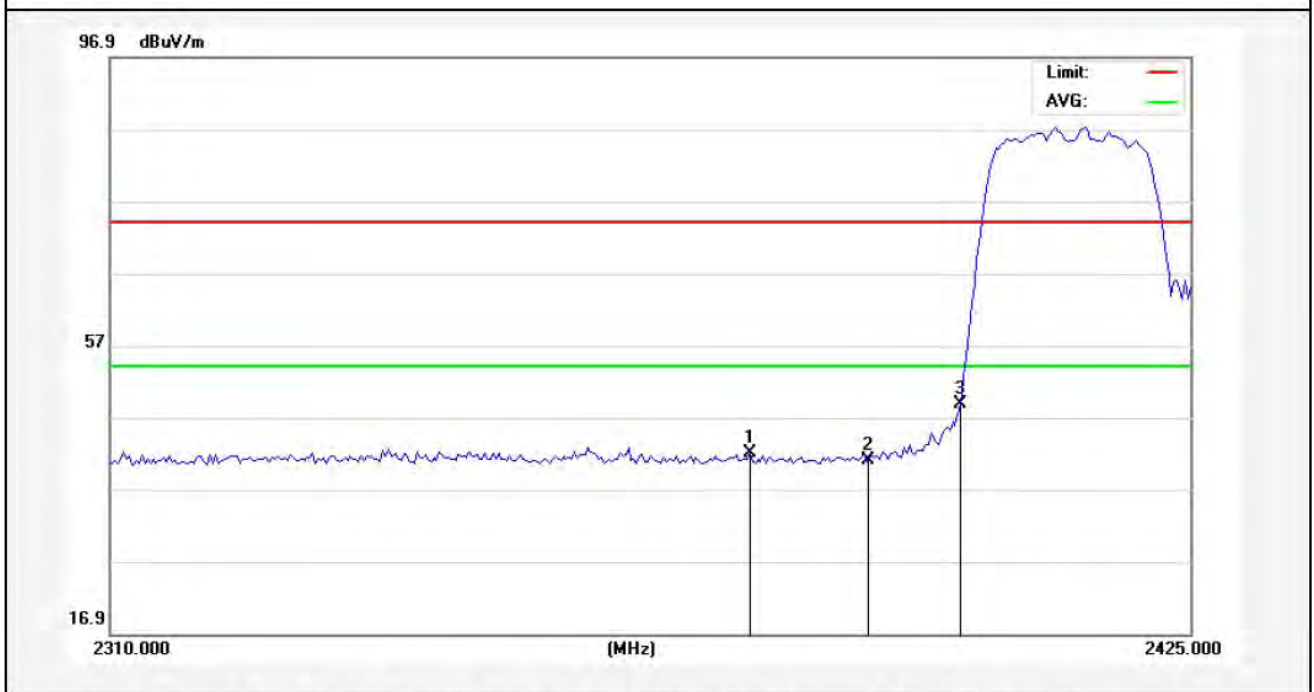

No.	Freq. (MHz)	Reading (dBuV/m)	Factor (dB/m)	Result (dBuV/m)	Limit (dBuV/)	Over Limit (dB)	Detector	Height (cm)	degree (deg)	Remark
1	2377.563	44.52	-2.54	41.98	74.00	-32.02	peak			
2	2390.000	43.54	-2.51	41.03	74.00	-32.97	peak			
3	2400.000	51.36	-2.49	48.87	74.00	-25.13	peak			

AMB

Vertical-AV:

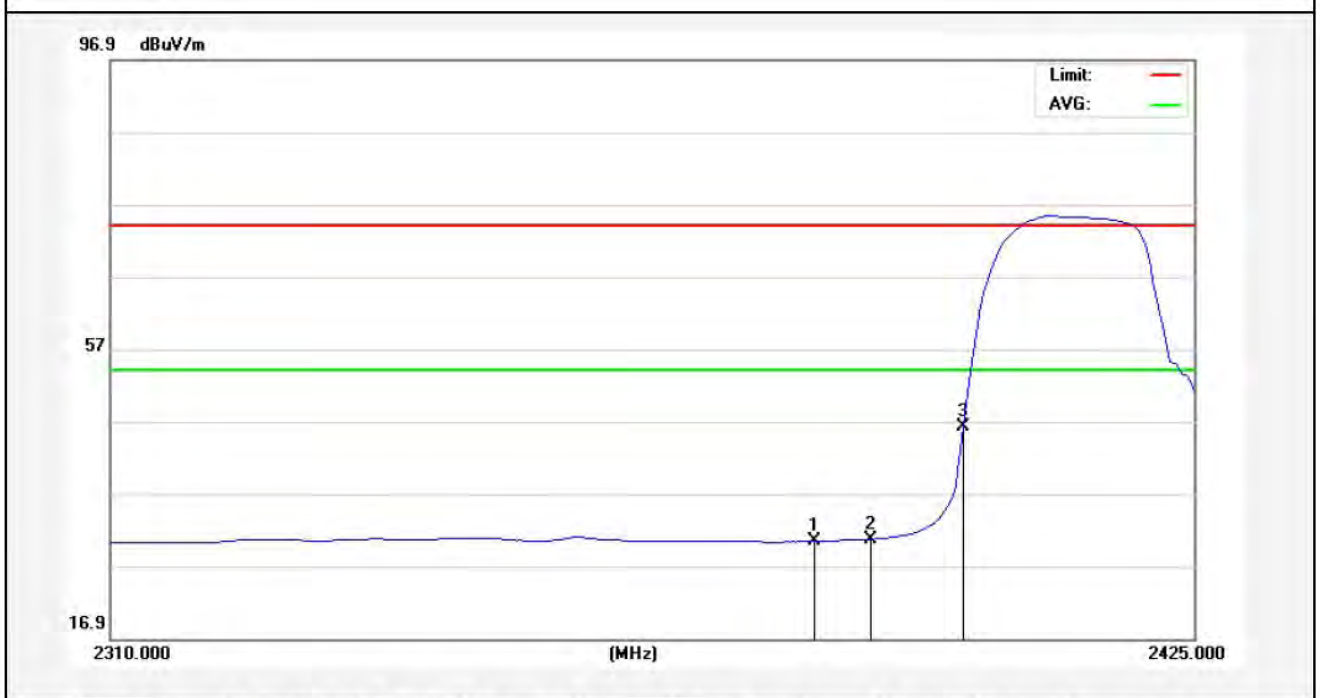

No.	Freq. (MHz)	Reading (dBuV/m)	Factor (dB/m)	Result (dBuV/m)	Limit (dBuV/)	Over Limit (dB)	Detector	Height (cm)	degree (deg)	Remark
1	2384.175	32.93	-2.53	30.40	54.00	-23.60	AVG			
2	2390.000	33.17	-2.51	30.66	54.00	-23.34	AVG			
3	2400.000	48.64	-2.49	46.15	54.00	-7.85	AVG			

Anbotek

Test Mode: 802.11n (HT20)
2462MHz
Horizontal-PEAK:

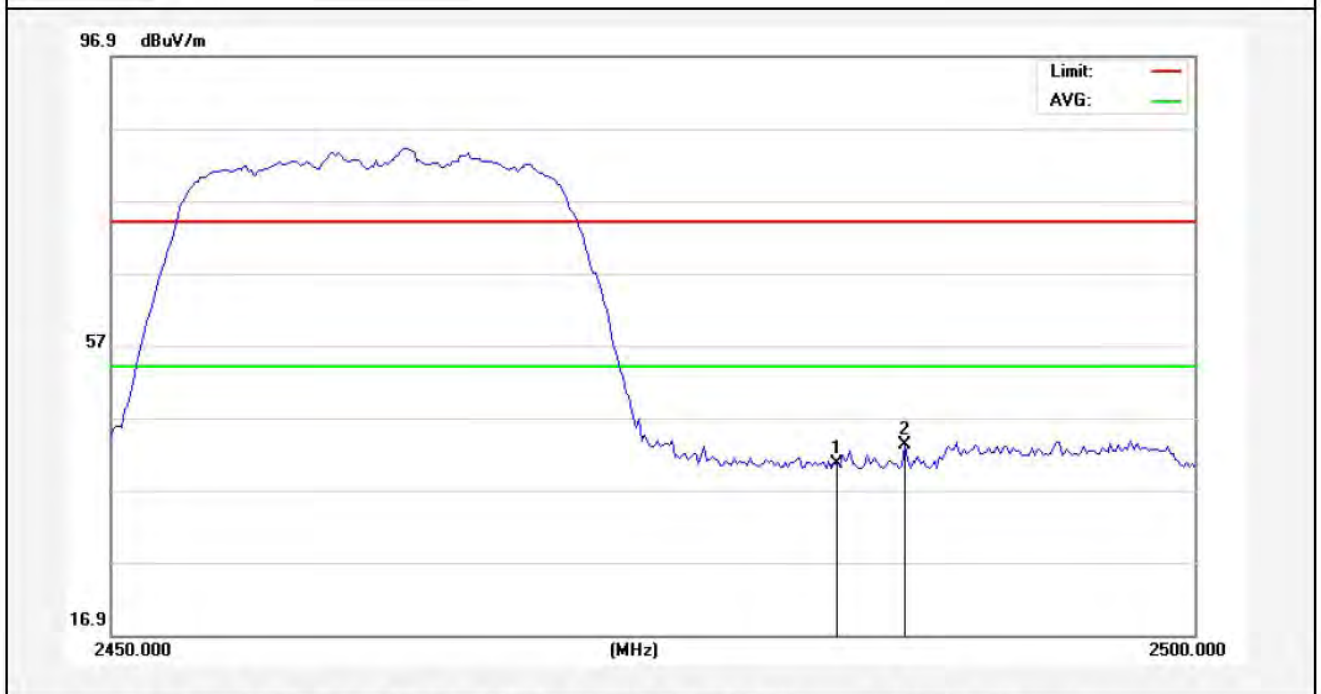

No.	Freq. (MHz)	Reading (dBuV/m)	Factor (dB/m)	Result (dBuV/m)	Limit (dBuV/)	Over Limit (dB)	Detector	Height (cm)	degree (deg)	Remark
1	2483.500	42.83	-2.31	40.52	74.00	-33.48	peak			
2	2486.625	45.50	-2.30	43.20	74.00	-30.80	peak			

Anbotek

Horizontal-AV:

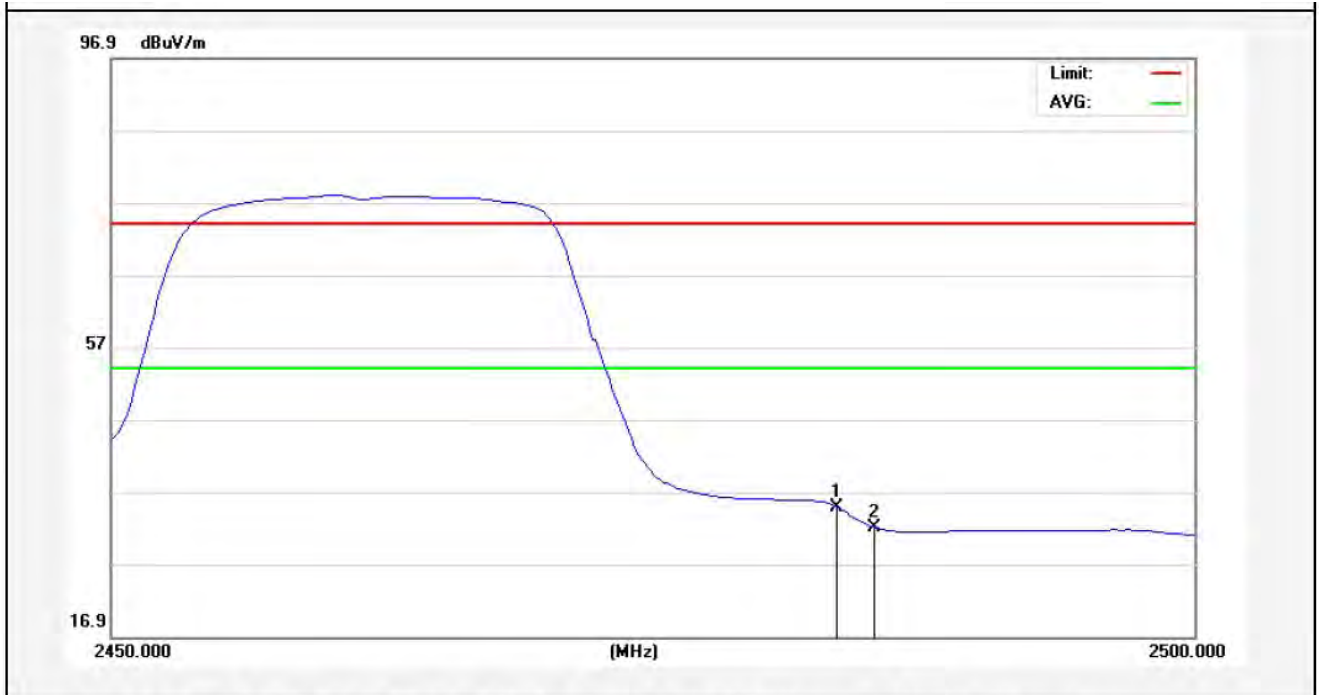

No.	Freq. (MHz)	Reading (dBuV/m)	Factor (dB/m)	Result (dBuV/m)	Limit (dBuV/)	Over Limit (dB)	Detector	Height (cm)	degree (deg)	Remark
1	2483.500	37.21	-2.31	34.90	54.00	-19.10	AVG			
2	2485.250	34.33	-2.30	32.03	54.00	-21.97	AVG			

Anbotek

Test Mode: 802.11n (HT20)
2462MHz
Vertical-PEAK:

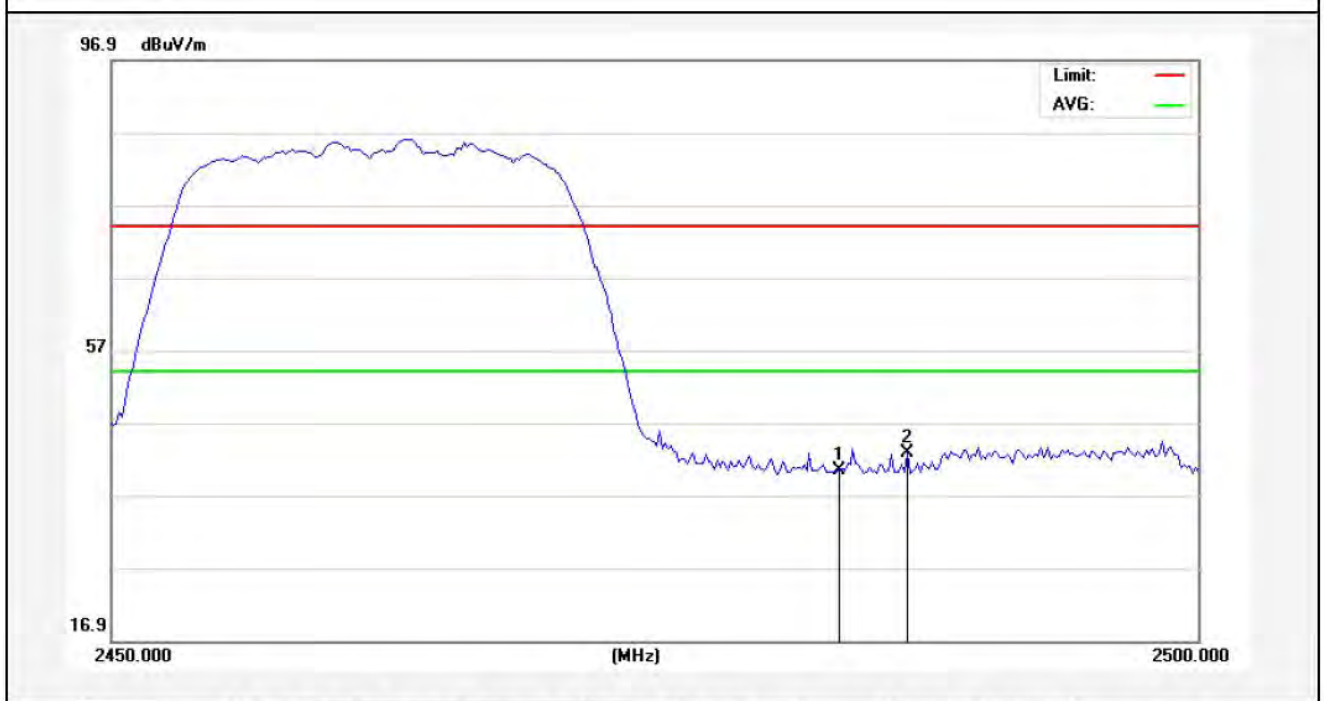

No.	Freq. (MHz)	Reading (dBuV/m)	Factor (dB/m)	Result (dBuV/m)	Limit (dBuV/)	Over Limit (dB)	Detector	Height (cm)	degree (deg)	Remark
1	2483.500	42.75	-2.31	40.44	74.00	-33.56	peak			
2	2486.625	45.09	-2.30	42.79	74.00	-31.21	peak			

Anbotek

Vertical-AV:

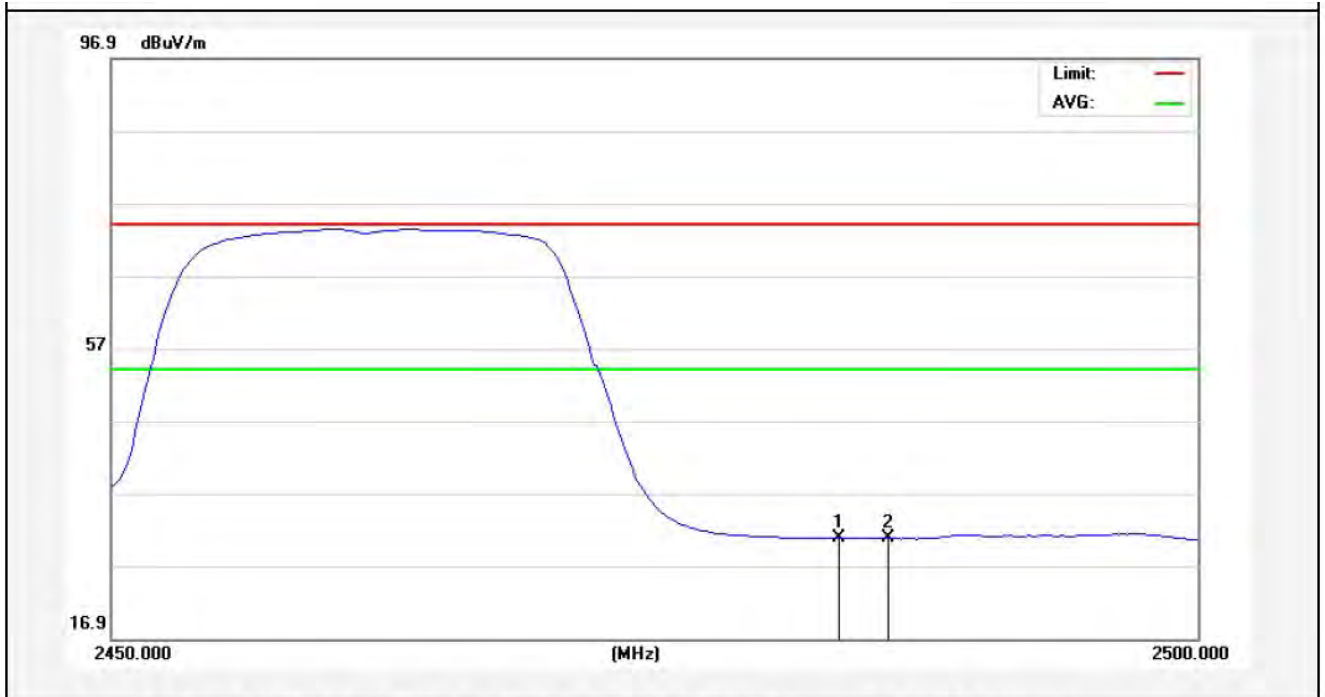

No.	Freq. (MHz)	Reading (dBuV/m)	Factor (dB/m)	Result (dBuV/m)	Limit (dBuV/)	Over Limit (dB)	Detector	Height (cm)	degree (deg)	Remark
1	2483.500	33.09	-2.31	30.78	74.00	-43.22	AVG			
2	2485.750	33.06	-2.30	30.76	74.00	-43.24	AVG			

Anbotek

Test Mode: 802.11n (HT40)
2422MHz
Horizontal-PEAK:

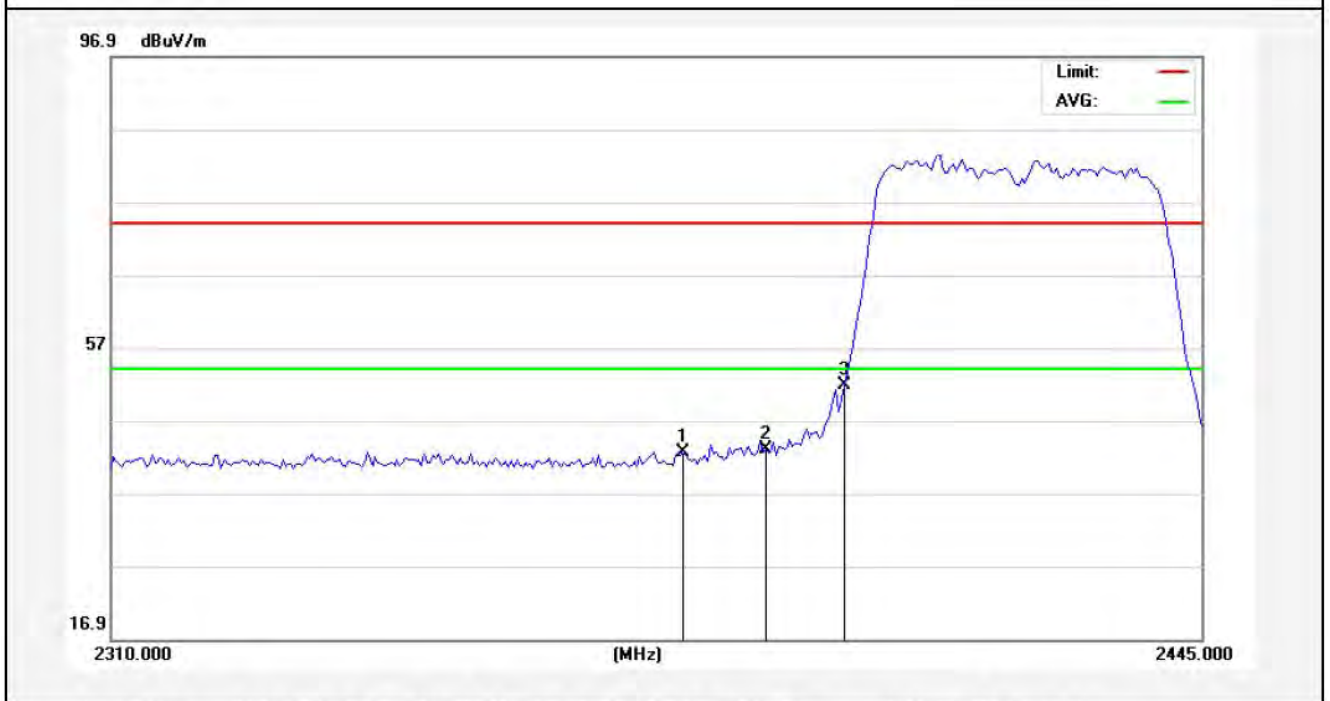

No.	Freq. (MHz)	Reading (dBuV/m)	Factor (dB/m)	Result (dBuV/m)	Limit (dBuV/)	Over Limit (dB)	Detector	Height (cm)	degree (deg)	Remark
1	2380.200	45.24	-2.54	42.70	74.00	-31.30	peak			
2	2390.000	45.48	-2.51	42.97	74.00	-31.03	peak			
3	2400.000	54.39	-2.49	51.90	74.00	-22.10	peak			

AMB

Horizontal-AV:

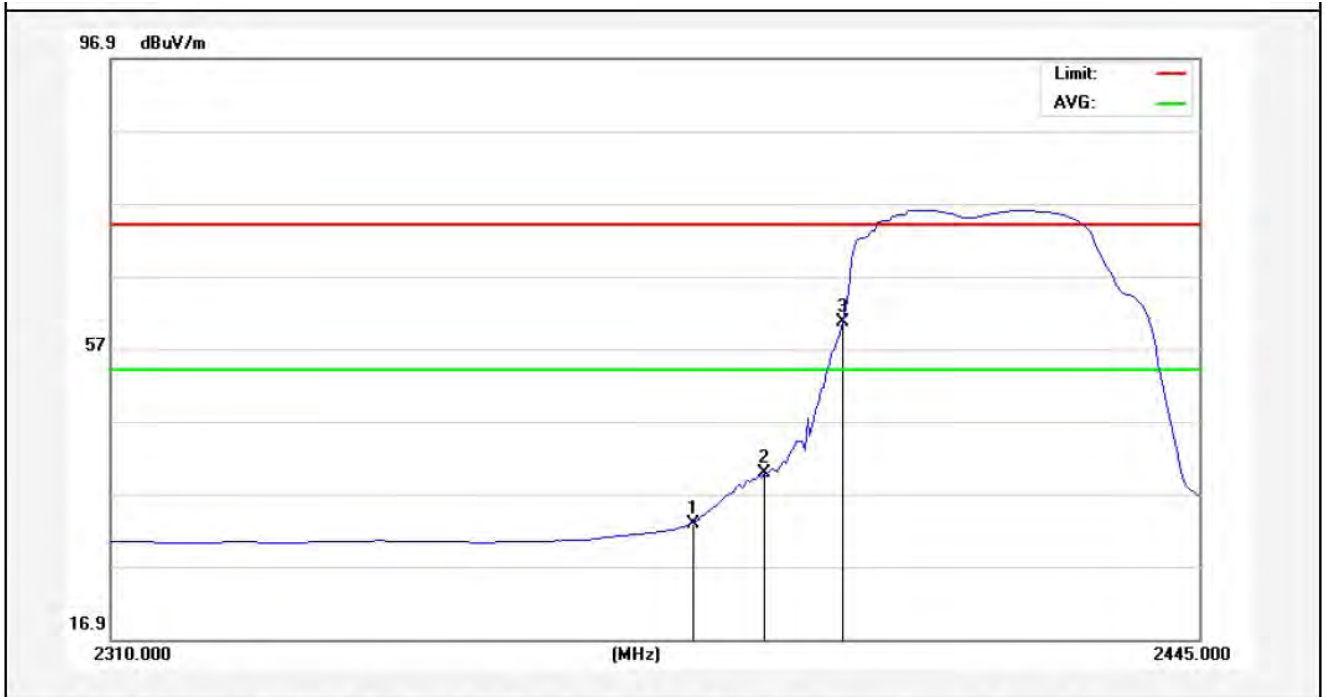

No.	Freq. (MHz)	Reading (dBuV/m)	Factor (dB/m)	Result (dBuV/m)	Limit (dBuV/)	Over Limit (dB)	Detector	Height (cm)	degree (deg)	Remark
1	2381.213	35.31	-2.53	32.78	54.00	-21.22	AVG			
2	2390.000	42.29	-2.51	39.78	54.00	-14.22	AVG			
3	2400.000	63.05	-2.49	60.56	54.00	6.56	AVG			

Anbotek

Test Mode: 802.11n (HT40)
2422MHz
Vertical-PEAK:

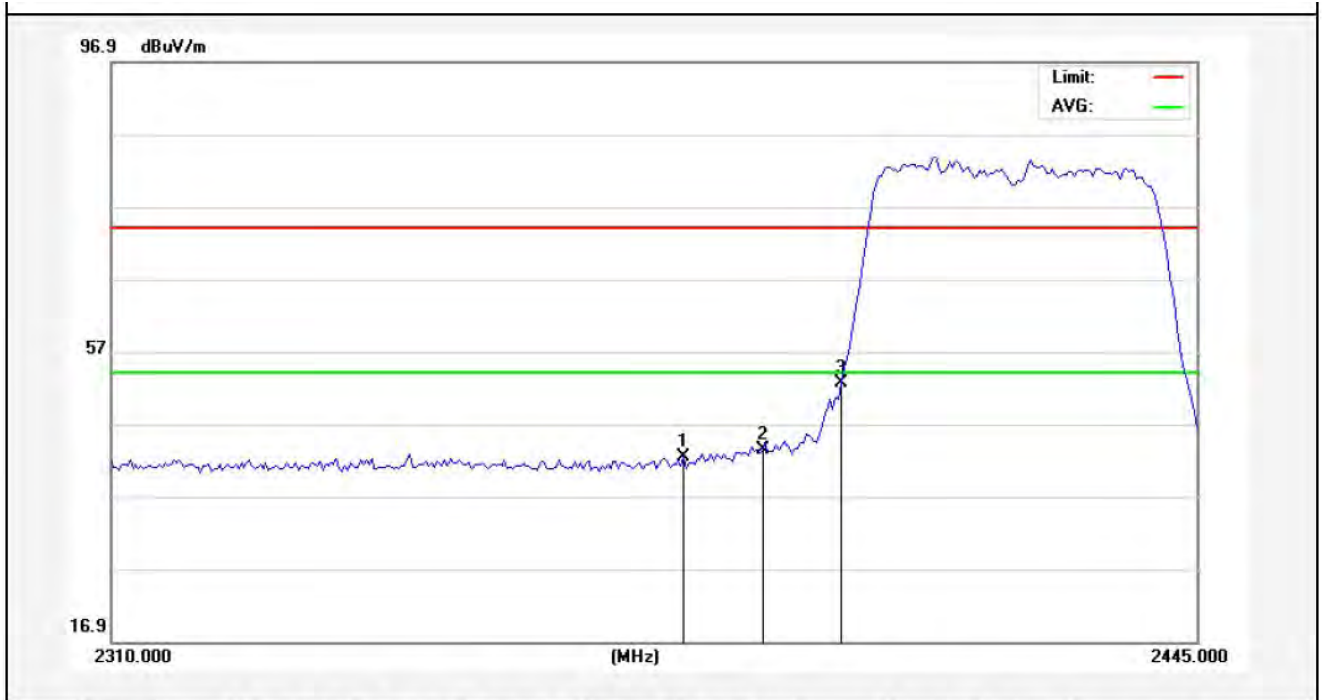

No.	Freq. (MHz)	Reading (dBuV/m)	Factor (dB/m)	Result (dBuV/m)	Limit (dBuV/)	Over Limit (dB)	Detector	Height (cm)	degree (deg)	Remark
1	2380.537	44.94	-2.54	42.40	74.00	-31.60	peak			
2	2390.000	45.96	-2.51	43.45	74.00	-30.55	peak			
3	2400.000	55.12	-2.49	52.63	74.00	-21.37	peak			

AMB

Vertical-AV:

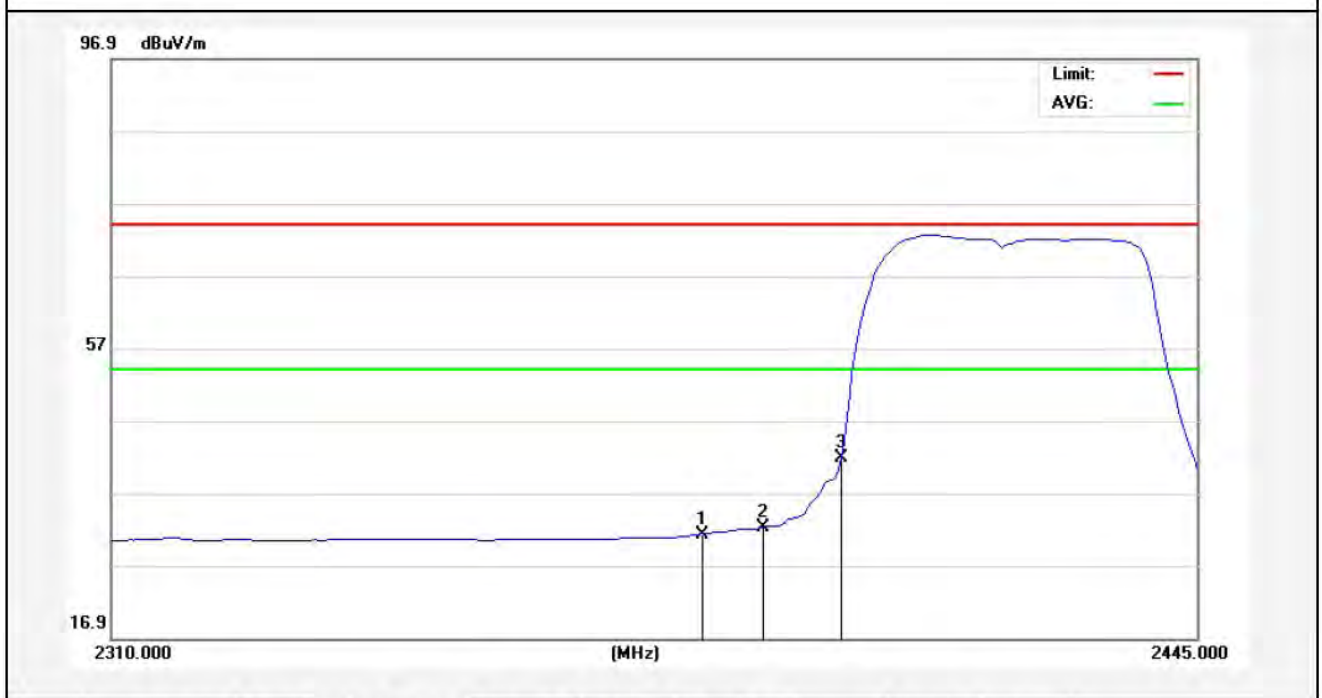

No.	Freq. (MHz)	Reading (dBuV/m)	Factor (dB/m)	Result (dBuV/m)	Limit (dBuV/)	Over Limit (dB)	Detector	Height (cm)	degree (deg)	Remark
1	2382.563	33.81	-2.53	31.28	54.00	-22.72	AVG			
2	2390.000	34.77	-2.51	32.26	54.00	-21.74	AVG			
3	2400.000	44.34	-2.49	41.85	54.00	-12.15	AVG			

Anbotek

Test Mode: 802.11n (HT40)
2452MHz
Horizontal-PEAK:

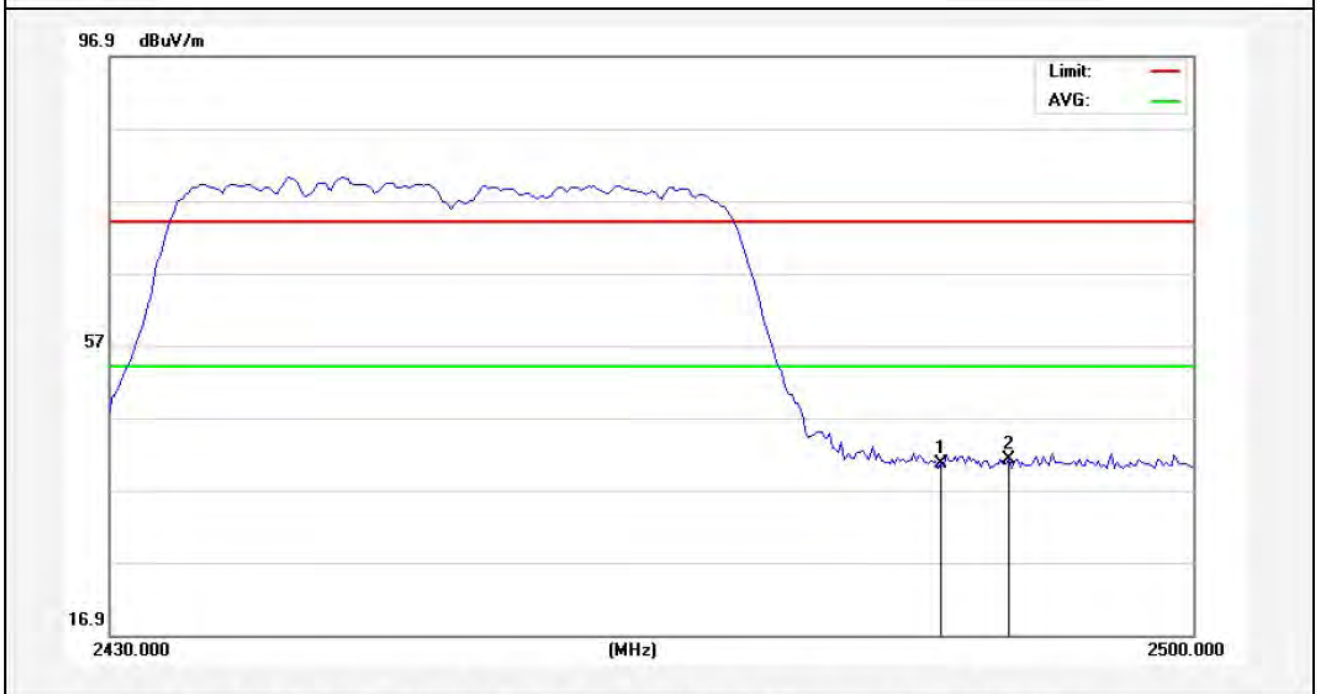

No.	Freq. (MHz)	Reading (dBuV/m)	Factor (dB/m)	Result (dBuV/m)	Limit (dBuV/)	Over Limit (dB)	Detector	Height (cm)	degree (deg)	Remark
1	2483.500	42.90	-2.31	40.59	74.00	-33.41	peak			
2	2488.100	43.53	-2.30	41.23	74.00	-32.77	peak			

Anbotek

Horizontal-AV:

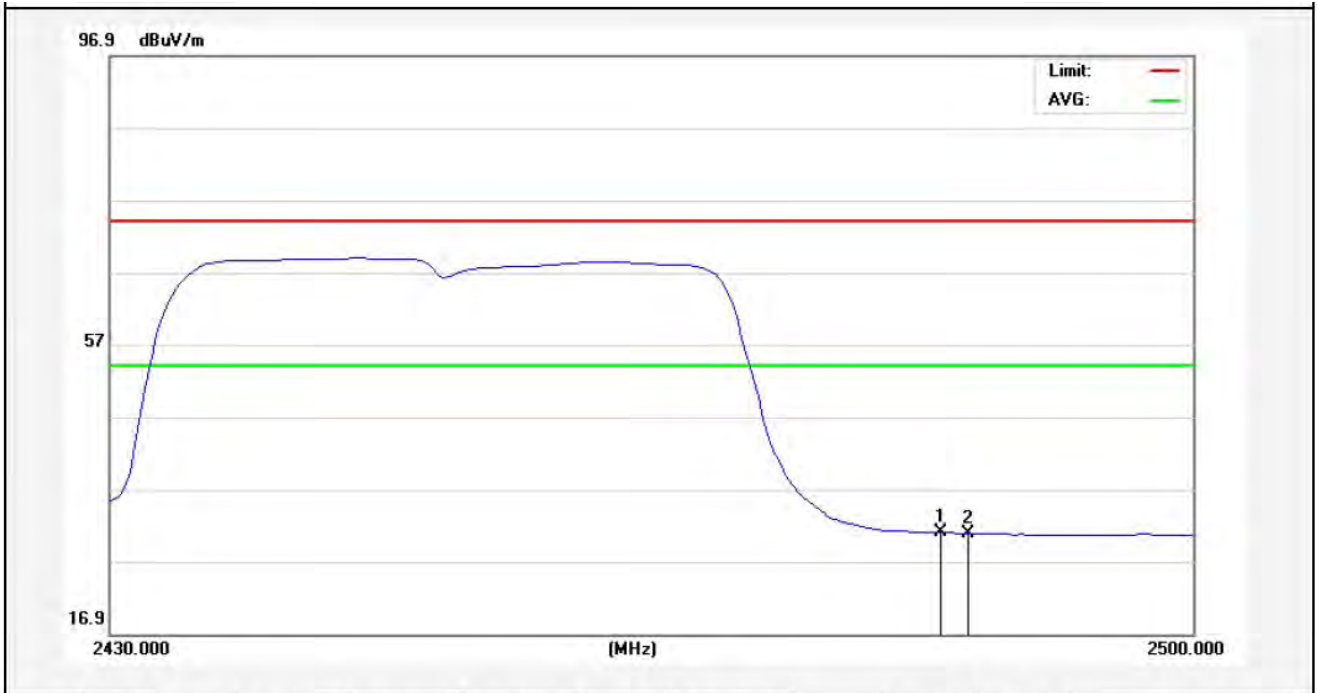

No.	Freq. (MHz)	Reading (dBuV/m)	Factor (dB/m)	Result (dBuV/m)	Limit (dBuV/)	Over Limit (dB)	Detector	Height (cm)	degree (deg)	Remark
1	2483.500	33.28	-2.31	30.97	54.00	-23.03	AVG			
2	2485.475	33.14	-2.30	30.84	54.00	-23.16	AVG			

Test Mode: 802.11n (HT40)
2452MHz
Vertical-PEAK:

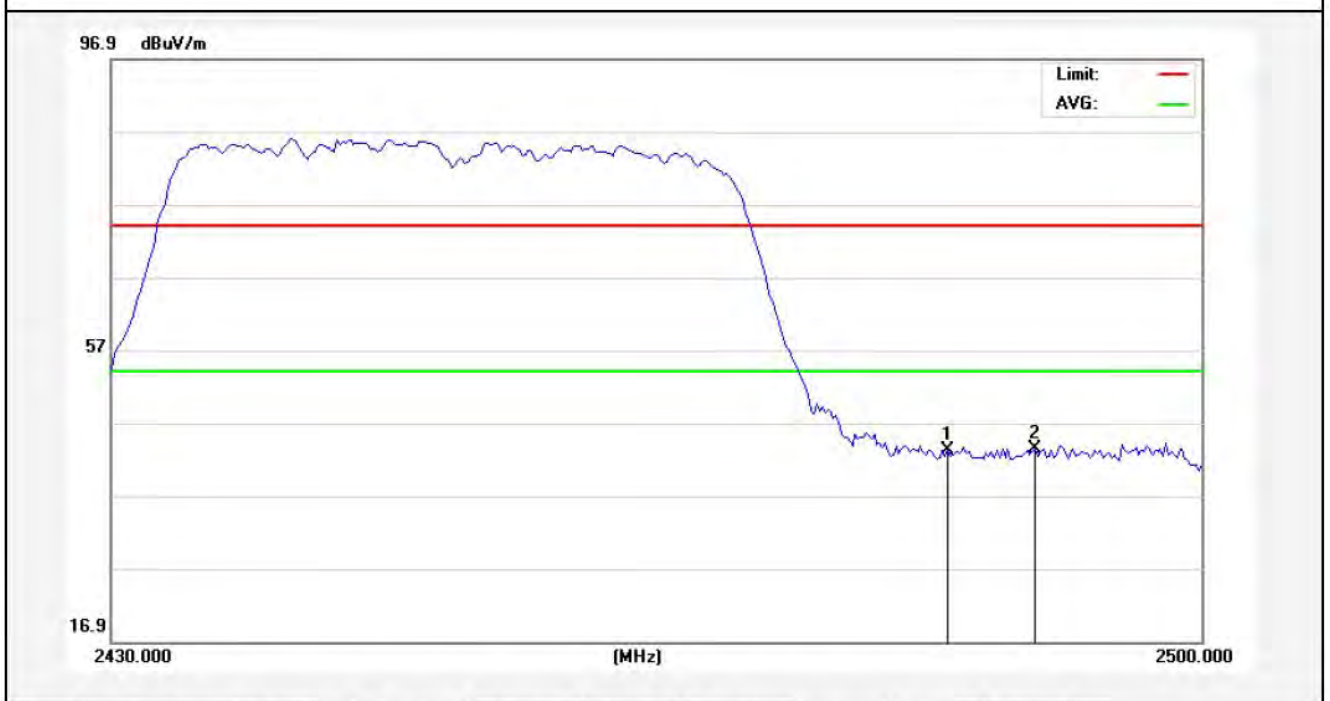

No.	Freq. (MHz)	Reading (dBuV/m)	Factor (dB/m)	Result (dBuV/m)	Limit (dBuV/)	Over Limit (dB)	Detector	Height (cm)	degree (deg)	Remark
1	2483.500	45.54	-2.31	43.23	74.00	-30.77	peak			
2	2489.325	45.78	-2.29	43.49	74.00	-30.51	peak			

Anbotek

Vertical-AV:

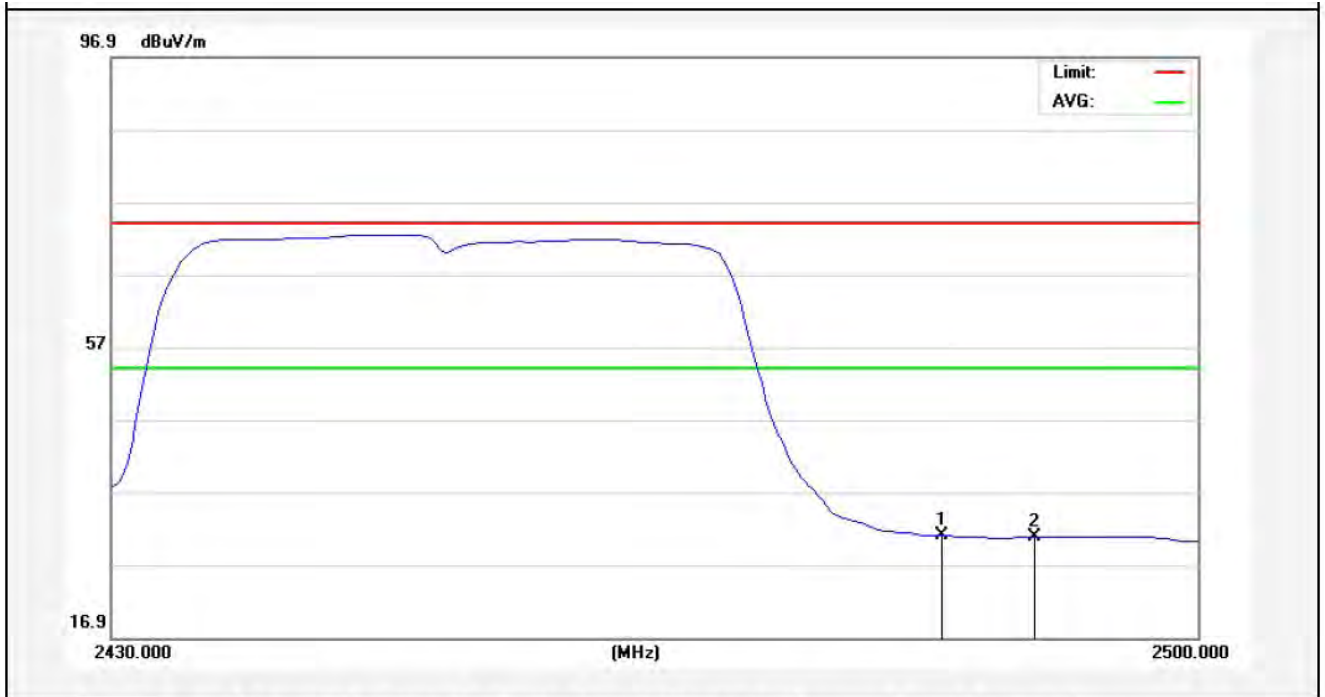

No.	Freq. (MHz)	Reading (dBuV/m)	Factor (dB/m)	Result (dBuV/m)	Limit (dBuV/)	Over Limit (dB)	Detector	Height (cm)	degree (deg)	Remark
1	2483.500	33.27	-2.31	30.96	54.00	-23.04	AVG			
2	2489.500	33.14	-2.29	30.85	54.00	-23.15	AVG			

Anbotek

4.5. Peak Power Spectral Density

a. Limit

1. For direct sequence systems, the peak power spectral density conducted from the intentional radiator to the antenna shall not be greater than 8dBm in any 3kHz band during any time interval of continuous transmission.
2. The direct sequence operating of the hybrid system, with the frequency hopping operation turned off, shall comply with the power density requirements of paragraph (d) of this section.

b. Test Procedure

1. Place the EUT on the table and set it in transmitting mode. Remove the antenna from the EUT and then connect a low loss RF cable from the antenna port to the spectrum analyzer.
2. Set the spectrum analyzer as RBW = 3kHz, VBW = 10kHz, Span = 1.5 times DTS BW, Sweep=500s
3. Record the max. reading.
4. Repeat the above procedure until the measurements for all frequencies are completed.

c. Test Equipment

Same as the equipment listed in 4.2.

d. Test Setup

See 4.1

e. Test Results

Pass

f. Test Data

Please refer to the following data.

g. Test Plot See the following pages

Test mode: IEEE 802.11b

Channel	Frequency (MHz)	PPSD (dBm/3KHz)	Σ PPSD (dBm/3KHz)	Limit (dBm)	Result
Low	2412	-22.92	-	8.00	Pass
Mid	2437	-23.78	-		Pass
High	2462	-24.01	-		Pass

Test mode: IEEE 802.11g

Channel	Frequency (MHz)	PPSD (dBm)	Σ PPSD (dBm)	Limit (dBm)	Result
Low	2412	-27.80	-	8.00	Pass
Mid	2437	-29.48	-		Pass
High	2462	-30.22	-		Pass

Test mode: IEEE 802.11n (HT20)

Channel	Frequency (MHz)	PPSD (dBm/3KHz)	Σ PPSD (dBm/3KHz)	Limit (dBm)	Result
Low	2412	-29.06	-	8.00	Pass
Mid	2437	-28.96	-		Pass
High	2462	-29.36	-		Pass

Test mode: IEEE 802.11n (HT40)

Channel	Frequency (MHz)	PPSD (dBm/3KHz)	Σ PPSD (dBm/3KHz)	Limit (dBm)	Result
Low	2422	-29.41	-	8.00	Pass
Mid	2437	-30.65	-		Pass
High	2452	-30.52	-		Pass

802.11 b CH--Low



*RBW 3 kHz Marker 1 [T1]
*VBW 10 kHz -22.92 dBm
SWT 2 s 2.413511880 GHz

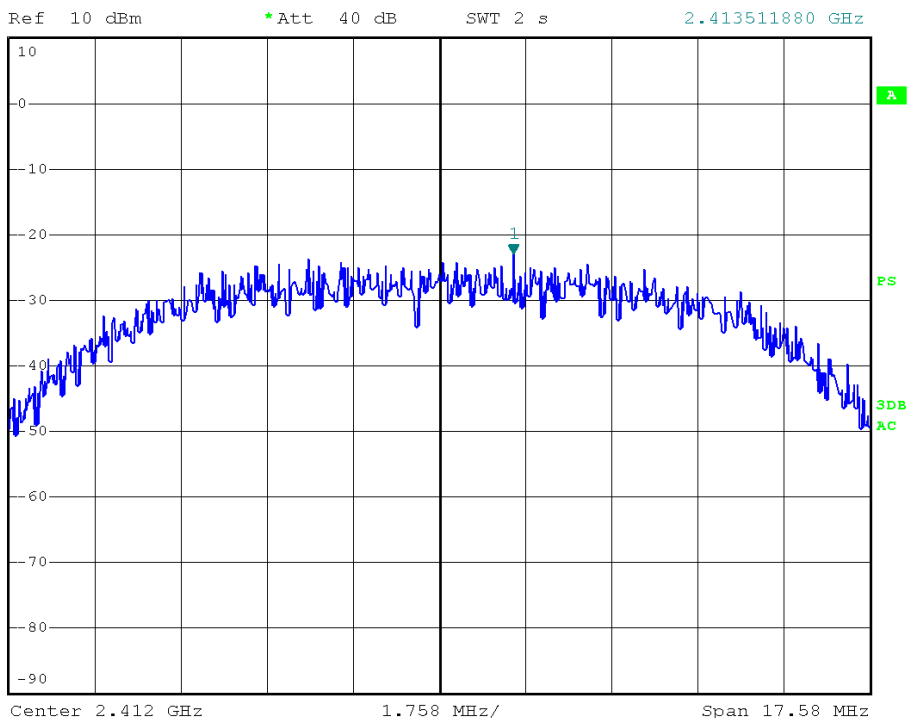

802.11 b CH--Mid



*RBW 3 kHz Marker 1 [T1]
*VBW 10 kHz -23.78 dBm
SWT 2 s 2.438476720 GHz

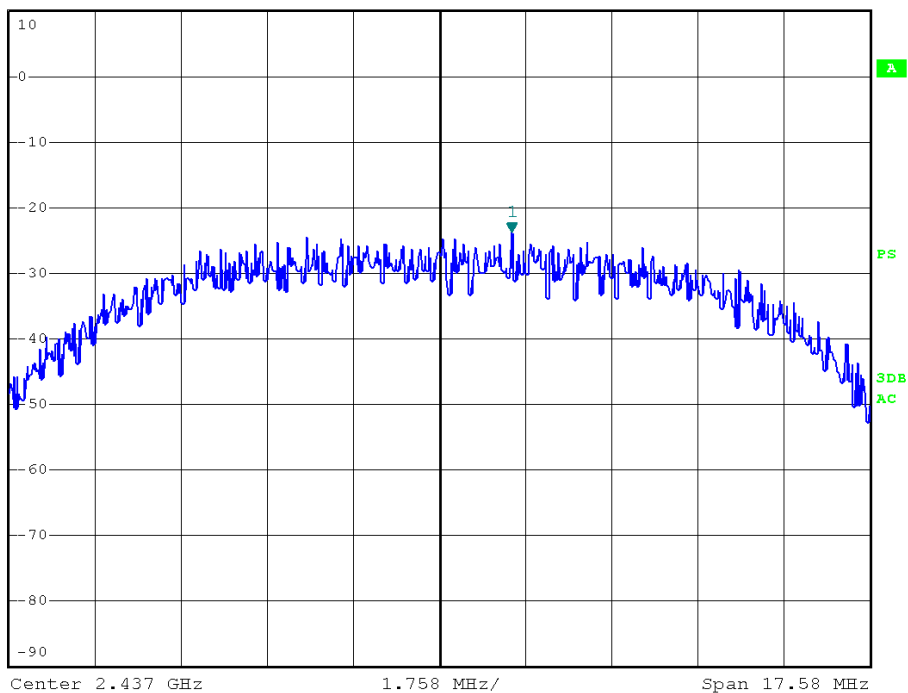

802.11 b CH--High

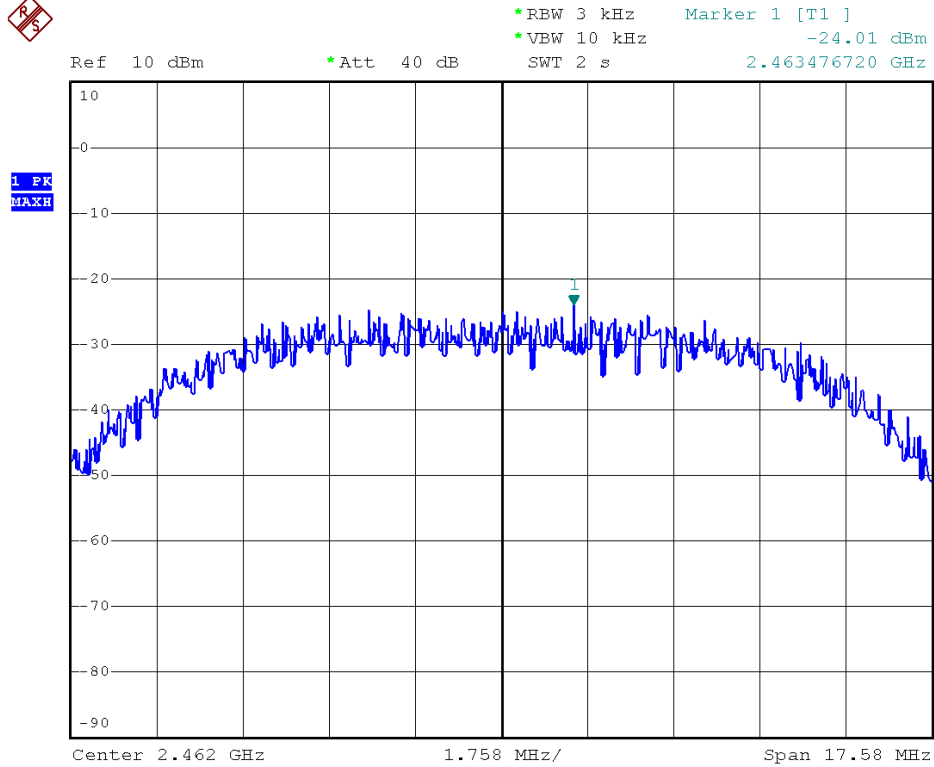

802.11g CH--Low

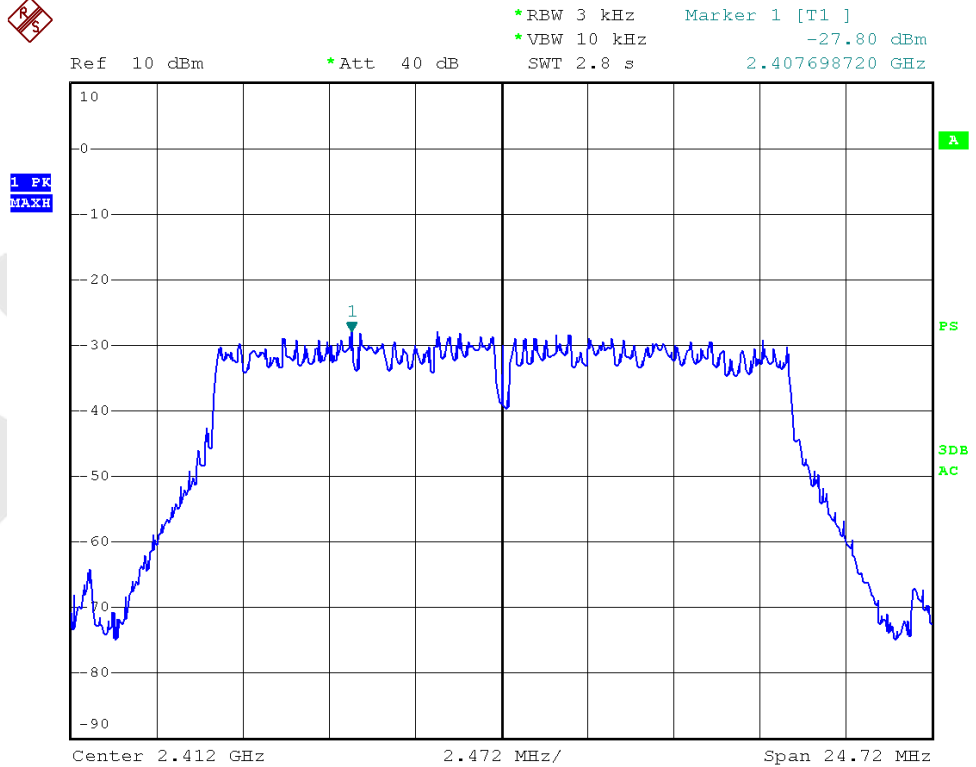

802.11g CH--Mid



*RBW 3 kHz Marker 1 [T1]
*VBW 10 kHz -29.48 dBm
SWT 2.8 s 2.432945920 GHz

Ref 10 dBm *Att 40 dB

1 PK
MAXH

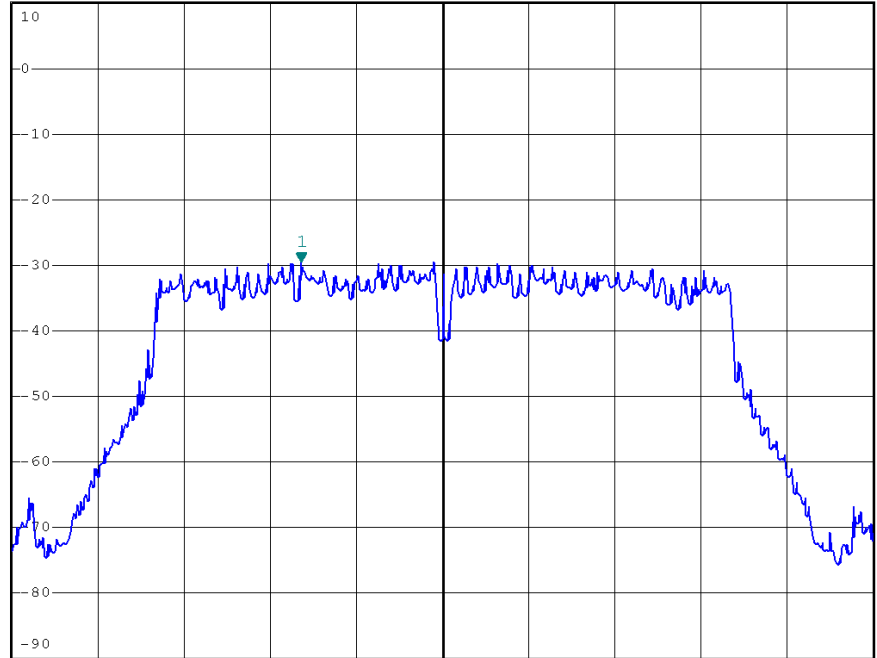

Center 2.437 GHz 2.472 MHz/ Span 24.72 MHz

802.11g CH--High



*RBW 3 kHz Marker 1 [T1]
*VBW 10 kHz -30.22 dBm
SWT 2.8 s 2.463582080 GHz

Ref 10 dBm *Att 40 dB

1 PK
MAXH

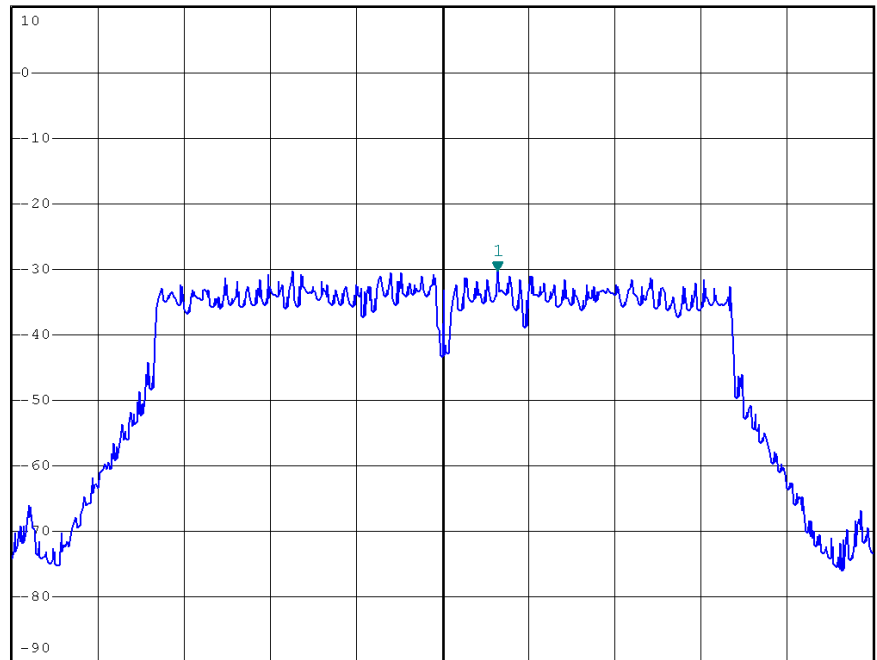

Center 2.462 GHz 2.472 MHz/ Span 24.72 MHz

802.11n (HT20) CH—Low



Ref 10 dBm *Att 40 dB *RBW 3 kHz Marker 1 [T1] -29.06 dBm
*VBW 10 kHz 2.416445280 GHz
SWT 3 s

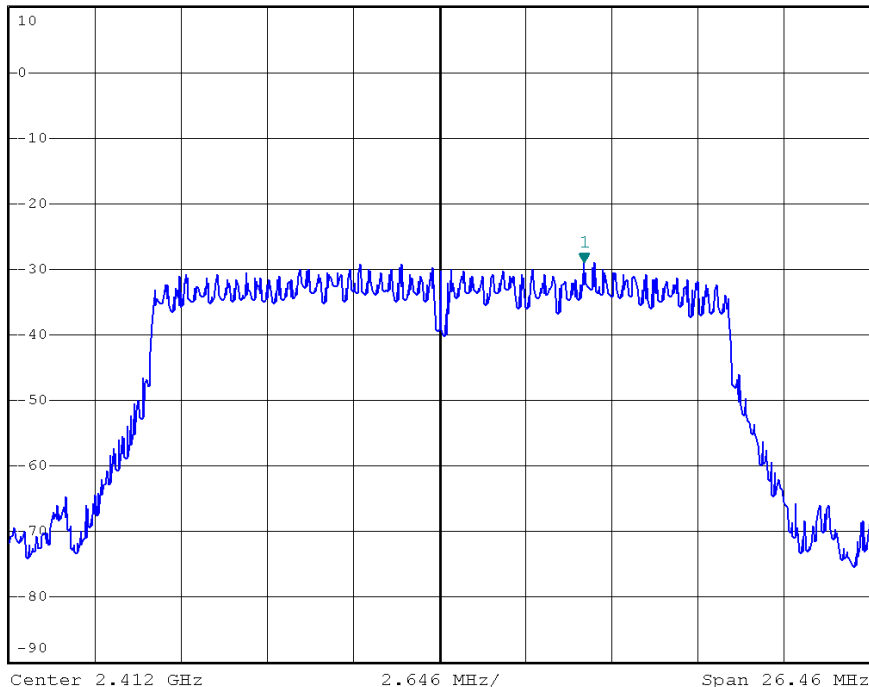

802.11n (HT20) CH—Mid



Ref 10 dBm *Att 40 dB *RBW 3 kHz Marker 1 [T1] -28.96 dBm
*VBW 10 kHz 2.434565680 GHz
SWT 3 s

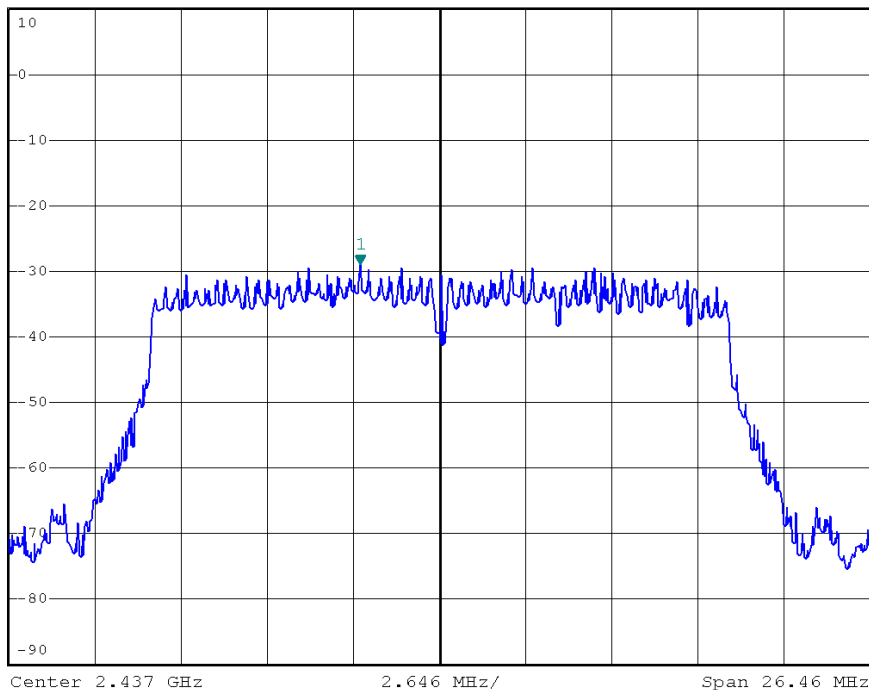

802.11n (HT20) CH—High



*RBW 3 kHz Marker 1 [T1]
*VBW 10 kHz -29.36 dBm
SWT 3 s 2.457978080 GHz

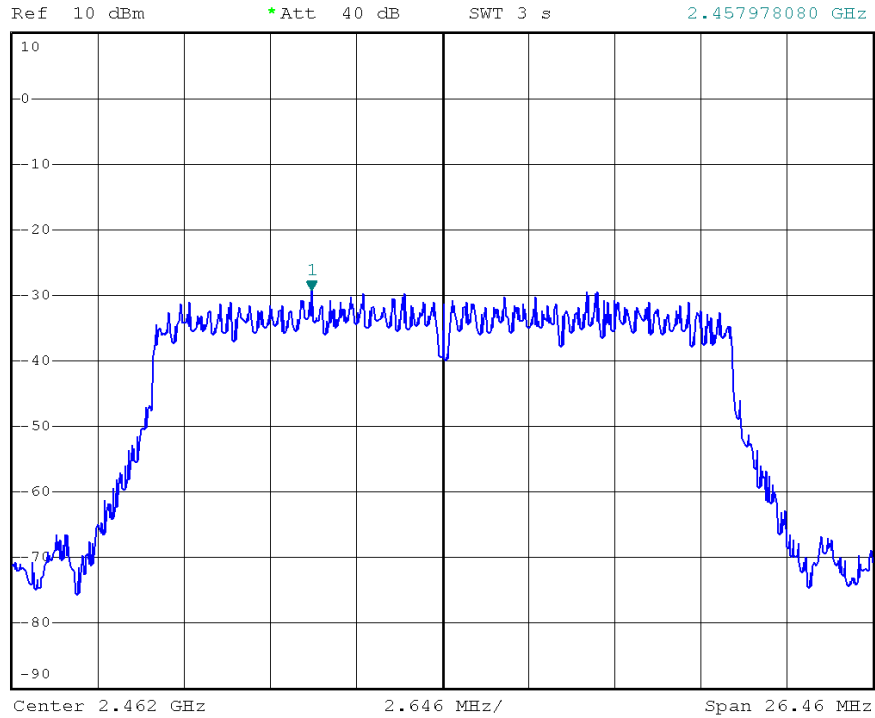

802.11n (HT40) CH—Low



*RBW 3 kHz Marker 1 [T1]
*VBW 10 kHz -29.41 dBm
SWT 6.2 s 2.418607360 GHz

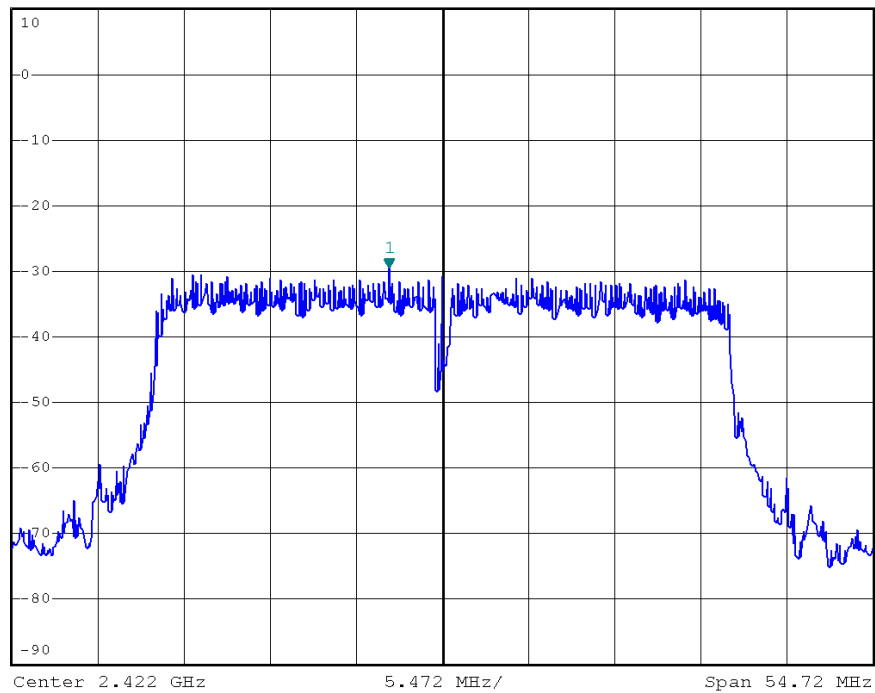

802.11n (HT40) CH—Mid



*RBW 3 kHz Marker 1 [T1]
*VBW 10 kHz -30.65 dBm
SWT 6.2 s 2.448600640 GHz

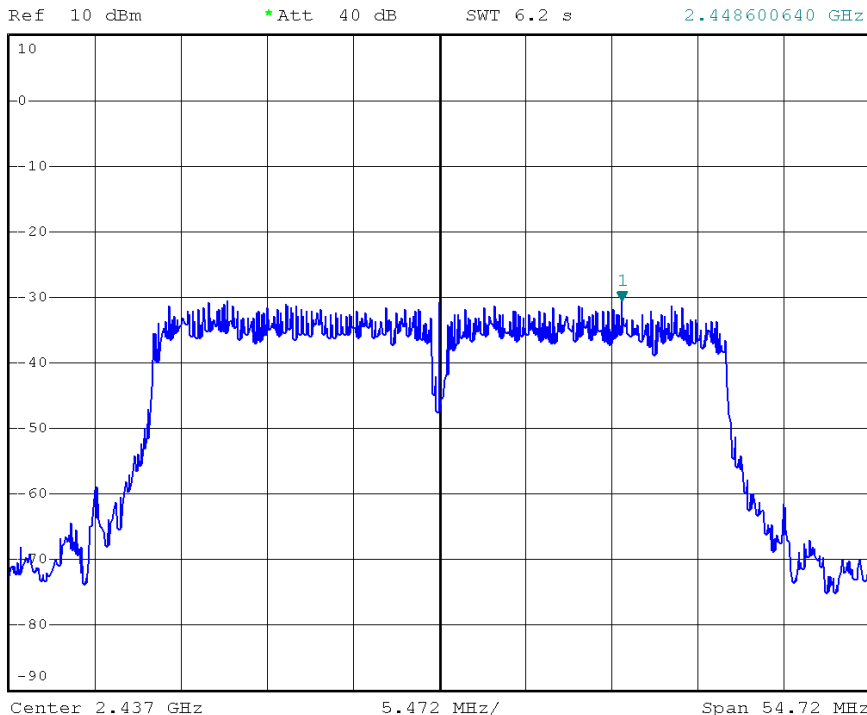

802.11n (HT40) CH—High



*RBW 3 kHz Marker 1 [T1]
*VBW 10 kHz -30.52 dBm
SWT 6.2 s 2.461083520 GHz

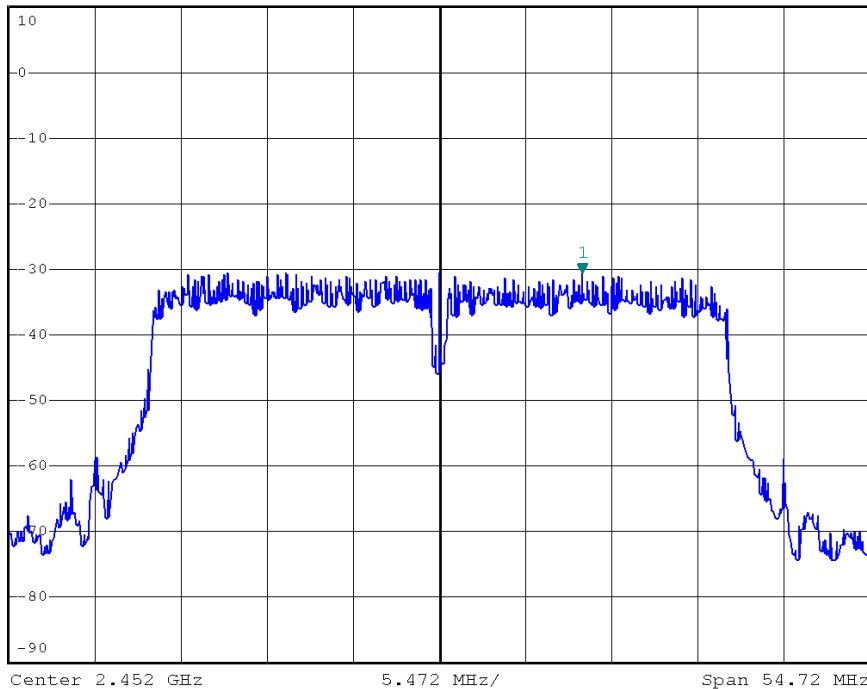

4.6. Radiated Emissions

4.6.1.1. Test Limits (< 30 MHz)

Frequency (MHz)	Field Strength (microvolts/meter)	Measurement Distance (meter)
0.009-0.490	2400/F(kHz)	300
0.490-1.705	24000/F(kHz)	30
1.705-30.0	30	30

4.6.1.2. Test Limits (≥ 30 MHz)

FIELD STRENGTH of Fundamental: @3M	FIELD STRENGTH of Harmonics	S15.209	
902-928 MHz		30 - 88 MHz	40 dBuV/m
2.4-2.4835 GHz		88 - 216 MHz	43.5
94 dBμV/m @3m	54 dBμV/m @3m	216 - 960 MHz	46
		ABOVE 960 MHz	54dBuV/m

In any 100 kHz bandwidth outside the frequency band in which the spread spectrum or digitally modulated intentional radiator is operating, the radio frequency power that is produced by the intentional radiator shall be at least 20 dB below that in the 100 kHz bandwidth within the band that contains the highest level of the desired power, based on either an RF conducted or a radiated measurement. Attenuation below the general limits specified in Section 15.209(a) is not required. In addition, radiated emissions which fall in the restricted bands, as defined in Section 15.205(a), must also comply with the radiated emission limits specified in Section 15.209(a) (see Section 15.205(c)).

Test Equipment

Item	Equipment	Manufacturer	Model No.	Serial No.	Last Cal.	Cal. Interval
1.	Spectrum Analysis	Agilent	E4407B	US39390582	Apr. 17, 2015	1 Year
2.	Preamplifier	Instruments corporation	EMC011830	980100	Apr. 17, 2015	1 Year
3.	EMI Test Receiver	Rohde & Schwarz	ESPI	101604	Apr. 17, 2015	1 Year
4.	Double Ridged Horn Antenna	Instruments corporation	GTH-0118	351600	Apr. 20, 2015	1 Year
5.	Bilog Broadband Antenna	Schwarzbeck	VULB9163	VULB 9163-289	Apr. 20, 2015	1 Year
6.	Pre-amplifier	SONOMA	310N	186860	Apr. 17, 2015	1 Year
7.	EMI Test Software EZ-EMC	SHURPLE	N/A	N/A	N/A	N/A

4.6.2. Test Configuration:

4.6.2.1. 9k to 30MHz emissions:

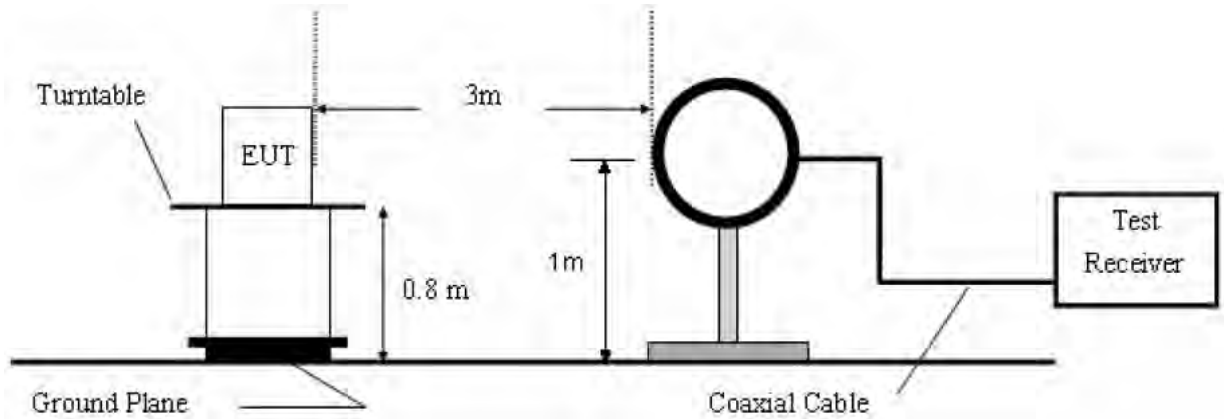

4.6.2.2. 30M to 1G emissions:

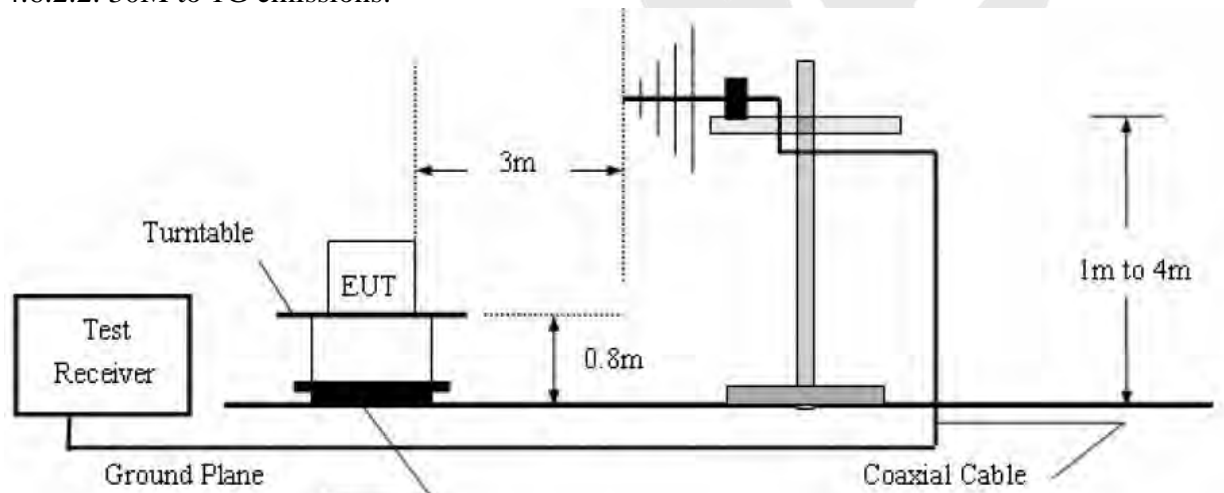

4.6.2.3. 1G to 40G emissions:

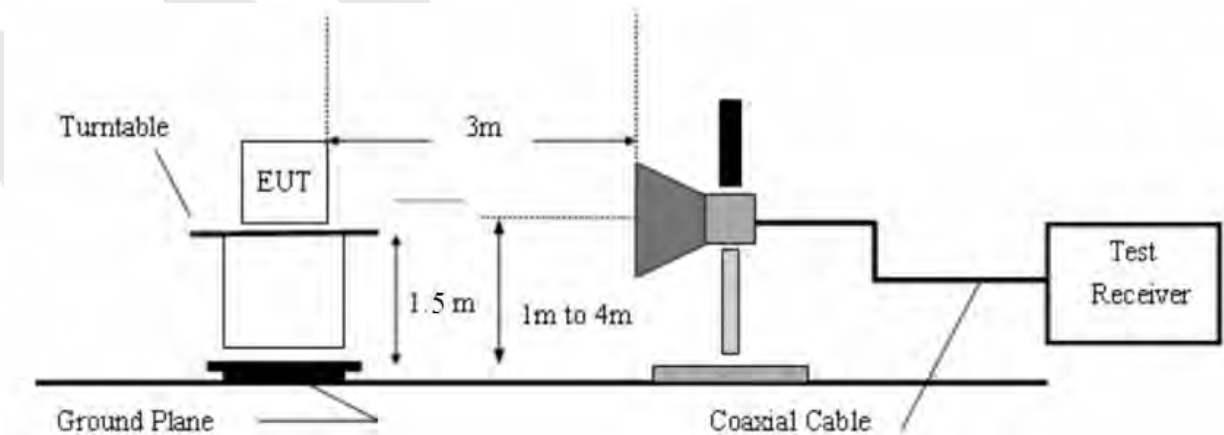

4.6.3. Test Procedure

The EUT is placed on a turn table which is 0.8 meter high above the ground. The turn table can rotate 360 degrees to determine the position of the maximum emission level. The EUT is set 3 meters away from the receiving antenna which is mounted on a antenna tower. The antenna can be moved up and down from 1 to 4 meters to find out the maximum emission level. Both horizontal and vertical polarization of the antenna are set on test.

Measurements are made on 9KHz to 30MHz and 30MHz to 26GHz range with the transmitter set to the lowest, middle, and highest channels.

All readings from 30MHz to 1GHz are quasi-peak values with a resolution bandwidth of 120kHz. All reading are above 1GHz, peak & average values with a resolution bandwidth of 1MHz.

The EUT is tested in 9*6*6 Chamber.

The test results are listed in Section 4.6.4.

4.6.4. Test Results

Please refer to the following pages.

Job No.:	011504578I	Polarization:	Horizontal
Standard:	(RE)FCC PART15 C _3m	Power Source:	AC 120V, 60Hz for host
Test item:	Radiation Test	Temp.(C)/Hum.(%RH):	24.3(C)/55%RH
Test Mode:	On	Distance:	3m

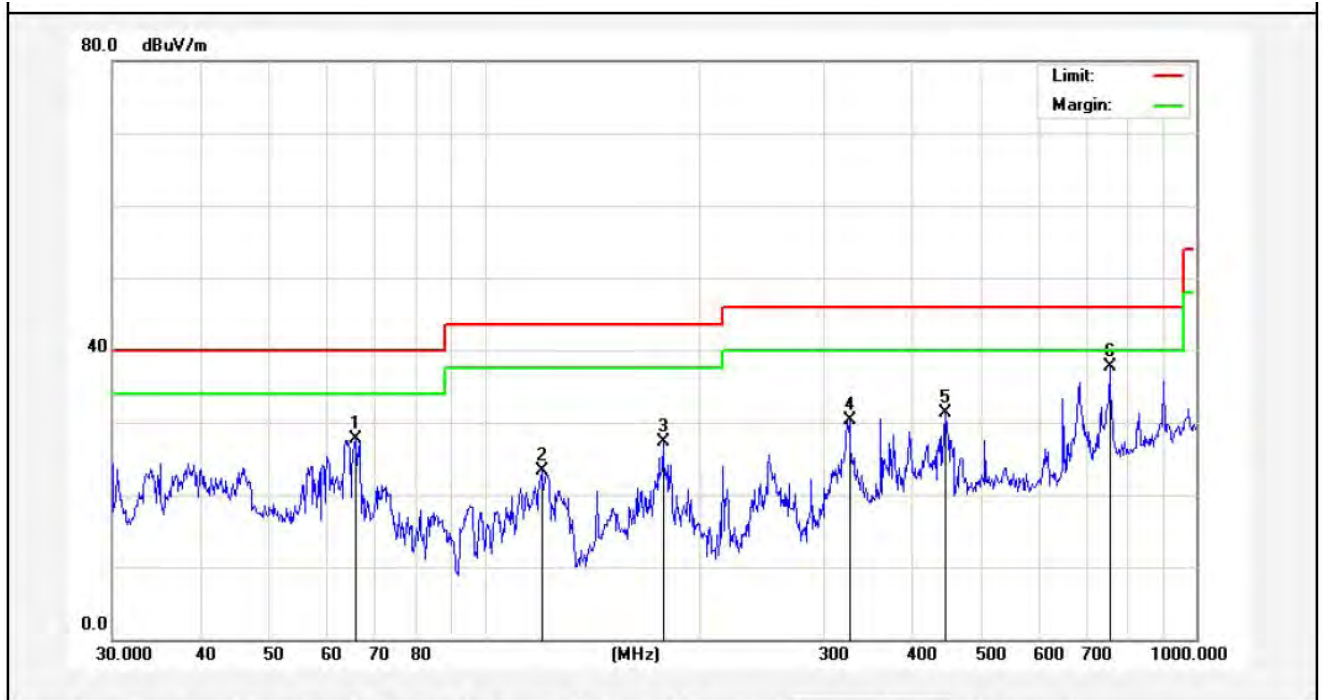

No.	Freq. (MHz)	Reading (dBuV/m)	Factor (dB/m)	Result (dBuV/m)	Limit (dBuV/)	Over Limit (dB)	Detector	Height (cm)	degree (deg)	Remark
1	65.8031	45.53	-17.81	27.72	40.00	-12.28	peak			
2	120.2766	44.67	-21.37	23.30	43.50	-20.20	peak			
3	178.1327	49.31	-21.98	27.33	43.50	-16.17	peak			
4	325.5958	45.26	-14.99	30.27	46.00	-15.73	peak			
5	444.8514	43.46	-12.18	31.28	46.00	-14.72	peak			
6	755.3873	45.06	-7.41	37.65	46.00	-8.35	peak			

Job No.:	011504578I	Polarization:	Vertical
Standard:	(RE)FCC PART15 C_3m	Power Source:	AC 120V, 60Hz for host
Test item:	Radiation Test	Temp.(C)/Hum.(%RH):	24.3(C)/55%RH
Test Mode:	On	Distance:	3m



No.	Freq. (MHz)	Reading (dBuV/m)	Factor (dB/m)	Result (dBuV/m)	Limit (dBuV/)	Over Limit (dB)	Detector	Height (cm)	degree (deg)	Remark
1	30.2111	49.40	-16.84	32.56	40.00	-7.44	QP	100	360	
2	34.2673	43.47	-14.68	28.79	40.00	-11.21	QP	100	0	
3	175.6516	51.09	-17.16	33.93	43.50	-9.57	peak			
4	682.3484	48.06	-8.61	39.45	46.00	-6.55	peak			
5	755.3873	42.50	-6.85	35.65	46.00	-10.35	QP	100	360	
6	906.4824	39.34	-3.66	35.68	46.00	-10.32	QP	100	0	

Job No.:	011504578I	Polarization:	Horizontal
Standard:	(RE)FCC PART15 C _3m	Power Source:	AC 120V, 60Hz for host
Test item:	Radiation Test	Temp.(C)/Hum.(%RH):	24.3(C)/55%RH
Note:	802.11b(2412MHz)	Distance:	3m

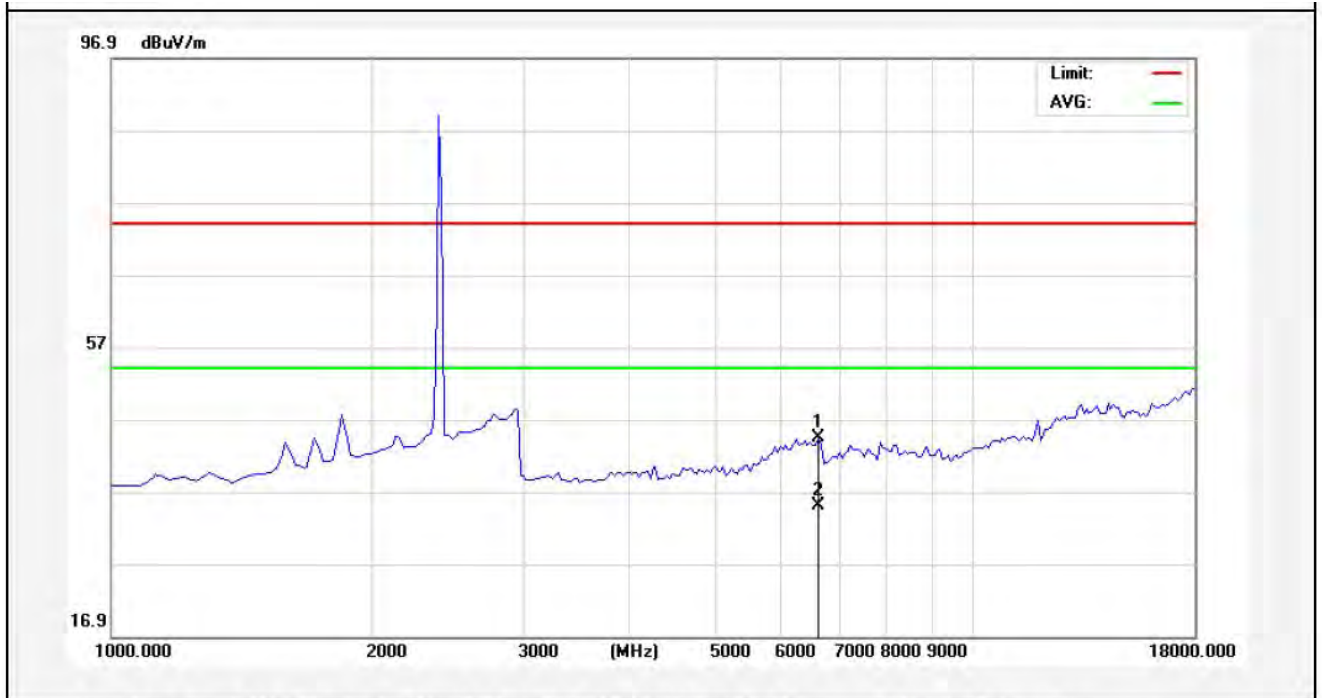

No.	Freq. (MHz)	Reading (dBuV/m)	Factor (dB/m)	Result (dBuV/m)	Limit (dBuV/)	Over Limit (dB)	Detector	Height (cm)	degree (deg)	Remark
1	6610.000	36.74	7.73	44.47	74.00	-29.53	peak			
2	6610.000	27.22	7.73	34.95	54.00	-19.05	AVG			

AM

Job No.:	011504578I	Polarization:	Vertical
Standard:	(RE)FCC PART15 C _3m	Power Source:	AC 120V, 60Hz for host
Test item:	Radiation Test	Temp.(C)/Hum.(%RH):	24.3(C)/55%RH
Note:	802.11b(2412MHz)	Distance:	3m

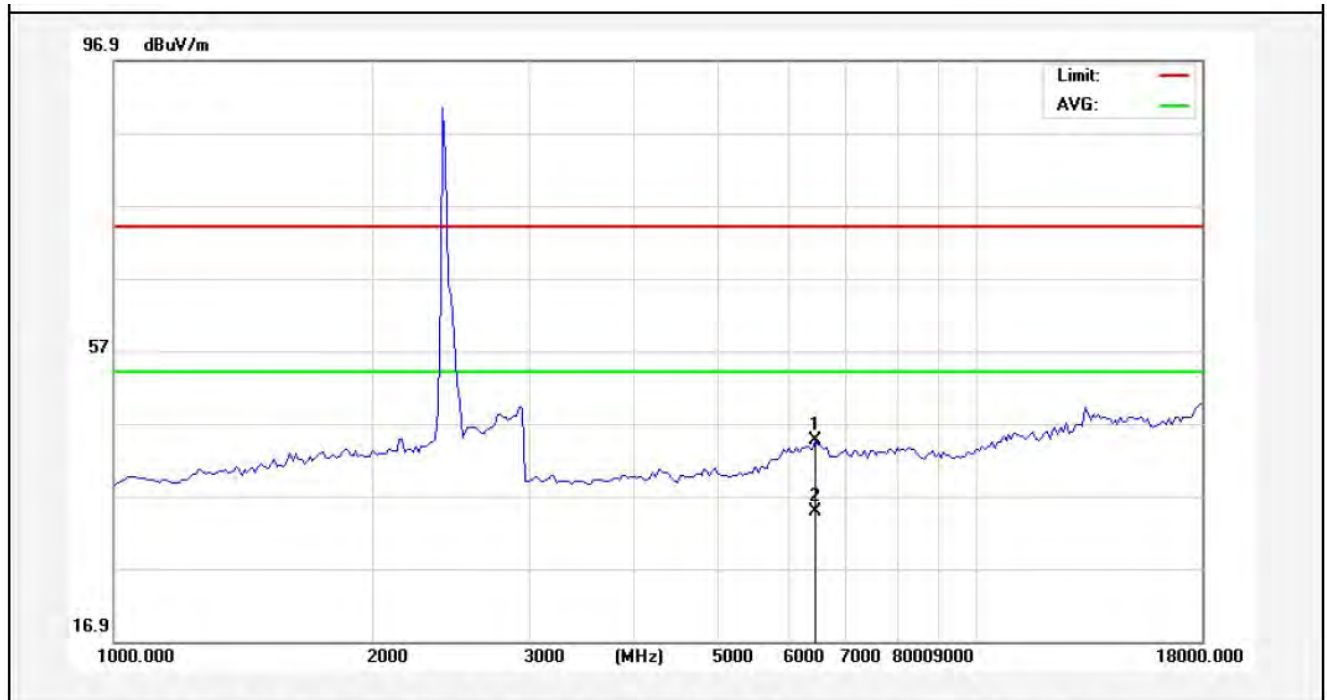

No.	Freq. (MHz)	Reading (dBuV/m)	Factor (dB/m)	Result (dBuV/m)	Limit (dBuV/)	Over Limit (dB)	Detector	Height (cm)	degree (deg)	Remark
1	6482.500	36.97	7.58	44.55	74.00	-29.45	peak			
2	6482.500	27.26	7.58	34.84	54.00	-19.16	AVG			

AAMI

Job No.:	011504578I	Polarization:	Horizontal
Standard:	(RE)FCC PART15 C_3m	Power Source:	AC 120V, 60Hz for host
Test item:	Radiation Test	Temp.(C)/Hum.(%RH):	24.3(C)/55%RH
Note:	802.11b(2437MHz)	Distance:	3m

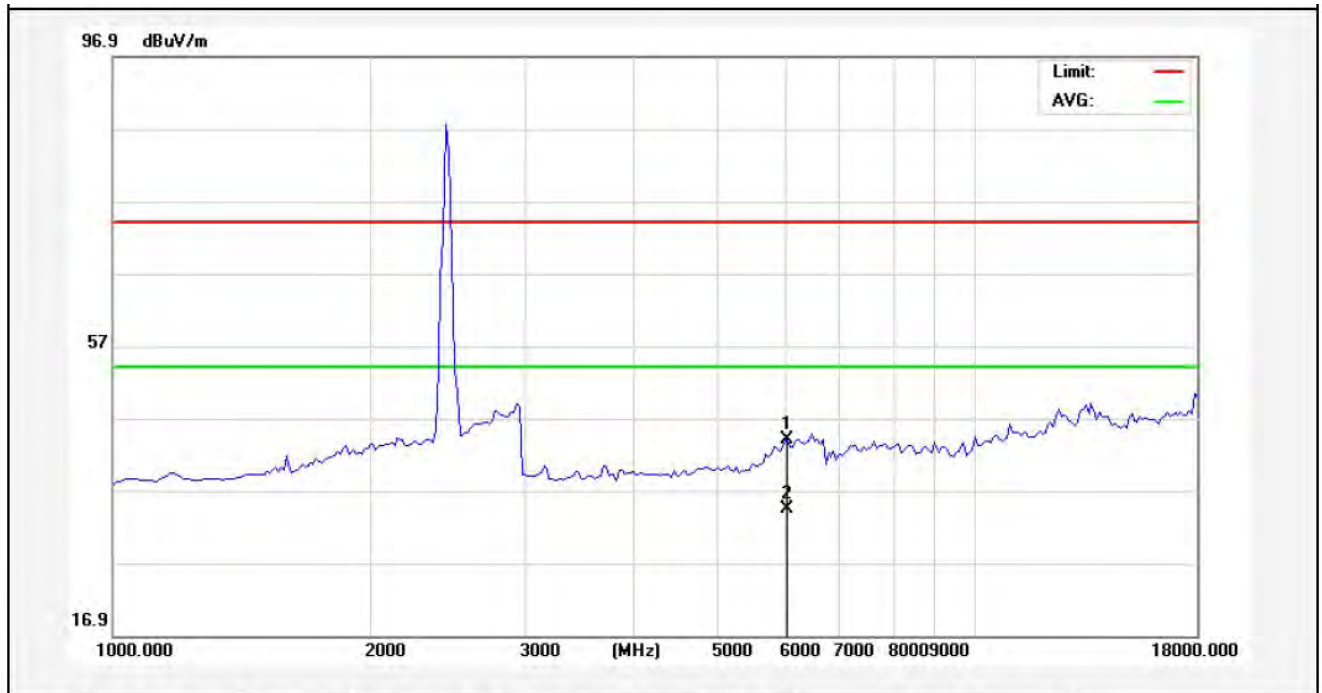

No.	Freq. (MHz)	Reading (dBuV/m)	Factor (dB/m)	Result (dBuV/m)	Limit (dBuV/)	Over Limit (dB)	Detector	Height (cm)	degree (deg)	Remark
1	6057.500	36.85	7.18	44.03	74.00	-29.97	peak			
2	6057.500	27.14	7.18	34.32	54.00	-19.68	AVG			

AEM

Job No.:	011504578I	Polarization:	Vertical
Standard:	(RE)FCC PART15 C_3m	Power Source:	AC 120V, 60Hz for host
Test item:	Radiation Test	Temp.(C)/Hum.(%RH):	24.3(C)/55%RH
Note:	802.11b(2437MHz)	Distance:	3m

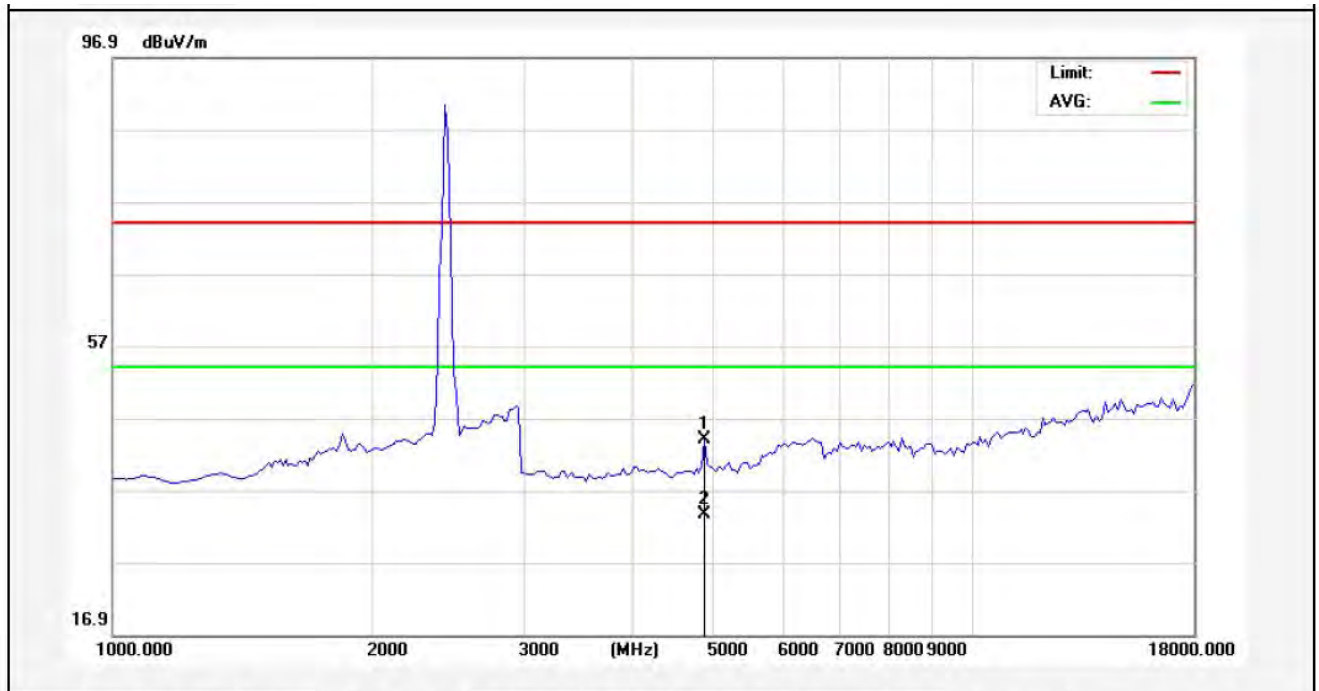

No.	Freq. (MHz)	Reading (dBuV/m)	Factor (dB/m)	Result (dBuV/m)	Limit (dBuV/)	Over Limit (dB)	Detector	Height (cm)	degree (deg)	Remark
1	4867.500	40.54	3.41	43.95	74.00	-30.05	peak			
2	4867.500	30.11	3.41	33.52	54.00	-20.48	AVG			

AEM

Job No.:	011504578I	Polarization:	Horizontal
Standard:	(RE)FCC PART15 C_3m	Power Source:	AC 120V, 60Hz for host
Test item:	Radiation Test	Temp.(C)/Hum.(%RH):	24.3(C)/55%RH
Note:	802.11b(2462MHz)	Distance:	3m

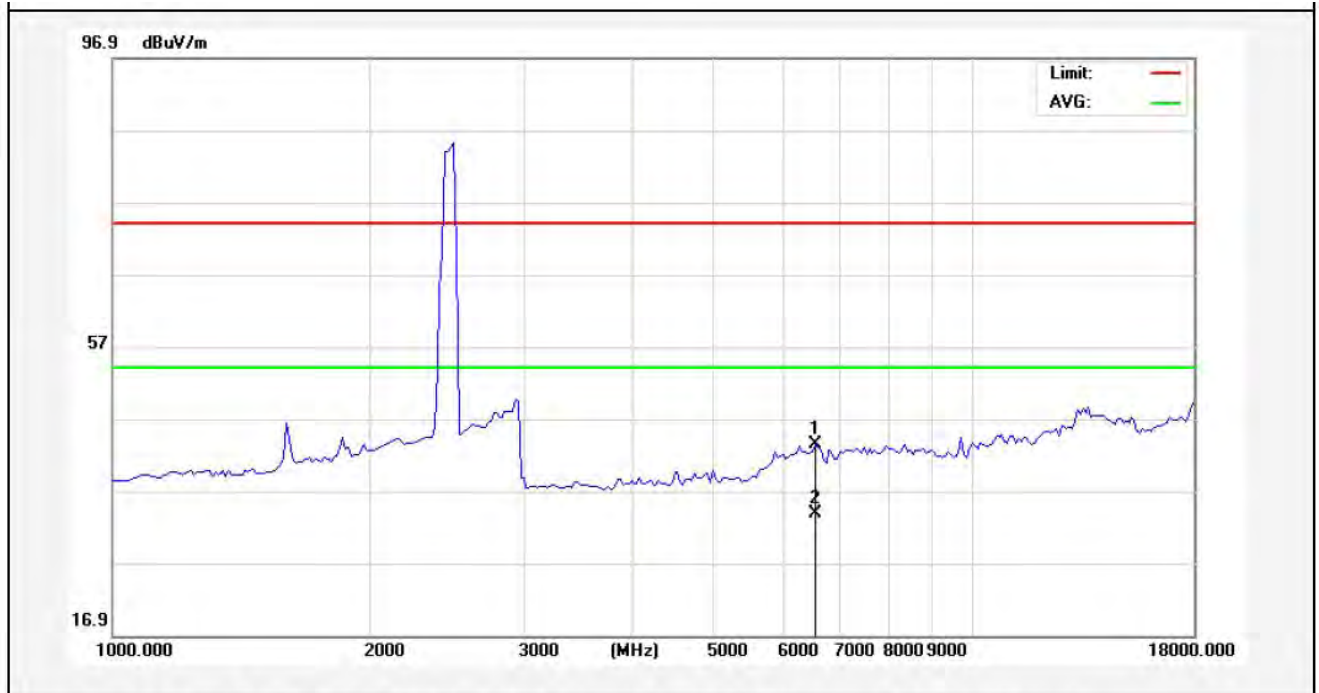

No.	Freq. (MHz)	Reading (dBuV/m)	Factor (dB/m)	Result (dBuV/m)	Limit (dBuV/)	Over Limit (dB)	Detector	Height (cm)	degree (deg)	Remark
1	6567.500	35.82	7.68	43.50	74.00	-30.50	peak			
2	6567.500	26.17	7.68	33.85	54.00	-20.15	AVG			

AM

Job No.:	011504578I	Polarization:	Vertical
Standard:	(RE)FCC PART15 C_3m	Power Source:	AC 120V, 60Hz for host
Test item:	Radiation Test	Temp.(C)/Hum.(%RH):	24.3(C)/55%RH
Note:	802.11b(2462MHz)	Distance:	3m

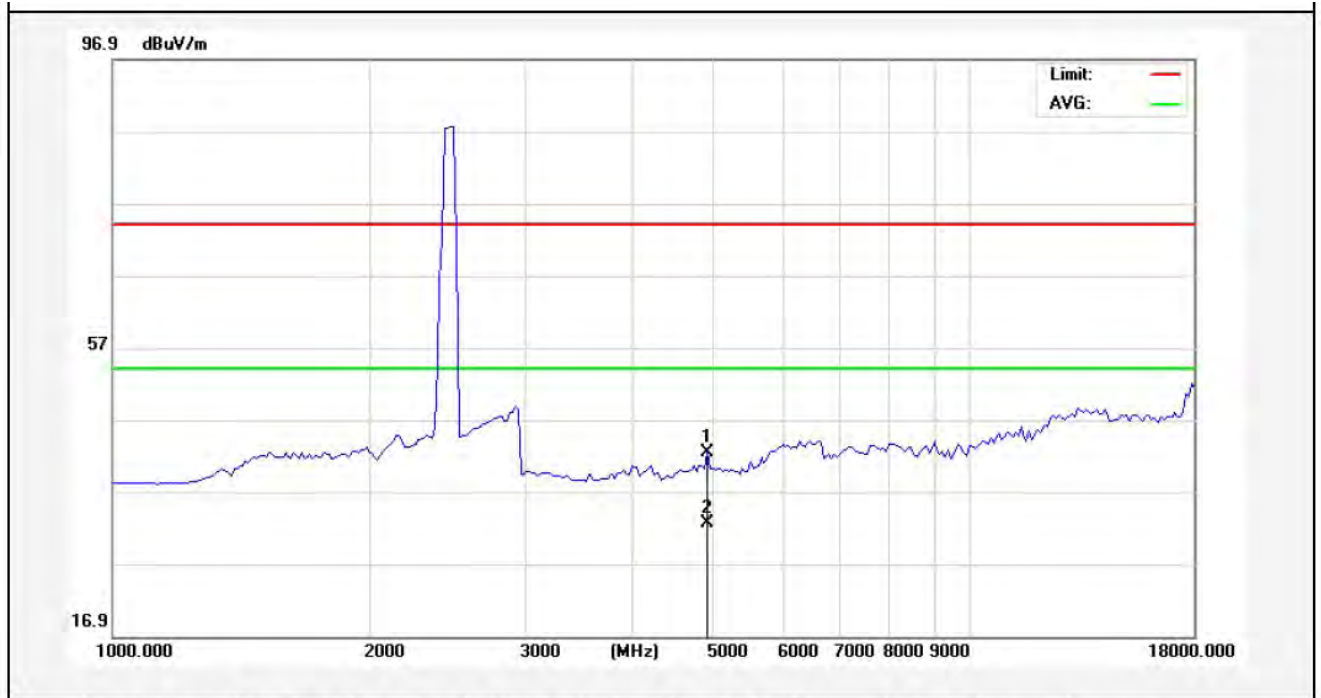

No.	Freq. (MHz)	Reading (dBuV/m)	Factor (dB/m)	Result (dBuV/m)	Limit (dBuV/)	Over Limit (dB)	Detector	Height (cm)	degree (deg)	Remark
1	4910.000	38.84	3.49	42.33	74.00	-31.67	peak			
2	4910.000	29.02	3.49	32.51	54.00	-21.49	AVG			

AAMI

5. ANTENNA APPLICATION

5.1. Antenna requirement

The EUT'S antenna is met the requirement of FCC part 15C section 15.203.

An intentional radiator shall be designed to ensure that no antenna other than that furnished by the responsible party shall be used with the device. The use of a permanently attached antenna or of an antenna that uses a unique coupling to the intentional radiator shall be considered sufficient to comply with the provisions of this section. The manufacturer may design the unit so that a broken antenna can be replaced by the user, but the use of a standard antenna jack or electrical connector is prohibited. This requirement does not apply to carrier current devices or to devices operated under the provisions of §15.211, §15.213, §15.217, §15.219, or §15.221. Further, this requirement does not apply to intentional radiators that must be professionally installed, such as perimeter protection systems and some field disturbance sensors, or to other intentional radiators which, in accordance with §15.31(d), must be measured at the installation site. However, the installer shall be responsible for ensuring that the proper antenna is employed so that the limits in this part are not exceeded.

5.2. Result

The EUT's antenna used a external antenna which is permanently attached, The antenna's gain is 2.5dBi and meets the requirement.



6. PHOTOGRAPH

6.1. Photo of Conducted Emission Measurement



6.2. Photo of Radiation Emission Test



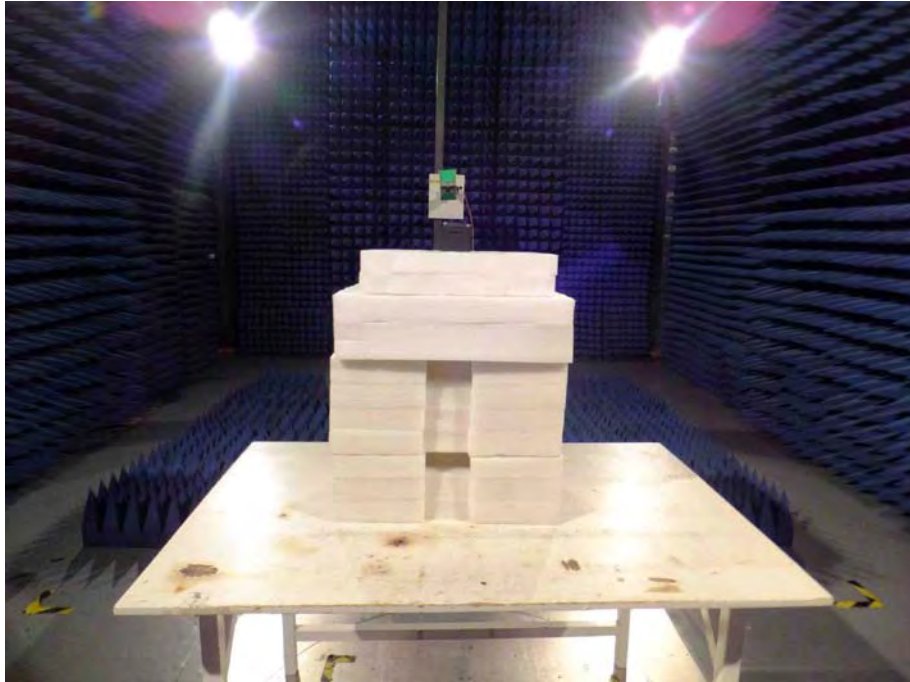

Anbotek

APPENDIX I (EXTERNAL PHOTOS)

Figure 1
The Host-Front View



Figure 2
The Host-Back View

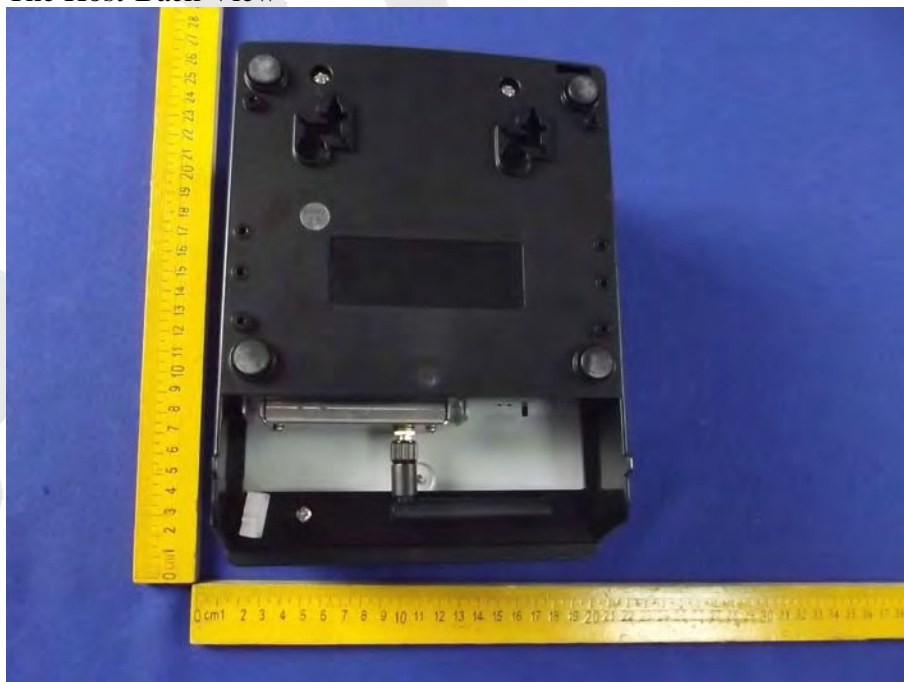

Figure 3
The Host-Side View



Figure 4
The Host-Inside View



Figure 5
The Host With EUT View



Figure 6
The EUT-Front View



Figure 7
The EUT-Back View



APPENDIX II (INTERNAL PHOTOS)

Figure 8
The EUT-Inside View

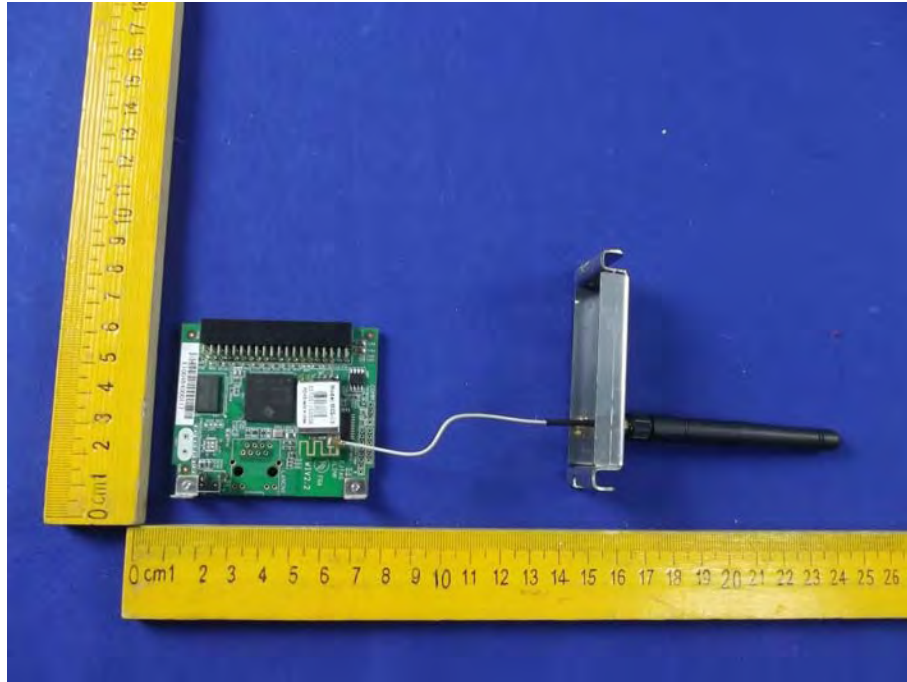

Figure 9
PCB of the EUT-Front View

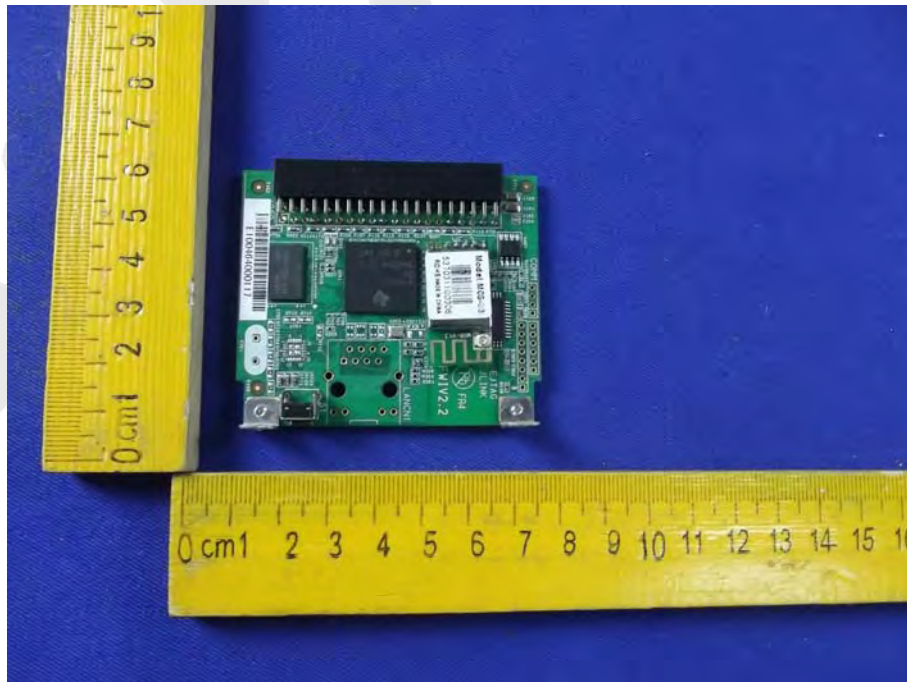

Figure 10
PCB of the EUT-Back View

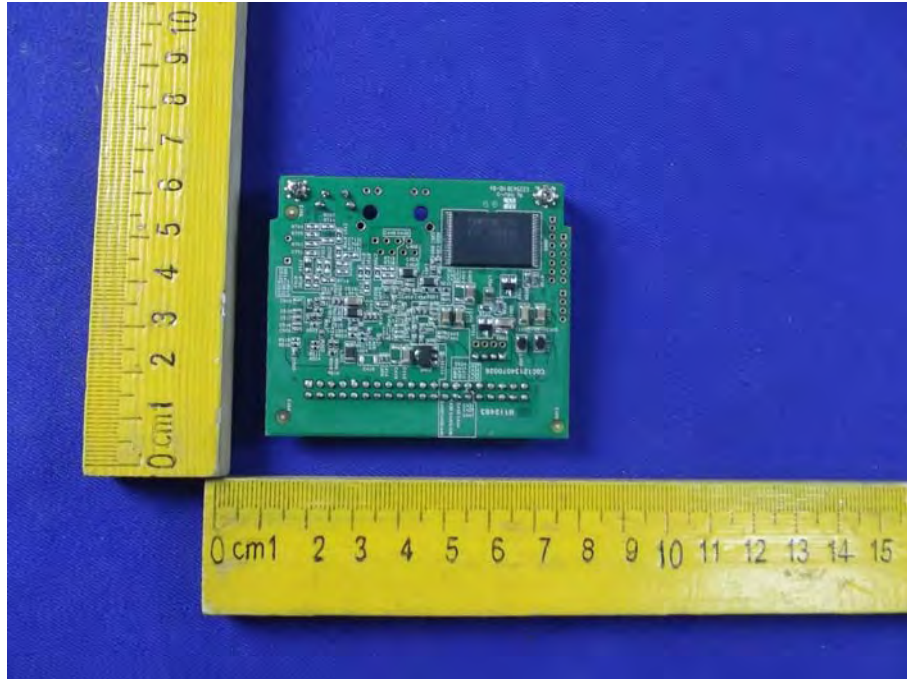

Figure 11
PCB of the EUT-Front View

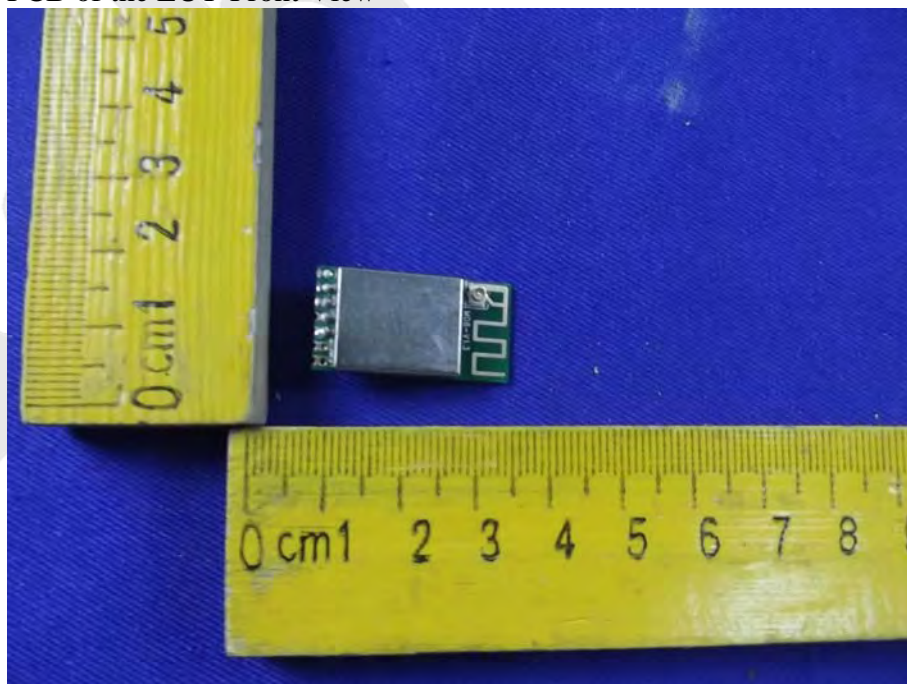

Figure 12
PCB of the EUT-Back View

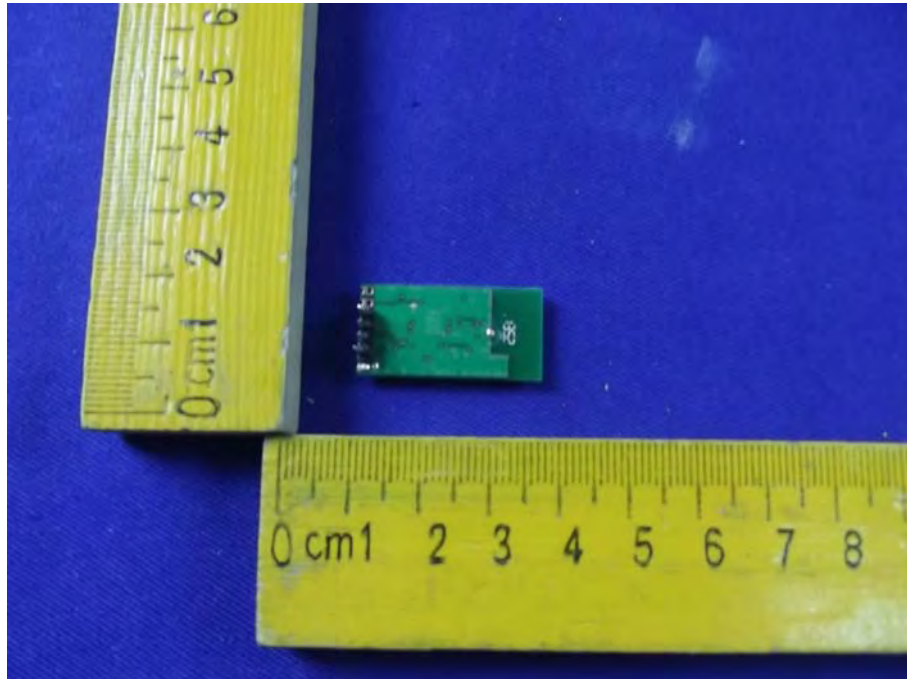

Figure 13
PCB of the EUT-Front View

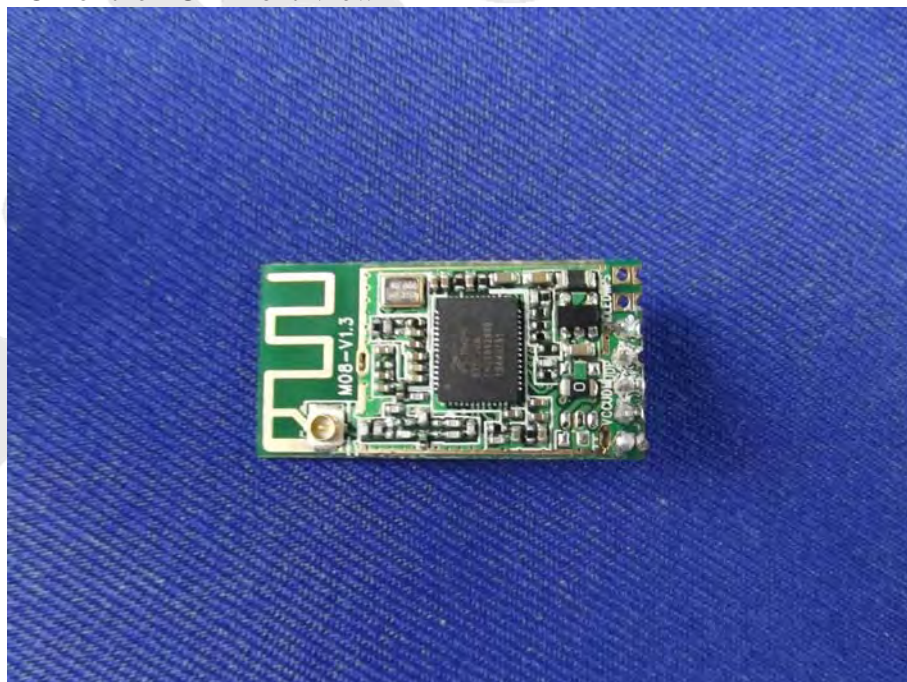
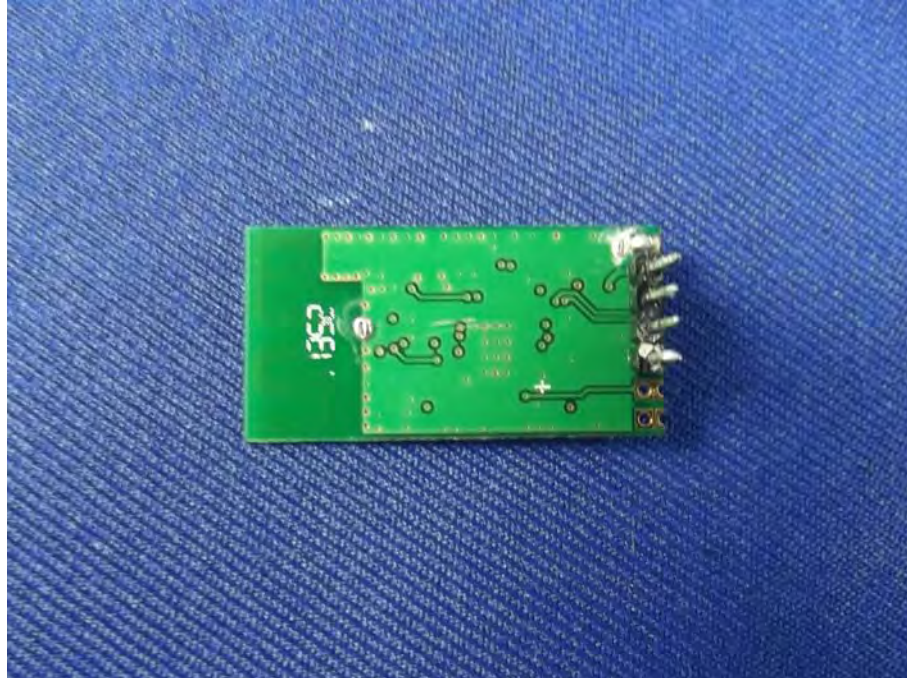

Figure 14
PCB of the EUT-Back View



Anbotek