

TEST REPORT (DFS)

Reference No...... : WTD22D03048052W008
FCC ID : 2AEPISILVERMAXLITE2
Applicant..... : COLOMBIANA DE COMERCIO S.A.
Address..... : Car. 43E No 8-71, Medellin, Colombia
Manufacturer : COOSEA GROUP (HK) COMPANY LIMITED LIMITED
Address..... : UNIT 5-6,16F.,MULTIFIELD PLAZA 3-7A PRAT AVENUE TSIM
SHA TSUI KL, HONG KONG
Product..... : Smartphone
Model(s) : Silver Max Lite 2
Brand Name..... : Kalley
Standards..... : FCC CFR47 Part 15.407
Date of Receipt sample : 2022-03-21
Date of Test : 2022-04-13 to 2022-04-14
Date of Issue..... : 2022-04-14
Test Result..... : **Pass**

Remarks:

The results shown in this test report refer only to the sample(s) tested, this test report cannot be reproduced, except in full, without prior written permission of the company. The report would be invalid without specific stamp of test institute and the signatures of compiler and approver.

Prepared By:

Waltek Testing Group Co., Ltd.

Address: No. 77, Houjie Section, Guantai Road, Houjie Town, Dongguan City, Guangdong, China

Tel: +86-769-2267 6998

Fax: +86-769-2267 6828

Compiled by:



Andy Feng / Project Engineer

Approved by:

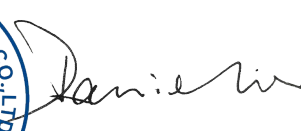

Daniel Liu / Designated Reviewer

2 Contents

	Page
1 COVER PAGE	1
2 CONTENTS	2
3 REVISION HISTORY	3
4 GENERAL INFORMATION.....	4
4.1 GENERAL DESCRIPTION OF E.U.T.	4
4.2 DETAILS OF E.U.T.....	4
4.3 FREQUENCY LIST TABLE.....	4
4.4 TEST FACILITY.....	5
5 TEST SUMMARY	7
6 EQUIPMENT USED DURING TEST	8
6.1 EQUIPMENTS LIST	8
7 DFS OVERVIEW	9
7.1 MASTER DEVICES	10
7.2 CLIENT DEVICES	10
8 DFS TECHNICAL REQUIREMENTS SPECIFICATIONS.....	11
8.1 DFS DETECTION THRESHOLDS	11
8.2 RESPONSE REQUIREMENTS	11
9 RADAR TEST WAVEFORMS	12
9.1 SHORT PULSE RADAR TEST WAVEFORMS.....	12
9.2 LONG PULSE RADAR TEST WAVEFORM	12
9.3 FREQUENCY HOPPING RADAR TEST WAVEFORM.....	13
10 RADAR WAVEFORM CALIBRATION.....	14
11 TEST PROCEDURE.....	21
11.1 IN-SERVICE MONITORING FOR CHANNEL MOVE TIME, CHANNEL CLOSING TRANSMISSION TIME AND NON-OCCUPANCY PERIOD.....	21
11.2 DFS SETUP.....	22
12 TEST RESULTS	23
12.1 CHANNEL SHUTDOWN	23
12.2 NON-OCCUPANCY PERIOD.....	27
13 PHOTOGRAPHS —TEST SETUP.....	29
13.1 PHOTOGRAPH - DFS.....	29

3 Revision History

Test report No.	Date of Receipt sample	Date of Test	Date of Issue	Purpose	Comment	Approved
WTD22D03048 052W008	2022-03-21	2022-04-13 to 2022-04-14	2022-04-14	original	-	Valid

4 General Information

4.1 General Description of E.U.T.

Product:	Smartphone
Model(s):	Silver Max Lite 2
Model Description:	N/A
GSM Band(s):	GSM 850/900/1800/1900MHz
GPRS/EGPRS Class:	12
WCDMA Band(s):	FDD Band II/V
LTE Band(s):	FDD Band 4/7
Wi-Fi Specification:	2.4G-802.11b/g/n HT20/n HT40 5G-802.11a/ n(HT20/40)/ac(HT20/40/80)
Bluetooth Version:	Bluetooth v5.0 with BLE
GPS:	Support
NFC:	N/A
Hardware Version:	KE2S_01
Software Version:	Kally_SM_LITE_2_V01_20220225
Highest frequency (Exclude Radio):	1.8GHz
Storage Location:	Internal Storage
Note:	N/A

4.2 Details of E.U.T.

Ratings:	Battery DC 3.85V, 4900mAh DC 5V, 1.55A, charging from adapter (Adapter Input: 100-240V~50/60Hz 0.25A)
Adapter:	Manufacturer: Guangdong Beicom Electronics Co.,Ltd Model No.: U282F0A050155

4.3 Frequency list table

Type	Frequency Range(MHz)	Channel No.	Frequency(MHz)	Availabel(Y/N)
802.11a/n-HT20	5260-5320	52	5260	<input checked="" type="checkbox"/>
		56	5280	<input type="checkbox"/>
		60	5300	<input type="checkbox"/>
		64	5320	<input type="checkbox"/>
	5500-5700	100	5500	<input checked="" type="checkbox"/>

		104	5520	<input type="checkbox"/>
		108	5540	<input type="checkbox"/>
		112	5560	<input type="checkbox"/>
		116	5580	<input type="checkbox"/>
		120	5600	<input type="checkbox"/>
		124	5620	<input type="checkbox"/>
		128	5640	<input type="checkbox"/>
		132	5660	<input type="checkbox"/>
		136	5680	<input type="checkbox"/>
		140	5700	<input type="checkbox"/>
			5745-5795	149
153	5765			<input type="checkbox"/>
157	5785			<input type="checkbox"/>
161	5805			<input type="checkbox"/>
165	5825			<input type="checkbox"/>
802.11n/ac HT40	5270-5310	54	5270	<input type="checkbox"/>
		62	5310	<input checked="" type="checkbox"/>
	5510-5670	102	5510	<input type="checkbox"/>
		110	5550	<input type="checkbox"/>
		118	5590	<input type="checkbox"/>
		126	5630	<input type="checkbox"/>
	5755-5795	134	5670	<input type="checkbox"/>
		151	5755	<input type="checkbox"/>
		159	5795	<input type="checkbox"/>
802.11n/ac-HT80	5290	58	5290	<input type="checkbox"/>
	5530,5610	106	5530	<input type="checkbox"/>
		122	5610	<input type="checkbox"/>
	5775	155	5775	<input type="checkbox"/>

4.4 Test Facility

The test facility has a test site registered with the following organizations:

ISED CAB identifier: CN0013. Test Firm Registration No.: 7760A.

Waltek Testing Group Co., Ltd. Has been registered and fully described in a report filed with the Industry Canada. The acceptance letter from the Industry Canada is maintained in our files.

Registration number 7760A, October 15, 2016.

FCC Designation No.: CN1201. Test Firm Registration No.: 523476.

Waltek Testing Group Co., Ltd. EMC Laboratory has been registered and fully described in a report filed with the (FCC) Federal Communications Commission. The acceptance letter from the FCC is maintained in our files. Registration number 523476, September 10, 2019.

5 Test Summary

Test Item	Test Requirement	Result
Non-Occupancy Period	15.407(h)	PASS
DFS Detection Threshold	15.407(h)	N/A
Channel Availability Check Time	15.407(h)	N/A
U-NII Detection Bandwidth	15.407(h)	N/A
Channel Closing Transmission Time	15.407(h)	PASS
Channel Move Time	15.407(h)	PASS
Statistical Performance Check	15.407(h)	N/A

Remark:

Note 1: N/A-Not Applicable

Note 2: DFS is not required for channels whose nominal bandwidth falls completely within the band 5 150 MHz to 5 250 MHz.

Note 3: Where implemented by the manufacturer.

RF: In this whole report RF means Radio Frequency.

A.M. Amplitude Modulation.

P.M. Pulse Modulation.

† D.M. – Differential Mode

U_T is the nominal supply voltage

6 Equipment Used during Test

6.1 Equipments List

Item	Equipment	Manufacturer	Model No.	Serial No.	Last Calibration Date	Calibration Due Date
1.	Signal Analyzer	Agilent	N9020A	/	2021-04-20	2022-04-19
2.	Signal Generator	Agilent	N5182A	/	2021-04-20	2022-04-19
3.	USB Wideband Power Sensor	Keysight	U2021XA	SG5440003	2021-04-20	2022-04-19
4	ESG VECTOR SIGNAL GENERATOR	Keysight	4438C	MY45092536 005506601U NJ	2021-04-20	2022-04-19
5	RF Path box	Yanchen	AT890-RFB	/	/	/

7 DFS Overview

A U-NII network will employ a DFS function to detect signals from radar systems and to avoid co-channel operation with these systems. This applies to the 5250-5350 MHz and/or 5470-5725 MHz bands.¹

Within the context of the operation of the DFS function, a U-NII device will operate in either Master Mode or Client Mode. U-NII devices operating in Client Mode can only operate in a network controlled by a U-NII device operating in Master Mode.²

Tables 1 and 2 shown below summarize the information contained in sections 5.1.1 and 5.1.2

Table 1: Applicability of DFS Requirements Prior to Use of a Channel

Requirement	Operational Mode		
	Master	Client Without Radar Detection	Client With Radar Detection
Non-Occupancy Period	Yes	Not required	Yes
DFS Detection Threshold	Yes	Not required	Yes
Channel Availability Check Time	Yes	Not required	Not required
U-NII Detection Bandwidth	Yes	Not required	Yes

Table 2: Applicability of DFS requirements during normal operation

Requirement	Operational Mode	
	Master Device or Client with Radar Detection	Client Without Radar Detection
DFS Detection Threshold	Yes	Not required
Channel Closing Transmission Time	Yes	Yes
Channel Move Time	Yes	Yes
U-NII Detection Bandwidth	Yes	Not required

Additional requirements for devices with multiple bandwidth modes	Master Device or Client with Radar Detection	Client Without Radar Detection
U-NII Detection Bandwidth and Statistical Performance Check	All BW modes must be tested	Not required
Channel Move Time and Channel Closing Transmission Time	Test using widest BW mode available	Test using the widest BW mode available for the link
All other tests	Any single BW mode	Not required
Note: Frequencies selected for statistical performance check (Section 7.8.4) should include several frequencies within the radar detection bandwidth and frequencies near the edge of the radar detection bandwidth. For 802.11 devices it is suggested to select frequencies in each of the bonded 20 MHz channels and the channel center frequency.		

The operational behavior and individual DFS requirements that are associated with these modes are as follows:

7.1 Master Devices

- a) The Master Device will use DFS in order to detect Radar Waveforms with received signal strength above the DFS Detection Threshold in the 5250 – 5350 MHz and 5470 – 5725 MHz bands. DFS is not required in the 5150 – 5250 MHz or 5725 – 5825 MHz bands.
- b) Before initiating a network on a Channel, the Master Device will perform a Channel Availability Check for a specified time duration (Channel Availability Check Time) to ensure that there is no radar system operating on the Channel, using DFS described under subsection a) above.
- c) The Master Device initiates a U-NII network by transmitting control signals that will enable other U-NII devices to Associate with the Master Device.
- d) During normal operation, the Master Device will monitor the Channel (In-Service Monitoring) to ensure that there is no radar system operating on the Channel, using DFS described under a).
- e) If the Master Device has detected a Radar Waveform during In-Service Monitoring as described under d), the Operating Channel of the U-NII network is no longer an Available Channel. The Master Device will instruct all associated Client Device(s) to stop transmitting on this Channel within the Channel Move Time. The transmissions during the Channel Move Time will be limited to the Channel Closing Transmission Time.
- f) Once the Master Device has detected a Radar Waveform it will not utilize the Channel for the duration of the Non-Occupancy Period. 3
- g) If the Master Device delegates the In-Service Monitoring to a Client Device, then the combination will be tested to the requirements described under d) through f) above.

7.2 Client Devices

- a) A Client Device will not transmit before having received appropriate control signals from a Master Device.
- b) A Client Device will stop all its transmissions whenever instructed by a Master Device to which it is associated and will meet the Channel Move Time and Channel Closing Transmission Time requirements. The Client Device will not resume any transmissions until it has again received control signals from a Master Device.
- c) If a Client Device is performing In-Service Monitoring and detects a Radar Waveform above the DFS Detection Threshold, it will inform the Master Device. This is equivalent to the Master Device detecting the Radar Waveform and d) through f) of section 5.1.1 apply.
- d) Irrespective of Client Device or Master Device detection the Channel Move Time and Channel Closing Transmission Time requirements remain the same.
- e) The client test frequency must be monitored to ensure no transmission of any type has occurred for 30 minutes. Note: If the client moves with the master, the device is considered compliant if nothing appears in the client non-occupancy period test. For devices that shut down (rather than moving channels), no beacons should appear.

8 DFS technical requirements specifications

8.1 DFS Detection Thresholds

Table 3 below provides the *DFS Detection Thresholds* for *Master Devices* as well as *Client Devices* incorporating *In-Service Monitoring*. NOTE: For devices that support multiple Nominal Channel Bandwidths, the Channel Availability Check

Table 3: DFS Detection Thresholds for Master Devices and Client Devices with Radar Detection

Maximum Transmit Power	Value (See Notes 1, 2, and 3)
EIRP \geq 200 milliwatt	-64 dBm
EIRP $<$ 200 milliwatt and power spectral density $<$ 10 dBm/MHz	-62 dBm
EIRP $<$ 200 milliwatt that do not meet the power spectral density requirement	-64 dBm
<p>Note 1: This is the level at the input of the receiver assuming a 0 dBi receive antenna.</p> <p>Note 2: Throughout these test procedures an additional 1 dB has been added to the amplitude of the test transmission waveforms to account for variations in measurement equipment. This will ensure that the test signal is at or above the detection threshold level to trigger a DFS response.</p> <p>Note3: EIRP is based on the highest antenna gain. For MIMO devices refer to KDB Publication 662911 D01.</p>	

8.2 Response Requirements

Table 4 provides the response requirements for Master and Client Devices incorporating DFS.

Table 4: DFS Response Requirement Values

Parameter	Value
Non-occupancy period	Minimum 30 minutes
Channel Availability Check Time	60 seconds
Channel Move Time	10 seconds See Note 1.
Channel Closing Transmission Time	200 milliseconds + an aggregate of 60 milliseconds over remaining 10 second period. See Notes 1 and 2.
U-NII Detection Bandwidth	Minimum 100% of the U-NII 99% transmission power bandwidth. See Note 3.
<p>Note 1: Channel Move Time and the Channel Closing Transmission Time should be performed with Radar Type 0. The measurement timing begins at the end of the Radar Type 0 burst.</p> <p>Note 2: The Channel Closing Transmission Time is comprised of 200 milliseconds starting at the beginning of the Channel Move Time plus any additional intermittent control signals required to facilitate a Channel move (an aggregate of 60 milliseconds) during the remainder of the 10 second period. The aggregate duration of control signals will not count quiet periods in between transmissions.</p> <p>Note 3: During the U-NII Detection Bandwidth detection test, radar type 0 should be used. For each frequency step the minimum percentage of detection is 90 percent. Measurements are performed with no data traffic.</p>	

9 RADAR TEST WAVEFORMS

This section provides the parameters for required test waveforms, minimum percentage of successful detections, and the minimum number of trials that must be used for determining DFS conformance. Step intervals of 0.1 microsecond for Pulse Width, 1 microsecond for PRI, 1 MHz for chirp width and 1 for the number of pulses will be utilized for the random determination of specific test waveforms.

9.1 Short Pulse Radar Test Waveforms

Table 5 – Short Pulse Radar Test Waveforms

Radar Type	Pulse Width (μsec)	PRI (μsec)	Number of Pulses	Minimum Percentage of Successful Detection	Minimum Number of Trials
1	1	1428	18	See Note 1	See Note 1
2	1-5	150-230	23-29	60%	30
3	6-10	200-500	16-18	60%	30
4	11-20	200-500	12-16	60%	30

Note 1: Short Pulse Radar Type 1 should be used for the detection bandwidth test, channel move time, and channel closing time tests.

9.2 Long Pulse Radar Test Waveform

Table 6 – Long Pulse Radar Test Waveform

Radar Type	Pulse Width (μsec)	Chirp Width (MHz)	PRI (μsec)	Number of Pulses per Burst	Number of Bursts	Minimum Percentage of Successful Detection	Minimum Number of Trials
5	50-100	5-20	1000-2000	1-3	8-20	80%	30

The parameters for this waveform are randomly chosen. Thirty unique waveforms are required for the Long Pulse Radar Type waveforms. If more than 30 waveforms are used for the Long Pulse Radar Type waveforms, then each additional waveform must also be unique and not repeated from the previous waveforms.

Each waveform is defined as follows:

- 1) The transmission period for the Long Pulse Radar test signal is 12 seconds.
- 2) There are a total of 8 to 20 Bursts in the 12 second period, with the number of Bursts being randomly chosen. This number is Burst Count.
- 3) Each Burst consists of 1 to 3 pulses, with the number of pulses being randomly chosen. Each Burst within the 12 second sequence may have a different number of pulses.

- 4) The pulse width is between 50 and 100 microseconds, with the pulse width being randomly chosen. Each pulse within a Burst will have the same pulse width. Pulses in different Bursts may have different pulse widths.
- 5) Each pulse has a linear frequency modulated chirp between 5 and 20 MHz, with the chirp width being randomly chosen. Each pulse within a transmission period will have the same chirp width. The chirp is centered on the pulse. For example, with a radar frequency of 5300 MHz and a 20 MHz chirped signal, the chirp starts at 5290 MHz and ends at 5310 MHz.
- 6) If more than one pulse is present in a Burst, the time between the pulses will be between 1000 and 2000 microseconds, with the time being randomly chosen. If three pulses are present in a Burst, the random time interval between the first and second pulses is chosen independently of the random time interval between the second and third pulses.
- 7) The 12 second transmission period is divided into even intervals. The number of intervals is equal to Burst Count. Each interval is of length $(12,000,000 / \text{Burst Count})$ microseconds. Each interval contains one Burst. The start time for the Burst, relative to the beginning of the interval, is between 1 and $[(12,000,000 / \text{Burst Count}) - (\text{Total Burst Length}) + (\text{One Random PRI Interval})]$ microseconds, with the start time being randomly chosen. The step interval for the start time is 1 microsecond. The start time for each Burst is chosen randomly.

9.3 Frequency Hopping Radar Test Waveform

Table 7 – Frequency Hopping Radar Test Waveform

Radar Type	Pulse Width (μsec)	PRI (μsec)	Pulses per Hop	Hopping Rate (kHz)	Hopping Sequence Length (msec)	Minimum Percentage of Successful Detection	Minimum Number of Trials
6	1	333	9	0.333	300	70%	30

For the Frequency Hopping Radar Type, the same Burst parameters are used for each waveform. The hopping sequence is different for each waveform and a 100-length segment is selected from the hopping sequence defined by the following algorithm: 4

The first frequency in a hopping sequence is selected randomly from the group of 475 integer frequencies from 5250 – 5724 MHz. Next, the frequency that was just chosen is removed from the group and is randomly selected from the remaining 474 frequencies in the group. This process continues until all are chosen for the set. For selection of a random frequency, the frequencies remaining within the group are treated as equally likely.

initial power up or at initial installation. Channels being used by other RLAN equipment may be omitted from the list of Usable Channels.

10 Radar Waveform Calibration

The following equipment setup was used to calibrate the conducted radar waveform. A spectrum analyzer was used to establish the test signal level for each radar type. During this process there were no transmissions by either the master or client device. The spectrum analyzer was switched to the zero spans (time domain) at the frequency of the radar waveform generator. Peak detection was utilized. The spectrum analyzer resolution bandwidth (RBW) and video bandwidth (VBW) were set to 1 MHz and 3 MHz. The signal generator amplitude was set so that the power level measured at the spectrum analyzer was -55dBm due to the interference threshold level is not required.

Conducted Calibration Setup

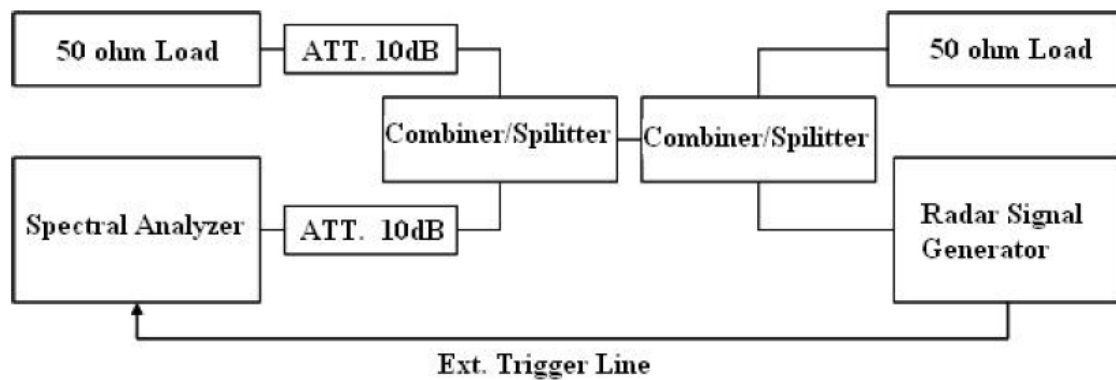

Calibration Test Plots As Below

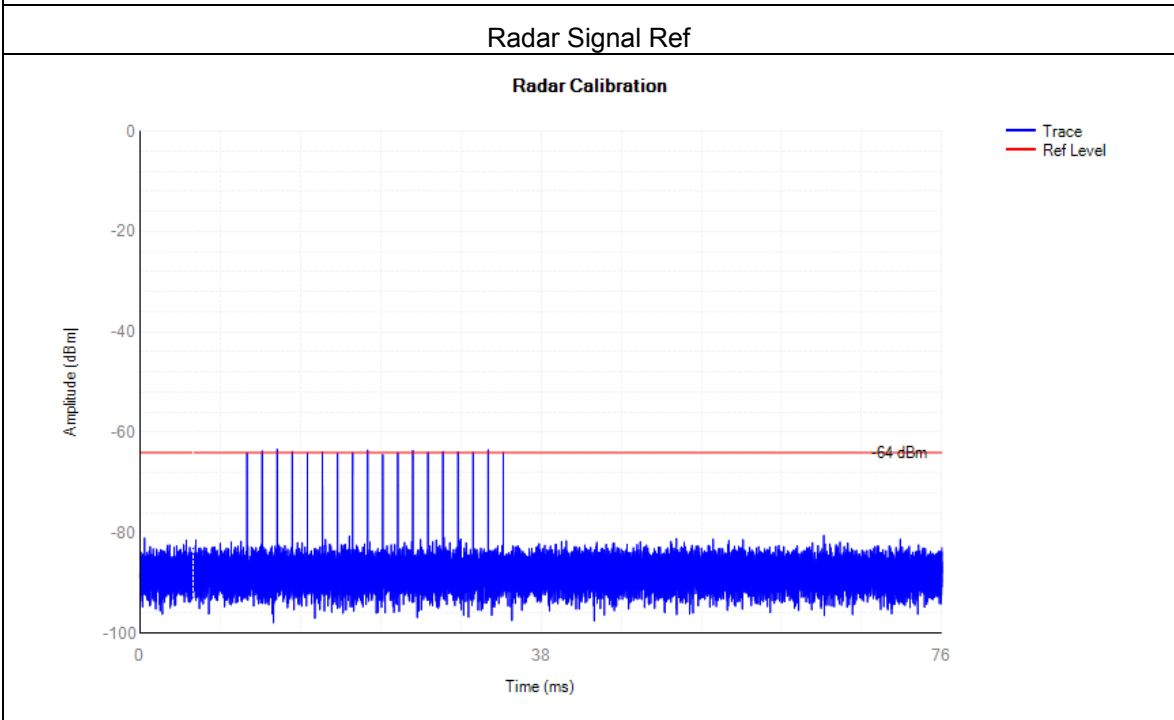
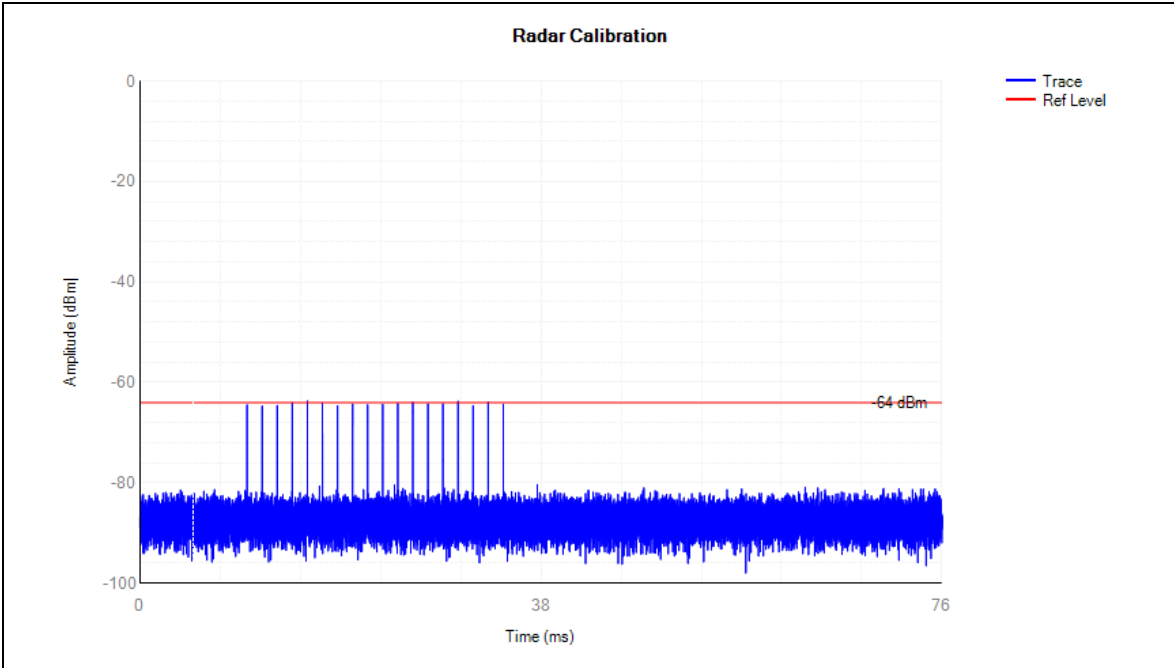

Radar Signal Type 1

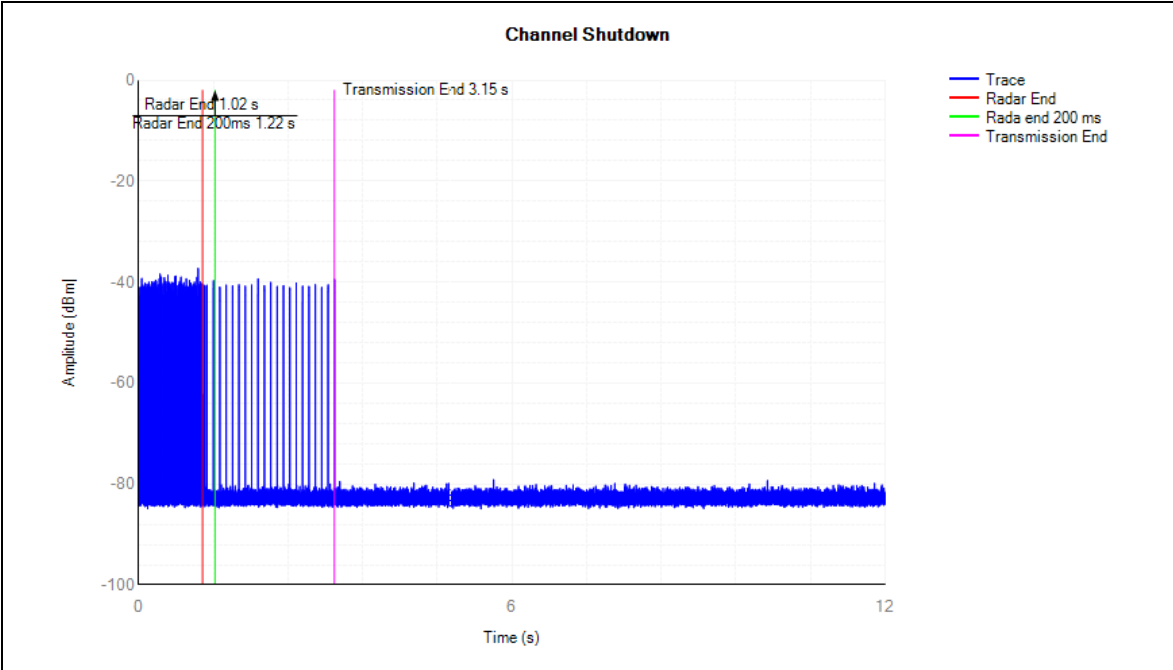

Radar Signal Type 2

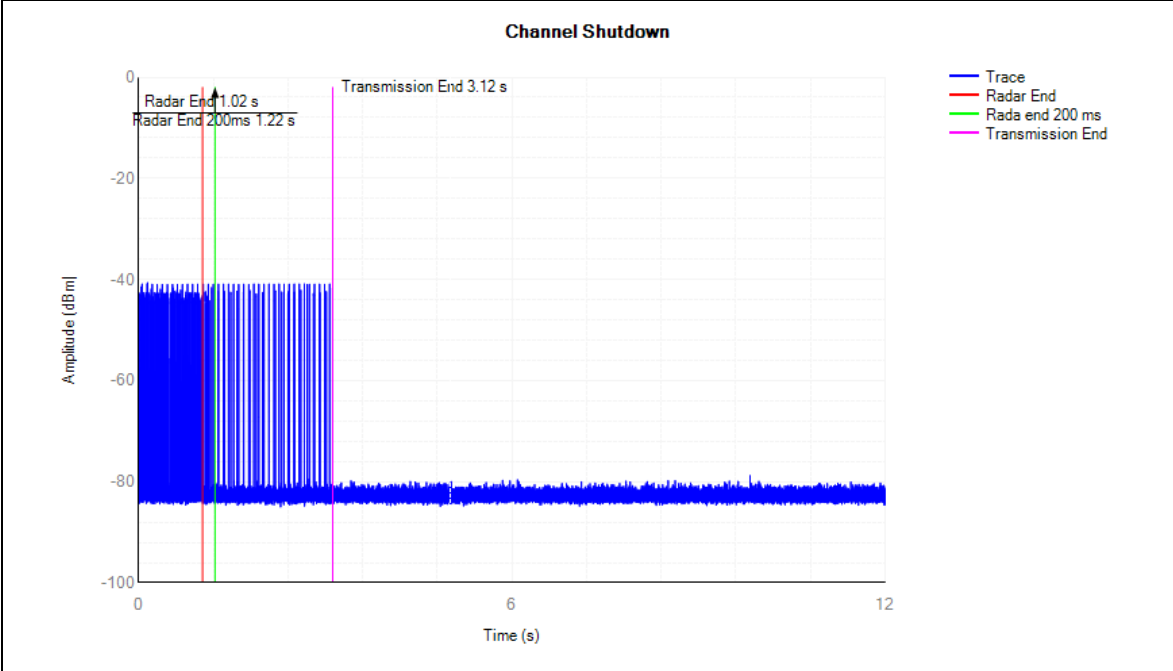

Radar Signal Type 3

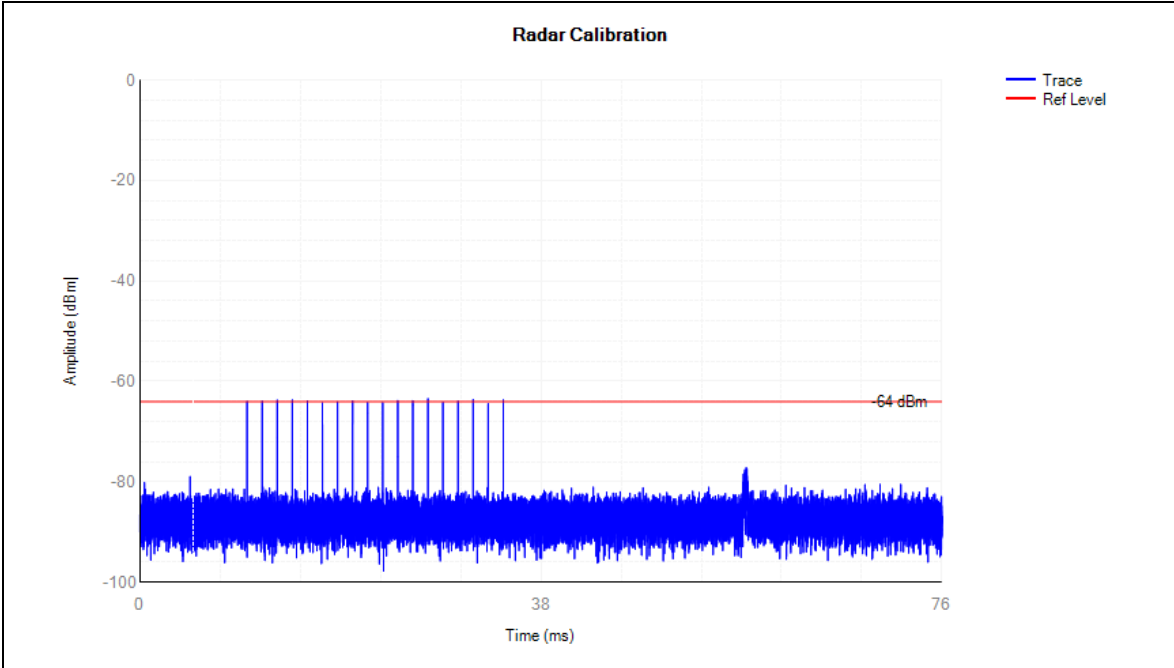

Radar Signal Type 4

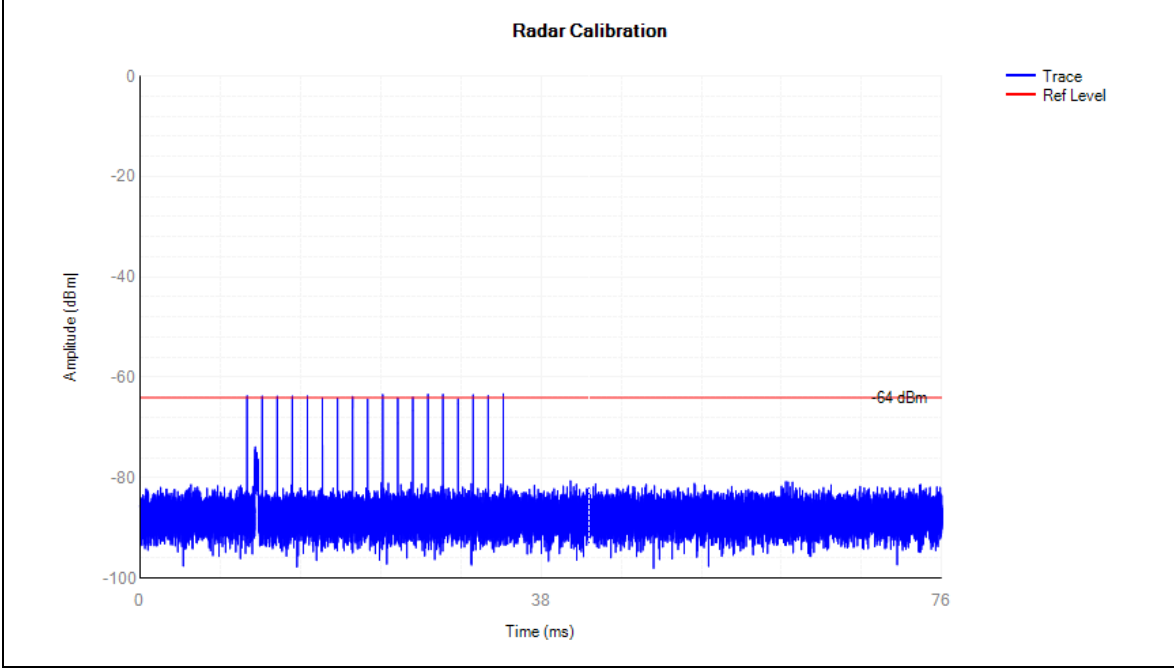

Radar Signal Type 5

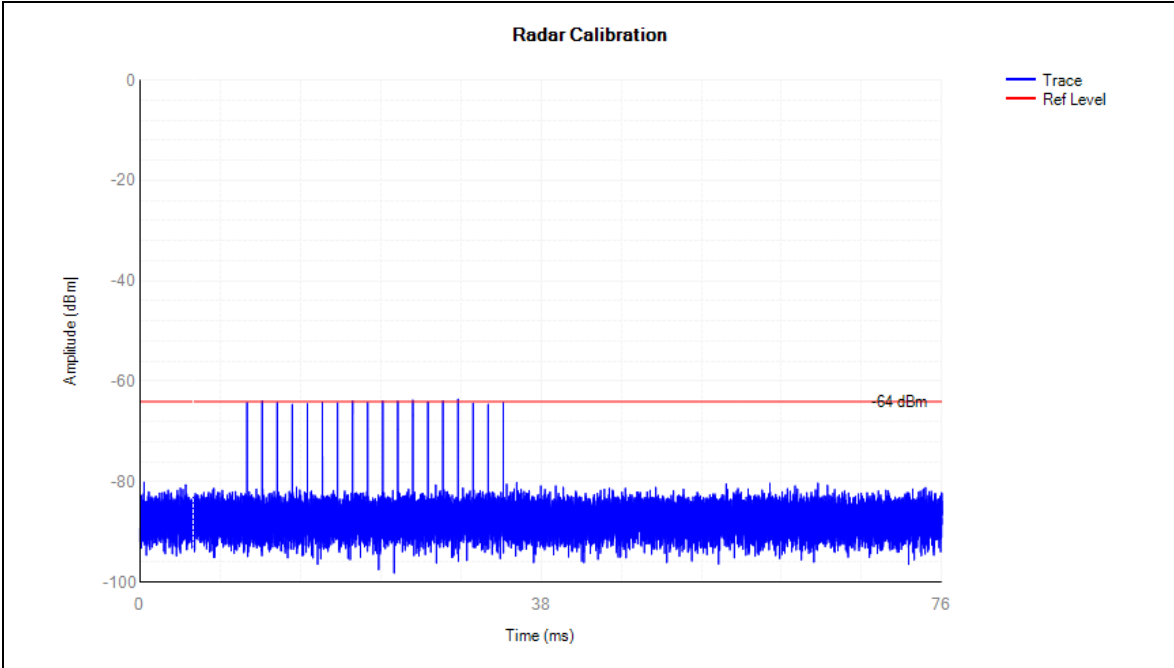

Radar Signal Type 5 AABB

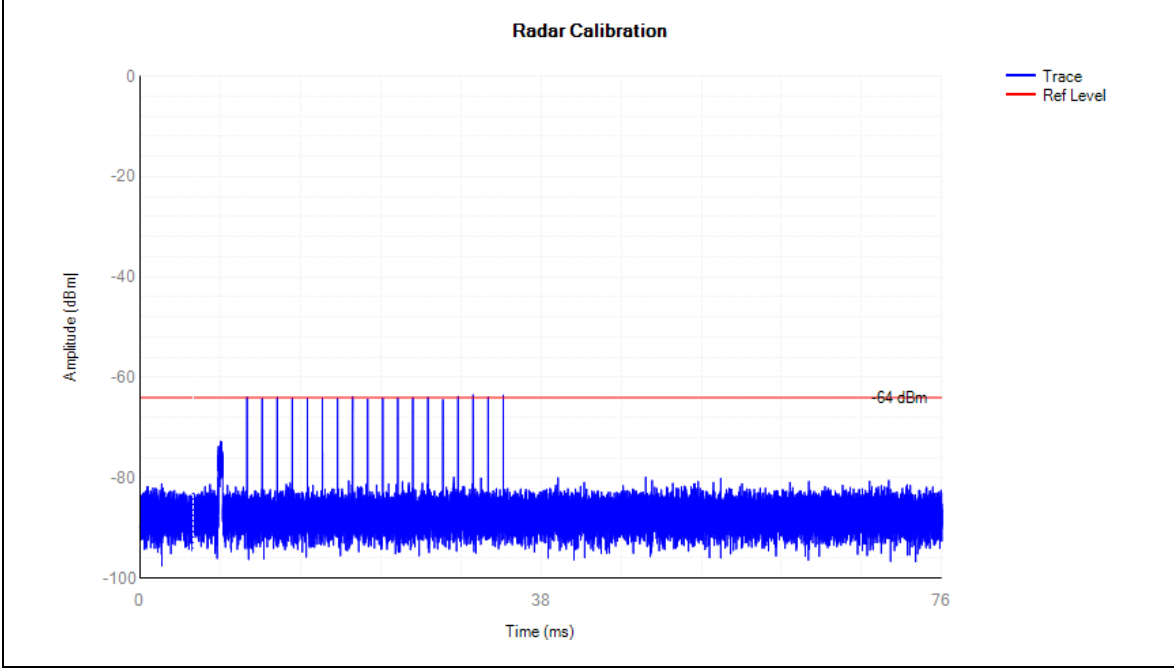

Radar Signal Type 5 ABAB

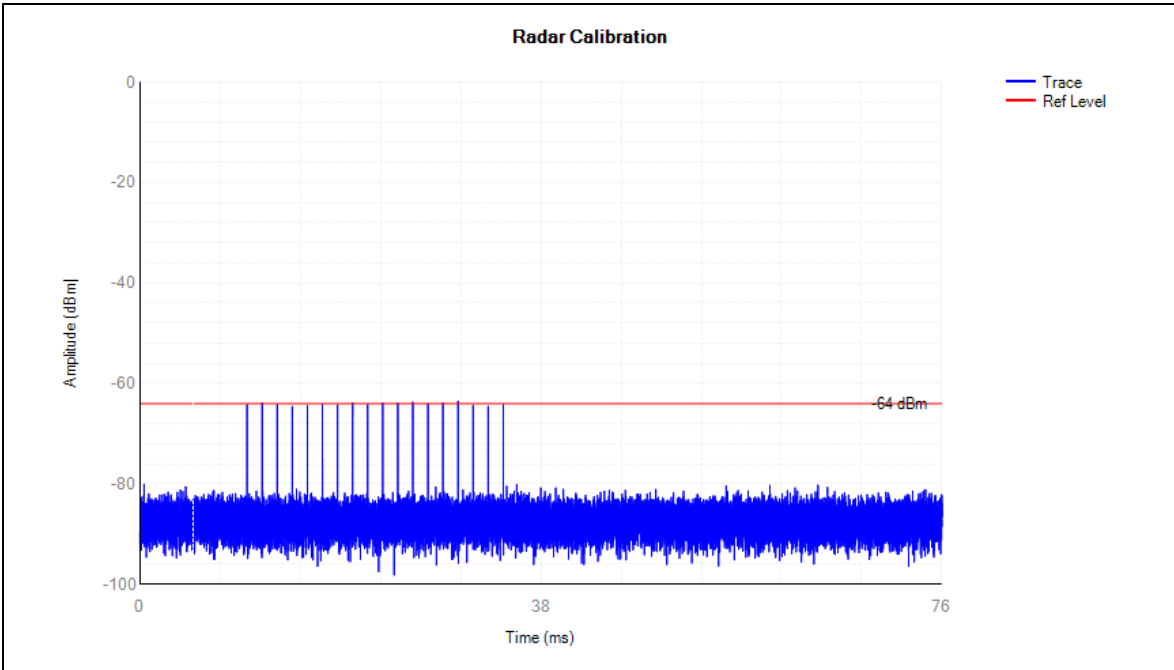

Radar Signal Type 6

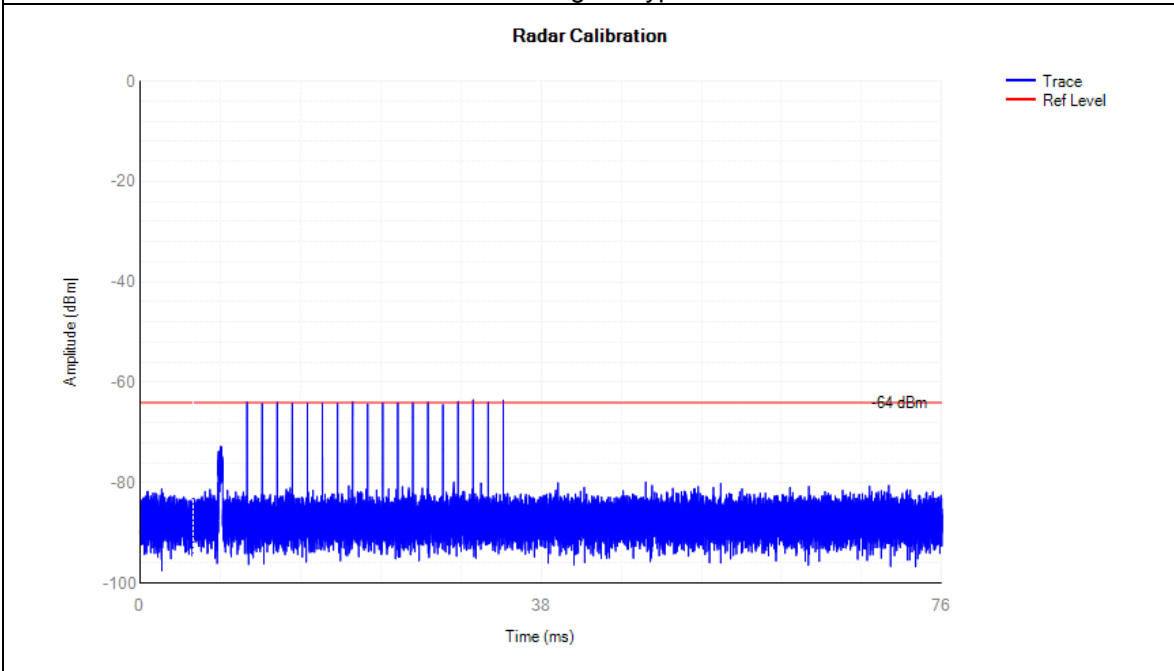

Radar Signal Type 6 AABB

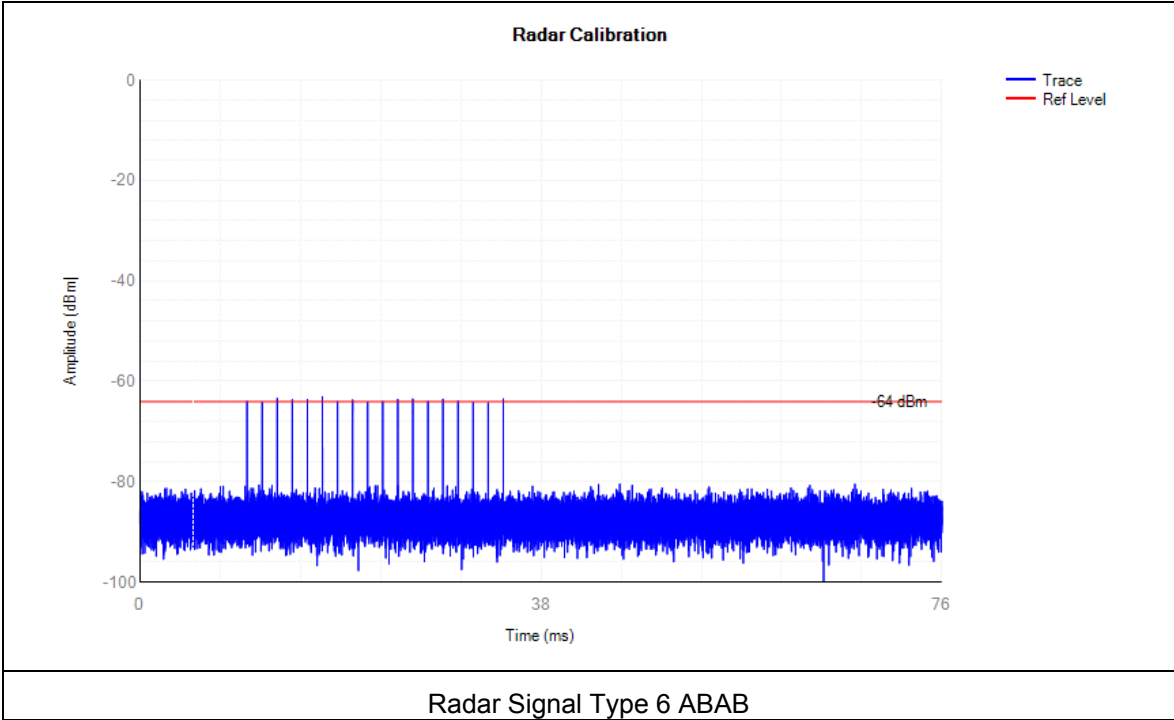

11 Test Procedure

11.1 In-Service Monitoring for Channel Move Time, Channel Closing Transmission Time and Non-Occupancy Period

These tests define how the following DFS parameters are verified during In-Service Monitoring;

- Channel Closing Transmission Time
- Channel Move Time
- Non-Occupancy Period

The steps below define the procedure to determine the above mentioned parameters when a radar Burst with a level equal to the DFS Detection Threshold + 1dB is generated on the Operating Channel of the U-NII device (In- Service Monitoring).

- a) One frequency will be chosen from the Operating Channels of the UUT within the 5250-5350 MHz or 5470-5725 MHz bands. For 802.11 devices, the test frequency must contain control signals. This can be verified by disabling channel loading and monitoring the spectrum analyzer. If no control signals are detected, another frequency must be selected within the emission bandwidth where control signals are detected.
- b) In case the UUT is a U-NII device operating as a Client Device (with or without DFS), a U-NII device operating as a Master Device will be used to allow the UUT (Client device) to Associate with the Master Device. In case the UUT is a Master Device, a U-NII device operating as a Client Device will be used and it is assumed that the Client will Associate with the UUT (Master). In both cases for conducted tests, the Radar Waveform generator will be connected to the Master Device. For radiated tests, the emissions of the Radar Waveform generator will be directed towards the Master Device. If the Master Device has antenna gain, the main beam of the antenna will be directed toward the radar emitter. Vertical polarization is used for testing.
- c) Stream the channel loading test file from the Master Device to the Client Device on the test Channel for the entire period of the test.
- d) At time T0 the Radar Waveform generator sends a Burst of pulses for one of the Radar Type 0 in Table 5 at levels defined in Table 3, on the Operating Channel. An additional 1 dB is added to the radar test signal to ensure it is at or above the DFS Detection Threshold, accounting for equipment variations/errors.
- e) Observe the transmissions of the UUT at the end of the radar Burst on the Operating Channel for duration greater than 10 seconds. Measure and record the transmissions from the UUT during the observation time (Channel Move Time). Measure and record the Channel Move Time and Channel Closing Transmission Time if radar detection occurs. Figure 17 illustrates Channel Closing Transmission Time.
- f) When operating as a Master Device, monitor the UUT for more than 30 minutes following instant T2 to verify that the UUT does not resume any transmissions on this Channel. Perform this test once and record the measurement result.

g) In case the UUT is a U-NII device operating as a Client Device with In-Service Monitoring, perform steps a) to f).

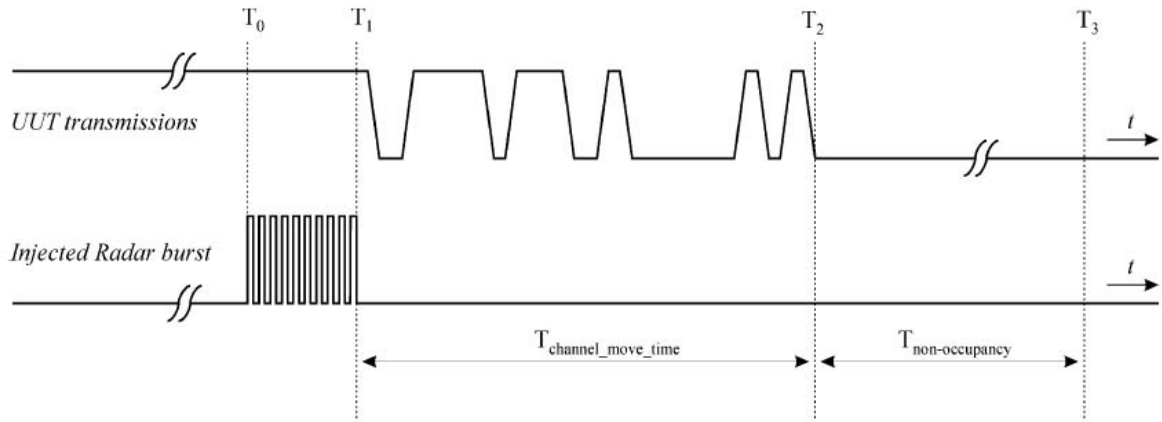

Figure 17: Example of Channel Closing Transmission Time & Channel Closing Time

11.2 DFS setup

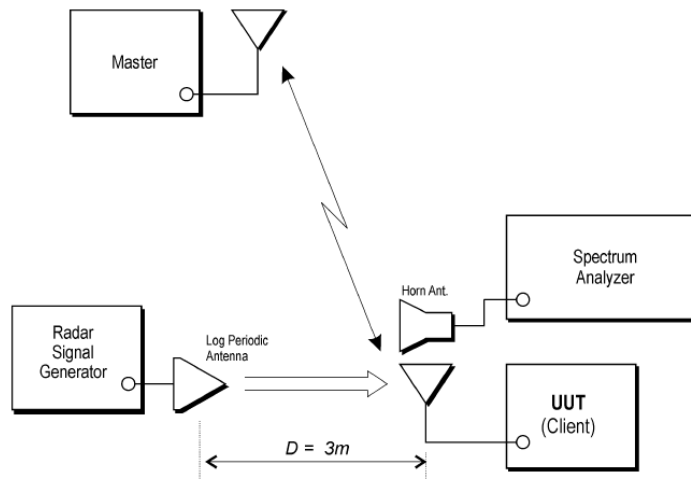

Figure 7: Example Radiated Setup where UUT is a Client and radar Test Waveforms are injected into the Client

12 Test Results

12.1 Channel Shutdown

Remark: We test all channels that need to be tested for DFS, including parts of the 5150-5250MHz and 5725-5850MHz that fall in the DFS band, reporting only part of the test pattern and data. In this report, we have identified other parts that are compliant with FCC regulations .

Mode	Channel number	Center frequency	Channel Move Time (s)	Limits(s)	Channel Closing Transmission Time(s)	Limits(s)	Results
802.11a(HT20)	52	5260	4.1264	10	0.0900	200 milliseconds + an aggregate of 60 milliseconds over remaining 10 second period	Pass
802.11a(HT20)	100	5500	3.8096		0.0816		Pass
802.11n(HT40)	54	5270	4.1060		0.0888		Pass
802.11n(HT40)	102	5510	4.1252		0.0852		Pass
802.11ac(HT80)	58	5290	3.8396		0.0828		Pass
802.11ac(HT80)	106	5530	4.1204		0.0912		Pass

Note:

1. The aggregate duration of all transmissions of the RLAN device on this channel during the Channel Move Time shall be limited to the Channel Closing Transmission Time. The aggregate duration of all transmissions shall not include quiet periods in between transmissions.
2. A reference type radar waveform was introduced to the EUT when 1s after sweep, and the spectrum Analyzer sweep time was set to 12s for monitoring and capturing the plot. A software program was created to collect the trace data and capturing the plot, then automatic calculate the duration time.

Test plots as below

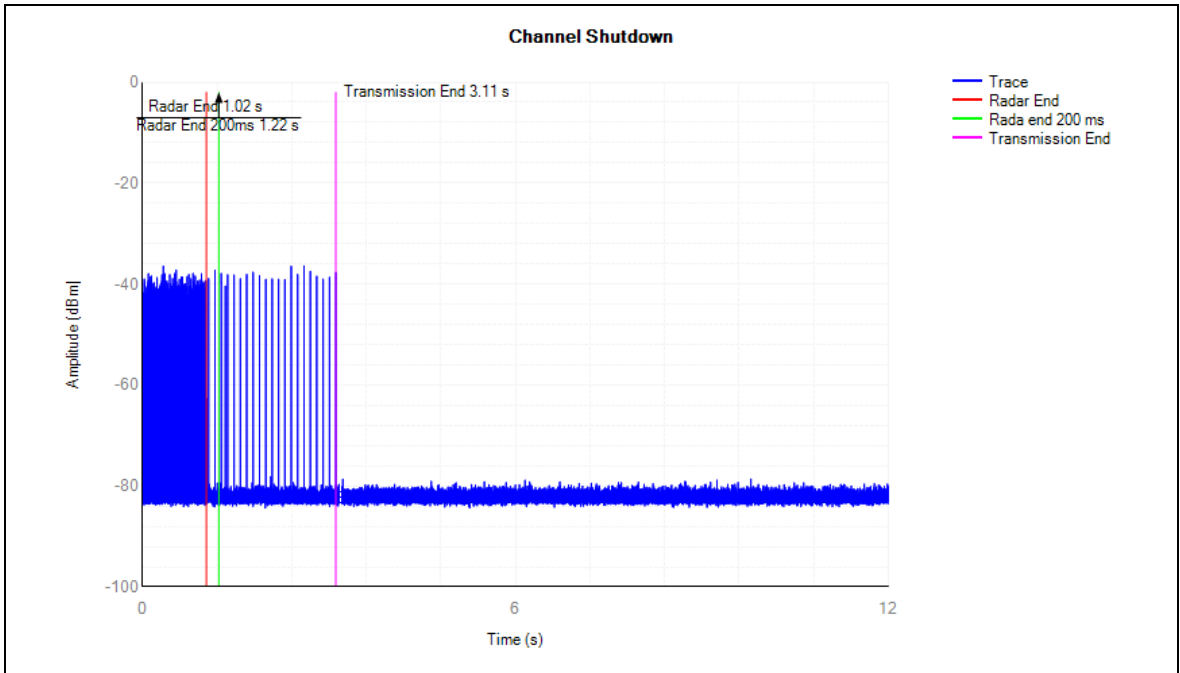

802.11a20 channel 52 5260MHz

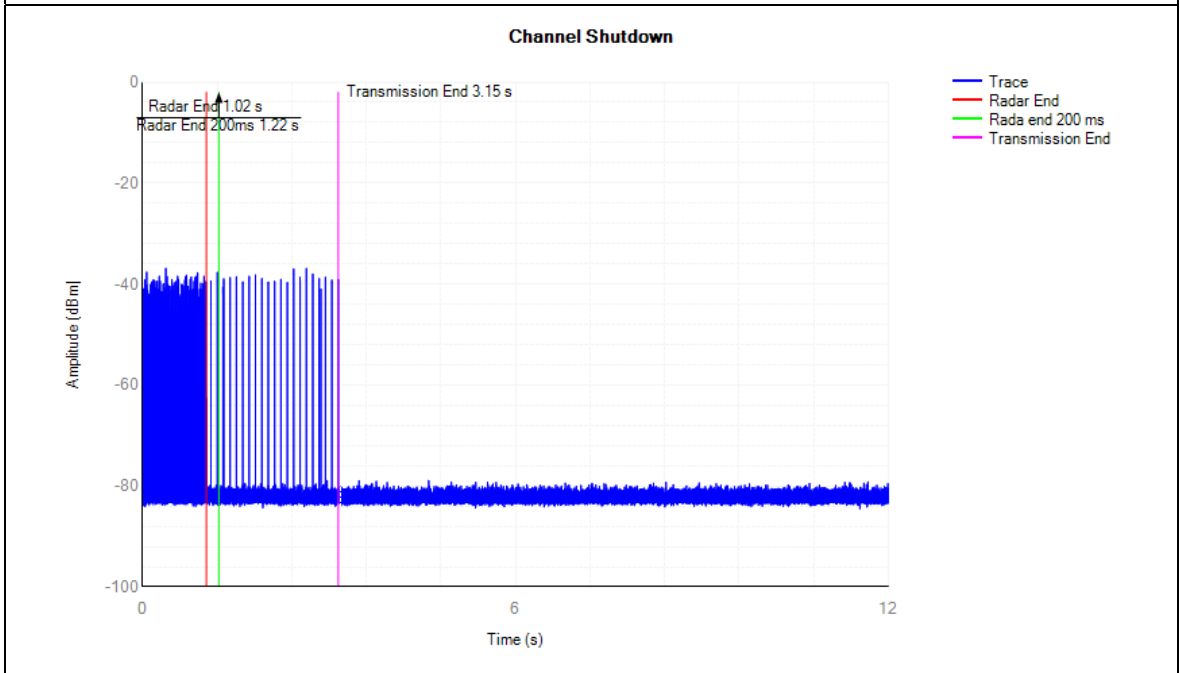

802.11a20 channel 100 5500MHz

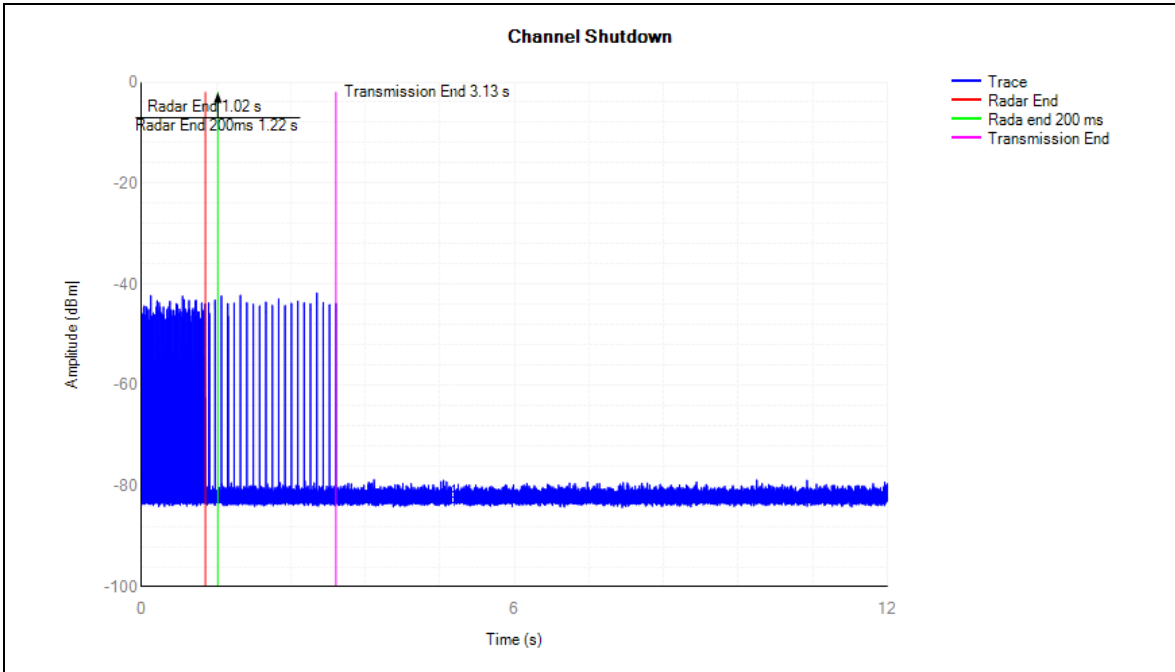

802.11n40 channel 54 5270MHz

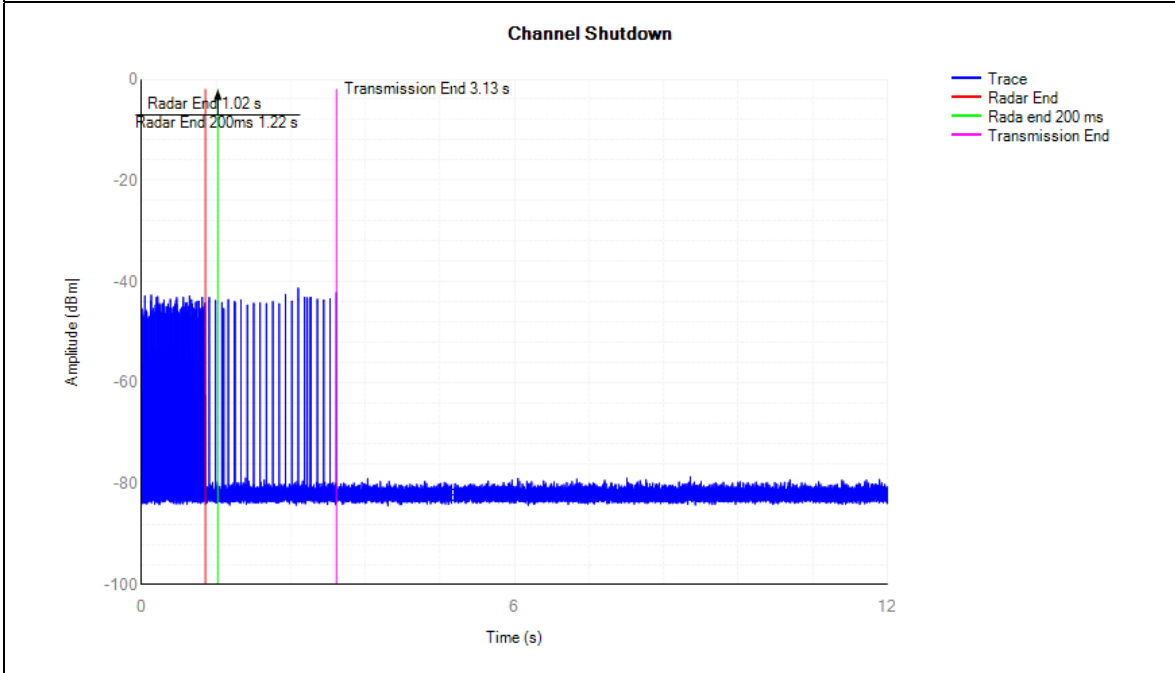

802.11n40 channel 102 5510MHz

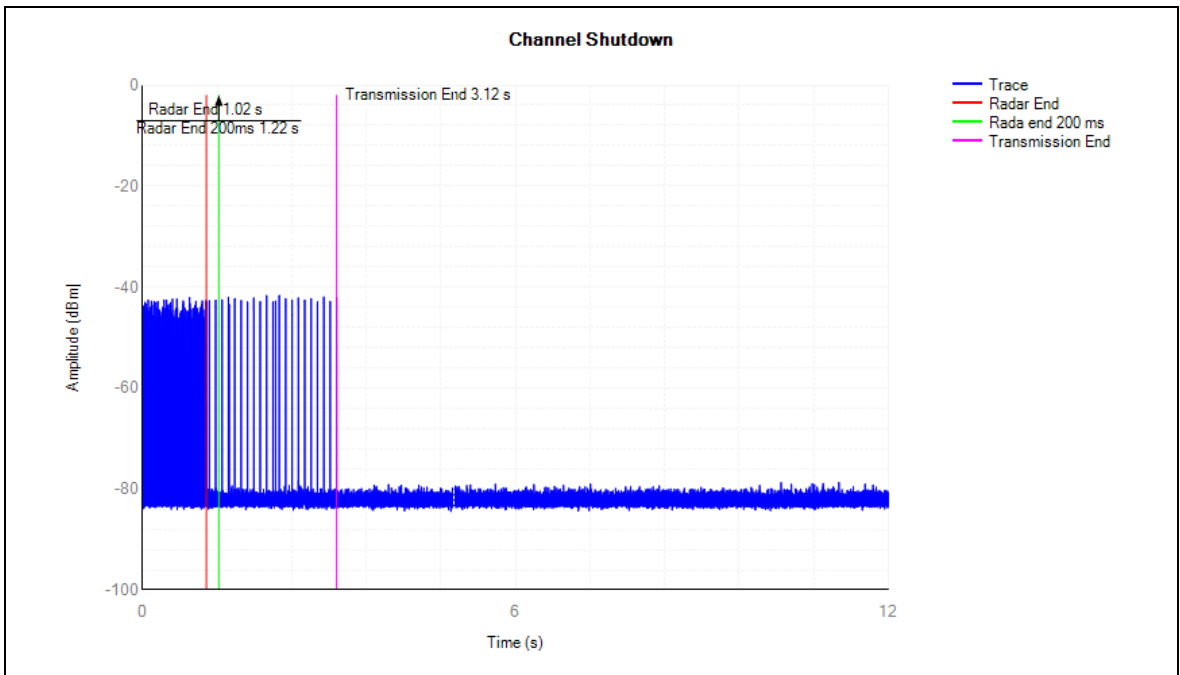

802.11ac80 channel 58 5290MHz

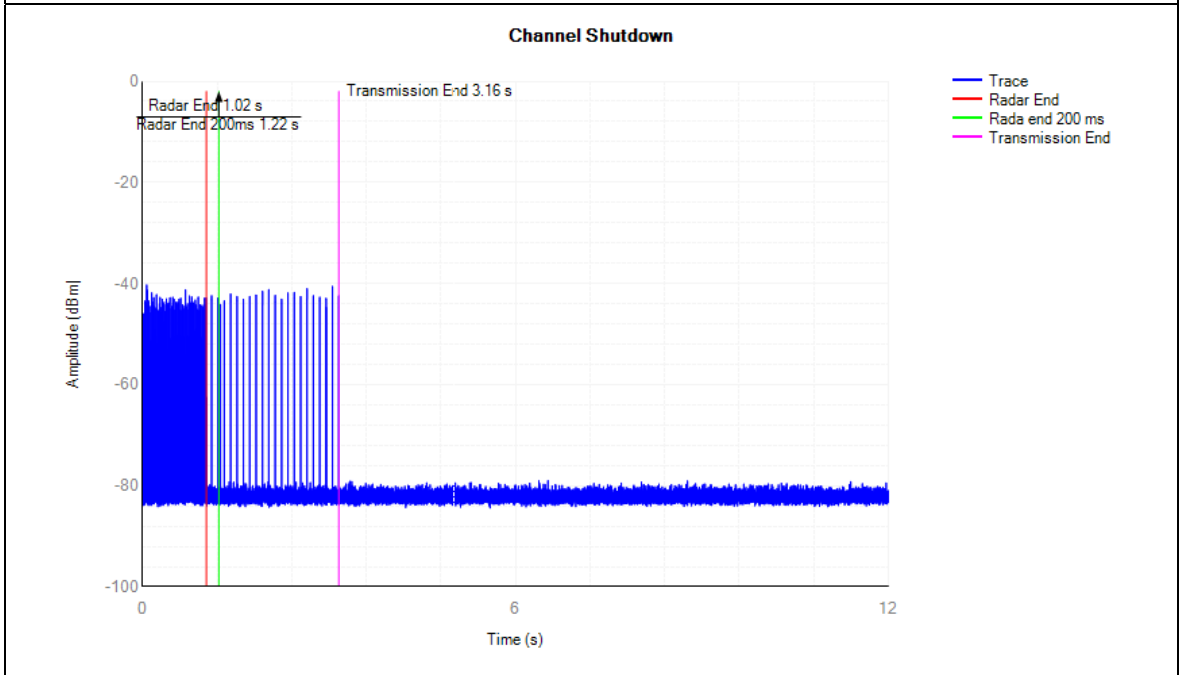

802.11ac80 channel 106 5530MHz

12.2 Non-Occupancy Period

Mode	Frequency	Bandwidth	Measured Value	Limit Requirements	Verdict
802.11a(HT20)	5260MHz	20MHz	>30min	30min	Pass
802.11a(HT20)	5500MHz	20MHz	>30min	30min	Pass
802.11n(HT40)	5270MHz	40MHz	>30min	30min	Pass
802.11n(HT40)	5510MHz	40MHz	>30min	30min	Pass
802.11ac(HT80)	5290MHz	80MHz	>30min	30min	Pass
802.11ac(HT80)	5530MHz	80MHz	>30min	30min	Pass

Note: All the mode have been tested and passed, only showed the worst mode in the report.

Test plots as below



13 Photographs —Test Setup

13.1 Photograph - DFS

For DFS Test

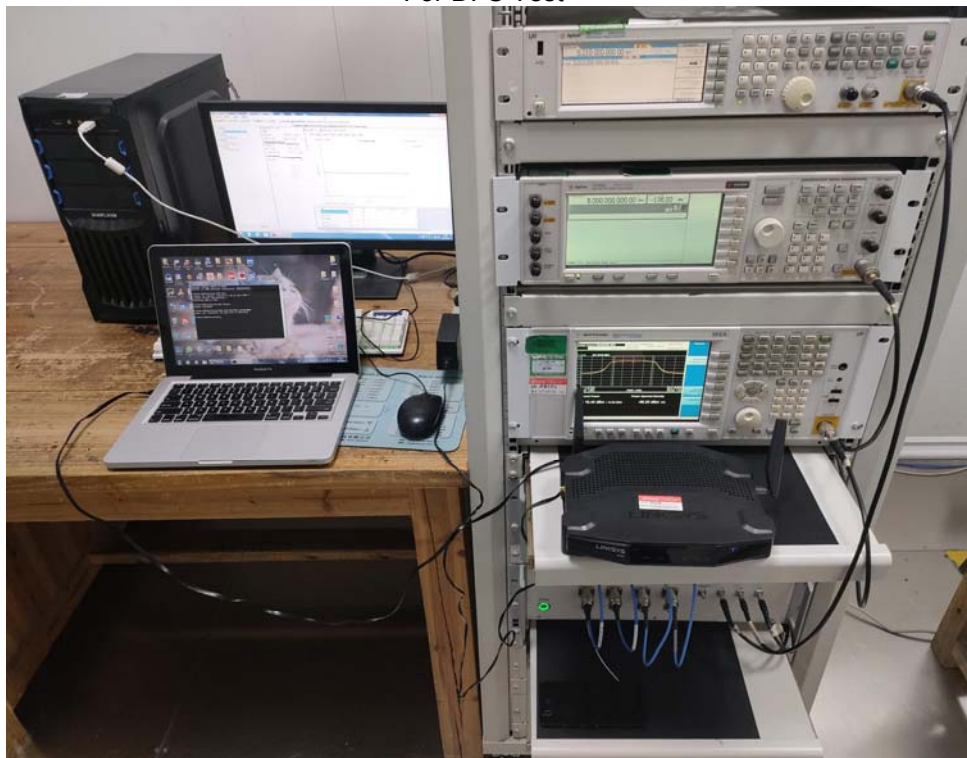

=====-End of Report=-====