



TEST REPORT

Report Reference No...... : **TRE1709004202** R/C.....: 48588

FCC ID..... : **2AEP1ELEMENTQ**

Applicant's name..... : **COLOMBIANA DE COMERCIO S.A.**

Address.....: Car.43E NO 8-71 Medellin,Colombia

Manufacturer.....: AMER international co.,limited

Address.....: 23th Floor,Century Square,No. 3018 Shennan Road,Futian District,Shenzhen Guangdong,PRC

Test item description : **ELEMENT**

Trade Mark: Kalley

Model/Type reference.....: Element Q

Listed Model(s): -

Standard : **FCC CFR Title 47 Part 15 Subpart C Section 15.247**

Date of receipt of test sample.....: Sep.07,2017

Date of testing.....: Sep.08,2017- Sep.21,2017

Date of issue.....: Sep.22,2017

Result.....: **PASS**

Compiled by
(position+printedname+signature)....: File administrators Candy Liu *Candy Liu*

Supervised by
(position+printedname+signature).....: Project Engineer : Edward Pan *Edward Pan*

Approved by
(position+printedname+signature)....: RF Manager Hans Hu *Hans Hu*

Testing Laboratory Name : **Shenzhen Huatongwei International Inspection Co., Ltd.**

Address.....: 1/F, Bldg 3, Hongfa Hi-tech Industrial Park, Genyu Road, Tianliao, Gongming, Shenzhen, China

Shenzhen Huatongwei International Inspection Co., Ltd. All rights reserved.

This publication may be reproduced in whole or in part for non-commercial purposes as long as the Shenzhen Huatongwei International Inspection Co., Ltd. is acknowledged as copyright owner and source of the material. Shenzhen Huatongwei International Inspection Co., Ltd. takes no responsibility for and will not assume liability for damages resulting from the reader's interpretation of the reproduced material due to its placement and context.

The test report merely correspond to the test sample.

Contents

1.	<u>TEST STANDARDS AND REPORT VERSION</u>	3
1.1.	Test Standards	3
1.2.	Report version	3
2.	<u>TEST DESCRIPTION</u>	4
3.	<u>SUMMARY</u>	5
3.1.	Client Information	5
3.2.	Product Description	5
3.3.	Operation state	6
3.4.	EUT configuration	6
3.5.	Modifications	6
4.	<u>TEST ENVIRONMENT</u>	7
4.1.	Address of the test laboratory	7
4.2.	Test Facility	7
4.3.	Environmental conditions	8
4.4.	Statement of the measurement uncertainty	8
4.5.	Equipments Used during the Test	9
5.	<u>TEST CONDITIONS AND RESULTS</u>	10
5.1.	Antenna requirement	10
5.2.	Conducted Emissions (AC Main)	11
5.3.	Conducted Peak Output Power	14
5.4.	Power Spectral Density	15
5.5.	6dB bandwidth	19
5.6.	Restricted band	23
5.7.	Band edge and Spurious Emissions (conducted)	38
5.8.	Spurious Emissions (radiated)	51
6.	<u>TEST SETUP PHOTOS</u>	57
7.	<u>EXTERANAL AND INTERNAL PHOTOS</u>	58

1. TEST STANDARDS AND REPORT VERSION

1.1. Test Standards

The tests were performed according to following standards:

[FCC Rules Part 15.247](#): Frequency Hopping, Direct Spread Spectrum and Hybrid Systems that are in operation within the bands of 902-928 MHz, 2400-2483.5 MHz, and 5725-5850 MHz.

[ANSI C63.10:2013](#): American National Standard for Testing Unlicensed Wireless Devices

[KDB 558074 D01 DTS Meas Guidance v04](#): Guidance for Performing Compliance Measurements on Digital Transmission Systems (DTS) Operating under §15.247

1.2. Report version

Version No.	Date of issue	Description
00	Sep.22,2017	Original

2. TEST DESCRIPTION

Test Item	FCC Rule	Result	Test Engineer
Antenna requirement	15.203/15.247(c)	Pass	William Wang
Line Conducted Emissions (AC Main)	15.207	Pass	William Wang
Conducted Peak Output Power	15.247(b)(3)	Pass	William Wang
Power Spectral Density	15.247(e)	Pass	William Wang
6dB Bandwidth	15.247(a)(2)	Pass	William Wang
Restricted band	15.247(d)/15.205	Pass	William Wang
Spurious Emissions	15.247(d)/15.209	Pass	William Wang

Note: The measurement uncertainty is not included in the test result.

3. SUMMARY

3.1. Client Information

Applicant:	COLOMBIANA DE COMERCIO S.A.
Address:	Car.43E NO 8-71 Medellin,Colombia
Manufacturer:	AMER international co.,limited
Address:	23th Floor,Century Square,No. 3018 Shennan Road,Futian District,Shenzhen Guangdong,PRC

3.2. Product Description

Name of EUT:	ELEMENT
Trade Mark:	Kalley
Model No.:	Element Q
Listed Model(s):	-
IMEI1:	354546080152055
IMEI2:	354546080152063
Power supply:	DC 3.7V From exchange battery
Adapter information:	Input: 100-240Va.c., 50/60Hz, 0.2A Output: 5Vd.c., 1.0A
Hardware version:	TC65B V2.0
Software version:	Kalley_ELEMENT_Q_SW05_20170929
WIFI	
Supported type:	802.11b/802.11g/802.11n(HT20)
Modulation:	DSSS for 802.11b OFDM for 802.11g/802.11n(HT20)
Operation frequency:	2412MHz~2462MHz
Channel number:	11
Channel separation:	5MHz
Antenna type:	Integral antenna
Antenna gain:	-1.2 dBi

3.3. Operation state

➤ Test frequency list

According to section 15.31(m), regards to the operating frequency range over 10 MHz, must select three channel which were tested. the Lowest frequency, the middle frequency, and the highest frequency of channel were selected to perform the test, please see the above gray bottom.

802.11b/g/n(HT20)	
Channel	Frequency (MHz)
01	2412
02	2417
03	2422
04	2427
05	2432
06	2437
07	2442
08	2447
09	2452
10	2457
11	2462

➤ Test mode

For RF test items
The engineering test program was provided and enabled to make EUT continuous transmit (duty cycle>98%).
For AC power line conducted emissions:
The EUT was set to connect with the WLAN AP under large package sizes transmission.
For RF test axis
EUT in each of three orthogonal axis emissions had been tested ,but only the worst case (X axis) data Recorded in the report.

3.4. EUT configuration

The following peripheral devices and interface cables were connected during the measurement:

- - supplied by the manufacturer
- - supplied by the lab

○ /	Manufacturer:	/
	Model No.:	/
○ /	Manufacturer:	/
	Model No.:	/

3.5. Modifications

No modifications were implemented to meet testing criteria.

4. TEST ENVIRONMENT

4.1. Address of the test laboratory

Laboratory: Shenzhen Huatongwei International Inspection Co., Ltd.

Address: 1/F, Bldg 3, Hongfa Hi-tech Industrial Park, Genyu Road, Tianliao, Gongming, Shenzhen, China

4.2. Test Facility

CNAS-Lab Code: L1225

Shenzhen Huatongwei International Inspection Co., Ltd. has been assessed and proved to be in compliance with CNAS-CL01 Accreditation Criteria for Testing and Calibration Laboratories (identical to ISO/IEC17025: 2005 General Requirements) for the Competence of Testing and Calibration Laboratories.

A2LA-Lab Cert. No.: 3902.01

Shenzhen Huatongwei International Inspection Co., Ltd. EMC Laboratory has been accredited by A2LA for technical competence in the field of electrical testing, and proved to be in compliance with ISO/IEC 17025: 2005 General Requirements for the Competence of Testing and Calibration Laboratories and any additional program requirements in the identified field of testing.

FCC-Registration No.: 762235

Shenzhen Huatongwei International Inspection Co., Ltd. EMC Laboratory has been registered and fully described in a report filed with the FCC (Federal Communications Commission). The acceptance letter from the FCC is maintained in our files.

IC-Registration No.:5377B-1

Two 3m Alternate Test Site of Shenzhen Huatongwei International Inspection Co., Ltd. has been registered by Certification and Engineering Bureau of Industry Canada for the performance of radiated measurements with Registration No.: 5377B-1.

ACA

Shenzhen Huatongwei International Inspection Co., Ltd. EMC Laboratory can also perform testing for the Australian C-Tick mark as a result of our A2LA accreditation.

4.3. Environmental conditions

During the measurement the environmental conditions were within the listed ranges:

Temperature:	15~35°C
Relative Humidity:	30~60 %
Air Pressure:	950~1050mba

4.4. Statement of the measurement uncertainty

The data and results referenced in this document are true and accurate. The reader is cautioned that there may be errors in calibration limits of the equipment and facilities. The measurement uncertainty was calculated for all measurements listed in this test report according to TR-100028-01 "Electromagnetic compatibility and Radio spectrum Matters (ERM); Uncertainties in the measurement of mobile radio equipment characteristics; Part 1" and TR-100028-02 "Electromagnetic compatibility and Radio spectrum Matters (ERM); Uncertainties in the measurement of mobile radio equipment characteristics; Part 2" and is documented in the Shenzhen Huatongwei International Inspection Co., Ltd. quality system according to ISO/IEC 17025. Furthermore, component and process variability of devices similar to that tested may result in additional deviation. The manufacturer has the sole responsibility of continued compliance of the device.

Here after the best measurement capability for Shenzhen Huatongwei International Inspection Co., Ltd. is reported:

Test Items	Measurement Uncertainty	Notes
Transmitter power conducted	0.57 dB	(1)
Transmitter power Radiated	2.20 dB	(1)
Conducted spurious emissions 9kHz~40GHz	1.60 dB	(1)
Radiated spurious emissions 9kHz~40GHz	2.20 dB	(1)
Conducted Emissions 9kHz~30MHz	3.39 dB	(1)
Radiated Emissions 30~1000MHz	4.24 dB	(1)
Radiated Emissions 1~18GHz	5.16 dB	(1)
Radiated Emissions 18~40GHz	5.54 dB	(1)

(1) This uncertainty represents an expanded uncertainty expressed at approximately the 95% confidence level using a coverage factor of $k=1.96$.

4.5. Equipments Used during the Test

Conducted Emissions					
Item	Test Equipment	Manufacturer	Model No.	Serial No.	Last Cal.
1	Artificial Mains	Rohde&Schwarz	ESH2-Z5	100028	2016/11/13
2	EMI Test Receiver	Rohde&Schwarz	ESCI3	100038	2016/11/13
3	Pulse Limiter	Rohde&Schwarz	ESHSZ2	100044	2016/11/13
4	EMI Test Software	Rohde&Schwarz	ES-K1 V1.71	-	-

Radiated Emissions					
Item	Test Equipment	Manufacturer	Model No.	Serial No.	Last Cal.
1	EMI test receiver	Rohde&Schwarz	ESI 26	100009	2016/11/13
2	Loop Antenna	Rohde&Schwarz	HFH2-Z2	100020	2016/11/13
3	Ultra-Broadband Antenna	ShwarzBeck	VULB9163	538	2016/11/13
4	Horn antenna	ShwarzBeck	9120D	1011	2016/11/13
5	Horn Antenna	SCHWARZBECK	BBHA9170	25841	2016/11/13
6	Amplifier	Sonoma	310N	E009-13	2016/11/13
7	JS Amplifier	Rohde&Schwarz	JS4-00101800-28-5A	F201504	2016/11/13
8	Amplifier	Compliance Direction systems	PAP1-4060	120	2016/11/13
9	High pass filter	Compliance Direction systems	BSU-6	34202	2016/11/13
10	EMI test Software	Rohde&Schwarz	ESK1	-	-
11	EMI test Software	Audix	E3	-	-
12	TURNTABLE	MATURO	TT2.0	-	-
13	ANTENNA MAST	MATURO	TAM-4.0-P	-	-

RF Conducted methods					
Item	Test Equipment	Manufacturer	Model No.	Serial No.	Last Cal.
1	Spectrum Analyzer	Rohde&Schwarz	FSP	1164.4391.40	2016/11/13
2	MXA Signal Analyzer	Agilent Technologies	N9020A	MY5050187	2016/11/13

The Cal.Interval was one year.

5. TEST CONDITIONS AND RESULTS

5.1. Antenna requirement

REQUIREMENT:

FCC CFR Title 47 Part 15 Subpart C Section 15.203:

An intentional radiator shall be designed to ensure that no antenna other than that furnished by the responsible party shall be used with the device. The use of a permanently attached antenna or of an antenna that uses a unique coupling to the intentional radiator, the manufacturer may design the unit so that a broken antenna can be replaced by the user, but the use of a standard antenna jack or electrical connector is prohibited.

FCC CFR Title 47 Part 15 Subpart C Section 15.247(c) (1)(i):

(i) Systems operating in the 2400~2483.5 MHz band that is used exclusively for fixed. Point-to-point operations may employ transmitting antennas with directional gain greater than 6 dBi provided the maximum conducted output power of the intentional radiator is reduced by 1 dB for every 3 dB that the directional gain of the antenna exceeds 6 dBi.

TEST RESULTS

Passed **Not Applicable**

The directional gain of the antenna less than 6 dBi, please refer to the below antenna photo.

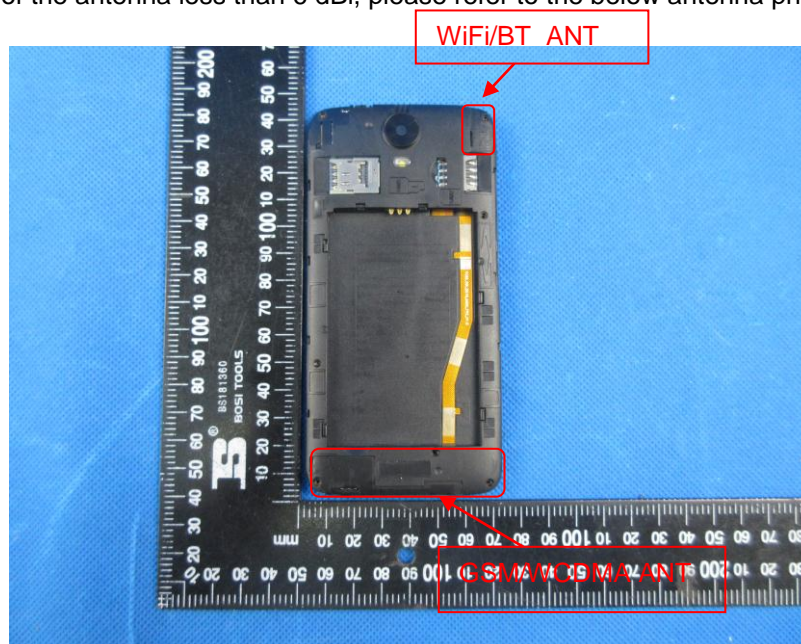

5.2. Conducted Emissions (AC Main)

LIMIT

FCC CFR Title 47 Part 15 Subpart C Section 15.207:

Frequency range (MHz)	Limit (dBuV)	
	Quasi-peak	Average
0.15-0.5	66 to 56*	56 to 46*
0.5-5	56	46
5-30	60	50

* Decreases with the logarithm of the frequency.

TEST CONFIGURATION

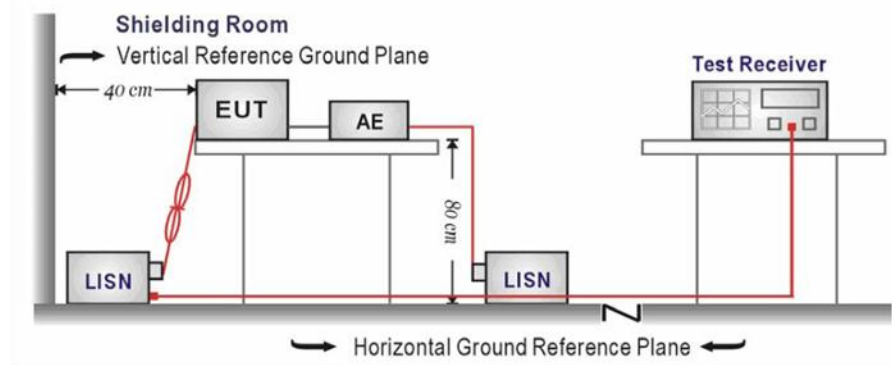

TEST PROCEDURE

1. The EUT was setup according to ANSI C63.10:2013 requirements.
2. The EUT was placed on a platform of nominal size, 1 m by 1.5 m, raised 80 cm above the conducting ground plane. The vertical conducting plane was located 40 cm to the rear of the EUT. All other surfaces of EUT were at least 80 cm from any other grounded conducting surface.
3. The EUT and simulators are connected to the main power through a line impedances stabilization network (LISN). The LISN provides a 50 ohm /50uH coupling impedance for the measuring equipment.
4. The peripheral devices are also connected to the main power through a LISN. (Please refer to the block diagram of the test setup and photographs)
5. Each current-carrying conductor of the EUT power cord, except the ground (safety) conductor, was individually connected through a LISN to the input power source.
6. The excess length of the power cord between the EUT and the LISN receptacle were folded back and forth at the center of the lead to form a bundle not exceeding 40 cm in length.
7. Conducted Emissions were investigated over the frequency range from 0.15MHz to 30MHz using a receiver bandwidth of 9 kHz.
8. During the above scans, the emissions were maximized by cable manipulation.

TEST MODE:

Please refer to the clause 3.3

TEST RESULTS

Passed Not Applicable

Note:

- 1) Transd=Cable lose+ Pulse Limiter Factor + Artificial Mains Factor
- 2) Margin= Limit -Level

Test Line:

L

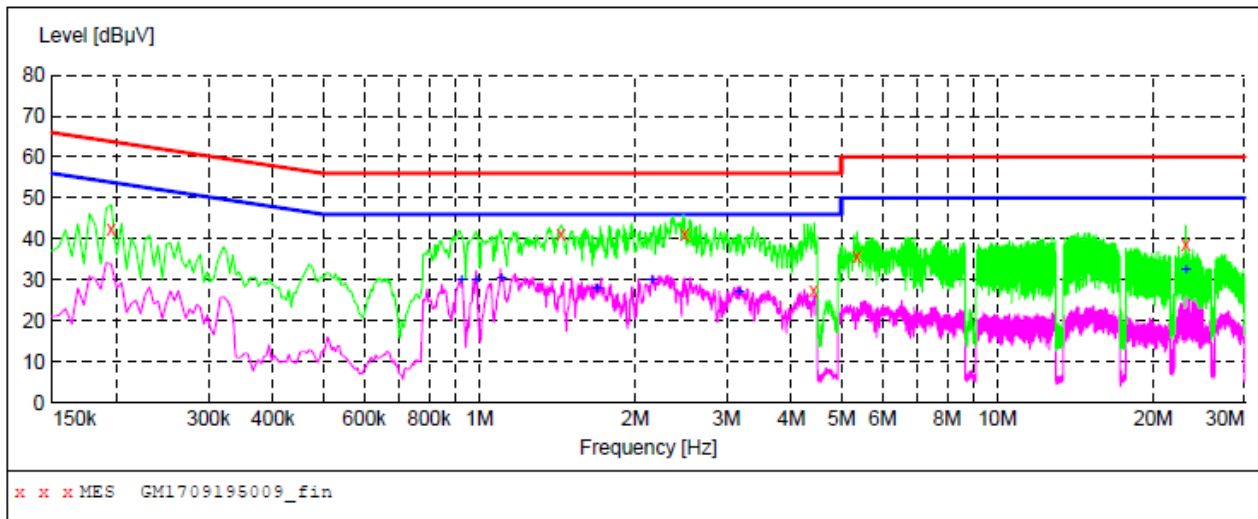

MEASUREMENT RESULT: "GM1709195009_fin"

9/19/2017 10:15AM

Frequency MHz	Level dBµV	Transd dB	Limit dBµV	Margin dB	Detector	Line	PE
0.195000	42.60	10.3	64	21.2	QP	L1	GND
1.437000	41.40	10.2	56	14.6	QP	L1	GND
2.490000	41.30	10.2	56	14.7	QP	L1	GND
4.425000	27.20	10.3	56	28.8	QP	L1	GND
5.356500	35.70	10.3	60	24.3	QP	L1	GND
23.127000	38.70	10.7	60	21.3	QP	L1	GND

MEASUREMENT RESULT: "GM1709195009_fin2"

9/19/2017 10:15AM

Frequency MHz	Level dBµV	Transd dB	Limit dBµV	Margin dB	Detector	Line	PE
0.924000	30.00	10.2	46	16.0	AV	L1	GND
0.987000	29.80	10.2	46	16.2	AV	L1	GND
1.104000	30.50	10.2	46	15.5	AV	L1	GND
1.684500	28.00	10.2	46	18.0	AV	L1	GND
2.152500	29.90	10.2	46	16.1	AV	L1	GND
3.169500	26.90	10.2	46	19.1	AV	L1	GND
23.127000	32.30	10.7	50	17.7	AV	L1	GND

Test Line: N

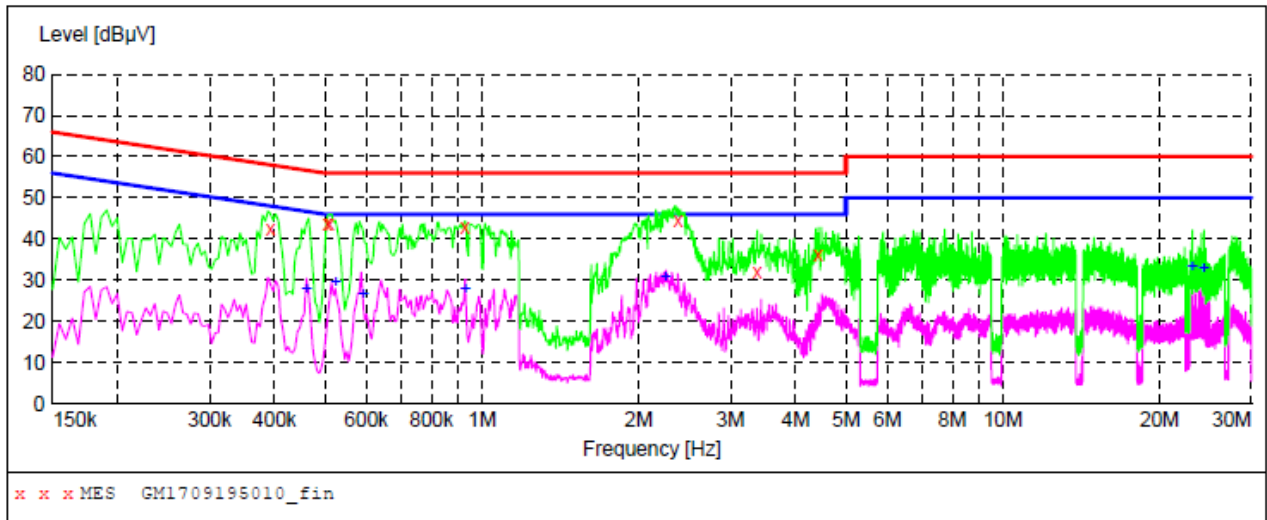

MEASUREMENT RESULT: "GM1709195010_fin"

9/19/2017 10:18AM

Frequency MHz	Level dBµV	Transd dB	Limit dBµV	Margin dB	Detector	Line	PE
0.393000	42.50	10.2	58	15.5	QP	N	GND
0.505500	43.80	10.2	56	12.2	QP	N	GND
0.510000	43.70	10.2	56	12.3	QP	N	GND
0.928500	42.80	10.2	56	13.2	QP	N	GND
2.382000	44.40	10.2	56	11.6	QP	N	GND
3.376500	32.20	10.3	56	23.8	QP	N	GND
4.425000	36.30	10.3	56	19.7	QP	N	GND

MEASUREMENT RESULT: "GM1709195010_fin2"

9/19/2017 10:18AM

Frequency MHz	Level dBµV	Transd dB	Limit dBµV	Margin dB	Detector	Line	PE
0.460500	27.80	10.2	47	18.9	AV	N	GND
0.523500	29.40	10.2	46	16.6	AV	N	GND
0.591000	26.70	10.2	46	19.3	AV	N	GND
0.928500	28.00	10.2	46	18.0	AV	N	GND
2.247000	30.80	10.2	46	15.2	AV	N	GND
23.127000	33.10	10.7	50	16.9	AV	N	GND
24.346500	32.90	10.7	50	17.1	AV	N	GND

5.3. Conducted Peak Output Power

LIMIT

FCC CFR Title 47 Part 15 Subpart C Section 15.247 (b)(3): **30dBm**:

TEST CONFIGURATION

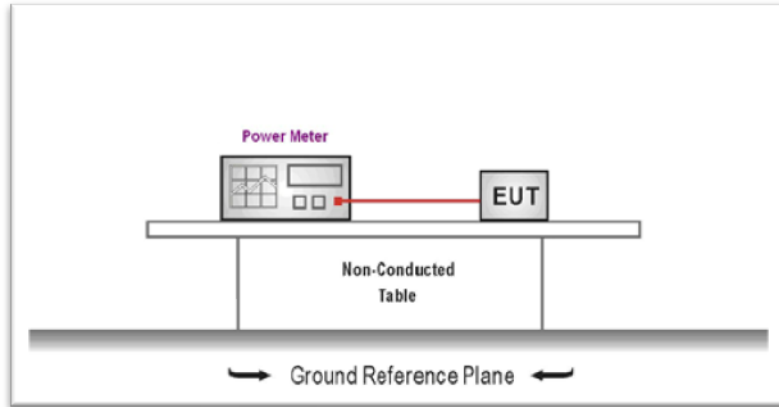

TEST PROCEDURE

1. The EUT was tested according to ANSI C63.10: 2013 and KDB 558074 D01 for compliance to FCC 47 CFR 15.247 requirements.
2. The maximum peak conducted output power may be measured using a broadband peak RF power meter.
3. The power meter shall have a video bandwidth that is greater than or equal to the DTS bandwidth and shall utilize a fast-responding diode detector
4. Record the measurement data.

TEST MODE:

Please refer to the clause 3.3

TEST RESULTS

Passed Not Applicable

Type	Channel	Output power (dBm)	Limit (dBm)	Result
802.11b	01	19.21	≤30.00	Pass
	06	19.65		
	11	19.66		
802.11g	01	18.11	≤30.00	Pass
	06	18.71		
	11	18.95		
802.11n(HT20)	01	16.27	≤30.00	Pass
	06	16.7		
	11	16.89		

5.4. Power Spectral Density

LIMIT

FCC CFR Title 47 Part 15 Subpart C Section 15.247 (e):For digitally modulated systems, the power spectral density conducted from the intentional radiator to the antenna shall not be greater than 8 dBm in any 3 kHz band during any time interval of continuous transmission.

TEST CONFIGURATION

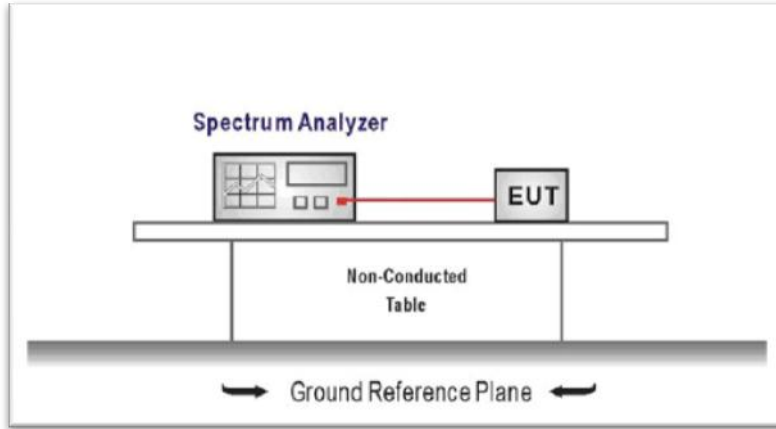

TEST PROCEDURE

1. Connect the antenna port(s) to the spectrum analyzer input,
2. Configure the spectrum analyzer as shown below:
 Center frequency=DTS channel center frequency
 Span =1.5 times the DTS bandwidth
 RBW = 3 kHz ≤ RBW ≤ 100 kHz, VBW ≥ 3 × RBW
 Sweep time = auto couple
 Detector = peak
 Trace mode = max hold
3. Place the radio in continuous transmit mode, allow the trace to stabilize, view the transmitter wave form on the spectrum analyzer.
4. Use the peak marker function to determine the maximum amplitude level within the RBW.
5. If measured value exceeds limit, reduce RBW (no less than 3 kHz) and repeat.

TEST MODE:



Please refer to the clause 3.3

TEST RESULTS

Passed Not Applicable

Type	Channel	Power Spectral Density (dBm/RBW)	Limit (dBm/RBW)	Result
802.11b	01	3.875	≤8.00	Pass
	06	3.217		
	11	3.367		
802.11g	01	-5.896	≤8.00	Pass
	06	-4.230		
	11	-4.784		
802.11n(HT20)	01	-7.787	≤8.00	Pass
	06	-6.861		
	11	-7.230		

Test plot as follows:

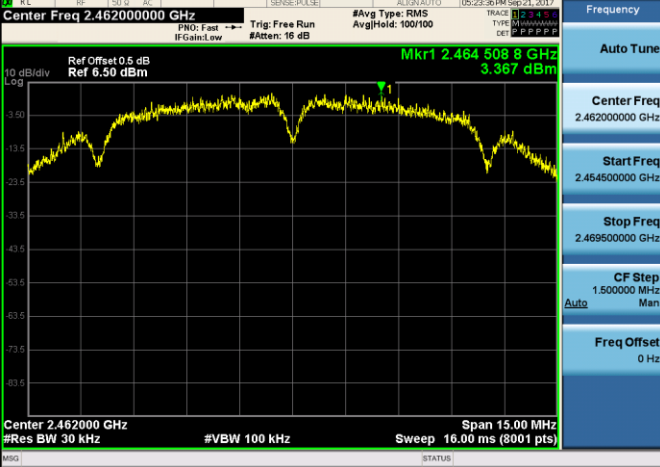
Type:		802.11 b	
CH01		<p>Agilent Spectrum Analyzer - Swept SA</p> <p>Center Freq 2.41200000 GHz</p> <p>Ref Offset 0.5 dB Ref 6.50 dBm</p> <p>Mkr1 2.413 006 9 GHz 3.875 dBm</p> <p>Center 2.412000 GHz #Res BW 30 kHz #VBW 100 kHz Sweep 16.00 ms (8001 pts)</p>	<p>Frequency</p> <p>Auto Tune</p> <p>Center Freq 2.41200000 GHz</p> <p>Start Freq 2.404500000 GHz</p> <p>Stop Freq 2.419500000 GHz</p> <p>CF Step 1.500000 MHz</p> <p>Auto Man</p> <p>Freq Offset 0 Hz</p>
CH06		<p>Agilent Spectrum Analyzer - Swept SA</p> <p>Center Freq 2.43700000 GHz</p> <p>Ref Offset 0.5 dB Ref 6.50 dBm</p> <p>Mkr1 2.438 498 1 GHz 3.217 dBm</p> <p>Center 2.437000 GHz #Res BW 30 kHz #VBW 100 kHz Sweep 16.00 ms (8001 pts)</p>	<p>Frequency</p> <p>Auto Tune</p> <p>Center Freq 2.43700000 GHz</p> <p>Start Freq 2.429500000 GHz</p> <p>Stop Freq 2.444500000 GHz</p> <p>CF Step 1.500000 MHz</p> <p>Auto Man</p> <p>Freq Offset 0 Hz</p>
CH11		<p>Agilent Spectrum Analyzer - Swept SA</p> <p>Center Freq 2.46200000 GHz</p> <p>Ref Offset 0.5 dB Ref 6.50 dBm</p> <p>Mkr1 2.464 508 8 GHz 3.367 dBm</p> <p>Center 2.462000 GHz #Res BW 30 kHz #VBW 100 kHz Sweep 16.00 ms (8001 pts)</p>	<p>Frequency</p> <p>Auto Tune</p> <p>Center Freq 2.46200000 GHz</p> <p>Start Freq 2.454500000 GHz</p> <p>Stop Freq 2.469500000 GHz</p> <p>CF Step 1.500000 MHz</p> <p>Auto Man</p> <p>Freq Offset 0 Hz</p>

Type:		802.11 g	
CH01		<p>Agilent Spectrum Analyzer - Sweep SA Center Freq 2.41200000 GHz Ref Offset 0.5 dB Ref 6.50 dBm Mkr1 2.414 488 GHz -5.896 dBm Span 25.00 MHz #Res BW 30 kHz #VBW 100 kHz Sweep 26.67 ms (8001 pts)</p>	<p>Frequency</p> <p>Auto Tune</p> <p>Center Freq 2.41200000 GHz</p> <p>Start Freq 2.399500000 GHz</p> <p>Stop Freq 2.424500000 GHz</p> <p>CF Step 2.500000 MHz Auto Man</p> <p>Freq Offset 0 Hz</p>
CH06		<p>Agilent Spectrum Analyzer - Sweep SA Center Freq 2.43700000 GHz Ref Offset 0.5 dB Ref 6.50 dBm Mkr1 2.444 500 GHz -4.230 dBm Span 25.00 MHz #Res BW 30 kHz #VBW 100 kHz Sweep 26.67 ms (8001 pts)</p>	<p>Frequency</p> <p>Auto Tune</p> <p>Center Freq 2.437000000 GHz</p> <p>Start Freq 2.424500000 GHz</p> <p>Stop Freq 2.449500000 GHz</p> <p>CF Step 2.500000 MHz Auto Man</p> <p>Freq Offset 0 Hz</p>
CH11		<p>Agilent Spectrum Analyzer - Sweep SA Center Freq 2.46200000 GHz Ref Offset 0.5 dB Ref 6.50 dBm Mkr1 2.464 491 GHz -4.784 dBm Span 25.00 MHz #Res BW 30 kHz #VBW 100 kHz Sweep 26.67 ms (8001 pts)</p>	<p>Frequency</p> <p>Auto Tune</p> <p>Center Freq 2.462000000 GHz</p> <p>Start Freq 2.449500000 GHz</p> <p>Stop Freq 2.474500000 GHz</p> <p>CF Step 2.500000 MHz Auto Man</p> <p>Freq Offset 0 Hz</p>

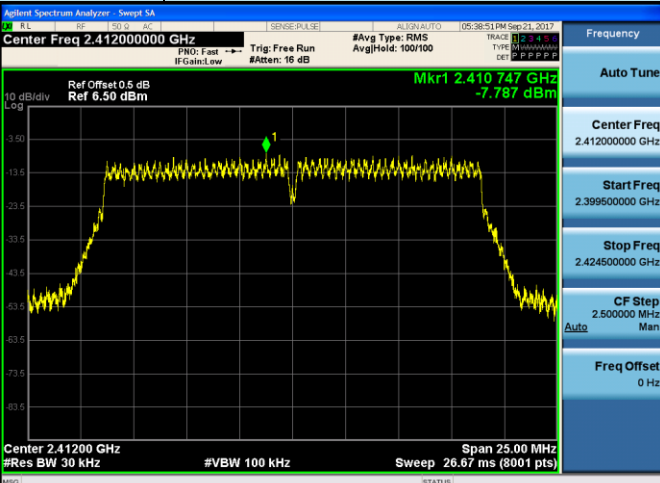
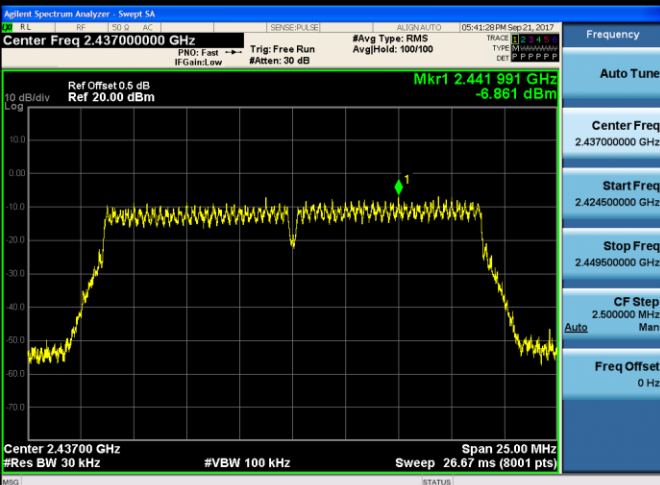
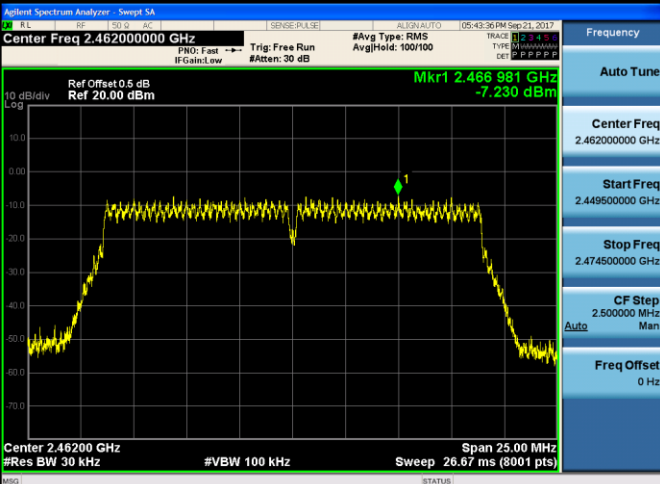
Type:		802.11n(HT20)	
CH01		<p>Agilent Spectrum Analyzer - Swept SA</p> <p>Center Freq 2.41200000 GHz</p> <p>Ref Offset 0.5 dB Ref 6.50 dBm</p> <p>Mkr1 2.410 747 GHz -7.787 dBm</p> <p>Center 2.41200 GHz #Res BW 30 kHz #VBW 100 kHz Sweep 26.67 ms (8001 pts)</p>	<p>Frequency</p> <p>Auto Tune</p> <p>Center Freq 2.41200000 GHz</p> <p>Start Freq 2.399500000 GHz</p> <p>Stop Freq 2.424500000 GHz</p> <p>CF Step 2.500000 MHz Auto Man</p> <p>Freq Offset 0 Hz</p>
CH06		<p>Agilent Spectrum Analyzer - Swept SA</p> <p>Center Freq 2.43700000 GHz</p> <p>Ref Offset 0.5 dB Ref 20.00 dBm</p> <p>Mkr1 2.441 991 GHz -6.861 dBm</p> <p>Center 2.43700 GHz #Res BW 30 kHz #VBW 100 kHz Sweep 26.67 ms (8001 pts)</p>	<p>Frequency</p> <p>Auto Tune</p> <p>Center Freq 2.437000000 GHz</p> <p>Start Freq 2.424500000 GHz</p> <p>Stop Freq 2.449500000 GHz</p> <p>CF Step 2.500000 MHz Auto Man</p> <p>Freq Offset 0 Hz</p>
CH11		<p>Agilent Spectrum Analyzer - Swept SA</p> <p>Center Freq 2.46200000 GHz</p> <p>Ref Offset 0.5 dB Ref 20.00 dBm</p> <p>Mkr1 2.466 981 GHz -7.230 dBm</p> <p>Center 2.46200 GHz #Res BW 30 kHz #VBW 100 kHz Sweep 26.67 ms (8001 pts)</p>	<p>Frequency</p> <p>Auto Tune</p> <p>Center Freq 2.462000000 GHz</p> <p>Start Freq 2.449500000 GHz</p> <p>Stop Freq 2.474500000 GHz</p> <p>CF Step 2.500000 MHz Auto Man</p> <p>Freq Offset 0 Hz</p>

5.5. 6dB bandwidth

LIMIT

FCC CFR Title 47 Part 15 Subpart C Section 15.247 (a)(2):For digital modulation systems, the minimum 6 dB bandwidth shall be at least 500 kHz.

TEST CONFIGURATION

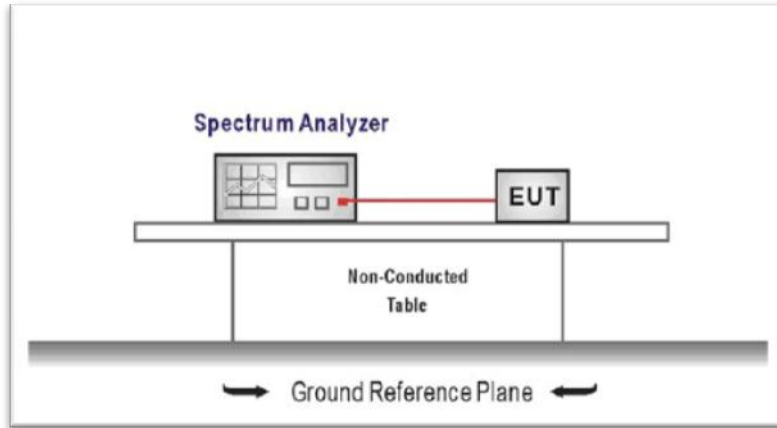

TEST PROCEDURE

1. Connect the antenna port(s) to the spectrum analyzer input.
2. Configure the spectrum analyzer as shown below (enter all losses between the transmitter output and the spectrum analyzer).
 Center Frequency =DTS channel center frequency
 Span=2 x DTS bandwidth
 RBW = 100 kHz, VBW ≥ 3 × RBW
 Sweep time= auto couple
 Detector = Peak
 Trace mode = max hold
3. Place the radio in continuous transmit mode, allow the trace to stabilize, view the transmitter wave form on the spectrum analyzer.
4. Measure the maximum width of the emission that is constrained by the frequencies associated with the two outermost amplitude points (upper and lower frequencies) that are attenuated by 6 dB relative to the maximum level measured in the fundamental emission, and record the pertinent measurements.

TEST MODE:

Please refer to the clause 3.3

TEST RESULTS

Passed **Not Applicable**

Type	Channel	6dB Bandwidth (MHz)	Limit (kHz)	Result
802.11b	01	8.970	≥500	Pass
	06	9.738		
	11	8.678		
802.11g	01	16.07	≥500	Pass
	06	16.40		
	11	16.53		
802.11n(HT20)	01	17.66	≥500	Pass
	06	17.65		
	11	17.70		

Test plot as follows:

Type:		802.11 b	
CH01	<p>Agilent Spectrum Analyzer - Occupied BW</p> <p>Center Freq 2.412000000 GHz</p> <p>Center Freq: 2.412000000 GHz</p> <p>Trig: Free Run</p> <p>Avg/Hold: 10/10</p> <p>Radio Std: None</p> <p>Radio Device: BTS</p> <p>Ref Offset 0.5 dB</p> <p>Ref 20.50 dBm</p> <p>Mkr1 2.412 GHz</p> <p>-6.0178 dBm</p> <p>Center 2.412 GHz</p> <p>#Res BW 100 kHz</p> <p>#VBW 300 kHz</p> <p>Span 25 MHz</p> <p>Sweep 2.667 ms</p> <p>Occupied Bandwidth 12.202 MHz</p> <p>Total Power 21.2 dBm</p> <p>Transmit Freq Error 44.314 kHz</p> <p>OBW Power 99.00 %</p> <p>x dB Bandwidth 8.970 MHz</p> <p>x dB -6.00 dB</p>		<p>Frequency</p> <p>Center Freq 2.41200000 GHz</p> <p>CF Step 2.500000 MHz</p> <p>Freq Offset 0 Hz</p>
CH06	<p>Agilent Spectrum Analyzer - Occupied BW</p> <p>Center Freq 2.437000000 GHz</p> <p>Center Freq: 2.437000000 GHz</p> <p>Trig: Free Run</p> <p>Avg/Hold: 10/10</p> <p>Radio Std: None</p> <p>Radio Device: BTS</p> <p>Ref Offset 0.5 dB</p> <p>Ref 20.50 dBm</p> <p>Center 2.437 GHz</p> <p>#Res BW 100 kHz</p> <p>#VBW 300 kHz</p> <p>Span 25 MHz</p> <p>Sweep 2.667 ms</p> <p>Occupied Bandwidth 12.564 MHz</p> <p>Total Power 14.9 dBm</p> <p>Transmit Freq Error -120.62 kHz</p> <p>OBW Power 99.00 %</p> <p>x dB Bandwidth 9.738 MHz</p> <p>x dB -6.00 dB</p>		<p>Frequency</p> <p>Center Freq 2.43700000 GHz</p> <p>CF Step 2.500000 MHz</p> <p>Freq Offset 0 Hz</p>
CH11	<p>Agilent Spectrum Analyzer - Occupied BW</p> <p>Center Freq 2.462000000 GHz</p> <p>Center Freq: 2.462000000 GHz</p> <p>Trig: Free Run</p> <p>Avg/Hold: 10/10</p> <p>Radio Std: None</p> <p>Radio Device: BTS</p> <p>Ref Offset 0.5 dB</p> <p>Ref 20.50 dBm</p> <p>Center 2.462 GHz</p> <p>#Res BW 100 kHz</p> <p>#VBW 300 kHz</p> <p>Span 25 MHz</p> <p>Sweep 2.667 ms</p> <p>Occupied Bandwidth 12.582 MHz</p> <p>Total Power 21.6 dBm</p> <p>Transmit Freq Error -31.182 kHz</p> <p>OBW Power 99.00 %</p> <p>x dB Bandwidth 8.678 MHz</p> <p>x dB -6.00 dB</p>		<p>Frequency</p> <p>Center Freq 2.46200000 GHz</p> <p>CF Step 2.500000 MHz</p> <p>Freq Offset 0 Hz</p>

Type:		802.11 g	
CH01	<p>Agilent Spectrum Analyzer - Occupied BW Center Freq: 2.412000000 GHz Ref Offset 0.5 dB, Ref 20.50 dBm Occupied Bandwidth: 16.442 MHz Total Power: 14.5 dBm Transmit Freq Error: 26.511 kHz x dB Bandwidth: 16.07 MHz</p>	<p>Frequency</p> <p>Center Freq 2.41200000 GHz</p> <p>CF Step 4.000000 MHz</p> <p>Freq Offset 0 Hz</p>	
CH06	<p>Agilent Spectrum Analyzer - Occupied BW Center Freq: 2.437000000 GHz Ref Offset 0.5 dB, Ref 20.50 dBm Occupied Bandwidth: 16.467 MHz Total Power: 15.1 dBm Transmit Freq Error: 47.804 kHz x dB Bandwidth: 16.40 MHz</p>	<p>Frequency</p> <p>Center Freq 2.43700000 GHz</p> <p>CF Step 4.000000 MHz</p> <p>Freq Offset 0 Hz</p>	
CH11	<p>Agilent Spectrum Analyzer - Occupied BW Center Freq: 2.462000000 GHz Ref Offset 0.5 dB, Ref 20.50 dBm Occupied Bandwidth: 16.456 MHz Total Power: 15.1 dBm Transmit Freq Error: 5.728 kHz x dB Bandwidth: 16.53 MHz</p>	<p>Frequency</p> <p>Center Freq 2.46200000 GHz</p> <p>CF Step 4.000000 MHz</p> <p>Freq Offset 0 Hz</p>	

Type:		802.11n(HT20)	
CH01	<p>Agilent Spectrum Analyzer - Occupied BW</p> <p>Center Freq: 2.412000000 GHz</p> <p>Occupied Bandwidth: 17.611 MHz</p> <p>Total Power: 12.6 dBm</p>	<p>Frequency</p> <p>Center Freq: 2.412000000 GHz</p> <p>CF Step: 4.000000 MHz</p> <p>Freq Offset: 0 Hz</p>	
CH06	<p>Agilent Spectrum Analyzer - Occupied BW</p> <p>Center Freq: 2.437000000 GHz</p> <p>Occupied Bandwidth: 17.629 MHz</p> <p>Total Power: 13.1 dBm</p>	<p>Frequency</p> <p>Center Freq: 2.437000000 GHz</p> <p>CF Step: 4.000000 MHz</p> <p>Freq Offset: 0 Hz</p>	
CH11	<p>Agilent Spectrum Analyzer - Occupied BW</p> <p>Center Freq: 2.462000000 GHz</p> <p>Occupied Bandwidth: 17.644 MHz</p> <p>Total Power: 13.2 dBm</p>	<p>Frequency</p> <p>Center Freq: 2.462000000 GHz</p> <p>CF Step: 4.000000 MHz</p> <p>Freq Offset: 0 Hz</p>	

5.6. Restricted band

LIMIT

FCC CFR Title 47 Part 15 Subpart C Section 15.247 (d):In any 100 kHz bandwidth outside the frequency band in which the spread spectrum or digitally modulated intentional radiator is operating, Radiated Emissions which fall in the restricted bands, as defined in §15.205(a), must also comply with the Radiated Emissions limits specified in §15.209(a) (see §15.205(c)).

TEST CONFIGURATION

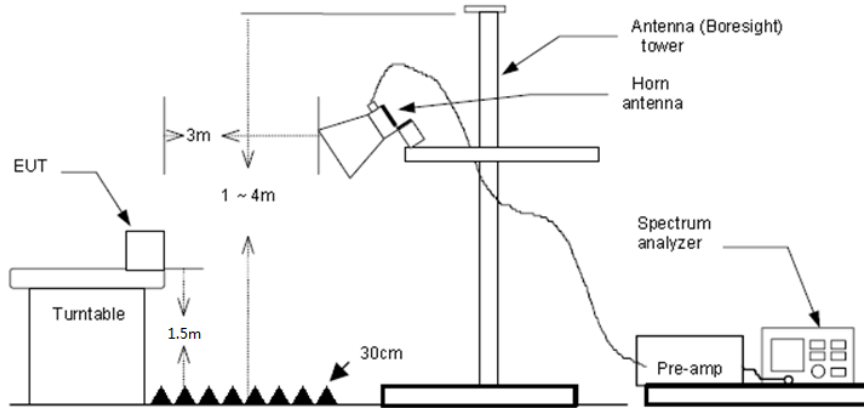

TEST PROCEDURE

- 1) The EUT was setup and tested according to ANSI C63.10:2013 for compliance to FCC 47CFR 15.247 requirements.
- 2) The EUT is placed on a turn table which is 1.5 meter above ground. The turn table is rotated 360 degrees to determine the position of the maximum emission level.
- 3) The EUT was positioned such that the distance from antenna to the EUT was 3 meters.
- 4) The antenna is scanned from 1 meter to 4 meters to find out the maximum emission level. This is repeated for both horizontal and vertical polarization of the antenna. In order to find the maximum emission, all of the interface cables were manipulated according to ANSI C63.10:2013 on radiated measurement.
- 5) The receiver set as follow:
 RBW=1MHz, VBW=3MHz PEAK detector for Peak value.
 RBW=1MHz, VBW=3MHz RMS detector for Average value.

TEST MODE:

Please refer to the clause 3.3

TEST RESULTS

Passed Not Applicable

Note:

- 1) Final level= Read level + Antenna Factor+ Cable Loss- Preamp Factor

802.11b					CH01				
Frequency (MHz)	Read Level (dBuV)	Antenna Factor (dB/m)	Cable Loss (dB)	Preamp Factor (dB)	Level (dBuV/m)	Limit Line (dBuV/m)	Over Limit (dB)	Polarization	Test value
2310.00	14.56	28.05	6.62	0.00	49.23	74.00	-24.77	Vertical	Peak
2390.01	13.43	27.65	6.75	0.00	47.83	74.00	-26.17	Vertical	Peak
2310.00	12.74	28.05	6.62	0.00	47.41	74.00	-26.59	Horizontal	Peak
2390.01	13.77	27.65	6.75	0.00	48.17	74.00	-25.83	Horizontal	Peak
2310.00	11.23	28.05	6.62	0.00	45.90	54.00	-8.10	Vertical	Average
2390.01	10.77	27.65	6.75	0.00	45.17	54.00	-8.83	Vertical	Average
2310.00	11.22	28.05	6.62	0.00	45.89	54.00	-8.11	Horizontal	Average
2390.01	10.73	27.65	6.75	0.00	45.13	54.00	-8.87	Horizontal	Average

802.11b					CH11				
Frequency (MHz)	Read Level (dBuV)	Antenna Factor (dB/m)	Cable Loss (dB)	Preamp Factor (dB)	Level (dBuV/m)	Limit Line (dBuV/m)	Over Limit (dB)	Polarization	Test value
2483.49	18.28	27.26	6.83	0.00	52.37	74.00	-21.63	Vertical	Peak
2500.00	17.11	27.20	6.84	0.00	51.15	74.00	-22.85	Vertical	Peak
2483.49	17.22	27.26	6.83	0.00	51.31	74.00	-22.69	Horizontal	Peak
2500.00	17.56	27.20	6.84	0.00	51.60	74.00	-22.40	Horizontal	Peak
2483.49	11.18	27.26	6.83	0.00	45.27	54.00	-8.73	Vertical	Average
2500.00	11.18	27.20	6.84	0.00	45.22	54.00	-8.78	Vertical	Average
2483.49	11.17	27.26	6.83	0.00	45.26	54.00	-8.74	Horizontal	Average
2500.00	11.14	27.20	6.84	0.00	45.18	54.00	-8.82	Horizontal	Average

802.11g					CH01				
Frequency (MHz)	Read Level (dBuV)	Antenna Factor (dB/m)	Cable Loss (dB)	Preamp Factor (dB)	Level (dBuV/m)	Limit Line (dBuV/m)	Over Limit (dB)	Polarization	Test value
2310.00	18.53	28.05	6.62	0.00	53.20	74.00	-20.80	Vertical	Peak
2390.01	17.75	27.65	6.75	0.00	52.15	74.00	-21.85	Vertical	Peak
2310.00	17.41	28.05	6.62	0.00	52.08	74.00	-21.92	Horizontal	Peak
2390.01	18.16	27.65	6.75	0.00	52.56	74.00	-21.44	Horizontal	Peak
2310.00	11.62	28.05	6.62	0.00	46.29	54.00	-7.71	Vertical	Average
2390.01	15.15	27.65	6.75	0.00	49.55	54.00	-4.45	Vertical	Average
2310.00	11.68	28.05	6.62	0.00	46.35	54.00	-7.65	Horizontal	Average
2390.01	13.81	27.65	6.75	0.00	48.21	54.00	-5.79	Horizontal	Average

802.11g					CH11				
Frequency (MHz)	Read Level (dBuV)	Antenna Factor (dB/m)	Cable Loss (dB)	Preamp Factor (dB)	Level (dBuV/m)	Limit Line (dBuV/m)	Over Limit (dB)	Polarization	Test value
2483.49	23.79	27.26	6.83	0.00	57.88	74.00	-16.12	Vertical	Peak
2500.00	17.79	27.20	6.84	0.00	51.83	74.00	-22.17	Vertical	Peak
2483.49	25.76	27.26	6.83	0.00	59.85	74.00	-14.15	Horizontal	Peak
2500.00	18.67	27.20	6.84	0.00	52.71	74.00	-21.29	Horizontal	Peak
2483.49	14.90	27.26	6.83	0.00	48.99	54.00	-5.01	Vertical	Average
2500.00	11.27	27.20	6.84	0.00	45.31	54.00	-8.69	Vertical	Average
2483.49	13.88	27.26	6.83	0.00	47.97	54.00	-6.03	Horizontal	Average
2500.00	11.30	27.20	6.84	0.00	45.34	54.00	-8.66	Horizontal	Average

802.11n(HT20)					CH01				
Frequency (MHz)	Read Level (dBuV)	Antenna Factor (dB/m)	Cable Loss (dB)	Preamp Factor (dB)	Level (dBuV/m)	Limit Line (dBuV/m)	Over Limit (dB)	Polarization	Test value
2310.00	16.62	28.05	6.62	0.00	51.29	74.00	-22.71	Vertical	Peak
2390.00	17.11	27.65	6.75	0.00	51.51	74.00	-22.49	Vertical	Peak
2310.00	15.80	28.05	6.62	0.00	50.47	74.00	-23.53	Horizontal	Peak
2390.00	17.64	27.65	6.75	0.00	52.04	74.00	-21.96	Horizontal	Peak
2310.00	11.67	28.05	6.62	0.00	46.34	54.00	-7.66	Vertical	Average
2390.00	11.58	27.65	6.75	0.00	45.98	54.00	-8.02	Vertical	Average
2310.00	11.67	28.05	6.62	0.00	46.34	54.00	-7.66	Horizontal	Average
2390.00	12.47	27.65	6.75	0.00	46.87	54.00	-7.13	Horizontal	Average

802.11n(HT20)					CH11				
Frequency (MHz)	Read Level (dBuV)	Antenna Factor (dB/m)	Cable Loss (dB)	Preamp Factor (dB)	Level (dBuV/m)	Limit Line (dBuV/m)	Over Limit (dB)	Polarization	Test value
2483.49	22.21	27.26	6.83	0.00	56.30	74.00	-17.70	Vertical	Peak
2500.00	16.68	27.20	6.84	0.00	50.72	74.00	-23.28	Vertical	Peak
2483.49	19.93	27.26	6.83	0.00	54.02	74.00	-19.98	Horizontal	Peak
2500.00	17.59	27.20	6.84	0.00	51.63	74.00	-22.37	Horizontal	Peak
2483.49	17.88	27.26	6.83	0.00	51.97	54.00	-2.03	Vertical	Average
2500.00	11.41	27.20	6.84	0.00	45.45	54.00	-8.55	Vertical	Average
2483.49	12.12	27.26	6.83	0.00	46.21	54.00	-7.79	Horizontal	Average
2500.00	11.20	27.20	6.84	0.00	45.24	54.00	-8.76	Horizontal	Average

802.11b-2412MHz Peak:

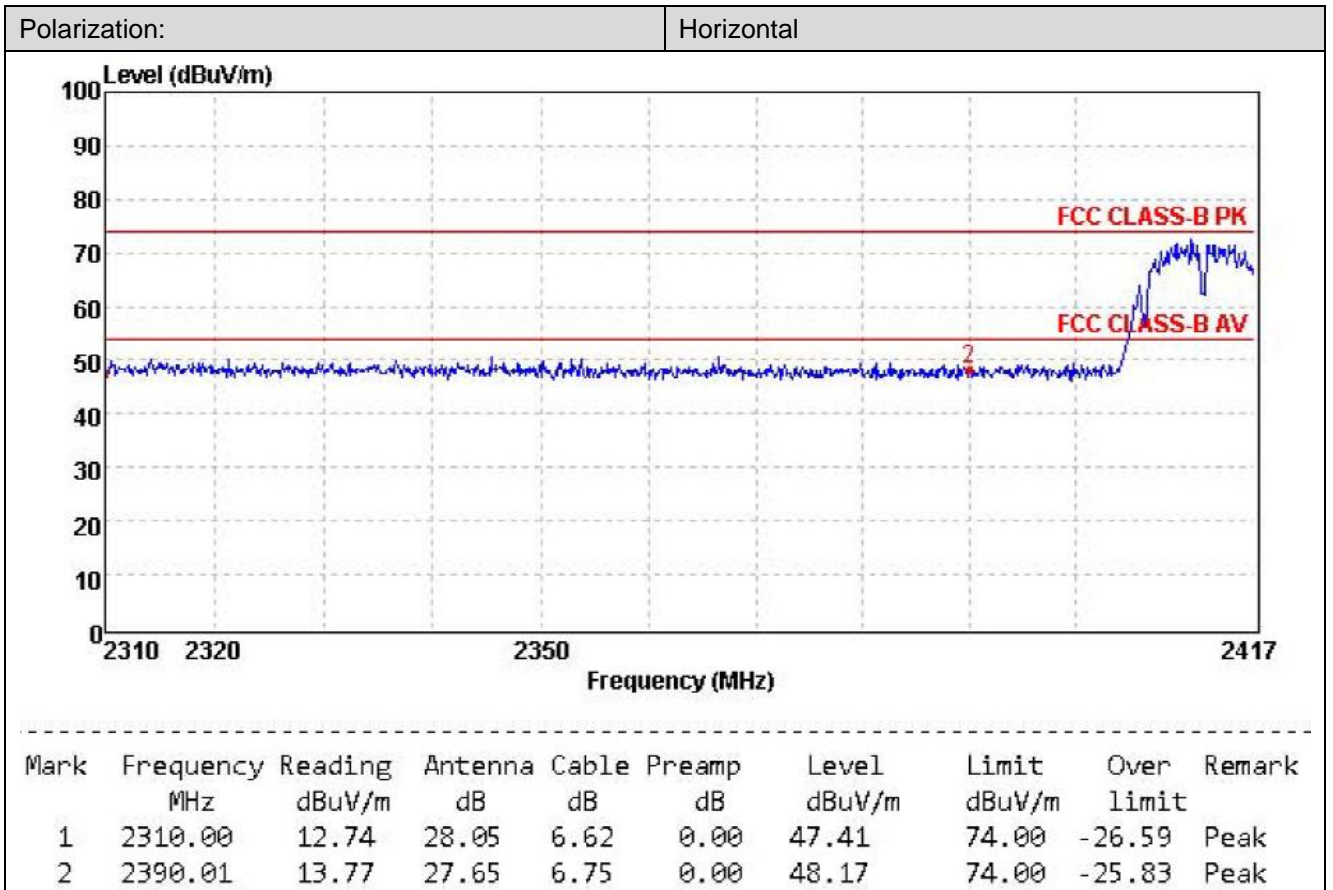
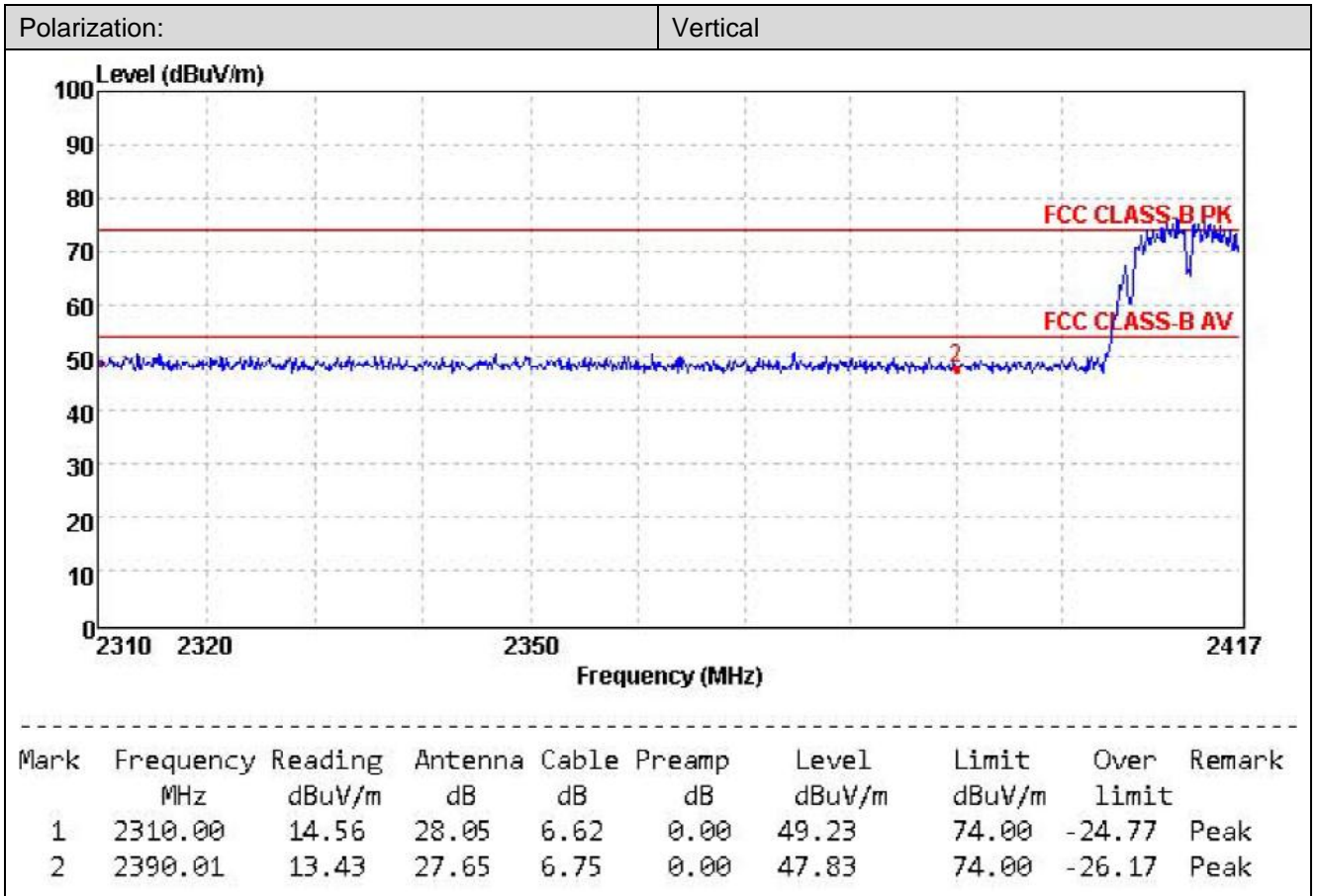

802.11b-2412MHz Average:

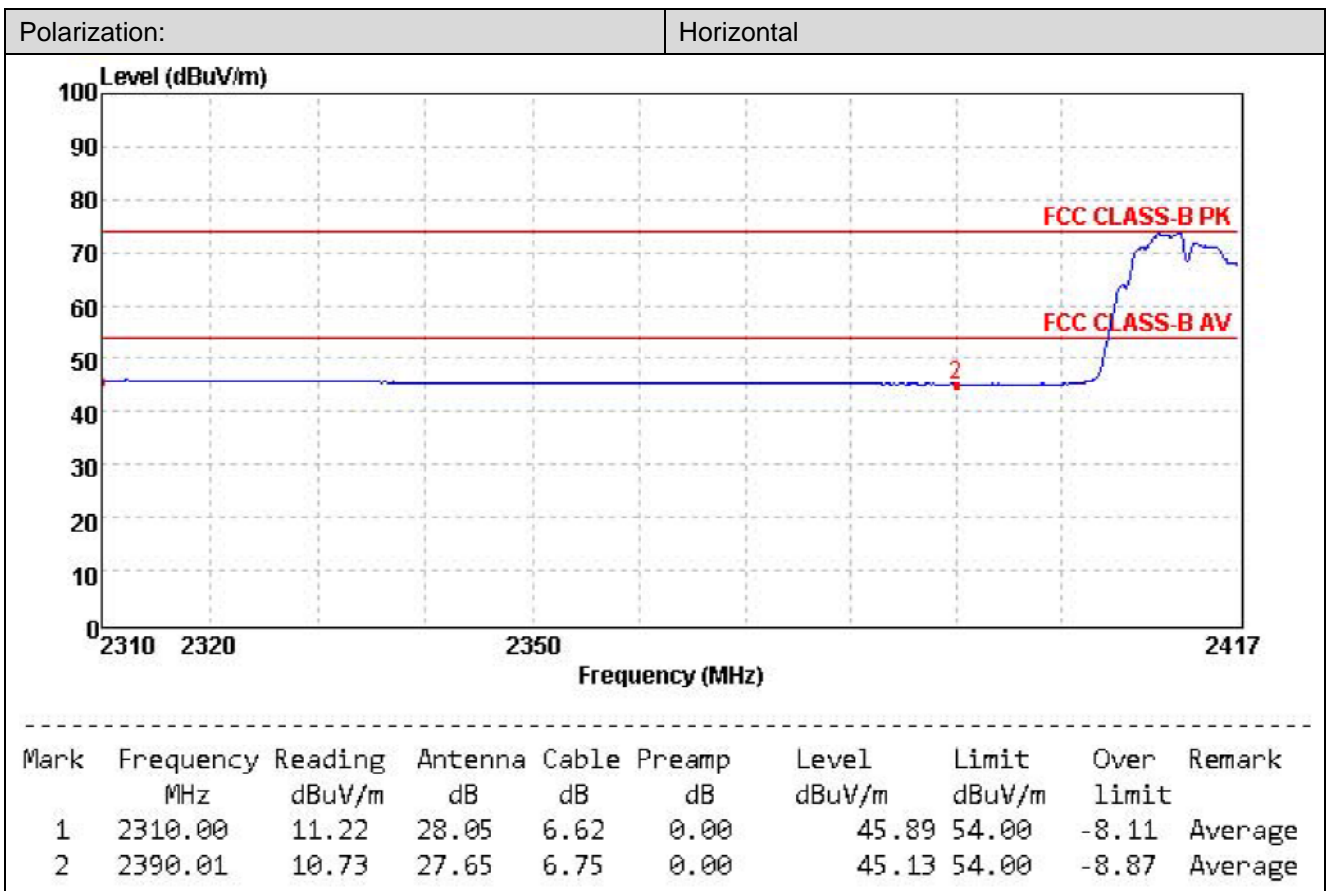
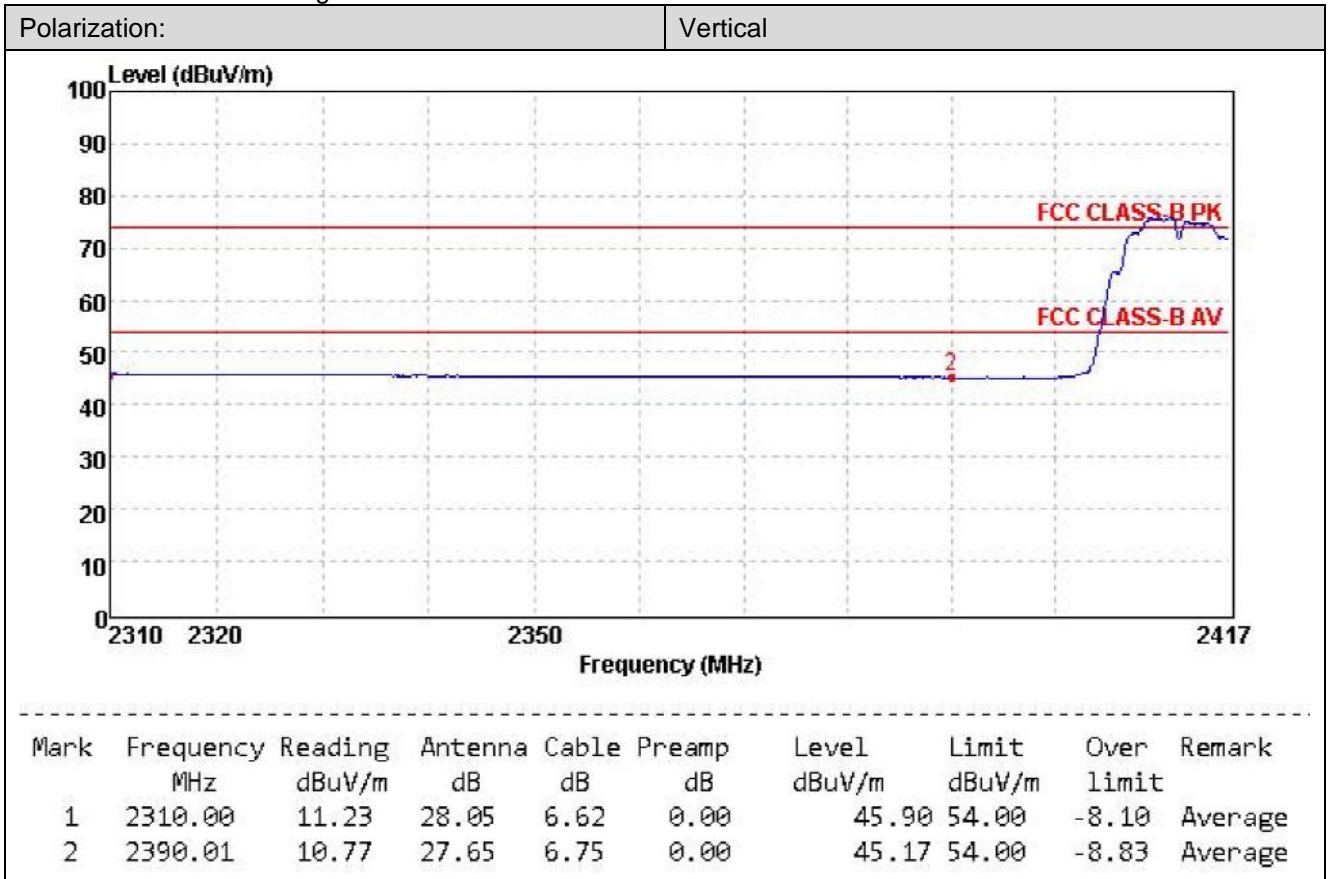

802.11b-2462MHz Peak:

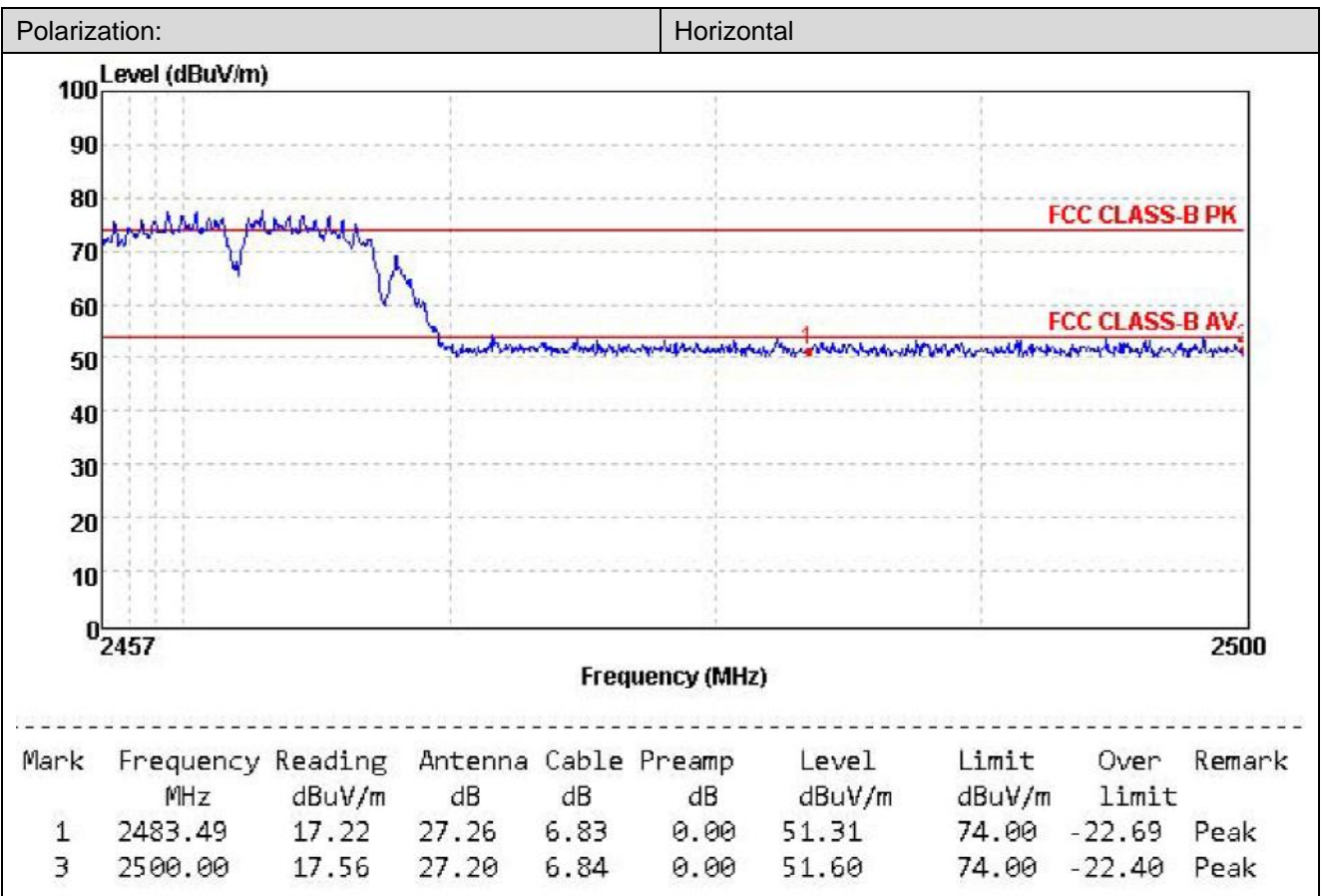
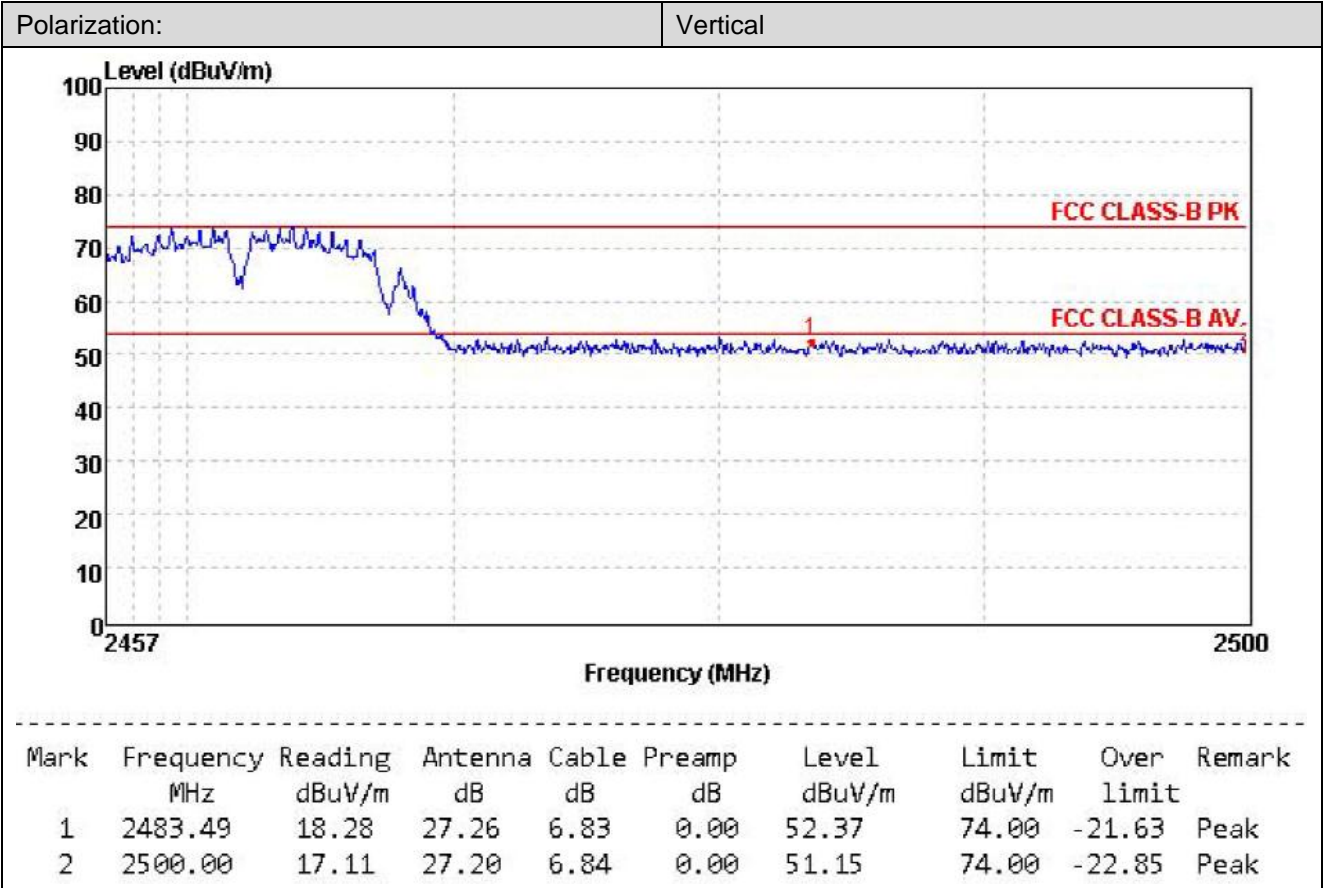

802.11b-2462MHz Average:

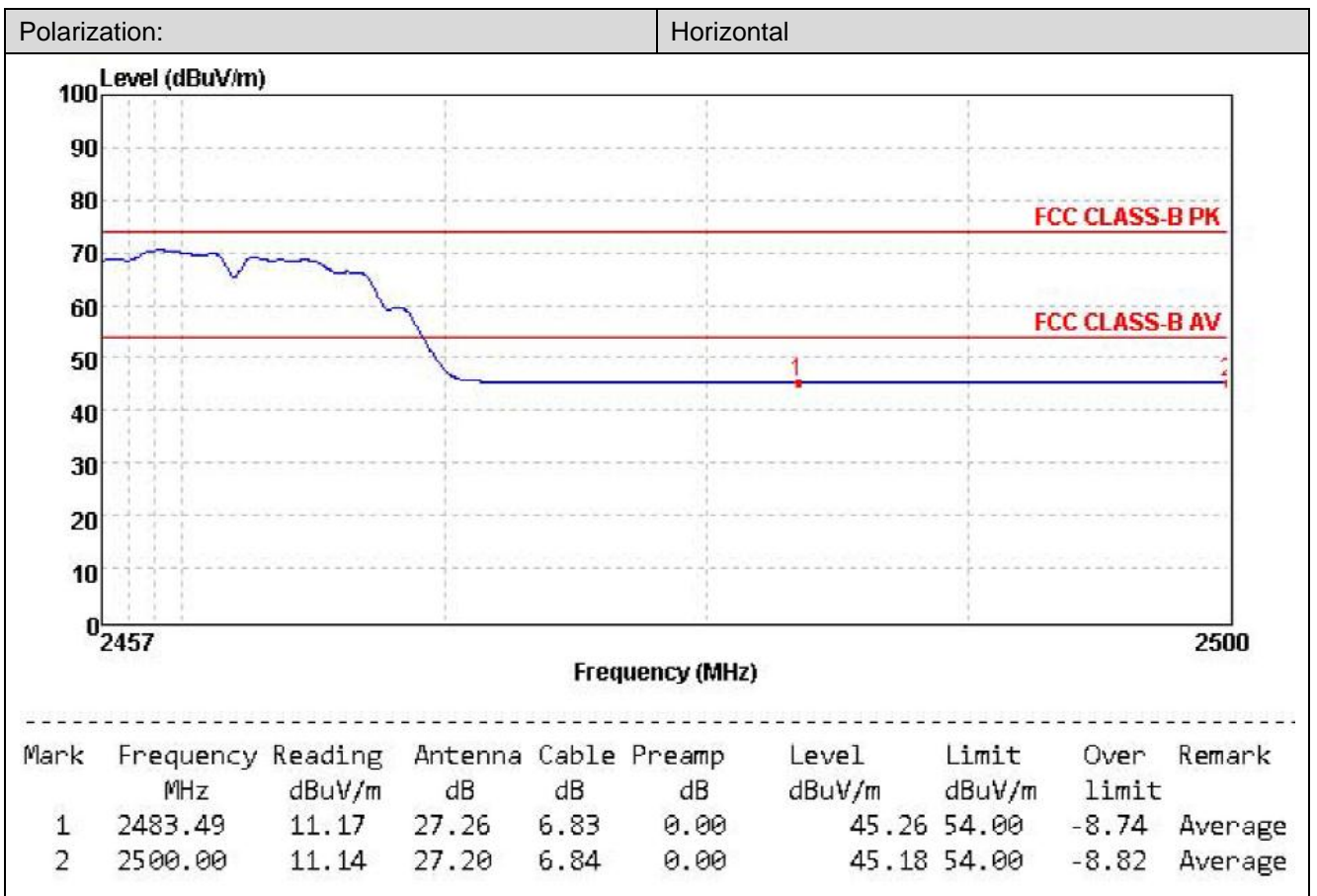
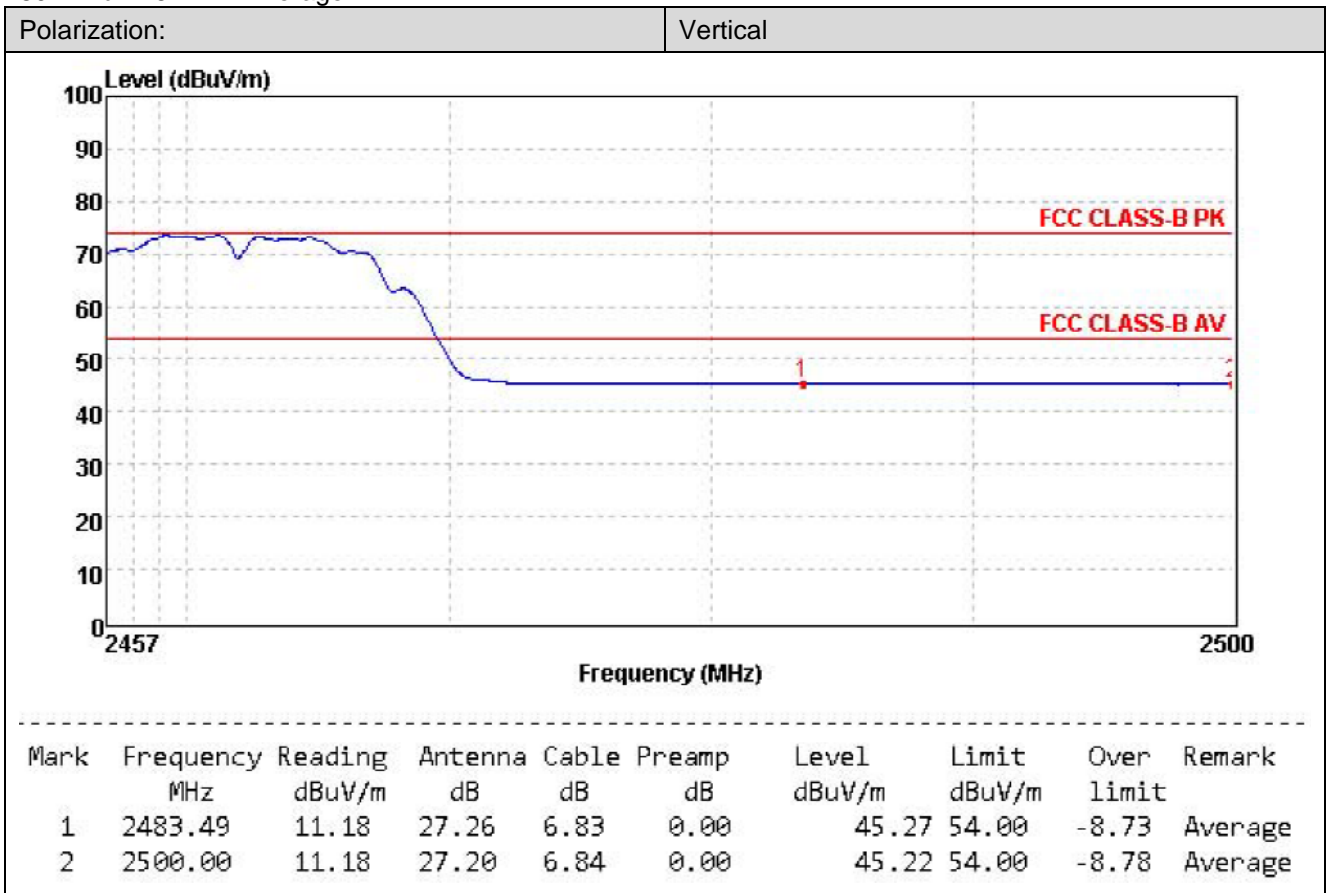

802.11g-2412MHz Peak:

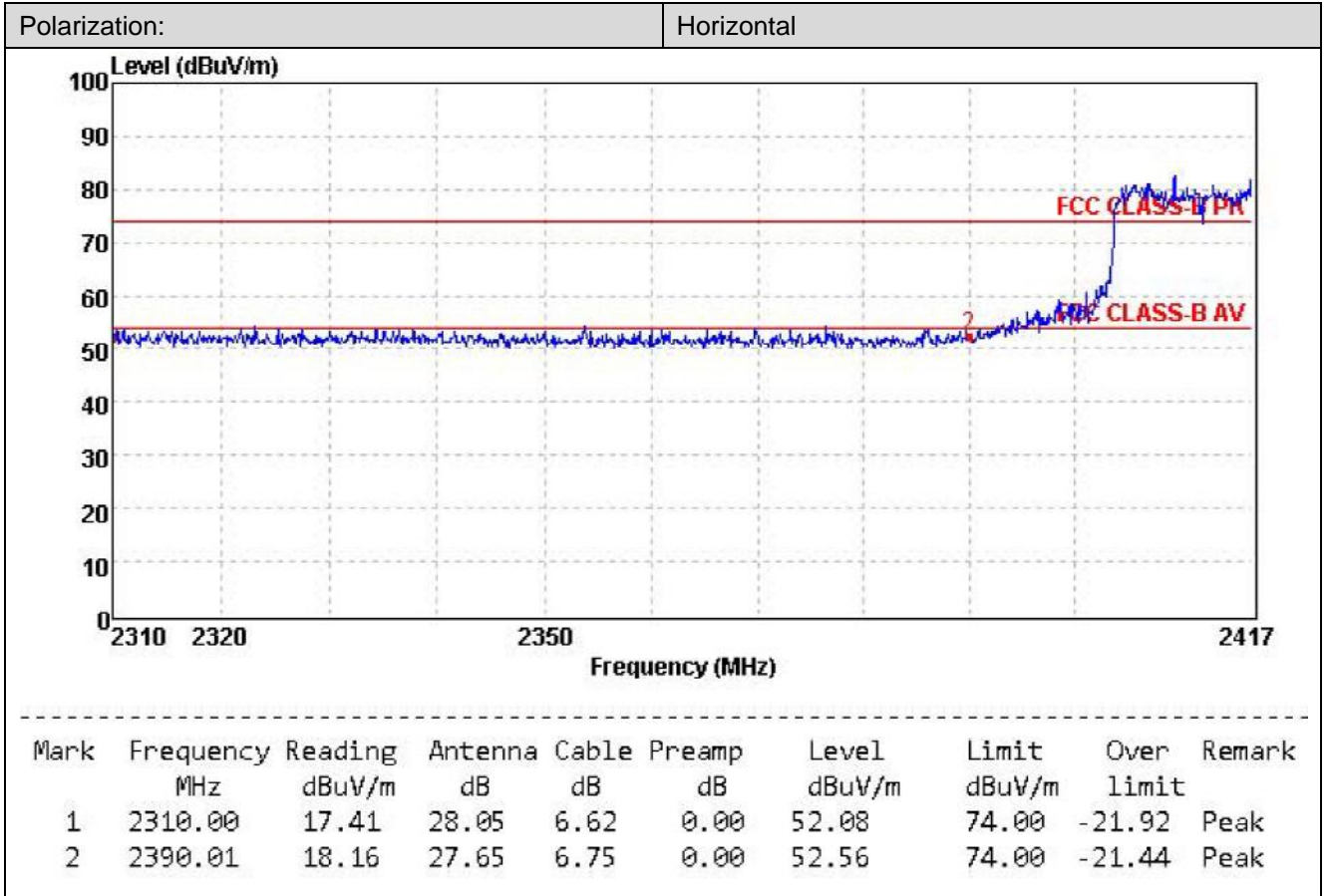
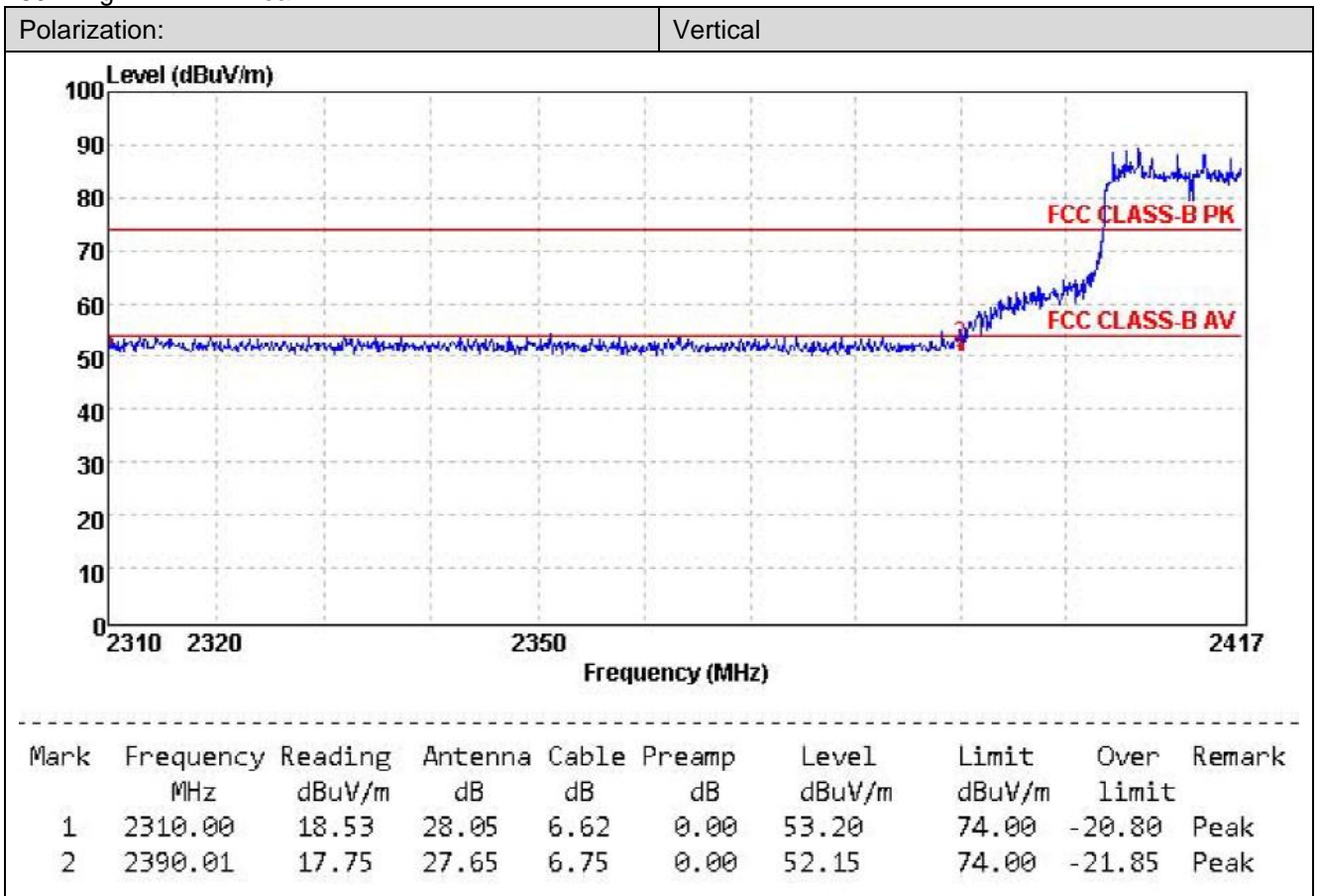

802.11g-2412MHz Average:

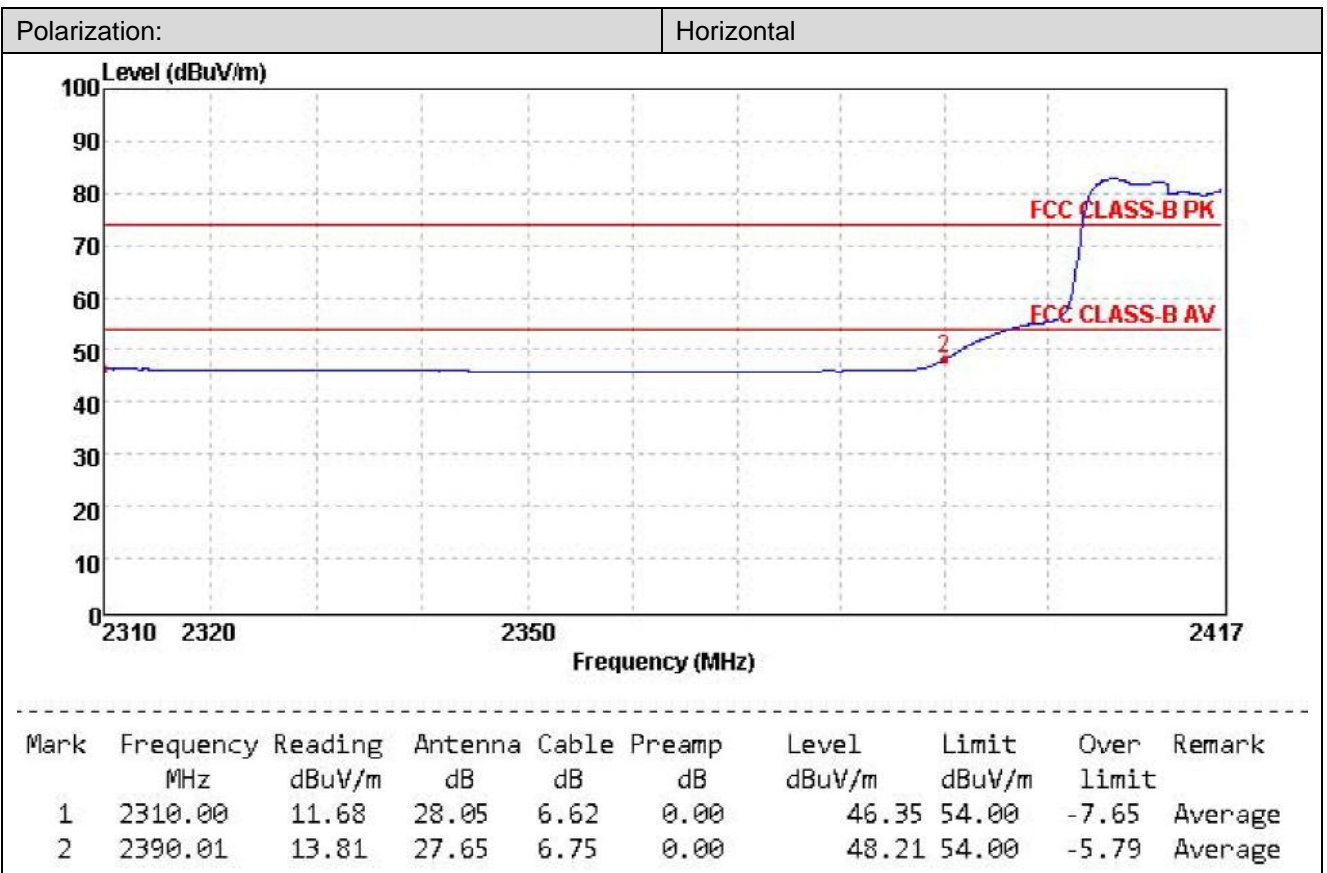
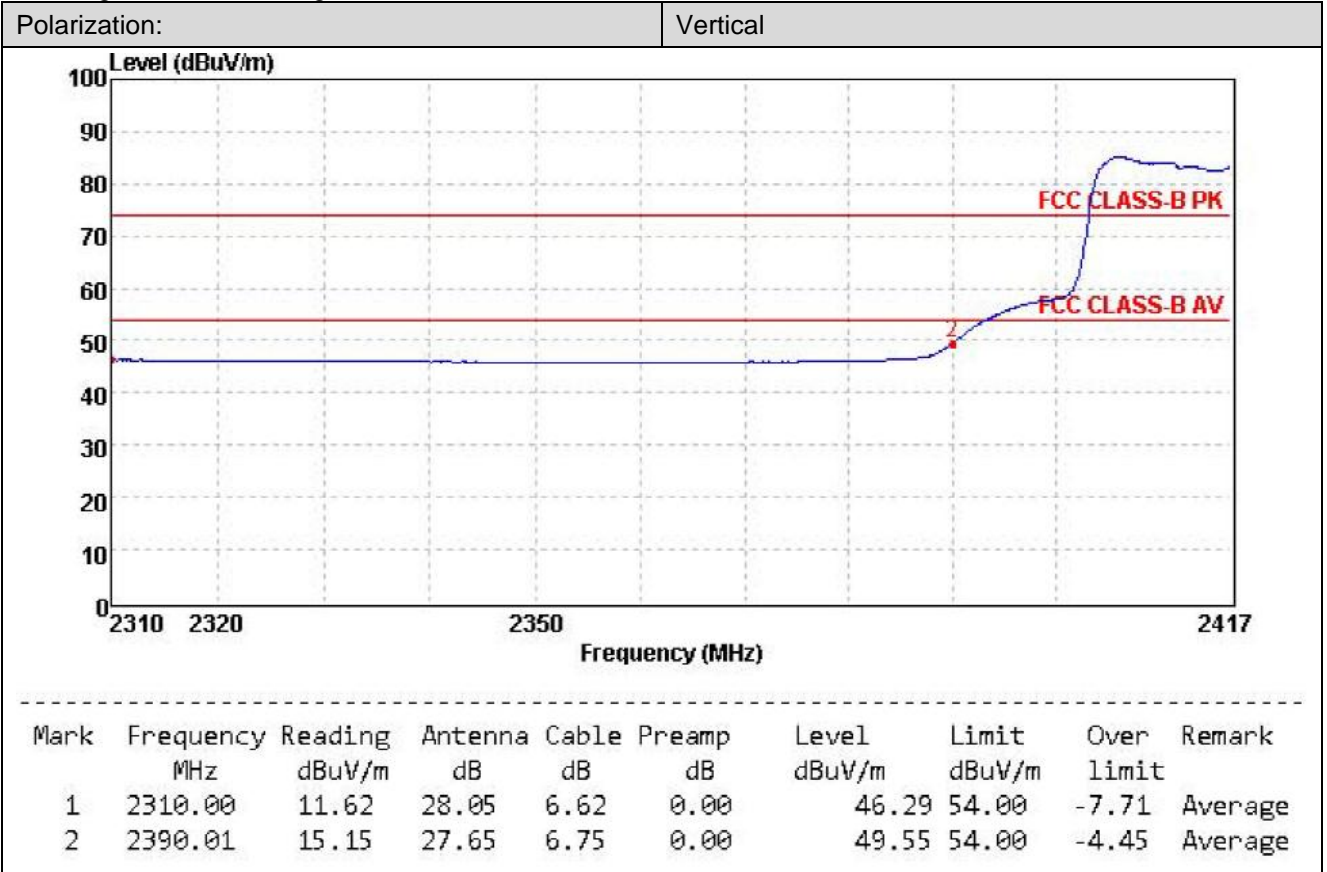

802.11g-2462MHz Peak:

