



## COMOSAR E-Field Probe Calibration Report

Ref : ACR.197.12.21.BES.B

Cancel and replace the report ACR.197.12.21.BES.A

### WALTEK TESTING GROUP (SHENZHEN) CO., LTD

1/F., ROOM 101, BUILDING 1, HONGWEI INDUSTRIAL  
PARK, LIUXIAN 2ND ROAD, BLOCK 70  
BAO'AN DISTRICT, SHENZHEN, GUANGDONG , CHINA  
MVG COMOSAR DOSIMETRIC E-FIELD PROBE  
SERIAL NO.: SN 18/21 EPG0356

Calibrated at MVG

Z.I. de la pointe du diable

Technopôle Brest Iroise – 295 avenue Alexis de Rochon  
29280 PLOUZANE - FRANCE

Calibration date: 07/08/2022



Accreditations #2-6789  
Scope available on [www.cofrac.fr](http://www.cofrac.fr)

#### Summary:

This document presents the method and results from an accredited COMOSAR E-Field Probe calibration performed at MVG, using the CALIPROBE test bench, for use with a MVG COMOSAR system only. The test results covered by accreditation are traceable to the International System of Units (SI).



	<i>Name</i>	<i>Function</i>	<i>Date</i>	<i>Signature</i>
<i>Prepared by :</i>	Jérôme Le Gall	Measurement Responsible	7/10/2022	
<i>Checked by :</i>	Jérôme Luc	Technical Manager	7/10/2022	
<i>Approved by :</i>	Yann Toutain	Laboratory Director	7/14/2022	

Yann TOUTAIN  
2022.07.14  
10:05:50 +03'00'

	<i>Customer Name</i>
<i>Distribution :</i>	Waltek Testing Group (Shenzhen) Co., Ltd

<i>Issue</i>	<i>Name</i>	<i>Date</i>	<i>Modifications</i>
A	Jérôme Luc	7/10/2022	Initial release



TABLE OF CONTENTS

1 Device Under Test .....4

2 Product Description .....4

    2.1 General Information .....4

3 Measurement Method .....4

    3.1 Linearity .....4

    3.2 Sensitivity .....5

    3.3 Lower Detection Limit .....5

    3.4 Isotropy .....5

    3.1 Boundary Effect .....5

4 Measurement Uncertainty .....6

5 Calibration Measurement Results .....6

    5.1 Sensitivity in air .....6

    5.2 Linearity .....7

    5.3 Sensitivity in liquid .....8

    5.4 Isotropy .....9

6 List of Equipment .....10



## 1 DEVICE UNDER TEST

Device Under Test	
Device Type	COMOSAR DOSIMETRIC E FIELD PROBE
Manufacturer	MVG
Model	SSE2
Serial Number	SN 18/21 EPGO356
Product Condition (new / used)	New
Frequency Range of Probe	0.15 GHz-6GHz
Resistance of Three Dipoles at Connector	Dipole 1: R1=0.221 MΩ Dipole 2: R2=0.197 MΩ Dipole 3: R3=0.195 MΩ

## 2 PRODUCT DESCRIPTION

### 2.1 GENERAL INFORMATION

MVG's COMOSAR E field Probes are built in accordance to the IEEE 1528, FCC KDB865664 D01, CENELEC EN62209 and CEI/IEC 62209 standards.



**Figure 1** – MVG COMOSAR Dosimetric E field Dipole

Probe Length	330 mm
Length of Individual Dipoles	2 mm
Maximum external diameter	8 mm
Probe Tip External Diameter	2.5 mm
Distance between dipoles / probe extremity	1 mm

## 3 MEASUREMENT METHOD

The IEEE 1528, FCC KDB865664 D01, CENELEC EN62209 and CEI/IEC 62209 standards provide recommended practices for the probe calibrations, including the performance characteristics of interest and methods by which to assess their affect. All calibrations / measurements performed meet the fore mentioned standards.

### 3.1 LINEARITY

The evaluation of the linearity was done in free space using the waveguide, performing a power sweep to cover the SAR range 0.01 W/kg to 100 W/kg.

### 3.2 SENSITIVITY

The sensitivity factors of the three dipoles were determined using a two step calibration method (air and tissue simulating liquid) using waveguides as outlined in the standards.

### 3.3 LOWER DETECTION LIMIT

The lower detection limit was assessed using the same measurement set up as used for the linearity measurement. The required lower detection limit is 10 mW/kg.

### 3.4 ISOTROPY

The axial isotropy was evaluated by exposing the probe to a reference wave from a standard dipole with the dipole mounted under the flat phantom in the test configuration suggested for system validations and checks. The probe was rotated along its main axis from 0 to 360 degrees in 15-degree steps. The hemispherical isotropy is determined by inserting the probe in a thin plastic box filled with tissue-equivalent liquid, with the plastic box illuminated with the fields from a half wave dipole. The dipole is rotated about its axis (0°–180°) in 15° increments. At each step the probe is rotated about its axis (0°–360°).

### 3.1 BOUNDARY EFFECT

The boundary effect is defined as the deviation between the SAR measured data and the expected exponential decay in the liquid when the probe is oriented normal to the interface. To evaluate this effect, the liquid filled flat phantom is exposed to fields from either a reference dipole or waveguide. With the probe normal to the phantom surface, the peak spatial average SAR is measured and compared to the analytical value at the surface.

The boundary effect uncertainty can be estimated according to the following uncertainty approximation formula based on linear and exponential extrapolations between the surface and  $d_{be} + d_{step}$  along lines that are approximately normal to the surface:

$$SAR_{uncertainty} [\%] = \Delta SAR_{be} \frac{(d_{be} + d_{step})^2}{2d_{step}} \frac{(e^{-d_{be}/(\delta/2)})}{\delta/2} \text{ for } (d_{be} + d_{step}) < 10 \text{ mm}$$

where

$SAR_{uncertainty}$

is the uncertainty in percent of the probe boundary effect

$d_{be}$

is the distance between the surface and the closest *zoom-scan* measurement point, in millimetre

$\Delta_{step}$

is the separation distance between the first and second measurement points that are closest to the phantom surface, in millimetre, assuming the boundary effect at the second location is negligible

$\delta$

is the minimum penetration depth in millimetres of the head tissue-equivalent liquids defined in this standard, i.e.,  $\delta \approx 14$  mm at 3 GHz;

$\Delta SAR_{be}$

in percent of SAR is the deviation between the measured SAR value, at the distance  $d_{be}$  from the boundary, and the analytical SAR value.





The measured worst case boundary effect SARuncertainty[%] for scanning distances larger than 4mm is 1.0% Limit ,2%).

**4 MEASUREMENT UNCERTAINTY**

The guidelines outlined in the IEEE 1528, OET 65 Bulletin C, CENELEC EN50361 and CEI/IEC 62209 standards were followed to generate the measurement uncertainty associated with an E-field probe calibration using the waveguide technique. All uncertainties listed below represent an expanded uncertainty expressed at approximately the 95% confidence level using a coverage factor of k=2, traceable to the Internationally Accepted Guides to Measurement Uncertainty.

Uncertainty analysis of the probe calibration in waveguide					
ERROR SOURCES	Uncertainty value (%)	Probability Distribution	Divisor	ci	Standard Uncertainty (%)
Expanded uncertainty 95 % confidence level k = 2					14 %

**5 CALIBRATION MEASUREMENT RESULTS**

Calibration Parameters	
Liquid Temperature	20 +/- 1 °C
Lab Temperature	20 +/- 1 °C
Lab Humidity	30-70 %

**5.1 SENSITIVITY IN AIR**

Normx dipole 1 (µV/(V/m) <sup>2</sup> )	Normy dipole 2 (µV/(V/m) <sup>2</sup> )	Normz dipole 3 (µV/(V/m) <sup>2</sup> )
0.98	0.94	0.75

DCP dipole 1 (mV)	DCP dipole 2 (mV)	DCP dipole 3 (mV)
105	107	104

Calibration curves ei=f(V) (i=1,2,3) allow to obtain E-field value using the formula:

$$E = \sqrt{E_1^2 + E_2^2 + E_3^2}$$

### Calibration curves

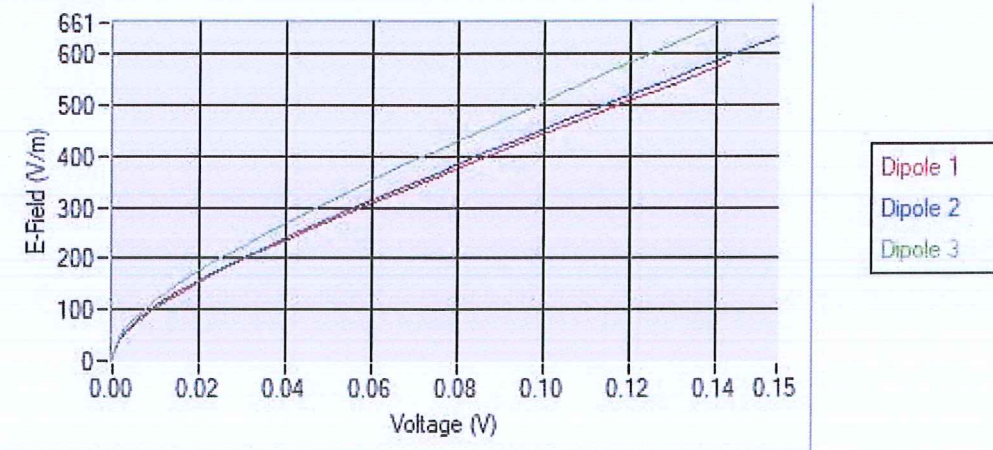

## 5.2 LINEARITY

### Linearity

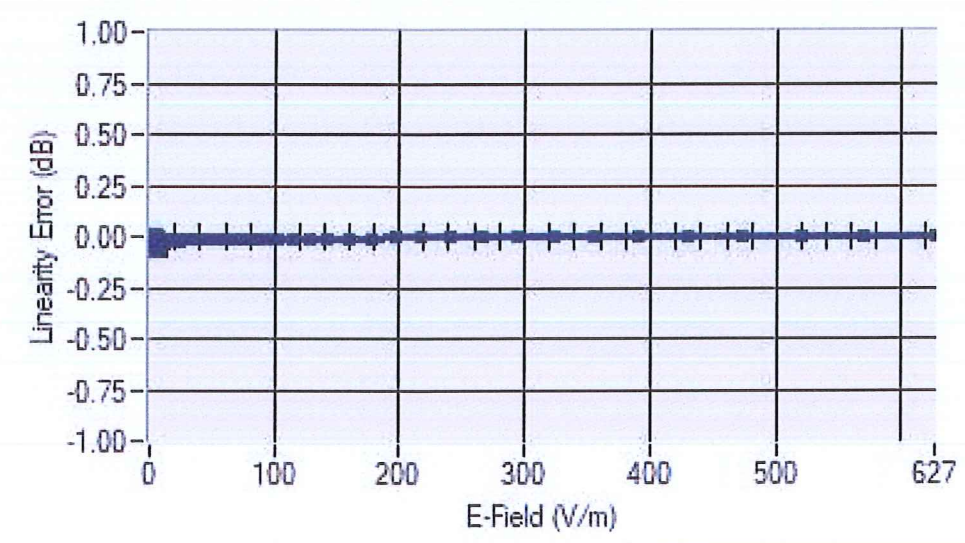

Linearity: +/-1.73% (+/-0.08dB)



5.3 SENSITIVITY IN LIQUID

<u>Liquid</u>	<u>Frequency (MHz +/- 100MHz)</u>	<u>ConvF</u>
HL750	750	1.66
BL750	750	1.76
HL850	835	1.71
BL850	835	1.78
HL900	900	1.88
BL900	900	1.85
HL1800	1800	2.11
BL1800	1800	2.15
HL1900	1900	2.21
BL1900	1900	2.30
HL2000	2000	2.41
BL2000	2000	2.39
HL2450	2450	2.29
BL2450	2450	2.60
HL2600	2600	2.22
BL2600	2600	2.41
HL3300	3300	2.64
BL3300	3300	2.16
HL3500	3500	2.05
BL3500	3500	2.20
HL3700	3700	2.27
BL3700	3700	2.24
HL3900	3900	2.38
BL3900	3900	2.45
HL4200	4200	2.42
BL4200	4200	2.53
HL4600	4600	2.41
BL4600	4600	2.64
HL4900	4900	2.21
BL4900	4900	2.46
HL5200	5200	1.91
BL5200	5200	1.84
HL5400	5400	2.12
BL5400	5400	2.02
HL5600	5600	2.25
BL5600	5600	2.20
HL5800	5800	2.14
BL5800	5800	2.11

LOWER DETECTION LIMIT: 8mW/kg





5.4 ISOTROPY

HL1800 MHz

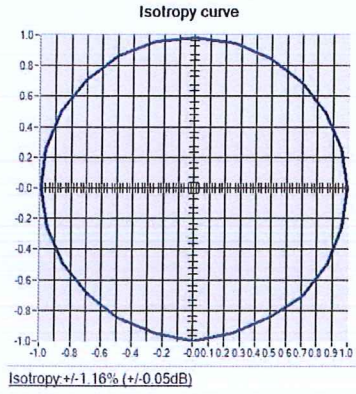



**6 LIST OF EQUIPMENT**

Equipment Summary Sheet				
Equipment Description	Manufacturer / Model	Identification No.	Current Calibration Date	Next Calibration Date
Flat Phantom	MVG	SN-20/09-SAM71	Validated. No cal required.	Validated. No cal required.
COMOSAR Test Bench	Version 3	NA	Validated. No cal required.	Validated. No cal required.
Network Analyzer	Rohde & Schwarz ZVM	100203	05/2022	05/2024
Network Analyzer – Calibration kit	Rohde & Schwarz ZV-Z235	101223	05/2022	05/2024
Multimeter	Keithley 2000	1160271	02/2020	02/2023
Signal Generator	Rohde & Schwarz SMB	106589	04/2022	04/2024
Amplifier	Aethercomm	SN 046	Characterized prior to test. No cal required.	Characterized prior to test. No cal required.
Power Meter	NI-USB 5680	170100013	05/2022	05/2024
Directional Coupler	Narda 4216-20	01386	Characterized prior to test. No cal required.	Characterized prior to test. No cal required.
Waveguide	Mega Industries	069Y7-158-13-712	Validated. No cal required.	Validated. No cal required.
Waveguide Transition	Mega Industries	069Y7-158-13-701	Validated. No cal required.	Validated. No cal required.
Waveguide Termination	Mega Industries	069Y7-158-13-701	Validated. No cal required.	Validated. No cal required.
Temperature / Humidity Sensor	Testo 184 H1	44220687	05/2020	05/2023





## SAR Reference Waveguide Calibration Report

Ref : ACR.240.1.17.SATU.A

### WALTEK TESTING GROUP (SHENZHEN) CO., LTD.

1/F, BUILDING A, HONGWEI INDUSTRIAL PARK,  
LIUXIAN 2ND ROAD BAO'AN DISTRICT SHENZHEN  
(518101), CHINA  
MVG COMOSAR REFERENCE  
WAVEGUIDE

FREQUENCY: 5000-6000 MHZ

SERIAL NO.: SN 49/16 WGA45

Calibrated at MVG US

2105 Barrett Park Dr. - Kennesaw, GA 30144



Calibration Date: 07/03/2020

#### *Summary:*

This document presents the method and results from an accredited SAR reference waveguide calibration performed in MVG USA using the COMOSAR test bench. All calibration results are traceable to national metrology institutions.



	<i>Name</i>	<i>Function</i>	<i>Date</i>	<i>Signature</i>
<i>Prepared by :</i>	Jérôme LUC	Product Manager	07/3/2020	<i>JL</i>
<i>Checked by :</i>	Jérôme LUC	Product Manager	07/3/2020	<i>JL</i>
<i>Approved by :</i>	Kim RUTKOWSKI	Quality Manager	07/3/2020	<i>Kim Rutkowski</i>

	<i>Customer Name</i>
<i>Distribution :</i>	Waltek Testing Group (Shenzhen) Co., Ltd.

<i>Issue</i>	<i>Date</i>	<i>Modifications</i>
A	07/15/2019	Initial release





**TABLE OF CONTENTS**

1 Introduction..... 4

2 Device Under Test ..... 4

3 Product Description ..... 4

    3.1 General Information ..... 4

4 Measurement Method ..... 4

    4.1 Return Loss Requirements ..... 4

    4.2 Mechanical Requirements ..... 4

5 Measurement Uncertainty ..... 5

    5.1 Return Loss ..... 5

    5.2 Dimension Measurement ..... 5

    5.3 Validation Measurement ..... 5

6 Calibration Measurement Results ..... 5

    6.1 Return Loss ..... 5

    6.2 Mechanical Dimensions ..... 6

7 Validation measurement ..... 7

    7.1 Head Liquid Measurement ..... 7

    7.2 Measurement Result ..... 7

    7.3 Body Measurement Result ..... 10

8 List of Equipment ..... 13



## 1 INTRODUCTION

This document contains a summary of the requirements set forth by the IEEE 1528 and CEI/IEC 62209 standards for reference waveguides used for SAR measurement system validations and the measurements that were performed to verify that the product complies with the fore mentioned standards.

## 2 DEVICE UNDER TEST

Device Under Test	
Device Type	COMOSAR 5000-6000 MHz REFERENCE WAVEGUIDE
Manufacturer	MVG
Model	SWG5500
Serial Number	SN 49/16 WGA45
Product Condition (new / used)	New

A yearly calibration interval is recommended.

## 3 PRODUCT DESCRIPTION

### 3.1 GENERAL INFORMATION

MVG’s COMOSAR Validation Waveguides are built in accordance to the IEEE 1528 and CEI/IEC 62209 standards.

## 4 MEASUREMENT METHOD

The IEEE 1528 and CEI/IEC 62209 standards provide requirements for reference waveguides used for system validation measurements. The following measurements were performed to verify that the product complies with the fore mentioned standards.

### 4.1 RETURN LOSS REQUIREMENTS

The waveguide used for SAR system validation measurements and checks must have a return loss of -8 dB or better. The return loss measurement shall be performed with matching layer placed in the open end of the waveguide, with the waveguide and matching layer in direct contact with the phantom shell as outlined in the fore mentioned standards.

### 4.2 MECHANICAL REQUIREMENTS

The IEEE 1528 and CEI/IEC 62209 standards specify the mechanical dimensions of the validation waveguide, the specified dimensions are as shown in Section 6.2. Figure 1 shows how the dimensions relate to the physical construction of the waveguide.



## 5 MEASUREMENT UNCERTAINTY

All uncertainties listed below represent an expanded uncertainty expressed at approximately the 95% confidence level using a coverage factor of  $k=2$ , traceable to the Internationally Accepted Guides to Measurement Uncertainty.

### 5.1 RETURN LOSS

The following uncertainties apply to the return loss measurement:

Frequency band	Expanded Uncertainty on Return Loss
400-6000MHz	0.1 dB

### 5.2 DIMENSION MEASUREMENT

The following uncertainties apply to the dimension measurements:

Length (mm)	Expanded Uncertainty on Length
3 - 300	0.05 mm

### 5.3 VALIDATION MEASUREMENT

The guidelines outlined in the IEEE 1528 and CEI/IEC 62209 standards were followed to generate the measurement uncertainty for validation measurements.

Scan Volume	Expanded Uncertainty
1 g	20.3 %
10 g	20.1 %

## 6 CALIBRATION MEASUREMENT RESULTS

### 6.1 RETURN LOSS IN HEAD LIQUID

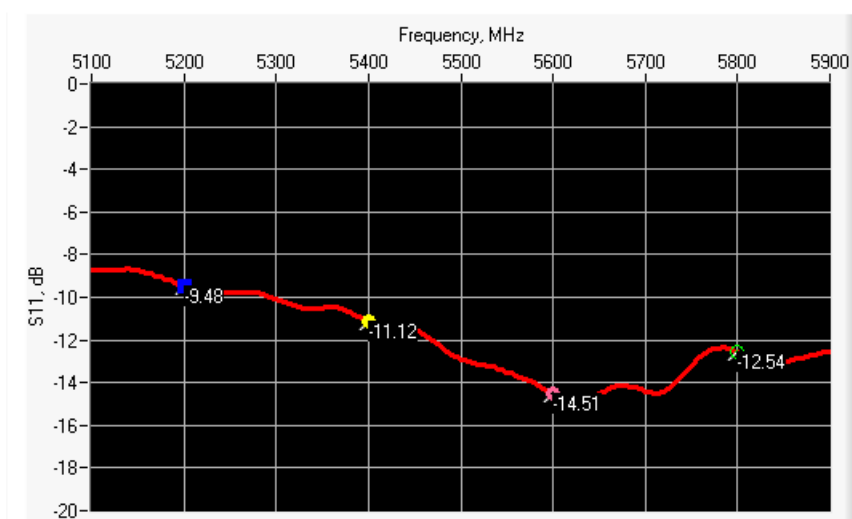

Frequency (MHz)	Return Loss (dB)	Requirement (dB)	Impedance
5200	-9.48	-8	21.44 $\Omega$ + 11.06 j $\Omega$
5400	-11.12	-8	75.61 $\Omega$ + 3.31 j $\Omega$
5600	-14.51	-8	34.43 $\Omega$ - 9.61 j $\Omega$
5800	-12.54	-8	53.85 $\Omega$ + 22.57 j $\Omega$

### 6.2 RETURN LOSS IN BODY LIQUID

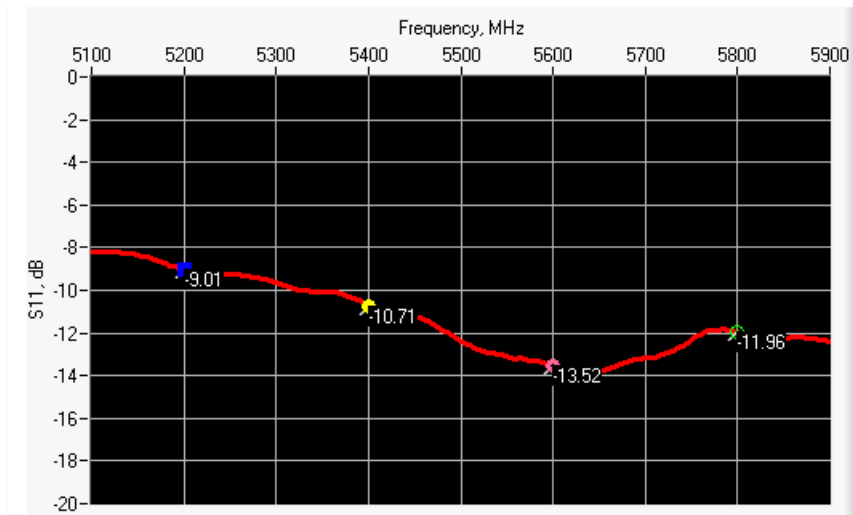

Frequency (MHz)	Return Loss (dB)	Requirement (dB)	Impedance
5200	-9.01	-8	21.02 $\Omega$ + 14.13 j $\Omega$
5400	-10.71	-8	76.84 $\Omega$ - 0.83 j $\Omega$
5600	-13.52	-8	31.10 $\Omega$ - 7.33 j $\Omega$
5800	-11.96	-8	58.01 $\Omega$ + 22.90 j $\Omega$

### 6.3 MECHANICAL DIMENSIONS

Frequency (MHz)	L (mm)		W (mm)		L <sub>r</sub> (mm)		W <sub>r</sub> (mm)		T (mm)	
	Required	Measured	Required	Measured	Required	Measured	Required	Measured	Required	Measured
5200	40.39 ± 0.13	PASS	20.19 ± 0.13	PASS	81.03 ± 0.13	PASS	61.98 ± 0.13	PASS	5.3*	PASS
5800	40.39 ± 0.13	PASS	20.19 ± 0.13	PASS	81.03 ± 0.13	PASS	61.98 ± 0.13	PASS	4.3*	PASS

\* The tolerance for the matching layer is included in the return loss measurement.

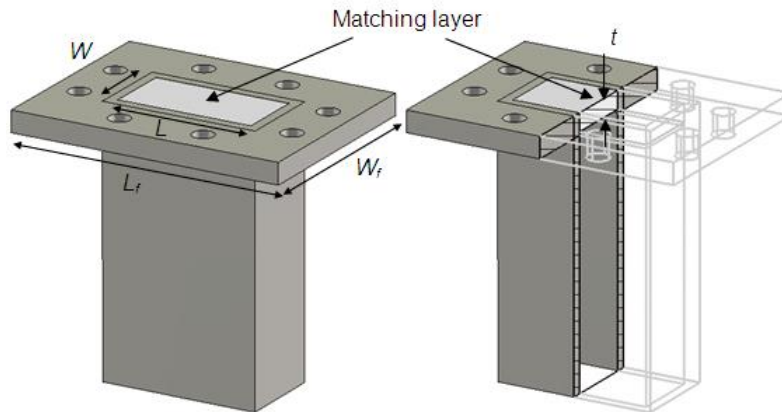

**Figure 1: Validation Waveguide Dimensions**

## 7 VALIDATION MEASUREMENT

The IEEE Std. 1528 and CEI/IEC 62209 standards state that the system validation measurements must be performed using a reference waveguide meeting the fore mentioned return loss and mechanical dimension requirements. The validation measurement must be performed with the matching layer placed in the open end of the waveguide, with the waveguide and matching layer in direct contact with the phantom shell.

### 7.1 HEAD LIQUID MEASUREMENT

Frequency MHz	Relative permittivity ( $\epsilon_r'$ )		Conductivity ( $\sigma$ ) S/m	
	required	measured	required	measured
5000	36.2 $\pm$ 10 %		4.45 $\pm$ 10 %	
5100	36.1 $\pm$ 10 %		4.56 $\pm$ 10 %	
5200	36.0 $\pm$ 10 %	PASS	4.66 $\pm$ 10 %	PASS
5300	35.9 $\pm$ 10 %		4.76 $\pm$ 10 %	
5400	35.8 $\pm$ 10 %	PASS	4.86 $\pm$ 10 %	PASS
5500	35.6 $\pm$ 10 %		4.97 $\pm$ 10 %	
5600	35.5 $\pm$ 10 %	PASS	5.07 $\pm$ 10 %	PASS
5700	35.4 $\pm$ 10 %		5.17 $\pm$ 10 %	
5800	35.3 $\pm$ 10 %	PASS	5.27 $\pm$ 10 %	PASS
5900	35.2 $\pm$ 10 %		5.38 $\pm$ 10 %	
6000	35.1 $\pm$ 10 %		5.48 $\pm$ 10 %	

### 7.2 SAR MEASUREMENT RESULT WITH HEAD LIQUID

At those frequencies, the target SAR value can not be generic. Hereunder is the target SAR value defined by MVG, within the uncertainty for the system validation. All SAR values are normalized to 1 W net power. In bracket, the measured SAR is given with the used input power.

Software	OPENSAR V4
Phantom	SN 20/09 SAM71
Probe	SN 18/11 EPG122
Liquid	Head Liquid Values 5200 MHz: eps' :35.14 sigma : 4.74 Head Liquid Values 5400 MHz: eps' :34.52 sigma : 4.77 Head Liquid Values 5600 MHz: eps' :37.08 sigma : 5.03 Head Liquid Values 5800 MHz: eps' :34.64 sigma : 5.19
Distance between dipole waveguide and liquid	0 mm
Area scan resolution	dx=8mm/dy=8mm
Zoon Scan Resolution	dx=4mm/dy=4m/dz=2mm
Frequency	5200 MHz 5400 MHz 5600 MHz 5800 MHz
Input power	20 dBm
Liquid Temperature	21 °C
Lab Temperature	21 °C
Lab Humidity	45 %

Frequency (MHz)	1 g SAR (W/kg)		10 g SAR (W/kg)	
	required	measured	required	measured
5200	159.00	161.23 (16.12)	56.90	56.14 (5.61)
5400	166.40	165.58 (16.56)	58.43	57.15 (5.71)
5600	173.80	173.58 (17.36)	59.97	59.52 (5.95)
5800	181.20	179.32 (17.93)	61.50	61.13 (6.11)

### SAR MEASUREMENT PLOTS @ 5200 MHz

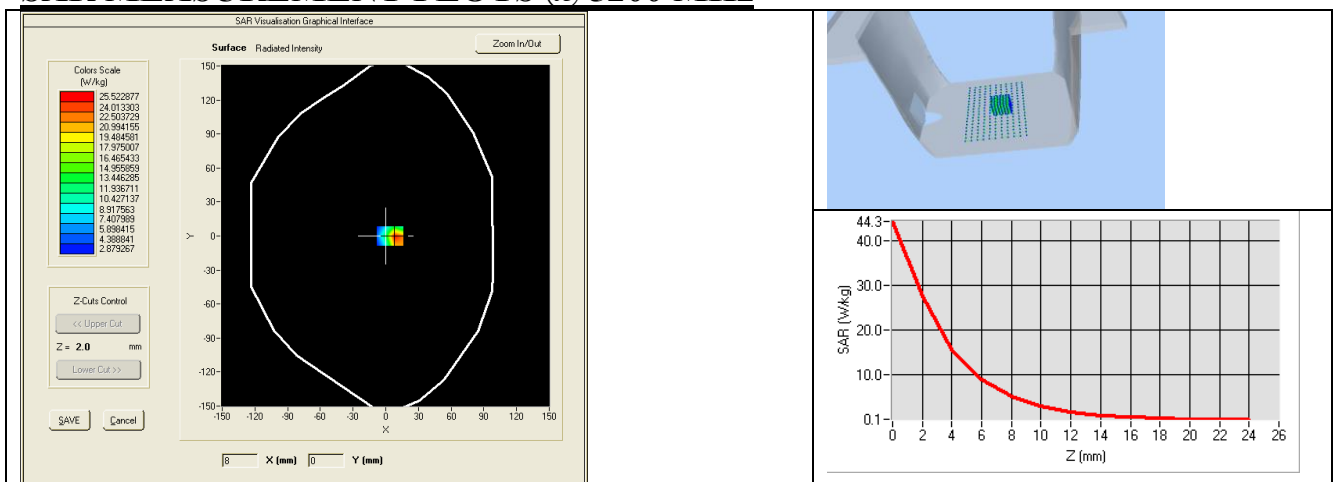



### SAR MEASUREMENT PLOTS @ 5400 MHz

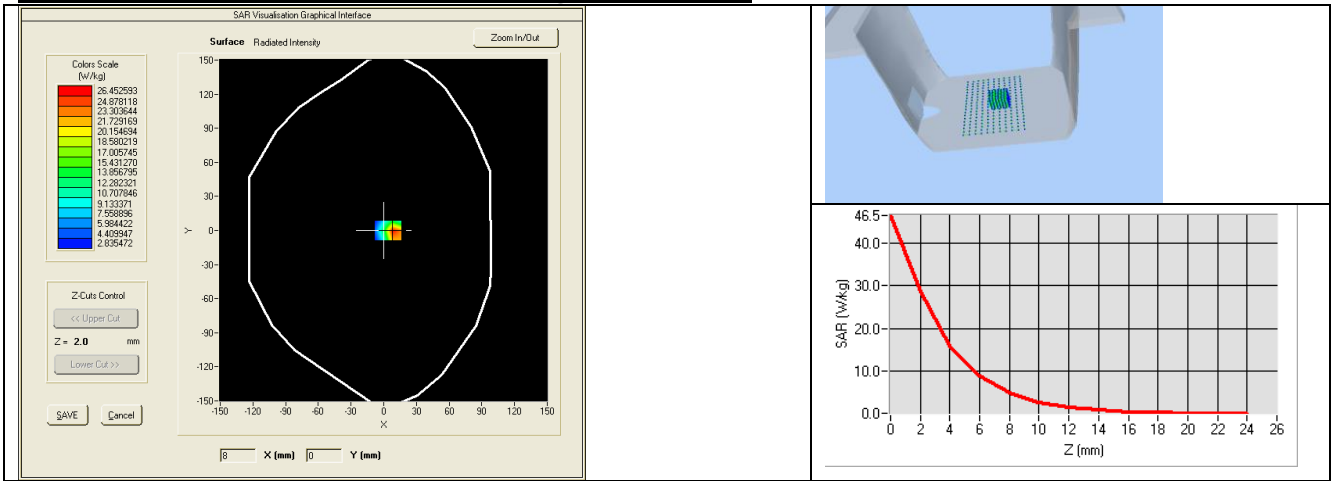

### SAR MEASUREMENT PLOTS @ 5600 MHz

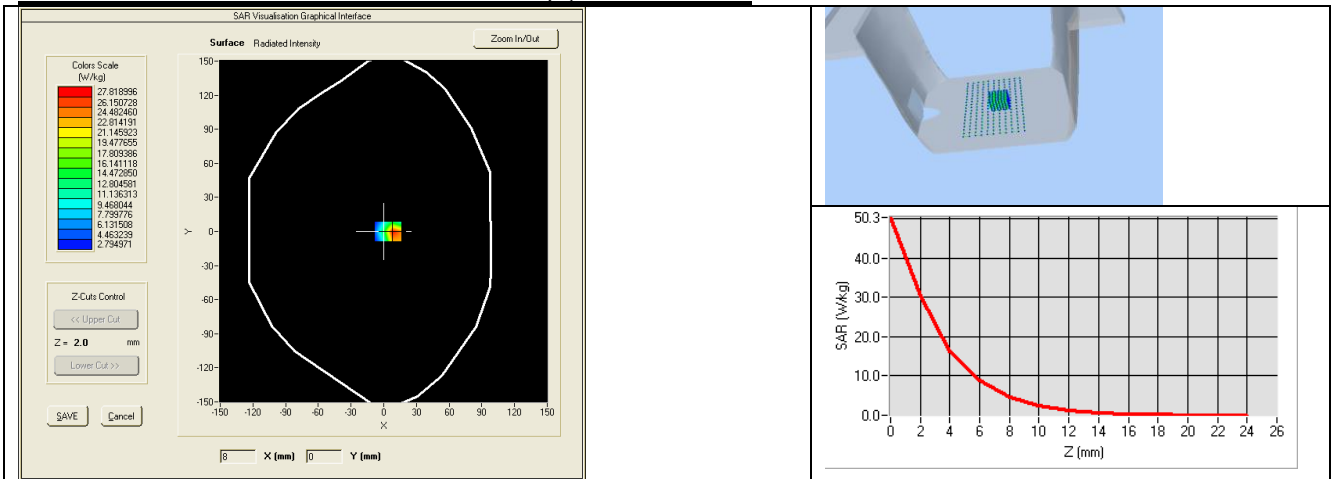

### SAR MEASUREMENT PLOTS @ 5800 MHz

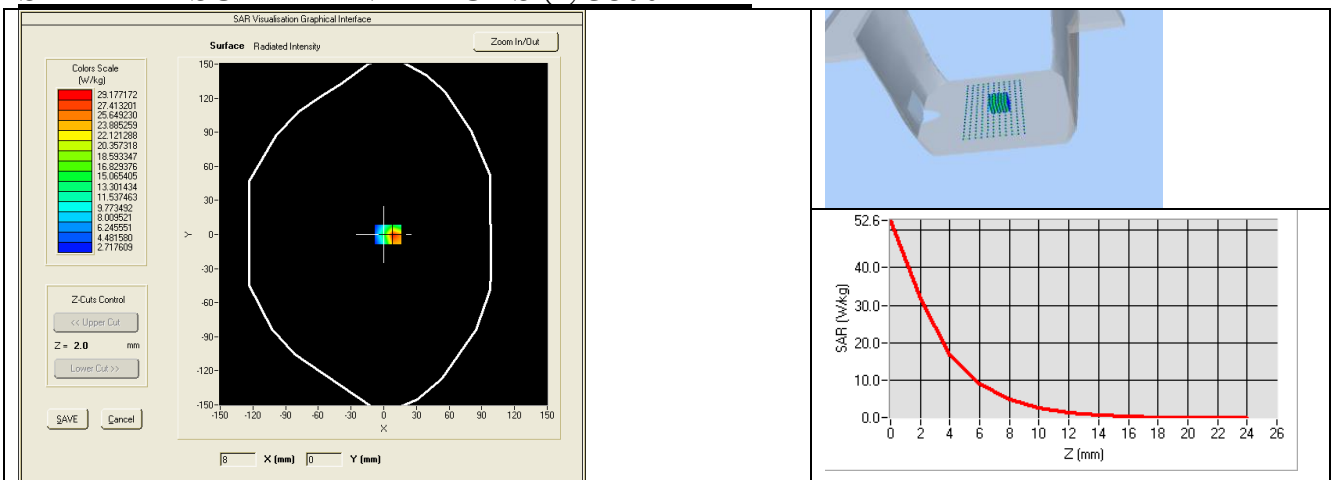

7.3 BODY LIQUID MEASUREMENT

Frequency MHz	Relative permittivity ( $\epsilon_r'$ )		Conductivity ( $\sigma$ ) S/m	
	required	measured	required	measured
5200	49.0 ±10 %	PASS	5.30 ±10 %	PASS
5400	48.7 ±10 %	PASS	5.53 ±10 %	PASS
5600	48.5 ±10 %	PASS	5.77 ±10 %	PASS
5800	48.2 ±10 %	PASS	6.00 ±10 %	PASS

7.4 SAR MEASUREMENT RESULT WITH BODY LIQUID

Software	OPENSAR V4
Phantom	SN 20/09 SAM71
Probe	SN 18/11 EPG122
Liquid	Body Liquid Values 5200 MHz: $\epsilon_r'$ :49.01 sigma : 5.27 Body Liquid Values 5400 MHz: $\epsilon_r'$ :49.67 sigma : 5.45 Body Liquid Values 5600 MHz: $\epsilon_r'$ :47.57 sigma : 5.69 Body Liquid Values 5800 MHz: $\epsilon_r'$ :49.82 sigma : 5.94
Distance between dipole waveguide and liquid	0 mm
Area scan resolution	dx=8mm/dy=8mm
Zoon Scan Resolution	dx=4mm/dy=4m/dz=2mm
Frequency	5200 MHz 5400 MHz 5600 MHz 5800 MHz
Input power	20 dBm
Liquid Temperature	21 °C
Lab Temperature	21 °C
Lab Humidity	45 %

Frequency (MHz)	1 g SAR (W/kg) measured	10 g SAR (W/kg) measured
5200	154.45 (15.45)	55.01 (5.50)
5400	163.31 (16.33)	57.57 (5.76)
5600	165.72 (16.57)	57.93 (5.79)
5800	170.71 (17.07)	59.17 (5.92)

### BODY SAR MEASUREMENT PLOTS @ 5200 MHz

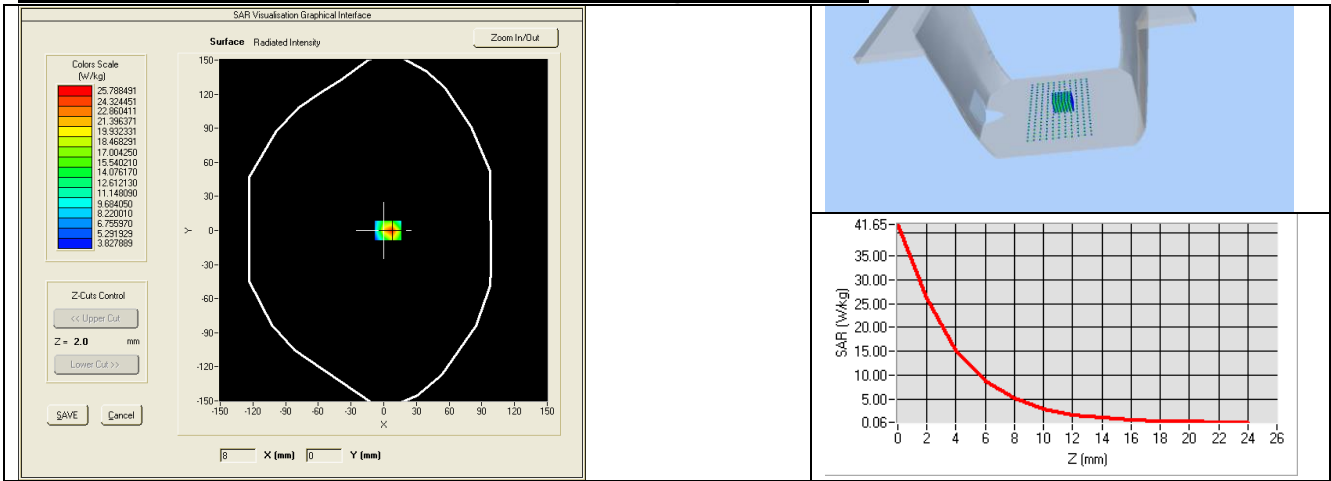

### BODY SAR MEASUREMENT PLOTS @ 5400 MHz

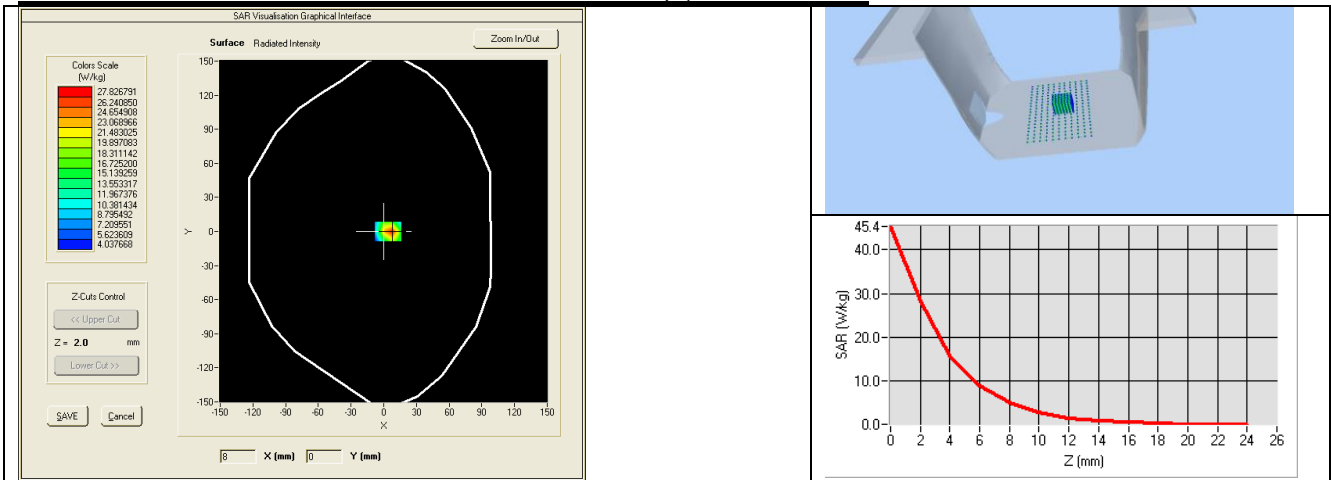

### BODY SAR MEASUREMENT PLOTS @ 5600 MHz

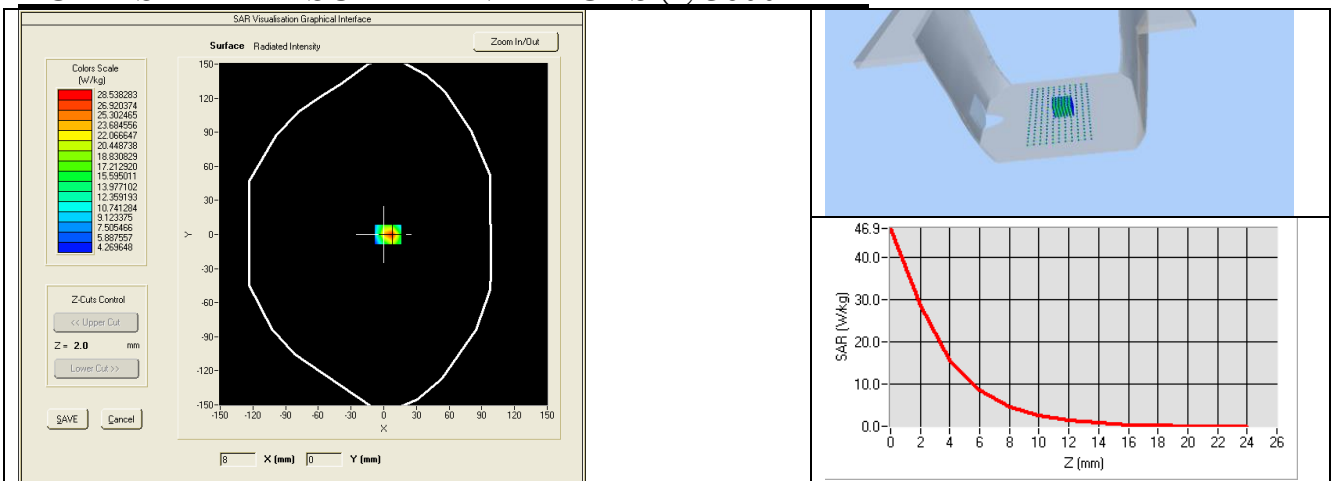

## BODY SAR MEASUREMENT PLOTS @ 5800 MHz

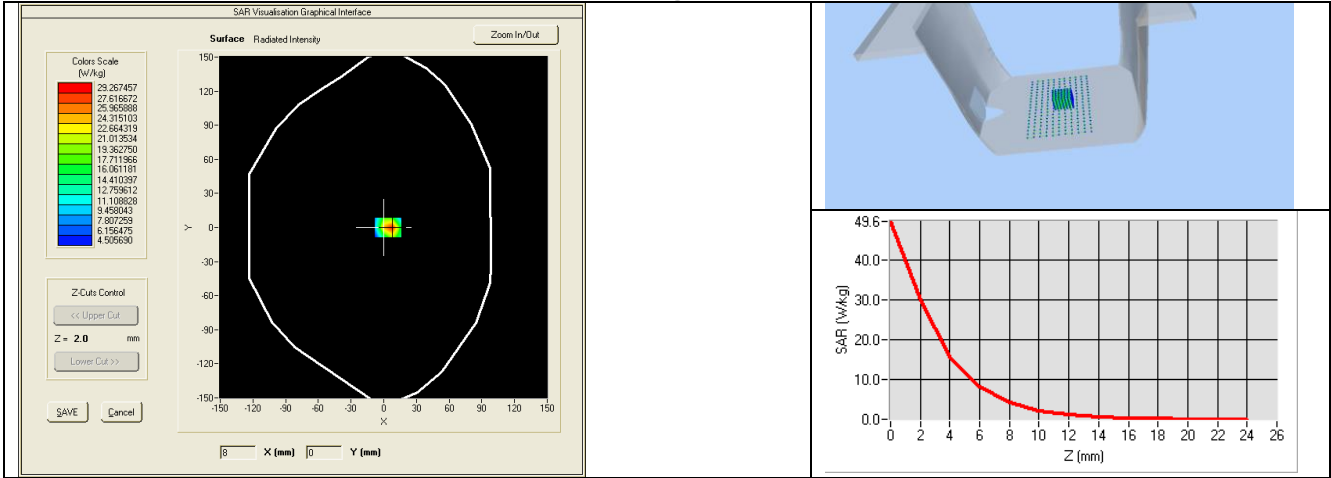





**8 LIST OF EQUIPMENT**

Equipment Summary Sheet				
Equipment Description	Manufacturer / Model	Identification No.	Current Calibration Date	Next Calibration Date
Flat Phantom	MVG	SN-20/09-SAM71	Validated. No cal required.	Validated. No cal required.
COMOSAR Test Bench	Version 3	NA	Validated. No cal required.	Validated. No cal required.
Network Analyzer	Rhode & Schwarz ZVA	SN100132	02/2019	02/2022
Calipers	Carrera	CALIPER-01	01/2019	01/2021
Reference Probe	MVG	EPG122 SN 18/11	10/2019	10/2020
Multimeter	Keithley 2000	1188656	01/2019	01/2021
Signal Generator	Agilent E4438C	MY49070581	01/2019	01/2021
Amplifier	Aethercomm	SN 046	Characterized prior to test. No cal required.	Characterized prior to test. No cal required.
Power Meter	HP E4418A	US38261498	01/2019	01/2021
Power Sensor	HP ECP-E26A	US37181460	01/2019	01/2021
Directional Coupler	Narda 4216-20	01386	Characterized prior to test. No cal required.	Characterized prior to test. No cal required.
Temperature and Humidity Sensor	Control Company	150798832	10/2019	10/2021

## Appendix A. Extended Calibration SAR Dipole

Referring to KDB865664 D01, if dipoles are verified in return loss ( $\leq -20\text{dBm}$ , within 20% of prior calibration), and in impedance (within 5 ohm of prior calibration), the annual calibration is not necessary and the calibration interval can be extended.

### Justification of Extended Calibration SAR Dipole SWG5500 – serial no. SN 49/16 WGA45@5200 MHz

Head						
Date of Measurement	Return-Loss (dB)	Delta (%)	Real Impedance (ohm)	Delta (ohm)	Imaginary Impedance (johm)	Delta (johm)
2020-07-03	-9.48	/	21.44	/	11.06	/
2021-03-01	-9.12	8.64	22.32	0.88	10.01	1.05
2022-03-08	-8.93	13.50	23.10	1.66	10.23	0.83

Body						
Date of Measurement	Return-Loss (dB)	Delta (%)	Real Impedance (ohm)	Delta (ohm)	Imaginary Impedance (johm)	Delta (johm)
2020-07-03	-9.01	/	21.02	/	14.13	/
2021-03-01	-9.75	15.67	19.84	1.18	12.51	1.62
2022-03-08	-8.83	4.23	19.12	1.90	11.98	2.15

### Justification of Extended Calibration SAR Dipole SWG5500 – serial no. SN 49/16 WGA45@5400 MHz

Head						
Date of Measurement	Return-Loss (dB)	Delta (%)	Real Impedance (ohm)	Delta (ohm)	Imaginary Impedance (johm)	Delta (johm)
2020-07-03	-11.12	/	75.61	/	3.31	/
2021-03-01	-11.42	6.67	76.94	1.33	2.46	0.85
2022-03-08	-10.89	5.44	77.22	1.61	2.34	0.97

Body						
Date of Measurement	Return-Loss (dB)	Delta (%)	Real Impedance (ohm)	Delta (ohm)	Imaginary Impedance (johm)	Delta (johm)
2020-07-03	-10.71	/	76.84	/	0.83	/
2021-03-01	-10.63	1.86	73.34	3.50	0.39	0.44
2022-03-08	-11.04	7.32	72.96	3.88	0.45	0.38

**Justification of Extended Calibration SAR Dipole SWG5500– serial no. SN 49/16 WGA45@5600 MHz**

Head						
Date of Measurement	Return-Loss (dB)	Delta (%)	Real Impedance (ohm)	Delta (ohm)	Imaginary Impedance (johm)	Delta (johm)
2020-07-03	-14.51	/	34.43	/	9.61	/
2021-03-01	-15.12	13.10	36.41	1.98	10.10	0.49
2022-03-08	-15.07	12.10	35.89	1.46	10.39	0.78

Body						
Date of Measurement	Return-Loss (dB)	Delta (%)	Real Impedance (ohm)	Delta (ohm)	Imaginary Impedance (johm)	Delta (johm)
2020-07-03	-13.52	/	31.10	/	7.33	/
2021-03-01	-14.15	13.50	32.46	1.36	6.56	0.77
2022-03-08	-14.29	16.25	32.85	1.75	6.12	1.21

**Justification of Extended Calibration SAR Dipole SWG5500 – serial no. SN 49/16 WGA45@5800 MHz**

Head						
Date of Measurement	Return-Loss (dB)	Delta (%)	Real Impedance (ohm)	Delta (ohm)	Imaginary Impedance (johm)	Delta (johm)
2020-07-03	-12.54	/	53.85	/	22.57	/
2021-03-01	-13.02	10.46	52.47	1.38	20.09	2.48
2022-03-08	-13.13	12.70	52.08	1.77	21.23	1.34

Body						
Date of Measurement	Return-Loss (dB)	Delta (%)	Real Impedance (ohm)	Delta (ohm)	Imaginary Impedance (johm)	Delta (johm)
2020-07-03	-11.96	/	58.01	/	22.90	/
2021-03-01	-12.35	8.59	56.44	1.57	22.54	0.36
2022-03-08	-12.21	5.59	56.03	1.98	21.84	1.06

The Return-Loss is <-20dB, and within 20% of prior calibration; the impedance is within 5 ohm of prior calibration. Therefore the value result should support extended.