

TEST REPORT

Reference No...... : WTD24D03060913W005
FCC ID : 2AEPBLACK1
Applicant..... : COLOMBIANA DE COMERCIO S.A.
Address..... : Car. 43E No 8-71, Medellin, Colombia
Manufacturer : Mobewire Mobiles (Ningbo) Co.,Ltd
Address..... : No. 518, Changting East Road, Yuelin Street, Fenghua District,
Ningbo City, Zhejiang Province, China
Product..... : Smart Phone
Model(s)..... : Black 1
Brand Name : Kalley
Standards..... : FCC CFR47 Part 22 Subpart H
FCC CFR47 Part 24 Subpart E
FCC CFR47 Part 27 Subpart L
Date of Receipt sample : 2024-03-25
Date of Test : 2024-03-25 to 2024-04-02
Date of Issue..... : 2024-04-11
Test Result..... : **Pass**

Remarks:

The results shown in this test report refer only to the sample(s) tested, this test report cannot be reproduced, except in full, without prior written permission of the company. The report would be invalid without specific stamp of test institute and the signatures of compiler and approver.

Prepared By:

Waltek Testing Group Co., Ltd.

Address: No. 77, Houjie Section, Guantai Road, Houjie Town, Dongguan City, Guangdong, China

Tel: +86-769-2267 6998

Fax: +86-769-2267 6828

Compiled by:

Ford Wang

Ford Wang / Project Engineer

Approved by:

Deval Qin

Deval Qin / Designated Reviewer

2 Contents

	Page
1 COVER PAGE	1
2 CONTENTS	2
3 REVISION HISTORY	4
4 GENERAL INFORMATION	5
4.1 GENERAL DESCRIPTION OF E.U.T.	5
4.2 DETAILS OF E.U.T.	5
4.3 TEST MODE	7
4.4 TEST FACILITY	7
5 TEST SUMMARY	8
6 EQUIPMENT USED DURING TEST	9
6.1 EQUIPMENTS LIST	9
6.2 MEASUREMENT UNCERTAINTY	10
7 RF OUTPUT POWER	11
7.1 EUT OPERATION.....	11
7.2 TEST PROCEDURE.....	11
7.3 TEST RESULT.....	12
8 PEAK-TO-AVERAGE RATIO	18
8.1 EUT OPERATION.....	18
8.2 TEST PROCEDURE.....	18
8.3 TEST RESULT.....	19
9 BANDWIDTH	23
9.1 EUT OPERATION.....	23
9.2 TEST PROCEDURE.....	23
9.3 TEST RESULT.....	24
10 SPURIOUS EMISSIONS AT ANTENNA TERMINALS	35
10.1 EUT OPERATION	35
10.2 TEST PROCEDURE	35
10.3 TEST RESULT	36
11 SPURIOUS RADIATED EMISSIONS	51
11.1 EUT OPERATION	51
11.2 TEST SETUP	51
11.3 SPECTRUM ANALYZER SETUP.....	52
11.4 TEST PROCEDURE	53
11.5 SUMMARY OF TEST RESULTS	54
12 BAND EDGE MEASUREMENT	56
12.1 EUT OPERATION	56
12.2 TEST PROCEDURE	56
12.3 TEST RESULT	57
13 FREQUENCY STABILITY	72
13.1 EUT OPERATION	72
13.2 TEST PROCEDURE	72

13.3	TEST RESULT	73
14	RF EXPOSURE	81
15	PHOTOGRAPHS OF TEST SETUP AND EUT.....	81

3 Revision History

Test Report No.	Date of Receipt Sample	Date of Test	Date of Issue	Purpose	Comment	Approved
WTD24D03060913W005	2024-03-25	2024-03-25 to 2024-04-02	2024-04-11	Original	-	Valid

4 General Information

4.1 General Description of E.U.T.

Product:	Smart Phone
Model(s):	Black 1
Model Description	The product has two configurations, single card and dual card, other parts are the same. The EUT is dual card in this report.
GSM Band(s):	GSM 850/1900MHz
GPRS/EGPRS Class:	12
WCDMA Band(s):	FDD Band II/IV/V
Hardware Version:	V01
Software Version:	Kalley_BLACK_1_Claro_Co_V01_20240315.
Highest frequency (Exclude Radio):	1.6GHz
Storage Location:	Internal Storage
Note:	This EUT has two SIM card slots, and use same one RF module. We found that RF parameters are the same, when we insert the card 1 and card 2. So we usually performed the test under main card slot 1.

4.2 Details of E.U.T.

Operation Frequency:	GSM/GPRS 850/EDGE: 824~849MHz PCS/GPRS 1900/EDGE: 1850~1910MHz WCDMA Band II: 1850~1910MHz WCDMA Band IV:1710~1755MHz WCDMA Band V: 824~849MHz
Max. RF output power:	GSM 850: 32.04dBm PCS1900: 29.72dBm WCDMA Band II: 22.21dBm WCDMA Band IV: 22.66dBm WCDMA Band V: 22.81dBm
Type of Modulation:	GSM,GPRS: GMSK EDGE: GMSK, 8PSK WCDMA: BPSK, 16QAM
Antenna installation:	GSM/WCDMA: internal permanent antenna
Antenna Gain:	GSM 850: -4.88dBi PCS1900: -0.39dBi WCDMA Band II: -0.39dBi WCDMA Band IV: 0.15dBi WCDMA Band V: -4.88dBi

Note:

#: The antenna gain is provided by the applicant, and the applicant should be responsible for its authenticity, WALTEK lab has not verified the authenticity of its information.

Ratings: Battery: DC 3.85V, 3850mAh, 14.82Wh
DC 5V, 2A charging from adapter

Adapter: Model No.: UT-681A-5200ZCY
Input: 100-240V~, 50/60Hz, 0.35A
Output: 5V===2.0A, 10.0W

Type of Emission: GSM850: 247KGXW, GPRS850: 241KGXW,
EGPRS850: 242KG7W
PCS1900: 245KGXW, GPRS1900: 243KGXW,
EGPRS1900: 240KG7W
WCDMA850: 4M15F9W, WCDMA1900: 4M15F9W
WCDMA1700: 4M16F9W

4.3 Test Mode

All test mode(s) and condition(s) mentioned were considered and evaluated respectively by performing full tests, the worst data were recorded and reported.

Support Band	Test Mode	Channel Frequency	Channel Number
GSM 850	GSM/GPRS/EDGE	824.2 MHz	128
		836.6 MHz	190
		848.8 MHz	251
PCS 1900	GSM/GPRS/EDGE	1850.2 MHz	512
		1880.0 MHz	661
		1909.8 MHz	810
WCDMA Band V	WCDMA/HSUPA/HSDPA	826.4 MHz	4132
		836.6 MHz	4183
		846.6 MHz	4233
WCDMA Band II	WCDMA/HSUPA/HSDPA	1852.4MHz	9262
		1880.0MHz	9400
		1907.6MHz	9538
WCDMA Band IV	WCDMA/HSUPA/HSDPA	1712.4MHz	1313
		1732.6MHz	1413
		1752.6MHz	1512
Remark: All mode(s) were tested and the worst data was recorded.			

4.4 Test Facility

The test facility has a test site registered with the following organizations:

ISED CAB identifier: CN0013. Test Firm Registration No.: 7760A.

Waltek Testing Group Co., Ltd. Has been registered and fully described in a report filed with the Industry Canada. The acceptance letter from the Industry Canada is maintained in our files.

Registration number 7760A, October 15, 2016.

FCC Designation No.: CN1201. Test Firm Registration No.: 523476.

Waltek Testing Group Co., Ltd. EMC Laboratory has been registered and fully described in a report filed with the (FCC) Federal Communications Commission. The acceptance letter from the FCC is maintained in our files. Registration number 523476, September 10, 2019.

5 Test Summary

Test Items	Test Requirement	Result
RF Output Power	2.1046 22.913 (a) 24.232 (c) 27.50(c) 27.50(d)	PASS
Peak-to-Average Ratio	24.232 (d) 27.50(d)	PASS
Bandwidth	2.1049 22.905 22.917 24.238 27.53(a)	PASS
Spurious Emissions at Antenna Terminal	2.1051 22.917 (a) 24.238 (a) 27.53(h)	PASS
Field Strength of Spurious Radiation	2.1053 22.917 (a) 24.238 (a) 27.53(h)	PASS
Out of band emission, Band Edge	22.917 (a) 24.238 (a) 27.53(h)	PASS
Frequency Stability	2.1055 22.355 24.235 27.5(h) 27.54	PASS
Maximum Permissible Exposure (SAR)	1.1307	PASS

6 Equipment Used during Test

6.1 Equipments List

Item	Equipment	Manufacturer	Model No.	Serial No.	Last Cal. Date	Calibration Due Date
3m Semi-anechoic Chamber for Radiation Emissions 1#						
1	Spectrum Analyzer	R&S	FSP30	100091	2023-04-24	2024-04-23
2	Amplifier	Agilent	8447D	2944A10178	2023-07-27	2024-07-26
3	Tri-log Broadband Antenna	SCHWARZBECK	VULB9163	336	2023-08-07	2024-08-06
4	Coaxial Cable	Top	TYPE16(13M)	-	2023-04-24	2024-04-23
5	Broad-band Horn Antenna	SCHWARZBECK	BBHA 9120D	667	2024-01-23	2025-01-22
6	Broad-band Horn Antenna	SCHWARZBECK	BBHA 9170	335	2023-07-27	2024-07-26
7	Broadband Pre-amplifier	COMPLIANCE	PAP-1G18	2004	2023-08-08	2024-08-07
8	Coaxial Cable	Top	ZT26-NJ-NJ-8M/FA	-	2023-04-24	2024-04-23
9	Microwave Amplifier	SCHWARZBECK	BBV 9721	100472	2023-07-27	2024-07-26
10	Coaxial Cable	Top	ZT40-2.92J-2.92J-2.0M	17100919	2023-04-24	2024-04-23
3m Semi-anechoic Chamber for Radiation Emissions 2#						
1	Test Receiver	R&S	ESCI	101296	2023-04-24	2024-04-23
2	Trilog Broadband Antenna	SCHWARZBECK	VULB9160	9160-3325	2023-11-04	2024-11-03
3	Active Loop Antenna	Com-Power	AL-130R	10160007	2023-05-07	2024-05-06
4	Amplifier	ANRITSU	MH648A	M43381	2023-04-24	2024-04-23
5	Cable	HUBER+SUHNER	CBL2	525178	2023-04-24	2024-04-23
RF Conducted Testing						
1	Spectrum Analyzer	R&S	FSP40	100501	2023-07-27	2024-07-26
2	Spectrum Analyzer	Agilent	N9020A	MY49100060	2023-07-27	2024-07-26
3.	Universal Radio Communication Tester	R&S	CMU 200	121315	2023-04-24	2024-04-23

Test Software:

Test Item	Software name	Software version
Radiated Emission(3m)	EZ-EMC	EZ-EMC(RA-03A1-1)

6.2 Measurement Uncertainty

Parameter	Uncertainty
Conducted Emission	± 3.64 dB(AC mains 150KHz~30MHz)
Radiated Spurious Emissions	± 5.08 dB (Bilog antenna 30M~1000MHz)
	± 5.47 dB (Horn antenna 1000M~25000MHz)
Radio Frequency	± 1 x 10 ⁻⁷ Hz
RF Power	± 0.42 dB
RF Power Density	± 0.7dB
Conducted Spurious Emissions	± 2.76 dB (9kHz~26500MHz)
Confidence interval: 95%. Confidence factor:k=2	

7 RF Output Power

Test Requirement:	FCC Part 2.1046, 22.913 (a), 24.232 (c), 27.50(c.10); 27.50(d.4)
Test Method:	ANSI/TIA-603-E:2016 ANSI C63.26:2015
Test Mode:	TX transmitting

7.1 EUT Operation

Operating Environment :

Temperature:	22.5 °C
Humidity:	52.1 % RH
Atmospheric Pressure:	101.2kPa

7.2 Test Procedure

Conducted method:

The RF output of the transmitter was connected to the wireless test set and the spectrum analyzer through sufficient attenuation.

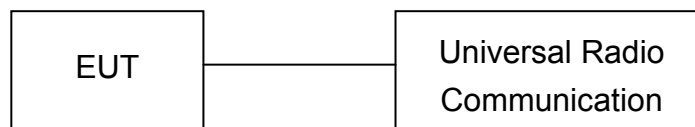

Radiated method:

1. The setup of EUT is according with per TIA/EIA Standard 603D.
2. The measurement antenna was placed at a distance of 3 meters from the EUT. During the tests, the antenna height and polarization as well as EUT azimuth were varied in order to identify the maximum level of emissions from the EUT. The test was performed by placing the EUT on 3-orthogonal axis.
3. The frequency range up to tenth harmonic of the fundamental frequency was investigated.
4. Remove the EUT and replace it with substitution antenna. A signal generator was connected to the substitution antenna by a non-radiating cable. The absolute levels of the spurious emissions were measured by the substitution.

7.3 Test Result

Conducted Power

GSM - Burst Average Power (dBm)						
Band	GSM850			PCS1900		
Channel	128	190	251	512	661	810
Frequency (MHz)	824.2	836.6	848.8	1850.2	1880	1909.8
GSM	31.86	31.93	32.04	29.72	29.09	28.65
GPRS (1 slot)	31.23	31.48	31.55	29.50	28.92	28.08
GPRS (2 slots)	30.62	30.83	30.91	28.72	28.59	28.12
GPRS (3 slots)	30.13	30.34	30.38	27.51	27.20	27.06
GPRS (4 slots)	29.81	29.83	30.02	26.89	26.41	26.11
EGPRS (1 slot)	27.07	27.14	27.15	25.44	25.10	24.78
EGPRS (2 slots)	26.31	26.38	26.41	24.76	24.32	24.05
EGPRS (3 slots)	25.28	25.36	25.43	23.94	23.58	23.27
EGPRS (4 slots)	24.45	24.50	24.59	23.05	22.61	22.43

WCDMA - Average Power (dBm)									
Band	WCDMA Band II			WCDMA Band V			WCDMA Band IV		
Channel	9262	9400	9538	4132	4183	4233	1313	1413	1512
Frequency (MHz)	1852.4	1880	1907.6	826.4	836.6	846.6	1712.4	1732.6	1752.6
RMC 12.2k	22.21	21.47	21.83	22.79	22.80	22.81	22.54	22.52	22.66
HSDPA Subtest-1	21.64	21.70	21.23	22.39	22.25	22.44	19.85	20.57	20.44
HSDPA Subtest-2	21.32	21.22	21.09	21.05	22.15	20.96	20.52	21.41	21.82
HSDPA Subtest-3	21.21	21.18	20.96	20.16	20.84	20.89	21.39	21.33	21.19
HSDPA Subtest-4	21.08	20.94	20.84	20.78	20.73	20.71	19.25	21.16	21.05
HSUPA Subtest-1	21.73	21.74	21.20	22.20	22.14	22.25	19.90	20.55	20.43
HSUPA Subtest-2	20.83	20.81	20.69	20.62	20.51	20.55	21.05	20.19	20.06
HSUPA Subtest-3	20.94	20.62	20.57	20.48	20.44	20.38	20.92	20.18	20.23
HSUPA Subtest-4	20.66	20.35	20.45	20.36	20.31	20.25	20.31	19.71	20.28
HSUPA Subtest-5	20.58	20.41	20.68	20.22	20.19	20.23	20.43	20.15	20.31

Radiated Power

ERP and EIRP

Cellular Band 850 (Part 22H)

Frequency	Receiver Reading	Turn table Angle	RX Antenna		Substituted			Absolute Level	Part 22H	
			Height	Polar	SG Level	Cable	Antenna Gain		Limit	Margin
(MHz)	(dBμV)	Degree	(m)	(H/V)	(dBm)	(dB)	(dB)	(dBm)	(dBm)	(dB)
GSM 850 Channel 128										
824.20	98.22	319	1.4	H	31.19	0.20	0.00	30.99	38.45	-7.46
824.20	97.77	197	1.9	V	30.67	0.20	0.00	30.47	38.45	-7.98
GSM 850 Channel 190										
836.60	98.06	11	2.0	H	31.03	0.20	0.00	30.83	38.45	-7.62
836.60	97.83	120	1.5	V	30.73	0.20	0.00	30.53	38.45	-7.92
GSM 850 Channel 251										
848.80	97.83	159	1.6	H	30.80	0.20	0.00	30.60	38.45	-7.85
848.80	97.74	137	2.4	V	30.64	0.20	0.00	30.44	38.45	-8.01
GPRS 850 Channel 128										
824.20	98.39	91	2.3	H	31.36	0.20	0.00	31.16	38.45	-7.29
824.20	98.58	23	2.2	V	31.48	0.20	0.00	31.28	38.45	-7.17
GPRS 850 Channel 190										
836.60	98.47	207	1.8	H	31.44	0.20	0.00	31.24	38.45	-7.21
836.60	98.18	95	1.2	V	31.08	0.20	0.00	30.88	38.45	-7.57
GPRS 850 Channel 251										
848.80	98.35	282	2.1	H	31.32	0.20	0.00	31.12	38.45	-7.33
848.80	98.19	238	1.9	V	31.09	0.20	0.00	30.89	38.45	-7.56
EGPRS 850 Channel 128										
824.20	90.01	21	2.1	H	22.98	0.20	0.00	22.78	38.45	-15.67
824.20	89.89	268	1.8	V	22.79	0.20	0.00	22.59	38.45	-15.86
EGPRS 850 Channel 190										
836.60	89.83	131	1.7	H	22.80	0.20	0.00	22.60	38.45	-15.85
836.60	89.65	327	2.4	V	22.55	0.20	0.00	22.35	38.45	-16.10
EGPRS 850 Channel 251										
848.80	89.53	109	1.3	H	22.50	0.20	0.00	22.30	38.45	-16.15
848.80	90.00	231	1.0	V	22.90	0.20	0.00	22.70	38.45	-15.75

Cellular Band 1900 (Part 24E)

Frequency	Receiver Reading	Turn table Angle	RX Antenna		Substituted			Absolute Level	Part 24E	
			Height	Polar	SG Level	Cable	Antenna Gain		Limit	Margin
(MHz)	(dB μ V)	Degree	(m)	(H/V)	(dBm)	(dB)	(dB)	(dBm)	(dBm)	(dB)
PCS 1900 Channel 512										
1850.20	92.05	222	1.5	H	18.08	0.31	10.40	28.17	33	-4.83
1850.20	91.74	112	2.2	V	18.46	0.31	10.40	28.55	33	-4.45
PCS 1900 Channel 661										
1880.00	91.63	28	2.5	H	17.78	0.31	10.40	27.87	33	-5.13
1880.00	91.70	80	1.7	V	18.58	0.31	10.40	28.67	33	-4.33
PCS 1900 Channel 810										
1909.80	91.59	56	2.0	H	17.86	0.32	10.40	27.94	33	-5.06
1909.80	91.98	83	1.8	V	19.02	0.32	10.40	29.10	33	-3.90
GPRS 1900 Channel 512										
1850.20	92.01	23	2.2	H	18.04	0.31	10.40	28.13	33	-4.87
1850.20	91.97	75	2.3	V	18.69	0.31	10.40	28.78	33	-4.22
GPRS 1900 Channel 661										
1880.00	91.86	310	1.7	H	18.01	0.31	10.40	28.10	33	-4.90
1880.00	91.69	62	2.2	V	18.57	0.31	10.40	28.66	33	-4.34
GPRS 1900 Channel 810										
1909.80	91.64	17	1.2	H	17.91	0.32	10.40	27.99	33	-5.01
1909.80	92.01	167	1.3	V	19.05	0.32	10.40	29.13	33	-3.87
EGPRS 1900 Channel 512										
1850.20	88.05	216	2.3	H	14.08	0.31	10.40	24.17	33	-8.83
1850.20	87.61	346	1.2	V	14.33	0.31	10.40	24.42	33	-8.58
EGPRS 1900 Channel 661										
1880.00	87.75	78	1.3	H	13.90	0.31	10.40	23.99	33	-9.01
1880.00	87.89	349	1.8	V	14.77	0.31	10.40	24.86	33	-8.14
EGPRS 1900 Channel 810										
1909.80	87.55	316	1.3	H	13.82	0.32	10.40	23.90	33	-9.10
1909.80	87.95	181	2.5	V	14.99	0.32	10.40	25.07	33	-7.93

WCDMA Band V (Part 22H)

Frequency	Receiver Reading	Turn table Angle	RX Antenna		Substituted			Absolute Level	Part 22H	
			Height	Polar	SG Level	Cable	Antenna Gain		Limit	Margin
(MHz)	(dB μ V)	Degree	(m)	(H/V)	(dBm)	(dB)	(dB)	(dBm)	(dBm)	(dB)
WCDMA Band V Voice Channel 4132										
826.40	89.14	321	2.4	H	22.11	0.20	0.00	21.91	38.45	-16.54
826.40	89.12	35	2.0	V	22.02	0.20	0.00	21.82	38.45	-16.63
WCDMA Band V Voice Channel 4183										
836.60	89.01	177	1.6	H	21.98	0.20	0.00	21.78	38.45	-16.67
836.60	89.00	22	1.3	V	21.90	0.20	0.00	21.70	38.45	-16.75
WCDMA Band V Voice Channel 4233										
846.60	89.12	140	1.9	H	22.09	0.20	0.00	21.89	38.45	-16.56
846.60	87.99	180	1.3	V	20.89	0.20	0.00	20.69	38.45	-17.76
WCDMA Band V HSDPA Channel 4132										
826.40	88.01	79	1.5	H	20.98	0.20	0.00	20.78	38.45	-17.67
826.40	89.49	329	2.0	V	22.39	0.20	0.00	22.19	38.45	-16.26
WCDMA Band V HSDPA Channel 4183										
836.60	88.05	323	2.3	H	21.02	0.20	0.00	20.82	38.45	-17.63
836.60	87.91	271	1.4	V	20.81	0.20	0.00	20.61	38.45	-17.84
WCDMA Band V HSDPA Channel 4233										
846.60	88.10	155	1.2	H	21.07	0.20	0.00	20.87	38.45	-17.58
846.60	88.09	177	1.6	V	20.99	0.20	0.00	20.79	38.45	-17.66
WCDMA Band V HSUPA Channel 4132										
826.40	86.68	320	2.4	H	19.65	0.20	0.00	19.45	38.45	-19.00
826.40	86.85	328	1.5	V	19.75	0.20	0.00	19.55	38.45	-18.90
WCDMA Band V HSUPA Channel 4183										
836.60	87.04	46	1.3	H	20.01	0.20	0.00	19.81	38.45	-18.64
836.60	87.14	34	1.6	V	20.04	0.20	0.00	19.84	38.45	-18.61
WCDMA Band V HSUPA Channel 4233										
846.60	86.77	352	1.6	H	19.74	0.20	0.00	19.54	38.45	-18.91
846.60	86.93	249	2.1	V	19.83	0.20	0.00	19.63	38.45	-18.82

WCDMA Band II (Part 24E)

Frequency	Receiver Reading	Turn table Angle	RX Antenna		Substituted			Absolute Level	Part 24E	
			Height	Polar	SG Level	Cable	Antenna Gain		Limit	Margin
(MHz)	(dB μ V)	Degree	(m)	(H/V)	(dBm)	(dB)	(dB)	(dBm)	(dBm)	(dB)
WCDMA Band II Voice Channel 9262										
1852.40	85.69	342	1.9	H	11.72	0.31	10.40	21.81	33	-11.19
1852.40	84.91	231	1.7	V	11.63	0.31	10.40	21.72	33	-11.28
WCDMA Band II Voice Channel 9400										
1880.00	85.68	165	2.4	H	11.83	0.31	10.40	21.92	33	-11.08
1880.00	84.75	66	1.5	V	11.63	0.31	10.40	21.72	33	-11.28
WCDMA Band II Voice Channel 9538										
1907.60	85.29	154	2.5	H	11.56	0.32	10.40	21.64	33	-11.36
1907.60	84.48	178	2.4	V	11.52	0.32	10.40	21.60	33	-11.40
WCDMA Band II HSDPA Channel 9262										
1852.40	84.71	260	1.2	H	10.74	0.31	10.40	20.83	33	-12.17
1852.40	84.64	61	1.4	V	11.36	0.31	10.40	21.45	33	-11.55
WCDMA Band II HSDPA Channel 9400										
1880.00	84.94	260	2.2	H	11.09	0.31	10.40	21.18	33	-11.82
1880.00	84.96	339	1.2	V	11.84	0.31	10.40	21.93	33	-11.07
WCDMA Band II HSDPA Channel 9538										
1907.60	85.08	115	1.2	H	11.35	0.32	10.40	21.43	33	-11.57
1907.60	85.06	295	1.8	V	12.10	0.32	10.40	22.18	33	-10.82
WCDMA Band II HSUPA Channel 9262										
1852.40	83.61	114	2.2	H	9.64	0.31	10.40	19.73	33	-13.27
1852.40	83.41	68	1.3	V	10.13	0.31	10.40	20.22	33	-12.78
WCDMA Band II HSUPA Channel 9400										
1880.00	83.42	48	1.2	H	9.57	0.31	10.40	19.66	33	-13.34
1880.00	83.48	87	1.2	V	10.36	0.31	10.40	20.45	33	-12.55
WCDMA Band II HSUPA Channel 9538										
1907.60	83.54	338	1.1	H	9.81	0.32	10.40	19.89	33	-13.11
1907.60	83.53	324	1.5	V	10.57	0.32	10.40	20.65	33	-12.35

WCDMA Band IV (Part 27L)

Frequency	Receiver Reading	Turntable Angle	RX Antenna		Substituted			Absolute Level	Part 27	
			Height	Polar	SG Level	Cable	Antenna Gain		Limit	Margin
(MHz)	(dBμV)	Degree	(m)	(H/V)	(dBm)	(dB)	(dB)	(dBm)	(dBm)	(dB)
WCDMA Band IV Voice Channel 1313										
1712.40	86.96	108	2.5	H	12.99	0.30	9.40	22.09	30	-7.91
1712.40	86.79	326	1.9	V	12.51	0.30	9.40	21.61	30	-8.39
WCDMA Band IV Voice Channel 1413										
1732.60	86.70	243	2.4	H	12.85	0.30	9.40	21.95	30	-8.05
1732.60	86.58	227	2.2	V	12.46	0.30	9.40	21.56	30	-8.44
WCDMA Band IV Voice Channel 1512										
1752.60	86.75	114	1.8	H	13.02	0.30	9.40	22.12	30	-7.88
1752.60	86.76	142	1.2	V	11.80	0.30	9.40	20.90	30	-9.10
WCDMA Band IV HSDPA Channel 1313										
1712.40	86.87	65	2.2	H	12.90	0.30	9.40	22.00	30	-8.00
1712.40	86.98	147	1.8	V	12.70	0.30	9.40	21.80	30	-8.20
WCDMA Band IV HSDPA Channel 1413										
1732.60	86.94	178	1.1	H	13.09	0.30	9.40	22.19	30	-7.81
1732.60	86.80	150	1.4	V	12.68	0.30	9.40	21.78	30	-8.22
WCDMA Band IV HSDPA Channel 1512										
1752.60	86.90	54	1.8	H	13.17	0.30	9.40	22.27	30	-7.73
1752.60	86.68	98	1.7	V	11.72	0.30	9.40	20.82	30	-9.18
WCDMA Band IV HSUPA Channel 1313										
1712.40	86.96	137	1.4	H	12.99	0.30	9.40	22.09	30	-7.91
1712.40	86.48	324	2.2	V	12.20	0.30	9.40	21.30	30	-8.70
WCDMA Band IV HSUPA Channel 1413										
1732.60	86.78	9	1.1	H	12.93	0.30	9.40	22.03	30	-7.97
1732.60	86.81	302	2.1	V	12.69	0.30	9.40	21.79	30	-8.21
WCDMA Band IV HSUPA Channel 1512										
1752.60	86.80	325	2.2	H	13.07	0.30	9.40	22.17	30	-7.83
1752.60	86.65	298	1.7	V	11.69	0.30	9.40	20.79	30	-9.21

8 Peak-to-Average Ratio

Test Requirement:	24.232 (d), 27.50(d)
Test Method:	N/A
Test Mode:	TX transmitting

8.1 EUT Operation

Operating Environment :

Temperature:	22.5 °C
Humidity:	52.3% RH
Atmospheric Pressure:	101.2kPa

8.2 Test Procedure

1. The EUT was connected to spectrum analyzer and system simulator via a power divider.
2. Set EUT to transmit at maximum output power.
3. When the duty cycle is less than 98%, then signal gating will be implemented on the spectrum analyzer by triggering from the system simulator.
4. Set the CCDF (Complementary Cumulative Distribution Function) option of the spectrum analyzer. Record the maximum PAPR level associated with a probability of 0.1%.

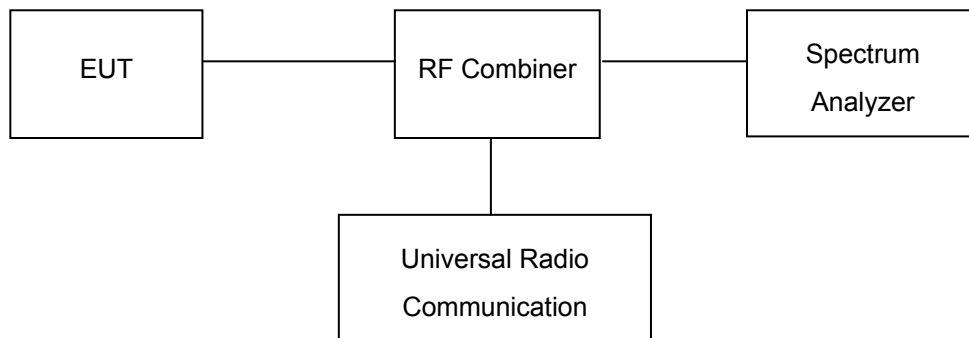

8.3 Test Result

Cellular Band (Part 24E)

Remark: All test data were reported and only the worst case (middle channel mode) test graphs were showed in test report.

Mode	PCS 1900			GPRS 1900			EDGE 1900			Limit (dB)
Channel	512	661	810	512	661	810	512	661	810	
Frequency (MHz)	1850.2	1880.0	1909.8	1850.2	1880.0	1909.8	1850.2	1880.0	1909.8	
Peak-to-Average Ratio (dB)	9.69	9.84	9.76	9.35	9.55	9.48	12.65	12.80	12.79	13

Cellular Band (Part 24E&Part 27L)

Mode	WCDMA Band II			WCDMA Band IV			Limit (dB)
Channel	9262	9400	9538	1313	1413	1512	
Frequency (MHz)	1852.4	1880.0	1907.6	1712.4	1732.6	1752.6	
Peak-to- Average Ratio (dB)	2.79	3.83	2.80	3.65	3.75	3.70	13

Test Plots (Part 24E)

PCS1900 Middle Channel

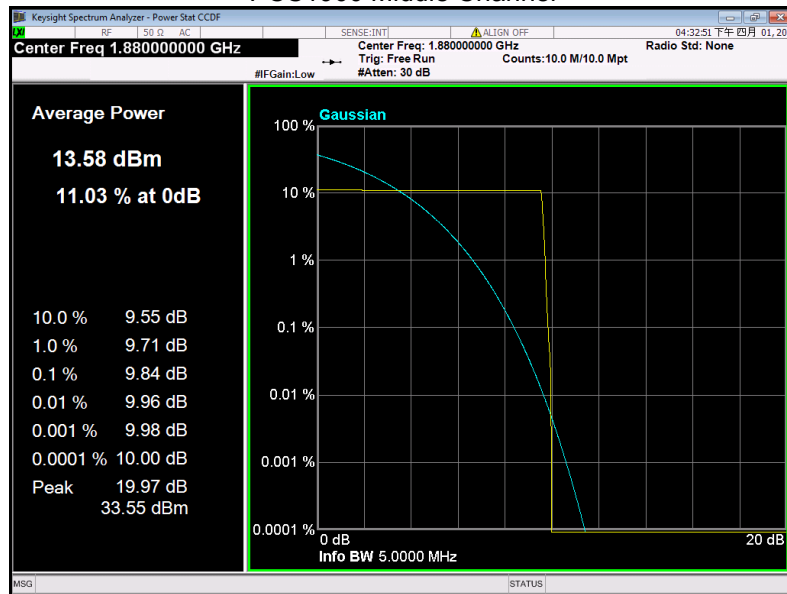

GPRS 1900 Middle Channel

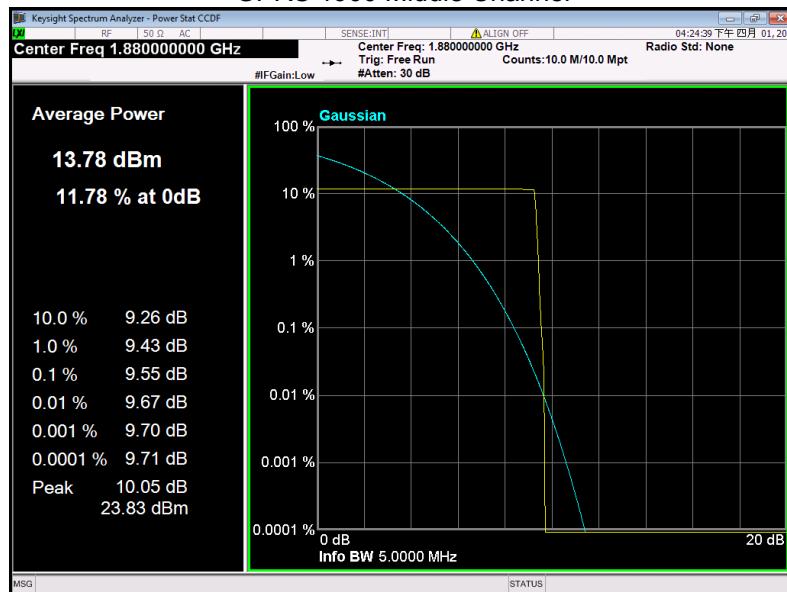

EDGE 1900 Middle Channel

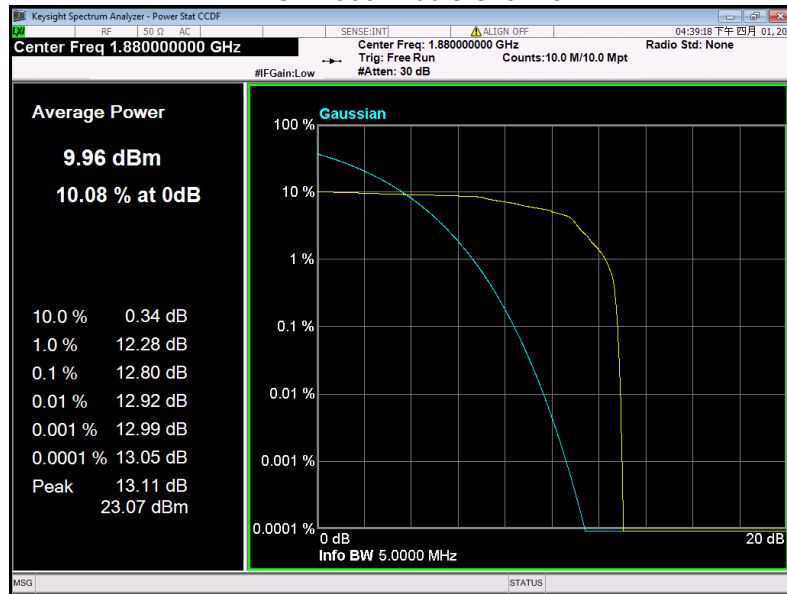

WCDMA Band II Middle Channel

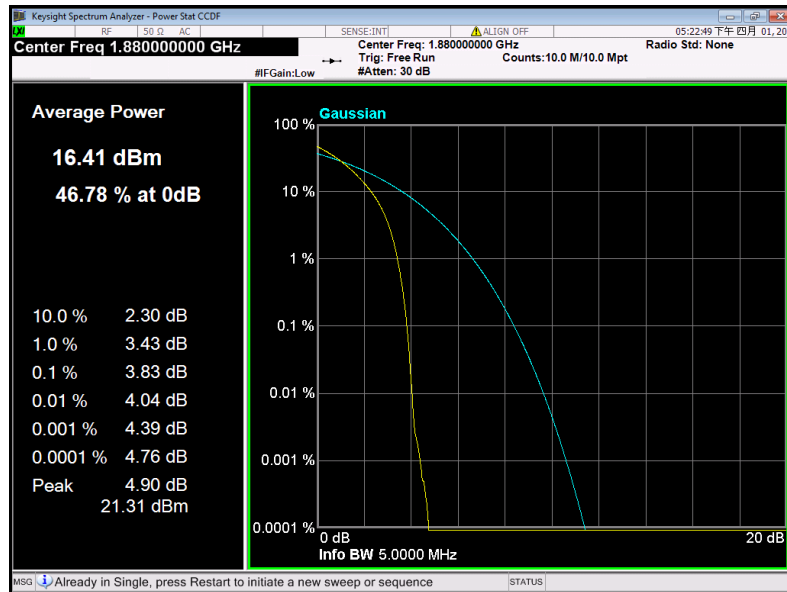

Test Plots (Part 27L)

WCDMA Band IV Middle Channel

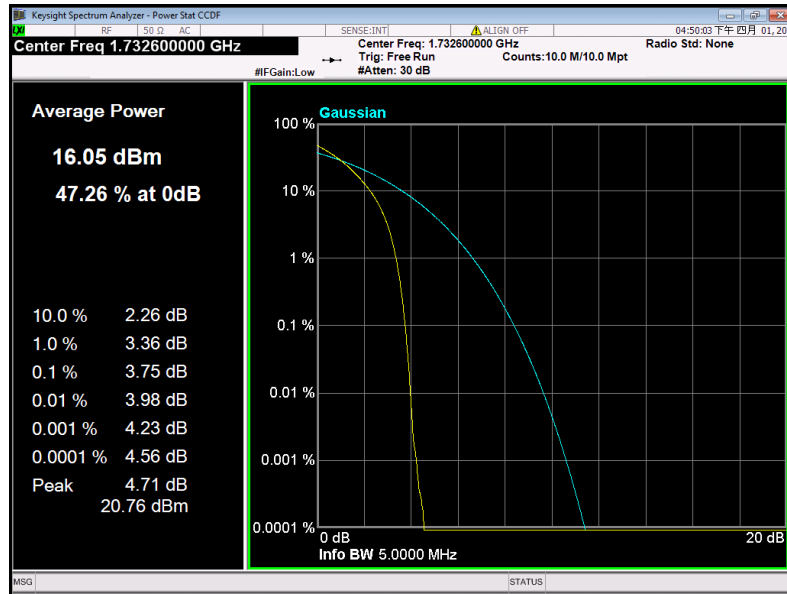

9 Bandwidth

Test Requirement: FCC Part 2.1049, 22.917, 22.905, 24.238, 27.53(a)

Test Method: ANSI/TIA-603-E:2016

ANSI C63.26:2015

Test Mode: TX transmitting

9.1 EUT Operation

Operating Environment :

Temperature: 22.5 °C

Humidity: 52.3% RH

Atmospheric Pressure: 101.2kPa

9.2 Test Procedure

The RF output of the transmitter was connected to the wireless test set and the spectrum analyzer through sufficient attenuation.

The resolution bandwidth of the spectrum analyzer was set in the range of 1 to 5 % of the anticipated OBW (Cellular /PCS) and the 26 dB & 99% bandwidth was recorded.

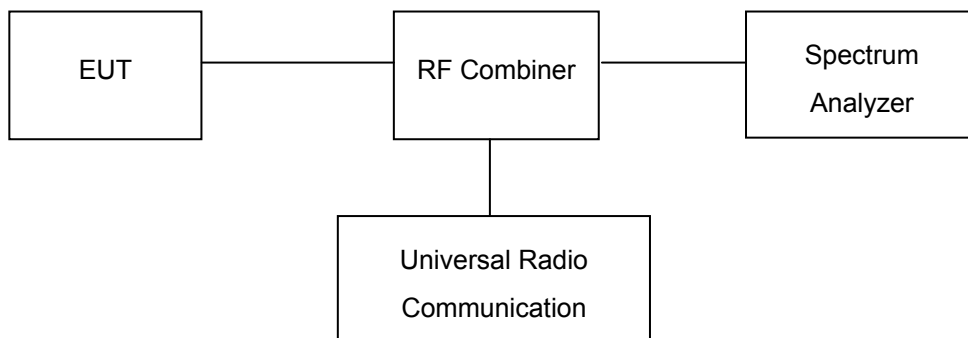

9.3 Test Result

Remark: All test data were reported and only the worst case (middle channel mode) test graphs were showed in test report.

Cellular Band (Part 22H)

Test Mode	Channel	Frequency (MHz)	99% Occupied Bandwidth(kHz)	26 dB Emission Bandwidth(kHz)
GSM 850	128	824.2	247.39	316.80
	190	836.6	247.40	316.80
	251	848.8	247.39	316.78
GPRS 850	128	824.2	241.74	307.79
	190	836.6	241.75	307.80
	251	848.8	241.74	307.79
EGPRS 850	128	824.2	242.73	308.89
	190	836.6	242.73	308.90
	251	848.8	242.72	308.89

Test Mode	Channel	Frequency (MHz)	99% Occupied Bandwidth(MHz)	26 dB Emission Bandwidth(MHz)	
WCDMA Band V	RMC12.2k	4132	826.4	4.14	4.63
		4183	836.6	4.14	4.63
		4233	846.6	4.13	4.62
	HSDPA(16QAM)	4132	826.4	4.14	4.63
		4183	836.6	4.15	4.64
		4233	846.6	4.14	4.63
	HSUPA(BPSK)	4132	826.4	4.13	4.62
		4183	836.6	4.14	4.63
		4233	846.6	4.13	4.62

Cellular Band (Part 24E)

Test Mode	Channel	Frequency (MHz)	99% Occupied Bandwidth(kHz)	26 dB Emission Bandwidth(kHz)
PCS 1900	512	1850.2	245.37	312.19
	661	1880.0	245.38	312.20
	810	1909.8	245.37	312.19
GPRS 1900	512	1850.2	243.79	314.70
	661	1880.0	243.81	314.70
	810	1909.8	243.80	314.69
EGPRS 1900	512	1850.2	240.53	306.19
	661	1880.0	240.54	306.20
	810	1909.8	240.53	306.20

Test Mode	Channel	Frequency (MHz)	99% Occupied Bandwidth(MHz)	26 dB Emission Bandwidth(MHz)	
WCDMA Band II	RMC12.2k	9262	1852.4	4.13	4.60
		9400	1880.0	4.15	4.62
		9538	1907.6	4.14	4.60
	HSDPA(16QAM)	9262	1852.4	4.14	4.62
		9400	1880.0	4.15	4.62
		9538	1907.6	4.15	4.62
	HSUPA(BPSK)	9262	1852.4	4.14	4.63
		9400	1880.0	4.15	4.63
		9538	1907.6	4.14	4.62

Cellular Band (Part 27L)

Test Mode		Channel	Frequency (MHz)	99% Occupied Bandwidth(MHz)	26 dB Emission Bandwidth(MHz)
WCDMA Band IV	RMC12.2k	1313	1712.6	4.12	4.53
		1413	1732.6	4.16	4.66
		1512	1752.4	4.02	4.52
	HSDPA	1313	1712.6	4.12	4.62
		1413	1732.6	4.14	4.64
		1512	1752.4	4.04	4.63
	HSUPA	1313	1712.6	4.02	4.49
		1413	1732.6	4.14	4.65
		1512	1752.4	4.06	4.52

Test Plots (worst case)
Cellular Band (Part 22H)

GSM 850

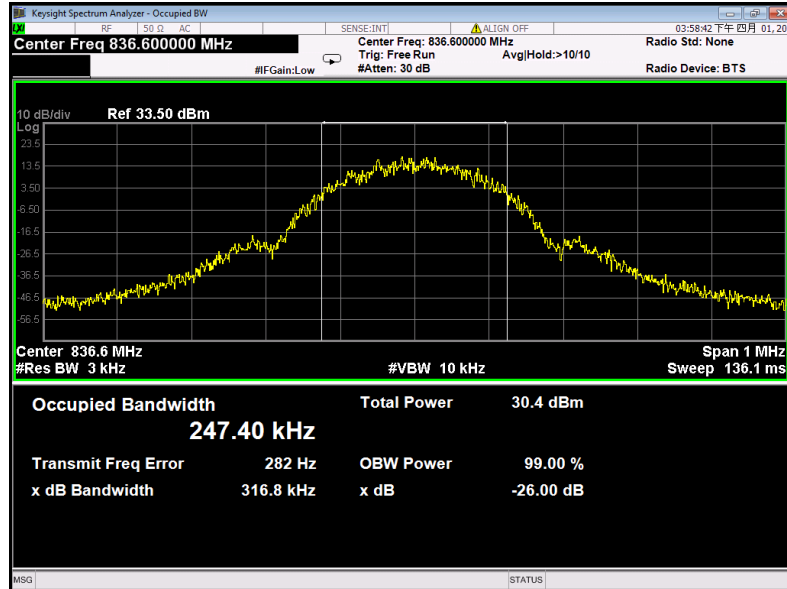

GPRS 850

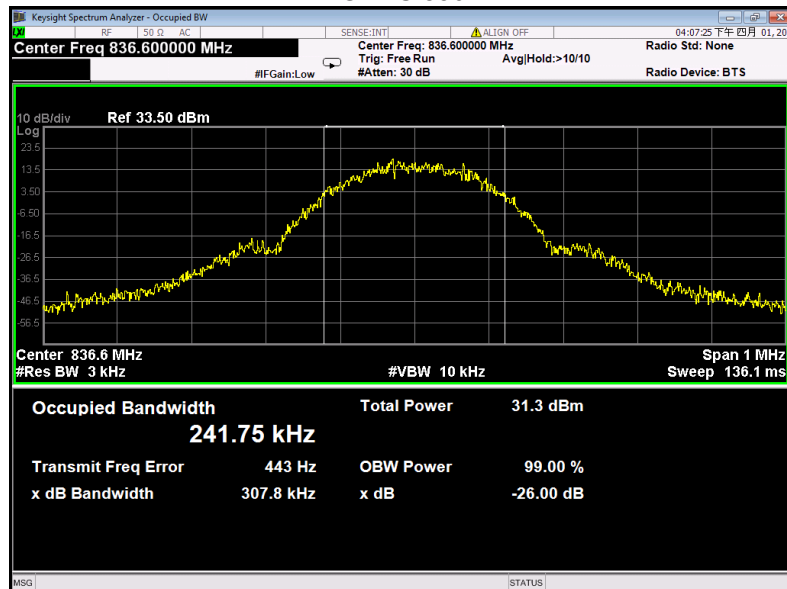

EGPRS 850

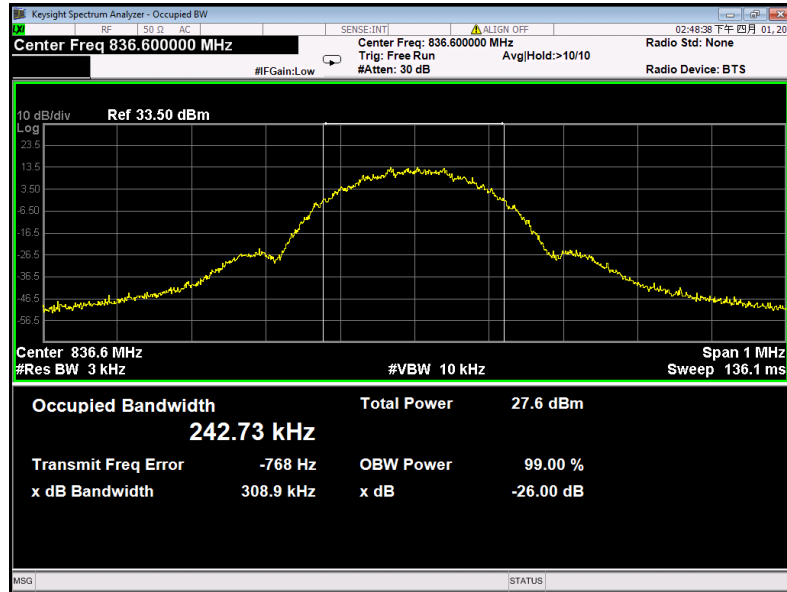

WCDMA band V

RMC12.2k

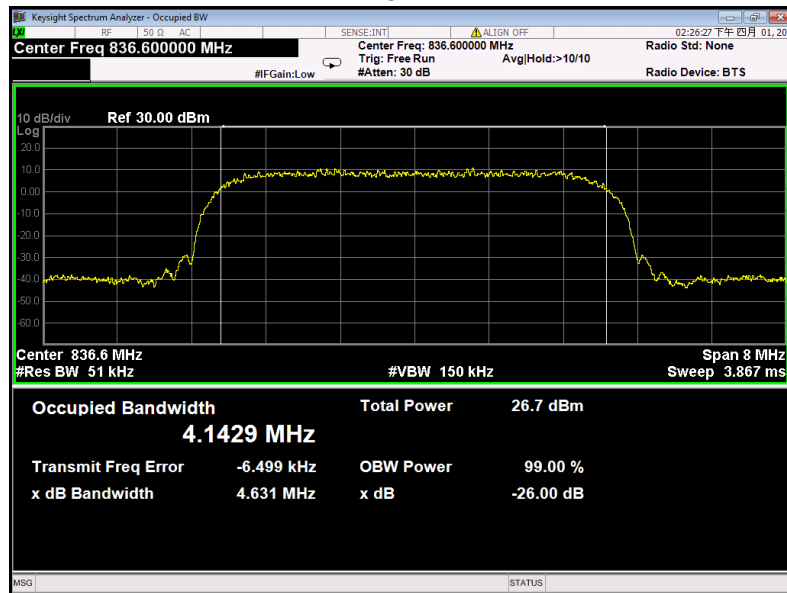

HSDPA

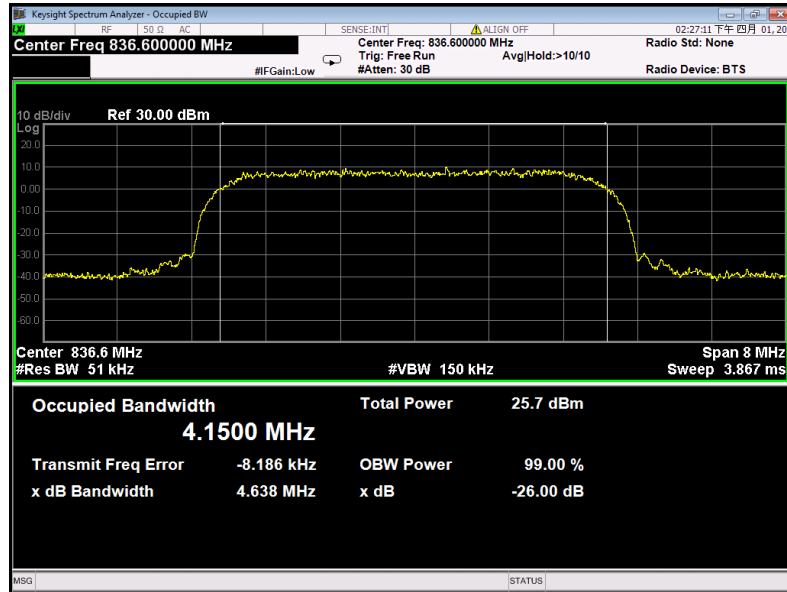

HSUPA

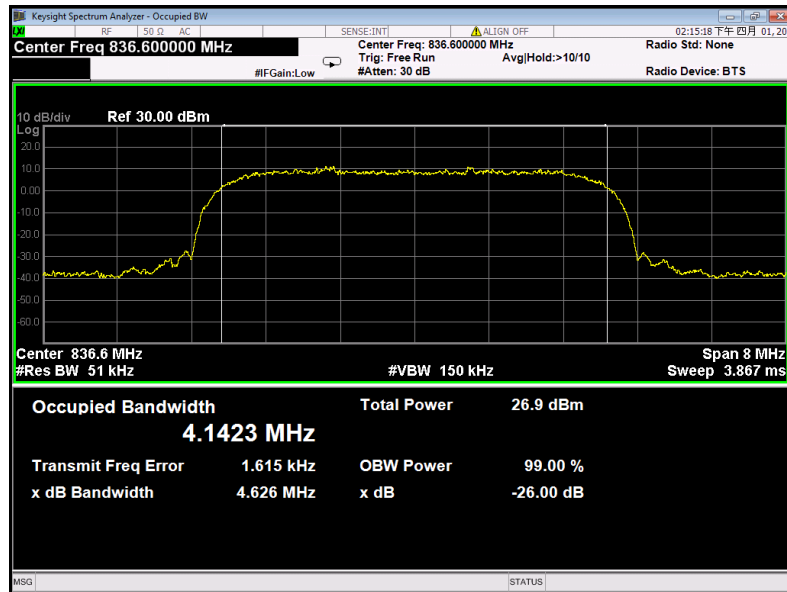

Cellular Band (Part 24E)

PCS 1900

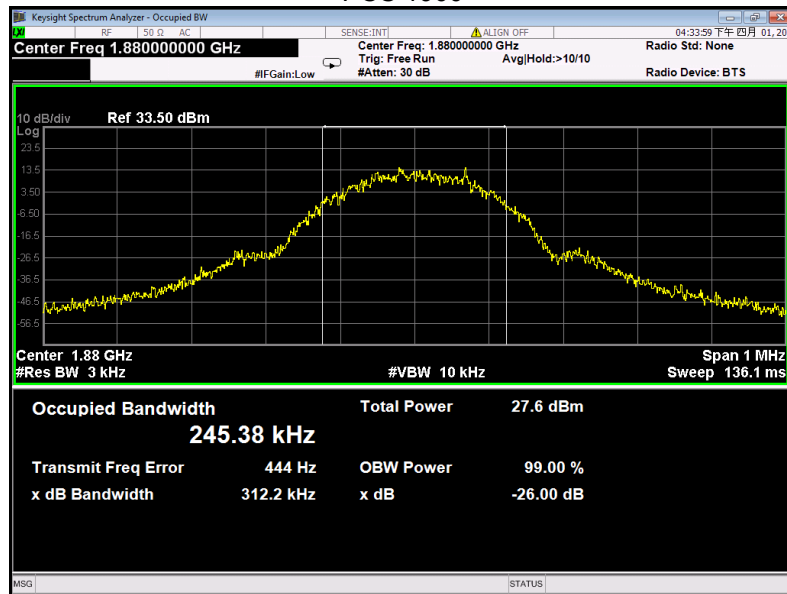

GPRS 1900

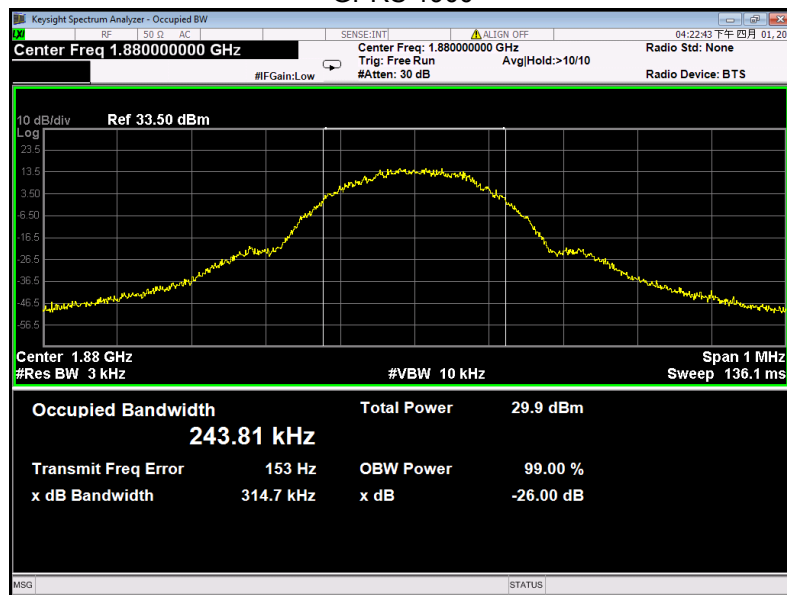

EGPRS 1900

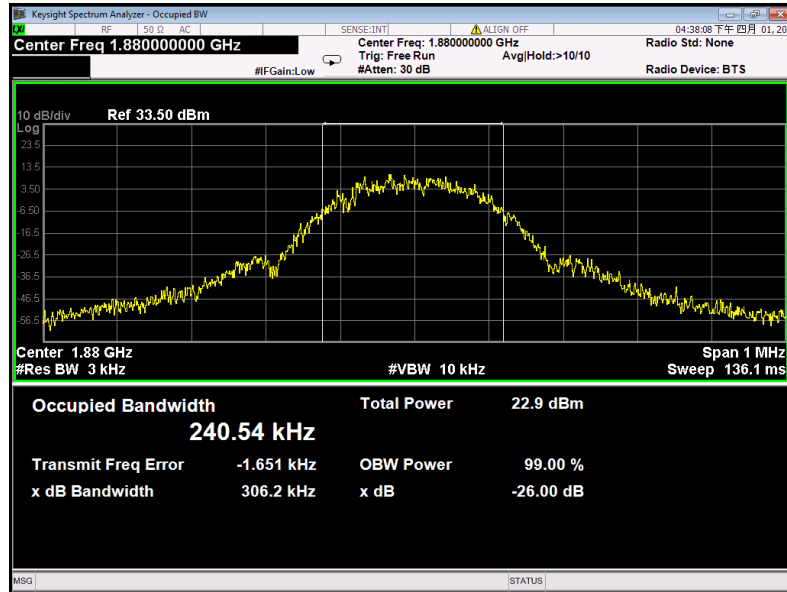

WCDMA band II

RMC12.2k

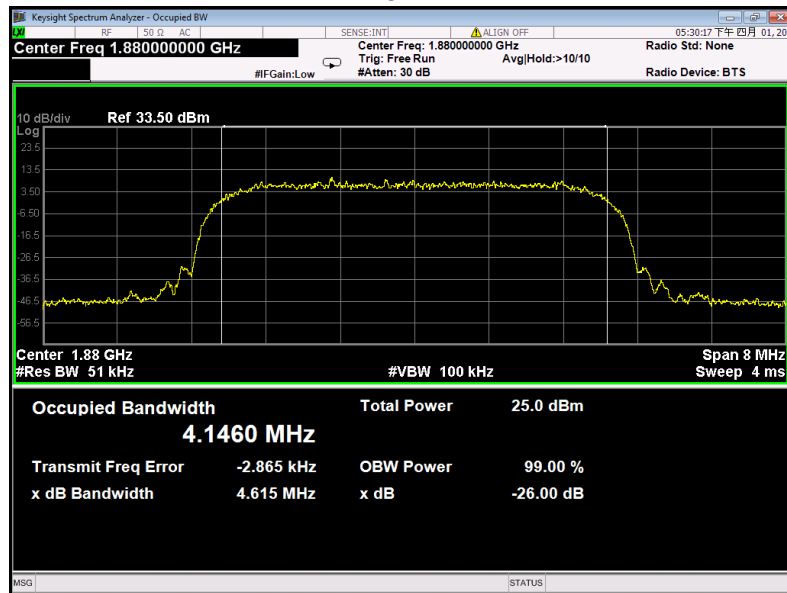

HSDPA

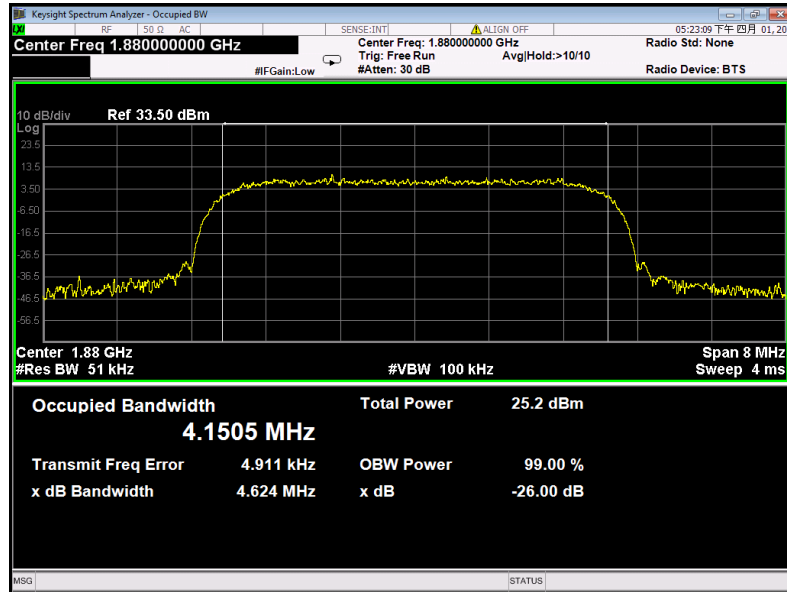

HSUPA

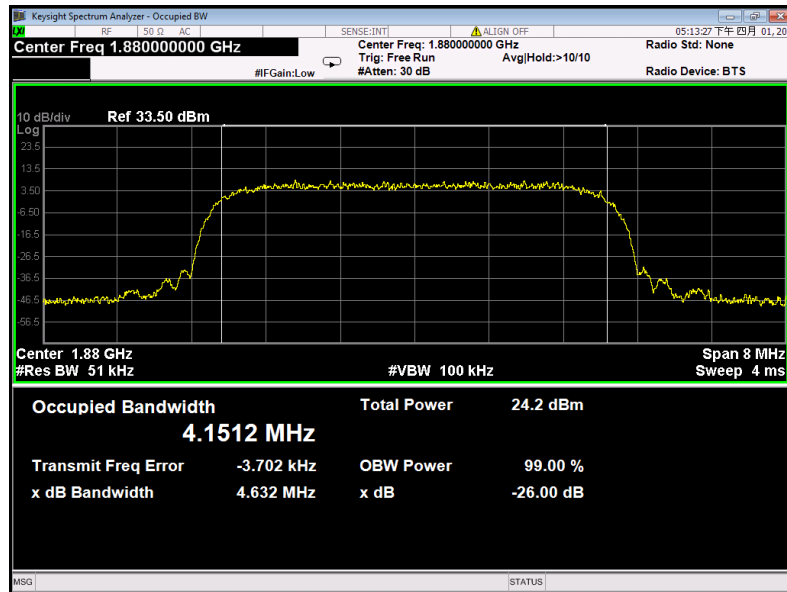

(Part 27L)
 WCDMA band IV
 RMC12.2k

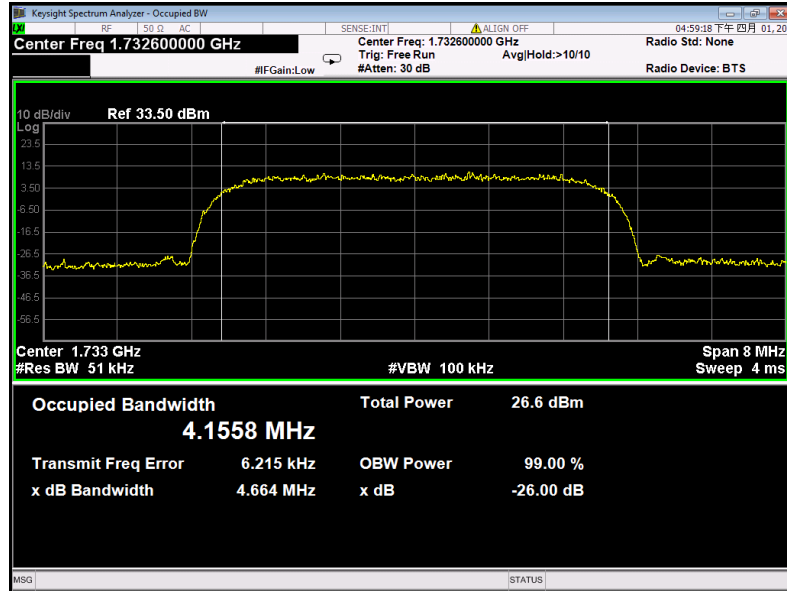

HSDPA

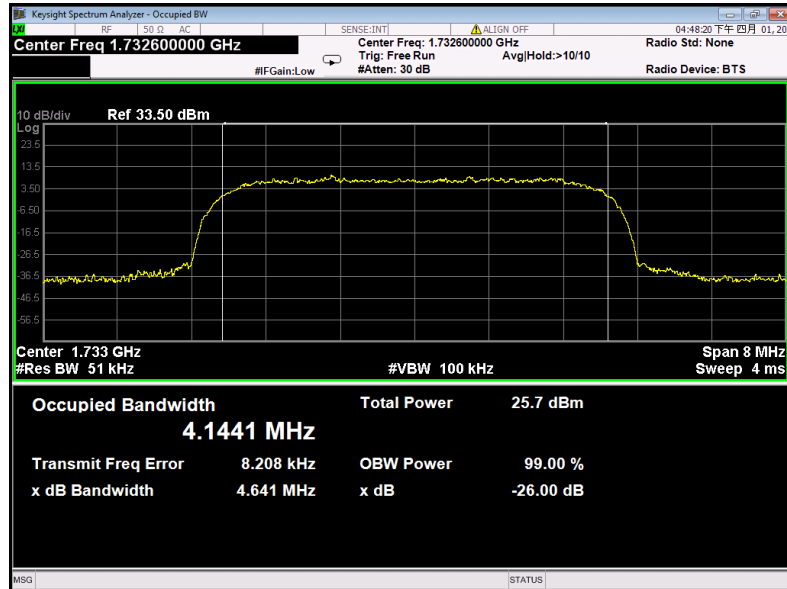

HSUPA

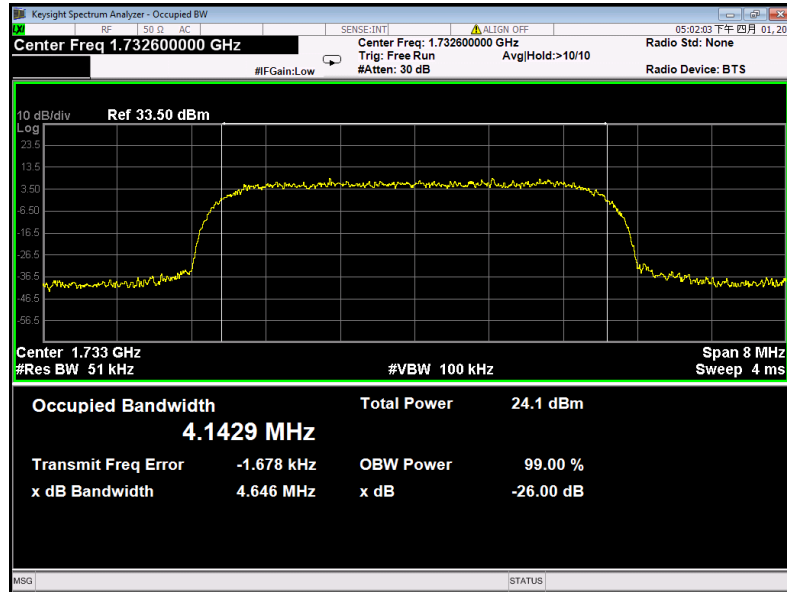

10 Spurious Emissions at Antenna Terminals

Test Requirement: FCC Part 2.1051, 22.917(a), 24.238(a), 27.53(h)

Test Method: ANSI/TIA-603-E:2016

ANSI C63.26:2015

Test Mode: TX transmitting

10.1 EUT Operation

Operating Environment :

Temperature: 23.5 °C

Humidity: 52.1 % RH

Atmospheric Pressure: 101.3kPa

10.2 Test Procedure

The RF output of the transceiver was connected to a spectrum analyzer and simulator through appropriate attenuation. The resolution bandwidth of the spectrum analyzer was set at 1MHz. Sufficient scans were taken to show any out of band emissions up to 10th harmonics.

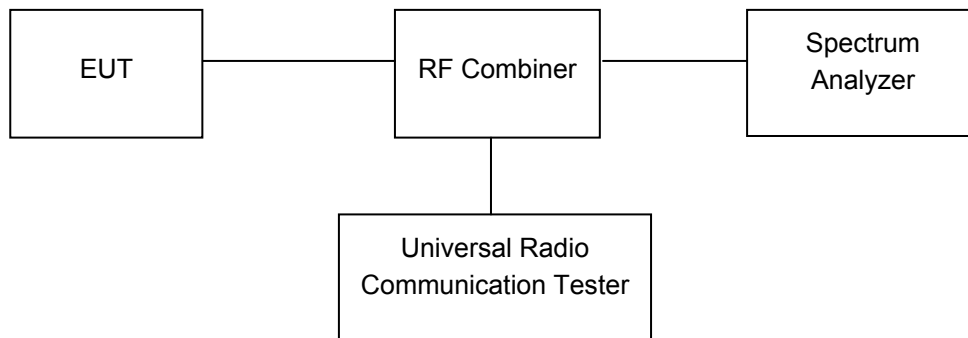

10.3 Test Result

Remark: All test data were reported and only the worst case (middle channel mode) test graphs were showed in test report.

Cellular Band (Part 22H)

GSM 850 - channel 190

30MHz-1GHz

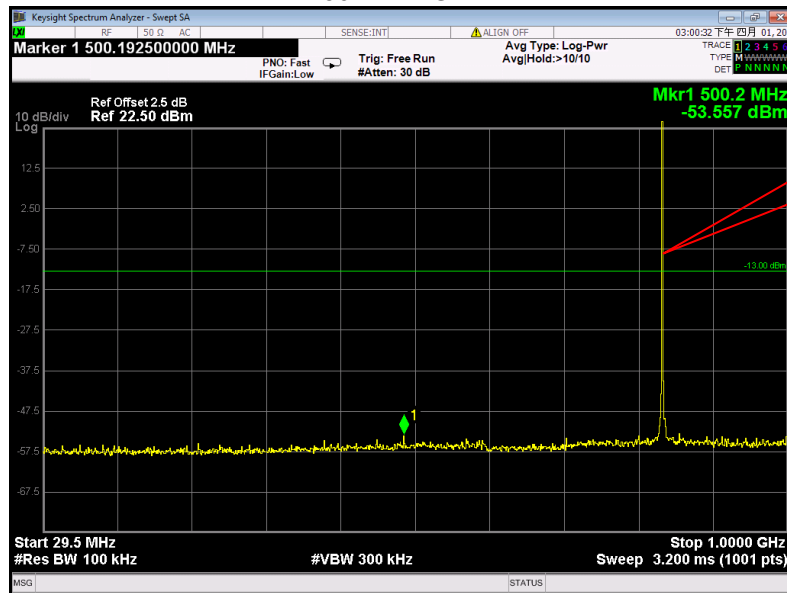

Above 1GHz

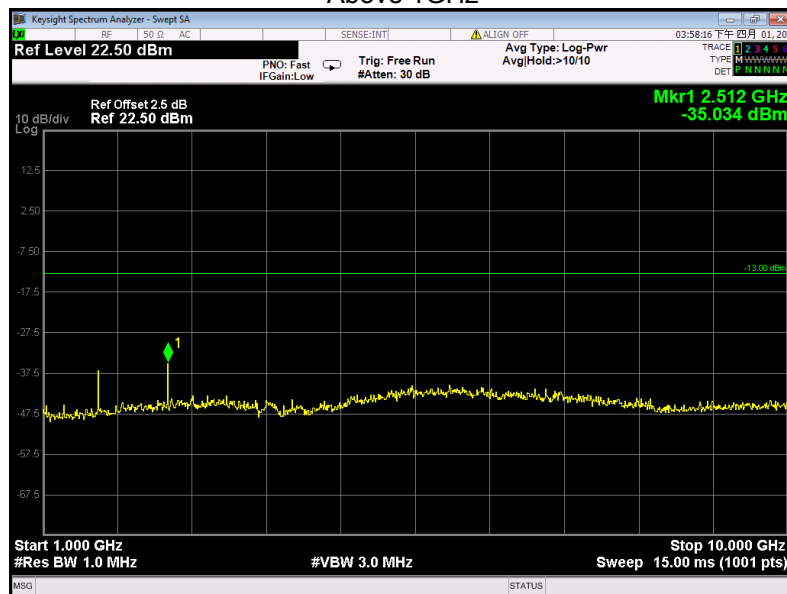

Cellular Band (Part 22H)

GPRS 850 - channel 190

30MHz-1GHz

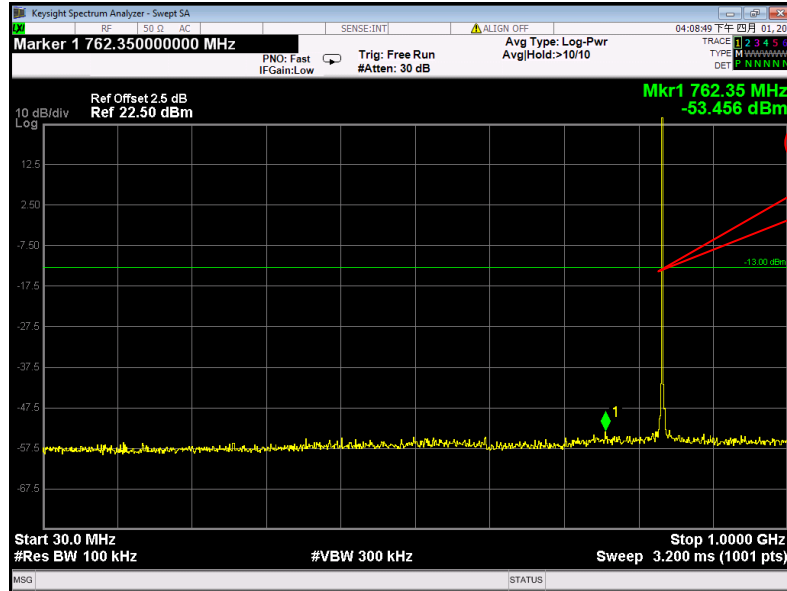

Above 1GHz

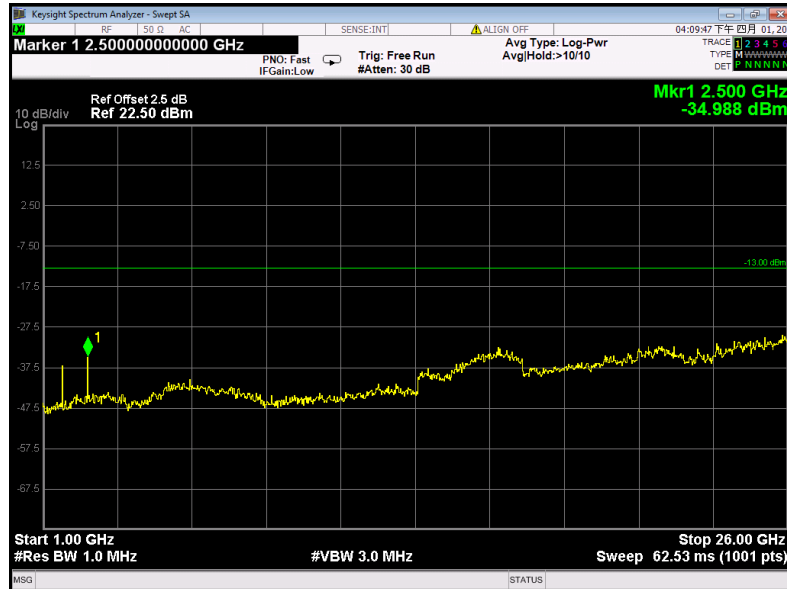

Cellular Band (Part 22H)
EGPRS 850 - channel 190
30MHz-1GHz

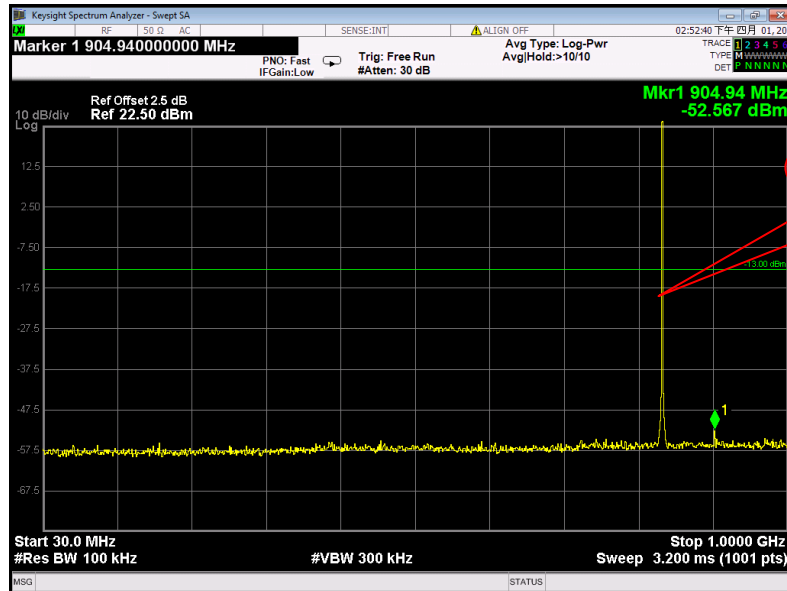

Above 1GHz

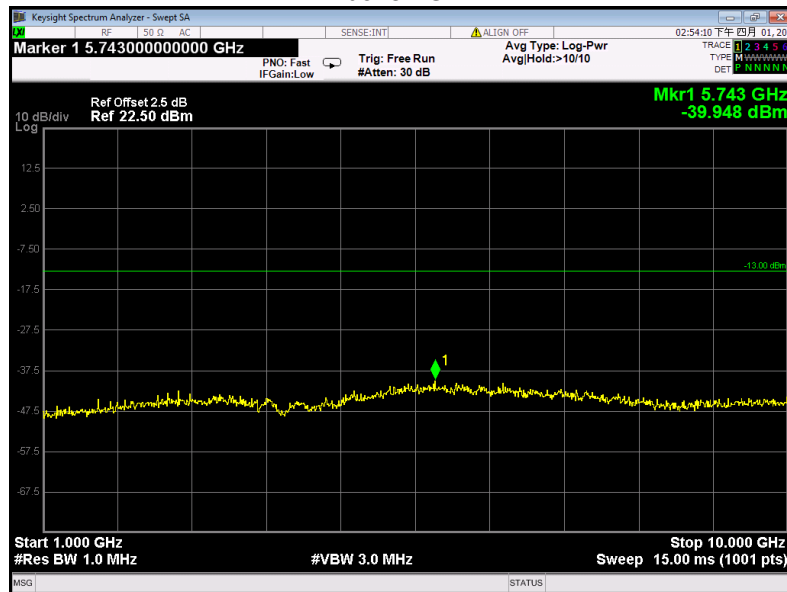

Cellular Band (Part 22H)
WCDMA band V - channel 4183
30MHz-1GHz

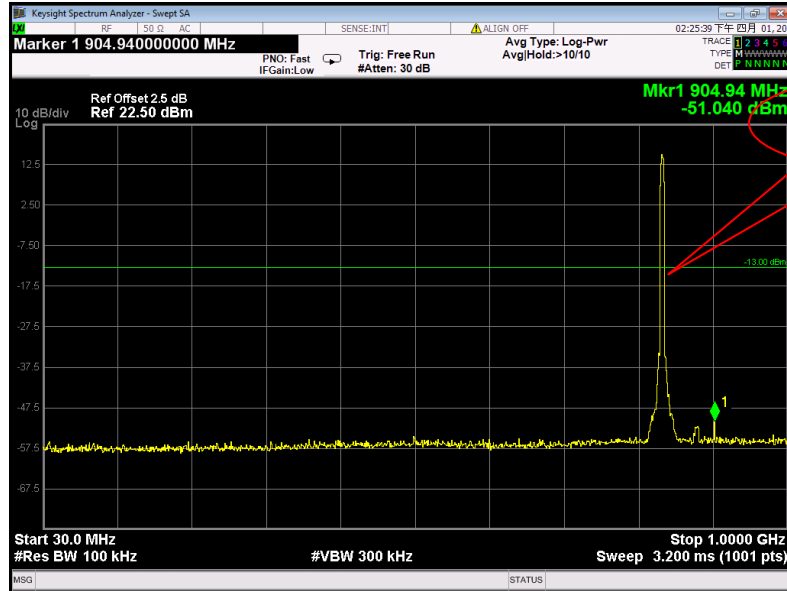

Fundamental

Above 1GHz

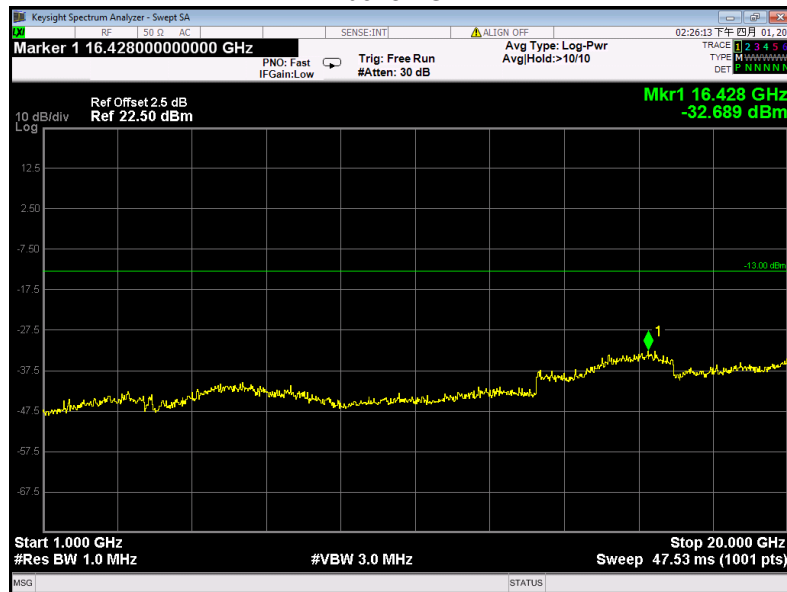

WCDMA band V - channel 4183 (HSDPA)

30MHz-1GHz

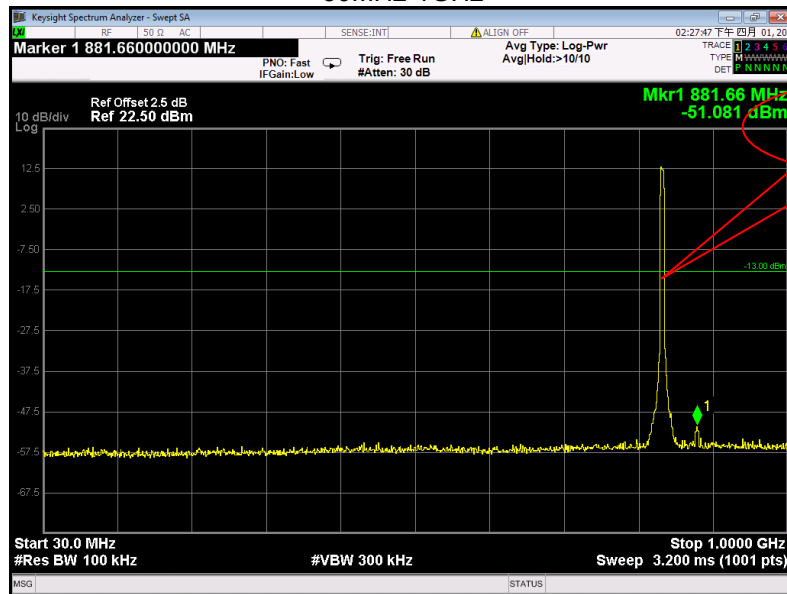

Above 1GHz

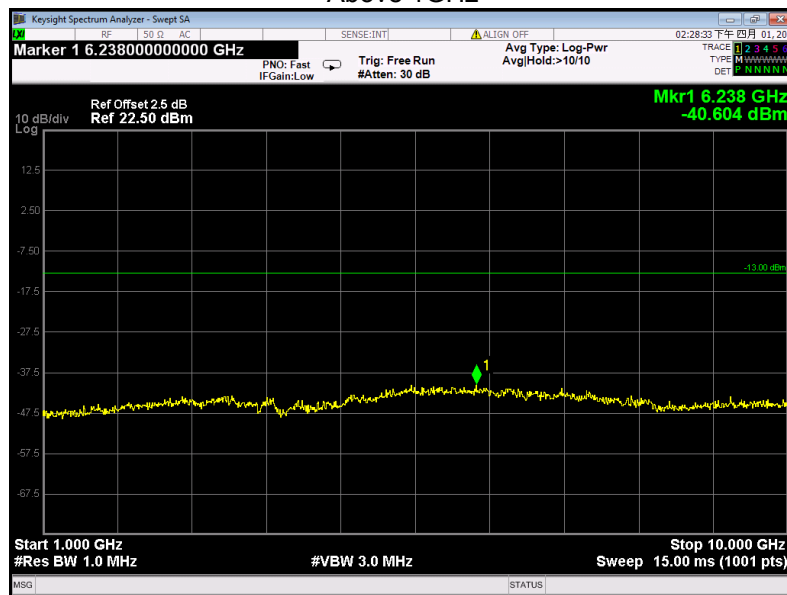

WCDMA band V - channel 4183 (HSUPA)

30MHz-1GHz

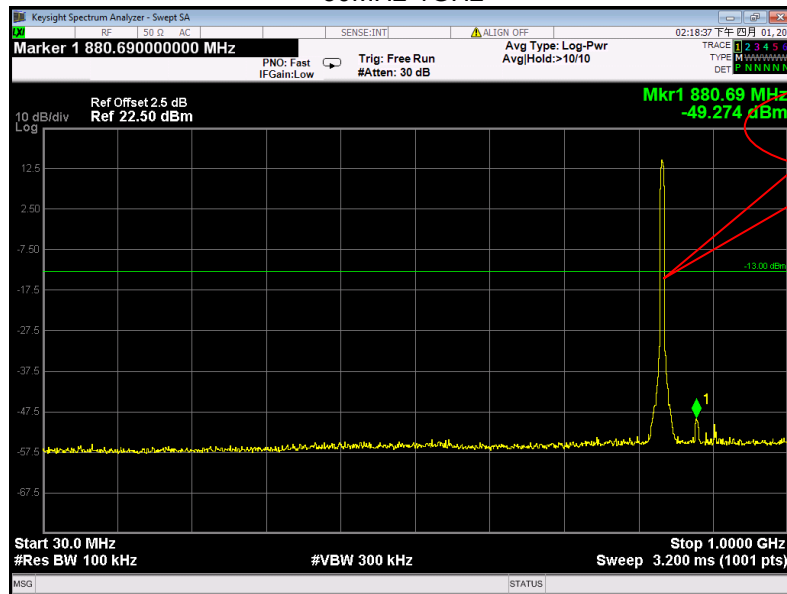

Above 1GHz

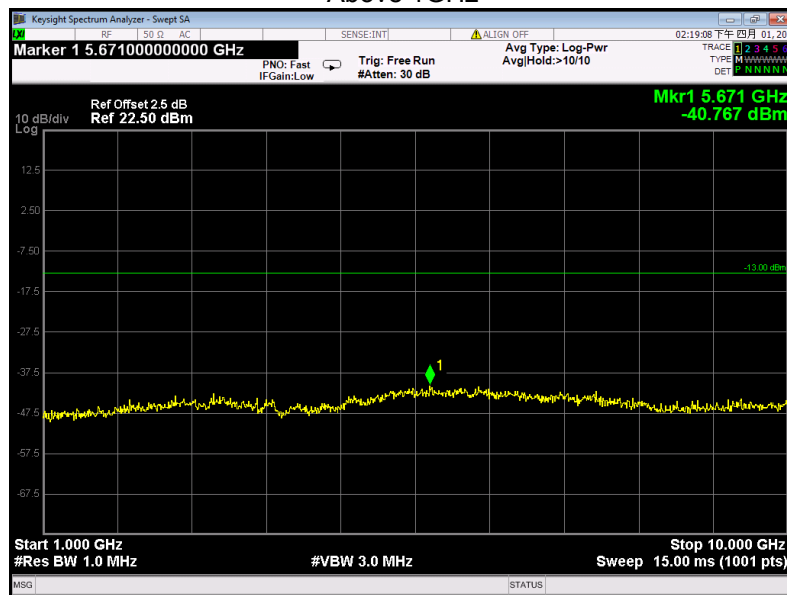

Cellular Band (Part 24E)

PCS 1900 - channel 661

30MHz-1GHz

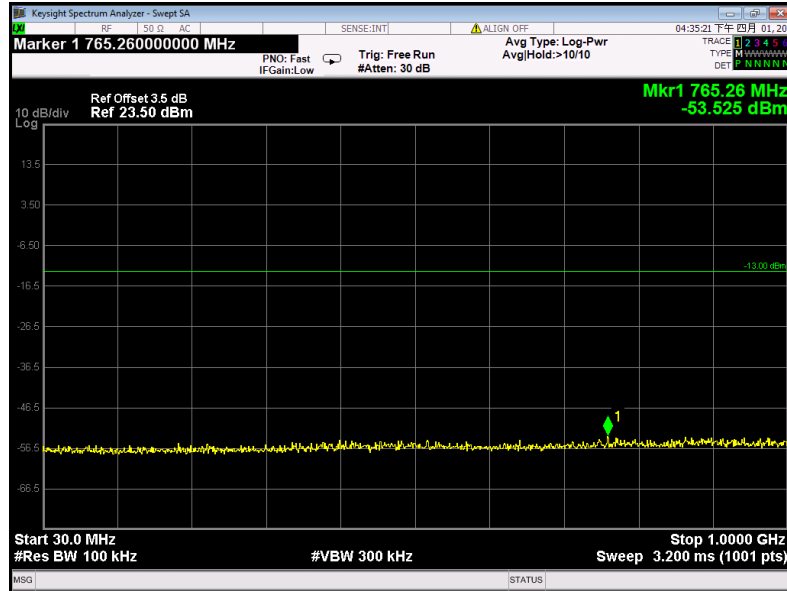

Above 1GHz

Fundamental

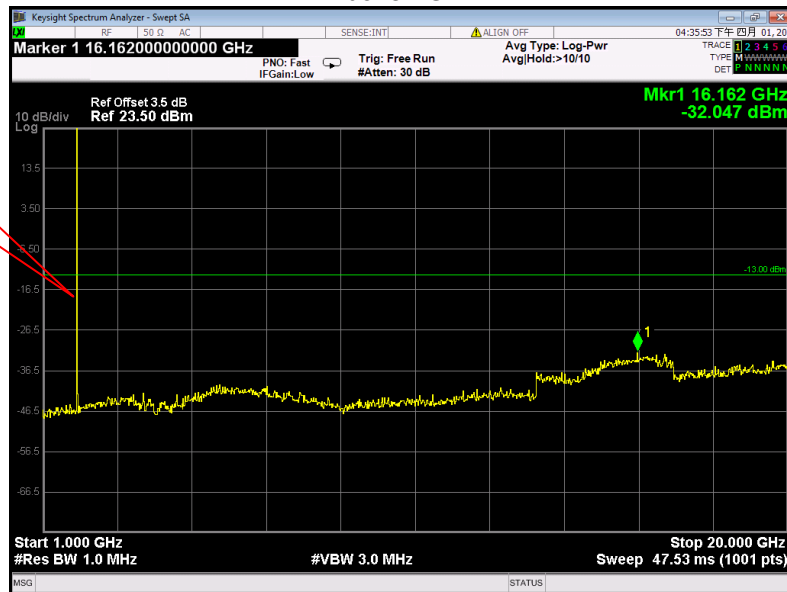

Cellular Band (Part 24E)
GPRS 1900 - channel 661
30MHz-1GHz

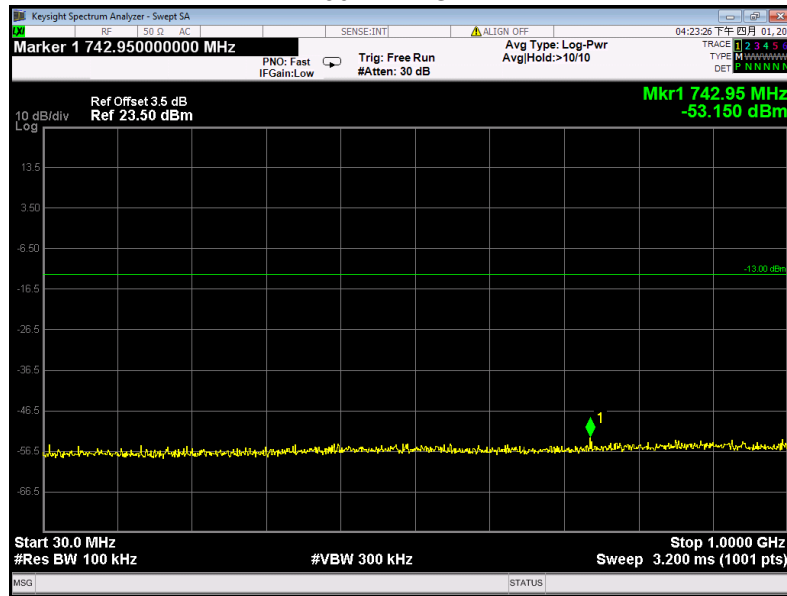

Above 1GHz

Fundamental

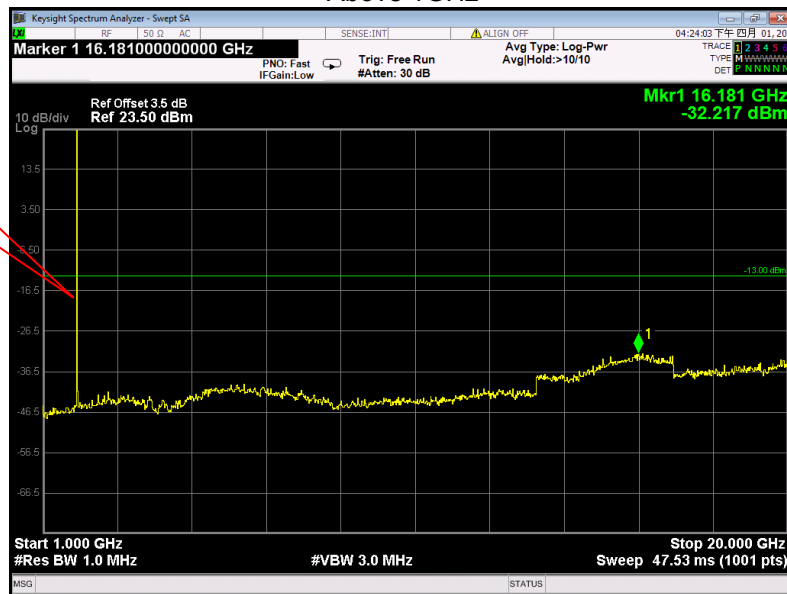

Cellular Band (Part 24E)
EGPRS 1900 - channel 661
30MHz-1GHz

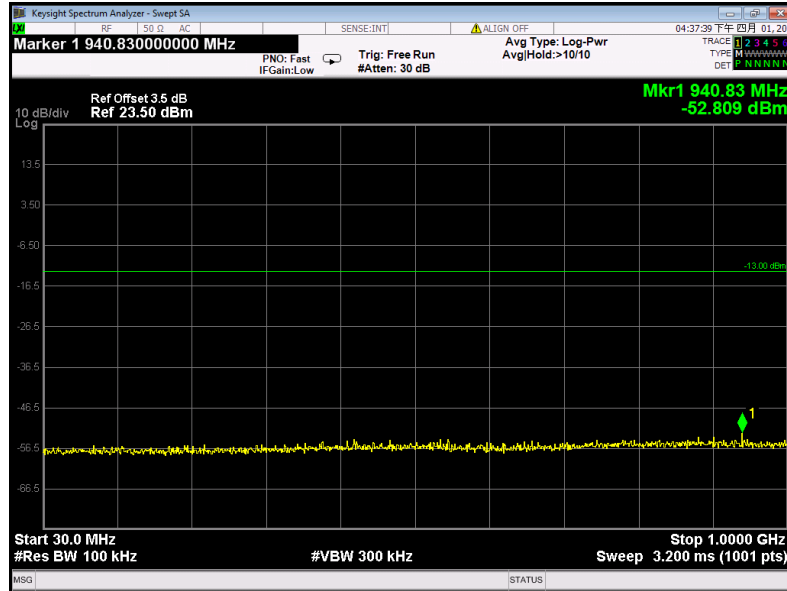

Above 1GHz

Fundamental

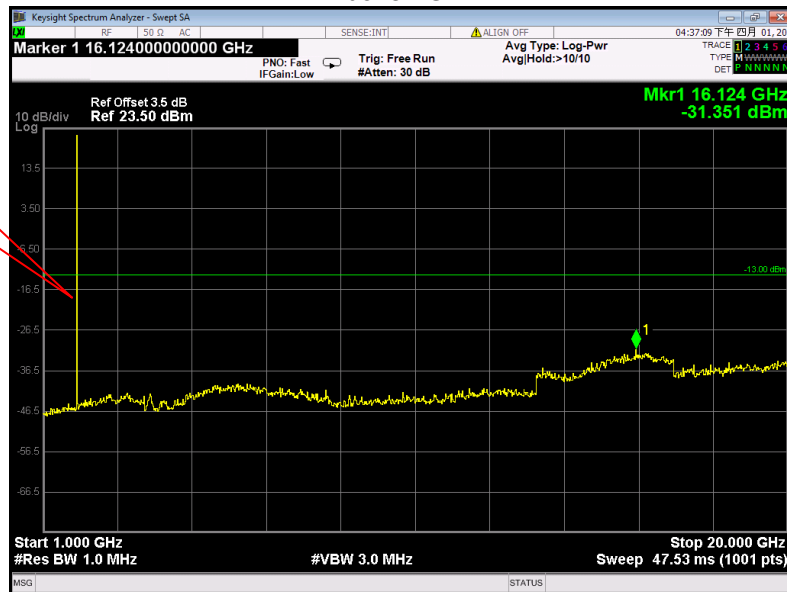

WCDMA band II - channel 9400

30MHz-1GHz

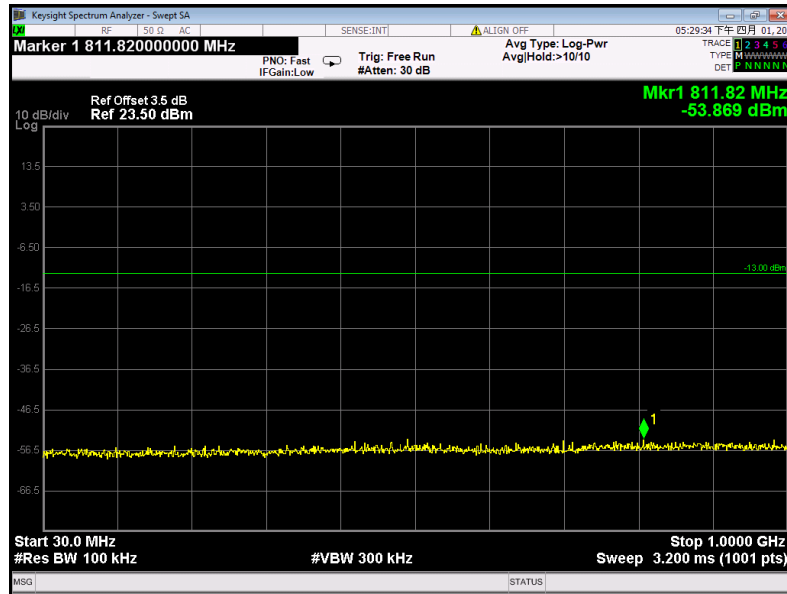

Above 1GHz

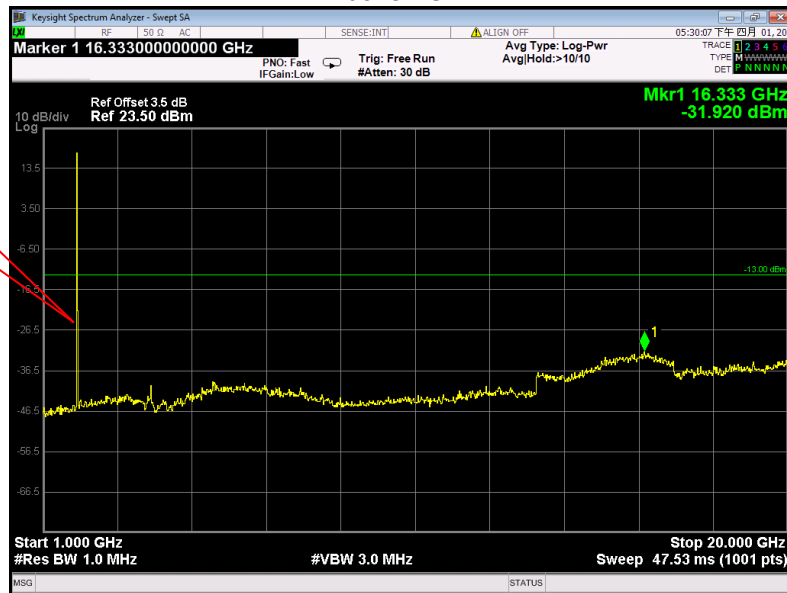
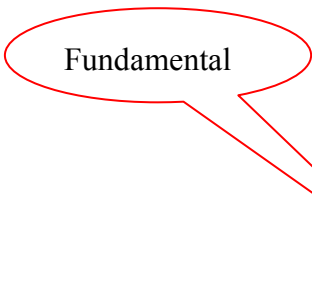

WCDMA band II - channel 9400 (HSDPA)

30MHz-1GHz

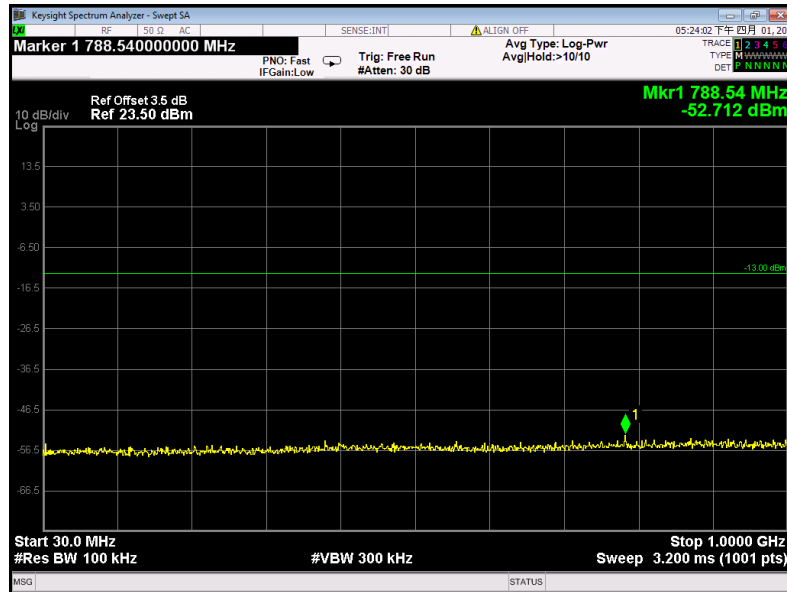

Above 1GHz

Fundamental



WCDMA band II - channel 9400 (HSUPA)

30MHz-1GHz

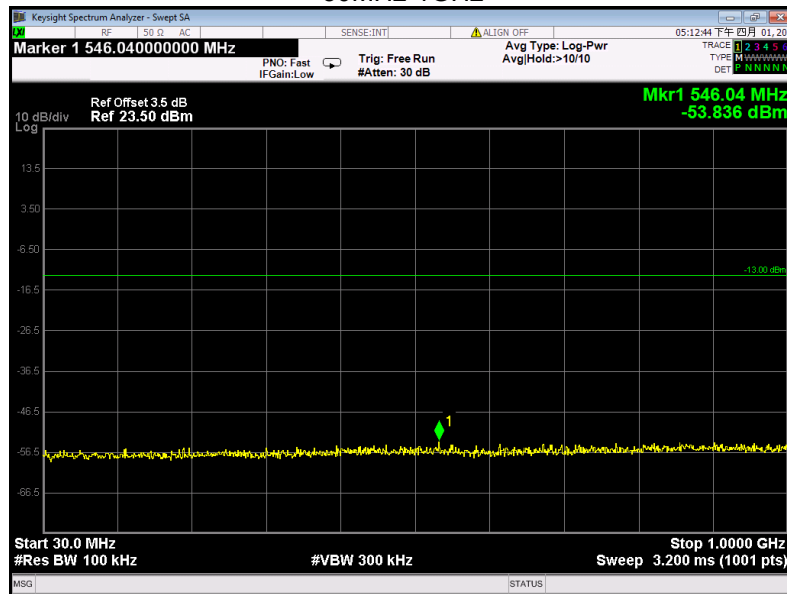

Above 1GHz

Fundamental

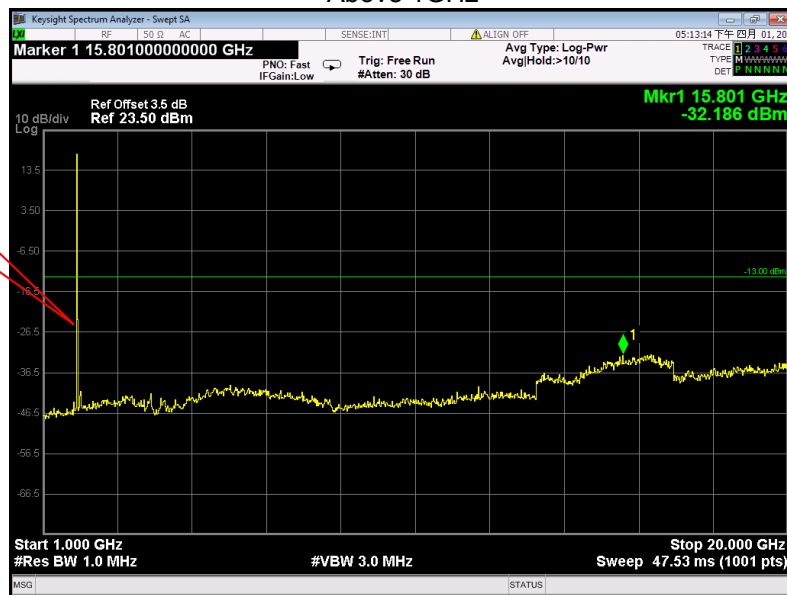

(Part 27L)

WCDMA band IV - channel 1413

30MHz-1GHz

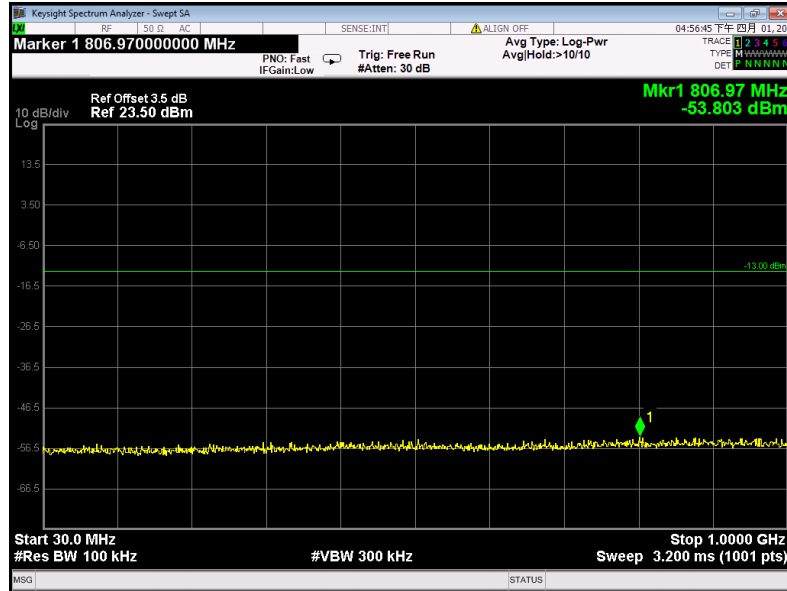

Above 1GHz

Fundamental

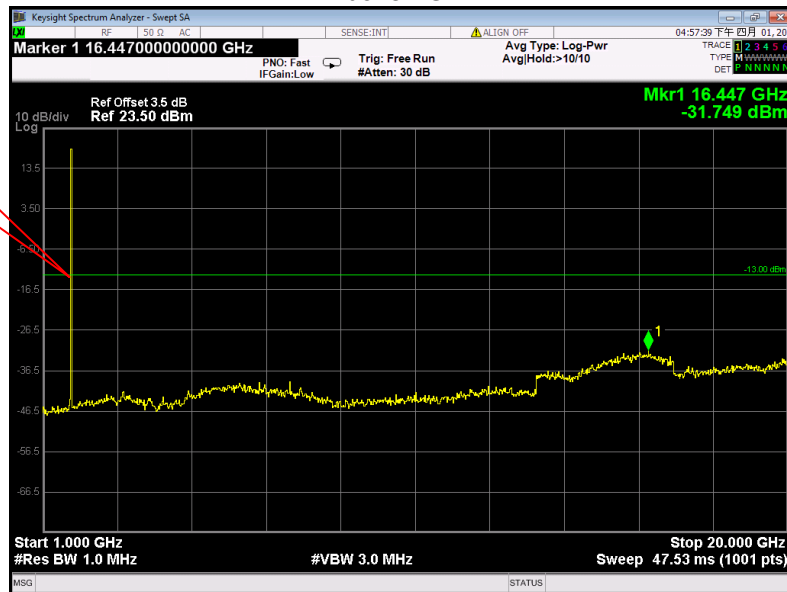

WCDMA band IV - channel 1413 (HSDPA)

30MHz-1GHz

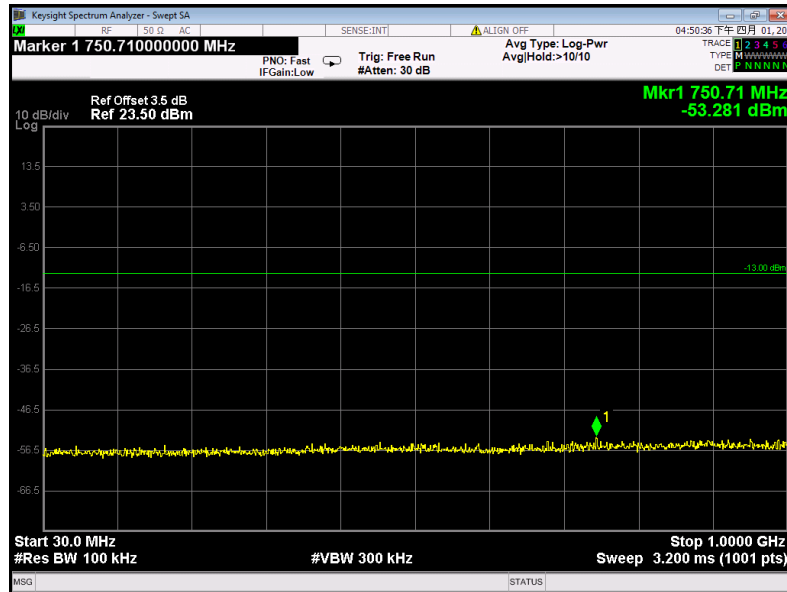

Above 1GHz

Fundamental

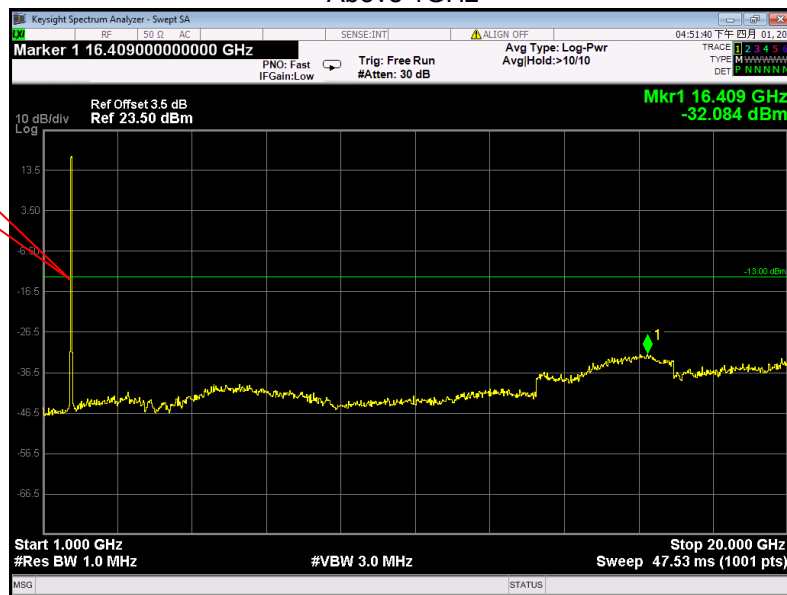

WCDMA band IV - channel 1413 (HSUPA)

30MHz-1GHz

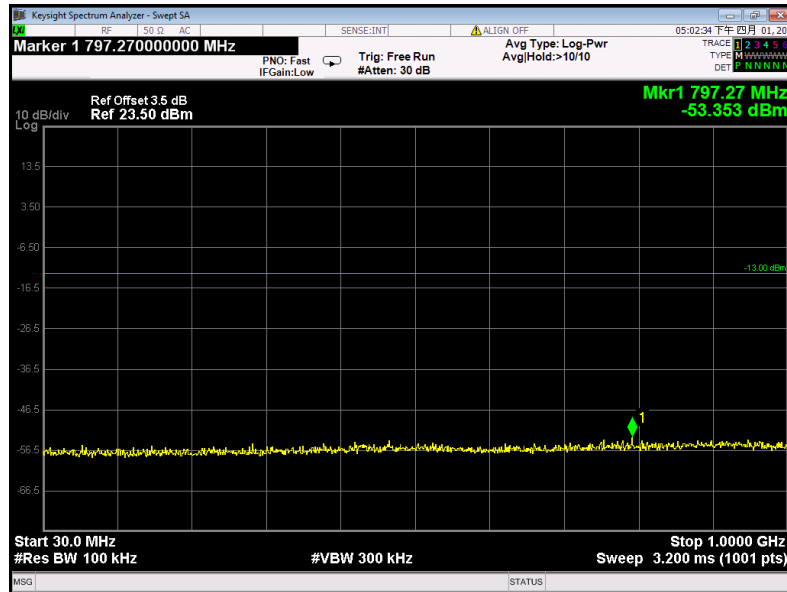

Above 1GHz

Fundamental

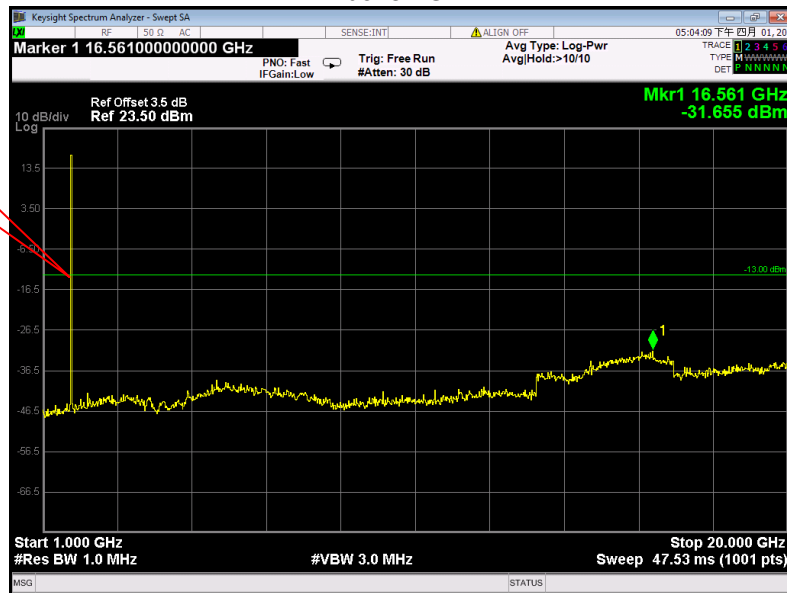

11 Spurious Radiated Emissions

Test Requirement: FCC Part 2.1053, 22.917, 24.238, 27.53(h)

Test Method: ANSI/TIA-603-E:2016

ANSI C63.26:2015

Test Mode: TX transmitting

11.1 EUT Operation

Operating Environment :

Temperature: 23.5 °C

Humidity: 52.1 % RH

Atmospheric Pressure: 101.2kPa

11.2 Test Setup

The radiated emission tests were performed in the 3m Semi- Anechoic Chamber test site. The test setup for emission measurement from 30 MHz to 1 GHz.

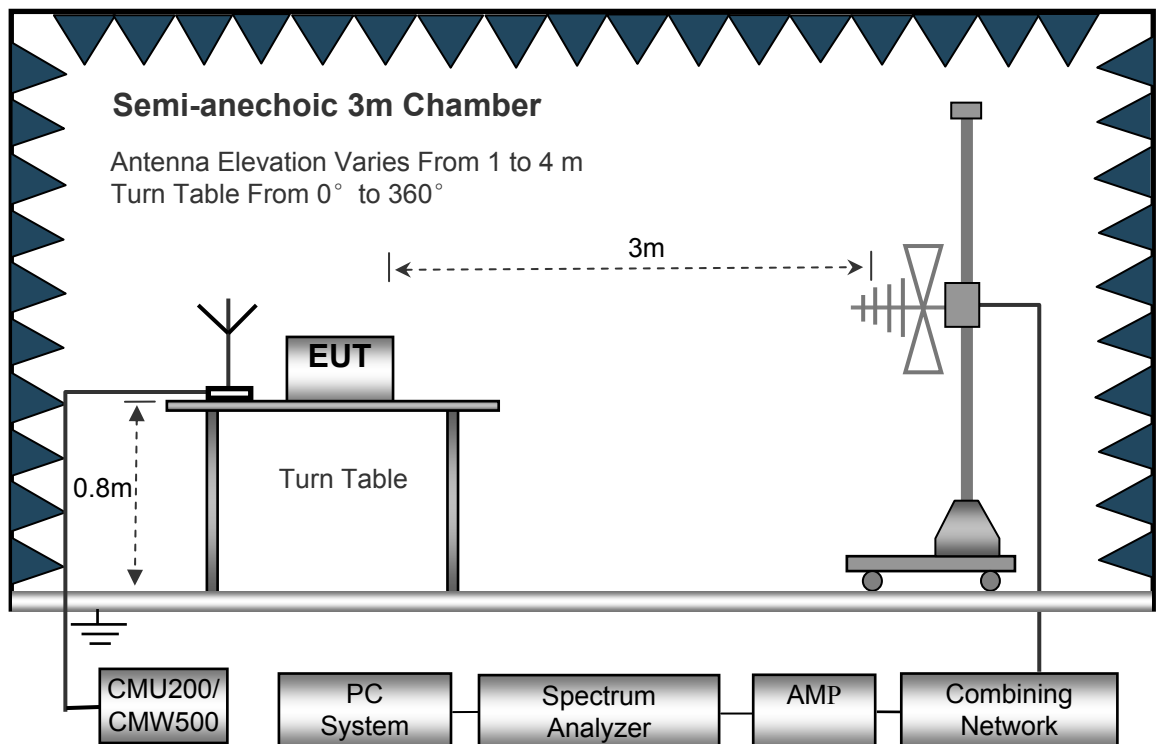

The test setup for emission measurement above 1 GHz.

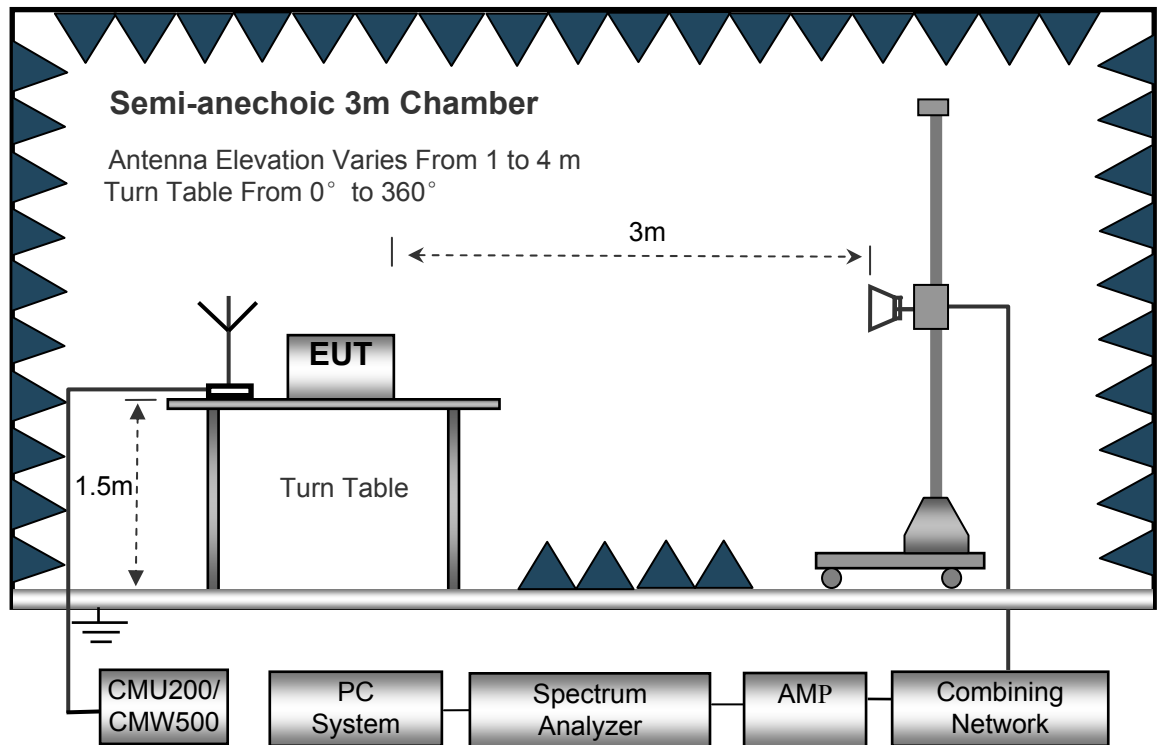

11.3 Spectrum Analyzer Setup

30MHz ~ 1GHz

Sweep Speed Auto
 Detector PK
 Resolution Bandwidth..... 100kHz
 Video Bandwidth..... 300kHz

Above 1GHz

Sweep Speed Auto
 Detector PK
 Resolution Bandwidth..... 1MHz
 Video Bandwidth..... 3MHz
 Detector Ave.
 Resolution Bandwidth..... 1MHz
 Video Bandwidth..... 10Hz

11.4 Test Procedure

1. The EUT is placed on a turntable, which is 0.8m for below 1GHz and 1.5m for above 1GHz above ground plane.
2. The turntable shall be rotated for 360 degrees to determine the position of maximum emission level.
3. EUT is set 3m away from the receiving antenna, which is moved from 1m to 4m to find out the maximum emissions. The spectrum was investigated from 30MHz up to the tenth harmonic of the highest fundamental frequency.
4. Maximum procedure was performed on the six highest emissions to ensure EUT compliance.
5. And also, each emission was to be maximized by changing the polarization of receiving antenna both horizontal and vertical.
6. The radiation measurements are tested under 3-axes(X,Y,Z) position(X denotes lying on the table, Y denotes side stand and Z denotes vertical stand), After pre-test, It was found that the worse radiation emission was get at the Z position. So the data shown was the Z position only.
7. Remove the EUT and replace it with substitution antenna. A signal generator was connected to the substitution antenna by a non-radiating cable. The absolute levels of the spurious emissions were measured by the substitution.
Spurious emissions in dB = $10 \lg (\text{TXpwr in Watts}/0.001)$ – the absolute level
Spurious attenuation limit in dB = $43 + 10 \text{Log}_{10} (\text{power out in Watts})$
8. Repeat above procedures until the measurements for all frequencies are completed.

11.5 Summary of Test Results

For 26MHz~30MHz,

The measurements were more than 20 dB below the limit and not reported.

Remark: Test performed from 30MHz to 10th harmonics with low/middle/high channels, only the worst data were recorded.

Cellular Band (Part 22H)

Frequency	Receiver Reading	Turn table Angle	RX Antenna		Substituted			Absolute Level	Result	
			Height	Polar	SG Level	Cable	Antenna Gain		Limit	Margin
(MHz)	(dB μ V)	Degree	(m)	(H/V)	(dBm)	(dB)	(dB)	(dBm)	(dBm)	(dB)
GSM 850 Channel 128										
223.15	41.19	185	1.0	H	-69.32	0.15	0.00	-69.47	-13.00	-56.47
223.15	44.39	34	1.6	V	-63.20	0.15	0.00	-63.35	-13.00	-50.35
1648.40	66.66	40	1.8	H	-47.31	0.30	9.40	-38.21	-13.00	-25.21
1648.40	58.03	273	1.0	V	-55.50	0.30	9.40	-46.40	-13.00	-33.40
2472.60	58.49	49	1.4	H	-55.51	0.43	10.60	-45.34	-13.00	-32.34
2472.60	48.41	201	1.2	V	-61.87	0.43	10.60	-51.70	-13.00	-38.70
WCDMA Band V Channel 4233										
199.38	41.15	223	1.4	H	-69.36	0.15	0.00	-69.51	-13.00	-56.51
199.38	45.95	201	1.5	V	-61.64	0.15	0.00	-61.79	-13.00	-48.79
1693.20	58.08	128	1.7	H	-55.89	0.30	9.40	-46.79	-13.00	-33.79
1693.20	49.02	225	1.5	V	-64.51	0.30	9.40	-55.41	-13.00	-42.41
2539.80	47.65	209	1.2	H	-66.35	0.43	10.60	-56.18	-13.00	-43.18
2539.80	38.92	324	1.1	V	-71.36	0.43	10.60	-61.19	-13.00	-48.19

Cellular Band (Part 24E)

Frequency	Receiver Reading	Turn table Angle	RX Antenna		Substituted			Absolute Level	Result	
			Height	Polar	SG Level	Cable	Antenna Gain		Limit	Margin
(MHz)	(dB μ V)	Degree	(m)	(H/V)	(dBm)	(dB)	(dB)	(dBm)	(dBm)	(dB)
PCS 1900 Channel 512										
223.15	49.48	331	1.4	H	-61.03	0.15	0.00	-61.18	-13.00	-48.18
223.15	41.05	261	2.2	V	-66.54	0.15	0.00	-66.69	-13.00	-53.69
3700.40	65.95	78	2.0	H	-45.59	2.37	12.50	-35.46	-13.00	-22.46
3700.40	59.98	108	1.6	V	-49.83	2.37	12.50	-39.70	-13.00	-26.70
5550.60	53.58	43	1.5	H	-56.03	2.86	12.90	-45.99	-13.00	-32.99
5550.60	44.73	342	2.1	V	-64.15	2.86	12.90	-54.11	-13.00	-41.11
WCDMA Band II Channel 9400										
199.38	36.43	348	1.6	H	-74.08	0.15	0.00	-74.23	-13.00	-61.23
199.38	37.45	207	1.2	V	-70.14	0.15	0.00	-70.29	-13.00	-57.29
3760.00	58.01	299	2.0	H	-53.53	2.37	12.50	-43.40	-13.00	-30.40
3760.00	53.85	122	1.5	V	-55.96	2.37	12.50	-45.83	-13.00	-32.83
5640.00	47.52	306	1.9	H	-62.09	2.86	12.90	-52.05	-13.00	-39.05
5640.00	37.04	319	1.1	V	-71.84	2.86	12.90	-61.80	-13.00	-48.80

Cellular Band (Part 27L)

Frequency	Receiver Reading	Turn table Angle	RX Antenna		Substituted			Absolute Level	Result	
			Height	Polar	SG Level	Cable	Antenna Gain		Limit	Margin
(MHz)	(dB μ V)	Degree	(m)	(H/V)	(dBm)	(dB)	(dB)	(dBm)	(dBm)	(dB)
WCDMA Band IV Channel 1313										
223.15	50.49	179	2.1	H	-60.02	0.15	0.00	-60.17	-13.00	-47.17
223.15	42.38	105	2.0	V	-65.21	0.15	0.00	-65.36	-13.00	-52.36
3424.80	53.62	338	1.6	H	-57.92	2.37	12.50	-47.79	-13.00	-34.79
3424.80	45.75	35	1.8	V	-64.06	2.37	12.50	-53.93	-13.00	-40.93
5137.20	39.57	7	1.2	H	-70.04	2.86	12.90	-60.00	-13.00	-47.00
5137.20	31.46	253	2.1	V	-77.42	2.86	12.90	-67.38	-13.00	-54.38

Note: 1) Absolute Level = SG Level - Cable loss + Antenna Gain

2) Margin = Limit- Absolute Level

12 Band Edge Measurement

Test Requirement:	FCC Part 2.1051, 22.917(a), 24.238(a), 27.53(h)
Test Method:	ANSI/TIA-603-E:2016 ANSI C63.26:2015
Test Mode:	TX transmitting

12.1 EUT Operation

Operating Environment :

Temperature:	23.5 °C
Humidity:	52.3 % RH
Atmospheric Pressure:	101.3kPa

12.2 Test Procedure

The RF output of the transmitter was connected to the input of the spectrum analyzer through sufficient attenuation.

According to FCC Part 22.917(a), the power of any emissions outside of the authorized operating frequency ranges must be attenuated below the TX transmitting power (P) by a factor of at least $43 + 10 \log(P)$ dB.

According to FCC Part 24.238(a), the power of any emissions outside of the authorized operating frequency ranges must be attenuated below the TX transmitting power (P) by a factor of at least $43 + 10 \log(P)$ dB.

The center of the spectrum analyzer was set to block edge frequency

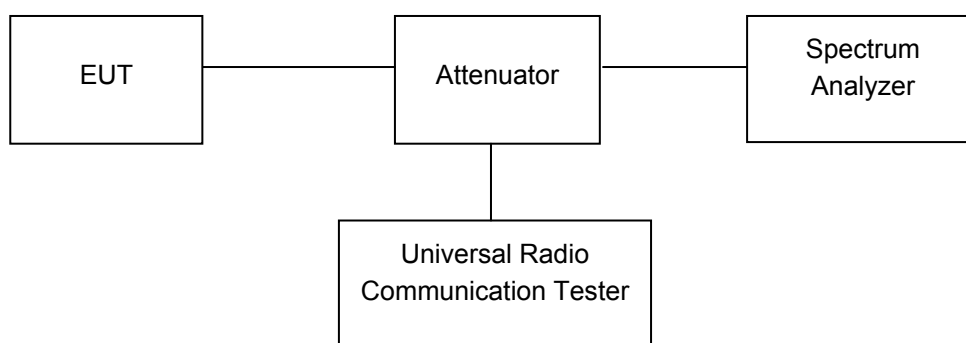

12.3 Test Result

Test plots Cellular Band (Part 22H) GSM 850 band edge-left side

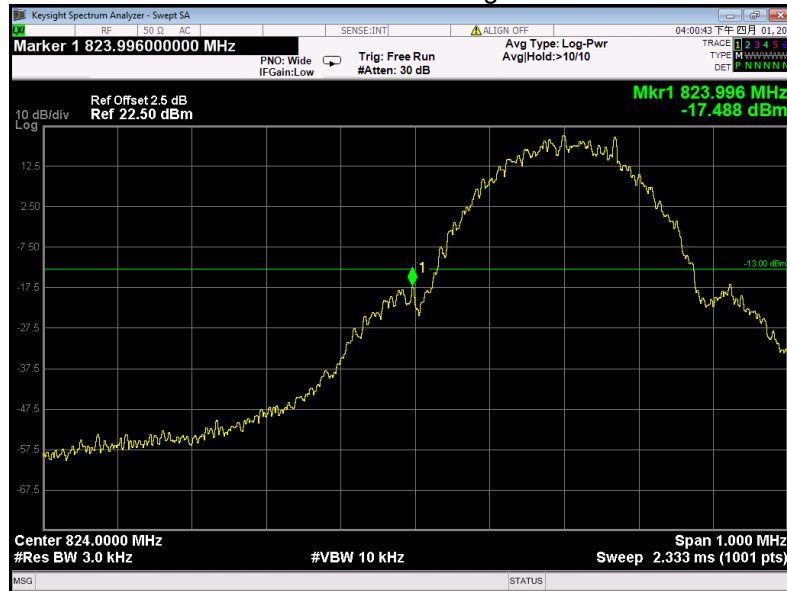

GSM 850 band edge-right side

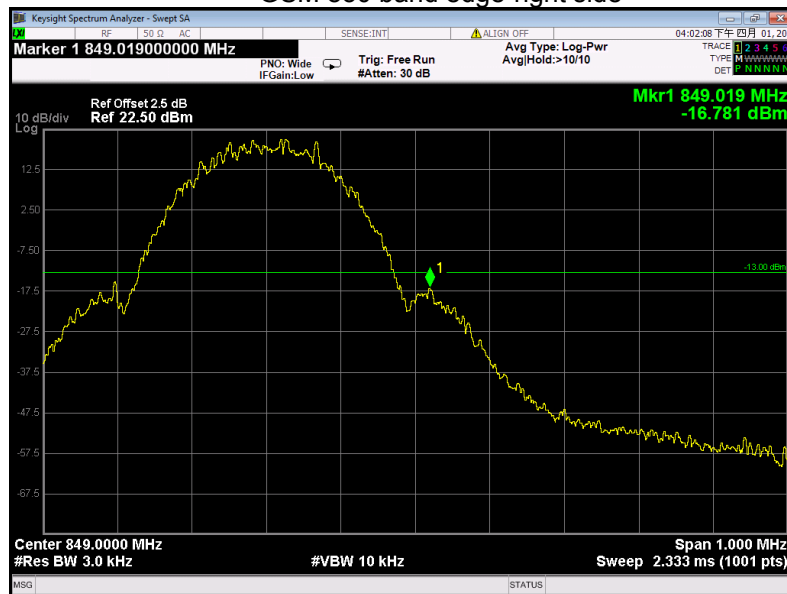

GPRS 850 band edge-left side

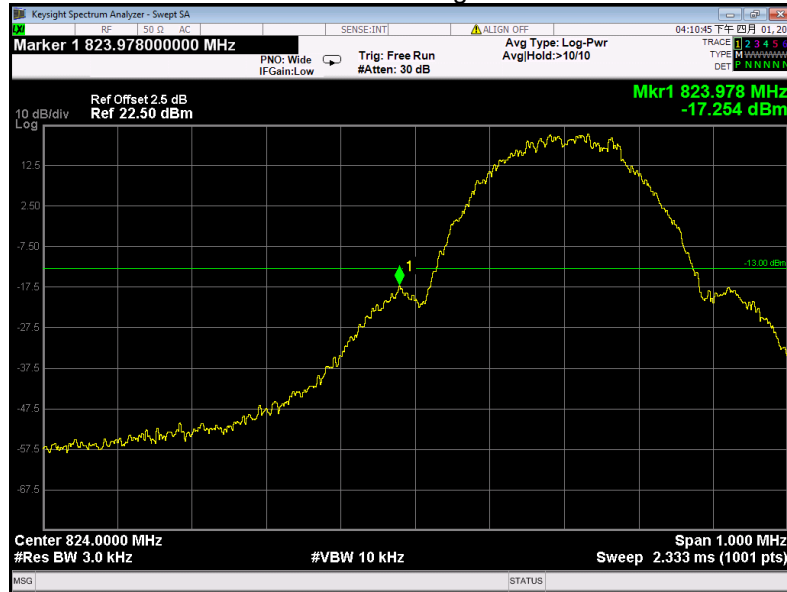

GPRS 850 band edge-right side

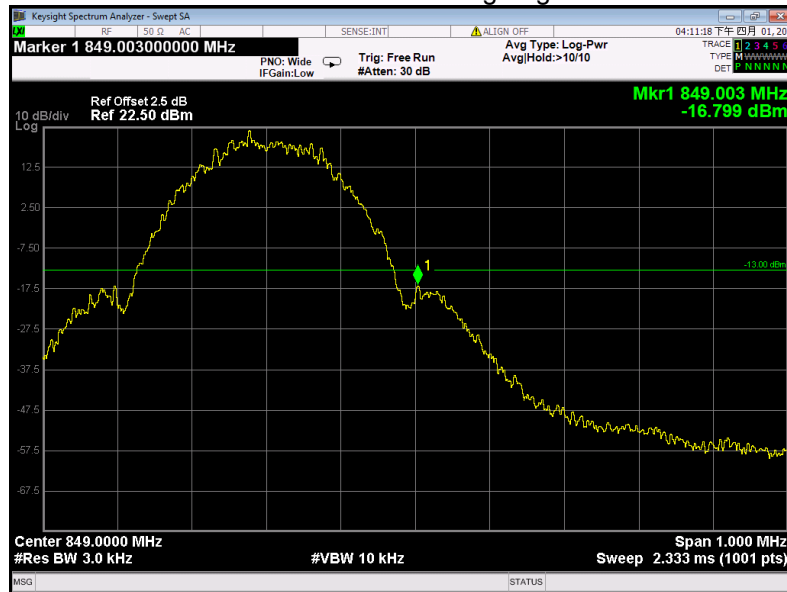

EGPRS 850 band edge-left side

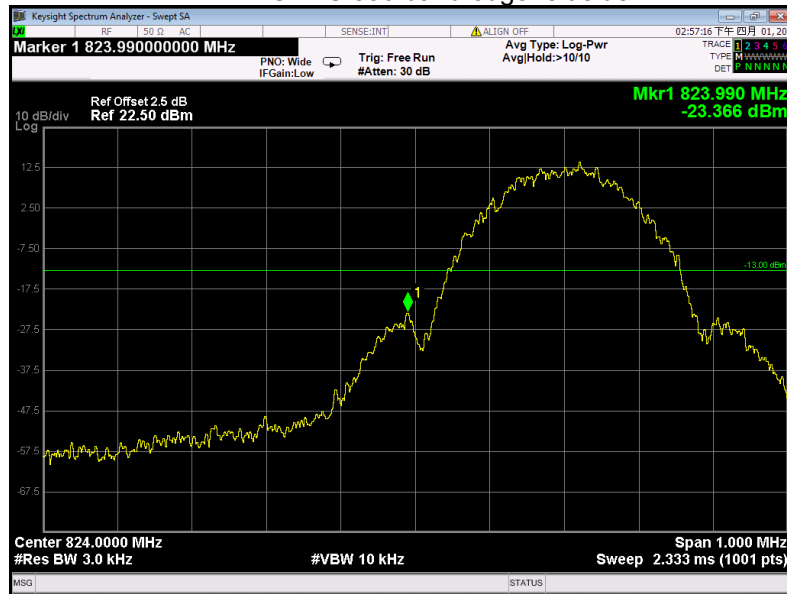

EGPRS 850 band edge-right side

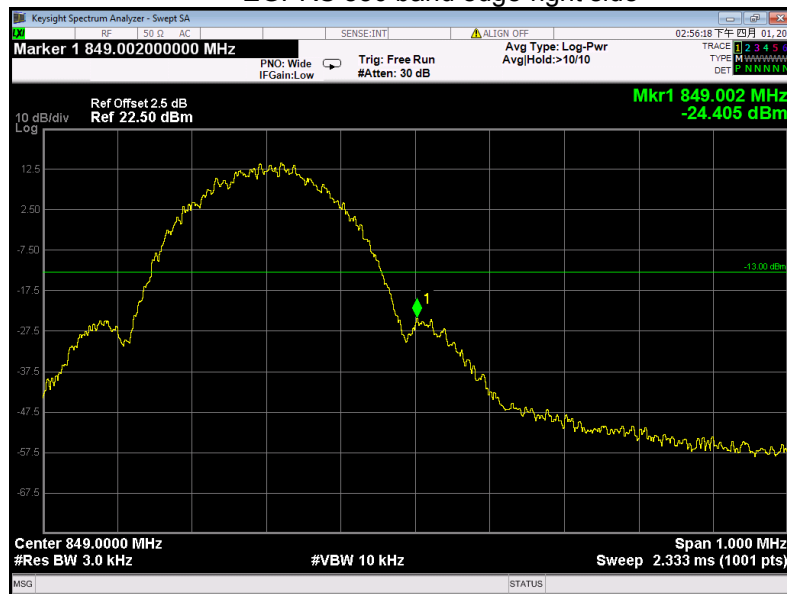

WCDMA band V band edge-left side

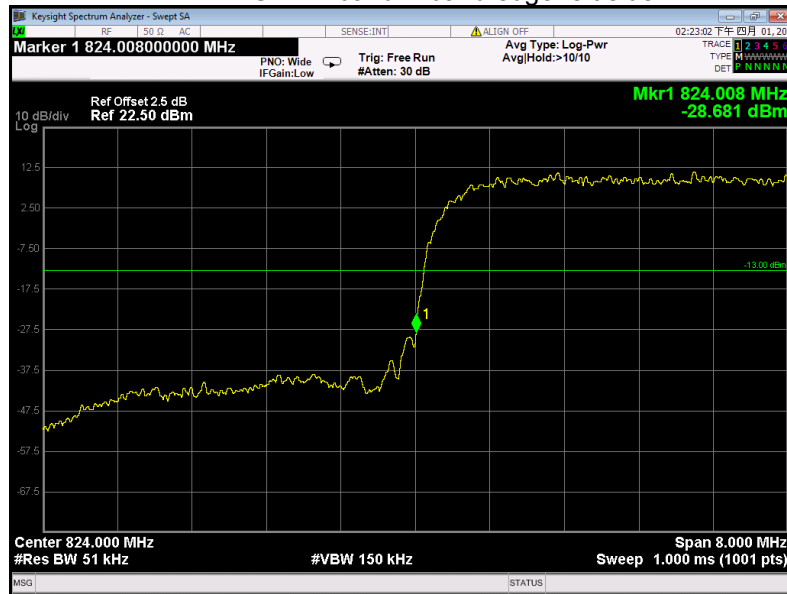

WCDMA band V band edge-right side



WCDMA band V band edge-left side (HSDPA)

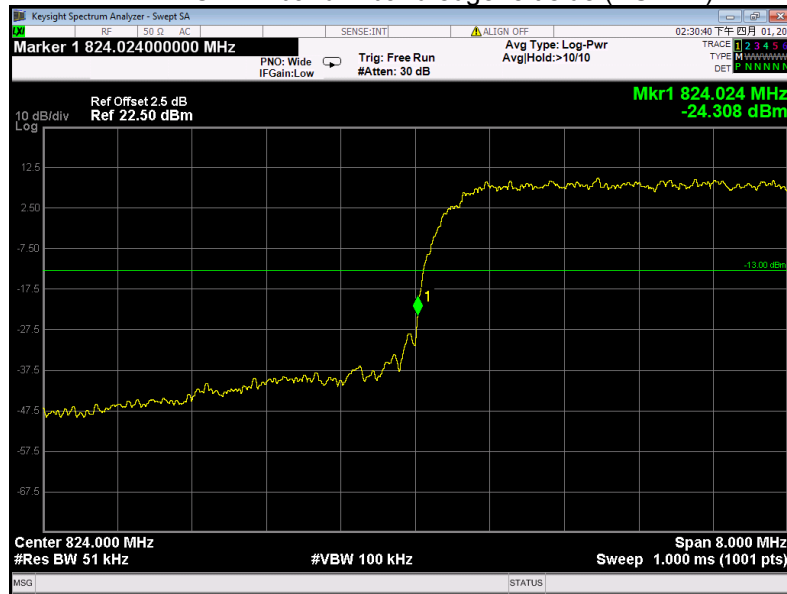

WCDMA band V band edge-right side (HSDPA)

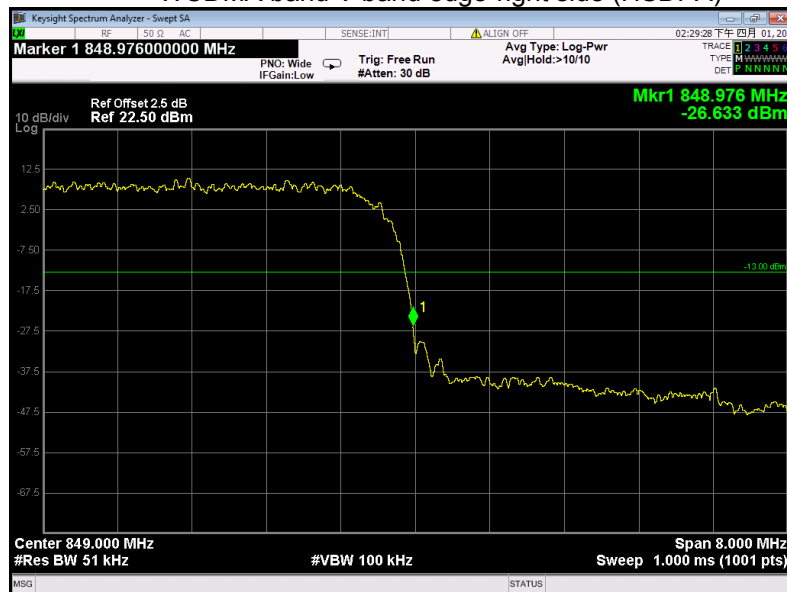

WCDMA band V band edge-left side (HSUPA)

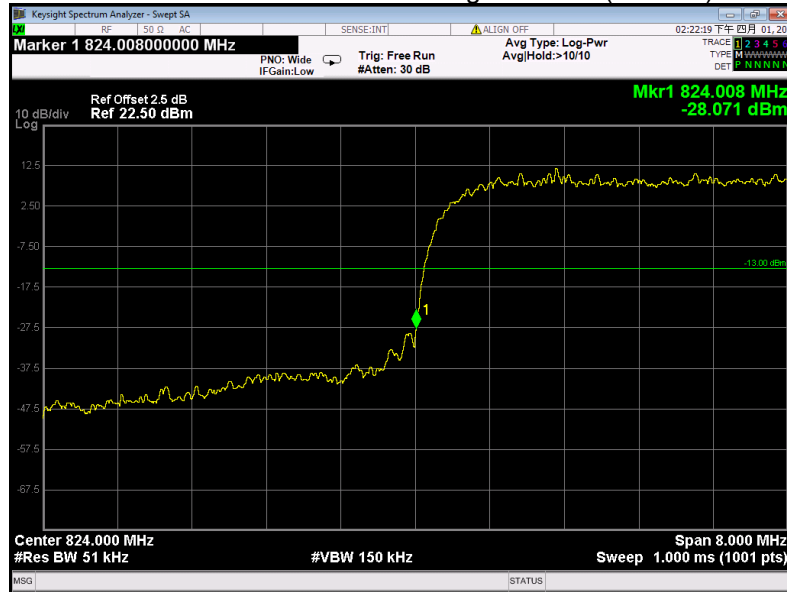

WCDMA band V band edge-right side (HSUPA)



Cellular Band (Part 24E) PCS 1900 band edge-left side

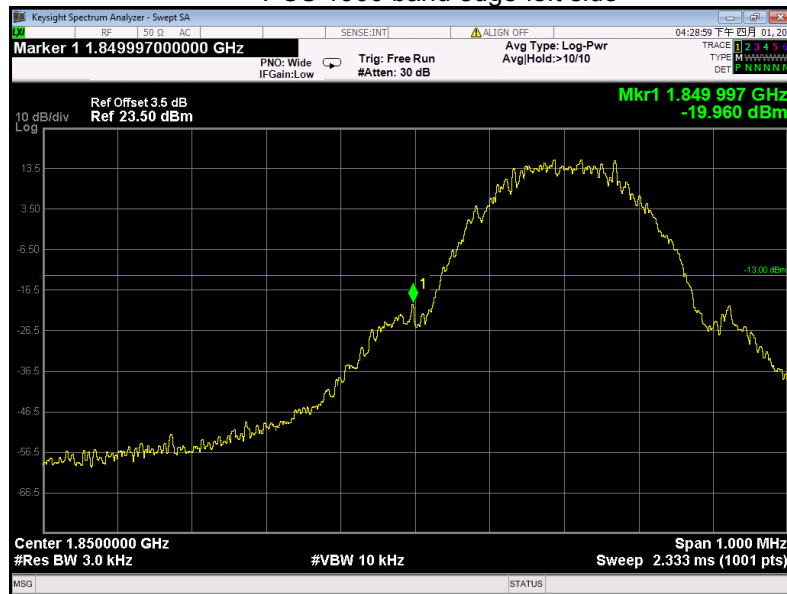

PCS 1900 band edge-right side



GPRS 1900 band edge-left side

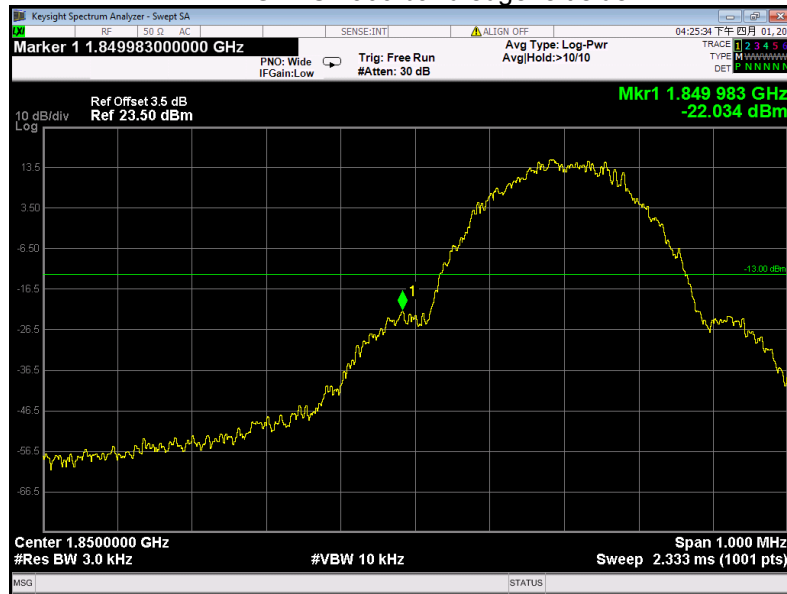

GPRS 1900 band edge-right side

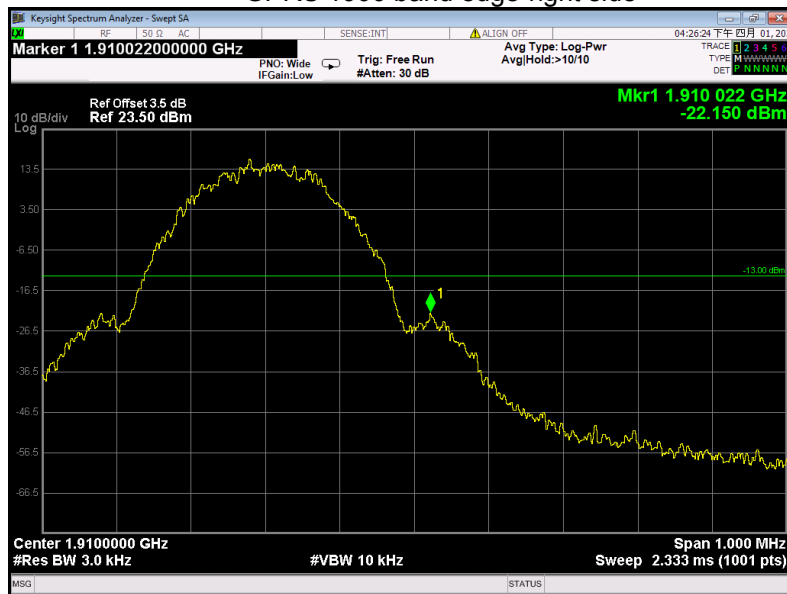

EGPRS 1900 band edge-left side

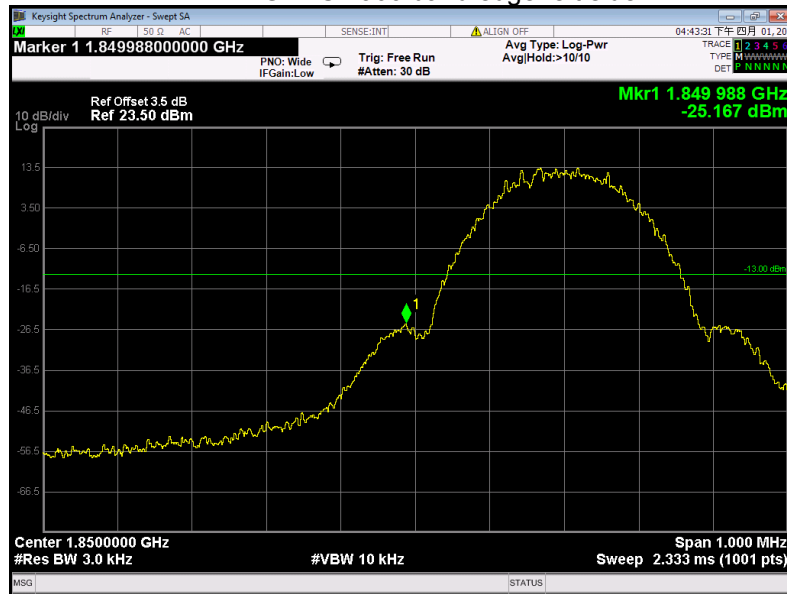

EGPRS 1900 band edge-right side

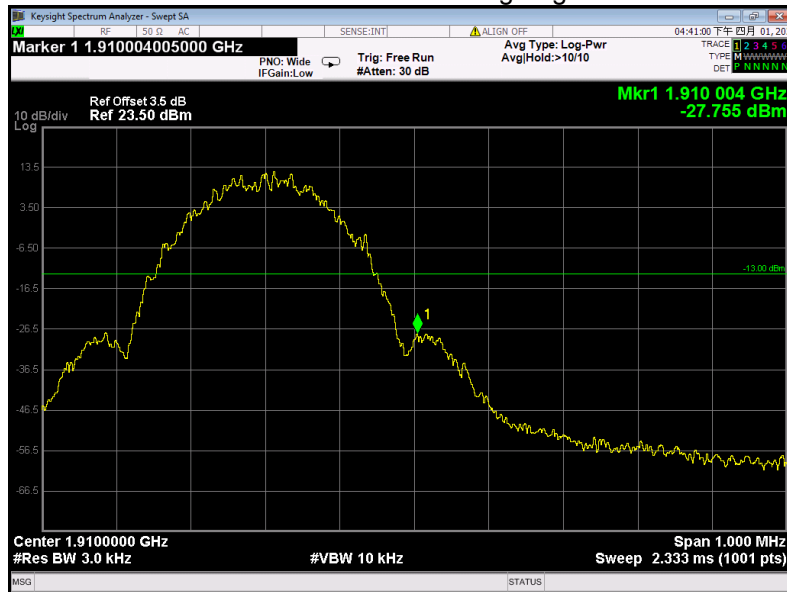

WCDMA band II band edge-left side

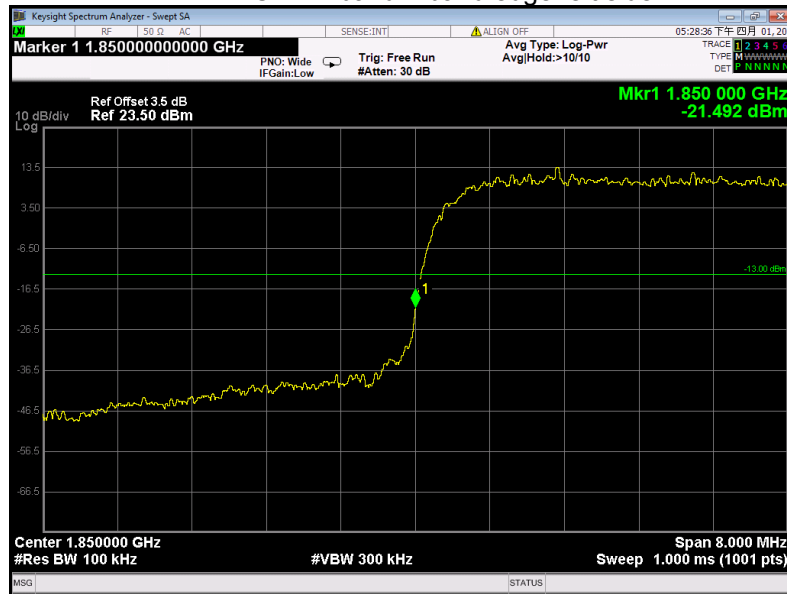

WCDMA band II band edge-right side

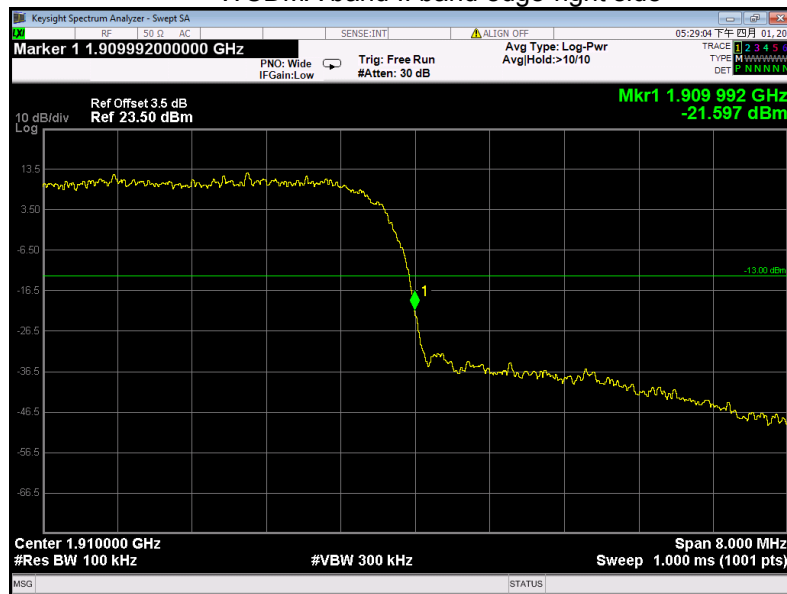

WCDMA band II band edge-left side (HSDPA)

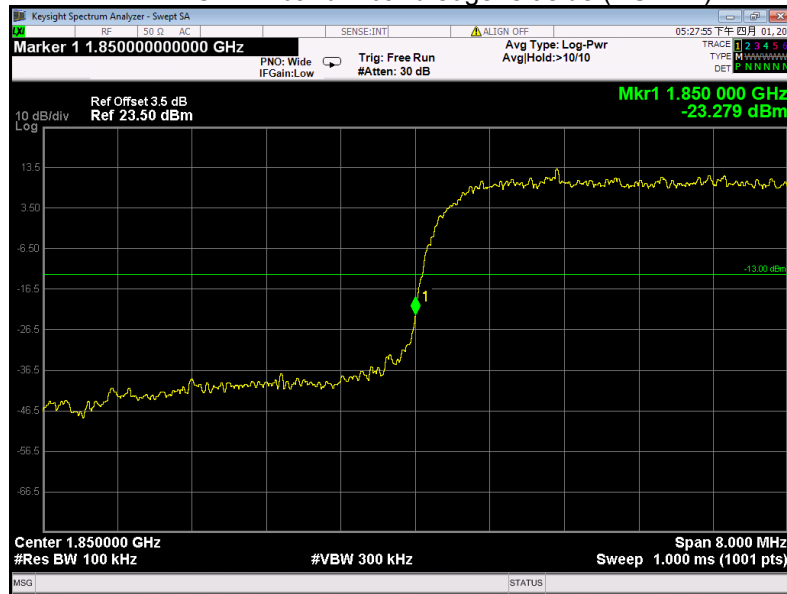

WCDMA band II band edge-right side (HSDPA)

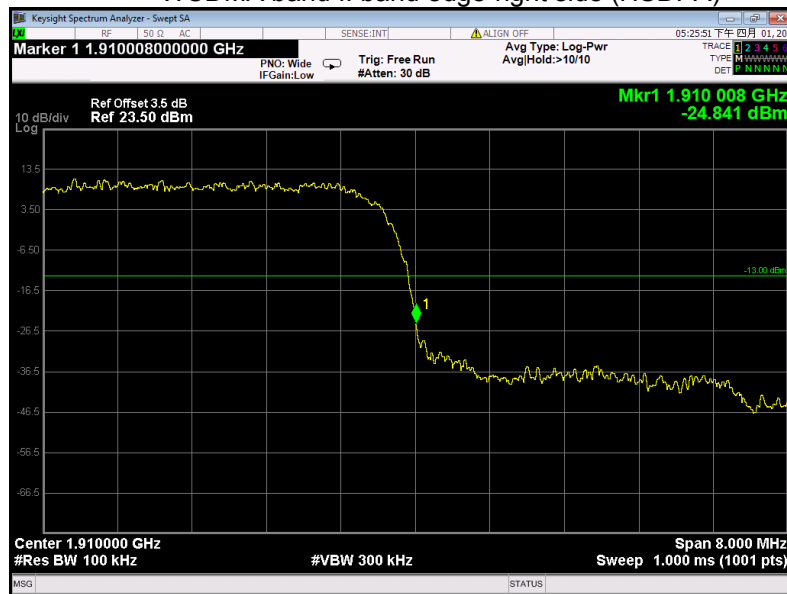

WCDMA band II band edge-left side (HSUPA)

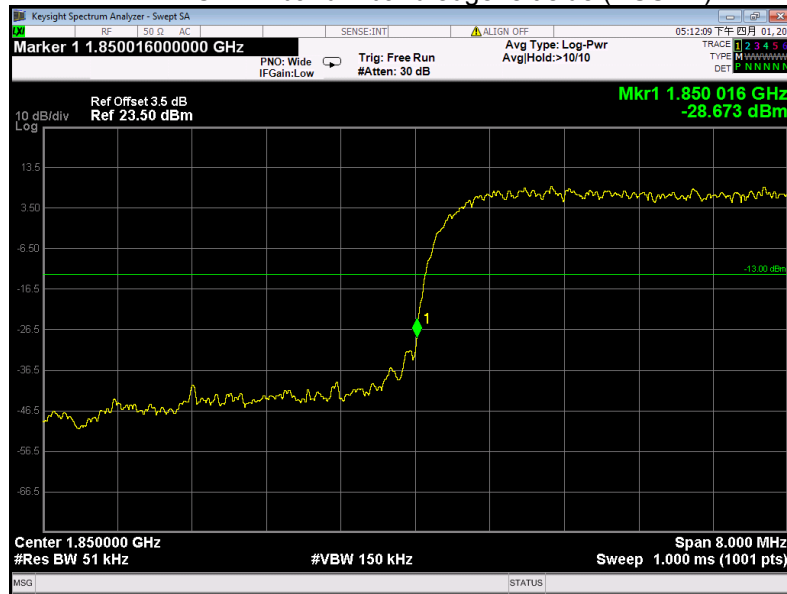

WCDMA band II band edge-right side (HSUPA)

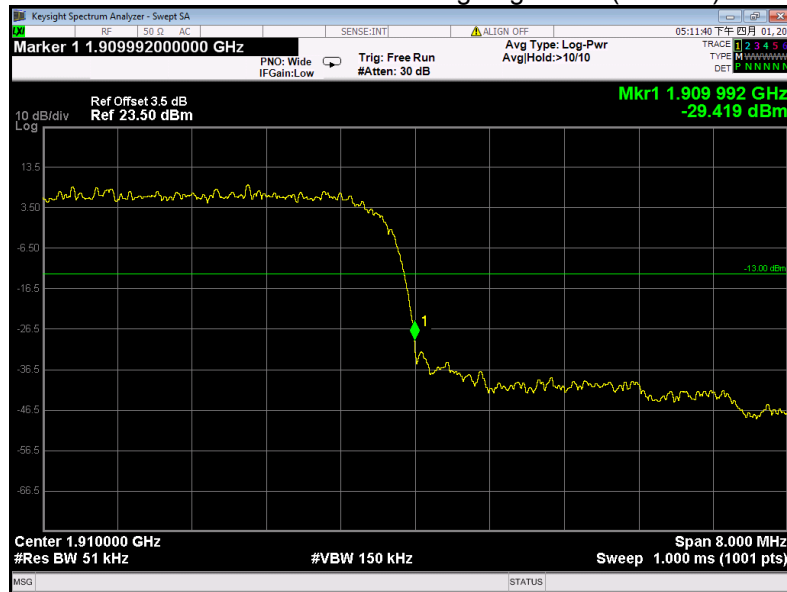

Part 27L

WCDMA band IV band edge-left side

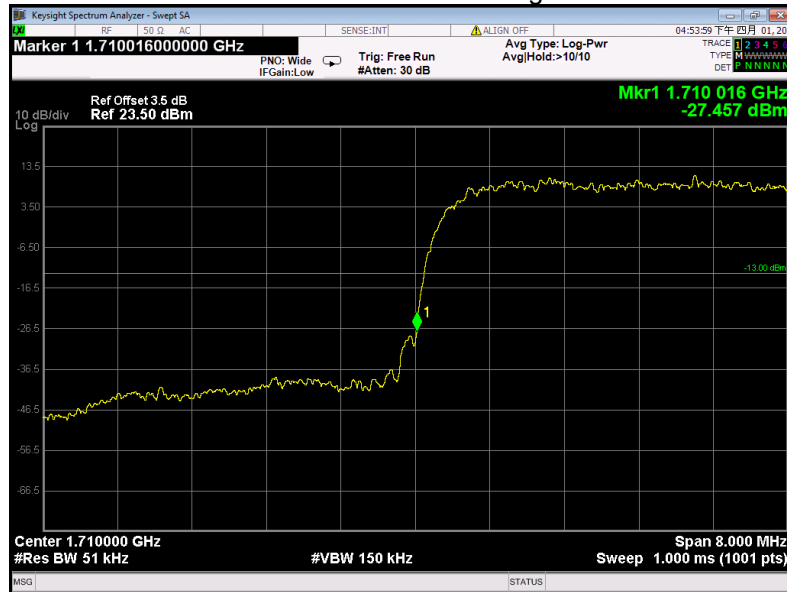

WCDMA band IV band edge-right side



WCDMA band IV band edge-left side (HSDPA)

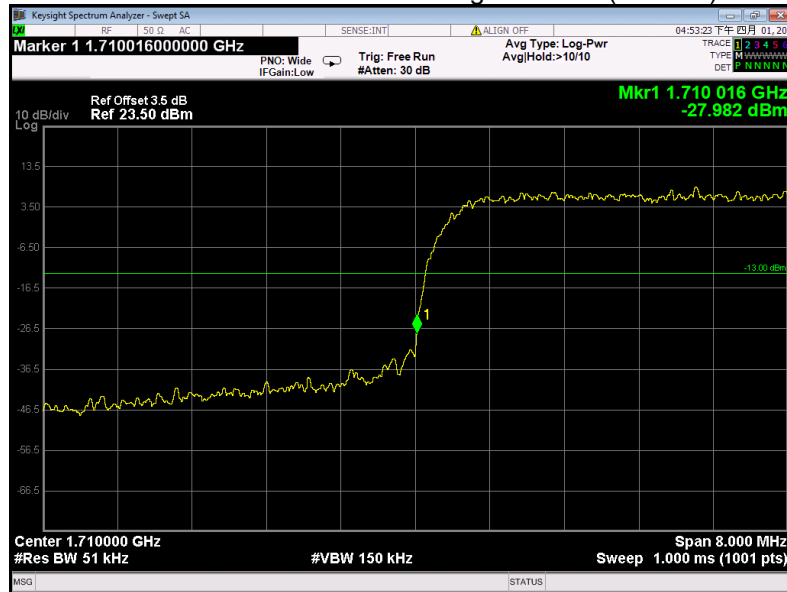

WCDMA band IV band edge-right side (HSDPA)



WCDMA band IV band edge-left side (HSUPA)

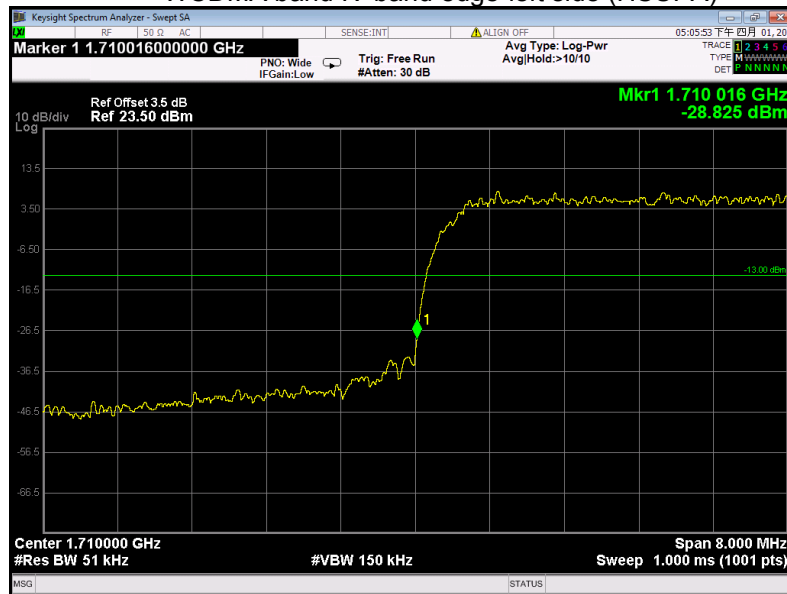

WCDMA band IV band edge-right side (HSUPA)

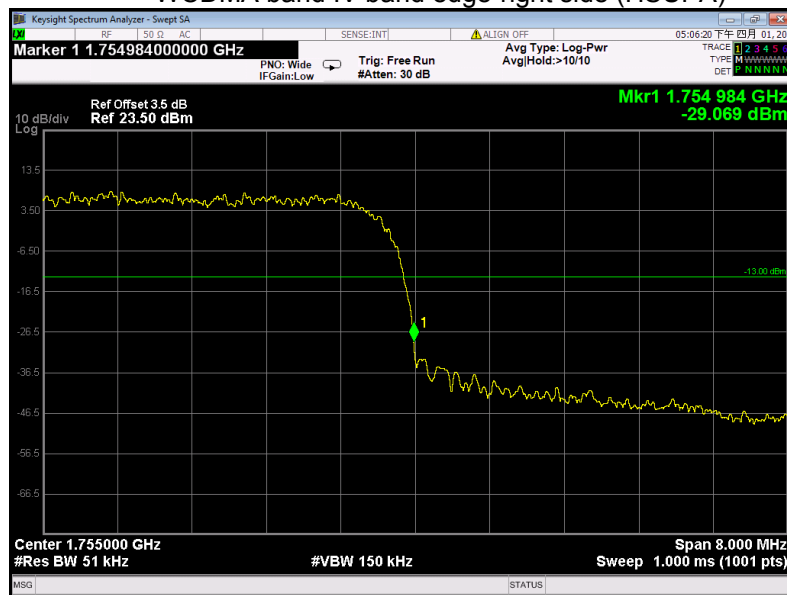

13 Frequency Stability

Test Requirement:	FCC Part 2.1055, 22.355, 24.235, 27.5(h),27.54
Test Method:	ANSI/TIA-603-E:2016 ANSI C63.26:2015
Test Mode:	TX transmitting

13.1 EUT Operation

Operating Environment :	
Temperature:	22.9 °C
Humidity:	52.0 % RH
Atmospheric Pressure:	101.3kPa

13.2 Test Procedure

Frequency Stability vs. Temperature: The equipment under test was connected to an external DC power supply and the RF output was connected to communication test set via feed-through attenuators. The EUT was placed inside the temperature chamber. The DC leads and RF output cable exited the chamber through an opening made for the purpose.

After the temperature stabilized for approximately 20 minutes, the frequency output was recorded from the communication test set.

Frequency Stability vs. Voltage: For hand carried, battery powered equipment; reduce primary supply voltage to the battery operating end point which shall be specified by the manufacturer.

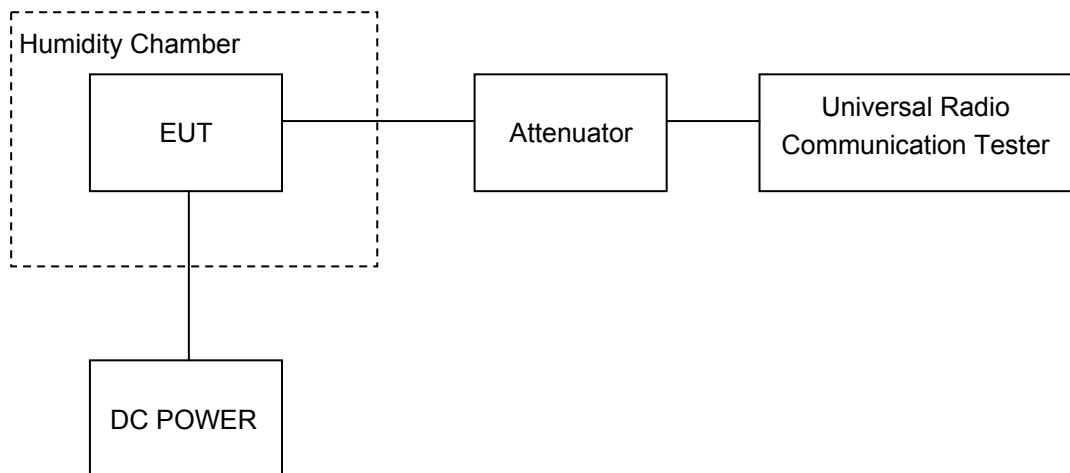

13.3 Test Result

Cellular Band (Part 22H)

GSM 850 Test Frequency:836.6MHz				
Temperature (°C)	Power Supply (VDC)	Frequency Error (Hz)	Frequency Error (ppm)	Limit (ppm)
50	3.85	12	0.0143	2.5
40		9	0.0108	2.5
30		0	0.0000	2.5
20		6	0.0072	2.5
10		6	0.0072	2.5
0		11	0.0131	2.5
-10		11	0.0131	2.5
-20		-2	-0.0024	2.5
-30		3	0.0036	2.5
20		3.47	12	0.0143
20	4.24	12	0.0143	2.5

GPRS 850 Test Frequency:836.6MHz				
Temperature (°C)	Power Supply (VDC)	Frequency Error (Hz)	Frequency Error (ppm)	Limit (ppm)
50	3.85	15	0.0179	2.5
40		3	0.0036	2.5
30		6	0.0072	2.5
20		9	0.0108	2.5
10		7	0.0084	2.5
0		9	0.0108	2.5
-10		2	0.0024	2.5
-20		6	0.0072	2.5
-30		12	0.0143	2.5
20		3.47	13	0.0155
20	4.24	15	0.0179	2.5

EGPRS 850 Test Frequency:836.6MHz				
Temperature (°C)	Power Supply (VDC)	Frequency Error (Hz)	Frequency Error (ppm)	Limit (ppm)
50	3.85	12	0.0143	2.5
40		18	0.0215	2.5
30		10	0.0120	2.5
20		9	0.0108	2.5
10		6	0.0072	2.5
0		17	0.0203	2.5
-10		5	0.0060	2.5
-20		16	0.0191	2.5
-30		4	0.0048	2.5
20		3.47	12	0.0143
20	4.24	9	0.0108	2.5

WCDMA Band V Test Frequency:836.6MHz				
Temperature (°C)	Power Supply (VDC)	Frequency Error (Hz)	Frequency Error (ppm)	Limit (ppm)
50	3.85	-3	-0.0016	2.5
40		12	0.0064	2.5
30		-1	-0.0005	2.5
20		5	0.0027	2.5
10		3	0.0016	2.5
0		-1	-0.0005	2.5
-10		7	0.0037	2.5
-20		3	0.0016	2.5
-30		12	0.0064	2.5
20		3.47	11	0.0059
20	4.24	-3	-0.0016	2.5

WCDMA Band V Test Frequency:836.6MHz(HSDPA)				
Temperature (°C)	Power Supply (VDC)	Frequency Error (Hz)	Frequency Error (ppm)	Limit (ppm)
50	3.85	4	0.0021	2.5
40		10	0.0053	2.5
30		16	0.0085	2.5
20		8	0.0043	2.5
10		3	0.0016	2.5
0		17	0.0090	2.5
-10		13	0.0069	2.5
-20		9	0.0048	2.5
-30		6	0.0032	2.5
20	3.47	10	0.0053	2.5
20	4.24	7	0.0037	2.5

WCDMA Band V Test Frequency:836.6MHz(HSUPA)				
Temperature (°C)	Power Supply (VDC)	Frequency Error (Hz)	Frequency Error (ppm)	Limit (ppm)
50	3.85	7	0.0037	2.5
40		10	0.0053	2.5
30		-1	-0.0005	2.5
20		2	0.0011	2.5
10		4	0.0021	2.5
0		0	0.0000	2.5
-10		6	0.0032	2.5
-20		6	0.0032	2.5
-30		3	0.0016	2.5
20	3.47	0	0.0000	2.5
20	4.24	-2	-0.0011	2.5

PCS Band (Part 24E)

PCS 1900 Test Frequency:1880.0MHz				
Temperature (°C)	Power Supply (VDC)	Frequency Error (Hz)	Frequency Error (ppm)	Limit (ppm)
50	3.85	-3	-0.0016	2.5
40		3	0.0016	2.5
30		-1	-0.0005	2.5
20		4	0.0021	2.5
10		-1	-0.0005	2.5
0		-4	-0.0021	2.5
-10		7	0.0037	2.5
-20		11	0.0059	2.5
-30		9	0.0048	2.5
20		3.47	8	0.0043
20	4.24	13	0.0069	2.5

GPRS 1900 Test Frequency:1880.0MHz				
Temperature (°C)	Power Supply (VDC)	Frequency Error (Hz)	Frequency Error (ppm)	Limit (ppm)
50	3.85	5	0.0029	2.5
40		4	0.0023	2.5
30		2	0.0012	2.5
20		6	0.0035	2.5
10		8	0.0046	2.5
0		2	0.0012	2.5
-10		8	0.0046	2.5
-20		10	0.0058	2.5
-30		13	0.0075	2.5
20		3.47	3	0.0017
20	4.24	11	0.0063	2.5

EGPRS 1900 Test Frequency:1880.0MHz				
Temperature (°C)	Power Supply (VDC)	Frequency Error (Hz)	Frequency Error (ppm)	Limit (ppm)
50	3.85	3	0.0036	2.5
40		7	0.0084	2.5
30		7	0.0084	2.5
20		4	0.0048	2.5
10		-1	-0.0012	2.5
0		12	0.0143	2.5
-10		6	0.0072	2.5
-20		2	0.0024	2.5
-30		10	0.0120	2.5
20		3.47	1	0.0012
20	4.24	8	0.0096	2.5

WCDMA Band II Test Frequency:1880.0MHz				
Temperature (°C)	Power Supply (VDC)	Frequency Error (Hz)	Frequency Error (ppm)	Limit (ppm)
50	3.85	2	0.0011	2.5
40		6	0.0032	2.5
30		3	0.0016	2.5
20		8	0.0043	2.5
10		12	0.0064	2.5
0		4	0.0021	2.5
-10		16	0.0085	2.5
-20		4	0.0021	2.5
-30		12	0.0064	2.5
20		3.47	13	0.0069
20	4.24	1	0.0005	2.5

WCDMA Band II Test Frequency:1880.0MHz(HSDPA)				
Temperature (°C)	Power Supply (VDC)	Frequency Error (Hz)	Frequency Error (ppm)	Limit (ppm)
50	3.85	11	0.0059	2.5
40		1	0.0005	2.5
30		4	0.0021	2.5
20		5	0.0027	2.5
10		1	0.0005	2.5
0		9	0.0048	2.5
-10		13	0.0069	2.5
-20		9	0.0048	2.5
-30		11	0.0059	2.5
20		3.47	14	0.0074
20	4.24	13	0.0069	2.5

WCDMA Band II Test Frequency:1880.0MHz(HSUPA)				
Temperature (°C)	Power Supply (VDC)	Frequency Error (Hz)	Frequency Error (ppm)	Limit (ppm)
50	3.85	15	0.0179	2.5
40		11	0.0131	2.5
30		4	0.0048	2.5
20		9	0.0108	2.5
10		3	0.0036	2.5
0		12	0.0143	2.5
-10		7	0.0084	2.5
-20		15	0.0179	2.5
-30		5	0.0060	2.5
20		3.47	17	0.0203
20	4.24	10	0.0120	2.5

Part 27L

WCDMA Band IV Test Frequency:1732.6MHz				
Temperature (°C)	Power Supply (VDC)	Frequency Error (Hz)	Frequency Error (ppm)	Limit (ppm)
50	3.85	3	0.0036	2.5
40		13	0.0155	2.5
30		1	0.0012	2.5
20		6	0.0072	2.5
10		13	0.0155	2.5
0		12	0.0143	2.5
-10		5	0.0060	2.5
-20		-2	-0.0024	2.5
-30		-1	-0.0012	2.5
20		3.47	11	0.0131
20	4.24	3	0.0036	2.5

WCDMA Band IV Test Frequency:1732.6MHz (HSDPA)				
Temperature (°C)	Power Supply (VDC)	Frequency Error (Hz)	Frequency Error (ppm)	Limit (ppm)
50	3.85	0	0.0000	2.5
40		9	0.0108	2.5
30		0	0.0000	2.5
20		8	0.0096	2.5
10		11	0.0131	2.5
0		4	0.0048	2.5
-10		1	0.0012	2.5
-20		6	0.0072	2.5
-30		14	0.0167	2.5
20		3.47	14	0.0167
20	4.24	3	0.0036	2.5

WCDMA Band IV Test Frequency:1732.6MHz (HSUPA)				
Temperature (°C)	Power Supply (VDC)	Frequency Error (Hz)	Frequency Error (ppm)	Limit (ppm)
50	3.85	10	0.0120	2.5
40		6	0.0072	2.5
30		10	0.0120	2.5
20		4	0.0048	2.5
10		6	0.0072	2.5
0		7	0.0084	2.5
-10		5	0.0060	2.5
-20		6	0.0072	2.5
-30		1	0.0012	2.5
20		3.47	-4	-0.0048
20	4.24	-1	-0.0012	2.5

