

FCC Radio Test Report

FCC ID: 2AEP6XM-JPLB1

Original Grant

Report No. : TB-FCC149802
Applicant : HangZhou XiongMai Technology CO., LTD
Equipment Under Test (EUT)
EUT Name : Smart LED Colorful Bulb
Model No. : XM-JPLB1
Series No. : XM-JPLB, XM-JPLB2, JPLB, JPLB1, JPLB2
Brand Name : XM
Receipt Date : 2016-09-07
Test Date : 2016-09-08 to 2016-09-26
Issue Date : 2016-09-27
Standards : FCC Part 15, Subpart C (15.247:2015)
Test Method : ANSI C63.10: 2013
Conclusions : **PASS**

In the configuration tested, the EUT complied with the standards specified above,
The EUT technically complies with the FCC and IC requirements

Test/Witness Engineer :

IWAN SU

Approved & Authorized :

Ray

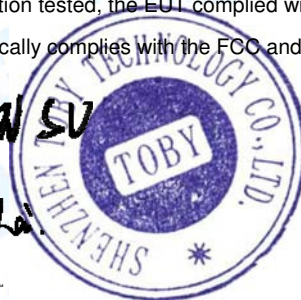

This report details the results of the testing carried out on one sample. The results contained in this test report do not relate to other samples of the same product. The manufacturer should ensure that all products in series production are in conformity with the product sample detailed in the report.

Contents

CONTENTS.....	2
1. GENERAL INFORMATION ABOUT EUT	4
1.1 Client Information.....	4
1.2 General Description of EUT (Equipment Under Test)	4
1.3 Block Diagram Showing the Configuration of System Tested.....	5
1.4 Description of Support Units	5
1.5 Description of Test Mode.....	6
1.6 Description of Test Software Setting	7
1.7 Measurement Uncertainty	7
1.7 Test Facility.....	8
2. TEST SUMMARY	9
3. TEST EQUIPMENT.....	10
4. CONDUCTED EMISSION TEST	11
4.1 Test Standard and Limit.....	11
4.2 Test Setup.....	11
4.3 Test Procedure.....	11
4.4 EUT Operating Mode	12
4.5 Test Data.....	12
5. RADIATED EMISSION TEST	17
5.1 Test Standard and Limit.....	17
5.2 Test Setup.....	18
5.3 Test Procedure.....	19
5.4 EUT Operating Condition	19
5.5 Test Data.....	20
6. RESTRICTED BANDS REQUIREMENT	51
6.1 Test Standard and Limit.....	51
6.2 Test Setup.....	51
6.3 Test Procedure.....	51
6.4 EUT Operating Condition	52
6.5 Test Data.....	52
7. BANDWIDTH TEST.....	73
7.1 Test Standard and Limit.....	73
7.2 Test Setup.....	73
7.3 Test Procedure.....	73
7.4 EUT Operating Condition	73
7.5 Test Data.....	74
8. PEAK OUTPUT POWER TEST.....	82
8.1 Test Standard and Limit.....	82
8.2 Test Setup.....	82

8.3 Test Procedure.....	82
8.4 EUT Operating Condition	82
8.5 Test Data.....	83
9. POWER SPECTRAL DENSITY TEST	86
9.1 Test Standard and Limit.....	86
9.2 Test Setup.....	86
9.3 Test Procedure.....	86
9.4 EUT Operating Condition	86
9.5 Test Data.....	87
10. ANTENNA REQUIREMENT.....	95
10.1 Standard Requirement.....	95
10.2 Antenna Connected Construction.....	95

1. General Information about EUT

1.1 Client Information

Applicant : HangZhou XiongMai Technology CO., LTD
Address : 9th Floor, Building 9, Yinhu Innovation Center, No.9 FuXian Road, YinHu Street, Hangzhou, China
Manufacturer : HangZhou XiongMai Technology CO., LTD
Address : No.2 Dong Qiao Road, Dongzhou Industrial, Fuyang District, Hangzhou , China

1.2 General Description of EUT (Equipment Under Test)

EUT Name	: Smart LED Colorful Bulb
Models No.	: XM-JPLB1, XM-JPLB, XM-JPLB2, JPLB, JPLB1, JPLB2
Model Difference	: All models are identical in the same PCB layout, interior structure and electrical circuits, The only difference is model name for commercial purpose.
Product Description	Operation Frequency: 802.11b/g/n(HT20): 2412MHz~2462MHz 802.11n(HT40): 2422MHz~2452MHz
	Number of Channel: 802.11b/g/n(HT20):11 channels <i>see note(3)</i> 802.11n(HT40): 7 channels <i>see note(3)</i>
	RF Output Power: 802.11b: 8.53 dBm 802.11g: 8.20 dBm 802.11n (HT20): 7.99 dBm 802.11n (HT40): 7.42 dBm
	Antenna Gain: 2 dBi PCB Antenna
	Modulation Type: 802.11b:CCK,DQPSK,DBPSK; 802.11g:64-QAM,QPSK,BPSK 802.11n:64-QAM,16-QAM,QPSK,BPSK
	Bit Rate of Transmitter: 802.11b:11/5.5/2/1 Mbps 802.11g:54/48/36/24/18/12/9/6 Mbps 802.11n:up to 150Mbps
	Power Supply : AC Voltage supplied from power network.
Power Rating	: Input: AC 100~240V,50/60Hz, 3W
Connecting I/O Port(S)	: Please refer to the User's Manual

Note:

(1) This Test Report is FCC Part 15.247 for 802.11b/g/n, the test procedure follows the FCC

KDB 558074 D01 DTS Meas Guidance v03r05.

(2) For a more detailed features description, please refer to the manufacturer's specifications or the User's Manual.

(3) Channel List:

Channel	Frequency (MHz)	Channel	Frequency (MHz)	Channel	Frequency (MHz)
01	2412	05	2432	09	2452
02	2417	06	2437	10	2457
03	2422	07	2442	11	2462
04	2427	08	2447		

Note:CH 01~CH 11 for 802.11b/g/n(HT20)
CH 03~CH 09 for 802.11n(HT40)

(4) The Antenna information about the equipment is provided by the applicant.

1.3 Block Diagram Showing the Configuration of System Tested

TX Mode

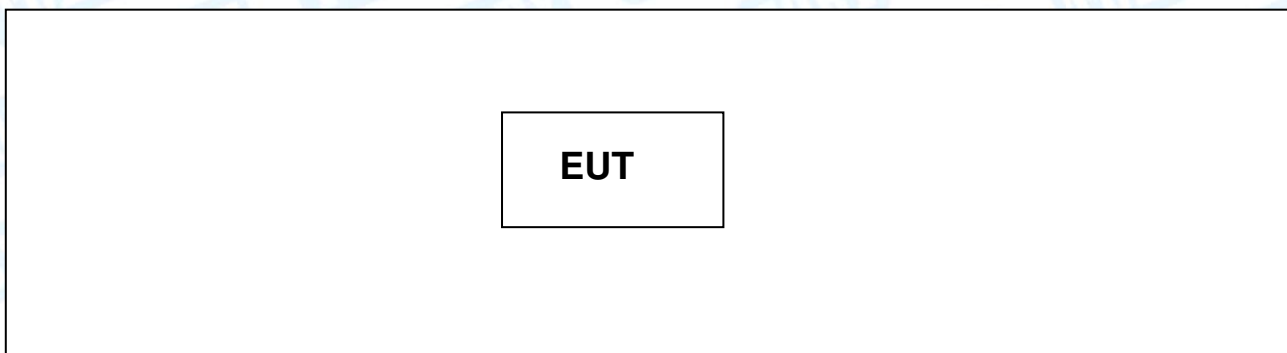

1.4 Description of Support Units

The EUT has been test as an independent unit

1.5 Description of Test Mode

To investigate the maximum EMI emission characteristics generates from EUT, the test system was pre-scanning tested base on the consideration of following EUT operation mode or test configuration mode which possible have effect on EMI emission level. Each of these EUT operation mode(s) or test configuration mode(s) mentioned follow was evaluated respectively.

For Conducted Test	
Final Test Mode	Description
Mode 1	TX B Mode

For Radiated Test	
Final Test Mode	Description
Mode 2	TX Mode B Mode Channel 01/06/11
Mode 3	TX Mode G Mode Channel 01/06/11
Mode 4	TX Mode N(HT20) Mode Channel 01/06/11
Mode 4	TX Mode N(HT40) Mode Channel 03/06/09

Note:

- (1) For all test, we have verified the construction and function in typical operation. And all the test modes were carried out with the EUT in transmitting operation in maximum power with all kinds of data rate.
According to ANSI C63.10 standards, the measurements are performed at the highest, middle, lowest available channels, and the worst case data rate as follows:
 - 802.11b Mode: CCK (1 Mbps)
 - 802.11g Mode: OFDM (6 Mbps)
 - 802.11n (HT20) Mode: MCS 0 (6.5 Mbps)
 - 802.11n (HT40) Mode: MCS 0 (13 Mbps)
- (2) During the testing procedure, the continuously transmitting with the maximum power mode was programmed by the customer.
- (3) The EUT is considered a stationary unit; in normal use it was positioned on X-plane. The worst case was found positioned on X-plane. Therefore only the test data of this X-plane was used for radiated emission measurement test.

1.6 Description of Test Software Setting

During testing channel & Power controlling software provided by the customer was used to control the operating channel as well as the output power level. The RF output power selection is for the setting of RF output power expected by the customer and is going to be fixed on the firmware of the final end product power parameters of WLAN.

Test Software Version	N/A		
Channel	CH 01	CH 06	CH 11
IEEE 802.11b DSSS	DEF	DEF	DEF
IEEE 802.11g OFDM	DEF	DEF	DEF
IEEE 802.11n (HT20)	DEF	DEF	DEF
Channel	CH 03	CH 06	CH 09
IEEE 802.11n (HT40)	DEF	DEF	DEF

1.7 Measurement Uncertainty

The reported uncertainty of measurement $y \pm U$, where expanded uncertainty U is based on a standard uncertainty multiplied by a coverage factor of $k=2$, providing a level of confidence of approximately 95 %.

Test Item	Parameters	Expanded Uncertainty (U_{Lab})
Conducted Emission	Level Accuracy: 9kHz~150kHz 150kHz to 30MHz	± 3.42 dB ± 3.42 dB
Radiated Emission	Level Accuracy: 9kHz to 30 MHz	± 4.60 dB
Radiated Emission	Level Accuracy: 30MHz to 1000 MHz	± 4.40 dB
Radiated Emission	Level Accuracy: Above 1000MHz	± 4.20 dB

1.7 Test Facility

The testing report were performed by the Shenzhen Toby Technology Co., Ltd., in their facilities located at 1A/F., Bldg.6, Yusheng Industrial Zone, The National Road No.107 Xixiang Section 467, Xixiang, Bao'an, Shenzhen, Guangdong, China. At the time of testing, the following bodies accredited the Laboratory:

CNAS (L5813)

The Laboratory has been accredited by CNAS to ISO/IEC 17025: 2005 General Requirements for the Competence of Testing and Calibration Laboratories for the competence in the field of testing. And the Registration No.: CNAS L5813.

FCC List No.: (811562)

The Laboratory is listed in the United States of American Federal Communications Commission (FCC), and the registration number is 811562.

IC Registration No.: (11950A-1)

The Laboratory has been registered by Certification and Engineering Bureau of Industry Canada for radio equipment testing. The site registration: Site# 11950A-1.

2. Test Summary

FCC Part 15 Subpart C(15.247)/ RSS 247 Issue 1				
Standard Section		Test Item	Judgment	Remark
FCC	IC			
15.203	/	Antenna Requirement	PASS	N/A
15.207	RSS-GEN 7.2.4	Conducted Emission	PASS	N/A
15.205	RSS-GEN 7.2.2	Restricted Bands	PASS	N/A
15.247(a)(2)	RSS 247 5.2 (1)	6dB Bandwidth	PASS	N/A
15.247(b)	RSS 247 5.4 (4)	Peak Output Power	PASS	N/A
15.247(e)	RSS 247 5.2 (2)	Power Spectral Density	PASS	N/A
15.247(d)	RSS 247 5.5	Transmitter Radiated Spurious Emission	PASS	N/A

Note: "/" for no requirement for this test item.
N/A is an abbreviation for Not Applicable.

3. Test Equipment

Conducted Emission Test					
Equipment	Manufacturer	Model No.	Serial No.	Last Cal.	Cal. Due Date
EMI Test Receiver	Rohde & Schwarz	ESCI	100321	Jul. 22, 2016	Jul. 21, 2017
RF Switching Unit	Compliance Direction Systems Inc	RSU-A4	34403	Jul. 22, 2016	Jul. 21, 2017
AMN	SCHWARZBECK	NNBL 8226-2	8226-2/164	Jul. 22, 2016	Jul. 21, 2017
LISN	Rohde & Schwarz	ENV216	101131	Jul. 22, 2016	Jul. 21, 2017
Radiation Emission Test					
Equipment	Manufacturer	Model No.	Serial No.	Last Cal.	Cal. Due Date
Spectrum Analyzer	Agilent	E4407B	MY45106456	Jul. 22, 2016	Jul. 21, 2017
EMI Test Receiver	Rohde & Schwarz	ESPI	100010/007	Jul. 22, 2016	Jul. 21, 2017
Bilog Antenna	ETS-LINDGREN	3142E	00117537	Mar. 20, 2016	Mar. 19, 2017
Bilog Antenna	ETS-LINDGREN	3142E	00117542	Mar. 20, 2016	Mar. 19, 2017
Horn Antenna	ETS-LINDGREN	3117	00143207	Mar. 19, 2016	Mar. 18, 2017
Horn Antenna	ETS-LINDGREN	3117	00143209	Mar. 19, 2016	Mar. 18, 2017
Pre-amplifier	Sonoma	310N	185903	Mar. 20, 2016	Mar. 19, 2017
Pre-amplifier	HP	8449B	3008A00849	Mar. 26, 2016	Mar. 25, 2017
Cable	HUBER+SUHNER	100	SUCOFLEX	Mar. 26, 2016	Mar. 25, 2017
Positioning Controller	ETS-LINDGREN	2090	N/A	N/A	N/A
Antenna Conducted Emission					
Equipment	Manufacturer	Model No.	Serial No.	Last Cal.	Cal. Due Date
Spectrum Analyzer	Agilent	E4407B	MY45106456	Jul. 22, 2016	Jul. 21, 2017
EMI Test Receiver	Rohde & Schwarz	ESCI	100010/007	Jul. 22, 2016	Jul. 21, 2017
Power Meter	Anritsu	ML2495A	25406005	Jul. 22, 2016	Jul. 21, 2017
Power Sensor	Anritsu	ML2411B	25406005	Jul. 22, 2016	Jul. 21, 2017

4. Conducted Emission Test

4.1 Test Standard and Limit

4.1.1 Test Standard

FCC Part 15.207

4.1.2 Test Limit

Conducted Emission Test Limit

Frequency	Maximum RF Line Voltage (dB μ V)	
	Quasi-peak Level	Average Level
150kHz~500kHz	66 ~ 56 *	56 ~ 46 *
500kHz~5MHz	56	46
5MHz~30MHz	60	50

Notes:

(1) *Decreasing linearly with logarithm of the frequency.

(2) The lower limit shall apply at the transition frequencies.

(3) The limit decrease in line with the logarithm of the frequency in the range of 0.15 to 0.50MHz.

4.2 Test Setup

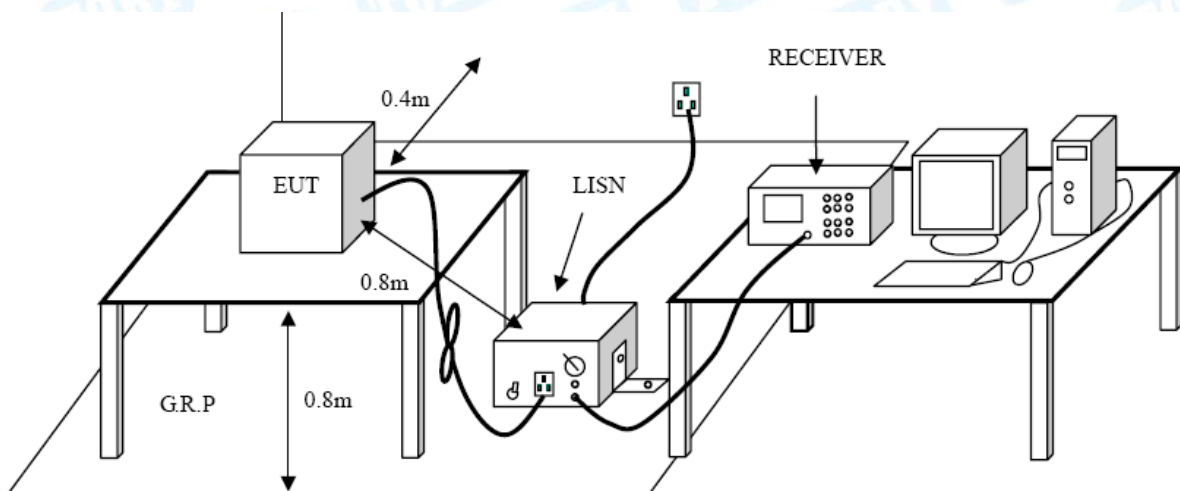

4.3 Test Procedure

The EUT was placed 0.8 meters from the horizontal ground plane with EUT being connected to the power mains through a line impedance stabilization network (LISN). All other support equipments powered from additional LISN(s). The LISN provide 50 Ohm/ 50uH of coupling impedance for the measuring instrument.

Interconnecting cables that hang closer than 40 cm to the ground plane shall be folded back and forth in the center forming a bundle 30 to 40 cm long.

I/O cables that are not connected to a peripheral shall be bundled in the center. The end of the cable may be terminated, if required, using the correct terminating impedance. The overall length shall not exceed 1 m.

LISN at least 80 cm from nearest part of EUT chassis.

The bandwidth of EMI test receiver is set at 9kHz, and the test frequency band is from 0.15MHz to 30MHz.

4.4 EUT Operating Mode

Please refer to the description of test mode.

4.5 Test Data

Please see the next page.

EUT:	Smart LED Colorful Bulb	Model Name :	XM-JPLB1
Temperature:	25 °C	Relative Humidity:	55%
Test Voltage:	AC 120V/60Hz		
Terminal:	Line		
Test Mode:	TX B Mode		
Remark:	Only worse case is reported		

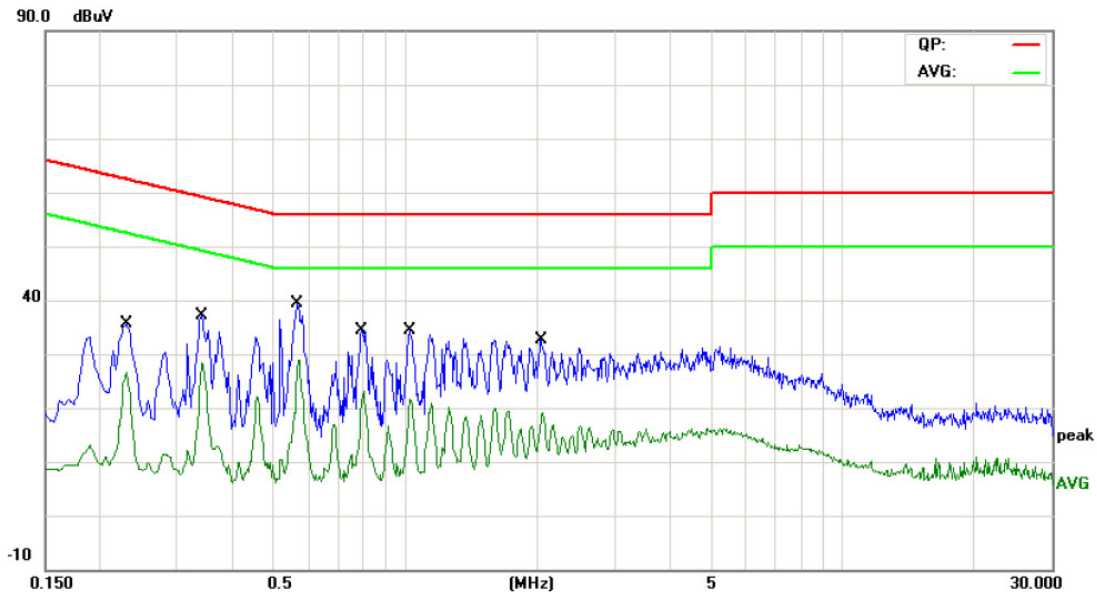

No.	Mk.	Freq. MHz	Reading Level dBuV	Correct Factor dB	Measure- ment dBuV	Limit dBuV	Over dB	Detector
1		0.2300	22.19	10.02	32.21	62.45	-30.24	QP
2		0.2300	15.33	10.02	25.35	52.45	-27.10	AVG
3		0.3420	25.06	10.02	35.08	59.15	-24.07	QP
4		0.3420	17.93	10.02	27.95	49.15	-21.20	AVG
5		0.5660	26.34	10.05	36.39	56.00	-19.61	QP
6	*	0.5660	17.00	10.05	27.05	46.00	-18.95	AVG
7		0.7940	21.05	10.10	31.15	56.00	-24.85	QP
8		0.7940	11.37	10.10	21.47	46.00	-24.53	AVG
9		1.0260	18.34	10.06	28.40	56.00	-27.60	QP
10		1.0260	11.09	10.06	21.15	46.00	-24.85	AVG
11		2.0420	16.27	10.06	26.33	56.00	-29.67	QP
12		2.0420	7.62	10.06	17.68	46.00	-28.32	AVG

*:Maximum data x:Over limit !:over margin

Emission Level= Read Level+ Correct Factor

EUT:	Smart LED Colorful Bulb	Model Name :	XM-JPLB1
Temperature:	25 °C	Relative Humidity:	55%
Test Voltage:	AC 120V/60Hz		
Terminal:	Neutral		
Test Mode:	TX B Mode		
Remark:	Only worse case is reported		

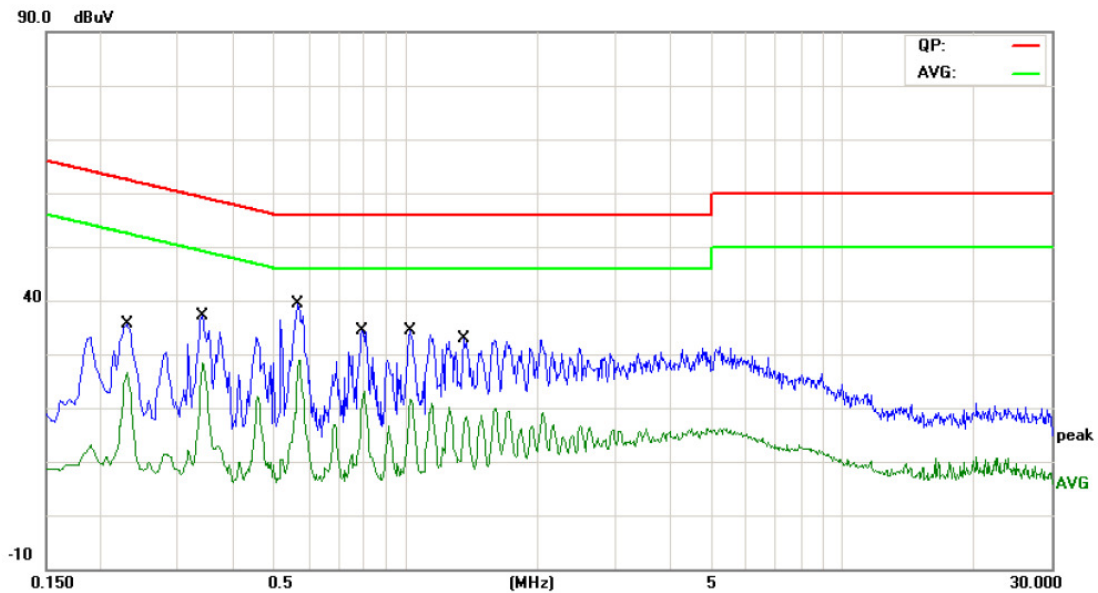

No.	Mk.	Freq. MHz	Reading Level dBuV	Correct Factor dB	Measure- ment dBuV	Limit dBuV	Over dB	Detector
1		0.2300	21.47	10.11	31.58	62.45	-30.87	QP
2		0.2300	15.27	10.11	25.38	52.45	-27.07	AVG
3		0.3420	25.42	10.07	35.49	59.15	-23.66	QP
4		0.3420	18.29	10.07	28.36	49.15	-20.79	AVG
5		0.5660	26.89	10.02	36.91	56.00	-19.09	QP
6	*	0.5660	17.09	10.02	27.11	46.00	-18.89	AVG
7		0.7940	21.59	10.06	31.65	56.00	-24.35	QP
8		0.7940	11.82	10.06	21.88	46.00	-24.12	AVG
9		1.0260	18.74	10.16	28.90	56.00	-27.10	QP
10		1.0260	11.59	10.16	21.75	46.00	-24.25	AVG
11		1.3540	17.00	10.12	27.12	56.00	-28.88	QP
12		1.3540	5.73	10.12	15.85	46.00	-30.15	AVG

*:Maximum data x:Over limit !:over margin

Emission Level= Read Level+ Correct Factor

EUT:	Smart LED Colorful Bulb	Model Name :	XM-JPLB1
Temperature:	25 °C	Relative Humidity:	55%
Test Voltage:	AC 240V/60Hz		
Terminal:	Line		
Test Mode:	TX B Mode		
Remark:	Only worse case is reported		

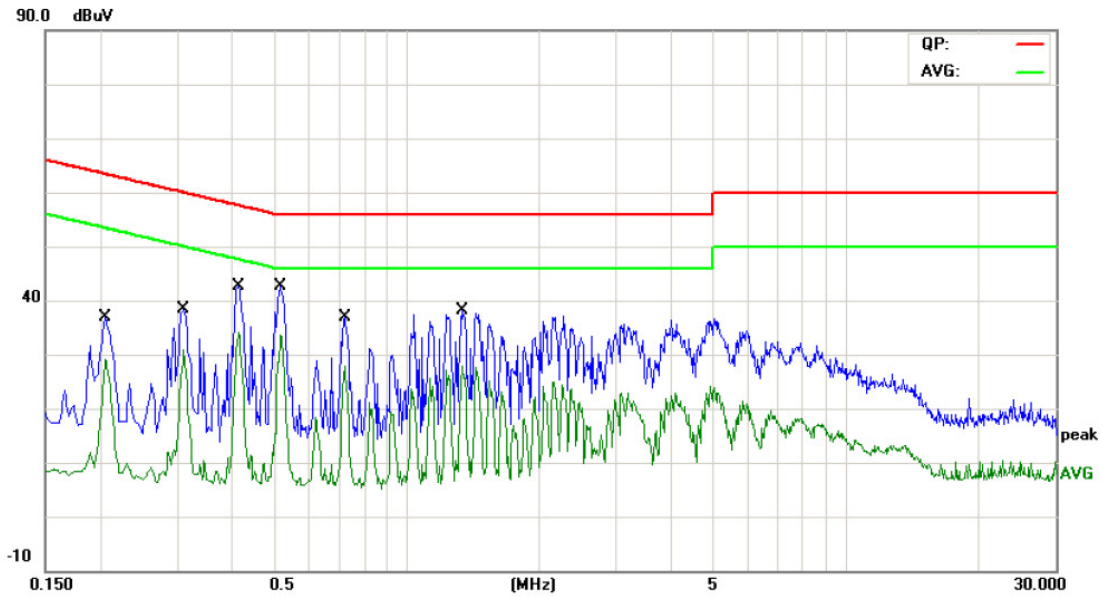

No.	Mk.	Freq. MHz	Reading Level dBuV	Correct Factor dB	Measure- ment dBuV	Limit dBuV	Over dB	Detector
1		0.2060	24.82	10.02	34.84	63.36	-28.52	QP
2		0.2060	18.56	10.02	28.58	53.36	-24.78	AVG
3		0.3100	26.32	10.02	36.34	59.97	-23.63	QP
4		0.3100	20.16	10.02	30.18	49.97	-19.79	AVG
5		0.4140	30.25	10.02	40.27	57.57	-17.30	QP
6		0.4140	24.15	10.02	34.17	47.57	-13.40	AVG
7		0.5140	30.43	10.03	40.46	56.00	-15.54	QP
8	*	0.5140	22.96	10.03	32.99	46.00	-13.01	AVG
9		0.7220	23.80	10.12	33.92	56.00	-22.08	QP
10		0.7220	17.20	10.12	27.32	46.00	-18.68	AVG
11		1.3340	24.08	10.06	34.14	56.00	-21.86	QP
12		1.3340	17.57	10.06	27.63	46.00	-18.37	AVG

*:Maximum data x:Over limit !:over margin

Emission Level= Read Level+ Correct Factor

EUT:	Smart LED Colorful Bulb	Model Name :	XM-JPLB1
Temperature:	25 °C	Relative Humidity:	55%
Test Voltage:	AC 240V/60Hz		
Terminal:	Neutral		
Test Mode:	TX B Mode		
Remark:	Only worse case is reported		

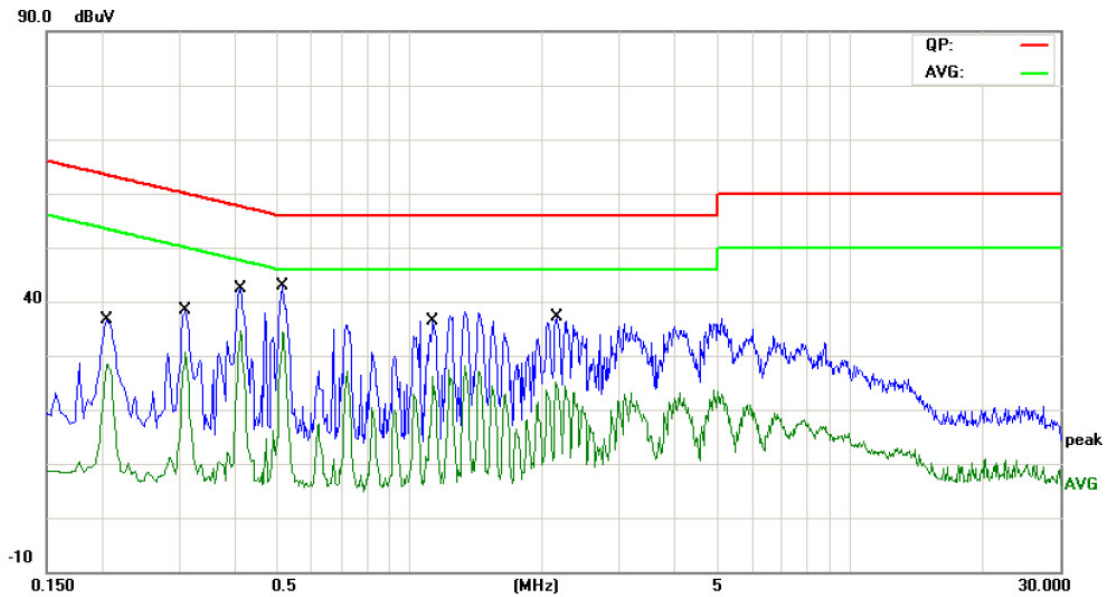

No.	Mk.	Freq. MHz	Reading Level dBuV	Correct Factor dB	Measure- ment dBuV	Limit dBuV	Over dB	Detector
1		0.2060	24.62	10.02	34.64	63.36	-28.72	QP
2		0.2060	18.62	10.02	28.64	53.36	-24.72	AVG
3		0.3100	26.15	10.02	36.17	59.97	-23.80	QP
4		0.3100	20.04	10.02	30.06	49.97	-19.91	AVG
5		0.4140	29.83	10.02	39.85	57.57	-17.72	QP
6		0.4140	23.76	10.02	33.78	47.57	-13.79	AVG
7		0.5140	30.19	10.03	40.22	56.00	-15.78	QP
8	*	0.5140	22.83	10.03	32.86	46.00	-13.14	AVG
9		1.1300	21.33	10.06	31.39	56.00	-24.61	QP
10		1.1300	15.48	10.06	25.54	46.00	-20.46	AVG
11		2.1580	21.40	10.05	31.45	56.00	-24.55	QP
12		2.1580	14.49	10.05	24.54	46.00	-21.46	AVG

*:Maximum data x:Over limit !:over margin

Emission Level= Read Level+ Correct Factor

5. Radiated Emission Test

5.1 Test Standard and Limit

5.1.1 Test Standard

FCC Part 15.209

5.1.2 Test Limit

Radiated Emission Limits (9kHz~1000MHz)

Frequency (MHz)	Field Strength (microvolt/meter)	Measurement Distance (meters)
0.009~0.490	2400/F(KHz)	300
0.490~1.705	24000/F(KHz)	30
1.705~30.0	30	30
30~88	100	3
88~216	150	3
216~960	200	3
Above 960	500	3

Radiated Emission Limit (Above 1000MHz)

Frequency (MHz)	Class A (dBuV/m)(at 3 M)		Class B (dBuV/m)(at 3 M)	
	Peak	Average	Peak	Average
Above 1000	80	60	74	54

Note:

- (1) The tighter limit applies at the band edges.
- (2) Emission Level(dBuV/m)=20log Emission Level(uV/m)

5.2 Test Setup

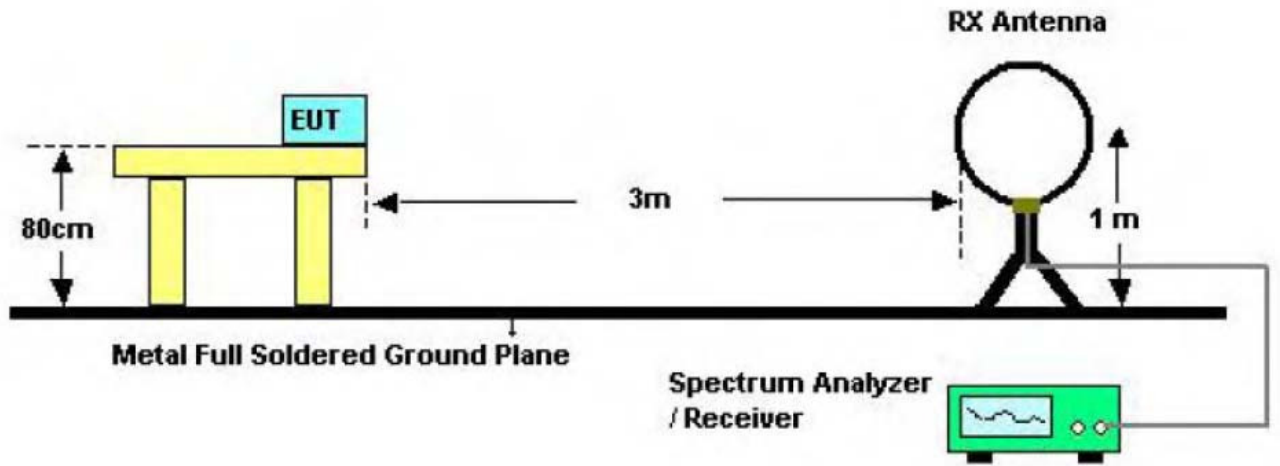

Below 30MHz Test Setup

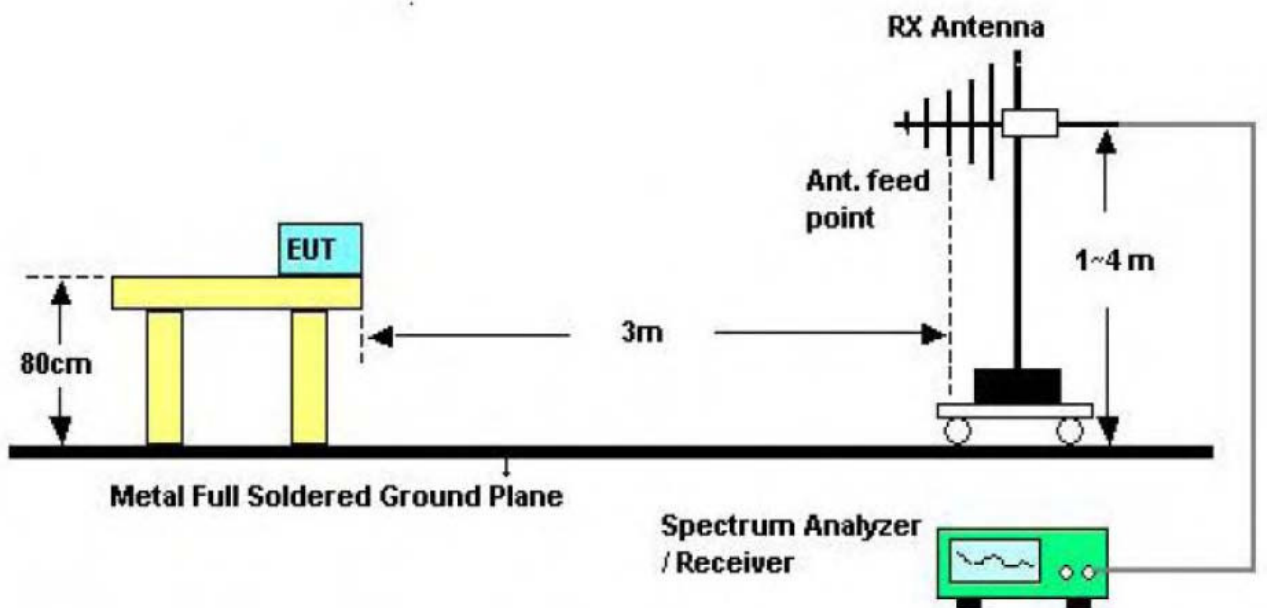

Below 1000MHz Test Setup

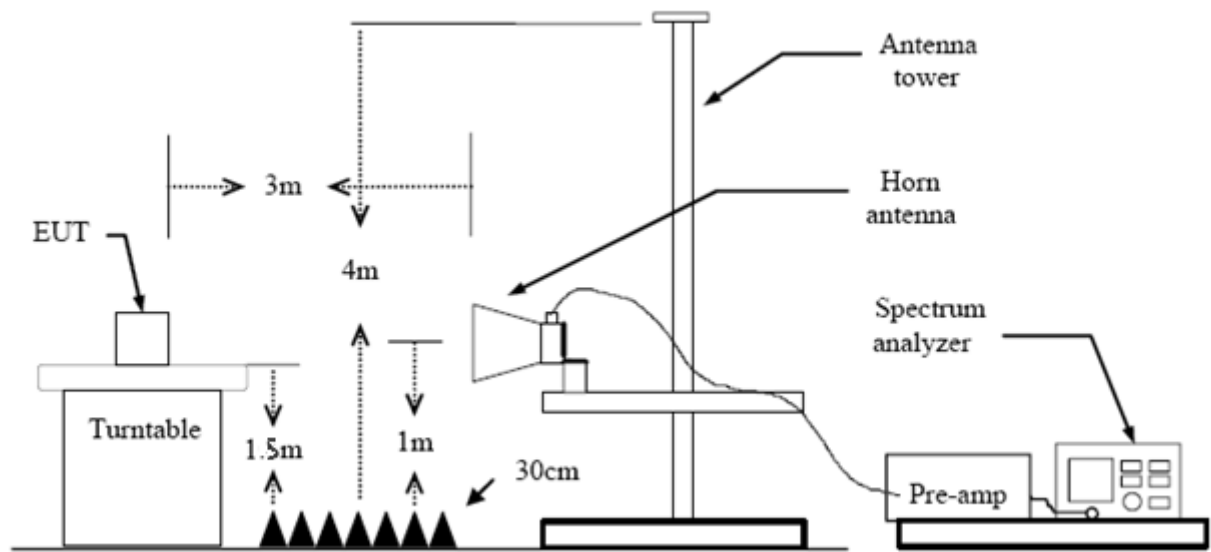

Above 1GHz Test Setup

5.3 Test Procedure

- (1) Measurements at frequency above 1GHz. The EUT was placed on a rotating 1.5m high above the ground. RF absorbers covered the ground plane with a minimum area of 3.0m by 3.0m between the EUT and measurement receiver antenna. The RF absorber shall not exceed 30cm in high above the conducting floor. The table was rotated 360 degrees to determine the position of the highest radiation.
- (2) The Test antenna shall vary between 1m and 4m, Both Horizontal and Vertical antenna are set to make measurement.
- (3) The initial step in collecting conducted emission data is a spectrum analyzer peak detector mode pre-scanning the measurement frequency range. Significant peaks are then marked and then Quasi Peak detector mode re-measured.
- (4) If the Peak Mode measured value compliance with and lower than Quasi Peak Mode Limit Bellow 1 GHz, the EUT shall be deemed to meet QP Limits and then no additional QP Mode measurement performed. But the Peak Value and average value both need to comply with applicable limit above 1 GHz.
- (5) Testing frequency range below 1GHz the measuring instrument use VBW=120 kHz with Quasi-peak detection.
- (6) Testing frequency range above 1GHz the measuring instrument use RBW=1 MHz and VBW=3 MHz with Peak Detector for Peak Values, and use RBW=1 MHz and VBW=10 Hz with Peak Detector for Average Values.
- (7) For the actual test configuration, please see the test setup photo.

5.4 EUT Operating Condition

The Equipment Under Test was set to Continual Transmitting in maximum power.

5.5 Test Data

Remark: During testing above 1GHz the measuring instrument use RBW=1 MHz and VBW=3 MHz with Peak Detector for Peak Values, and use RBW=1 MHz and VBW=10 Hz with Peak Detector for Average Values.

Test data please refer the following pages.

EUT:	Smart LED Colorful Bulb	Model:	XM-JPLB1
Temperature:	25 °C	Relative Humidity:	55%
Test Voltage:	AC 120V/60Hz		
Ant. Pol.	Horizontal		
Test Mode:	TX B Mode 2412MHz		
Remark:	Only worse case is reported		

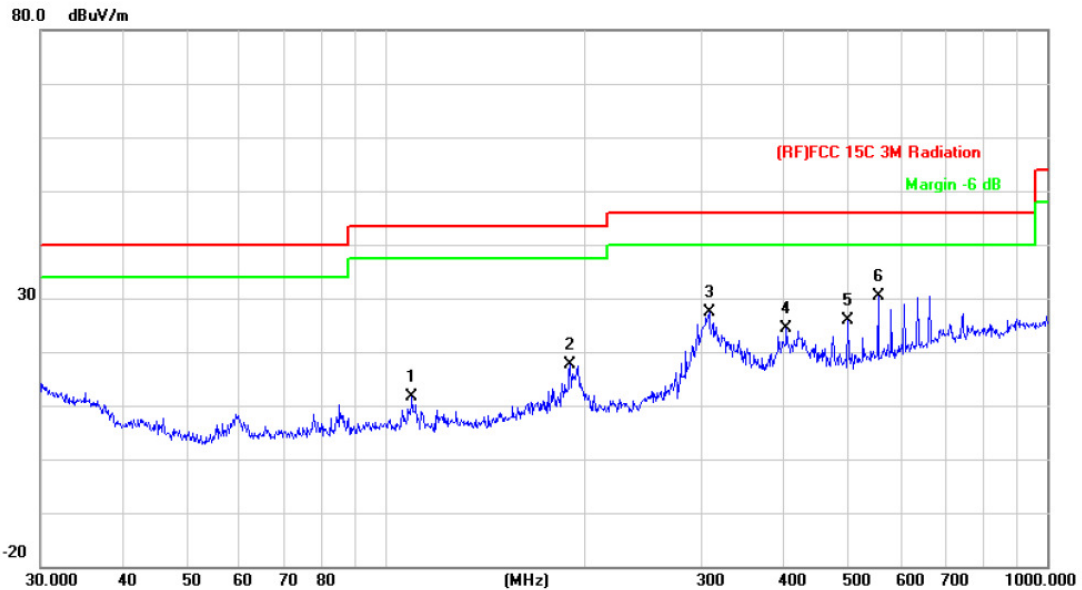

No.	Mk.	Freq.	Reading Level	Correct Factor	Measurement	Limit	Over	Detector
		MHz	dBuV	dB/m	dBuV/m	dBuV/m	dB	
1		109.4116	33.55	-21.86	11.69	43.50	-31.81	peak
2		189.7384	38.08	-20.54	17.54	43.50	-25.96	peak
3		307.8312	43.63	-16.35	27.28	46.00	-18.72	peak
4		403.2500	36.70	-12.35	24.35	46.00	-21.65	peak
5		499.4246	37.04	-11.20	25.84	46.00	-20.16	peak
6	*	554.8253	39.80	-9.50	30.30	46.00	-15.70	peak

*:Maximum data x:Over limit !:over margin

Emission Level= Read Level+ Correct Factor

EUT:	Smart LED Colorful Bulb	Model:	XM-JPLB1
Temperature:	25 °C	Relative Humidity:	55%
Test Voltage:	AC 120V/60Hz		
Ant. Pol.	Vertical		
Test Mode:	TX B Mode 2412MHz		
Remark:	Only worse case is reported		

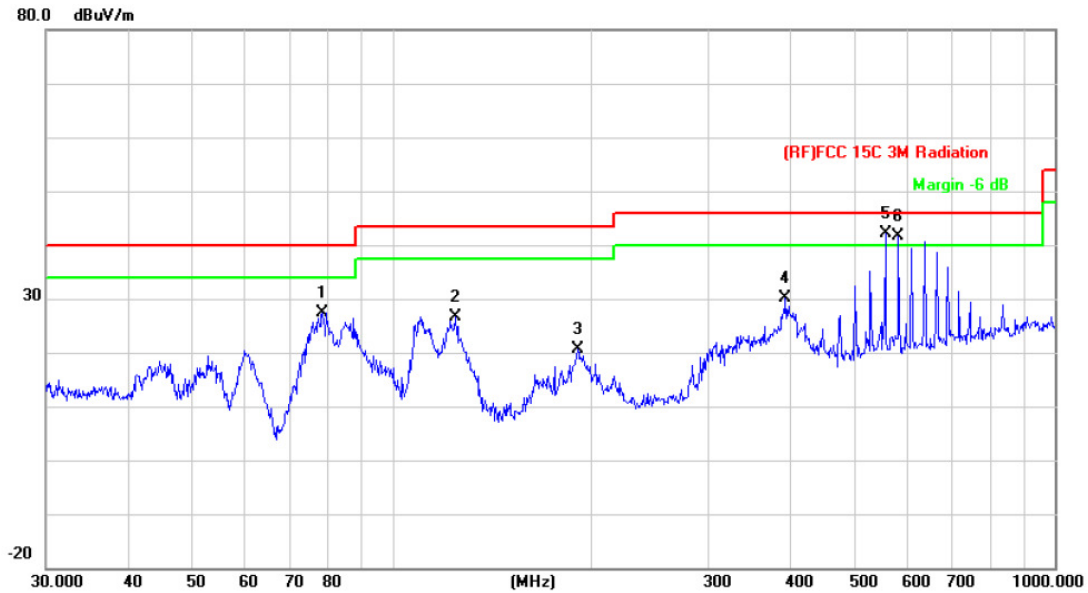

No.	Mk.	Freq. MHz	Reading Level dBuV	Correct Factor dB/m	Measure- ment dBuV/m	Limit dBuV/m	Over dB	Detector
1		78.4133	50.67	-23.40	27.27	40.00	-12.73	peak
2		124.5690	48.88	-22.27	26.61	43.50	-16.89	peak
3		190.4050	41.10	-20.53	20.57	43.50	-22.93	peak
4		392.0951	43.04	-12.87	30.17	46.00	-15.83	peak
5	*	554.8254	51.66	-9.50	42.16	46.00	-3.84	peak
6	!	580.7026	50.99	-9.29	41.70	46.00	-4.30	peak

*:Maximum data x:Over limit !:over margin

Emission Level= Read Level+ Correct Factor

EUT:	Smart LED Colorful Bulb	Model:	XM-JPLB1
Temperature:	25 °C	Relative Humidity:	55%
Test Voltage:	AC 120V/60Hz		
Ant. Pol.	Horizontal		
Test Mode:	TX B Mode 2437MHz		
Remark:	Only worse case is reported		

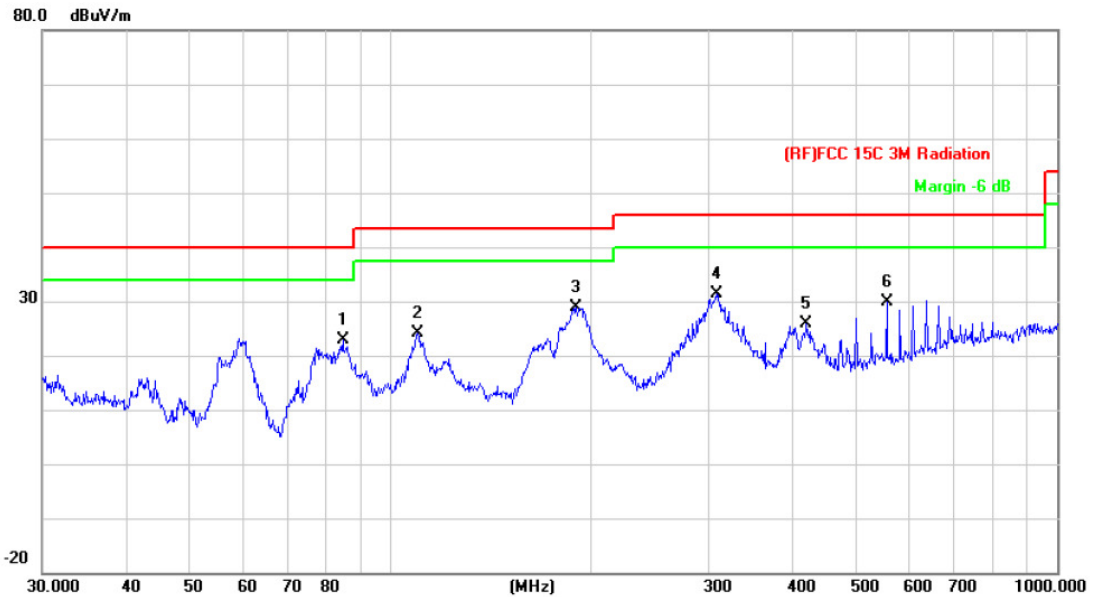

No.	Mk.	Freq. MHz	Reading Level dBuV	Correct Factor dB/m	Measure- ment dBuV/m	Limit dBuV/m	Over dB	Detector
1		84.7018	46.01	-23.06	22.95	40.00	-17.05	peak
2		109.7960	45.99	-21.86	24.13	43.50	-19.37	peak
3		189.7384	49.32	-20.54	28.78	43.50	-14.72	peak
4	*	307.8312	47.82	-16.35	31.47	46.00	-14.53	peak
5		420.5803	38.22	-12.44	25.78	46.00	-20.22	peak
6		554.8253	39.26	-9.50	29.76	46.00	-16.24	peak

*:Maximum data x:Over limit !:over margin

Emission Level= Read Level+ Correct Factor

EUT:	Smart LED Colorful Bulb	Model:	XM-JPLB1
Temperature:	25 °C	Relative Humidity:	55%
Test Voltage:	AC 120V/60Hz		
Ant. Pol.	Vertical		
Test Mode:	TX B Mode 2437MHz		
Remark:	Only worse case is reported		

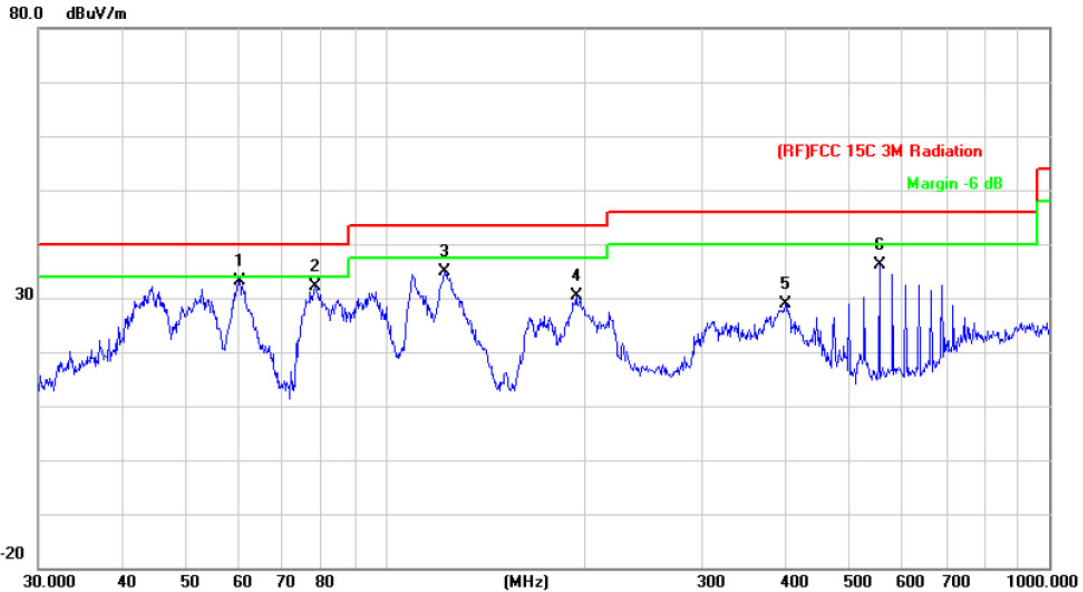

No.	Mk.	Freq. MHz	Reading Level dBuV	Correct Factor dB/m	Measure- ment dBuV/m	Limit dBuV/m	Over dB	Detector
1	*	60.2800	57.73	-24.59	33.14	40.00	-6.86	peak
2		78.4133	55.46	-23.40	32.06	40.00	-7.94	peak
3		122.8340	57.24	-22.34	34.90	43.50	-8.60	peak
4		193.7726	50.65	-20.35	30.30	43.50	-13.20	peak
5		400.4318	41.12	-12.33	28.79	46.00	-17.21	peak
6		554.8251	45.63	-9.50	36.13	46.00	-9.87	peak

*:Maximum data x:Over limit !:over margin

Emission Level= Read Level+ Correct Factor

EUT:	Smart LED Colorful Bulb	Model:	XM-JPLB1
Temperature:	25 °C	Relative Humidity:	55%
Test Voltage:	AC 120V/60Hz		
Ant. Pol.	Horizontal		
Test Mode:	TX B Mode 2462MHz		
Remark:	Only worse case is reported		

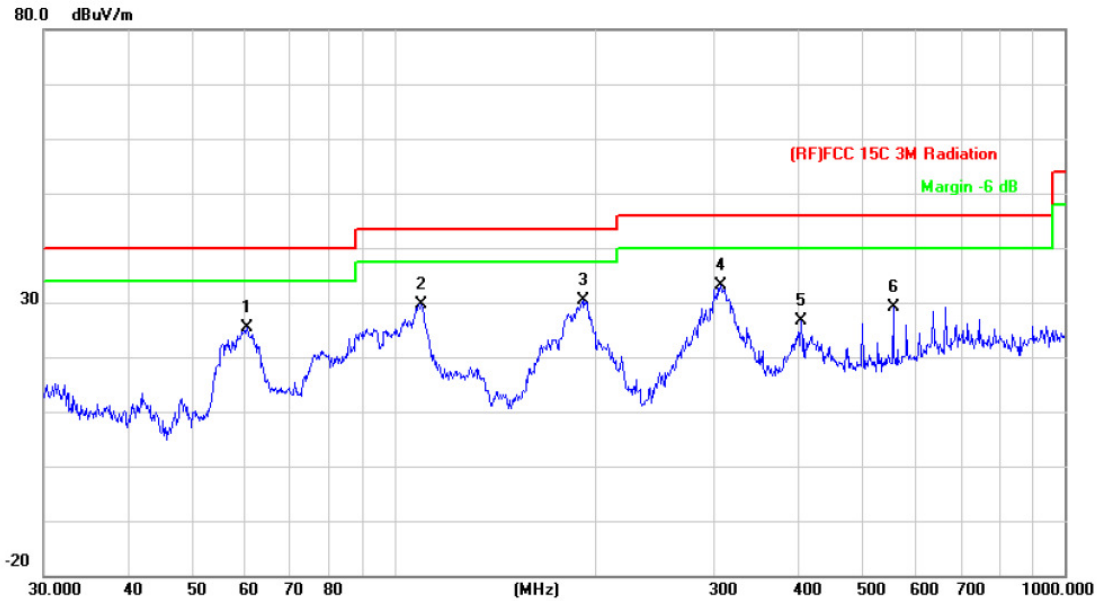

No.	Mk.	Freq. MHz	Reading Level dBuV	Correct Factor dB/m	Measure- ment dBuV/m	Limit dBuV/m	Over dB	Detector
1		60.2800	49.89	-24.59	25.30	40.00	-14.70	peak
2		109.7960	51.54	-21.86	29.68	43.50	-13.82	peak
3		191.0738	50.94	-20.50	30.44	43.50	-13.06	peak
4	*	306.7536	49.44	-16.39	33.05	46.00	-12.95	peak
5		404.6664	38.97	-12.36	26.61	46.00	-19.39	peak
6		554.8251	38.71	-9.50	29.21	46.00	-16.79	peak

*:Maximum data x:Over limit !:over margin

Emission Level= Read Level+ Correct Factor

EUT:	Smart LED Colorful Bulb	Model:	XM-JPLB1
Temperature:	25 °C	Relative Humidity:	55%
Test Voltage:	AC 120V/60Hz		
Ant. Pol.	Vertical		
Test Mode:	TX B Mode 2462MHz		
Remark:	Only worse case is reported		

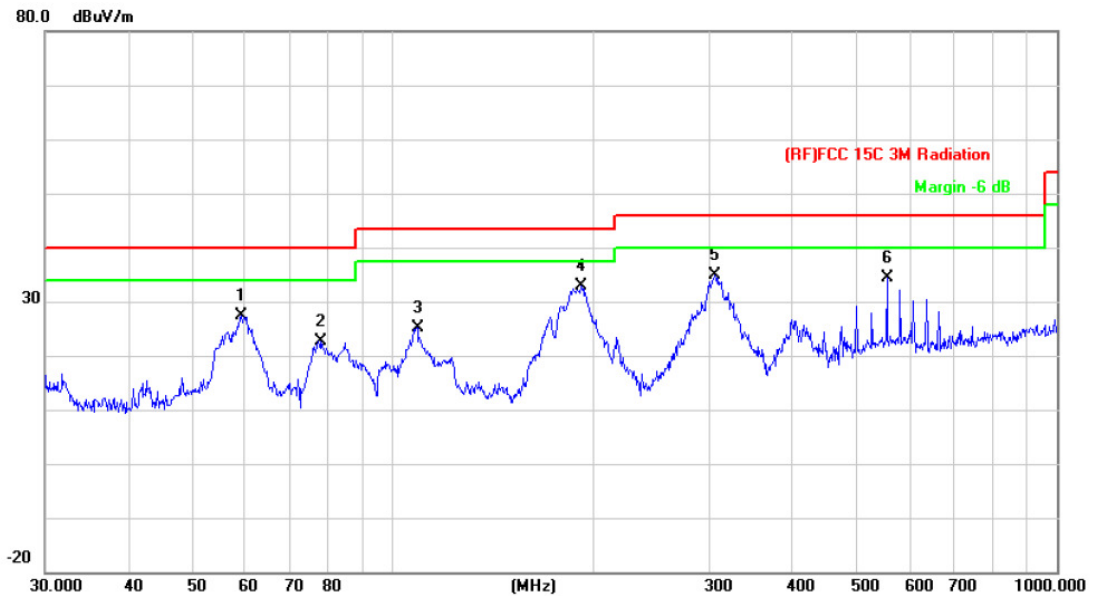

No.	Mk.	Freq. MHz	Reading Level dBuV	Correct Factor dB/m	Measure- ment dBuV/m	Limit dBuV/m	Over dB	Detector
1		59.2325	51.95	-24.60	27.35	40.00	-12.65	peak
2		78.1389	45.97	-23.40	22.57	40.00	-17.43	peak
3		109.0284	46.99	-21.85	25.14	43.50	-18.36	peak
4	*	192.4183	53.23	-20.41	32.82	43.50	-10.68	peak
5		305.6800	51.22	-16.43	34.79	46.00	-11.21	peak
6		554.8251	43.89	-9.50	34.39	46.00	-11.61	peak

*:Maximum data x:Over limit !:over margin

Emission Level= Read Level+ Correct Factor

EUT:	Smart LED Colorful Bulb	Model:	XM-JPLB1
Temperature:	25 °C	Relative Humidity:	55%
Test Voltage:	AC 120V/60Hz		
Ant. Pol.	Horizontal		
Test Mode:	TX B Mode 2412MHz		
Remark:	No report for the emission which more than 10 dB below the prescribed limit.		

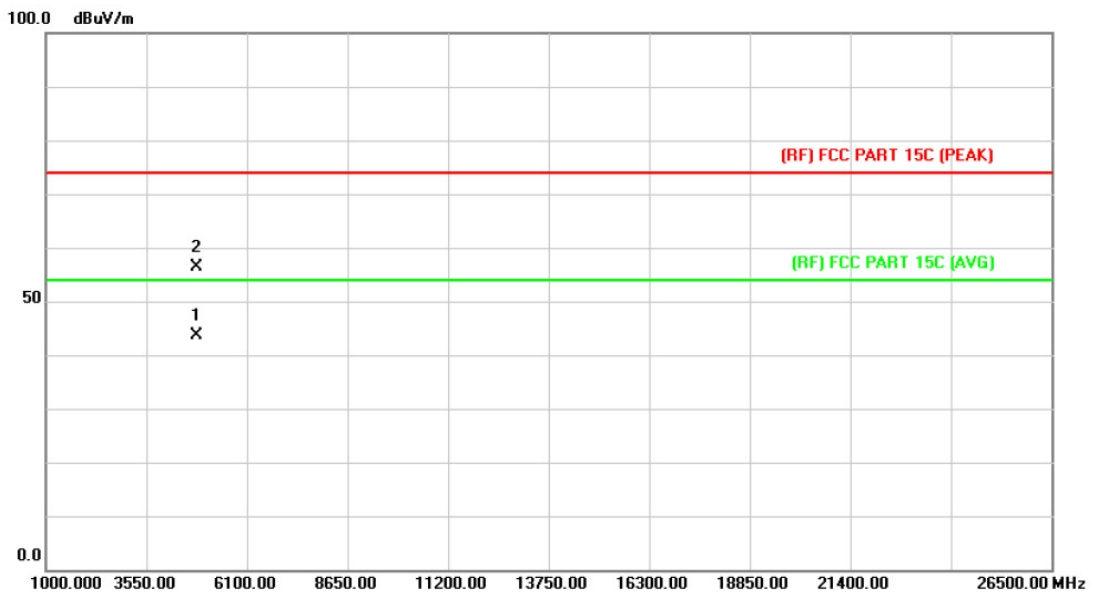

No.	Mk.	Freq.	Reading Level	Correct Factor	Measurement	Limit	Over	Detector
		MHz	dBuV	dB/m	dBuV/m	dBuV/m	dB	
1	*	4823.654	30.09	13.56	43.65	54.00	-10.35	AVG
2		4824.021	42.86	13.56	56.42	74.00	-17.58	peak

Emission Level= Read Level+ Correct Factor

EUT:	Smart LED Colorful Bulb	Model:	XM-JPLB1
Temperature:	25 °C	Relative Humidity:	55%
Test Voltage:	AC 120V/60Hz		
Ant. Pol.	Vertical		
Test Mode:	TX B Mode 2412MHz		
Remark:	No report for the emission which more than 10 dB below the prescribed limit.		

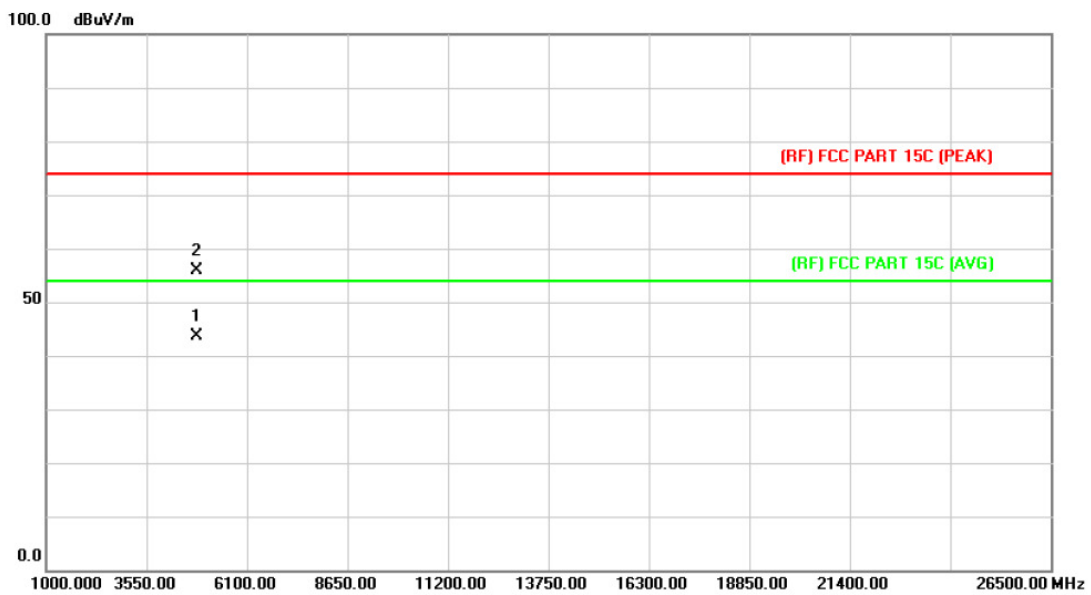

No.	Mk.	Freq. MHz	Reading Level dBuV	Correct Factor dB/m	Measure- ment dBuV/m	Limit dBuV/m	Over dB	Detector
1	*	4823.897	30.19	13.56	43.75	54.00	-10.25	AVG
2		4824.652	42.33	13.56	55.89	74.00	-18.11	peak

Emission Level= Read Level+ Correct Factor

EUT:	Smart LED Colorful Bulb	Model:	XM-JPLB1
Temperature:	25 °C	Relative Humidity:	55%
Test Voltage:	AC 120V/60Hz		
Ant. Pol.	Horizontal		
Test Mode:	TX B Mode 2437MHz		
Remark:	No report for the emission which more than 10 dB below the prescribed limit.		

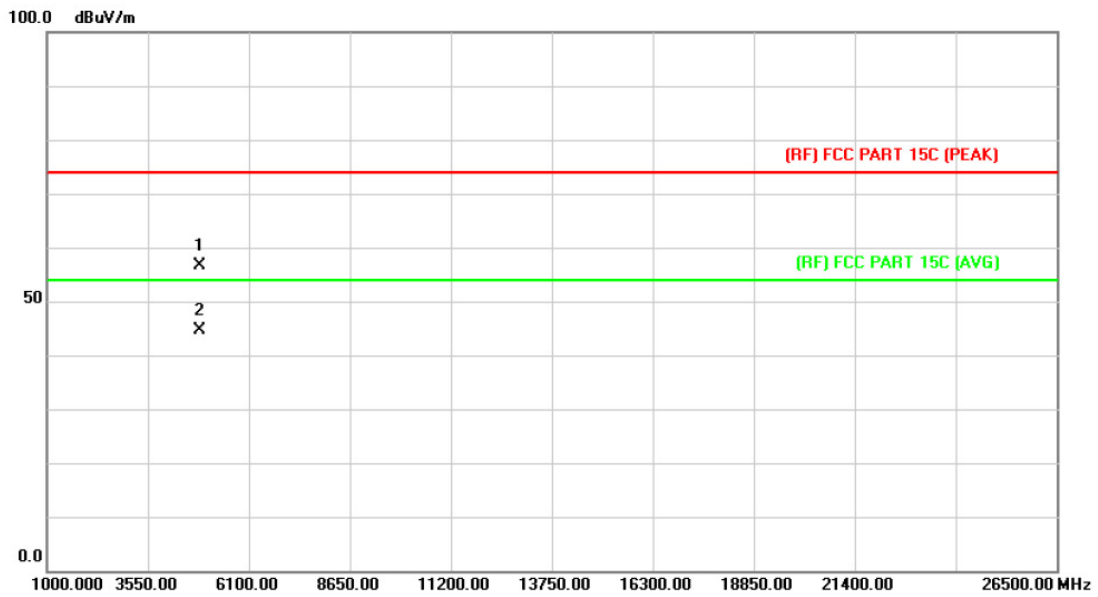

No.	Mk.	Freq. MHz	Reading Level dBuV	Correct Factor dB/m	Measure- ment dBuV/m	Limit dBuV/m	Over dB	Detector
1		4873.899	42.73	13.86	56.59	74.00	-17.41	peak
2	*	4874.065	30.76	13.86	44.62	54.00	-9.38	AVG

Emission Level= Read Level+ Correct Factor

EUT:	Smart LED Colorful Bulb	Model:	XM-JPLB1
Temperature:	25 °C	Relative Humidity:	55%
Test Voltage:	AC 120V/60Hz		
Ant. Pol.	Vertical		
Test Mode:	TX B Mode 2437MHz		
Remark:	No report for the emission which more than 10 dB below the prescribed limit.		

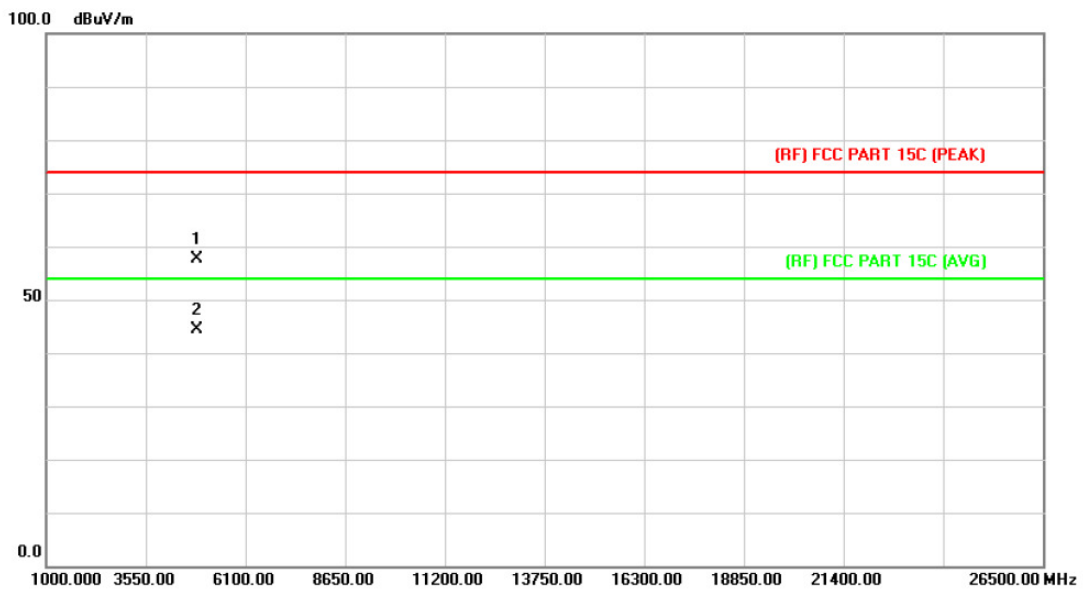

No.	Mk.	Freq. MHz	Reading Level dBuV	Correct Factor dB/m	Measure- ment dBuV/m	Limit dBuV/m	Over dB	Detector
1		4873.584	43.83	13.86	57.69	74.00	-16.31	peak
2	*	4874.254	30.46	13.86	44.32	54.00	-9.68	AVG

Emission Level= Read Level+ Correct Factor

EUT:	Smart LED Colorful Bulb	Model:	XM-JPLB1
Temperature:	25 °C	Relative Humidity:	55%
Test Voltage:	AC 120V/60Hz		
Ant. Pol.	Horizontal		
Test Mode:	TX B Mode 2462MHz		
Remark:	No report for the emission which more than 10 dB below the prescribed limit.		

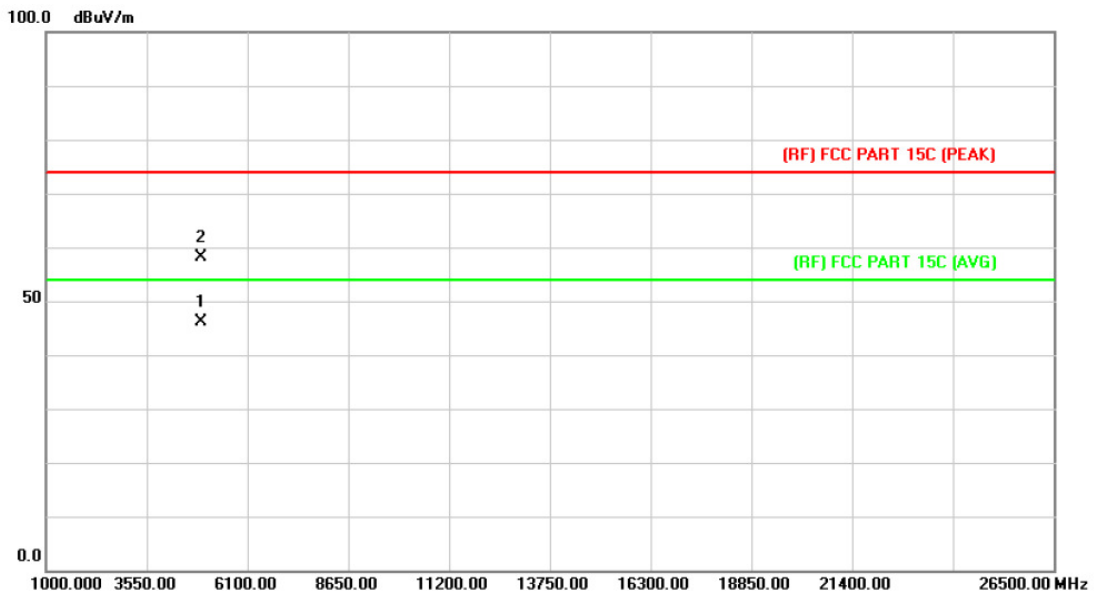

No.	Mk.	Freq. MHz	Reading Level dBuV	Correct Factor dB/m	Measure- ment dBuV/m	Limit dBuV/m	Over dB	Detector
1	*	4923.514	31.97	14.15	46.12	54.00	-7.88	AVG
2		4924.021	44.08	14.15	58.23	74.00	-15.77	peak

Emission Level= Read Level+ Correct Factor

EUT:	Smart LED Colorful Bulb	Model:	XM-JPLB1
Temperature:	25 °C	Relative Humidity:	55%
Test Voltage:	AC 120V/60Hz		
Ant. Pol.	Vertical		
Test Mode:	TX B Mode 2462MHz		
Remark:	No report for the emission which more than 10 dB below the prescribed limit.		

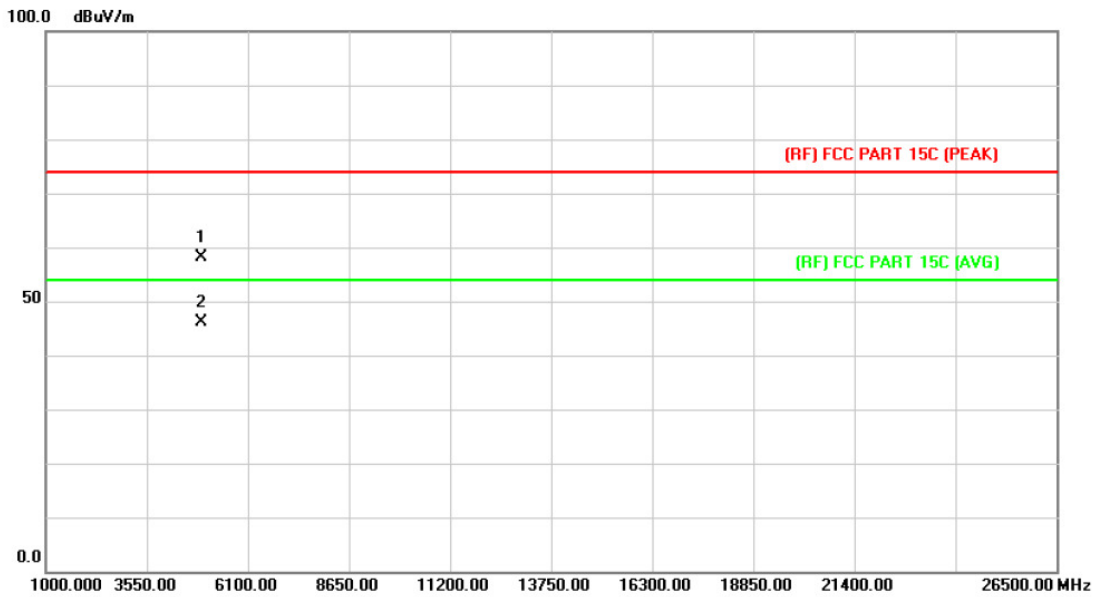

No.	Mk.	Freq.	Reading Level	Correct Factor	Measurement	Limit	Over	Detector
		MHz	dBuV	dB/m	dBuV/m	dBuV/m	dB	
1		4923.987	43.97	14.15	58.12	74.00	-15.88	peak
2	*	4924.354	32.06	14.15	46.21	54.00	-7.79	AVG

Emission Level= Read Level+ Correct Factor

EUT:	Smart LED Colorful Bulb	Model:	XM-JPLB1
Temperature:	25 °C	Relative Humidity:	55%
Test Voltage:	AC 120V/60Hz		
Ant. Pol.	Horizontal		
Test Mode:	TX G Mode 2412MHz		
Remark:	No report for the emission which more than 10 dB below the prescribed limit.		

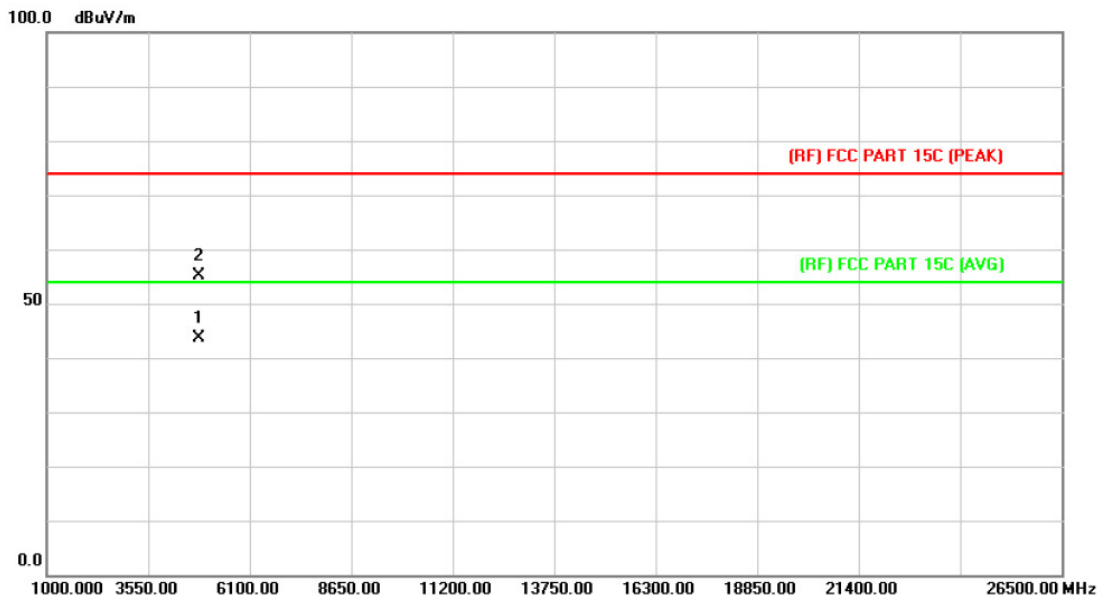

No.	Mk.	Freq. MHz	Reading Level dBuV	Correct Factor dB/m	Measure- ment dBuV/m	Limit dBuV/m	Over dB	Detector
1	*	4823.687	30.12	13.56	43.68	54.00	-10.32	AVG
2		4824.556	41.52	13.56	55.08	74.00	-18.92	peak

Emission Level= Read Level+ Correct Factor

EUT:	Smart LED Colorful Bulb	Model:	XM-JPLB1
Temperature:	25 °C	Relative Humidity:	55%
Test Voltage:	AC 120V/60Hz		
Ant. Pol.	Vertical		
Test Mode:	TX G Mode 2412MHz		
Remark:	No report for the emission which more than 10 dB below the prescribed limit.		

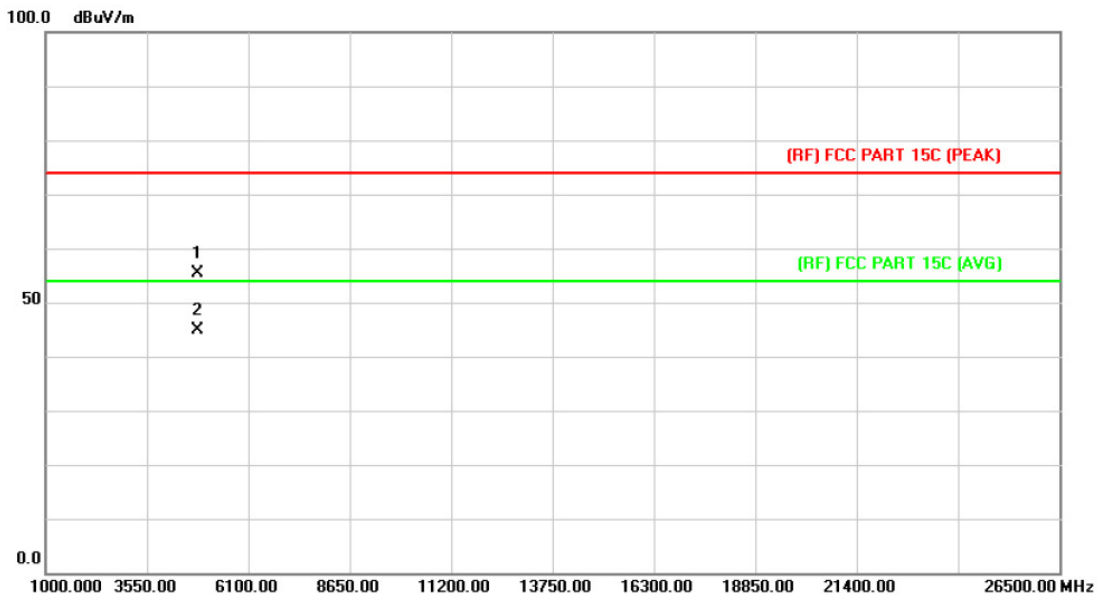

No.	Mk.	Freq.	Reading Level	Correct Factor	Measurement	Limit	Over	Detector
		MHz	dBuV	dB/m	dBuV/m	dBuV/m	dB	
1		4823.654	41.90	13.56	55.46	74.00	-18.54	peak
2	*	4824.622	31.21	13.56	44.77	54.00	-9.23	AVG

Emission Level= Read Level+ Correct Factor

EUT:	Smart LED Colorful Bulb	Model:	XM-JPLB1
Temperature:	25 °C	Relative Humidity:	55%
Test Voltage:	AC 120V/60Hz		
Ant. Pol.	Horizontal		
Test Mode:	TX G Mode 2437MHz		
Remark:	No report for the emission which more than 10 dB below the prescribed limit.		

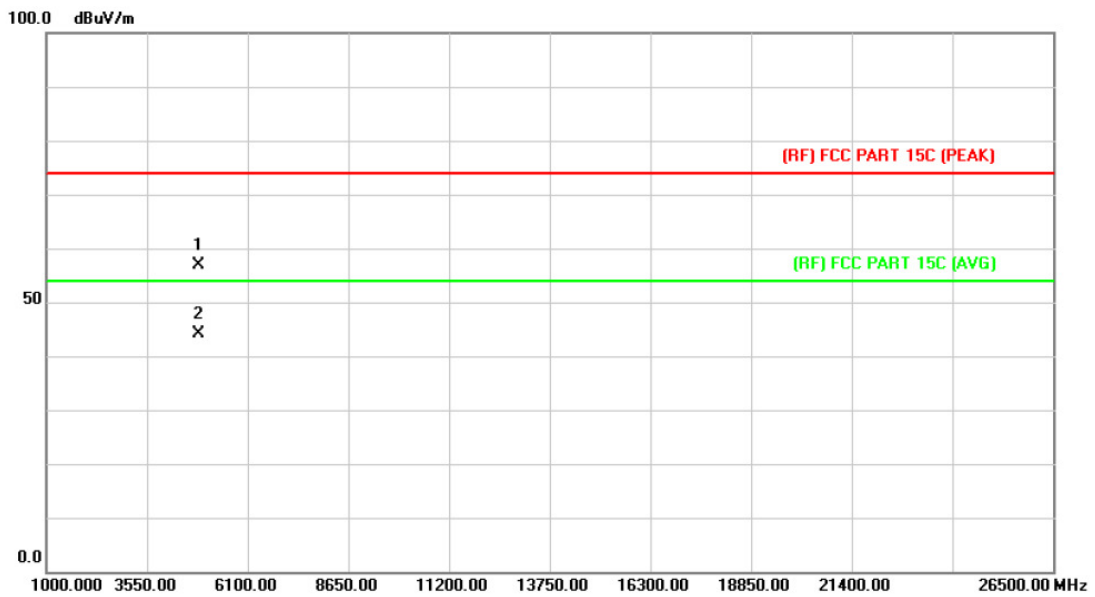

No.	Mk.	Freq. MHz	Reading Level dBuV	Correct Factor dB/m	Measure- ment dBuV/m	Limit dBuV/m	Over dB	Detector
1		4873.735	43.01	13.86	56.87	74.00	-17.13	peak
2	*	4874.035	30.39	13.86	44.25	54.00	-9.75	AVG

Emission Level= Read Level+ Correct Factor

EUT:	Smart LED Colorful Bulb	Model:	XM-JPLB1
Temperature:	25 °C	Relative Humidity:	55%
Test Voltage:	AC 120V/60Hz		
Ant. Pol.	Vertical		
Test Mode:	TX G Mode 2437MHz		
Remark:	No report for the emission which more than 10 dB below the prescribed limit.		

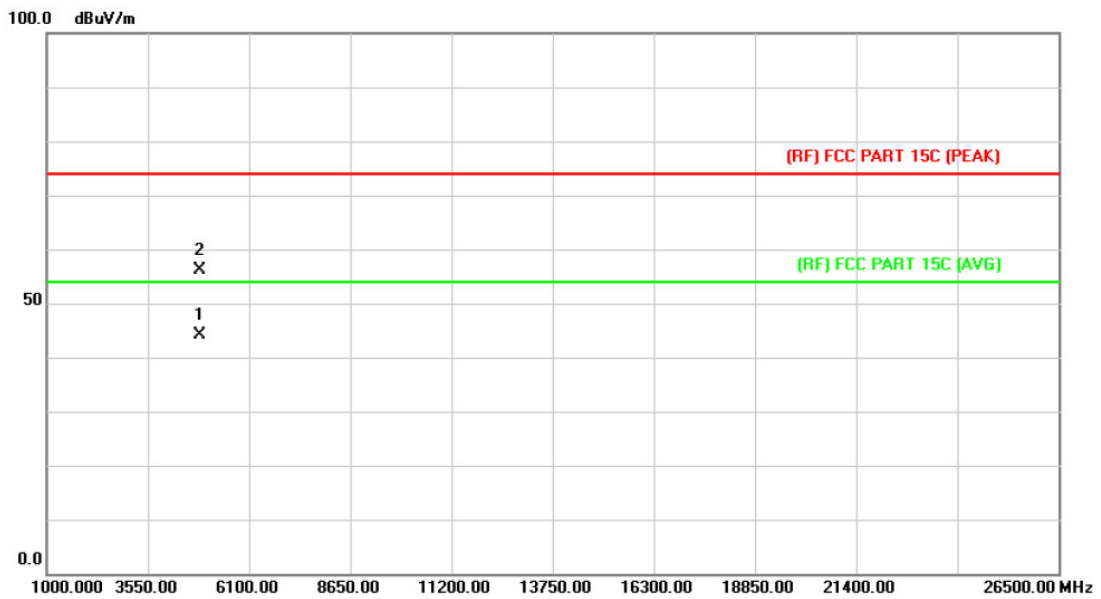

No.	Mk.	Freq. MHz	Reading Level dBuV	Correct Factor dB/m	Measure- ment dBuV/m	Limit dBuV/m	Over dB	Detector
1	*	4873.854	30.37	13.86	44.23	54.00	-9.77	AVG
2		4874.685	42.35	13.86	56.21	74.00	-17.79	peak

Emission Level= Read Level+ Correct Factor

EUT:	Smart LED Colorful Bulb	Model:	XM-JPLB1
Temperature:	25 °C	Relative Humidity:	55%
Test Voltage:	AC 120V/60Hz		
Ant. Pol.	Horizontal		
Test Mode:	TX G Mode 2462MHz		
Remark:	No report for the emission which more than 10 dB below the prescribed limit.		

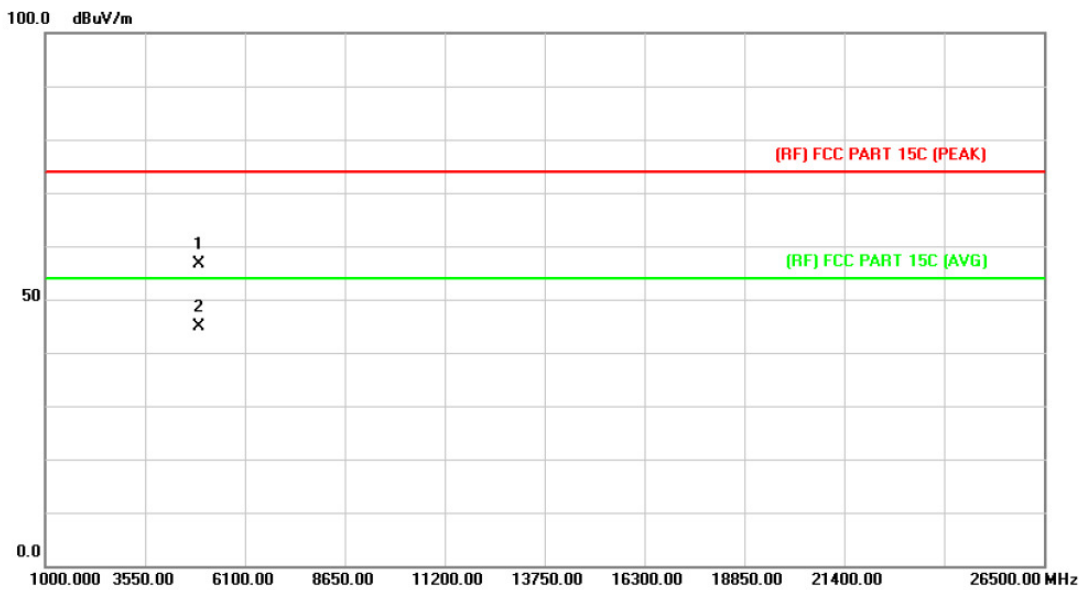

No.	Mk.	Freq.	Reading Level	Correct Factor	Measurement	Limit	Over	Detector
		MHz	dBuV	dB/m	dBuV/m	dBuV/m	dB	
1		4923.608	42.39	14.15	56.54	74.00	-17.46	peak
2	*	4923.987	30.74	14.15	44.89	54.00	-9.11	AVG

Emission Level= Read Level+ Correct Factor

EUT:	Smart LED Colorful Bulb	Model:	XM-JPLB1
Temperature:	25 °C	Relative Humidity:	55%
Test Voltage:	AC 120V/60Hz		
Ant. Pol.	Vertical		
Test Mode:	TX G Mode 2462MHz		
Remark:	No report for the emission which more than 10 dB below the prescribed limit.		

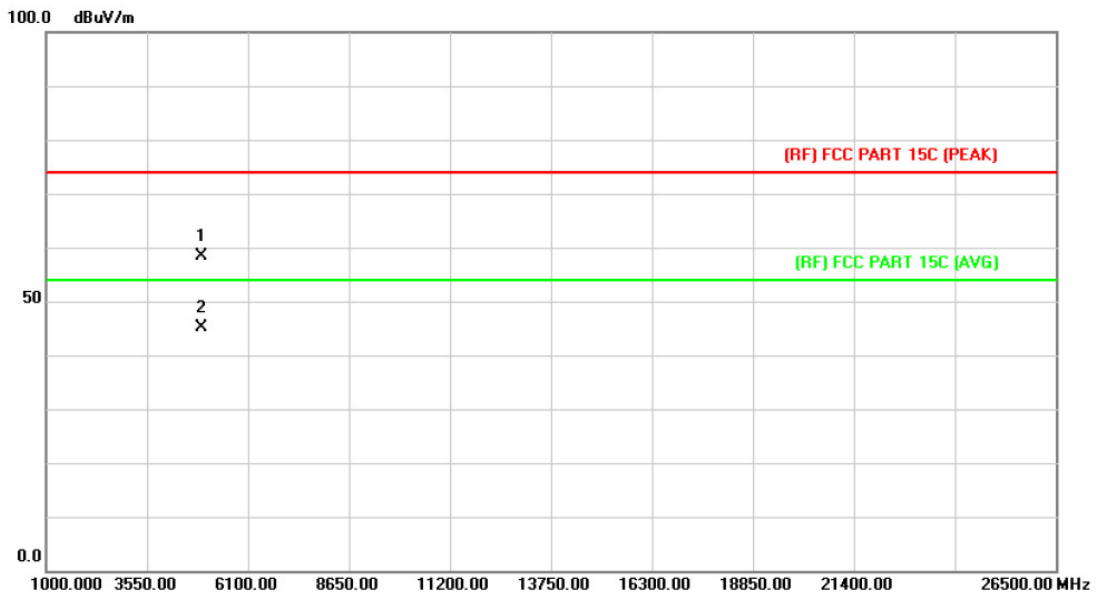

No.	Mk.	Freq.	Reading Level	Correct Factor	Measurement	Limit	Over	Detector
		MHz	dBuV	dB/m	dBuV/m	dBuV/m	dB	
1		4923.574	44.18	14.15	58.33	74.00	-15.67	peak
2	*	4923.621	30.89	14.15	45.04	54.00	-8.96	AVG

Emission Level= Read Level+ Correct Factor

EUT:	Smart LED Colorful Bulb	Model:	XM-JPLB1
Temperature:	25 °C	Relative Humidity:	55%
Test Voltage:	AC 120V/60Hz		
Ant. Pol.	Horizontal		
Test Mode:	TX N(HT20) Mode 2412MHz		
Remark:	No report for the emission which more than 10 dB below the prescribed limit.		

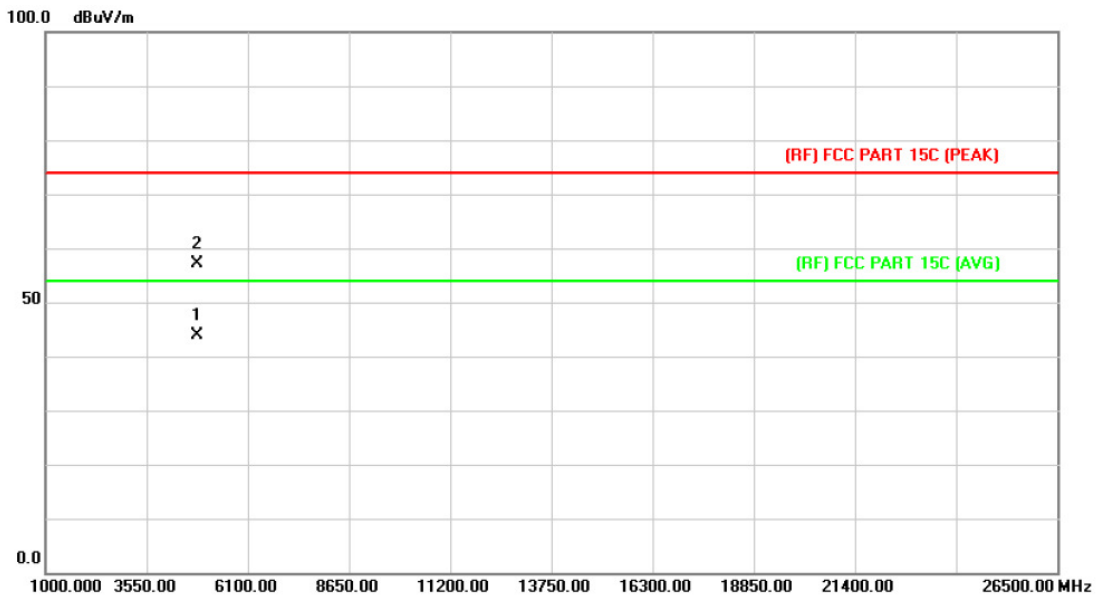

No.	Mk.	Freq.	Reading Level	Correct Factor	Measurement	Limit	Over	Detector
		MHz	dBuV	dB/m	dBuV/m	dBuV/m	dB	
1	*	4823.587	30.22	13.56	43.78	54.00	-10.22	AVG
2		4824.351	43.69	13.56	57.25	74.00	-16.75	peak

Emission Level= Read Level+ Correct Factor

EUT:	Smart LED Colorful Bulb	Model:	XM-JPLB1
Temperature:	25 °C	Relative Humidity:	55%
Test Voltage:	AC 120V/60Hz		
Ant. Pol.	Vertical		
Test Mode:	TX N(HT20) Mode 2412MHz		
Remark:	No report for the emission which more than 10 dB below the prescribed limit.		

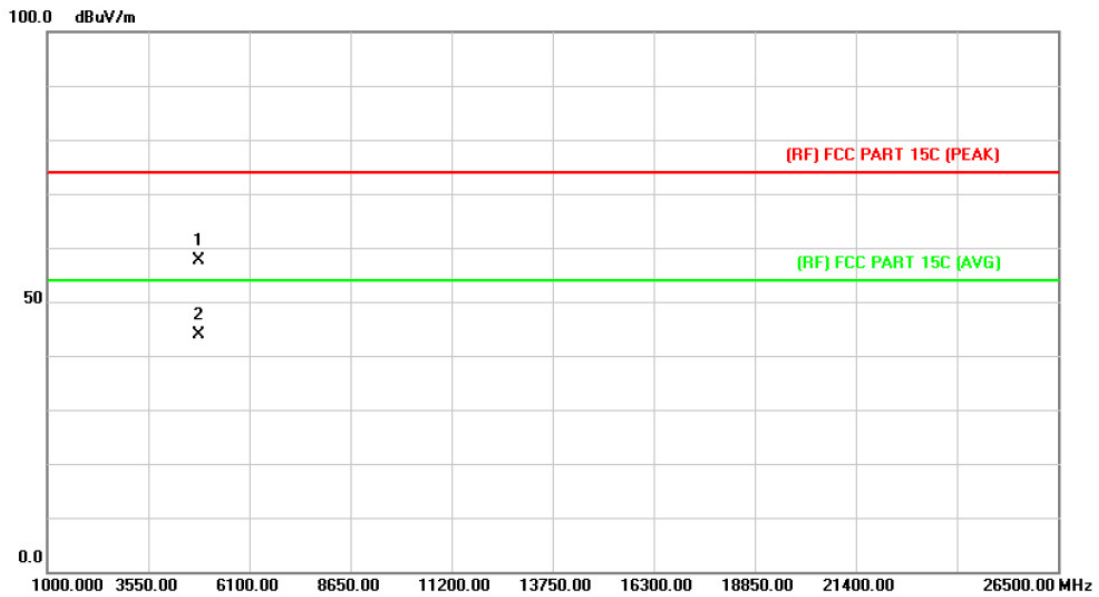

No.	Mk.	Freq. MHz	Reading Level dBuV	Correct Factor dB/m	Measure- ment dBuV/m	Limit dBuV/m	Over dB	Detector
1		4823.684	44.09	13.56	57.65	74.00	-16.35	peak
2	*	4824.521	30.41	13.56	43.97	54.00	-10.03	AVG

Emission Level= Read Level+ Correct Factor

EUT:	Smart LED Colorful Bulb	Model:	XM-JPLB1
Temperature:	25 °C	Relative Humidity:	55%
Test Voltage:	AC 120V/60Hz		
Ant. Pol.	Horizontal		
Test Mode:	TX N(HT20) Mode 2437MHz		
Remark:	No report for the emission which more than 10 dB below the prescribed limit.		

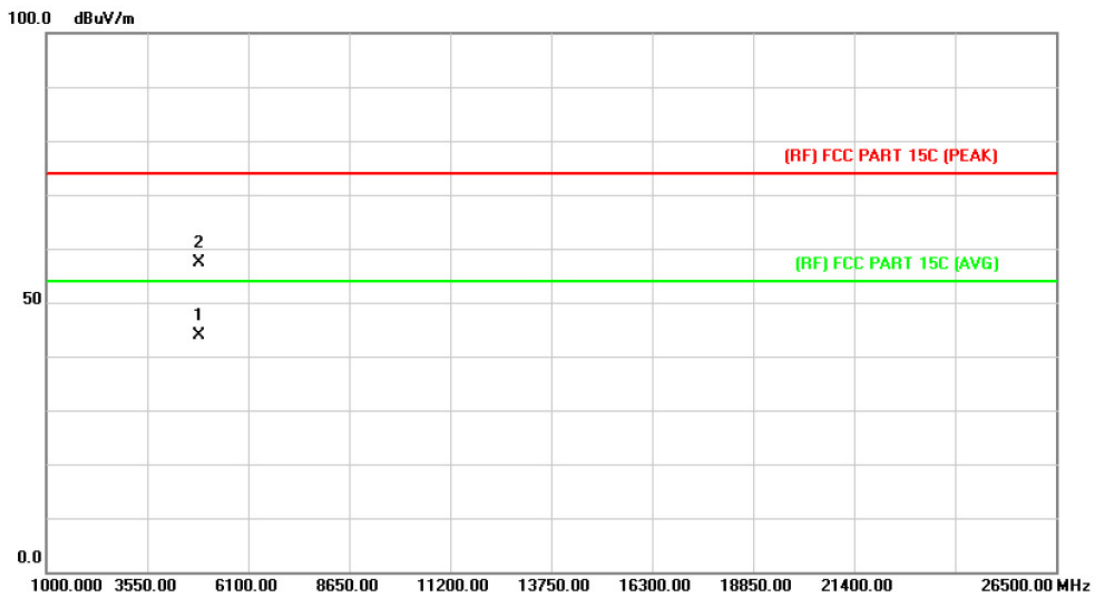

No.	Mk.	Freq. MHz	Reading Level dBuV	Correct Factor dB/m	Measure- ment dBuV/m	Limit dBuV/m	Over dB	Detector
1	*	4873.985	30.01	13.86	43.87	54.00	-10.13	AVG
2		4874.025	43.52	13.86	57.38	74.00	-16.62	peak

Emission Level= Read Level+ Correct Factor

EUT:	Smart LED Colorful Bulb	Model:	XM-JPLB1
Temperature:	25 °C	Relative Humidity:	55%
Test Voltage:	AC 120V/60Hz		
Ant. Pol.	Vertical		
Test Mode:	TX N(HT20) Mode 2437MHz		
Remark:	No report for the emission which more than 10 dB below the prescribed limit.		

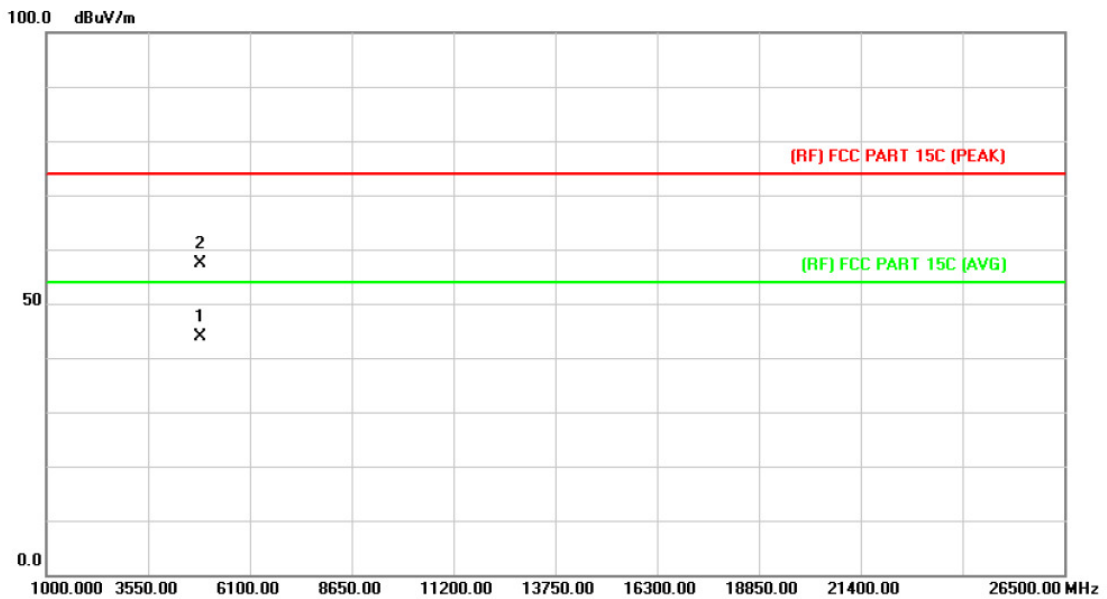

No.	Mk.	Freq.	Reading Level	Correct Factor	Measurement	Limit	Over	Detector
		MHz	dBuV	dB/m	dBuV/m	dBuV/m	dB	
1	*	4873.608	29.96	13.86	43.82	54.00	-10.18	AVG
2		4874.621	43.40	13.86	57.26	74.00	-16.74	peak

Emission Level= Read Level+ Correct Factor

EUT:	Smart LED Colorful Bulb	Model:	XM-JPLB1
Temperature:	25 °C	Relative Humidity:	55%
Test Voltage:	AC 120V/60Hz		
Ant. Pol.	Horizontal		
Test Mode:	TX N(HT20) Mode 2462MHz		
Remark:	No report for the emission which more than 10 dB below the prescribed limit.		

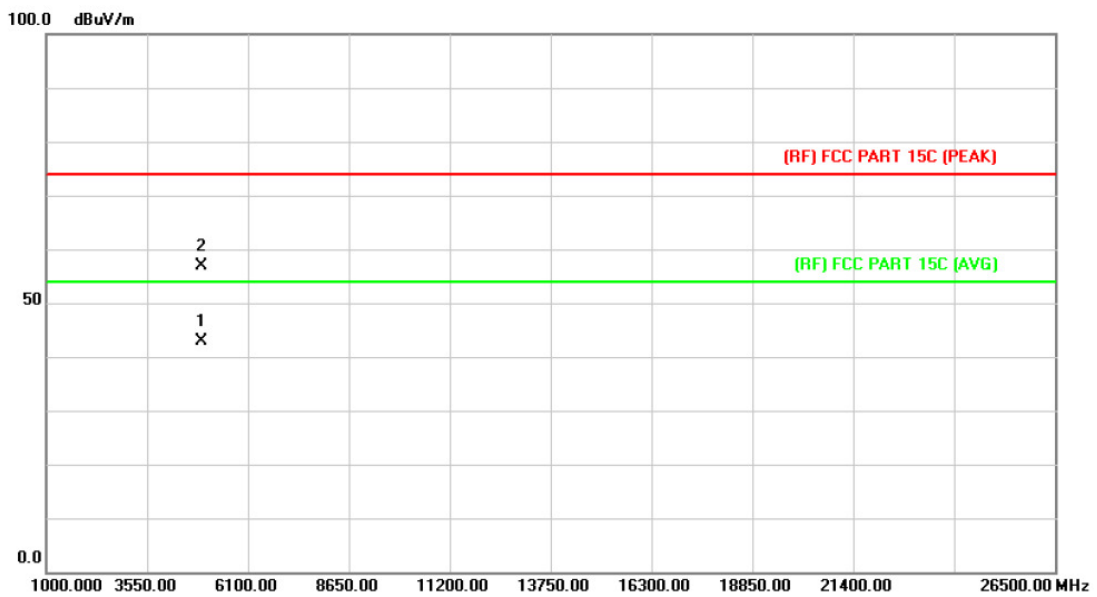

No.	Mk.	Freq. MHz	Reading Level dBuV	Correct Factor dB/m	Measure- ment dBuV/m	Limit dBuV/m	Over dB	Detector
1	*	4923.854	28.71	14.15	42.86	54.00	-11.14	AVG
2		4924.341	42.74	14.15	56.89	74.00	-17.11	peak

Emission Level= Read Level+ Correct Factor

EUT:	Smart LED Colorful Bulb	Model:	XM-JPLB1
Temperature:	25 °C	Relative Humidity:	55%
Test Voltage:	AC 120V/60Hz		
Ant. Pol.	Vertical		
Test Mode:	TX N(HT20) Mode 2462MHz		
Remark:	No report for the emission which more than 10 dB below the prescribed limit.		

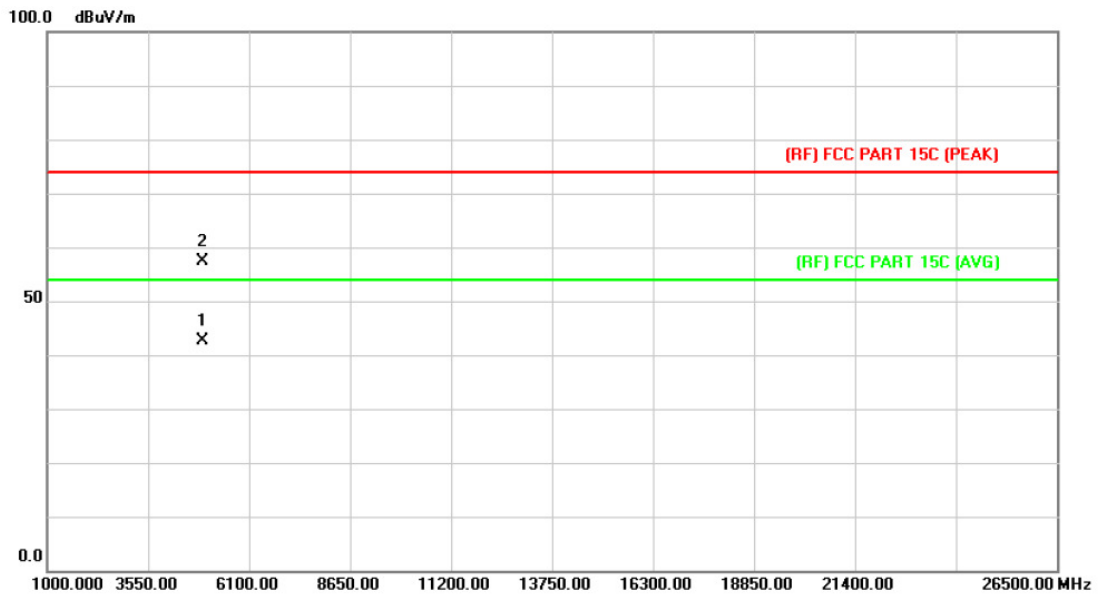

No.	Mk.	Freq.	Reading Level	Correct Factor	Measurement	Limit	Over	Detector
		MHz	dBuV	dB/m	dBuV/m	dBuV/m	dB	
1	*	4923.874	28.42	14.15	42.57	54.00	-11.43	AVG
2		4924.084	43.20	14.15	57.35	74.00	-16.65	peak

Emission Level= Read Level+ Correct Factor

EUT:	Smart LED Colorful Bulb	Model:	XM-JPLB1
Temperature:	25 °C	Relative Humidity:	55%
Test Voltage:	AC 120V/60Hz		
Ant. Pol.	Horizontal		
Test Mode:	TX N(HT40) Mode 2422MHz		
Remark:	No report for the emission which more than 10 dB below the prescribed limit.		

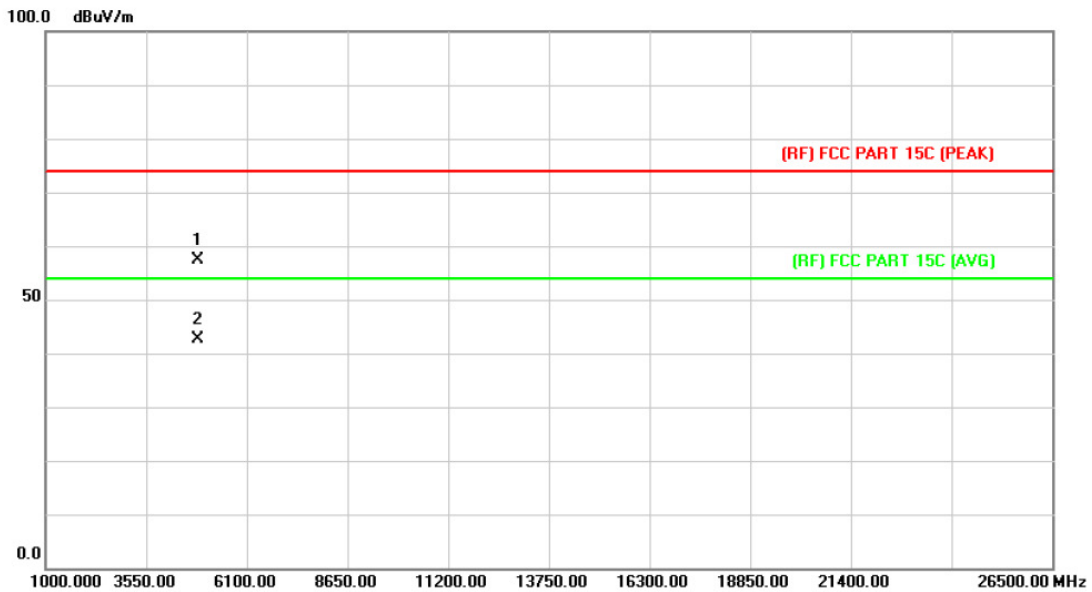

No.	Mk.	Freq.	Reading Level	Correct Factor	Measurement	Limit	Over	Detector
		MHz	dBuV	dB/m	dBuV/m	dBuV/m	dB	
1		4844.054	43.64	13.68	57.32	74.00	-16.68	peak
2	*	4844.321	28.89	13.68	42.57	54.00	-11.43	AVG

Emission Level= Read Level+ Correct Factor

EUT:	Smart LED Colorful Bulb	Model:	XM-JPLB1
Temperature:	25 °C	Relative Humidity:	55%
Test Voltage:	AC 120V/60Hz		
Ant. Pol.	Vertical		
Test Mode:	TX N(HT40) Mode 2422MHz		
Remark:	No report for the emission which more than 10 dB below the prescribed limit.		

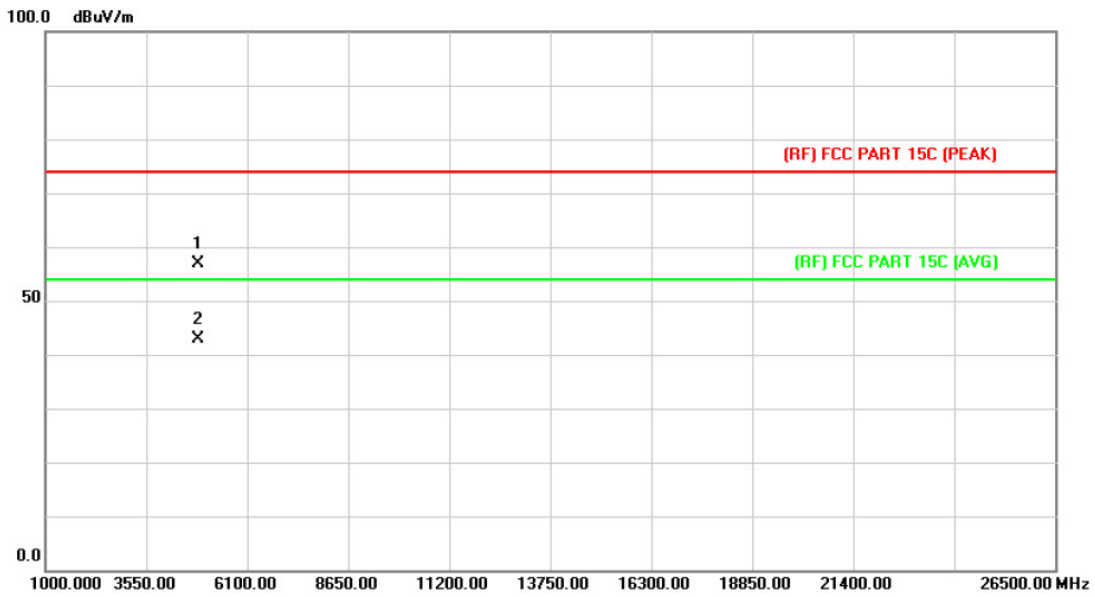

No.	Mk.	Freq. MHz	Reading Level dBuV	Correct Factor dB/m	Measure- ment dBuV/m	Limit dBuV/m	Over dB	Detector
1		4843.956	43.19	13.68	56.87	74.00	-17.13	peak
2	*	4844.221	29.14	13.68	42.82	54.00	-11.18	AVG

Emission Level= Read Level+ Correct Factor

EUT:	Smart LED Colorful Bulb	Model:	XM-JPLB1
Temperature:	25 °C	Relative Humidity:	55%
Test Voltage:	AC 120V/60Hz		
Ant. Pol.	Horizontal		
Test Mode:	TX N(HT40) Mode 2437MHz		
Remark:	No report for the emission which more than 10 dB below the prescribed limit.		

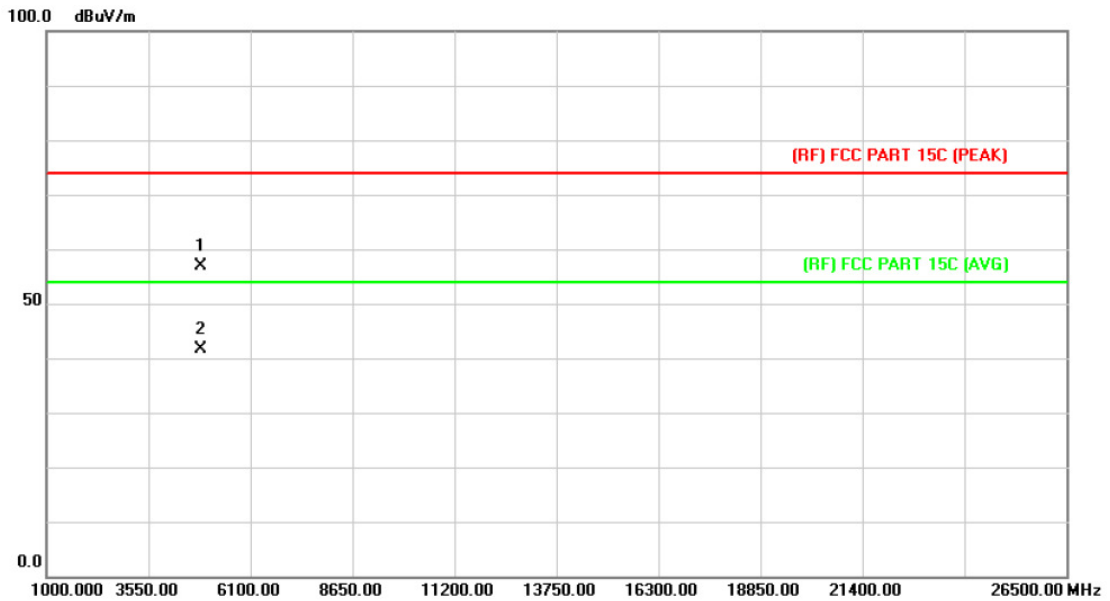

No.	Mk.	Freq. MHz	Reading Level dBuV	Correct Factor dB/m	Measure- ment dBuV/m	Limit dBuV/m	Over dB	Detector
1		4873.984	43.01	13.86	56.87	74.00	-17.13	peak
2	*	4874.521	27.70	13.86	41.56	54.00	-12.44	AVG

Emission Level= Read Level+ Correct Factor

EUT:	Smart LED Colorful Bulb	Model:	XM-JPLB1
Temperature:	25 °C	Relative Humidity:	55%
Test Voltage:	AC 120V/60Hz		
Ant. Pol.	Vertical		
Test Mode:	TX N(HT40) Mode 2437MHz		
Remark:	No report for the emission which more than 10 dB below the prescribed limit.		

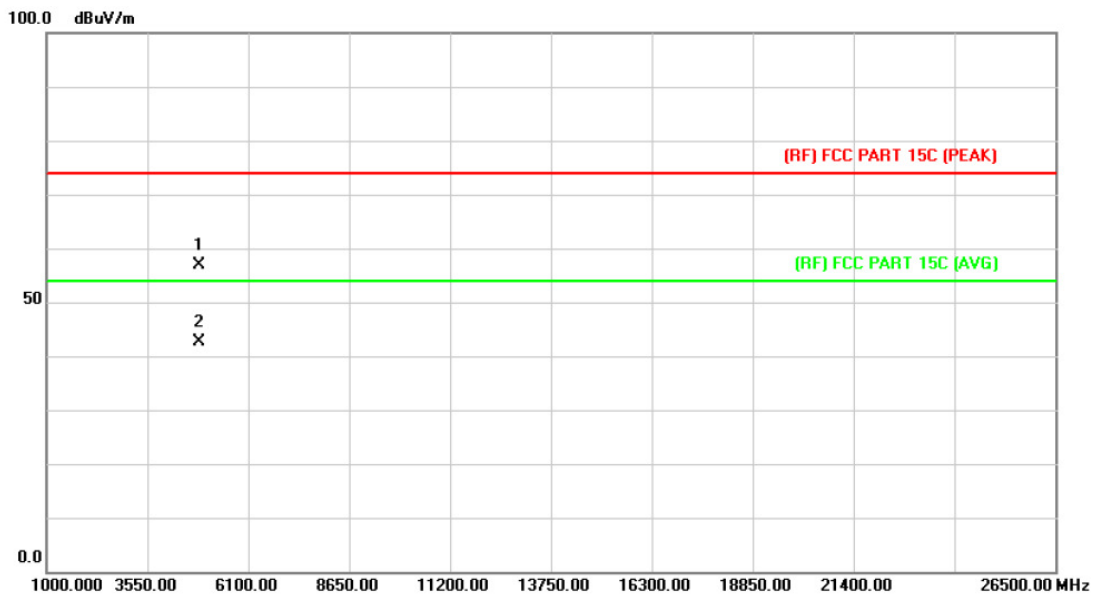

No.	Mk.	Freq. MHz	Reading Level dBuV	Correct Factor dB/m	Measure- ment dBuV/m	Limit dBuV/m	Over dB	Detector
1		4873.691	43.12	13.86	56.98	74.00	-17.02	peak
2	*	4874.674	28.79	13.86	42.65	54.00	-11.35	AVG

Emission Level= Read Level+ Correct Factor

EUT:	Smart LED Colorful Bulb	Model:	XM-JPLB1
Temperature:	25 °C	Relative Humidity:	55%
Test Voltage:	AC 120V/60Hz		
Ant. Pol.	Horizontal		
Test Mode:	TX N(HT40) Mode 2452MHz		
Remark:	No report for the emission which more than 10 dB below the prescribed limit.		

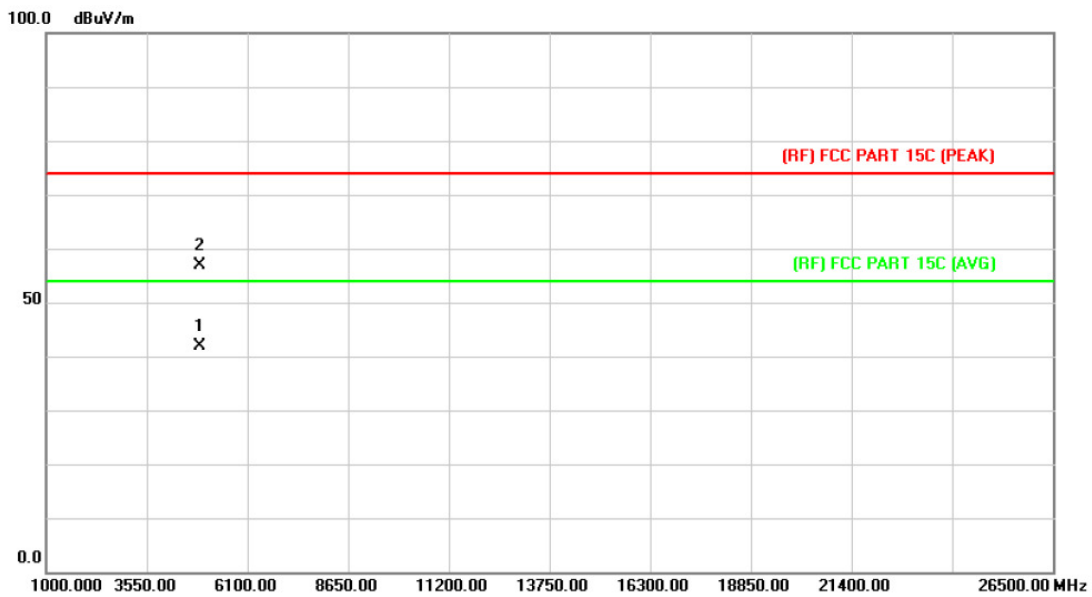

No.	Mk.	Freq.	Reading Level	Correct Factor	Measurement	Limit	Over	Detector
		MHz	dBuV	dB/m	dBuV/m	dBuV/m	dB	
1	*	4903.574	27.83	14.03	41.86	54.00	-12.14	AVG
2		4904.054	42.95	14.03	56.98	74.00	-17.02	peak

Emission Level= Read Level+ Correct Factor

EUT:	Smart LED Colorful Bulb	Model:	XM-JPLB1
Temperature:	25 °C	Relative Humidity:	55%
Test Voltage:	AC 120V/60Hz		
Ant. Pol.	Vertical		
Test Mode:	TX N(HT40) Mode 2452MHz		
Remark:	No report for the emission which more than 10 dB below the prescribed limit.		

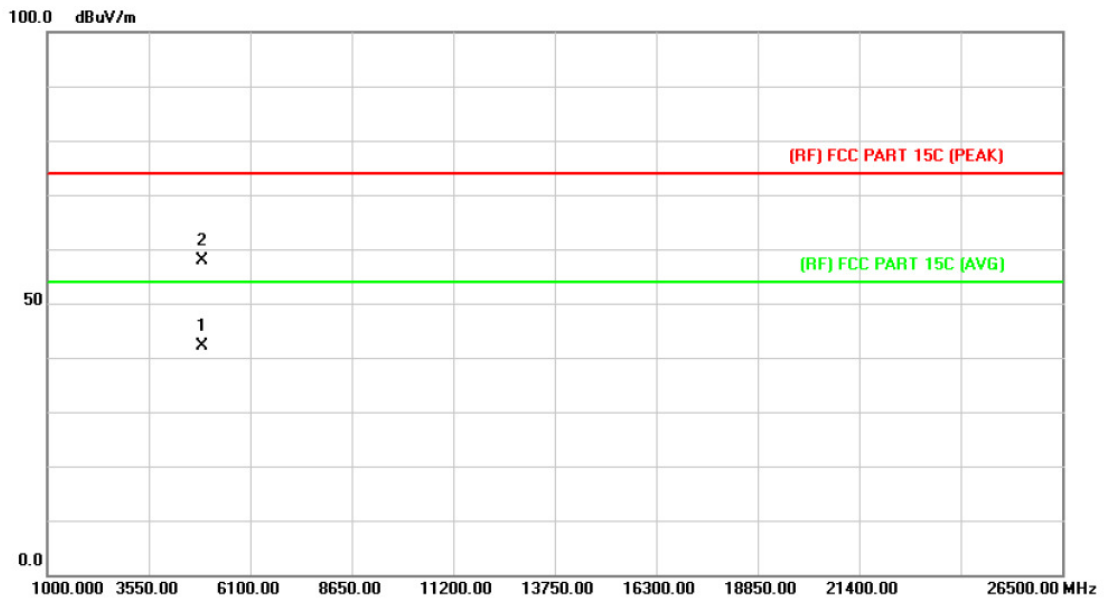

No.	Mk.	Freq.	Reading Level	Correct Factor	Measurement	Limit	Over	
		MHz	dBuV	dB/m	dBuV/m	dBuV/m	dB	Detector
1	*	4903.841	28.21	14.03	42.24	54.00	-11.76	AVG
2		4904.671	43.91	14.03	57.94	74.00	-16.06	peak

Emission Level= Read Level+ Correct Factor

6. Restricted Bands Requirement

6.1 Test Standard and Limit

6.1.1 Test Standard

FCC Part 15.209 FCC Part 15.205

6.1.2 Test Limit

Restricted Frequency Band (MHz)	Class B (dBuV/m)(at 3 M)	
	Peak	Average
2310 ~2390	74	54
2483.5 ~2500	74	54

6.2 Test Setup

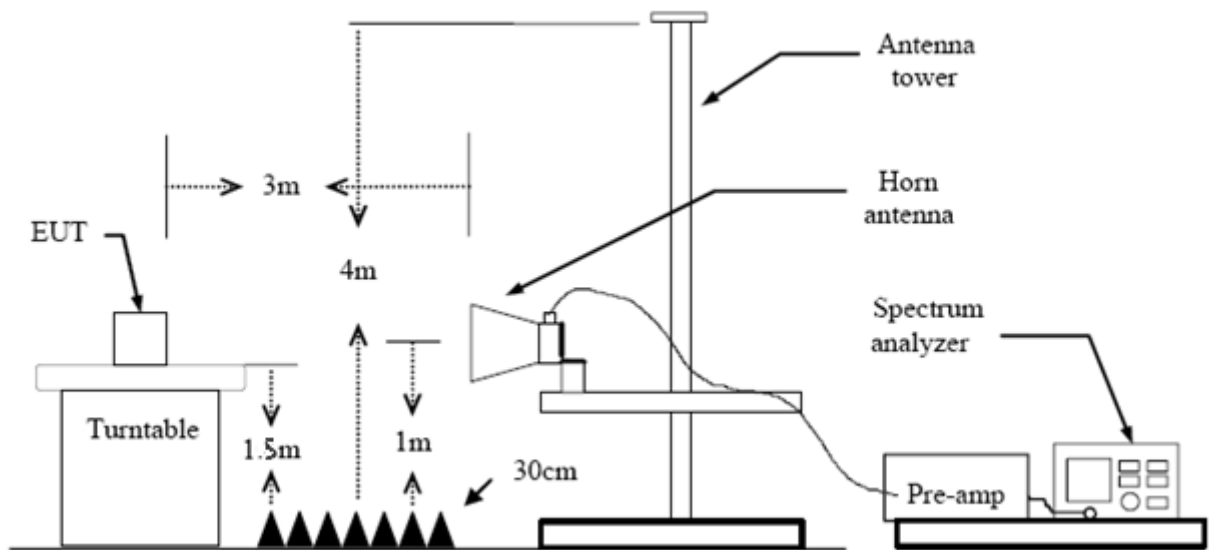

6.3 Test Procedure

- (1) The measuring distance of 3m shall be used for measurements at frequency up to 1GHz and above 1 GHz. The EUT was placed on a rotating 0.8m high above ground, the table was rotated 360 degrees to determine the position of the highest radiation.
- (2) Measurements at frequency above 1GHz. The EUT was placed on a rotating 1.5m high above the ground. RF absorbers covered the ground plane with a minimum area of 3.0m by 3.0m between the EUT and measurement receiver antenna. The RF absorber shall not exceed 30cm in high above the conducting floor. The table was rotated 360 degrees to determine the position of the highest radiation.
- (3) The Test antenna shall vary between 1m and 4m, Both Horizontal and Vertical antenna are set to make measurement.

- (4) The initial step in collecting conducted emission data is a spectrum analyzer peak detector mode pre-scanning the measurement frequency range. Significant peaks are then marked and then Quasi Peak detector mode re-measured.
- (5) If the Peak Mode measured value compliance with and lower than Quasi Peak Mode Limit Bellow 1 GHz, the EUT shall be deemed to meet QP Limits and then no additional QP Mode measurement performed. But the Peak Value and average value both need to comply with applicable limit above 1 GHz.
- (6) Testing frequency range below 1GHz the measuring instrument use VBW=120 kHz with Quasi-peak detection.
- (7) Testing frequency range above 1GHz the measuring instrument use RBW=1 MHz and VBW=3 MHz with Peak Detector for Peak Values, and use RBW=1 MHz and VBW=10 Hz with Peak Detector for Average Values.
- (8) For the actual test configuration, please see the test setup photo.

6.4 EUT Operating Condition

The Equipment Under Test was set to Continual Transmitting in maximum power.

6.5 Test Data

Please see the next page.

(1) Radiation Test

EUT:	Smart LED Colorful Bulb	Model:	XM-JPLB1
Temperature:	25 °C	Relative Humidity:	55%
Test Voltage:	AC 120V/60Hz		
Ant. Pol.	Horizontal		
Test Mode:	TX B Mode 2412MHz		
Remark:	N/A		

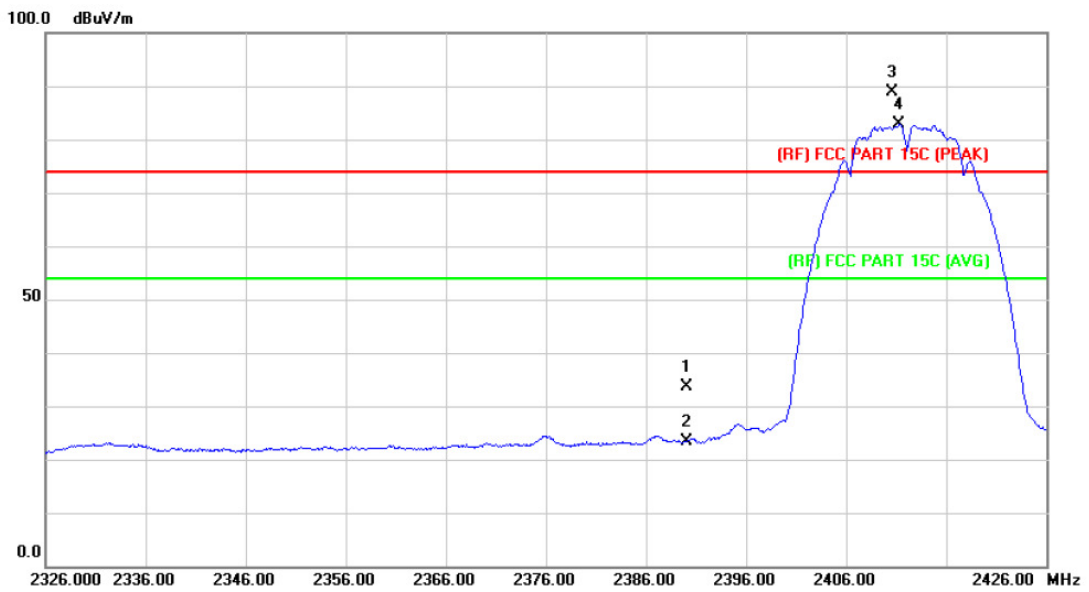

No.	Mk.	Freq. MHz	Reading Level dBuV	Correct Factor dB/m	Measure- ment dBuV/m	Limit dBuV/m	Over dB	Detector
1		2390.000	32.80	0.77	33.57	74.00	-40.43	peak
2		2390.000	22.66	0.77	23.43	54.00	-30.57	AVG
3	X	2410.600	88.12	0.86	88.98	Fundamental Frequency		peak
4	*	2411.300	81.94	0.86	82.80	Fundamental Frequency		AVG

Emission Level= Read Level+ Correct Factor

EUT:	Smart LED Colorful Bulb	Model:	XM-JPLB1
Temperature:	25 °C	Relative Humidity:	55%
Test Voltage:	AC 120V/60Hz		
Ant. Pol.	Vertical		
Test Mode:	TX B Mode 2412MHz		
Remark:	N/A		

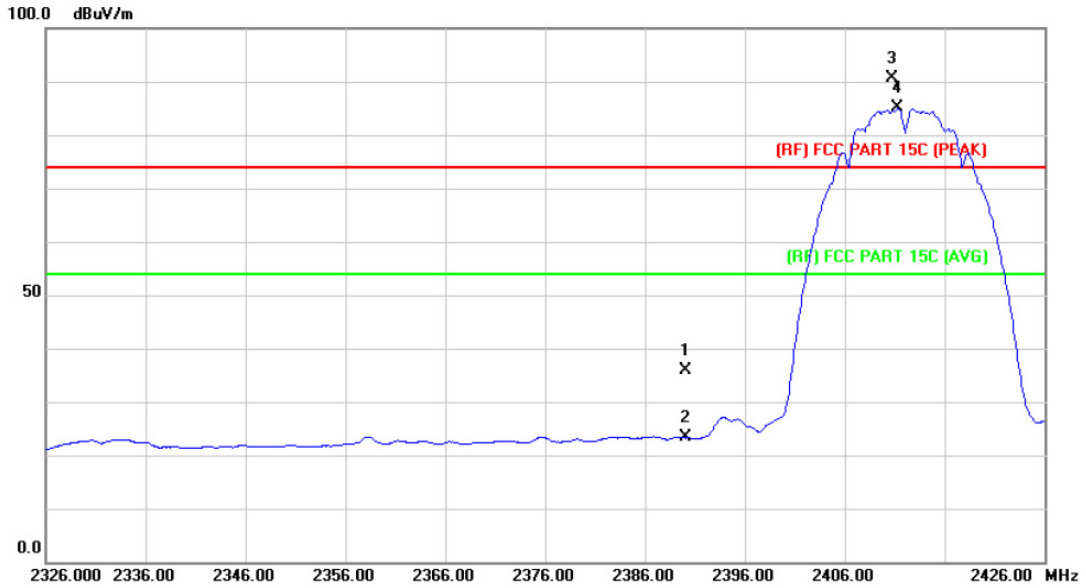

No.	Mk.	Freq. MHz	Reading Level dBuV	Correct Factor dB/m	Measure- ment dBuV/m	Limit dBuV/m	Over dB	Detector
1		2390.000	35.00	0.77	35.77	74.00	-38.23	peak
2		2390.000	22.51	0.77	23.28	54.00	-30.72	AVG
3	X	2410.700	89.70	0.86	90.56	Fundamental Frequency		peak
4	*	2411.300	84.16	0.86	85.02	Fundamental Frequency		AVG

Emission Level= Read Level+ Correct Factor

EUT:	Smart LED Colorful Bulb	Model:	XM-JPLB1
Temperature:	25 °C	Relative Humidity:	55%
Test Voltage:	AC 120V/60Hz		
Ant. Pol.	Horizontal		
Test Mode:	TX B Mode 2462MHz		
Remark:	N/A		

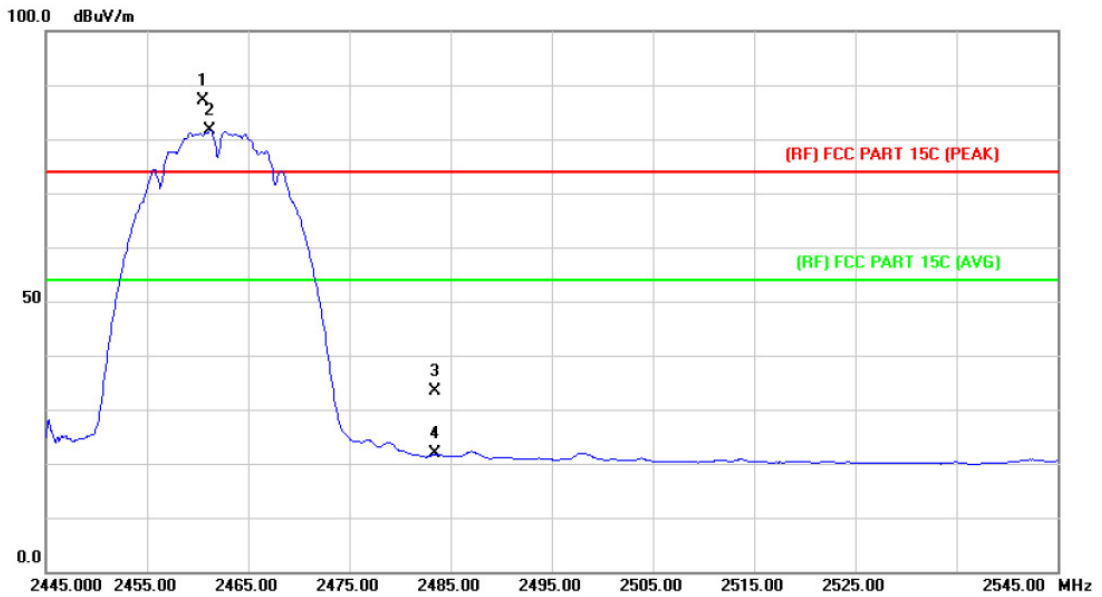

No.	Mk.	Freq. MHz	Reading Level dBuV	Correct Factor dB/m	Measure- ment dBuV/m	Limit dBuV/m	Over dB	Detector
1	X	2460.600	86.19	1.06	87.25	Fundamental Frequency		peak
2	*	2461.200	80.46	1.07	81.53	Fundamental Frequency		AVG
3		2483.500	32.26	1.17	33.43	74.00	-40.57	peak
4		2483.500	20.59	1.17	21.76	54.00	-32.24	AVG

Emission Level= Read Level+ Correct Factor

EUT:	Smart LED Colorful Bulb	Model:	XM-JPLB1
Temperature:	25 °C	Relative Humidity:	55%
Test Voltage:	AC 120V/60Hz		
Ant. Pol.	Vertical		
Test Mode:	TX B Mode 2462MHz		
Remark:	N/A		

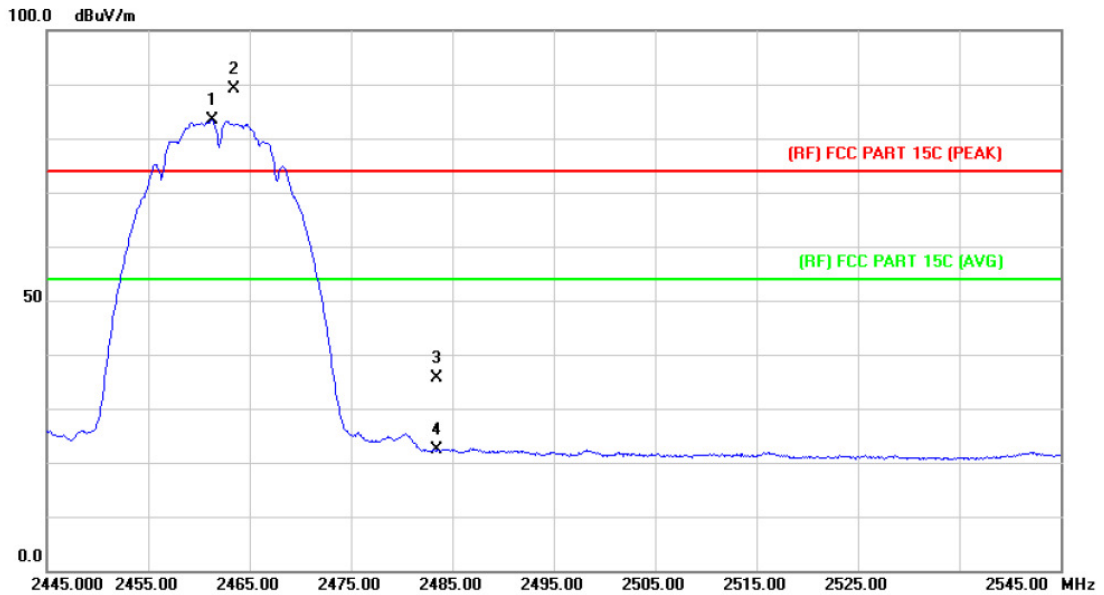

No.	Mk.	Freq. MHz	Reading Level dBuV	Correct Factor dB/m	Measure- ment dBuV/m	Limit dBuV/m	Over dB	Detector
1	*	2461.300	82.21	1.07	83.28	Fundamental Frequency		AVG
2	X	2463.400	88.05	1.08	89.13	Fundamental Frequency		peak
3		2483.500	34.54	1.17	35.71	74.00	-38.29	peak
4		2483.500	21.12	1.17	22.29	54.00	-31.71	AVG

Emission Level= Read Level+ Correct Factor

EUT:	Smart LED Colorful Bulb	Model:	XM-JPLB1
Temperature:	25 °C	Relative Humidity:	55%
Test Voltage:	AC 120V/60Hz		
Ant. Pol.	Horizontal		
Test Mode:	TX G Mode 2412MHz		
Remark:	N/A		

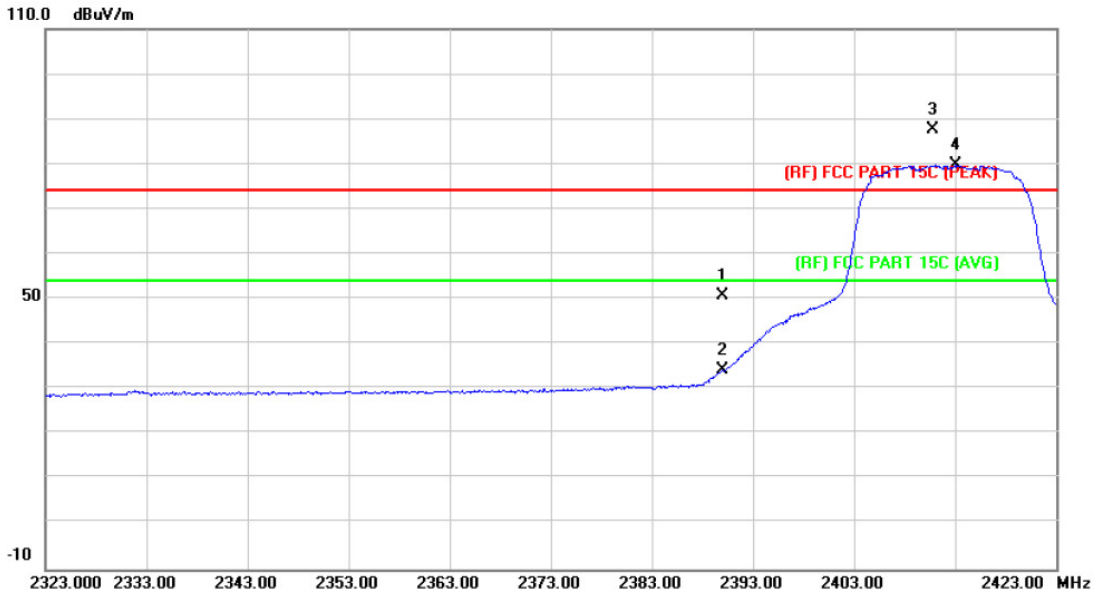

No.	Mk.	Freq.	Reading Level	Correct Factor	Measurement	Limit	Over	Detector
		MHz	dBuV	dB/m	dBuV/m	dBuV/m	dB	
1		2390.000	49.94	0.77	50.71	74.00	-23.29	peak
2		2390.000	33.39	0.77	34.16	54.00	-19.84	AVG
3	X	2410.800	86.84	0.86	87.70	Fundamental Frequency		peak
4	*	2413.100	78.86	0.86	79.72	Fundamental Frequency		AVG

Emission Level= Read Level+ Correct Factor

EUT:	Smart LED Colorful Bulb	Model:	XM-JPLB1
Temperature:	25 °C	Relative Humidity:	55%
Test Voltage:	AC 120V/60Hz		
Ant. Pol.	Vertical		
Test Mode:	TX G Mode 2412MHz		
Remark:	N/A		

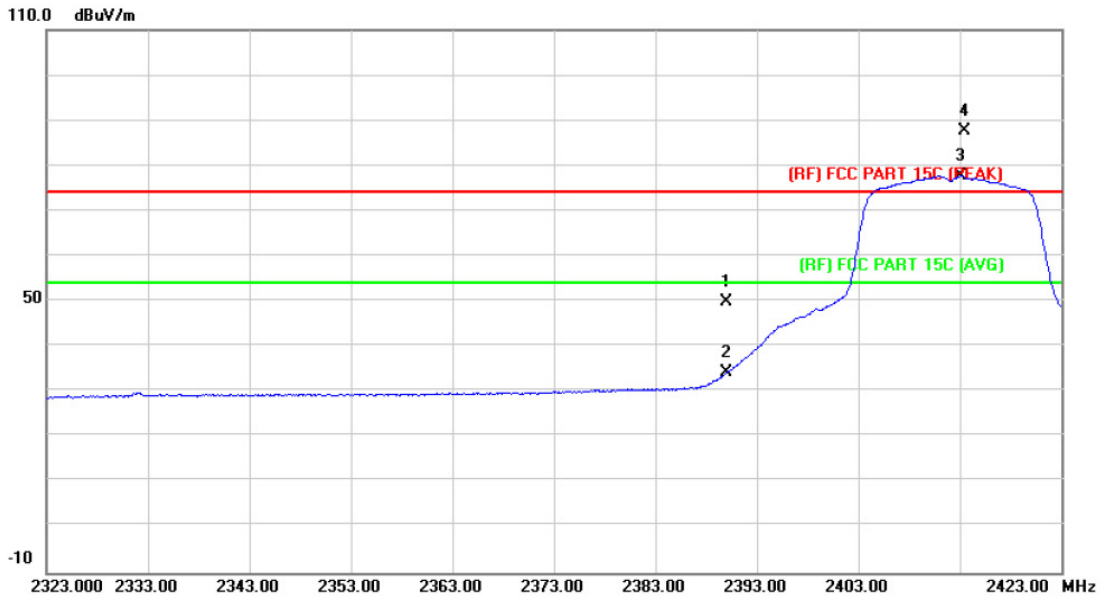

No.	Mk.	Freq.	Reading Level	Correct Factor	Measurement	Limit	Over	Detector
		MHz	dBuV	dB/m	dBuV/m	dBuV/m	dB	
1		2390.000	49.22	0.77	49.99	74.00	-24.01	peak
2		2390.000	33.38	0.77	34.15	54.00	-19.85	AVG
3	*	2413.100	76.86	0.86	77.72	Fundamental Frequency		AVG
4	X	2413.500	86.88	0.86	87.74	Fundamental Frequency		peak

Emission Level= Read Level+ Correct Factor

EUT:	Smart LED Colorful Bulb	Model:	XM-JPLB1
Temperature:	25 °C	Relative Humidity:	55%
Test Voltage:	AC 120V/60Hz		
Ant. Pol.	Horizontal		
Test Mode:	TX G Mode 2462MHz		
Remark:	N/A		

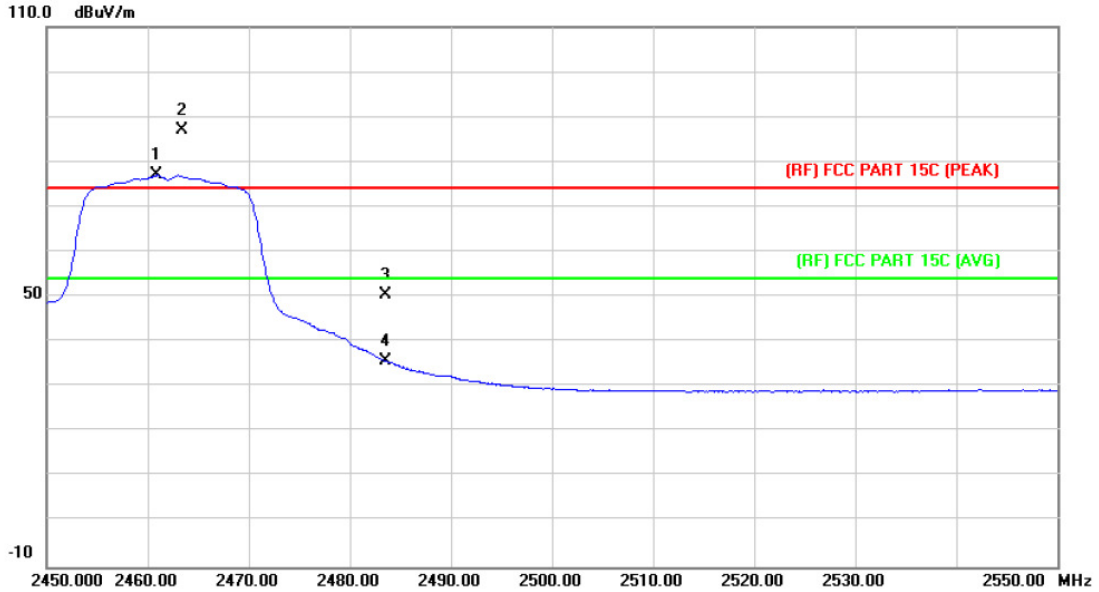

No.	Mk.	Freq. MHz	Reading Level dBuV	Correct Factor dB/m	Measure- ment dBuV/m	Limit dBuV/m	Over dB	Detector
1	*	2460.900	75.98	1.06	77.04	Fundamental Frequency		AVG
2	X	2463.400	86.00	1.08	87.08	Fundamental Frequency		peak
3		2483.500	49.18	1.17	50.35	74.00	-23.65	peak
4		2483.500	34.69	1.17	35.86	54.00	-18.14	AVG

Emission Level= Read Level+ Correct Factor

EUT:	Smart LED Colorful Bulb	Model:	XM-JPLB1
Temperature:	25 °C	Relative Humidity:	55%
Test Voltage:	AC 120V/60Hz		
Ant. Pol.	Vertical		
Test Mode:	TX G Mode 2462MHz		
Remark:	N/A		

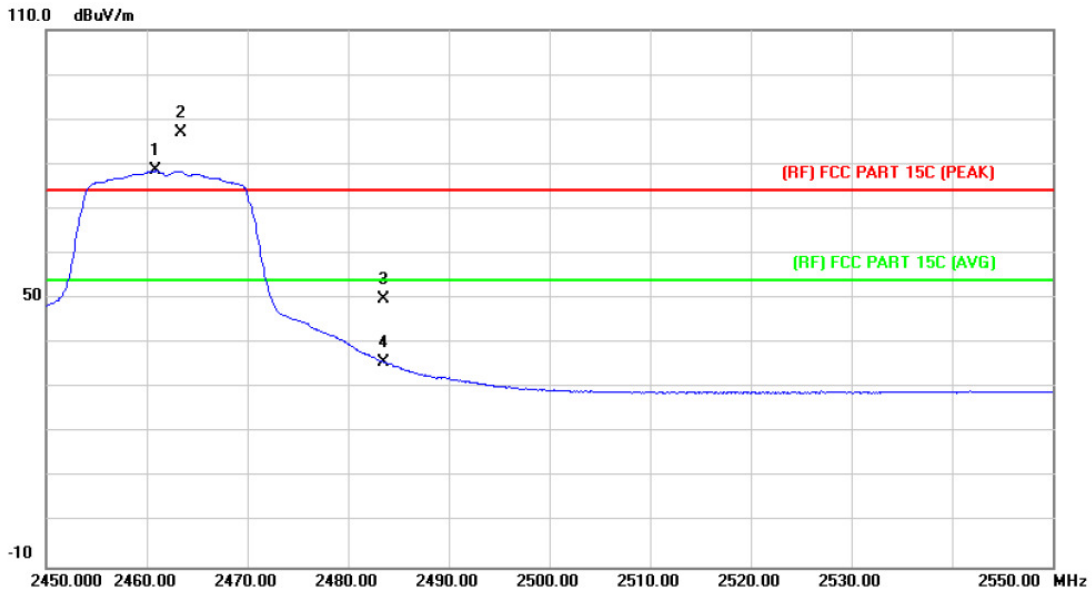

No.	Mk.	Freq. MHz	Reading Level dBuV	Correct Factor dB/m	Measure- ment dBuV/m	Limit dBuV/m	Over dB	Detector
1	*	2460.900	77.46	1.06	78.52	Fundamental Frequency		AVG
2	X	2463.400	85.95	1.08	87.03	Fundamental Frequency		peak
3		2483.500	48.79	1.17	49.96	74.00	-24.04	peak
4		2483.500	34.60	1.17	35.77	74.00	-38.23	peak

Emission Level= Read Level+ Correct Factor

EUT:	Smart LED Colorful Bulb	Model:	XM-JPLB1
Temperature:	25 °C	Relative Humidity:	55%
Test Voltage:	AC 120V/60Hz		
Ant. Pol.	Horizontal		
Test Mode:	TX N(HT20) Mode 2412MHz		
Remark:	N/A		

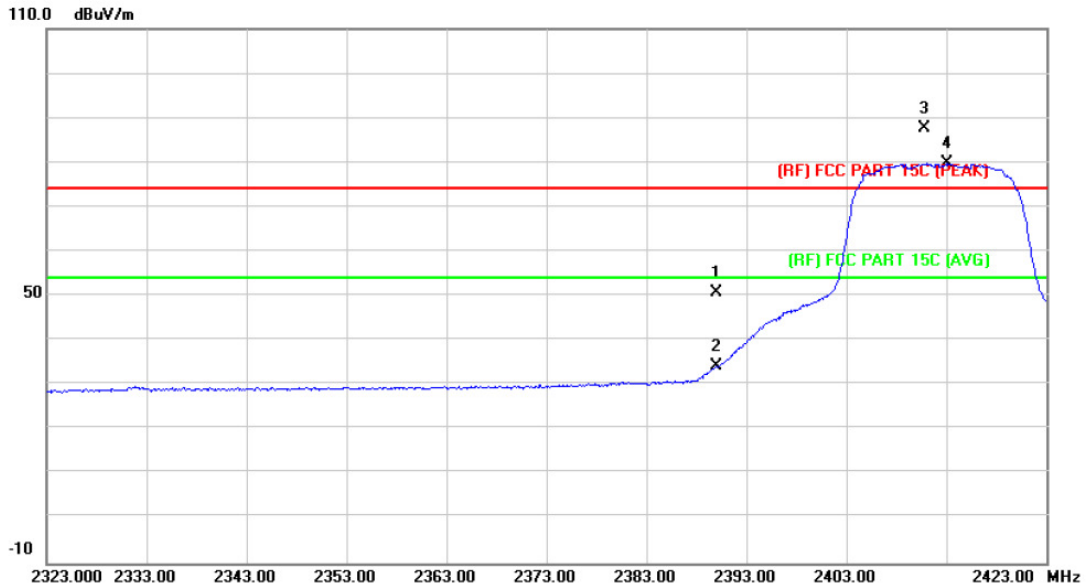

No.	Mk.	Freq. MHz	Reading Level dBuV	Correct Factor dB/m	Measure- ment dBuV/m	Limit dBuV/m	Over dB	Detector
1		2390.000	49.94	0.77	50.71	74.00	-23.29	peak
2		2390.000	33.39	0.77	34.16	54.00	-19.84	AVG
3	X	2410.800	86.84	0.86	87.70	Fundamental Frequency		peak
4	*	2413.100	78.86	0.86	79.72	Fundamental Frequency		AVG

Emission Level= Read Level+ Correct Factor

EUT:	Smart LED Colorful Bulb	Model:	XM-JPLB1
Temperature:	25 °C	Relative Humidity:	55%
Test Voltage:	AC 120V/60Hz		
Ant. Pol.	Vertical		
Test Mode:	TX N(HT20) Mode 2412MHz		
Remark:	N/A		

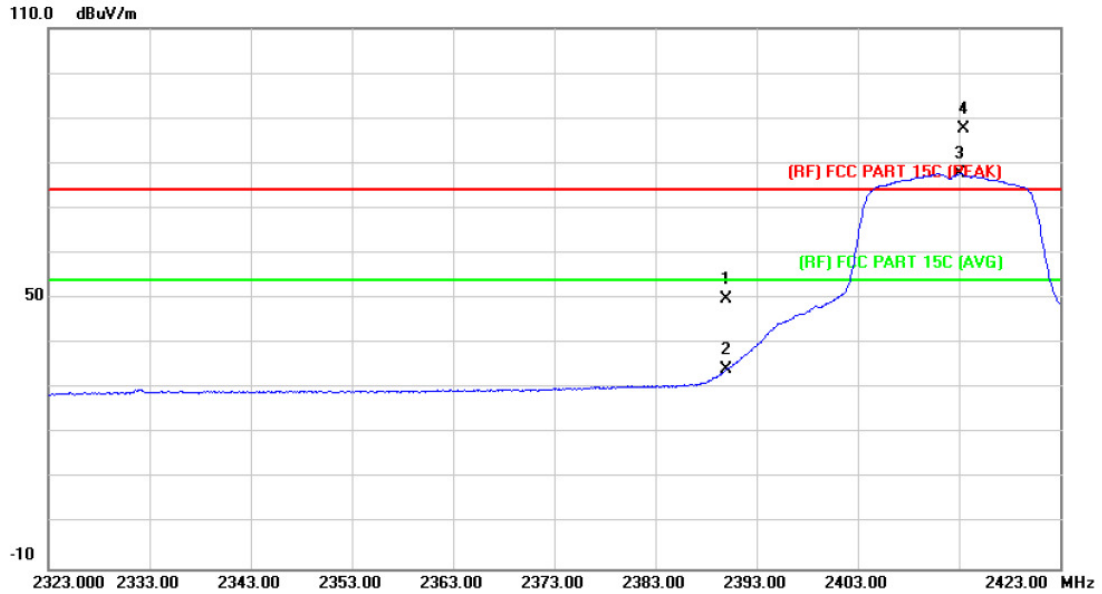

No.	Mk.	Freq.	Reading Level	Correct Factor	Measurement	Limit	Over	Detector
		MHz	dBuV	dB/m	dBuV/m	dBuV/m	dB	
1		2390.000	49.22	0.77	49.99	74.00	-24.01	peak
2		2390.000	33.38	0.77	34.15	54.00	-19.85	AVG
3	*	2413.100	76.86	0.86	77.72	Fundamental Frequency		AVG
4	X	2413.500	86.88	0.86	87.74	Fundamental Frequency		peak

Emission Level= Read Level+ Correct Factor

EUT:	Smart LED Colorful Bulb	Model:	XM-JPLB1
Temperature:	25 °C	Relative Humidity:	55%
Test Voltage:	AC 120V/60Hz		
Ant. Pol.	Horizontal		
Test Mode:	TX N(HT20) Mode 2462MHz		
Remark:	N/A		

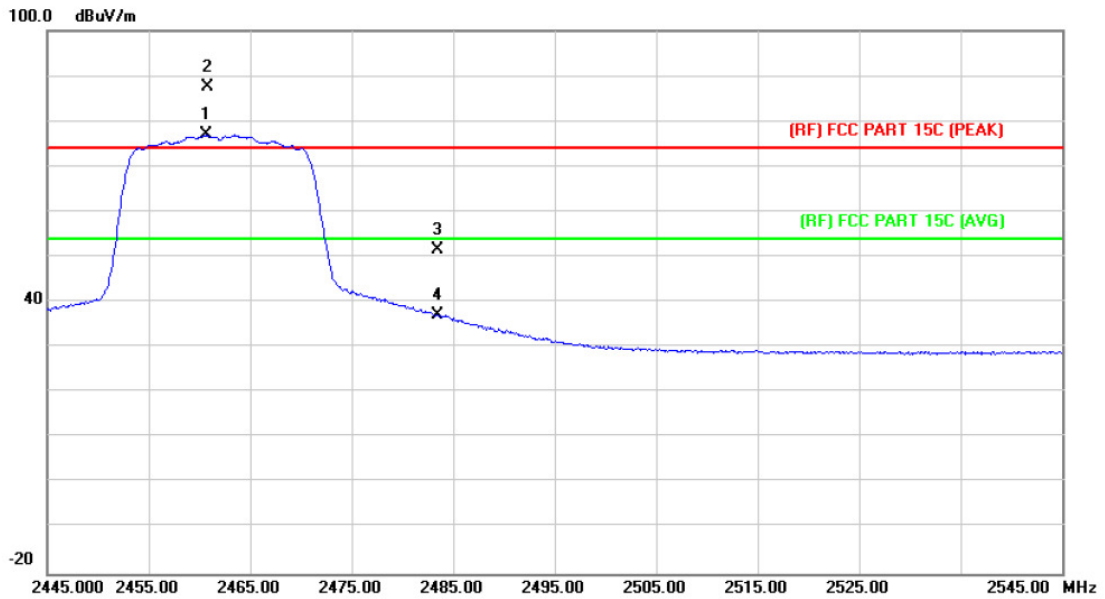

No.	Mk.	Freq. MHz	Reading Level dBuV	Correct Factor dB/m	Measure- ment dBuV/m	Limit dBuV/m	Over dB	Detector
1	*	2460.700	75.89	1.06	76.95	Fundamental Frequency		AVG
2	X	2460.800	86.36	1.06	87.42	Fundamental Frequency		peak
3		2483.500	50.50	1.17	51.67	74.00	-22.33	peak
4		2483.500	35.98	1.17	37.15	54.00	-16.85	AVG

Emission Level= Read Level+ Correct Factor

EUT:	Smart LED Colorful Bulb	Model:	XM-JPLB1
Temperature:	25 °C	Relative Humidity:	55%
Test Voltage:	AC 120V/60Hz		
Ant. Pol.	Vertical		
Test Mode:	TX N(HT20) Mode 2462MHz		
Remark:	N/A		

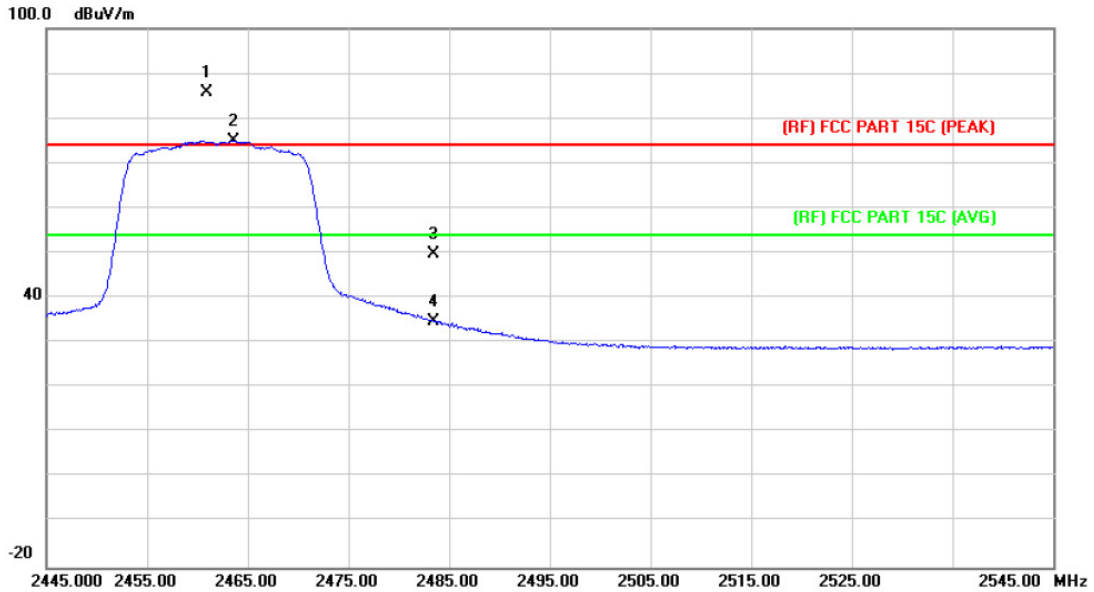

No.	Mk.	Freq.	Reading Level	Correct Factor	Measurement	Limit	Over	Detector
		MHz	dBuV	dB/m	dBuV/m	dBuV/m	dB	
1	X	2460.900	84.60	1.06	85.66	Fundamental Frequency		peak
2	*	2463.600	73.98	1.08	75.06	Fundamental Frequency		AVG
3		2483.500	48.59	1.17	49.76	74.00	-24.24	peak
4		2483.500	33.59	1.17	34.76	54.00	-19.24	AVG

Emission Level= Read Level+ Correct Factor

EUT:	Smart LED Colorful Bulb	Model:	XM-JPLB1
Temperature:	25 °C	Relative Humidity:	55%
Test Voltage:	AC 120V/60Hz		
Ant. Pol.	Horizontal		
Test Mode:	TX N(HT40) Mode 2422MHz		
Remark:	N/A		

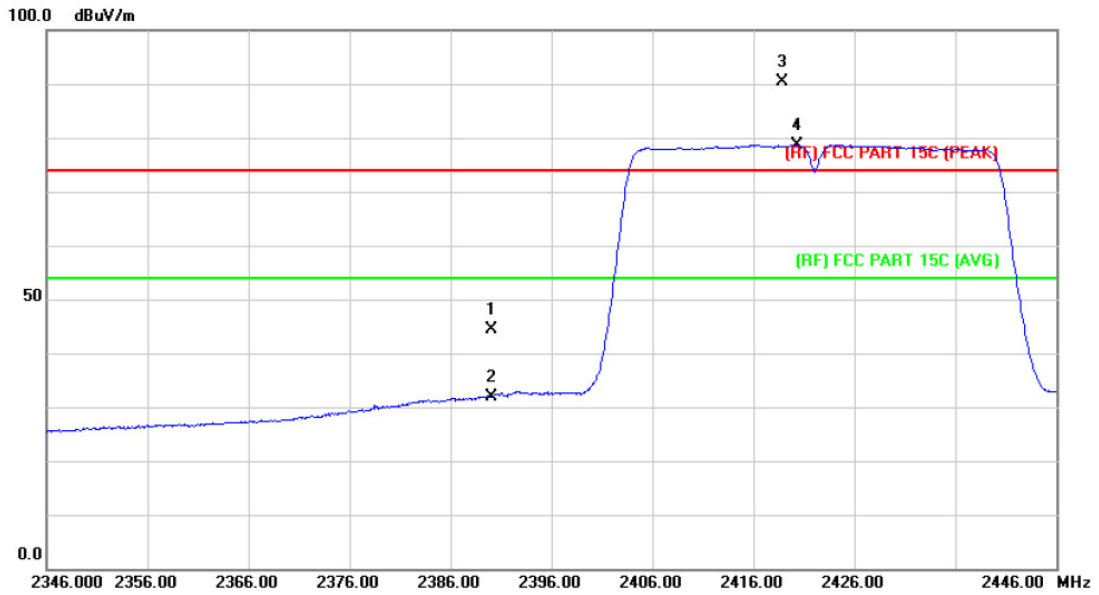

No.	Mk.	Freq. MHz	Reading Level dBuV	Correct Factor dB/m	Measure- ment dBuV/m	Limit dBuV/m	Over dB	Detector
1		2390.000	43.61	0.77	44.38	74.00	-29.62	peak
2		2390.000	31.21	0.77	31.98	54.00	-22.02	AVG
3	X	2418.800	89.45	0.89	90.34	Fundamental Frequency		peak
4	*	2420.300	77.77	0.89	78.66	Fundamental Frequency		AVG

Emission Level= Read Level+ Correct Factor

EUT:	Smart LED Colorful Bulb	Model:	XM-JPLB1
Temperature:	25 °C	Relative Humidity:	55%
Test Voltage:	AC 120V/60Hz		
Ant. Pol.	Vertical		
Test Mode:	TX N(HT40) Mode 2422MHz		
Remark:	N/A		

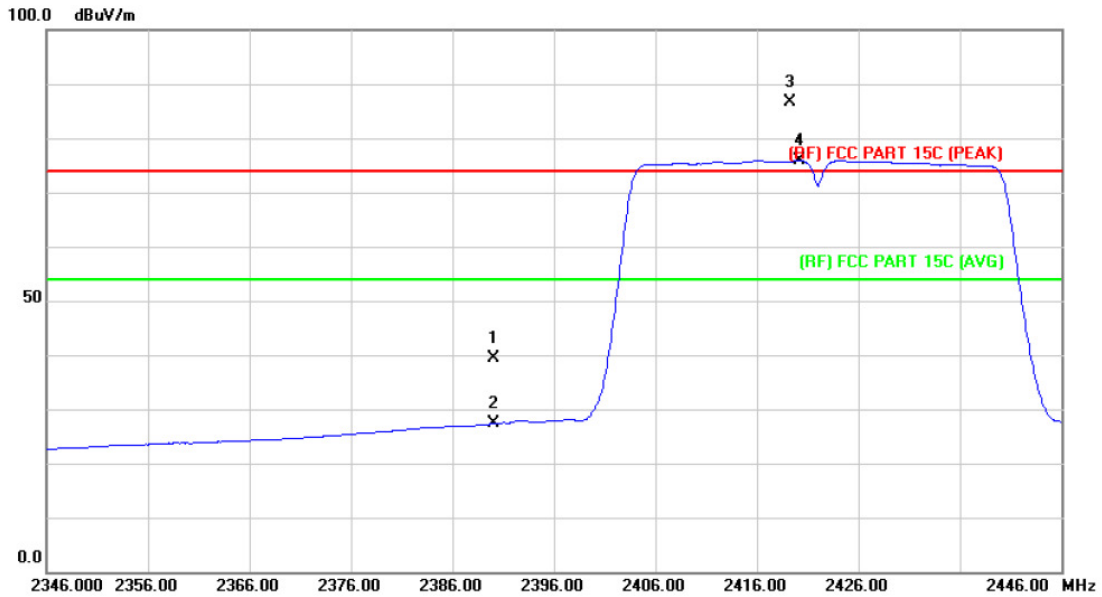

No.	Mk.	Freq. MHz	Reading Level dBuV	Correct Factor dB/m	Measure- ment dBuV/m	Limit dBuV/m	Over dB	Detector
1		2390.000	38.60	0.77	39.37	74.00	-34.63	peak
2		2390.000	26.57	0.77	27.34	54.00	-26.66	AVG
3	X	2419.300	85.72	0.89	86.61	Fundamental Frequency		peak
4	*	2420.200	75.01	0.89	75.90	Fundamental Frequency		AVG

Emission Level= Read Level+ Correct Factor

EUT:	Smart LED Colorful Bulb	Model:	XM-JPLB1
Temperature:	25 °C	Relative Humidity:	55%
Test Voltage:	AC 120V/60Hz		
Ant. Pol.	Horizontal		
Test Mode:	TX N(HT40) Mode 2452MHz		
Remark:	N/A		

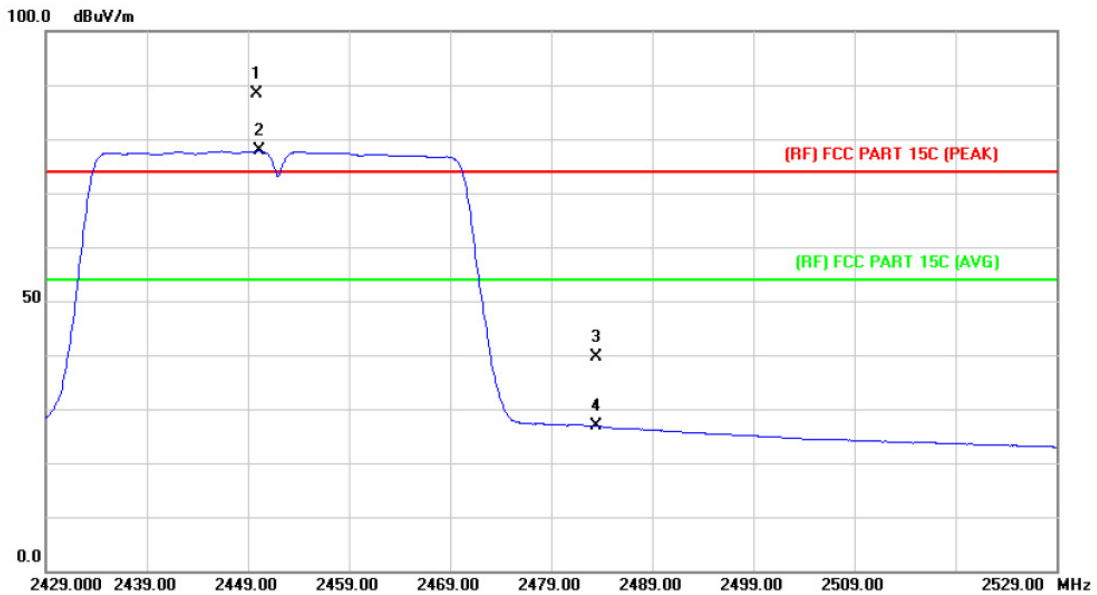

No.	Mk.	Freq. MHz	Reading Level dBuV	Correct Factor dB/m	Measure- ment dBuV/m	Limit dBuV/m	Over dB	Detector
1	X	2449.900	87.33	1.02	88.35	Fundamental Frequency		peak
2	*	2450.100	76.74	1.02	77.76	Fundamental Frequency		AVG
3		2483.500	38.50	1.17	39.67	74.00	-34.33	peak
4		2483.500	25.70	1.17	26.87	54.00	-27.13	AVG

Emission Level= Read Level+ Correct Factor

EUT:	Smart LED Colorful Bulb	Model:	XM-JPLB1
Temperature:	25 °C	Relative Humidity:	55%
Test Voltage:	AC 120V/60Hz		
Ant. Pol.	Vertical		
Test Mode:	TX N(HT40) Mode 2452MHz		
Remark:	N/A		

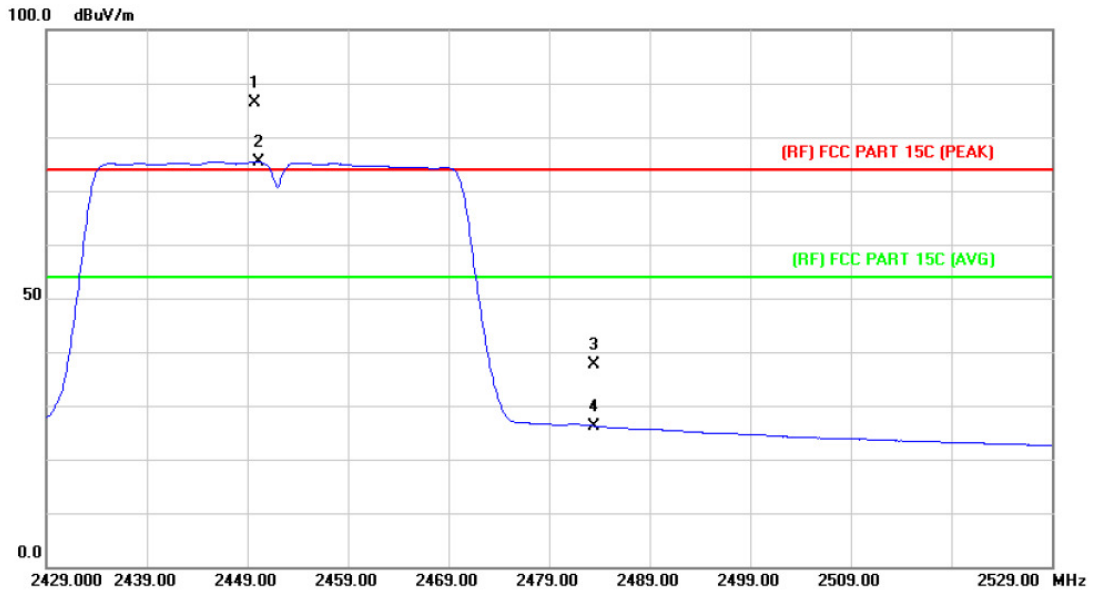

No.	Mk.	Freq.	Reading Level	Correct Factor	Measurement	Limit	Over	Detector
		MHz	dBuV	dB/m	dBuV/m	dBuV/m	dB	
1	X	2449.700	85.30	1.02	86.32	Fundamental Frequency		peak
2	*	2450.200	74.34	1.02	75.36	Fundamental Frequency		AVG
3		2483.500	36.46	1.17	37.63	74.00	-36.37	peak
4		2483.500	25.07	1.17	26.24	54.00	-27.76	AVG

Emission Level= Read Level+ Correct Factor

(2) Conducted Test

EUT:	Smart LED Colorful Bulb	Model:	XM-JPLB1
Temperature:	25 °C	Relative Humidity:	55%
Test Voltage:	AC 120V/60Hz		
Test Mode:	TX B Mode 2412MHz / TX B Mode 2462MHz		
Remark:	The EUT is programed in continuously transmitting mode		

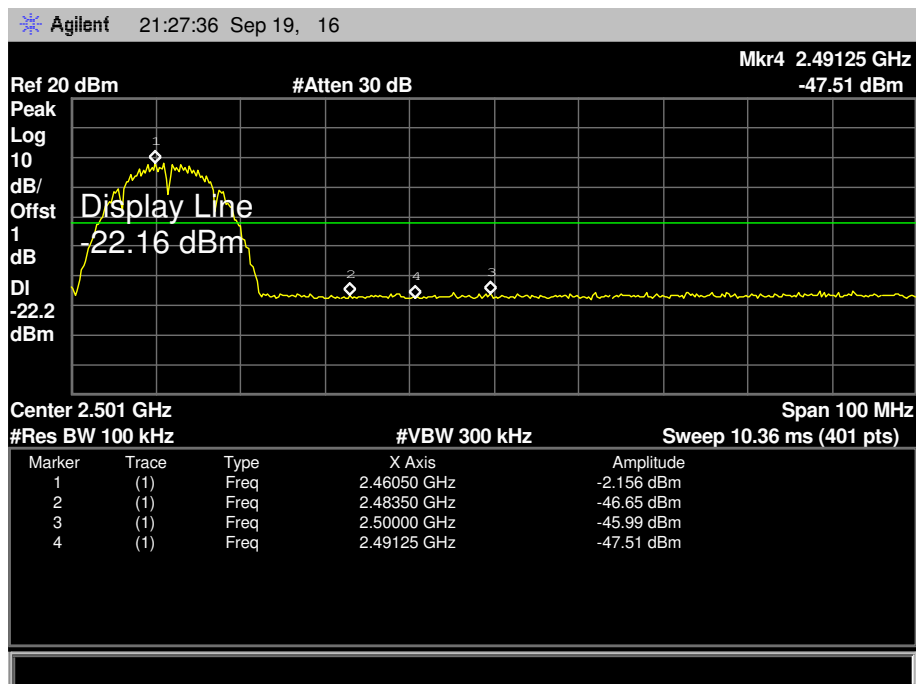
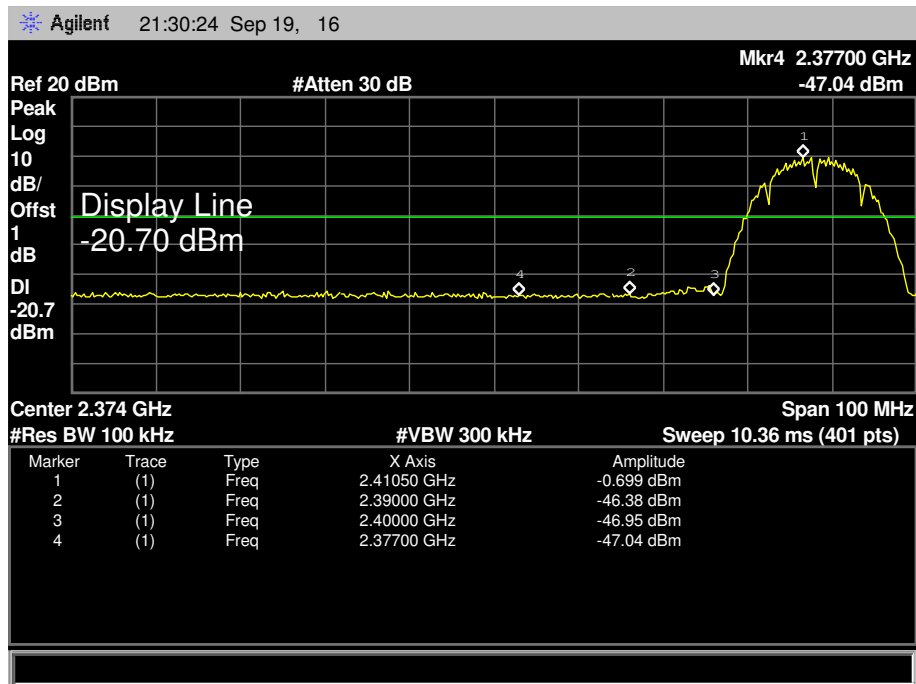

EUT:	Smart LED Colorful Bulb	Model:	XM-JPLB1
Temperature:	25 °C	Relative Humidity:	55%
Test Voltage:	AC 120V/60Hz		
Test Mode:	TX G Mode 2412MHz / TX G Mode 2462MHz		
Remark:	The EUT is programed in continuously transmitting mode		

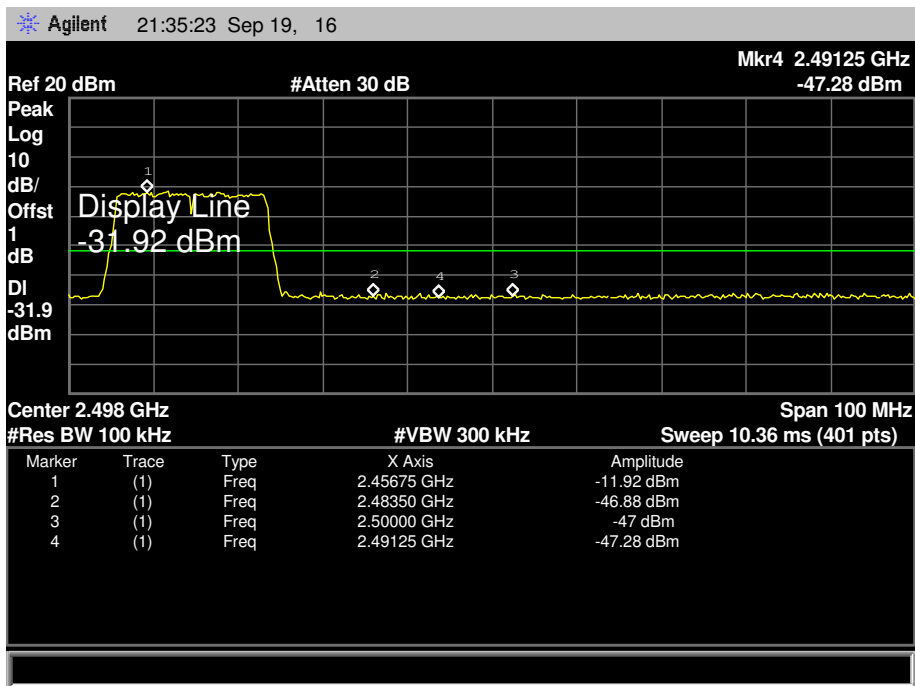
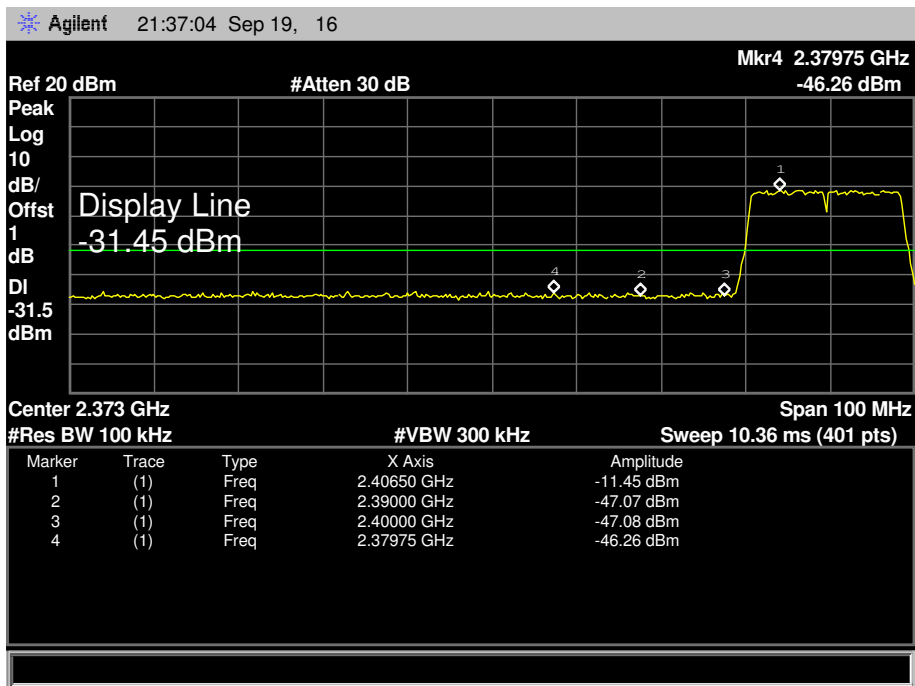

EUT:	Smart LED Colorful Bulb	Model:	XM-JPLB1
Temperature:	25 °C	Relative Humidity:	55%
Test Voltage:	AC 120V/60Hz		
Test Mode:	TX N(HT20) Mode 2412MHz / TX N(HT20) Mode 2462MHz		
Remark:	The EUT is programed in continuously transmitting mode		

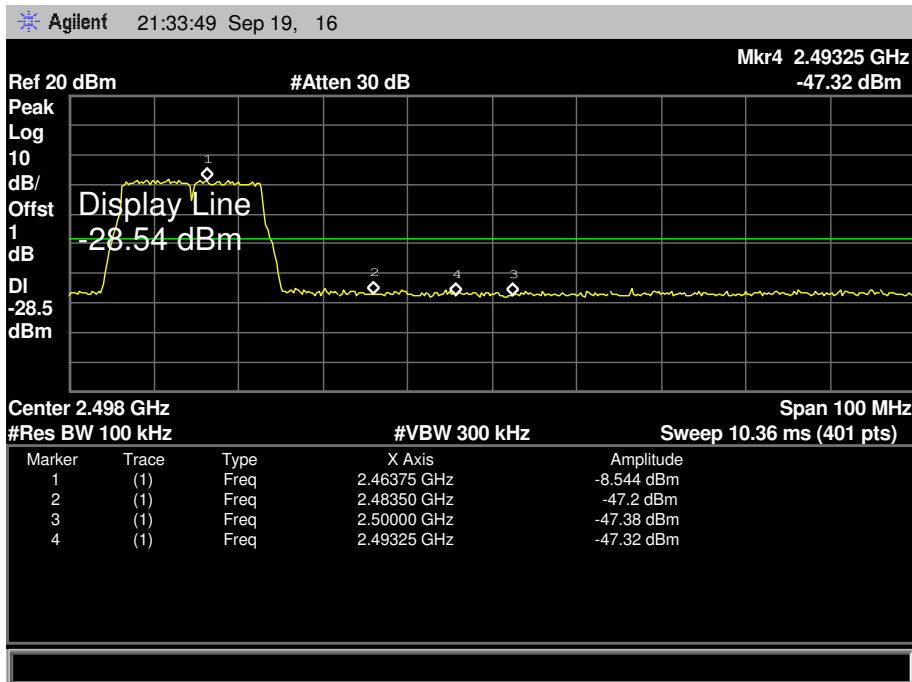
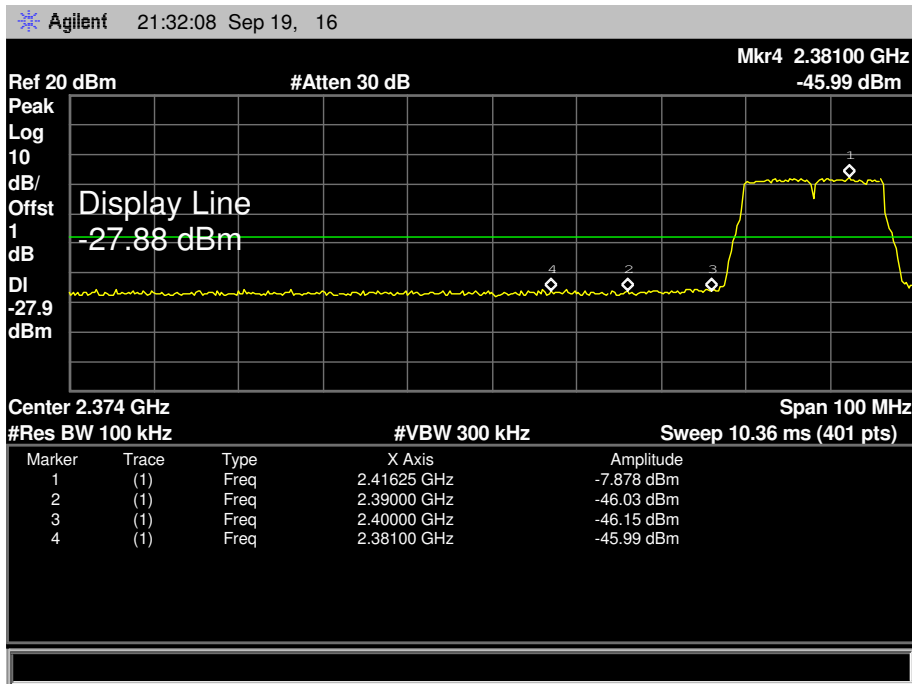

EUT:	Smart LED Colorful Bulb	Model:	XM-JPLB1
Temperature:	25 °C	Relative Humidity:	55%
Test Voltage:	AC 120V/60Hz		
Test Mode:	TX N(HT40) Mode 2422MHz / TX N(HT40) Mode 2452MHz		
Remark:	The EUT is programed in continuously transmitting mode		

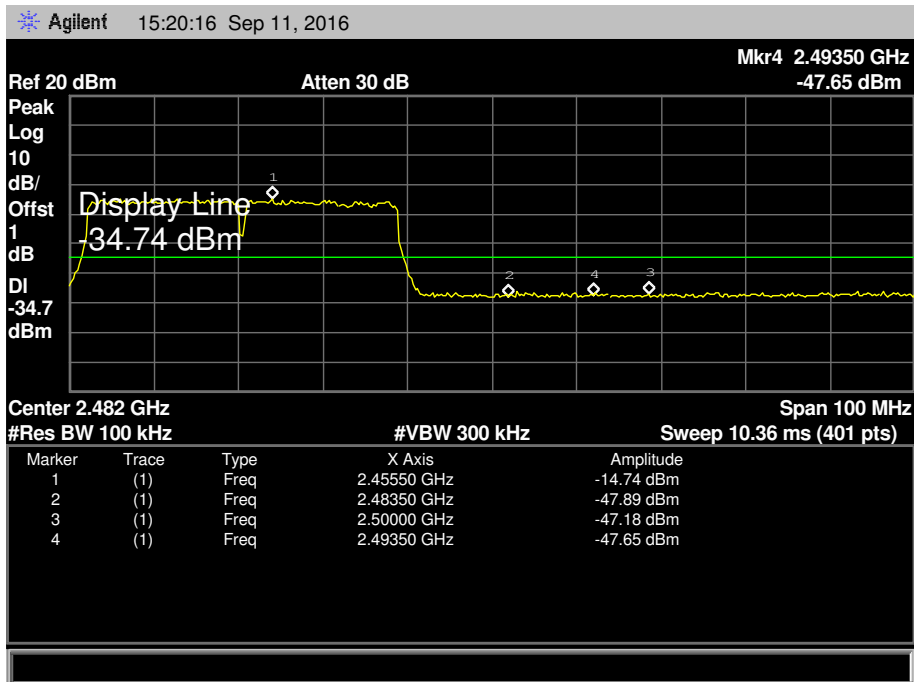
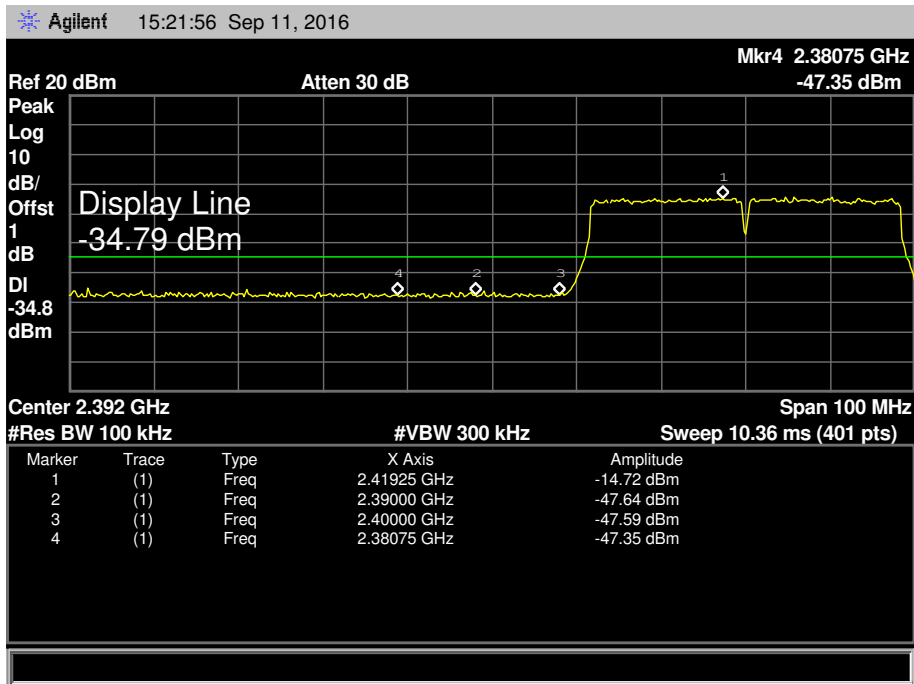

7. Bandwidth Test

7.1 Test Standard and Limit

7.1.1 Test Standard

FCC Part 15.247 (a)(2)

7.1.2 Test Limit

FCC Part 15 Subpart C(15.247)/RSS-210		
Test Item	Limit	Frequency Range(MHz)
Bandwidth	≥ 500 KHz (6dB bandwidth)	2400~2483.5

7.2 Test Setup

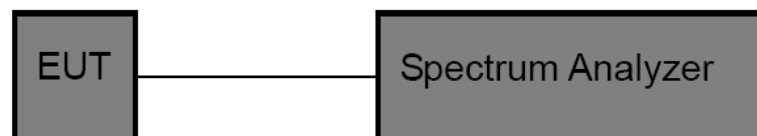

7.3 Test Procedure

- (1) The EUT was directly connected to the spectrum analyzer and antenna output port as show in the block diagram above.
- (2) The bandwidth is measured at an amplitude level reduced 6dB from the reference level. The reference level is the level of the highest amplitude signal observed from the transmitter at the fundamental frequency. Once the reference level is established, the equipment is conditioned with typical modulating signal to produce the worst –case (i.e the widest) bandwidth.
- (3) Measure the channel separation the spectrum analyzer was set to Resolution Bandwidth:100 kHz, and Video Bandwidth:300 kHz, Detector: Peak, Sweep Time set auto.

7.4 EUT Operating Condition

The EUT was set to continuously transmitting in each mode and low, middle and high channel for the test.

7.5 Test Data

EUT:	Smart LED Colorful Bulb	Model:	XM-JPLB1
Temperature:	25 °C	Relative Humidity:	55%
Test Voltage:	AC 120V/60Hz		
Test Mode:	TX 802.11B Mode		
Channel frequency (MHz)	6dB Bandwidth (MHz)	99% Bandwidth (MHz)	Limit (MHz)
2412	10.112	14.1599	≥0.5
2437	9.988	14.2788	
2462	9.765	14.2831	
802.11B Mode			
2412 MHz			
<p>Agilent 05:22:11 Sep 11, 2016</p> <p>Ref 20 dBm Atten 30 dB</p> <p>#Peak Log 10 dB/Offst 1 dB</p> <p>Center 2.412000000 GHz</p> <p>Center 2.412 GHz Span 20 MHz</p> <p>#Res BW 100 kHz #VBW 300 kHz Sweep 4 ms (401 pts)</p> <p>Occupied Bandwidth 14.1599 MHz Occ BW % Pwr 99.00 % x dB -6.00 dB</p> <p>Transmit Freq Error -28.276 kHz x dB Bandwidth 10.112 MHz</p>			

802.11B Mode

2437 MHz

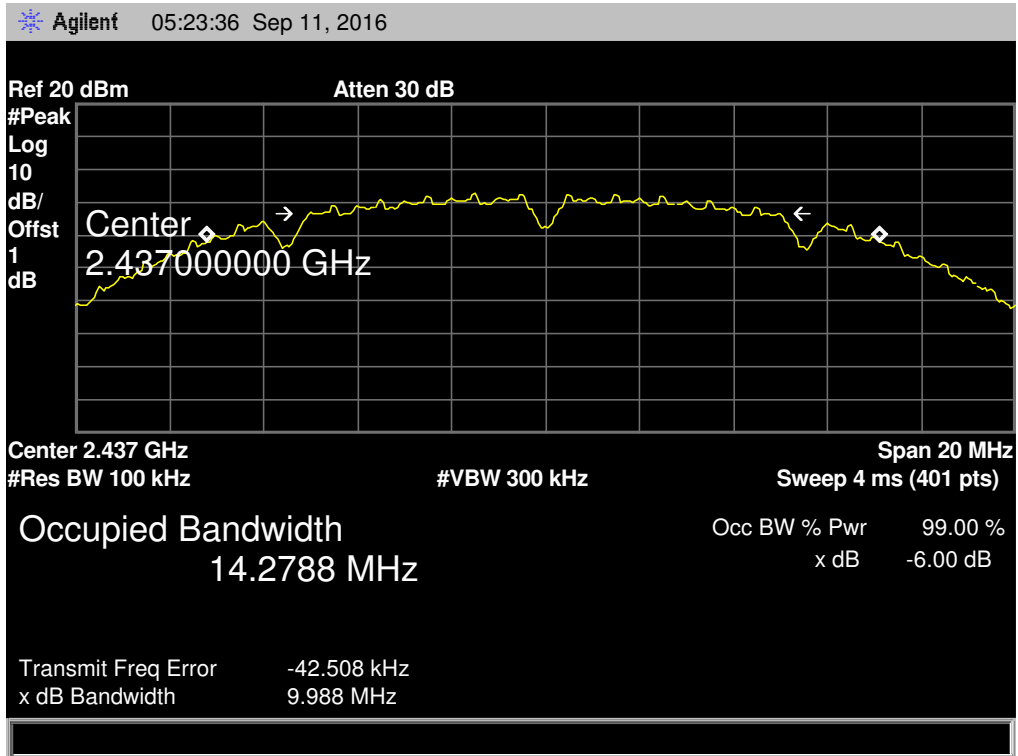

802.11B Mode

2462 MHz

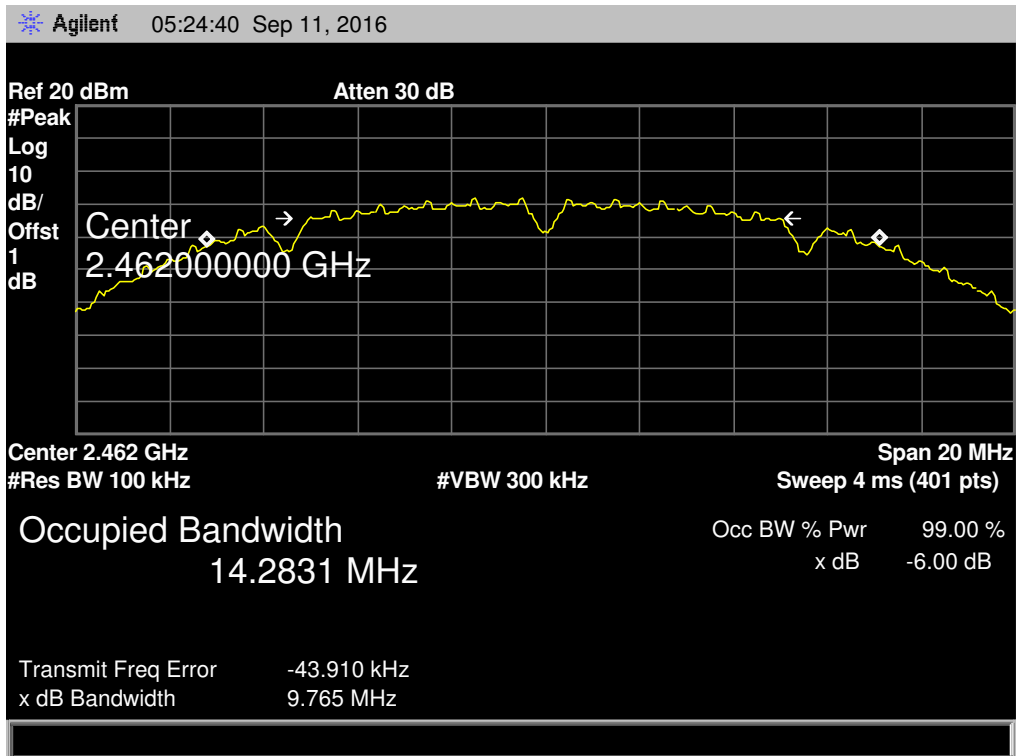

EUT:	Smart LED Colorful Bulb	Model:	XM-JPLB1
Temperature:	25 °C	Relative Humidity:	55%
Test Voltage:	AC 120V/60Hz		
Test Mode:	TX 802.11G Mode		
Channel frequency (MHz)	6dB Bandwidth (MHz)	99% Bandwidth (MHz)	Limit (MHz)
2412	16.612	16.5431	>=0.5
2437	16.601	16.4828	
2462	16.611	16.5433	

802.11G Mode

2412 MHz

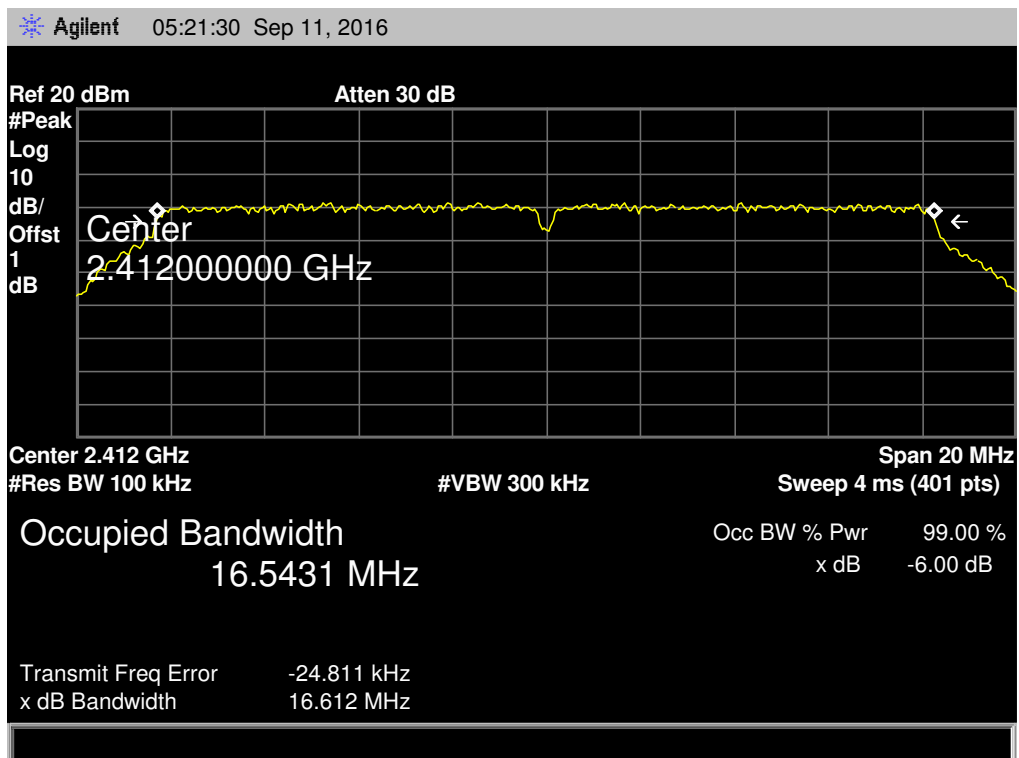

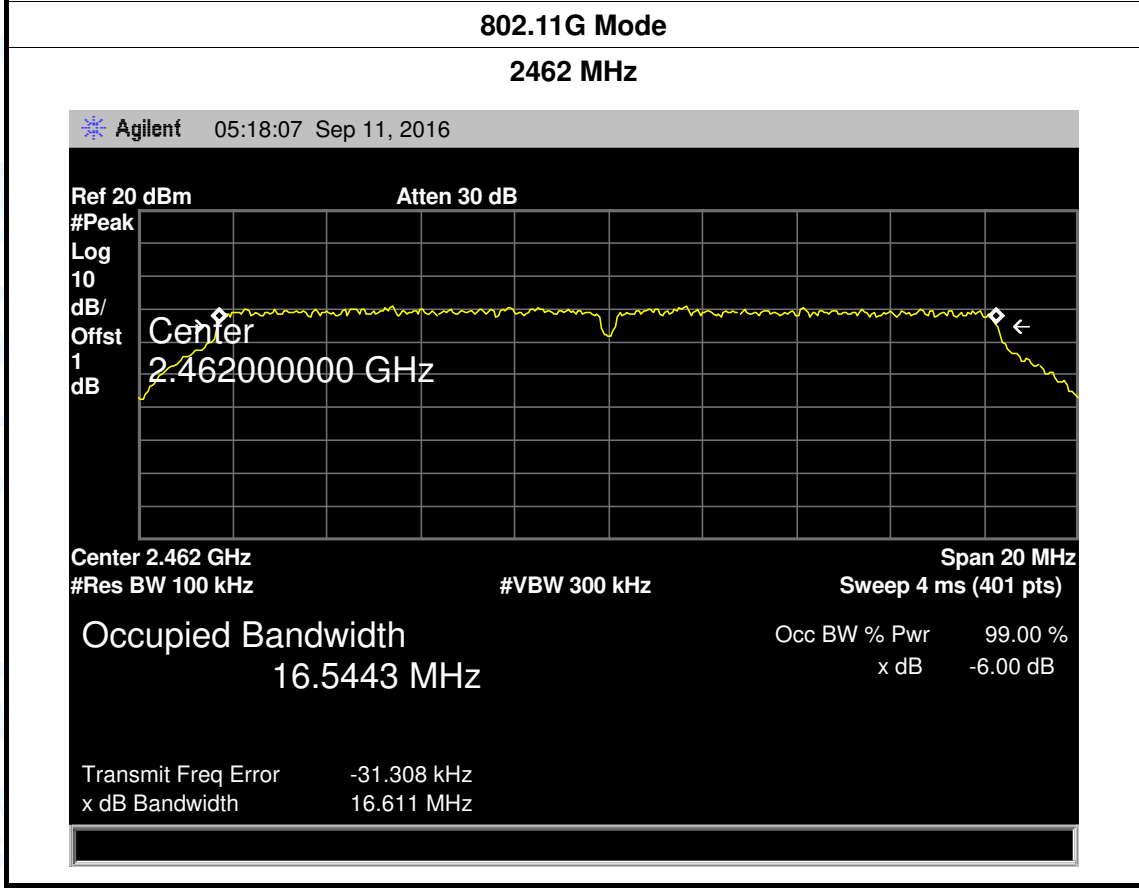
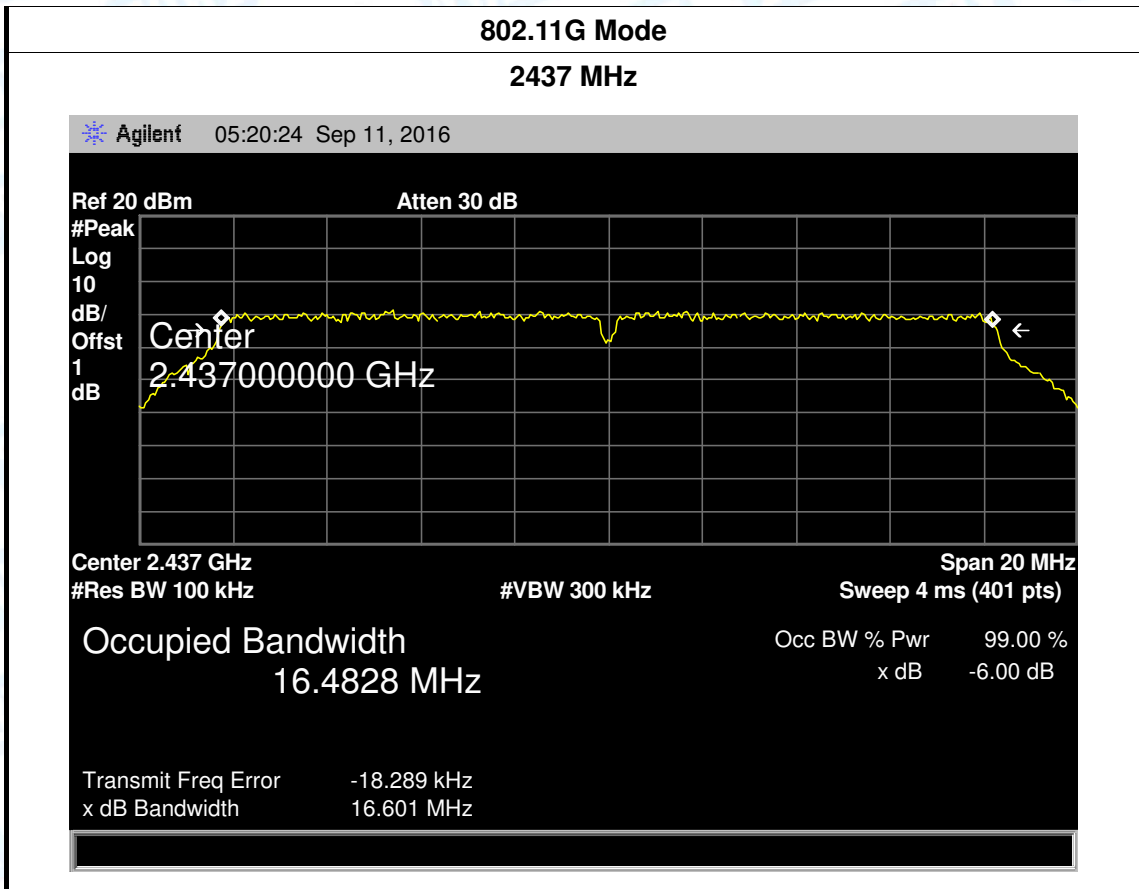

EUT:	Smart LED Colorful Bulb	Model:	XM-JPLB1
Temperature:	25 °C	Relative Humidity:	55%
Test Voltage:	AC 120V/60Hz		
Test Mode:	TX 802.11N(HT20) Mode		
Channel frequency (MHz)	6dB Bandwidth (MHz)	99% Bandwidth (MHz)	Limit (MHz)
2412	17.818	17.6233	≥0.5
2437	17.830	17.6259	
2462	17.829	17.6389	

802.11N(HT20) Mode

2412 MHz

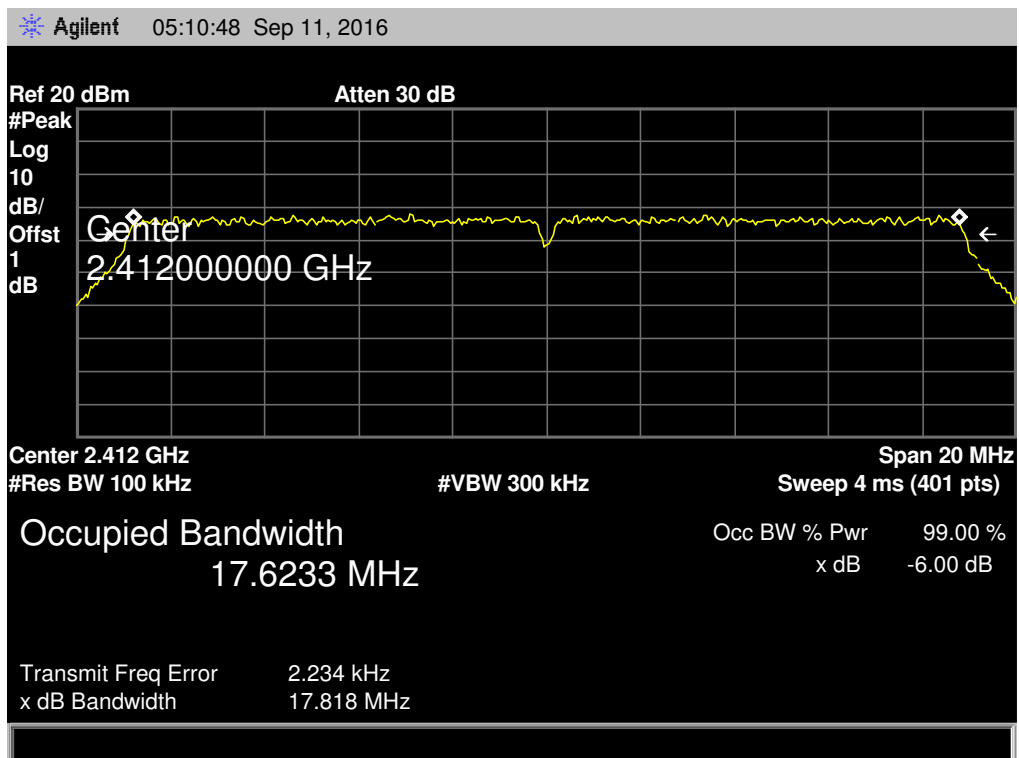

802.11N(HT20) Mode

2437 MHz

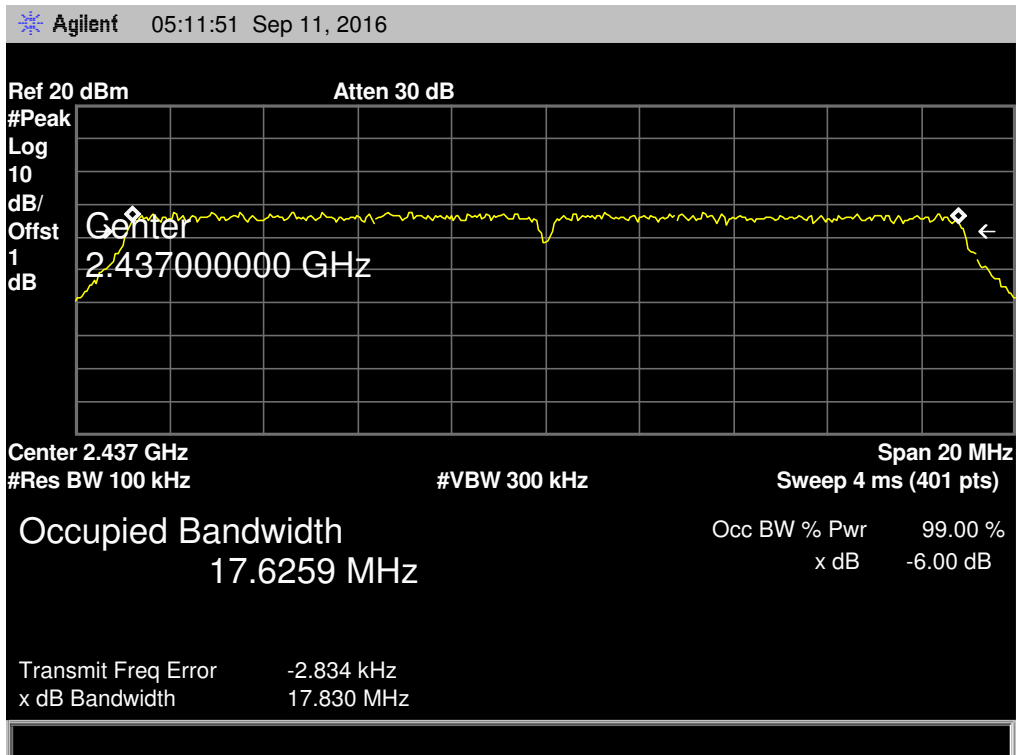

802.11N(HT20) Mode

2462 MHz

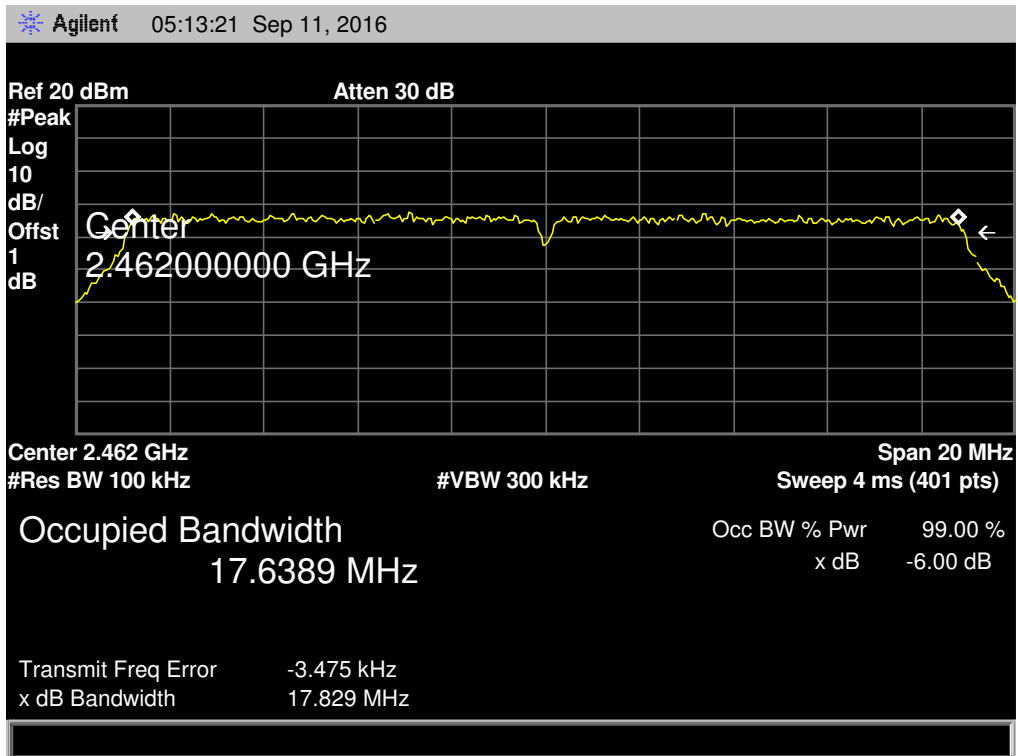

EUT:	Smart LED Colorful Bulb	Model:	XM-JPLB1
Temperature:	25 °C	Relative Humidity:	55%
Test Voltage:	AC 120V/60Hz		
Test Mode:	TX 802.11N(HT40) Mode		
Channel frequency (MHz)	6dB Bandwidth (MHz)	99% Bandwidth (MHz)	Limit (MHz)
2422	36.530	36.0115	≥0.5
2437	36.518	35.9964	
2452	36.528	36.0185	

802.11N(HT20) Mode

2422 MHz

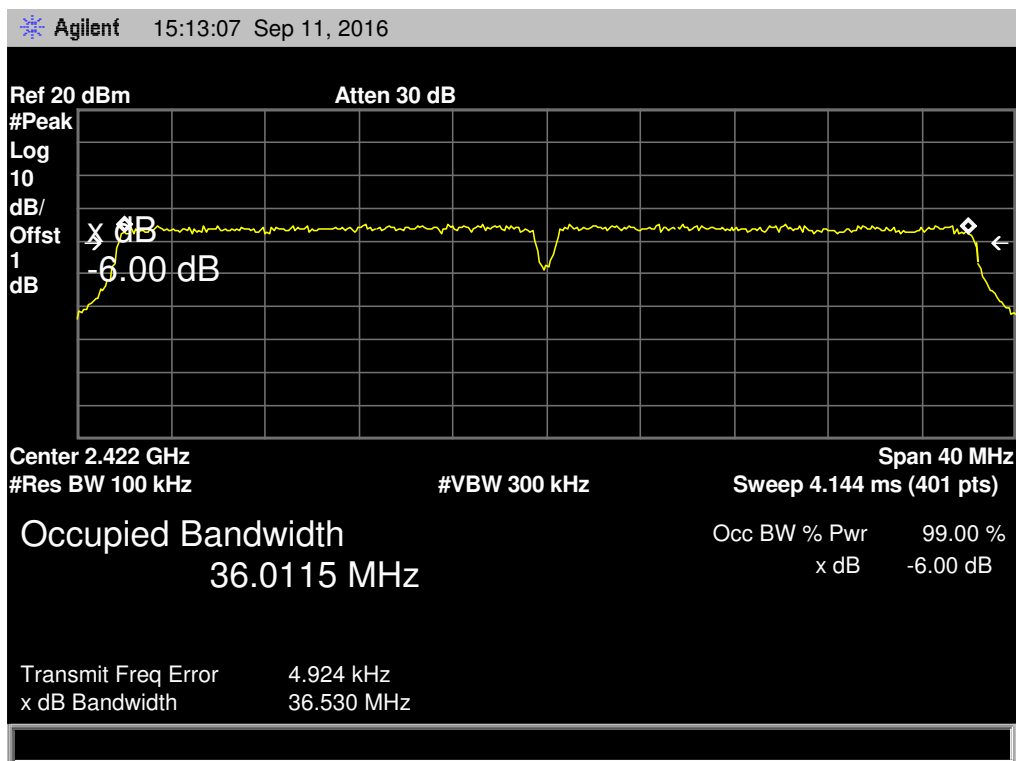

802.11N(HT40) Mode

2437 MHz

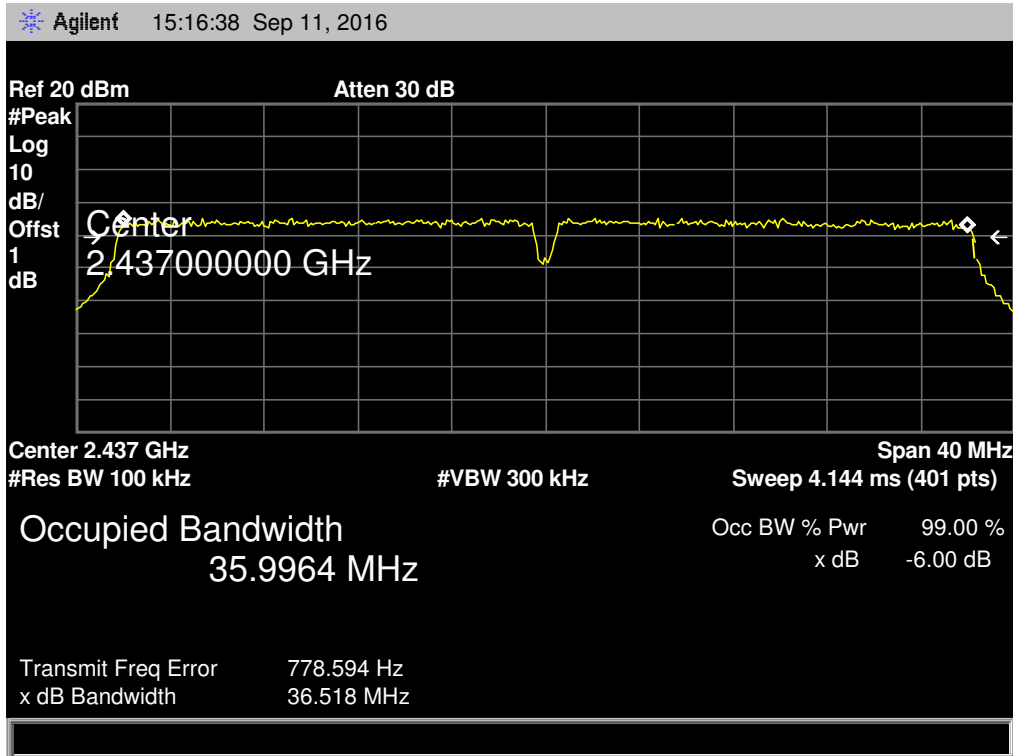

802.11N(HT40) Mode

2452 MHz

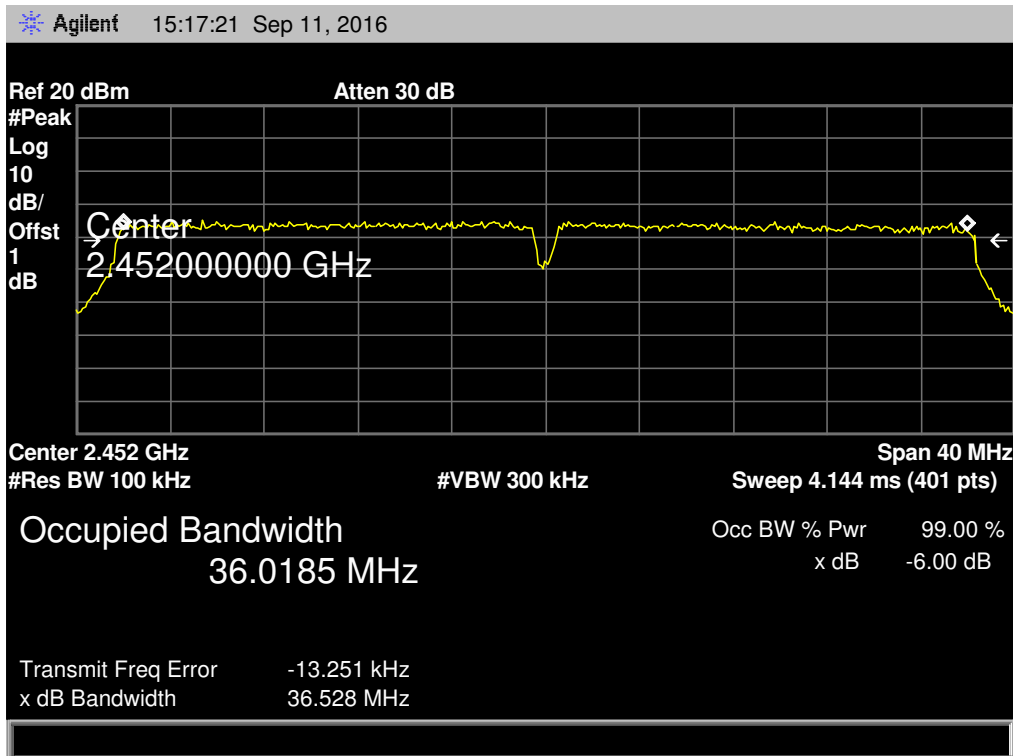

8. Peak Output Power Test

8.1 Test Standard and Limit

8.1.1 Test Standard

FCC Part 15.247 (b)

8.1.2 Test Limit

FCC Part 15 Subpart C(15.247)/RSS-210		
Test Item	Limit	Frequency Range(MHz)
Peak Output Power	1 Watt or 30 dBm	2400~2483.5

8.2 Test Setup

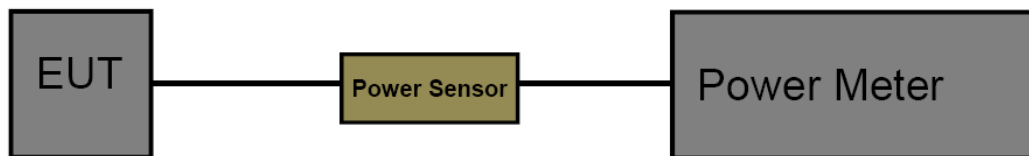

8.3 Test Procedure

The measurement is according to section 9.1.2 of KDB 558074 D01 DTS Meas Guidance v03r05.

The EUT was connected to RF power meter via a broadband power sensor as show the block above. The power sensor video bandwidth is greater than or equal to the DTS bandwidth of the equipment.

8.4 EUT Operating Condition

The EUT was set to continuously transmitting in the max power during the test.

8.5 Test Data

EUT:	Smart LED Colorful Bulb	Model Name :	XM-JPLB1
Temperature:	25 °C	Relative Humidity:	55%
Test Voltage:	AC 120V/60Hz		
Mode	Channel frequency (MHz)	Test Result (dBm)	Limit (dBm)
802.11b	2412	8.42	30
	2437	8.53	
	2462	8.51	
802.11g	2412	8.13	
	2437	8.20	
	2462	8.14	
802.11n (HT20)	2412	7.98	
	2437	7.99	
	2462	7.89	
802.11n (HT40)	2422	7.42	
	2437	7.38	
	2452	7.29	
Result: PASS			

Duty Cycle		
Mode	Channel frequency (MHz)	Test Result
802.11b	2412	>98%
	2437	
	2462	
802.11g	2412	
	2437	
	2462	
802.11n (HT20)	2412	
	2437	
	2462	
802.11n (HT40)	2422	
	2437	
	2452	
Please see below plots		

802.11 B Mode 2412 MHz

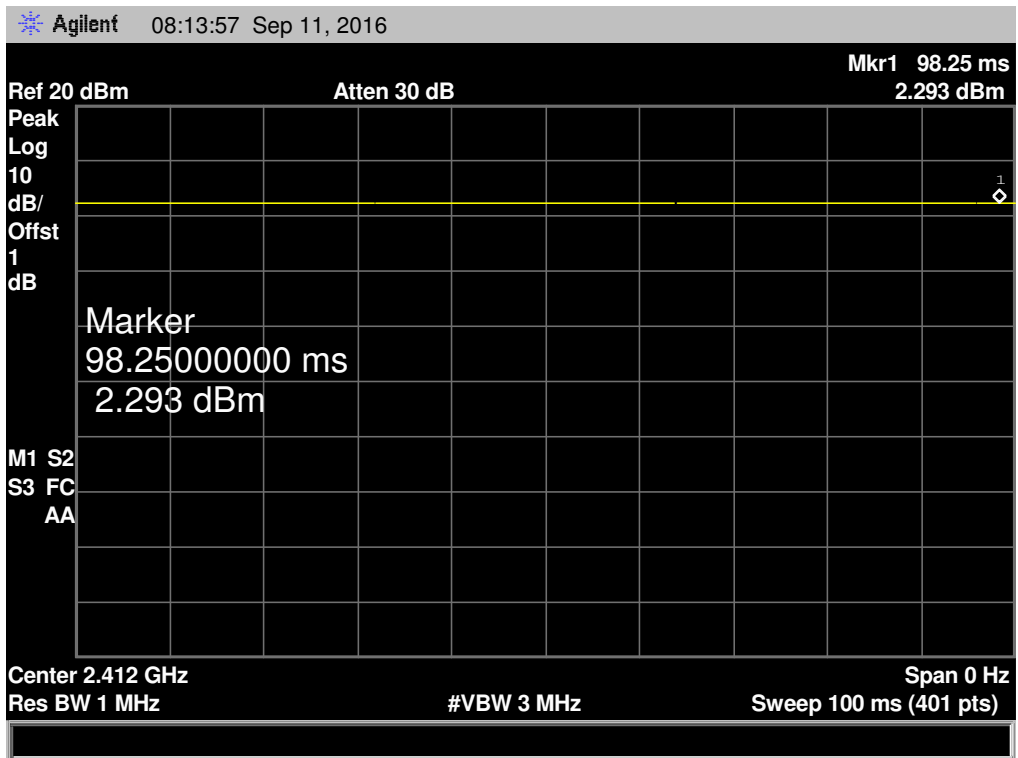

802.11 G Mode 2412MHz

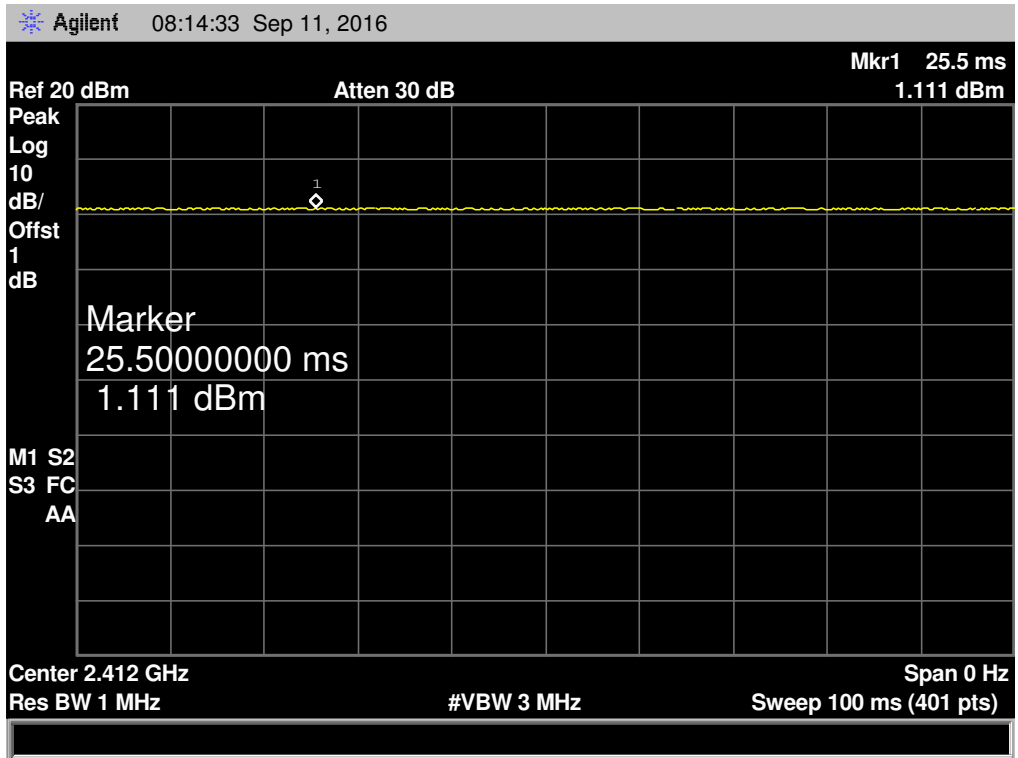

802.11 N(HT20) Mode 2412 MHz

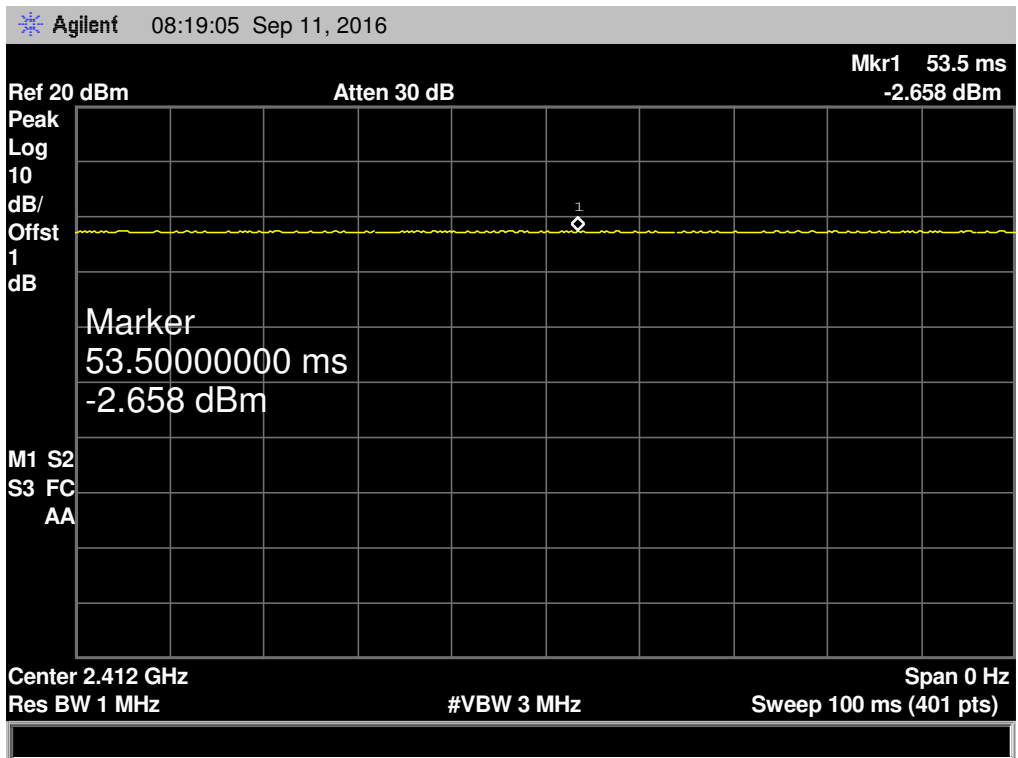

802.11 N(HT40) Mode 2422 MHz

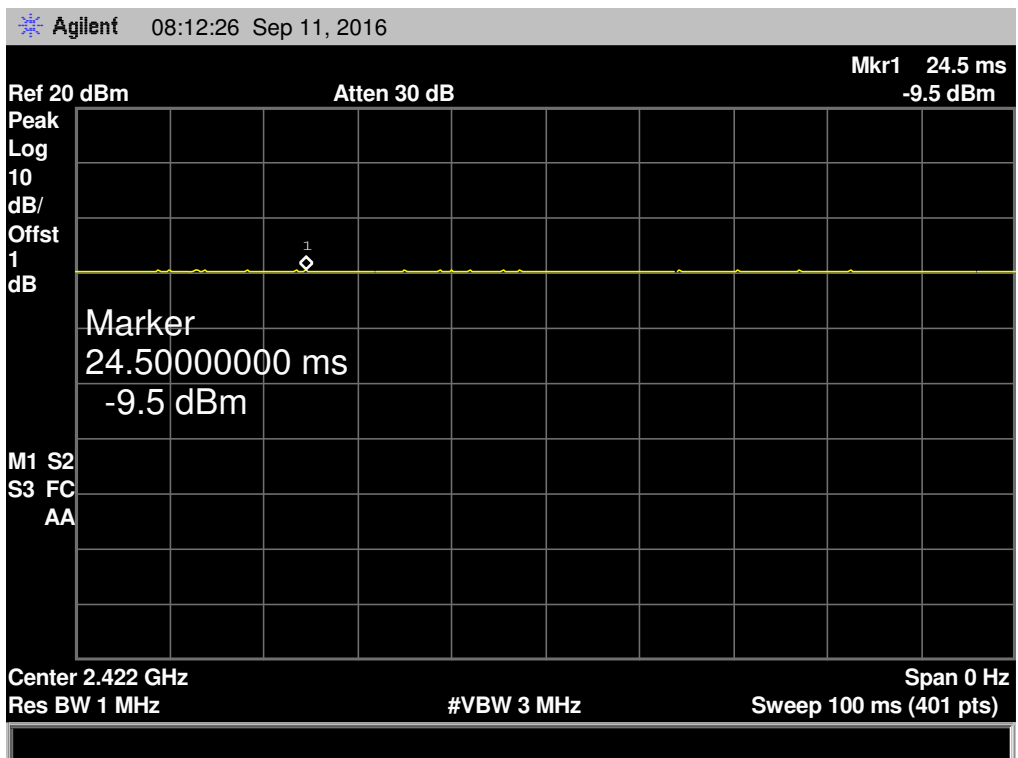

9. Power Spectral Density Test

9.1 Test Standard and Limit

9.1.1 Test Standard

FCC Part 15.247 (e)

9.1.2 Test Limit

FCC Part 15 Subpart C(15.247)		
Test Item	Limit	Frequency Range(MHz)
Power Spectral Density	8dBm(in any 3 kHz)	2400~2483.5

9.2 Test Setup

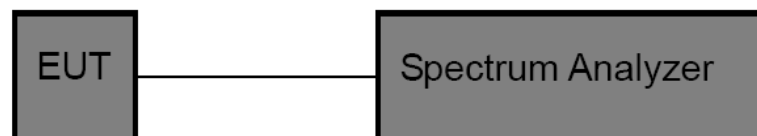

9.3 Test Procedure

The EUT was directly connected to the Spectrum Analyzer and antenna output port as show in the block diagram above. The measurement according to section 10.2 of KDB 558074 D01 DTS Meas Guidance v03r05.

- (1) The EUT was directly connected to the spectrum analyzer and antenna output port as show in the block diagram above.
- (2) Set analyser center frequency to DTS channel center frequency.
- (3) Set the span to 1.5 times the DTS bandwidth.
- (4) Set the RBW to: 3 kHz
- (5) Set the VBW to: 10 kHz
- (6) Detector: peak
- (7) Sweep time: auto
- (8) Allow trace to fully stabilize. Then use the peak marker function to determine the maximum amplitude level.

9.4 EUT Operating Condition

The EUT was set to continuously transmitting in each mode and low, middle and high channel for the test.

9.5 Test Data

EUT:	Smart LED Colorful Bulb	Model:	XM-JPLB1
Temperature:	25 °C	Relative Humidity:	55%
Test Voltage:	AC 120V/60Hz		
Test Mode:	TX 802.11B Mode		
Channel Frequency (MHz)	Power Density (3 kHz/dBm)	Limit (dBm)	
2412	-25.00	8	
2437	-25.76		
2462	-26.69		

802.11B Mode

2412 MHz

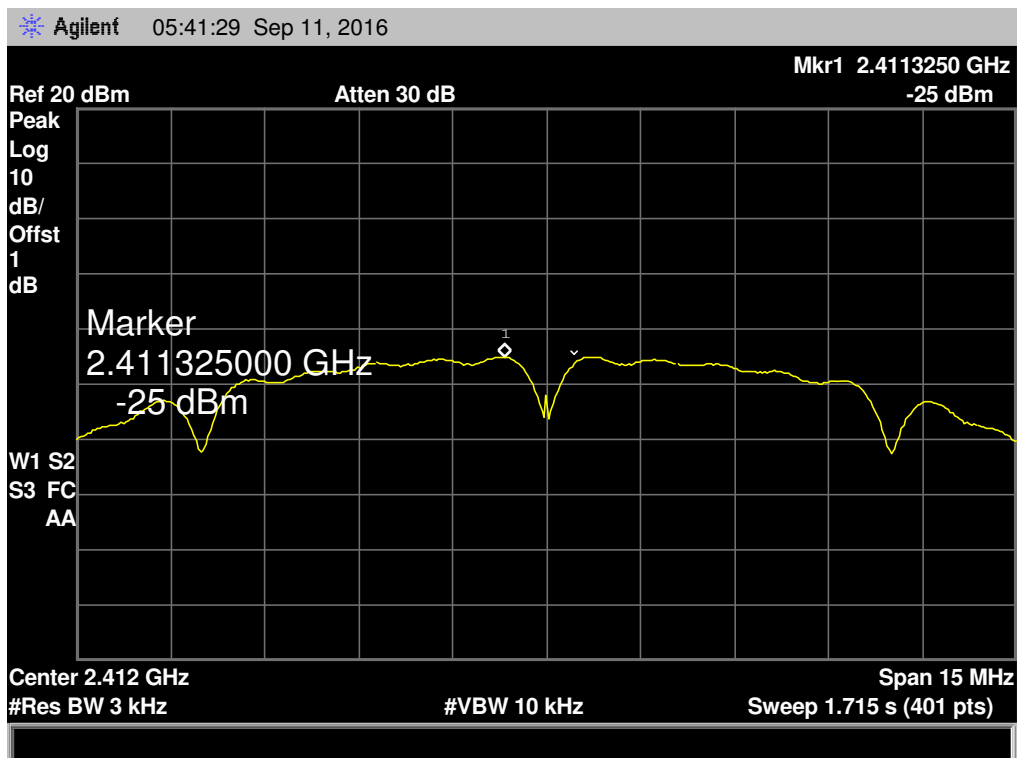

802.11B Mode

2437 MHz

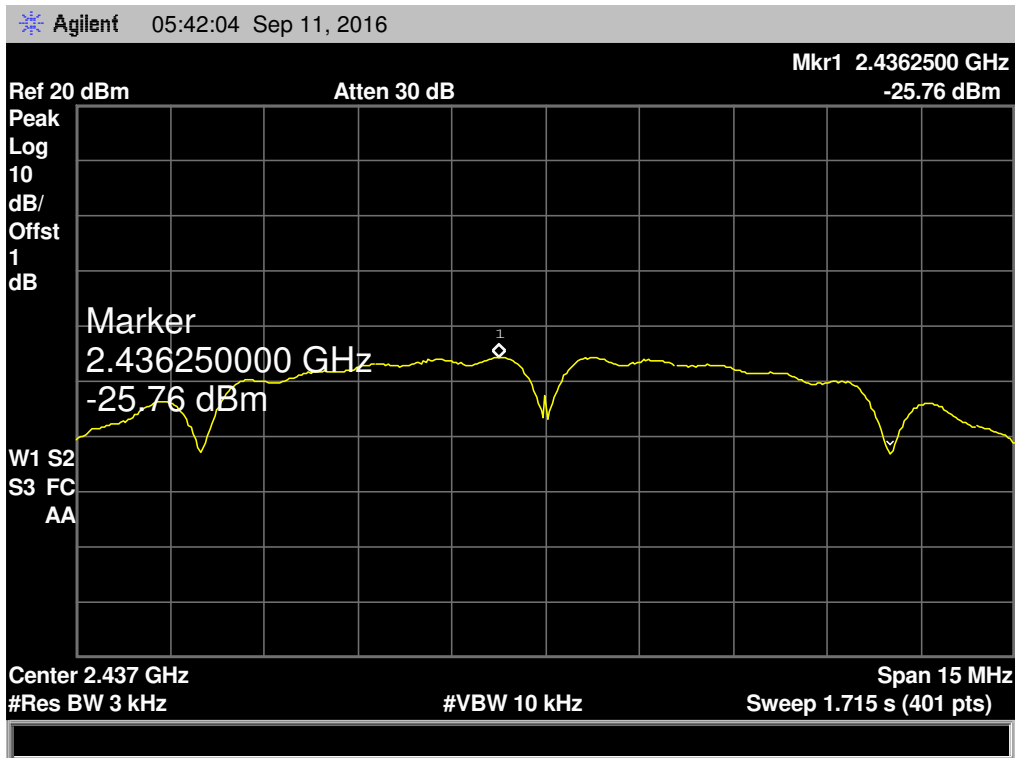

802.11B Mode

2462 MHz

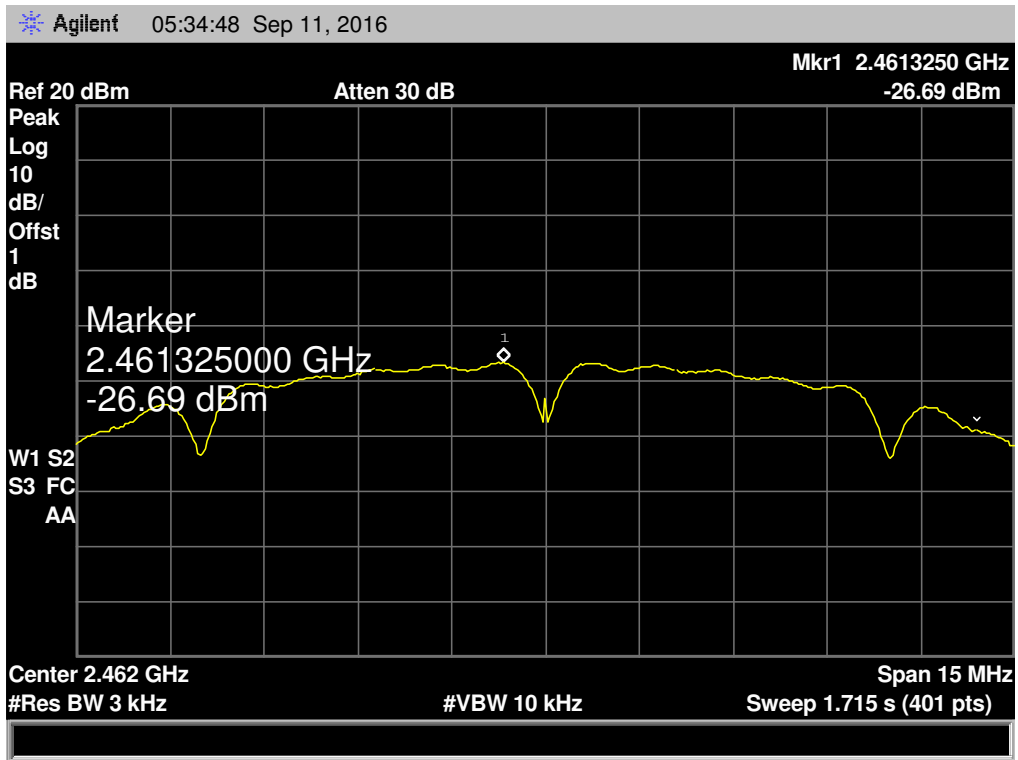

EUT:	Smart LED Colorful Bulb	Model:	XM-JPLB1
Temperature:	25 °C	Temperature:	25 °C
Test Voltage:	AC 120V/60Hz		
Test Mode:	TX 802.11G Mode		
Channel Frequency (MHz)	Power Density (3 kHz/dBm)	Limit (dBm)	
2412	-26.26	8	
2437	-25.20		
2462	-25.56		

802.11G Mode

2412 MHz

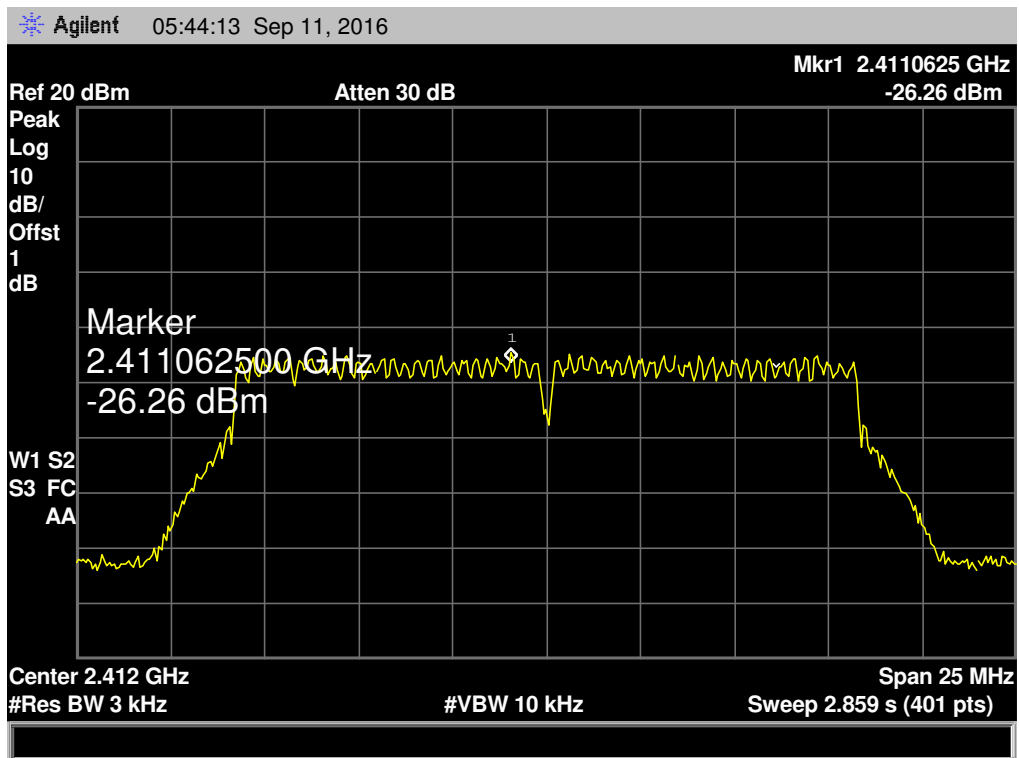

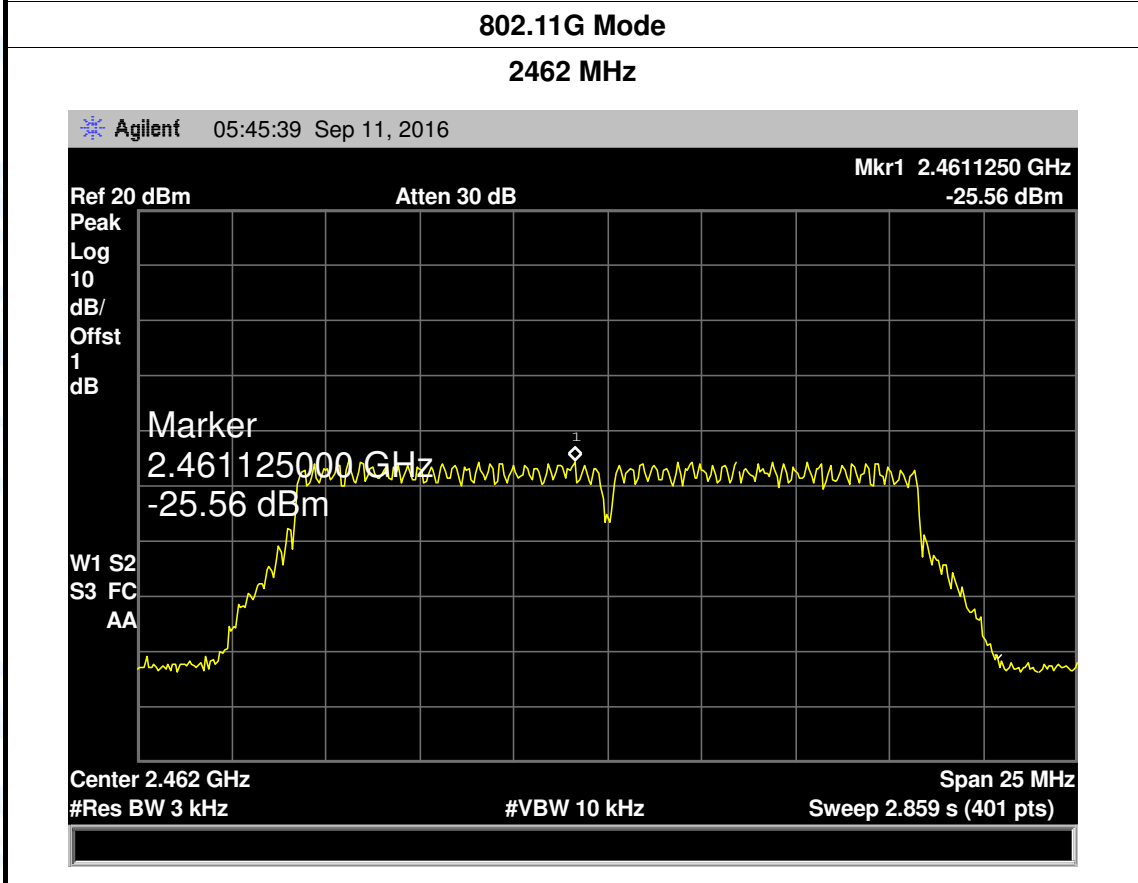
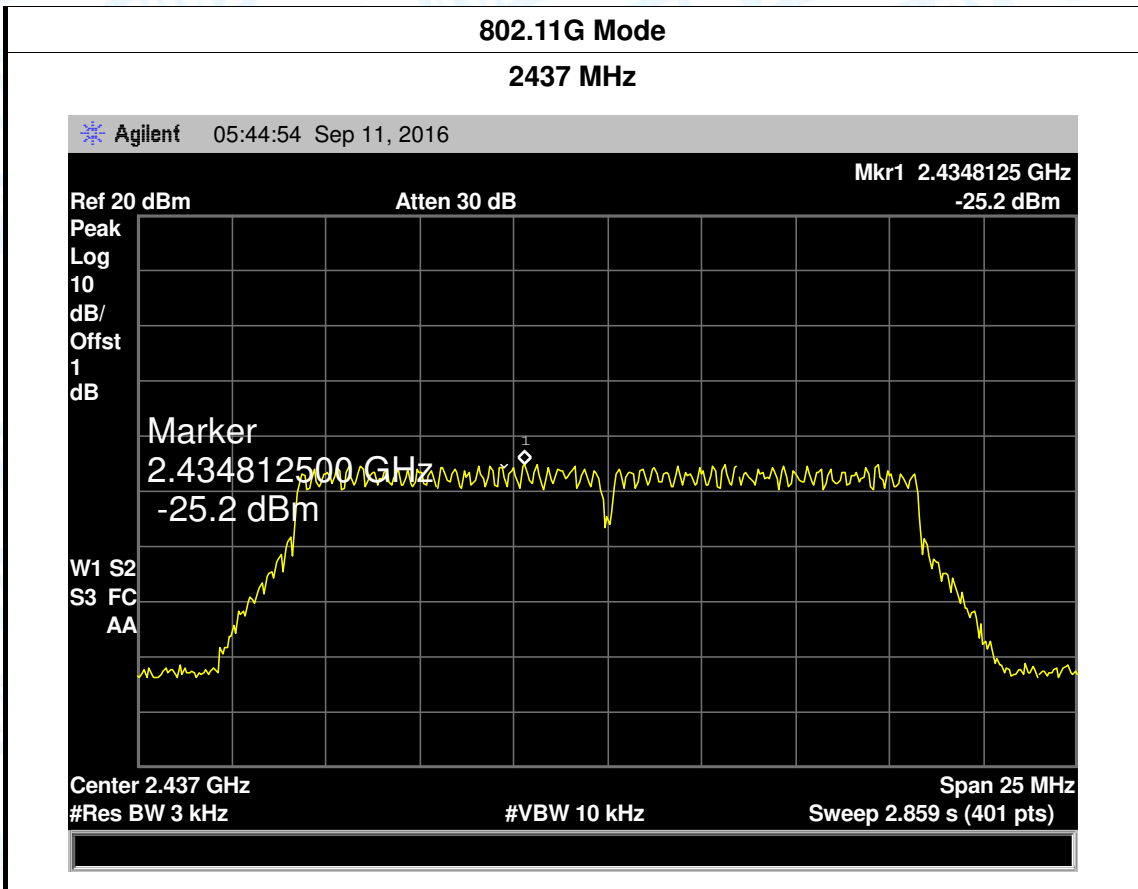

EUT:	Smart LED Colorful Bulb	Model:	XM-JPLB1
Temperature:	25 °C	Temperature:	25 °C
Test Voltage:	AC 120V/60Hz		
Test Mode:	TX 802.11N(HT20) Mode		
Channel Frequency (MHz)	Power Density (3 kHz/dBm)	Limit (dBm)	
2412	-27.88	8	
2437	-28.18		
2462	-25.37		

802.11N(HT20) Mode

2412 MHz

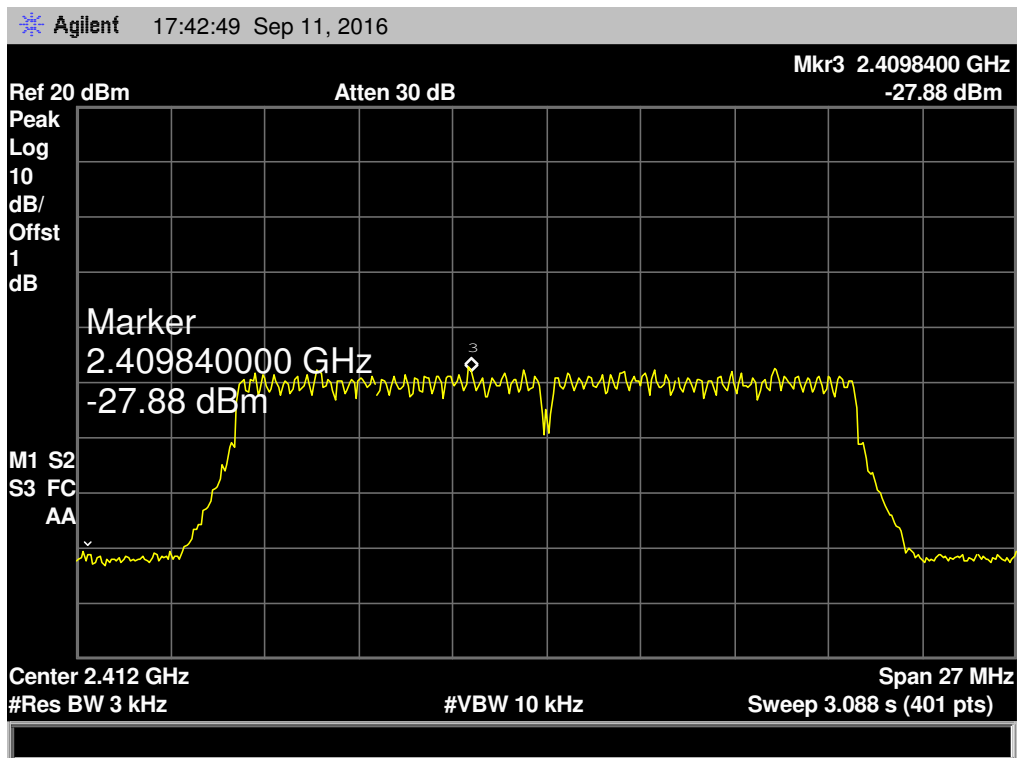

802.11N(HT20) Mode

2437 MHz

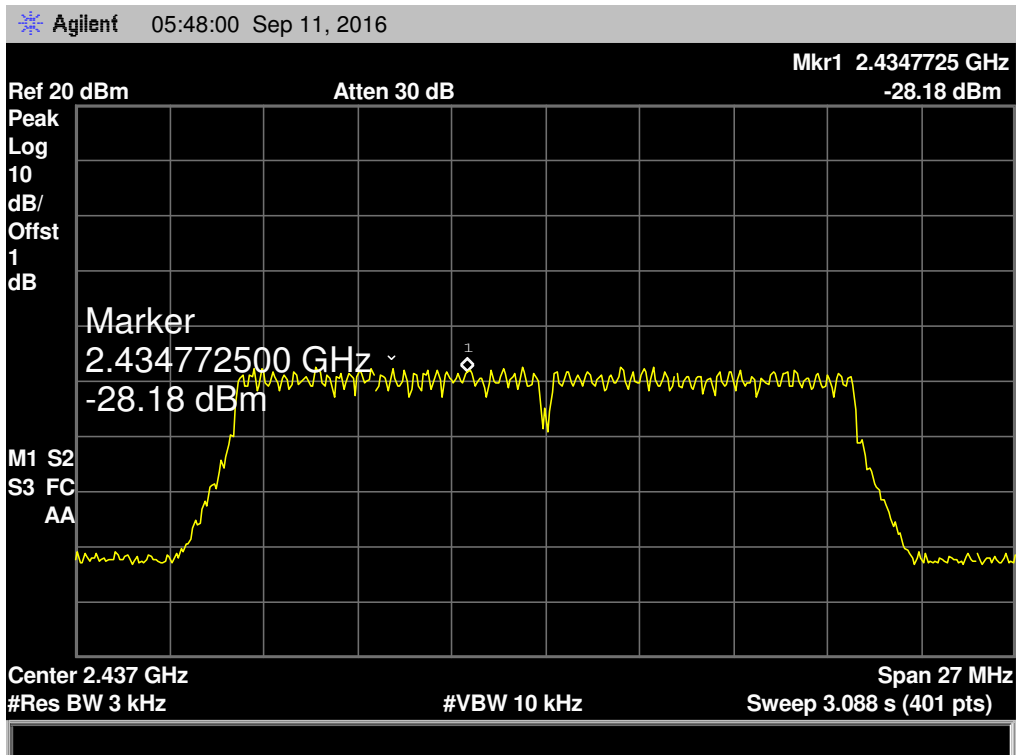

802.11N(HT20) Mode

2462 MHz

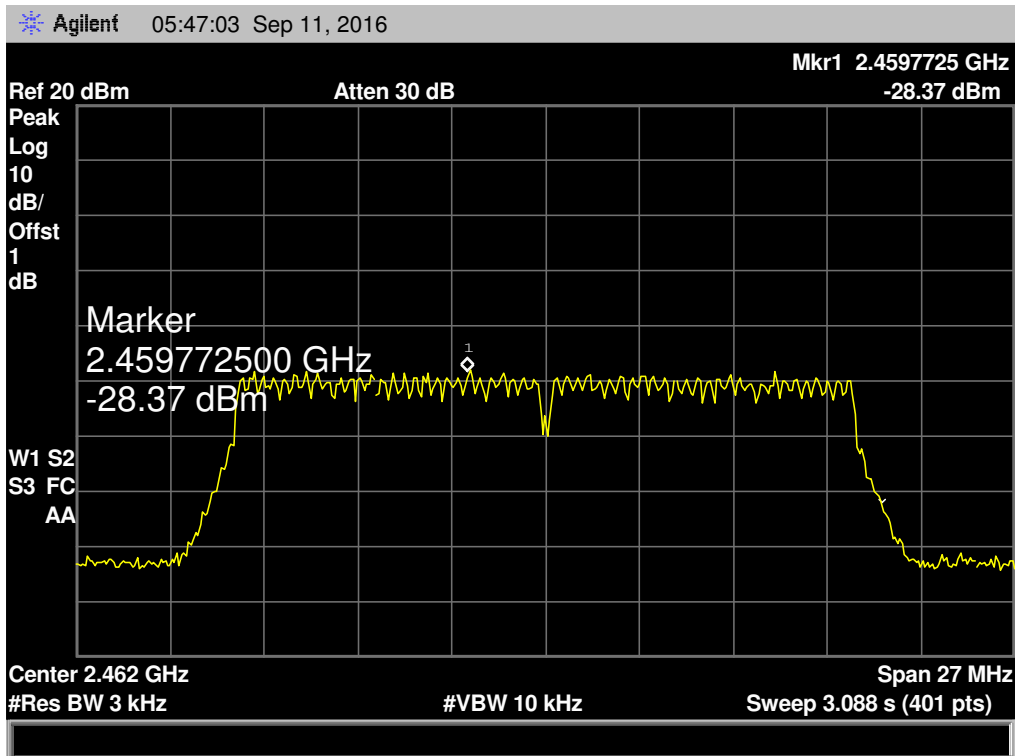

EUT:	Smart LED Colorful Bulb	Model:	XM-JPLB1
Temperature:	25 °C	Temperature:	25 °C
Test Voltage:	AC 120V/60Hz		
Test Mode:	TX 802.11N(HT40) Mode		
Channel Frequency (MHz)	Power Density (3 kHz/dBm)	Limit (dBm)	
2422	-28.83	8	
2437	-28.88		
2452	-28.17		

802.11N(HT40) Mode

2422 MHz

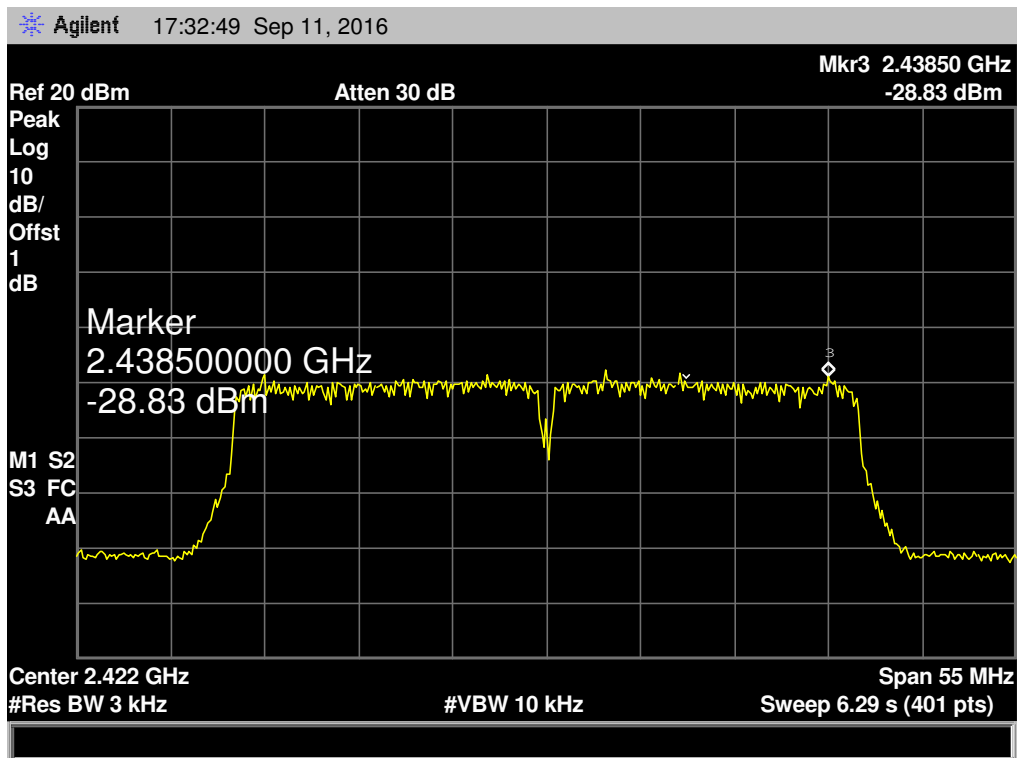

802.11N(HT20) Mode

2437 MHz

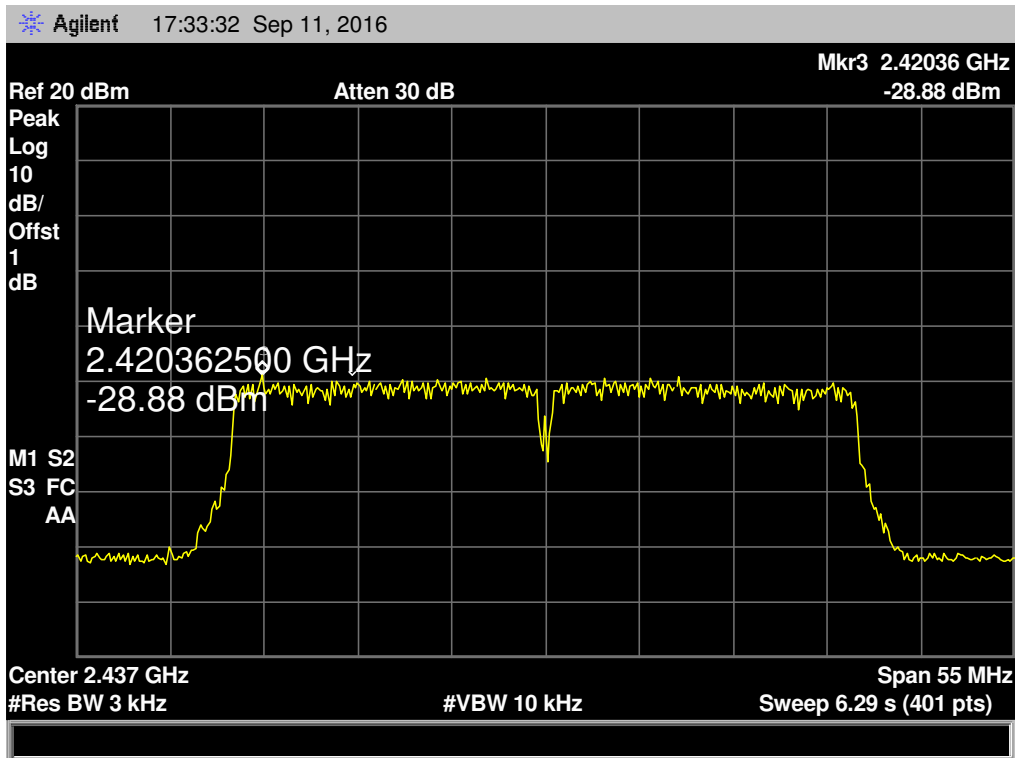

802.11N(HT40) Mode

2452 MHz

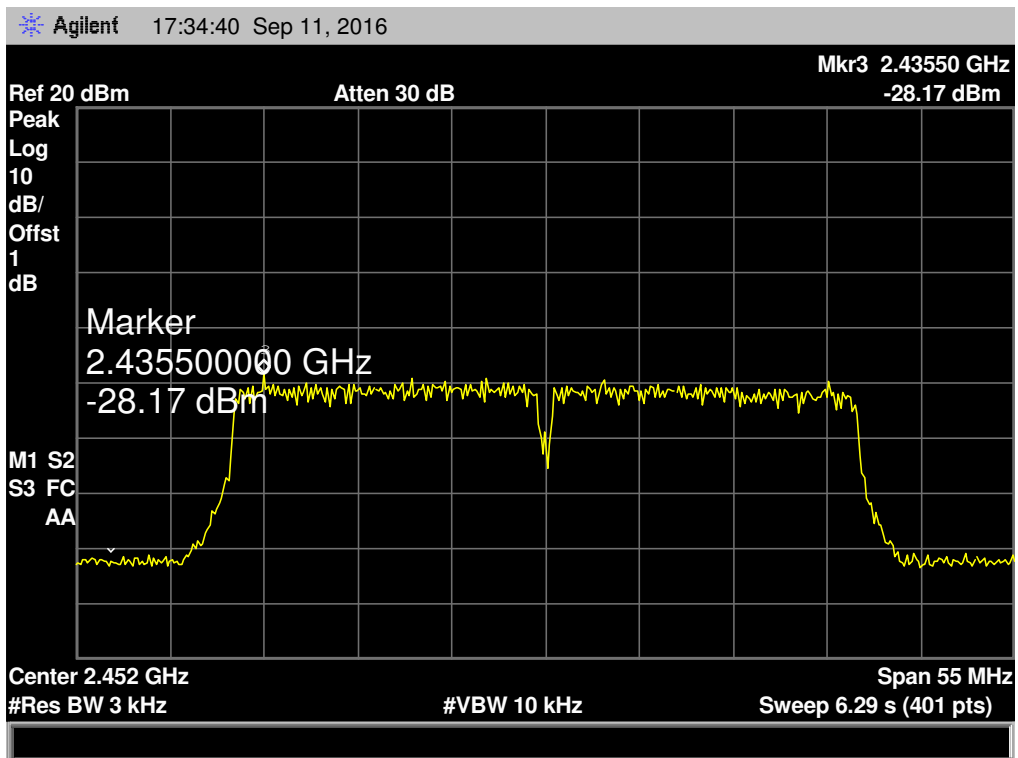

10. Antenna Requirement

10.1 Standard Requirement

10.1.1 Standard

FCC Part 15.203

10.1.2 Requirement

An intentional radiator shall be designed to ensure that no antenna other than that furnished by the responsible party shall be used with the device. The use of a permanently attached antenna or of an antenna that uses a unique coupling to the intentional radiator shall be considered sufficient to comply with the provisions of this Section. The manufacturer may design the unit so that a broken antenna can be replaced by the user, but the use of a standard antenna jack or electrical connector is prohibited.

10.2 Antenna Connected Construction

The directional gains of the antenna used for transmitting is 2 dBi, and the antenna de-signed with permanent attachment and no consideration of replacement. Please see the EUT photo for details.

Result

The EUT antenna is a PCB Antenna. It complies with the standard requirement.

Antenna Type
<input checked="" type="checkbox"/> Permanent attached antenna
<input type="checkbox"/> Unique connector antenna
<input type="checkbox"/> Professional installation antenna