

FCC Radio Test Report

FCC ID: 2AEP6XM-JPG1-2

Original Grant

Report No. : TB-FCC147282
Applicant : HangZhou XiongMai Technology CO., LTD
Equipment Under Test (EUT)
EUT Name : WarriorG1
Model No. : XM-JPG1-2
Series No. : XM-JPG1-2S, XM-JPG1-4, XM-JPG1-4S, G1-2, G1-4S
Brand Name : XM
Receipt Date : 2016-03-18
Test Date : 2016-03-18 to 2016-03-27
Issue Date : 2016-03-28
Standards : FCC Part 15, Subpart C (15.247:2015)
Test Method : ANSI C63.10: 2013
Conclusions : **PASS**

In the configuration tested, the EUT complied with the standards specified above,
The EUT technically complies with the FCC and IC requirements

Test/Witness Engineer :

IWAN SU

**Approved &
Authorized**

:

Ray

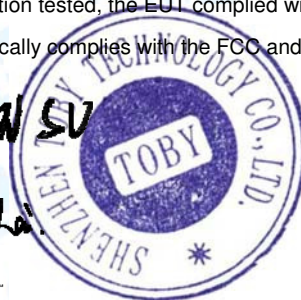

This report details the results of the testing carried out on one sample. The results contained in this test report do not relate to other samples of the same product. The manufacturer should ensure that all products in series production are in conformity with the product sample detailed in the report.

Contents

CONTENTS..... 2

1. GENERAL INFORMATION ABOUT EUT 4

1.1 Client Information..... 4

1.2 General Description of EUT (Equipment Under Test) 4

1.3 Block Diagram Showing the Configuration of System Tested..... 5

1.4 Description of Support Units 5

1.5 Description of Test Mode..... 6

1.6 Description of Test Software Setting 6

1.7 Measurement Uncertainty 7

1.7 Test Facility..... 8

2. TEST SUMMARY 9

3. TEST EQUIPMENT 10

4. CONDUCTED EMISSION TEST 11

4.1 Test Standard and Limit..... 11

4.2 Test Setup..... 11

4.3 Test Procedure..... 11

4.4 EUT Operating Mode 12

4.5 Test Data..... 12

5. RADIATED EMISSION TEST 17

5.1 Test Standard and Limit..... 17

5.2 Test Setup..... 18

5.3 Test Procedure..... 19

5.4 EUT Operating Condition 19

5.5 Test Data..... 20

6. RESTRICTED BANDS REQUIREMENT 51

6.1 Test Standard and Limit..... 51

6.2 Test Setup..... 51

6.3 Test Procedure..... 51

6.4 EUT Operating Condition 52

6.5 Test Data..... 52

7. BANDWIDTH TEST 73

7.1 Test Standard and Limit..... 73

7.2 Test Setup..... 73

7.3 Test Procedure..... 73

7.4 EUT Operating Condition 73

7.5 Test Data..... 74

8. PEAK OUTPUT POWER TEST..... 82

8.1 Test Standard and Limit..... 82

- 8.2 Test Setup.....82
- 8.3 Test Procedure.....82
- 8.4 EUT Operating Condition82
- 8.5 Test Data.....83
- 9. POWER SPECTRAL DENSITY TEST88**
- 9.1 Test Standard and Limit.....88
- 9.2 Test Setup.....88
- 9.3 Test Procedure.....88
- 9.4 EUT Operating Condition88
- 9.5 Test Data.....89
- 10. ANTENNA REQUIREMENT.....97**
- 10.1 Standard Requirement.....97
- 10.2 Antenna Connected Construction.....97

1. General Information about EUT

1.1 Client Information

Applicant : HangZhou XiongMai Technology CO., LTD
Address : 9th Floor, Building 9, Yinhu Innovation Center, No.9 FuXian Road, YinHu Street, Hangzhou, China
Manufacturer : HangZhou XiongMai Technology CO., LTD
Address : 9th Floor, Building 9, Yinhu Innovation Center, No.9 FuXian Road, YinHu Street, Hangzhou, China

1.2 General Description of EUT (Equipment Under Test)

EUT Name	:	WarriorG1
Models No.	:	XM-JPG1-2, XM-JPG1-2S, XM-JPG1-4, XM-JPG1-4S, G1-2, G1-4S
Model Difference	:	All these models are identical in the same PCB, layout and electrical circuit, the only difference is model name for commercial.
Product Description	:	Operation Frequency: 802.11b/g/n(HT20): 2412MHz~2462MHz 802.11n(HT40): 2422MHz~2452MHz
	:	Number of Channel: 802.11b/g/n(HT20):11 channels see note(3) 802.11n(HT40): 7 channels see note(3)
	:	RF Output Power: 802.11b: 9.13 dBm 802.11g: 9.08 dBm 802.11n (HT20): 9.00 dBm 802.11n (HT40): 9.02 dBm
	:	Antenna Gain: 2 dBi Chip Antenna
	:	Modulation Type: 802.11b: CCK, DQPSK, DBPSK 802.11g: 64-QAM,QPSK,BPSK 802.11n: 64-QAM,16-QAM,QPSK,BPSK
	:	Bit Rate of Transmitter: 802.11b:11/5.5/2/1 Mbps 802.11g:54/48/36/24/18/12/9/6 Mbps 802.11n:up to 150Mbps
	Power Supply	:
Power Rating	:	DC 5.0V by USB cable. DC 3.6V by 3400mAh Li-ion Battery.
Connecting I/O Port(S)	:	Please refer to the User's Manual

Note:

- (1) This Test Report is FCC Part 15.247 for 802.11b/g/n, the test procedure follows the FCC KDB 558074 D01 DTS Meas Guidance v03r04.
- (2) For a more detailed features description, please refer to the manufacturer's specifications or the User's Manual.
- (3) Channel List:

Channel	Frequency (MHz)	Channel	Frequency (MHz)	Channel	Frequency (MHz)
01	2412	05	2432	09	2452
02	2417	06	2437	10	2457
03	2422	07	2442	11	2462
04	2427	08	2447		

Note:CH 01~CH 11 for 802.11b/g/n(HT20)
CH 03~CH 09 for 802.11n(HT40)

- (4) The Antenna information about the equipment is provided by the applicant.

1.3 Block Diagram Showing the Configuration of System Tested

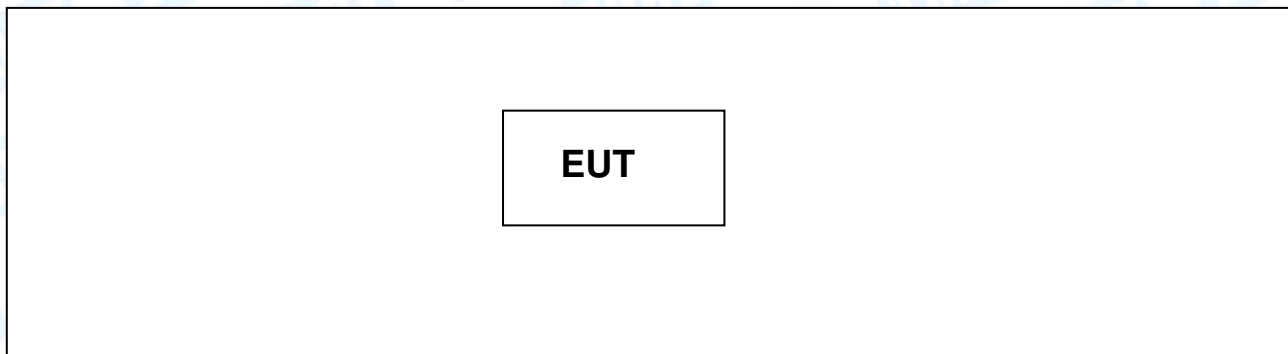
TX Mode

1.4 Description of Support Units

The EUT has been test as an independent unit

1.5 Description of Test Mode

To investigate the maximum EMI emission characteristics generates from EUT, the test system was pre-scanning tested base on the consideration of following EUT operation mode or test configuration mode which possible have effect on EMI emission level. Each of these EUT operation mode(s) or test configuration mode(s) mentioned follow was evaluated respectively.

For Conducted Test	
Final Test Mode	Description
Mode 1	TX B Mode

For Radiated Test	
Final Test Mode	Description
Mode 3	TX Mode B Mode Channel 01/06/11
Mode 4	TX Mode G Mode Channel 01/06/11
Mode 5	TX Mode N(HT20) Mode Channel 01/06/11
Mode 6	TX Mode N(HT40) Mode Channel 03/06/09

Note:

- (1) For all test, we have verified the construction and function in typical operation. And all the test modes were carried out with the EUT in transmitting operation in maximum power with all kinds of data rate.
According to ANSI C63.10 standards, the measurements are performed at the highest, middle, lowest available channels, and the worst case data rate as follows:
 - 802.11b Mode: CCK (1 Mbps)
 - 802.11g Mode: OFDM (6 Mbps)
 - 802.11n (HT20) Mode: MCS 0 (6.5 Mbps)
 - 802.11n (HT40) Mode: MCS 0 (13 Mbps)
- (2) During the testing procedure, the continuously transmitting with the maximum power mode was programmed by the customer.
- (3) The EUT is considered a mobile unit; in normal use it was positioned on X-plane. The worst case was found positioned on X-plane. Therefore only the test data of this X-plane was used for radiated emission measurement test.

1.6 Description of Test Software Setting

During testing channel & Power controlling software provided by the customer was used to control the operating channel as well as the output power level. The RF output power selection is for the setting of RF output power expected by the customer and is going to be fixed on the firmware of the final end product power parameters of WLAN.

Test Software Version	N/A		
Channel	CH 01	CH 06	CH 11
IEEE 802.11b DSSS	DEF	DEF	DEF
IEEE 802.11g OFDM	DEF	DEF	DEF
IEEE 802.11n (HT20)	DEF	DEF	DEF
	CH 03	CH 06	CH 09
IEEE 802.11n (HT40)	DEF	DEF	DEF

1.7 Measurement Uncertainty

The reported uncertainty of measurement $y \pm U$, where expanded uncertainty U is based on a standard uncertainty multiplied by a coverage factor of $k=2$, providing a level of confidence of approximately 95 %.

Test Item	Parameters	Expanded Uncertainty (U_{Lab})
Conducted Emission	Level Accuracy: 9kHz~150kHz	± 3.42 dB
	150kHz to 30MHz	± 3.42 dB
Radiated Emission	Level Accuracy: 9kHz to 30 MHz	± 4.60 dB
Radiated Emission	Level Accuracy: 30MHz to 1000 MHz	± 4.40 dB
Radiated Emission	Level Accuracy: Above 1000MHz	± 4.20 dB

1.7 Test Facility

The testing report were performed by the Shenzhen Toby Technology Co., Ltd., in their facilities located at 1A/F., Bldg.6, Yusheng Industrial Zone, The National Road No.107 Xixiang Section 467, Xixiang, Bao'an, Shenzhen, Guangdong, China. At the time of testing, the following bodies accredited the Laboratory:

CNAS (L5813)

The Laboratory has been accredited by CNAS to ISO/IEC 17025: 2005 General Requirements for the Competence of Testing and Calibration Laboratories for the competence in the field of testing. And the Registration No.: CNAS L5813.

FCC List No.: (811562)

The Laboratory is listed in the United States of American Federal Communications Commission (FCC), and the registration number is 811562.

IC Registration No.: (11950A-1)

The Laboratory has been registered by Certification and Engineering Bureau of Industry Canada for radio equipment testing. The site registration: Site# 11950A-1.

2. Test Summary

FCC Part 15 Subpart C(15.247)/ RSS 247 Issue 1				
Standard Section		Test Item	Judgment	Remark
FCC	IC			
15.203	/	Antenna Requirement	PASS	N/A
15.207	RSS-GEN 7.2.4	Conducted Emission	PASS	N/A
15.205	RSS-GEN 7.2.2	Restricted Bands	PASS	N/A
15.247(a)(2)	RSS 247 5.2 (1)	6dB Bandwidth	PASS	N/A
15.247(b)	RSS 247 5.4 (4)	Peak Output Power	PASS	N/A
15.247(e)	RSS 247 5.2 (2)	Power Spectral Density	PASS	N/A
15.247(d)	RSS 247 5.5	Transmitter Radiated Spurious Emission	PASS	N/A

Note: "/" for no requirement for this test item.
N/A is an abbreviation for Not Applicable.

3. Test Equipment

Conducted Emission Test					
Equipment	Manufacturer	Model No.	Serial No.	Last Cal.	Cal. Due Date
EMI Test Receiver	Rohde & Schwarz	ESCI	100321	Aug. 07, 2015	Aug. 06, 2016
RF Switching Unit	Compliance Direction Systems Inc	RSU-A4	34403	Aug. 07, 2015	Aug. 06, 2016
AMN	SCHWARZBECK	NNBL 8226-2	8226-2/164	Aug. 07, 2015	Aug. 06, 2016
LISN	Rohde & Schwarz	ENV216	101131	Aug. 07, 2015	Aug. 06, 2016
Radiation Emission Test					
Equipment	Manufacturer	Model No.	Serial No.	Last Cal.	Cal. Due Date
Spectrum Analyzer	Agilent	E4407B	MY45106456	Aug. 07, 2015	Aug. 06, 2016
EMI Test Receiver	Rohde & Schwarz	ESCI	100010/007	Aug. 07, 2015	Aug. 06, 2016
Bilog Antenna	ETS-LINDGREN	3142E	00117537	Mar. 26, 2016	Mar. 25, 2017
Bilog Antenna	ETS-LINDGREN	3142E	00117542	Mar. 26, 2016	Mar. 25, 2017
Horn Antenna	ETS-LINDGREN	3117	00143207	Mar. 26, 2016	Mar. 25, 2017
Horn Antenna	ETS-LINDGREN	3117	00143209	Mar. 26, 2016	Mar. 25, 2017
Pre-amplifier	Sonoma	310N	185903	Mar. 26, 2016	Mar. 25, 2017
Pre-amplifier	HP	8447B	3008A00849	Mar. 26, 2016	Mar. 25, 2017
Cable	HUBER+SUHNER	100	SUCOFLEX	Mar. 26, 2016	Mar. 25, 2017
Positioning Controller	ETS-LINDGREN	2090	N/A	N/A	N/A

4. Conducted Emission Test

4.1 Test Standard and Limit

4.1.1 Test Standard

FCC Part 15.207

4.1.2 Test Limit

Conducted Emission Test Limit

Frequency	Maximum RF Line Voltage (dB μ V)	
	Quasi-peak Level	Average Level
150kHz~500kHz	66 ~ 56 *	56 ~ 46 *
500kHz~5MHz	56	46
5MHz~30MHz	60	50

Notes:

(1) *Decreasing linearly with logarithm of the frequency.

(2) The lower limit shall apply at the transition frequencies.

(3) The limit decrease in line with the logarithm of the frequency in the range of 0.15 to 0.50MHz.

4.2 Test Setup

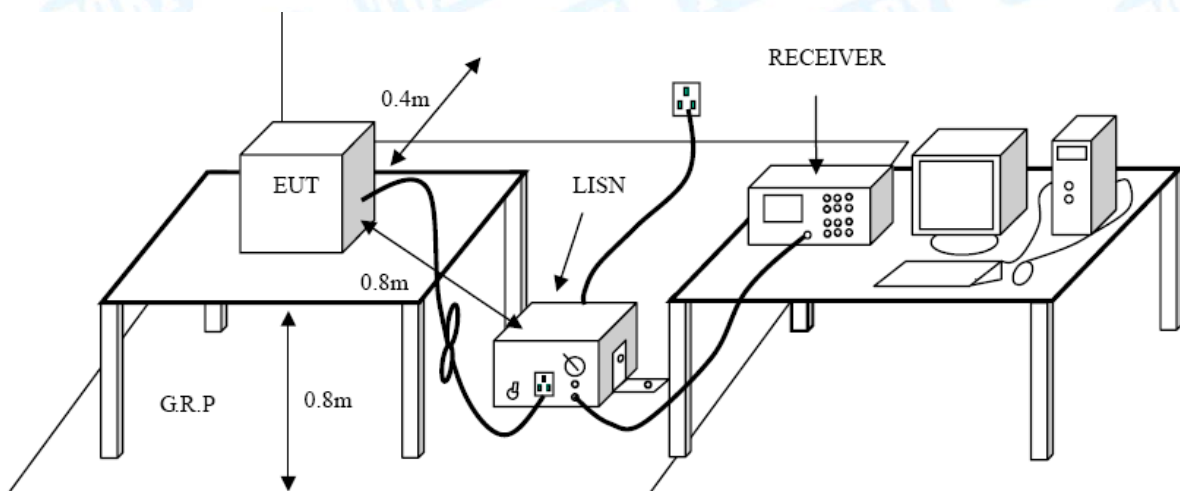

4.3 Test Procedure

The EUT was placed 0.8 meters from the horizontal ground plane with EUT being connected to the power mains through a line impedance stabilization network (LISN). All other support equipments powered from additional LISN(s). The LISN provide 50 Ohm/ 50uH of coupling impedance for the measuring instrument.

Interconnecting cables that hang closer than 40 cm to the ground plane shall be folded back and forth in the center forming a bundle 30 to 40 cm long.

I/O cables that are not connected to a peripheral shall be bundled in the center. The end of the cable may be terminated, if required, using the correct terminating impedance. The overall length shall not exceed 1 m.

LISN at least 80 cm from nearest part of EUT chassis.

The bandwidth of EMI test receiver is set at 9kHz, and the test frequency band is from 0.15MHz to 30MHz.

4.4 EUT Operating Mode

Please refer to the description of test mode.

4.5 Test Data

Please see the next page.

EUT:	WarriorG1	Model Name :	XM-JPG1-2
Temperature:	25 °C	Relative Humidity:	55%
Test Voltage:	AC 120V/60Hz		
Terminal:	Line		
Test Mode:	TX B Mode		
Remark:	Only worse case is reported		

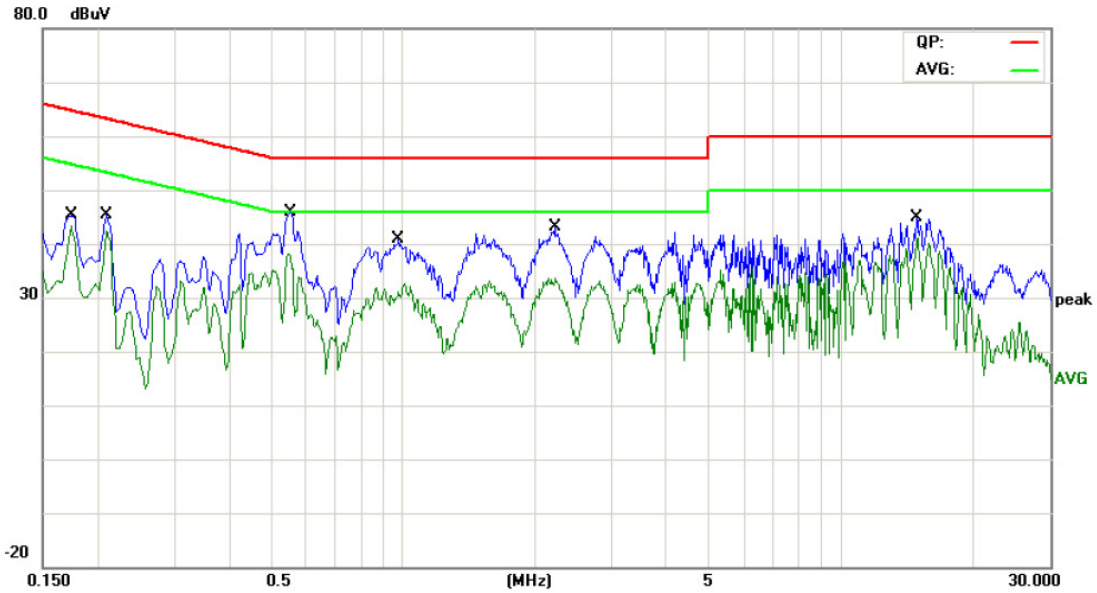

No.	Mk.	Freq. MHz	Reading Level dBuV	Correct Factor dB	Measure- ment dBuV	Limit dBuV	Over dB	Detector
1		0.1740	33.93	10.12	44.05	64.76	-20.71	QP
2		0.1740	33.25	10.12	43.37	54.76	-11.39	AVG
3		0.2100	33.90	10.12	44.02	63.20	-19.18	QP
4		0.2100	32.11	10.12	42.23	53.20	-10.97	AVG
5		0.5540	35.41	10.02	45.43	56.00	-10.57	QP
6	*	0.5540	27.69	10.02	37.71	46.00	-8.29	AVG
7		0.9780	28.56	10.15	38.71	56.00	-17.29	QP
8		0.9780	21.06	10.15	31.21	46.00	-14.79	AVG
9		2.2220	27.70	10.06	37.76	56.00	-18.24	QP
10		2.2220	22.93	10.06	32.99	46.00	-13.01	AVG
11		14.9060	31.68	10.06	41.74	60.00	-18.26	QP
12		14.9060	30.65	10.06	40.71	50.00	-9.29	AVG

*:Maximum data x:Over limit !:over margin

Emission Level= Read Level+ Correct Factor

EUT:	WarriorG1	Model Name :	XM-JPG1-2
Temperature:	25 °C	Relative Humidity:	55%
Test Voltage:	AC 120V/60Hz		
Terminal:	Neutral		
Test Mode:	TX B Mode		
Remark:	Only worse case is reported		

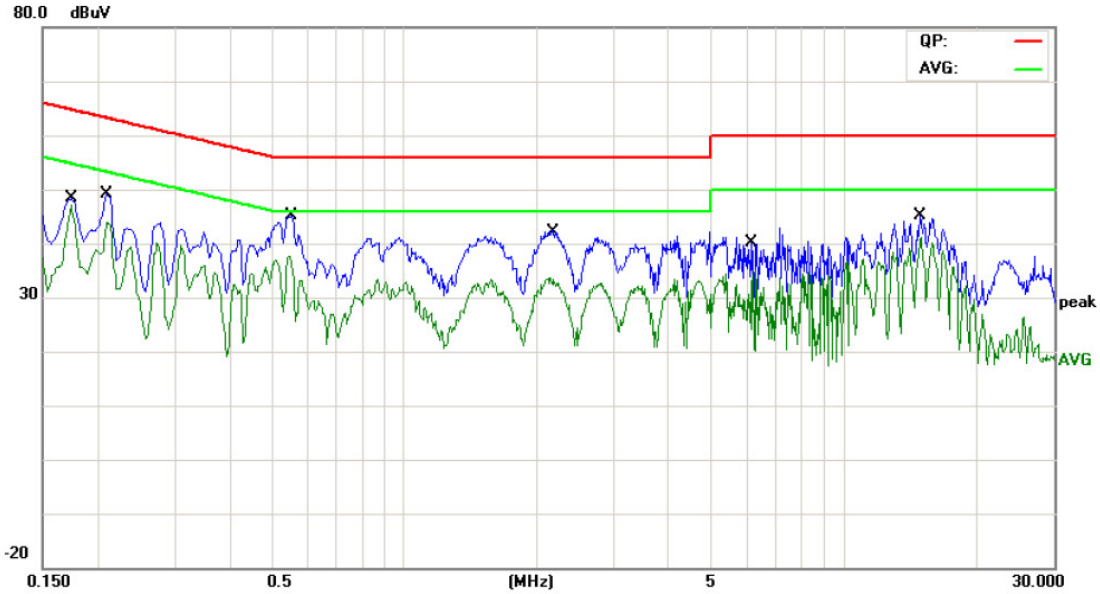

No.	Mk.	Freq. MHz	Reading Level dBuV	Correct Factor dB	Measure- ment dBuV	Limit dBuV	Over dB	Detector
1		0.1740	37.38	9.97	47.35	64.76	-17.41	QP
2	*	0.1740	36.89	9.97	46.86	54.76	-7.90	AVG
3		0.2100	37.19	10.02	47.21	63.20	-15.99	QP
4		0.2100	33.84	10.02	43.86	53.20	-9.34	AVG
5		0.5540	34.30	10.05	44.35	56.00	-11.65	QP
6		0.5540	26.48	10.05	36.53	46.00	-9.47	AVG
7		2.2020	27.20	10.05	37.25	56.00	-18.75	QP
8		2.2020	21.70	10.05	31.75	46.00	-14.25	AVG
9		6.1420	14.58	10.02	24.60	60.00	-35.40	QP
10		6.1420	10.04	10.02	20.06	50.00	-29.94	AVG
11		14.9060	4.50	10.26	14.76	60.00	-45.24	QP
12		14.9060	-1.00	10.26	9.26	50.00	-40.74	AVG

*:Maximum data x:Over limit !:over margin

Emission Level= Read Level+ Correct Factor

EUT:	WarriorG1	Model Name :	XM-JPG1-2
Temperature:	25 °C	Relative Humidity:	55%
Test Voltage:	AC 240V/60Hz		
Terminal:	Line		
Test Mode:	TX B Mode		
Remark:	Only worse case is reported		

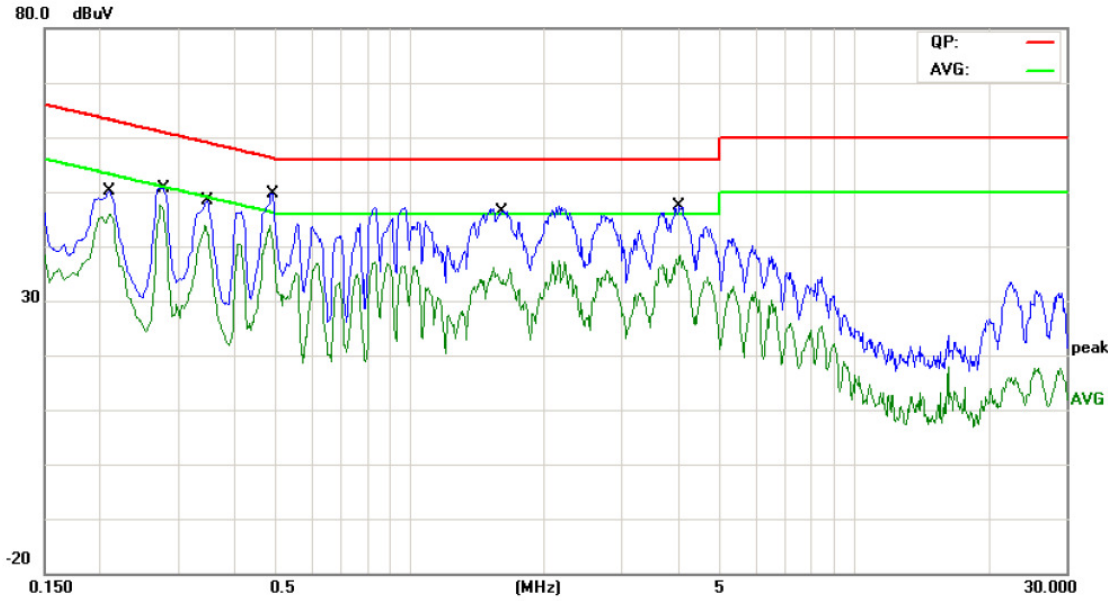

No.	Mk.	Freq. MHz	Reading Level dBuV	Correct Factor dB	Measure- ment dBuV	Limit dBuV	Over dB	Detector
1		0.2100	38.66	10.02	48.68	63.20	-14.52	QP
2		0.2100	36.41	10.02	46.43	53.20	-6.77	AVG
3		0.2779	40.49	10.02	50.51	60.88	-10.37	QP
4	*	0.2779	35.97	10.02	45.99	50.88	-4.89	AVG
5		0.3500	36.29	10.02	46.31	58.96	-12.65	QP
6		0.3500	31.69	10.02	41.71	48.96	-7.25	AVG
7		0.4900	37.47	10.02	47.49	56.17	-8.68	QP
8		0.4900	30.69	10.02	40.71	46.17	-5.46	AVG
9		1.6019	34.16	10.06	44.22	56.00	-11.78	QP
10		1.6019	23.07	10.06	33.13	46.00	-12.87	AVG
11		4.0340	32.68	9.99	42.67	56.00	-13.33	QP
12		4.0340	26.58	9.99	36.57	46.00	-9.43	AVG

*:Maximum data x:Over limit !:over margin

Emission Level= Read Level+ Correct Factor

EUT:	WarriorG1	Model Name :	XM-JPG1-2
Temperature:	25 °C	Relative Humidity:	55%
Test Voltage:	AC 240V/60Hz		
Terminal:	Neutral		
Test Mode:	TX B Mode		
Remark:	Only worse case is reported		

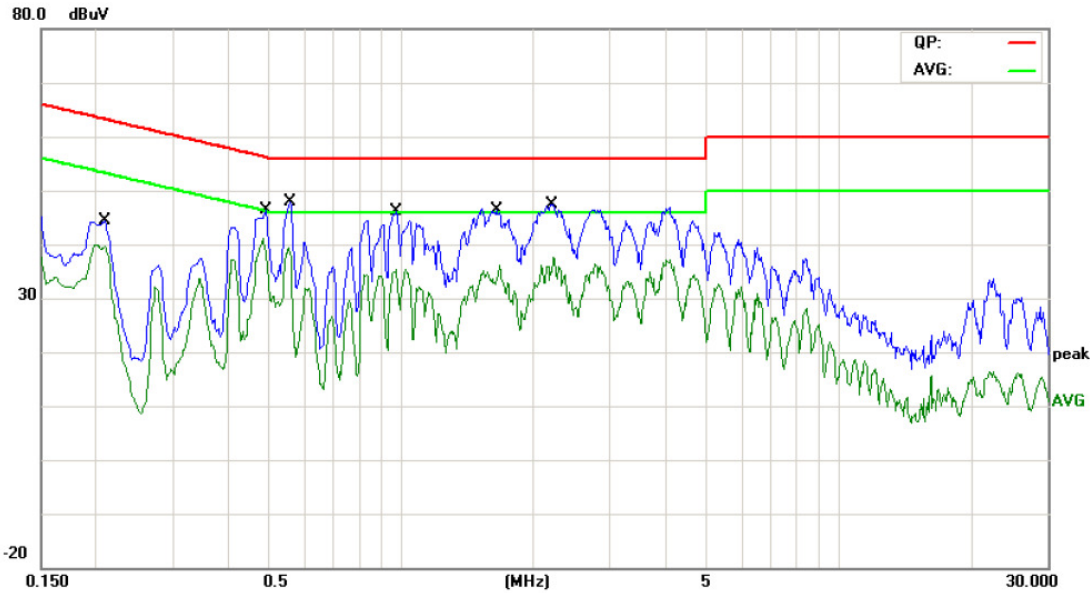

No.	Mk.	Freq. MHz	Reading Level dBuV	Correct Factor dB	Measure- ment dBuV	Limit dBuV	Over dB	Detector
1		0.2100	31.15	10.12	41.27	63.20	-21.93	QP
2		0.2100	29.09	10.12	39.21	53.20	-13.99	AVG
3		0.4900	34.71	10.02	44.73	56.17	-11.44	QP
4	*	0.4900	28.29	10.02	38.31	46.17	-7.86	AVG
5		0.5580	37.54	10.02	47.56	56.00	-8.44	QP
6		0.5580	28.01	10.02	38.03	46.00	-7.97	AVG
7		0.9740	34.77	10.15	44.92	56.00	-11.08	QP
8		0.9740	25.03	10.15	35.18	46.00	-10.82	AVG
9		1.6460	34.85	10.10	44.95	56.00	-11.05	QP
10		1.6460	23.37	10.10	33.47	46.00	-12.53	AVG
11		2.2300	33.52	10.06	43.58	56.00	-12.42	QP
12		2.2300	27.24	10.06	37.30	46.00	-8.70	AVG

*:Maximum data x:Over limit !:over margin

Emission Level= Read Level+ Correct Factor

5. Radiated Emission Test

5.1 Test Standard and Limit

5.1.1 Test Standard

FCC Part 15.209

5.1.2 Test Limit

Radiated Emission Limits (9kHz~1000MHz)

Frequency (MHz)	Field Strength (microvolt/meter)	Measurement Distance (meters)
0.009~0.490	2400/F(KHz)	300
0.490~1.705	24000/F(KHz)	30
1.705~30.0	30	30
30~88	100	3
88~216	150	3
216~960	200	3
Above 960	500	3

Radiated Emission Limit (Above 1000MHz)

Frequency (MHz)	Class A (dBuV/m)(at 3 M)		Class B (dBuV/m)(at 3 M)	
	Peak	Average	Peak	Average
Above 1000	80	60	74	54

Note:

- (1) The tighter limit applies at the band edges.
- (2) Emission Level(dBuV/m)=20log Emission Level(uV/m)

5.2 Test Setup

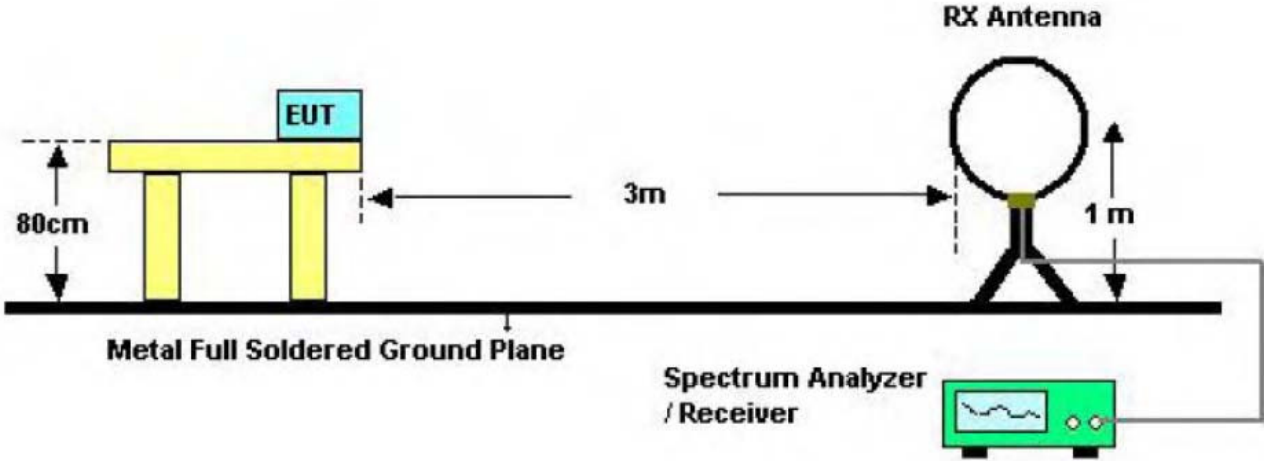

Below 30MHz Test Setup

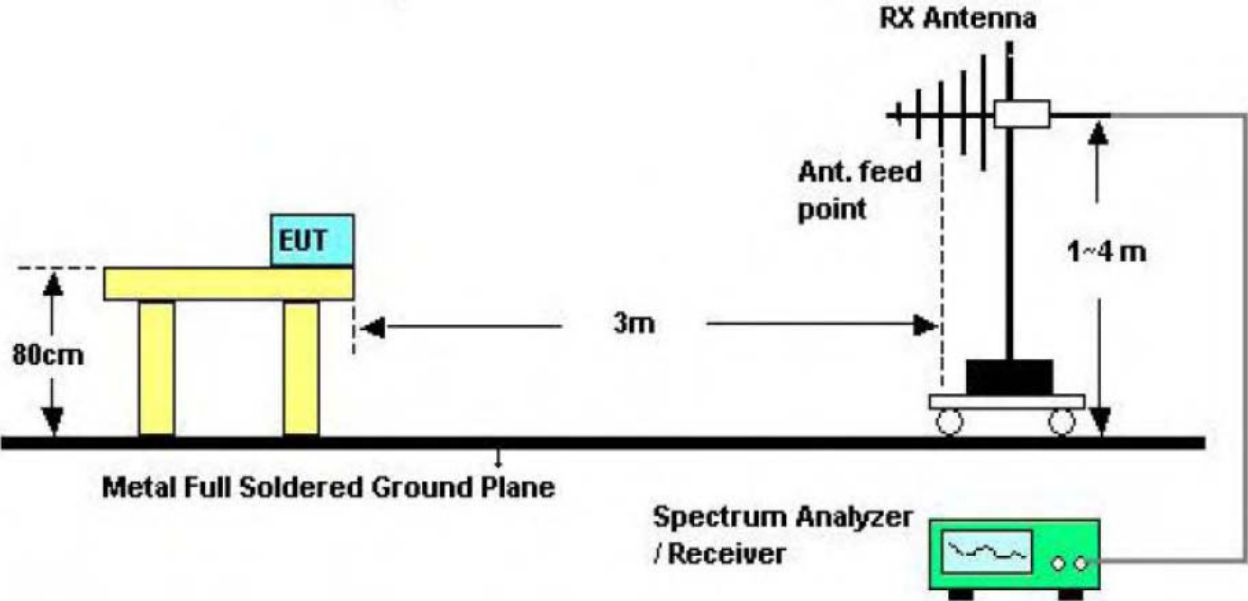

Below 1000MHz Test Setup

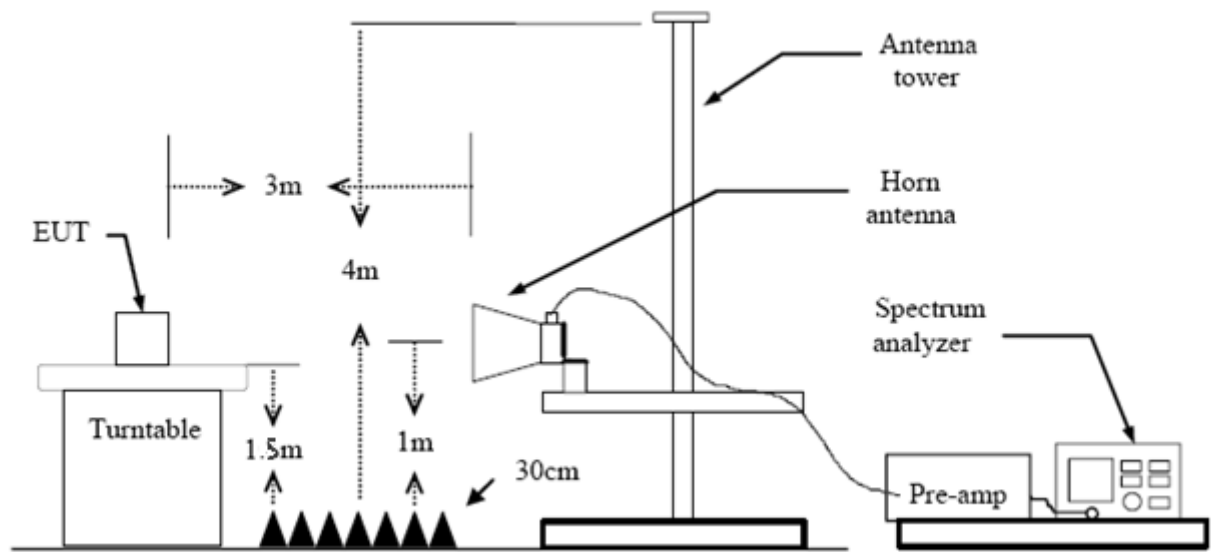

Above 1GHz Test Setup

5.3 Test Procedure

- (1) Measurements at frequency above 1GHz. The EUT was placed on a rotating 1.5m high above the ground. RF absorbers covered the ground plane with a minimum area of 3.0m by 3.0m between the EUT and measurement receiver antenna. The RF absorber shall not exceed 30cm in high above the conducting floor. The table was rotated 360 degrees to determine the position of the highest radiation.
- (2) The Test antenna shall vary between 1m and 4m, Both Horizontal and Vertical antenna are set to make measurement.
- (3) The initial step in collecting conducted emission data is a spectrum analyzer peak detector mode pre-scanning the measurement frequency range. Significant peaks are then marked and then Quasi Peak detector mode re-measured.
- (4) If the Peak Mode measured value compliance with and lower than Quasi Peak Mode Limit Bellow 1 GHz, the EUT shall be deemed to meet QP Limits and then no additional QP Mode measurement performed. But the Peak Value and average value both need to comply with applicable limit above 1 GHz.
- (5) Testing frequency range below 1GHz the measuring instrument use VBW=120 kHz with Quasi-peak detection.
- (6) Testing frequency range above 1GHz the measuring instrument use RBW=1 MHz and VBW=3 MHz with Peak Detector for Peak Values, and use RBW=1 MHz and VBW=10 Hz with Peak Detector for Average Values.
- (7) For the actual test configuration, please see the test setup photo.

5.4 EUT Operating Condition

The Equipment Under Test was set to Continual Transmitting in maximum power.

5.5 Test Data

Remark: During testing above 1GHz the measuring instrument use RBW=1 MHz and VBW=3 MHz with Peak Detector for Peak Values, and use RBW=1 MHz and VBW=10 Hz with Peak Detector for Average Values.

Test data please refer the following pages.

EUT:	WarriorG1	Model:	XM-JPG1-2
Temperature:	25 °C	Relative Humidity:	55%
Test Voltage:	DC 3.6V		
Ant. Pol.	Horizontal		
Test Mode:	TX B Mode 2412MHz		
Remark:	Only worse case is reported		

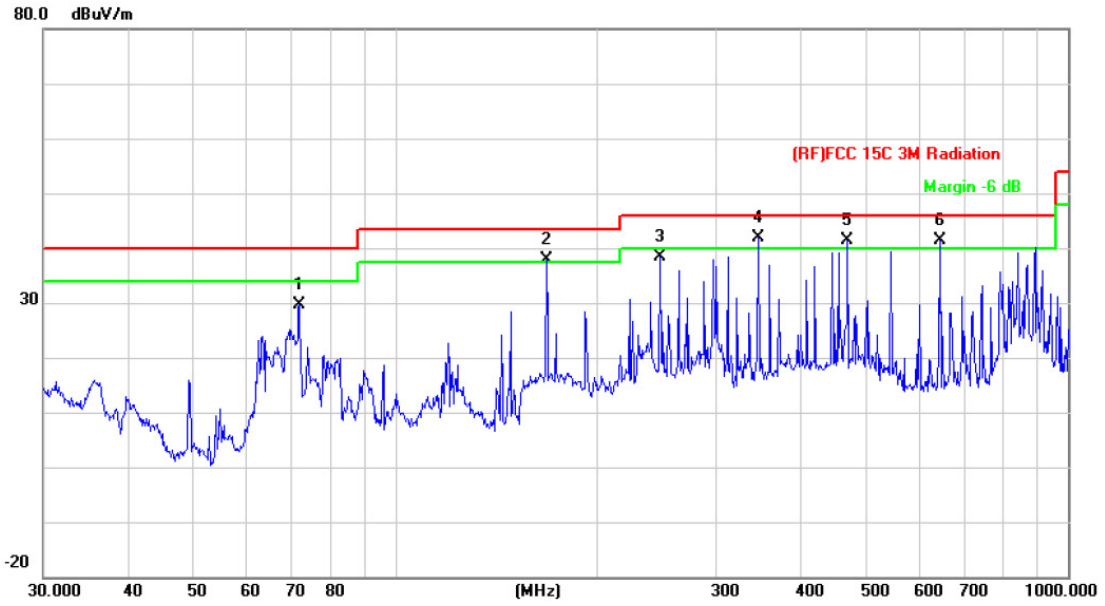

No.	Mk.	Freq. MHz	Reading Level dBuV	Correct Factor dB/m	Measure- ment dBuV/m	Limit dBuV/m	Over dB	Detector
1		72.0841	53.74	-24.22	29.52	40.00	-10.48	peak
2	!	167.8241	60.14	-22.18	37.96	43.50	-5.54	peak
3		247.6819	58.03	-19.62	38.41	46.00	-7.59	peak
4	*	346.8091	58.27	-16.51	41.76	46.00	-4.24	peak
5	!	470.5230	55.31	-13.84	41.47	46.00	-4.53	peak
6	!	645.1195	52.62	-11.15	41.47	46.00	-4.53	peak

*:Maximum data x:Over limit !:over margin

Emission Level= Read Level+ Correct Factor

EUT:	WarriorG1	Model:	XM-JPG1-2
Temperature:	25 °C	Relative Humidity:	55%
Test Voltage:	DC 3.6V		
Ant. Pol.	Vertical		
Test Mode:	TX B Mode 2412MHz		
Remark:	Only worse case is reported		

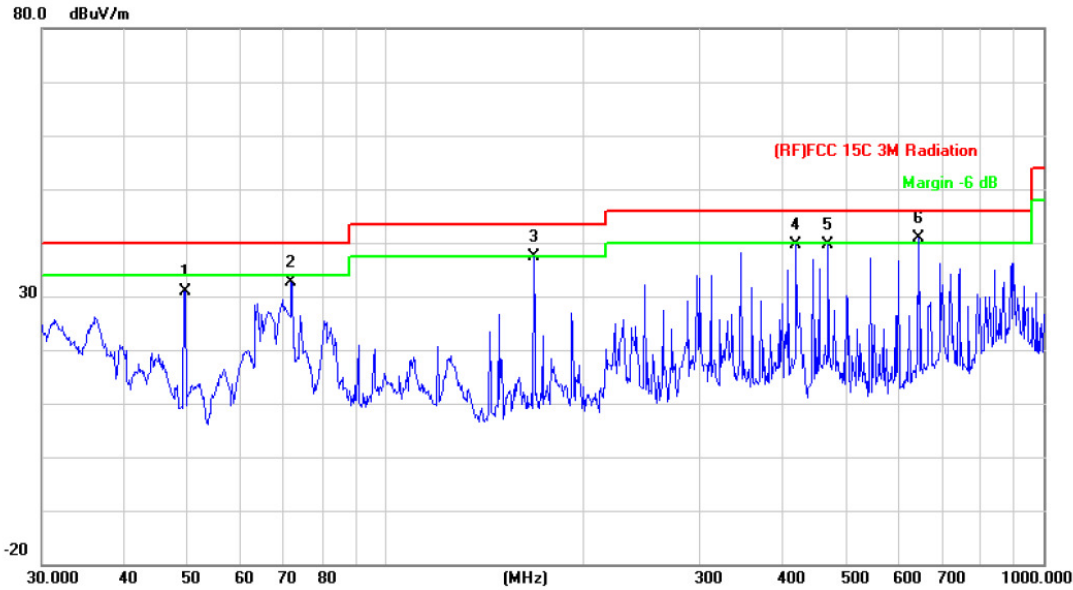

No.	Mk.	Freq. MHz	Reading Level dBuV	Correct Factor dB/m	Measure- ment dBuV/m	Limit dBuV/m	Over dB	Detector
1		49.5328	55.49	-24.67	30.82	40.00	-9.18	peak
2		71.8319	56.82	-24.23	32.59	40.00	-7.41	peak
3		167.8240	59.62	-22.18	37.44	43.50	-6.06	peak
4		420.5803	54.47	-14.84	39.63	46.00	-6.37	peak
5		470.5230	53.36	-13.84	39.52	46.00	-6.48	peak
6	*	645.1195	52.12	-11.15	40.97	46.00	-5.03	peak

*:Maximum data x:Over limit !:over margin

Emission Level= Read Level+ Correct Factor

EUT:	WarriorG1	Model:	XM-JPG1-2
Temperature:	25 °C	Relative Humidity:	55%
Test Voltage:	DC 3.6V		
Ant. Pol.	Horizontal		
Test Mode:	TX B Mode 2437MHz		
Remark:	Only worse case is reported		

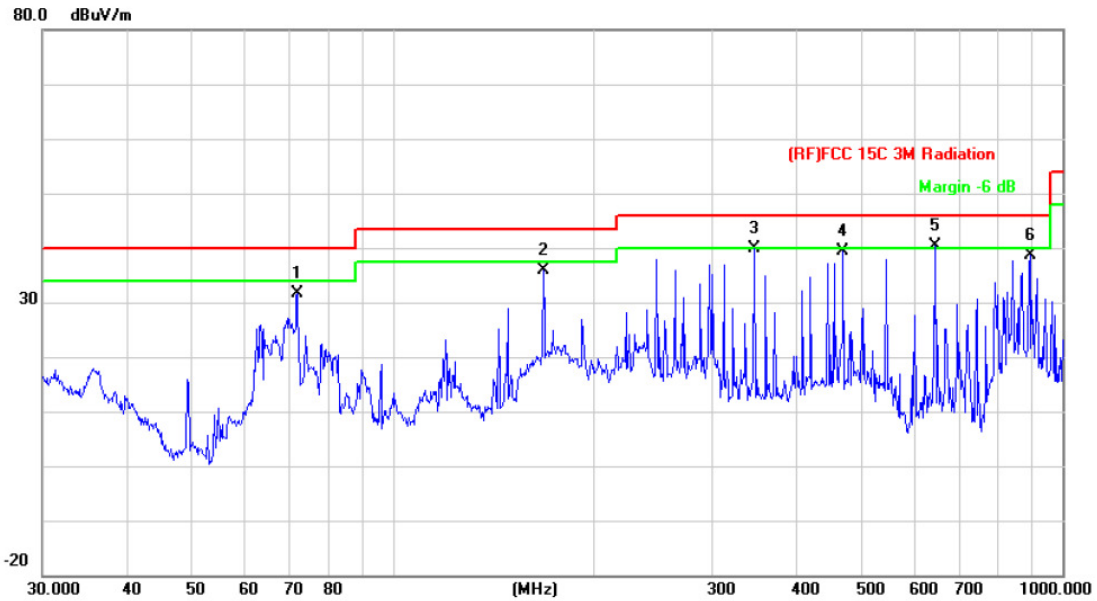

No.	Mk.	Freq. MHz	Reading Level dBuV	Correct Factor dB/m	Measure- ment dBuV/m	Limit dBuV/m	Over dB	Detector
1		72.0841	55.74	-24.22	31.52	40.00	-8.48	peak
2		167.8240	58.14	-22.18	35.96	43.50	-7.54	peak
3		346.8091	56.27	-16.51	39.76	46.00	-6.24	peak
4		470.5230	53.31	-13.84	39.47	46.00	-6.53	peak
5	*	645.1195	51.62	-11.15	40.47	46.00	-5.53	peak
6		893.8567	46.95	-8.22	38.73	46.00	-7.27	peak

*:Maximum data x:Over limit !:over margin

Emission Level= Read Level+ Correct Factor

EUT:	WarriorG1	Model:	XM-JPG1-2
Temperature:	25 °C	Relative Humidity:	55%
Test Voltage:	DC 3.6V		
Ant. Pol.	Vertical		
Test Mode:	TX B Mode 2437MHz		
Remark:	Only worse case is reported		

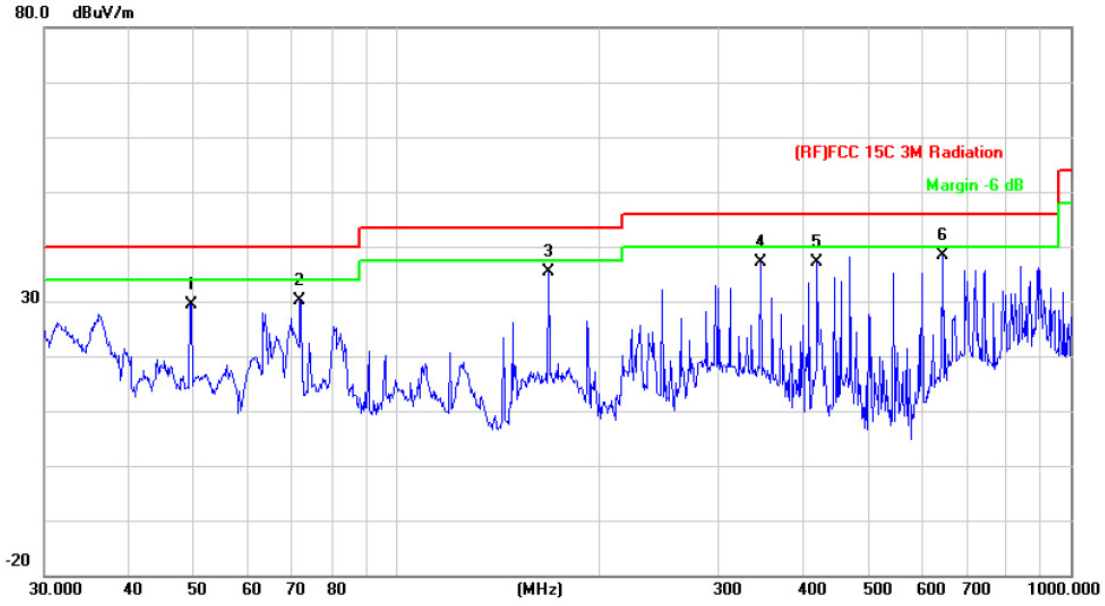

No.	Mk.	Freq. MHz	Reading Level dBuV	Correct Factor dB/m	Measure- ment dBuV/m	Limit dBuV/m	Over dB	Detector
1		49.5328	53.99	-24.67	29.32	40.00	-10.68	peak
2		71.8319	54.32	-24.23	30.09	40.00	-9.91	peak
3		167.8240	57.62	-22.18	35.44	43.50	-8.06	peak
4		346.8091	53.61	-16.51	37.10	46.00	-8.90	peak
5		420.5803	51.97	-14.84	37.13	46.00	-8.87	peak
6	*	645.1195	49.62	-11.15	38.47	46.00	-7.53	peak

*:Maximum data x:Over limit !:over margin

Emission Level= Read Level+ Correct Factor

EUT:	WarriorG1	Model:	XM-JPG1-2
Temperature:	25 °C	Relative Humidity:	55%
Test Voltage:	DC 3.6V		
Ant. Pol.	Horizontal		
Test Mode:	TX B Mode 2462MHz		
Remark:	Only worse case is reported		

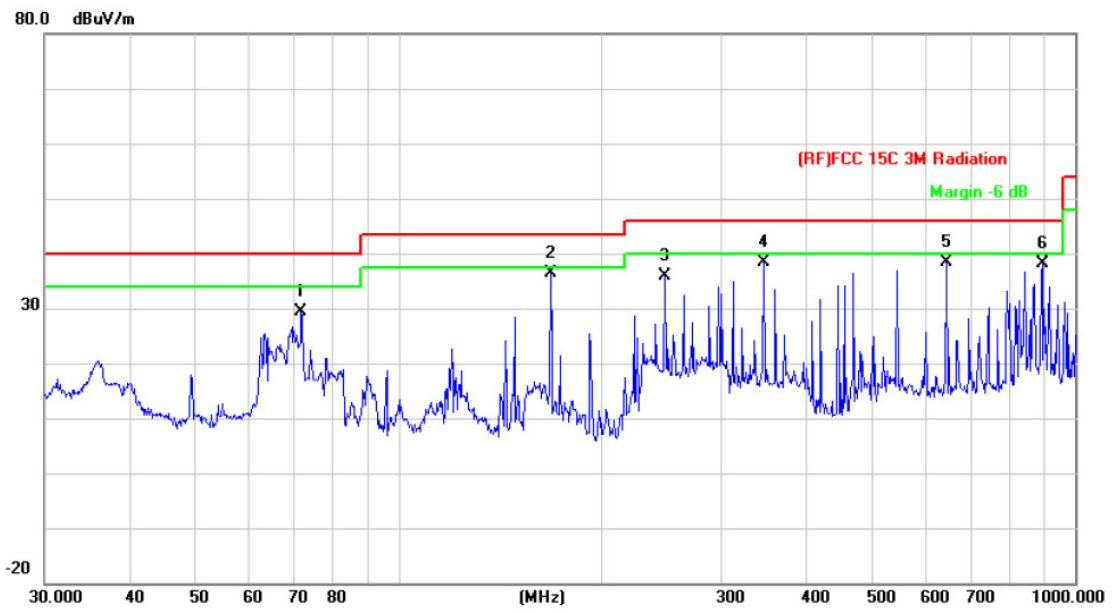

No.	Mk.	Freq. MHz	Reading Level dBuV	Correct Factor dB/m	Measure- ment dBuV/m	Limit dBuV/m	Over dB	Detector
1		71.8319	53.73	-24.23	29.50	40.00	-10.50	peak
2	*	167.8240	58.64	-22.18	36.46	43.50	-7.04	peak
3		247.6819	55.53	-19.62	35.91	46.00	-10.09	peak
4		346.8091	54.77	-16.51	38.26	46.00	-7.74	peak
5		645.1195	49.62	-11.15	38.47	46.00	-7.53	peak
6		893.8567	46.45	-8.22	38.23	46.00	-7.77	peak

*:Maximum data x:Over limit !:over margin

Emission Level= Read Level+ Correct Factor

EUT:	WarriorG1	Model:	XM-JPG1-2
Temperature:	25 °C	Relative Humidity:	55%
Test Voltage:	DC 3.6V		
Ant. Pol.	Vertical		
Test Mode:	TX B Mode 2462MHz		
Remark:	Only worse case is reported		

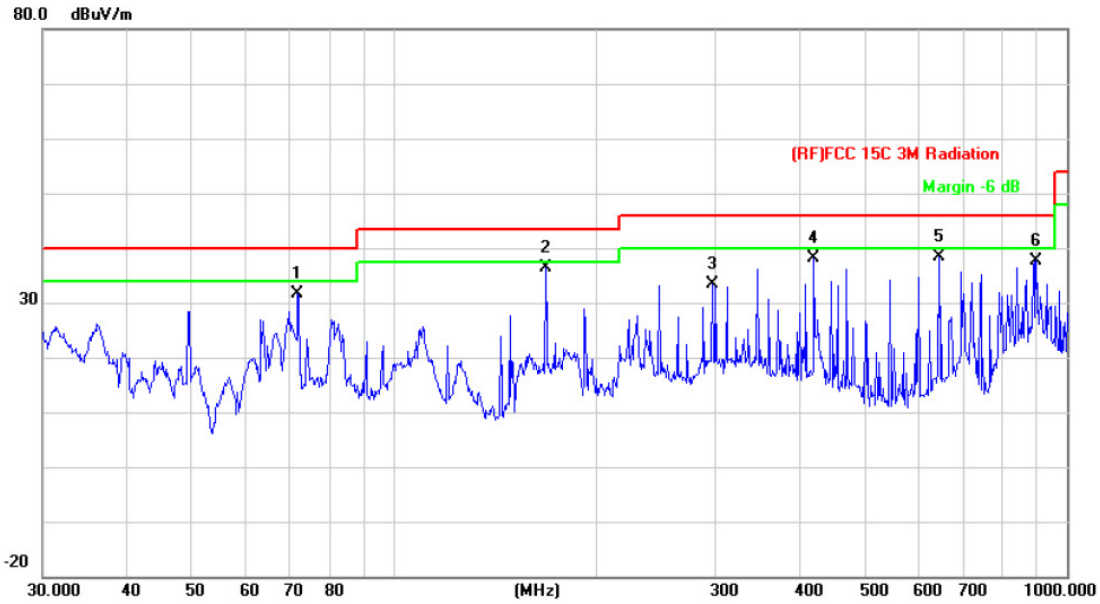

No.	Mk.	Freq. MHz	Reading Level dBuV	Correct Factor dB/m	Measure- ment dBuV/m	Limit dBuV/m	Over dB	Detector
1		71.8319	55.82	-24.23	31.59	40.00	-8.41	peak
2	*	167.8240	58.62	-22.18	36.44	43.50	-7.06	peak
3		297.2241	52.08	-18.69	33.39	46.00	-12.61	peak
4		420.5803	52.97	-14.84	38.13	46.00	-7.87	peak
5		645.1195	49.62	-11.15	38.47	46.00	-7.53	peak
6		900.1471	45.54	-7.99	37.55	46.00	-8.45	peak

*:Maximum data x:Over limit !:over margin

Emission Level= Read Level+ Correct Factor

EUT:	WarriorG1	Model:	XM-JPG1-2
Temperature:	25 °C	Relative Humidity:	55%
Test Voltage:	DC 3.6V		
Ant. Pol.	Horizontal		
Test Mode:	TX B Mode 2412MHz		
Remark:	No report for the emission which more than 10 dB below the prescribed limit.		

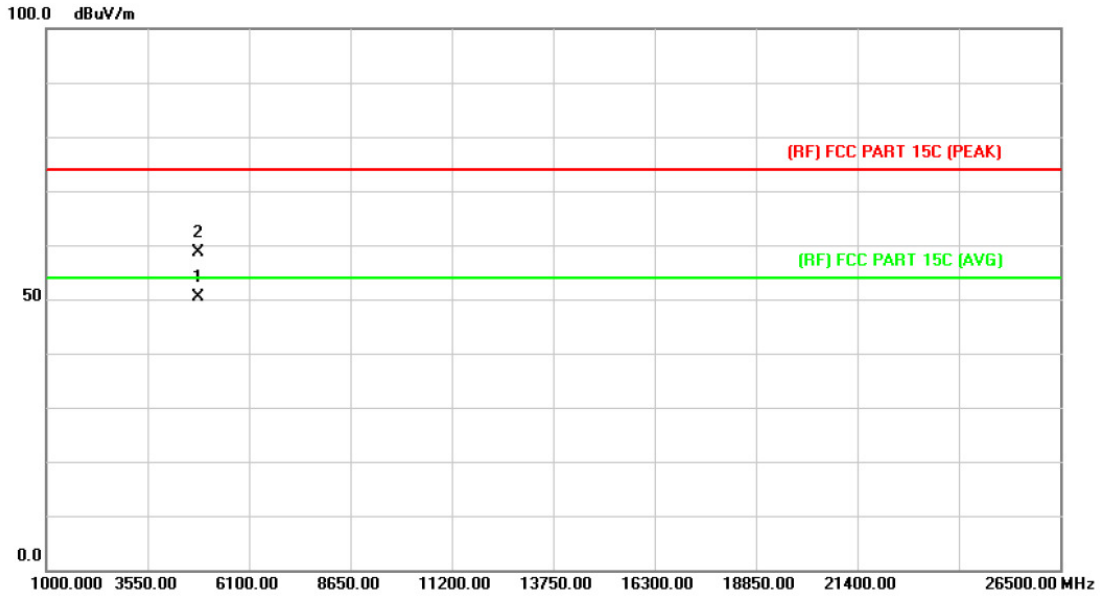

No.	Mk.	Freq.	Reading Level	Correct Factor	Measurement	Limit	Over	Detector
		MHz	dBuV	dB/m	dBuV/m	dBuV/m	dB	
1	*	4824.311	36.78	13.56	50.34	54.00	-3.66	AVG
2		4824.652	45.11	13.56	58.67	74.00	-15.33	peak

Emission Level= Read Level+ Correct Factor

EUT:	WarriorG1	Model:	XM-JPG1-2
Temperature:	25 °C	Relative Humidity:	55%
Test Voltage:	DC 3.6V		
Ant. Pol.	Vertical		
Test Mode:	TX B Mode 2412MHz		
Remark:	No report for the emission which more than 10 dB below the prescribed limit.		

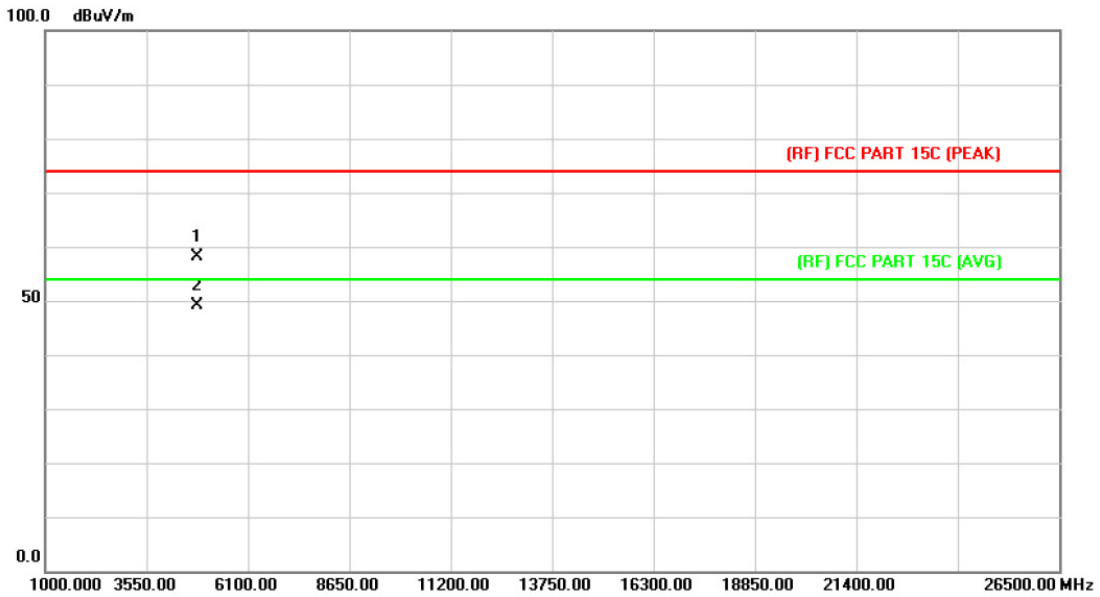

No.	Mk.	Freq.	Reading Level	Correct Factor	Measurement	Limit	Over	Detector
		MHz	dBuV	dB/m	dBuV/m	dBuV/m	dB	
1		4823.674	44.59	13.56	58.15	74.00	-15.85	peak
2	*	4824.034	35.65	13.56	49.21	54.00	-4.79	AVG

Emission Level= Read Level+ Correct Factor

EUT:	WarriorG1	Model:	XM-JPG1-2
Temperature:	25 °C	Relative Humidity:	55%
Test Voltage:	DC 3.6V		
Ant. Pol.	Horizontal		
Test Mode:	TX B Mode 2437MHz		
Remark:	No report for the emission which more than 10 dB below the prescribed limit.		

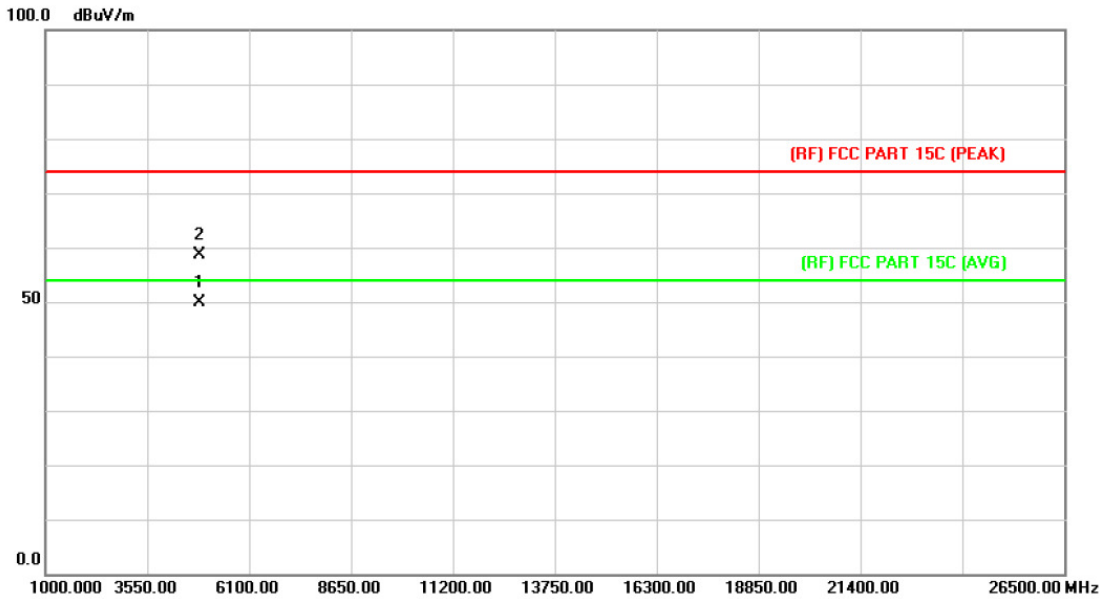

No.	Mk.	Freq. MHz	Reading Level dBuV	Correct Factor dB/m	Measure- ment dBuV/m	Limit dBuV/m	Over dB	Detector
1	*	4873.025	36.01	13.86	49.87	54.00	-4.13	AVG
2		4874.210	44.78	13.86	58.64	74.00	-15.36	peak

Emission Level= Read Level+ Correct Factor

EUT:	WarriorG1	Model:	XM-JPG1-2
Temperature:	25 °C	Relative Humidity:	55%
Test Voltage:	DC 3.6V		
Ant. Pol.	Vertical		
Test Mode:	TX B Mode 2437MHz		
Remark:	No report for the emission which more than 10 dB below the prescribed limit.		

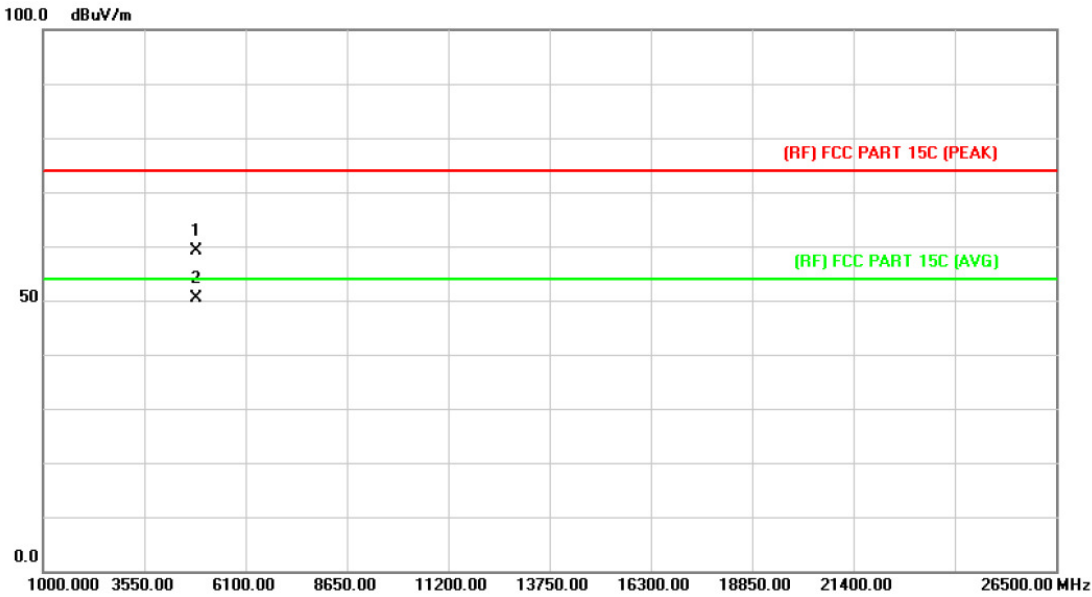

No.	Mk.	Freq. MHz	Reading Level dBuV	Correct Factor dB/m	Measure- ment dBuV/m	Limit dBuV/m	Over dB	Detector
1		4874.314	45.38	13.86	59.24	74.00	-14.76	peak
2	*	4874.351	36.48	13.86	50.34	54.00	-3.66	AVG

Emission Level= Read Level+ Correct Factor

EUT:	WarriorG1	Model:	XM-JPG1-2
Temperature:	25 °C	Relative Humidity:	55%
Test Voltage:	DC 3.6V		
Ant. Pol.	Horizontal		
Test Mode:	TX B Mode 2462MHz		
Remark:	No report for the emission which more than 10 dB below the prescribed limit.		

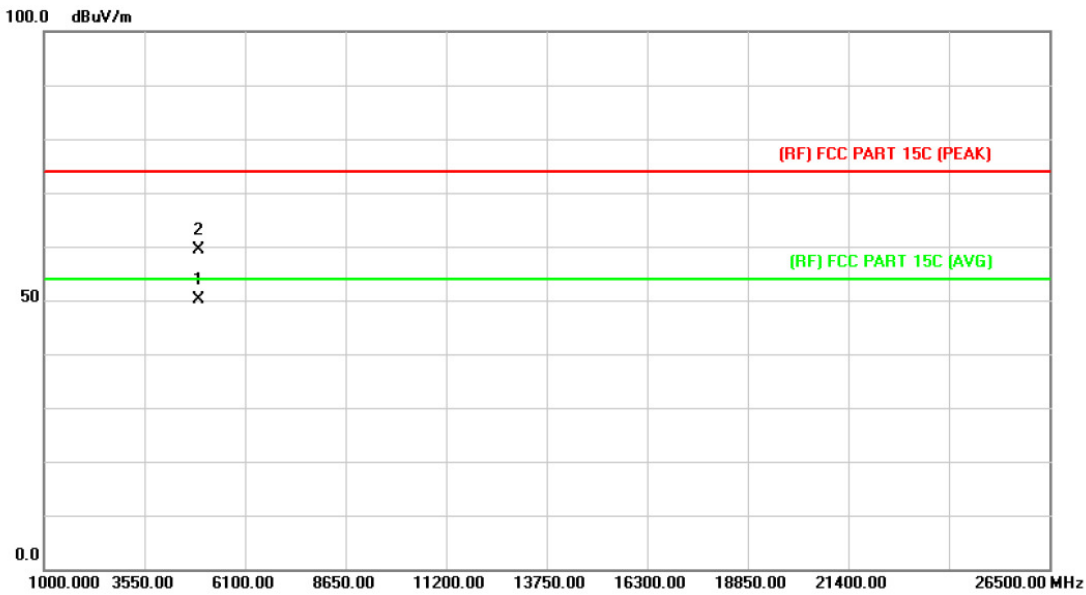

No.	Mk.	Freq.	Reading Level	Correct Factor	Measurement	Limit	Over	Detector
		MHz	dBuV	dB/m	dBuV/m	dBuV/m	dB	
1	*	4923.687	35.86	14.15	50.01	54.00	-3.99	AVG
2		4924.064	45.22	14.15	59.37	74.00	-14.63	peak

Emission Level= Read Level+ Correct Factor

EUT:	WarriorG1	Model:	XM-JPG1-2
Temperature:	25 °C	Relative Humidity:	55%
Test Voltage:	DC 3.6V		
Ant. Pol.	Vertical		
Test Mode:	TX B Mode 2462MHz		
Remark:	No report for the emission which more than 10 dB below the prescribed limit.		

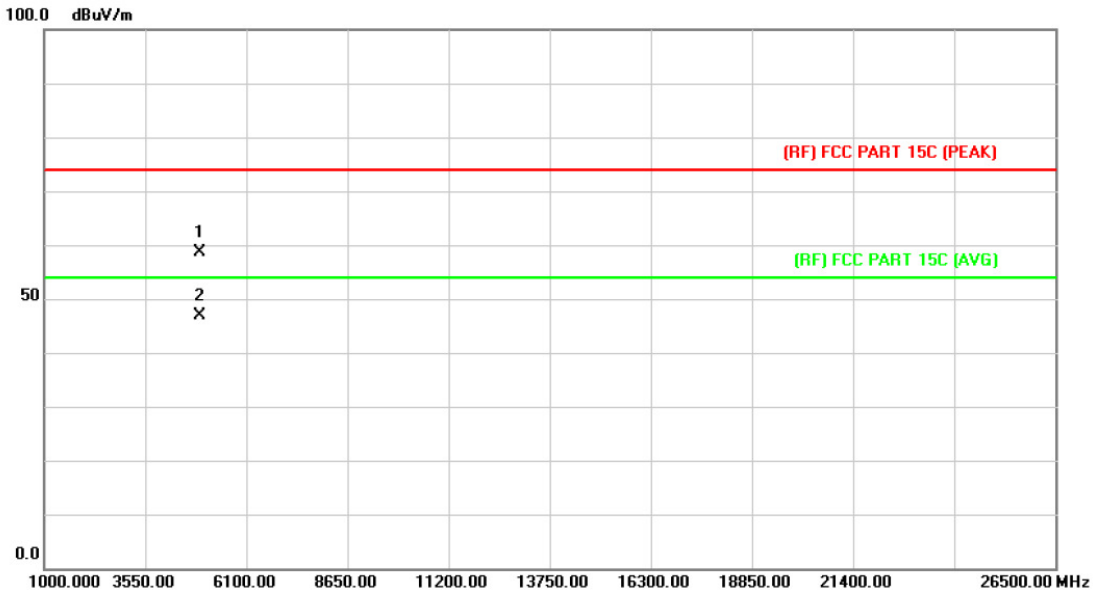

No.	Mk.	Freq.	Reading Level	Correct Factor	Measurement	Limit	Over	Detector
		MHz	dBuV	dB/m	dBuV/m	dBuV/m	dB	
1		4923.974	44.54	14.15	58.69	74.00	-15.31	peak
2	*	4924.310	32.72	14.15	46.87	54.00	-7.13	AVG

Emission Level= Read Level+ Correct Factor

EUT:	WarriorG1	Model:	XM-JPG1-2
Temperature:	25 °C	Relative Humidity:	55%
Test Voltage:	DC 3.6V		
Ant. Pol.	Horizontal		
Test Mode:	TX G Mode 2412MHz		
Remark:	No report for the emission which more than 10 dB below the prescribed limit.		

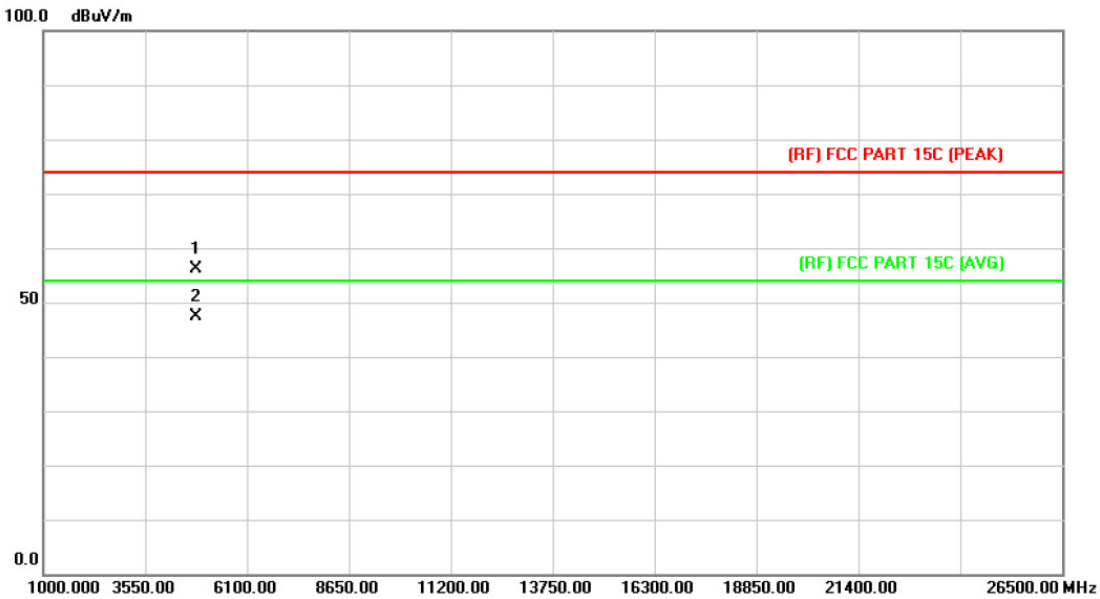

No.	Mk.	Freq.	Reading Level	Correct Factor	Measurement	Limit	Over	Detector
		MHz	dBuV	dB/m	dBuV/m	dBuV/m	dB	
1		4823.974	42.61	13.56	56.17	74.00	-17.83	peak
2	*	4824.067	33.82	13.56	47.38	54.00	-6.62	AVG

Emission Level= Read Level+ Correct Factor

EUT:	WarriorG1	Model:	XM-JPG1-2
Temperature:	25 °C	Relative Humidity:	55%
Test Voltage:	DC 3.6V		
Ant. Pol.	Vertical		
Test Mode:	TX G Mode 2412MHz		
Remark:	No report for the emission which more than 10 dB below the prescribed limit.		

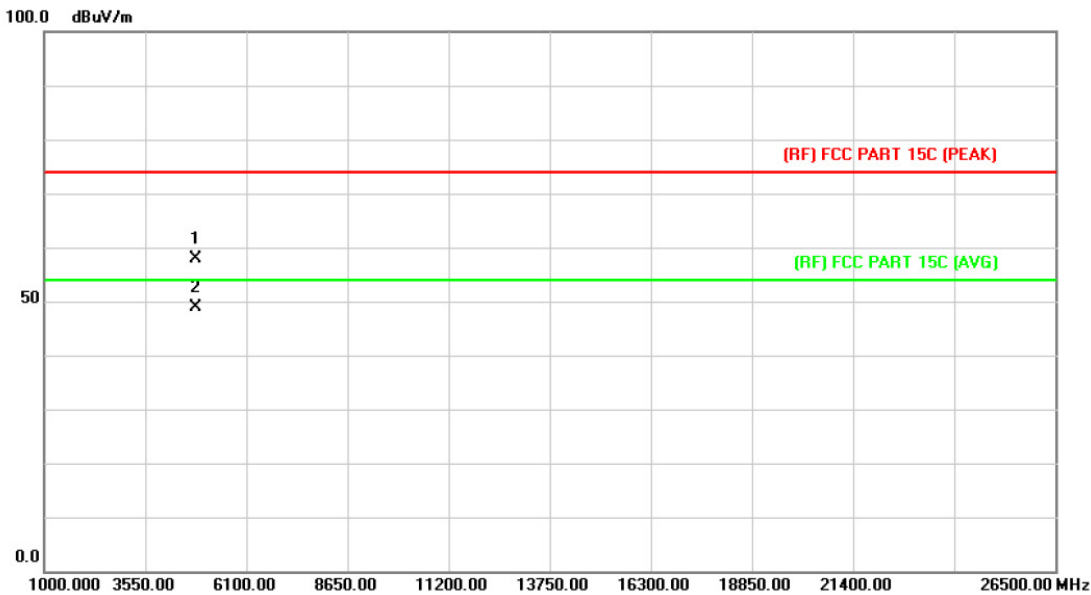

No.	Mk.	Freq. MHz	Reading Level dBuV	Correct Factor dB/m	Measure- ment dBuV/m	Limit dBuV/m	Over dB	Detector
1		4824.287	44.33	13.56	57.89	74.00	-16.11	peak
2	*	4824.317	35.20	13.56	48.76	54.00	-5.24	AVG

Emission Level= Read Level+ Correct Factor

EUT:	WarriorG1	Model:	XM-JPG1-2
Temperature:	25 °C	Relative Humidity:	55%
Test Voltage:	DC 3.6V		
Ant. Pol.	Horizontal		
Test Mode:	TX G Mode 2437MHz		
Remark:	No report for the emission which more than 10 dB below the prescribed limit.		

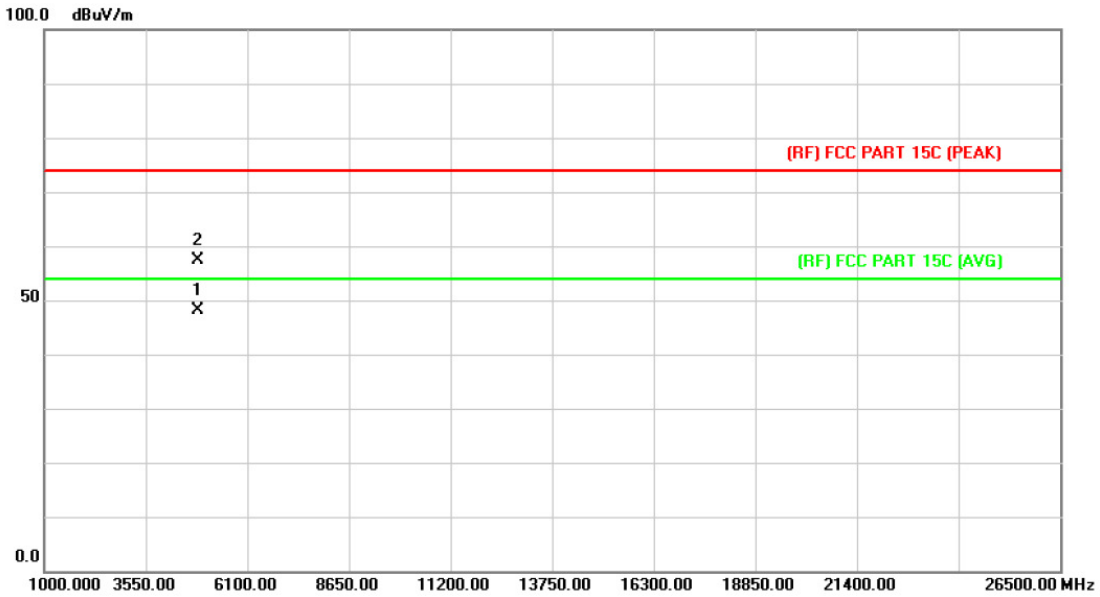

No.	Mk.	Freq.	Reading Level	Correct Factor	Measurement	Limit	Over	Detector
		MHz	dBuV	dB/m	dBuV/m	dBuV/m	dB	
1	*	4874.349	34.32	13.86	48.18	54.00	-5.82	AVG
2		4874.366	43.49	13.86	57.35	74.00	-16.65	peak

Emission Level= Read Level+ Correct Factor

EUT:	WarriorG1	Model:	XM-JPG1-2
Temperature:	25 °C	Relative Humidity:	55%
Test Voltage:	DC 3.6V		
Ant. Pol.	Vertical		
Test Mode:	TX G Mode 2437MHz		
Remark:	No report for the emission which more than 10 dB below the prescribed limit.		

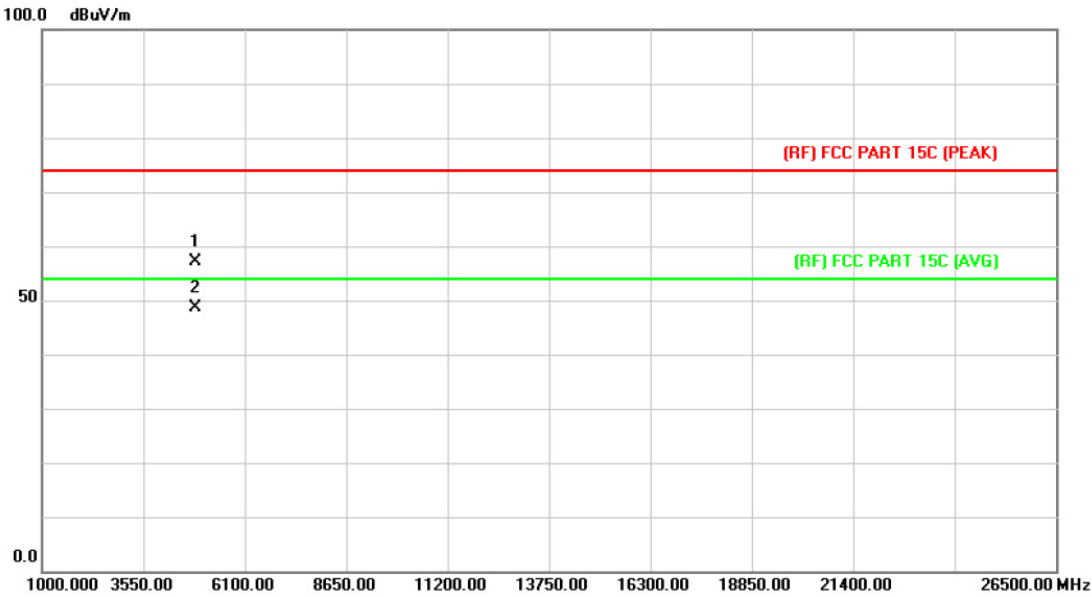

No.	Mk.	Freq. MHz	Reading Level dBuV	Correct Factor dB/m	Measure- ment dBuV/m	Limit dBuV/m	Over dB	Detector
1		4874.598	43.38	13.86	57.24	74.00	-16.76	peak
2	*	4874.641	34.81	13.86	48.67	54.00	-5.33	AVG

Emission Level= Read Level+ Correct Factor

EUT:	WarriorG1	Model:	XM-JPG1-2
Temperature:	25 °C	Relative Humidity:	55%
Test Voltage:	DC 3.6V		
Ant. Pol.	Horizontal		
Test Mode:	TX G Mode 2462MHz		
Remark:	No report for the emission which more than 10 dB below the prescribed limit.		

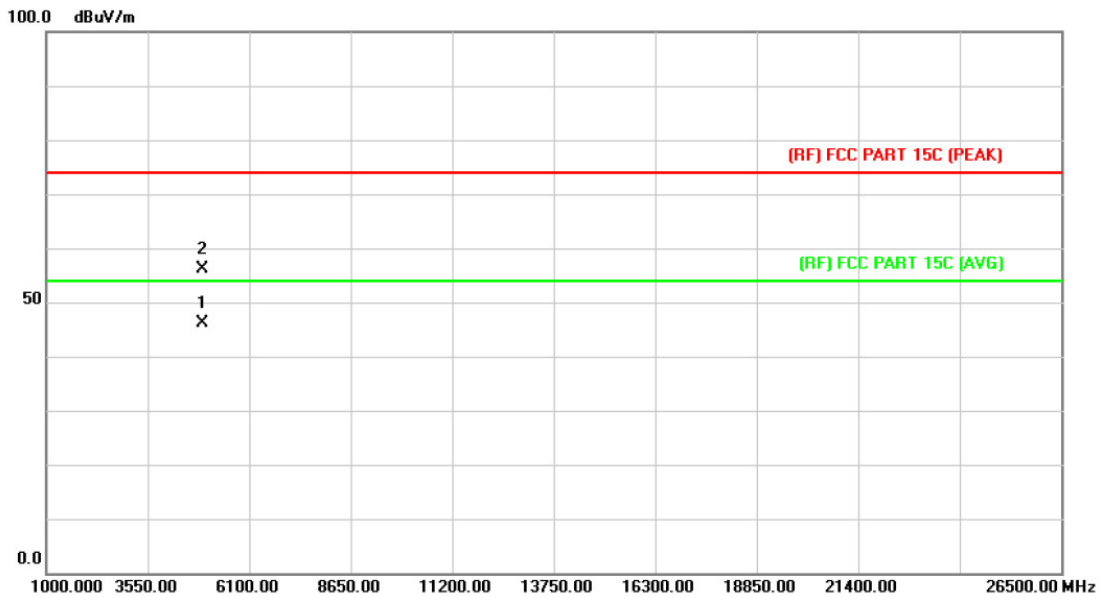

No.	Mk.	Freq. MHz	Reading Level dBuV	Correct Factor dB/m	Measure- ment dBuV/m	Limit dBuV/m	Over dB	Detector
1	*	4923.678	32.07	14.15	46.22	54.00	-7.78	AVG
2		4924.351	42.09	14.15	56.24	74.00	-17.76	peak

Emission Level= Read Level+ Correct Factor

EUT:	WarriorG1	Model:	XM-JPG1-2
Temperature:	25 °C	Relative Humidity:	55%
Test Voltage:	DC 3.6V		
Ant. Pol.	Vertical		
Test Mode:	TX G Mode 2462MHz		
Remark:	No report for the emission which more than 10 dB below the prescribed limit.		

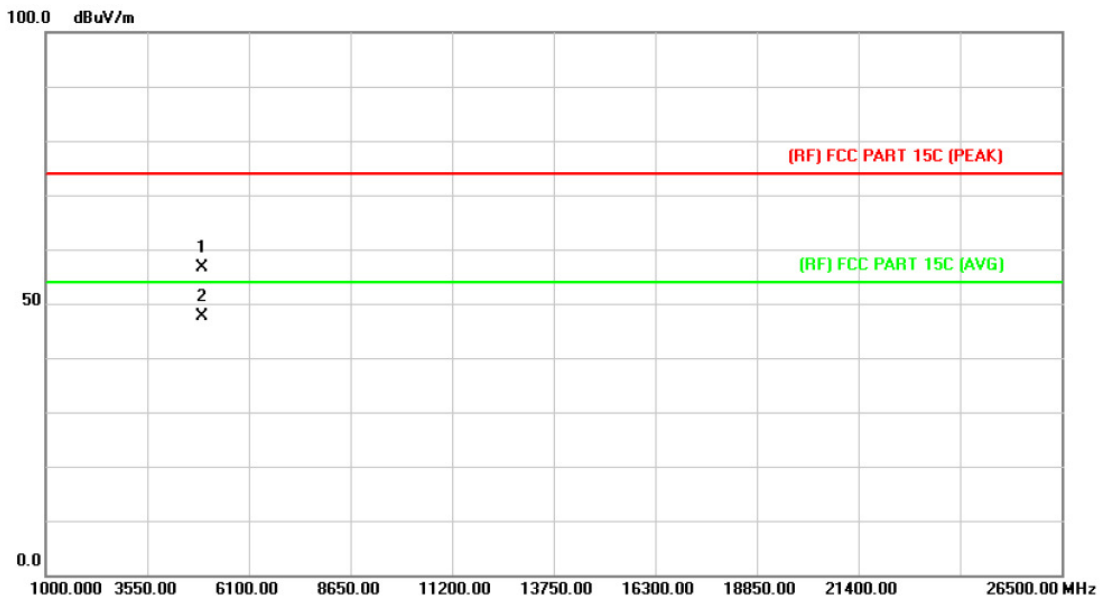

No.	Mk.	Freq.	Reading Level	Correct Factor	Measurement	Limit	Over	Detector
		MHz	dBuV	dB/m	dBuV/m	dBuV/m	dB	
1		4923.641	42.39	14.15	56.54	74.00	-17.46	peak
2	*	4924.312	33.53	14.15	47.68	54.00	-6.32	AVG

Emission Level= Read Level+ Correct Factor

EUT:	WarriorG1	Model:	XM-JPG1-2
Temperature:	25 °C	Relative Humidity:	55%
Test Voltage:	DC 3.6V		
Ant. Pol.	Horizontal		
Test Mode:	TX N(HT20) Mode 2412MHz		
Remark:	No report for the emission which more than 10 dB below the prescribed limit.		

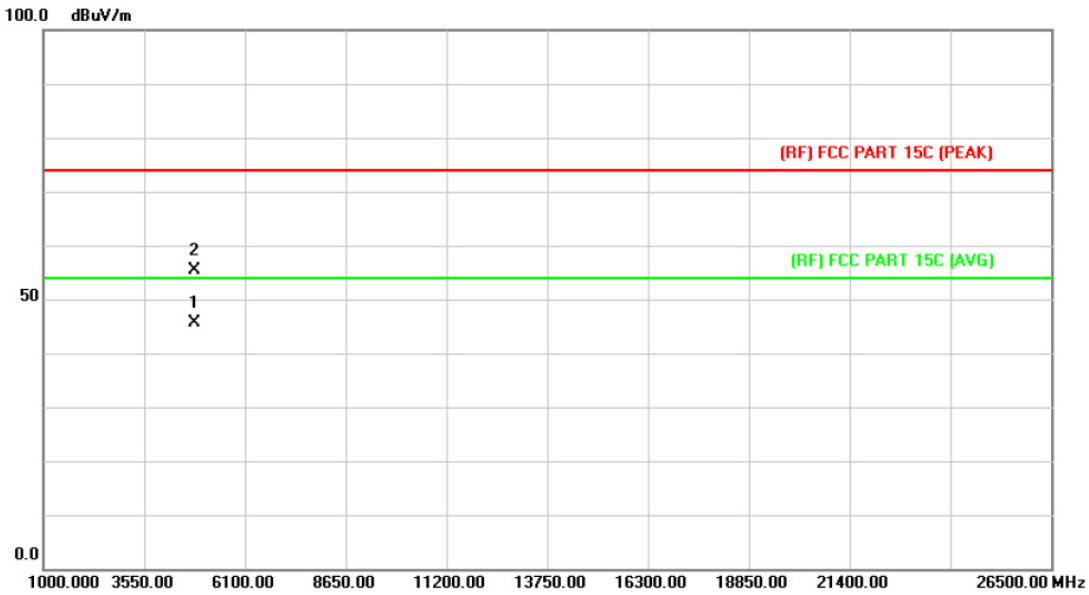

No.	Mk.	Freq.	Reading Level	Correct Factor	Measurement	Limit	Over	Detector
		MHz	dBuV	dB/m	dBuV/m	dBuV/m	dB	
1	*	4823.654	32.12	13.56	45.68	54.00	-8.32	AVG
2		4824.254	41.81	13.56	55.37	74.00	-18.63	peak

Emission Level= Read Level+ Correct Factor

EUT:	WarriorG1	Model:	XM-JPG1-2
Temperature:	25 °C	Relative Humidity:	55%
Test Voltage:	DC 3.6V		
Ant. Pol.	Vertical		
Test Mode:	TX N(HT20) Mode 2412MHz		
Remark:	No report for the emission which more than 10 dB below the prescribed limit.		

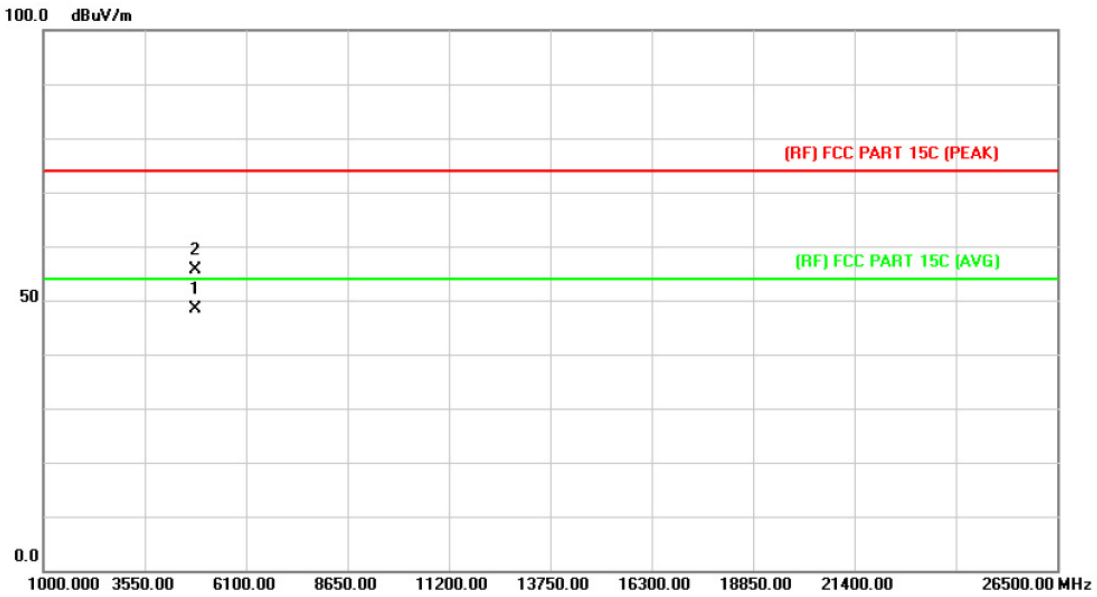

No.	Mk.	Freq.	Reading Level	Correct Factor	Measurement	Limit	Over	Detector
		MHz	dBuV	dB/m	dBuV/m	dBuV/m	dB	
1	*	4824.541	34.78	13.56	48.34	54.00	-5.66	AVG
2		4824.658	42.08	13.56	55.64	74.00	-18.36	peak

Emission Level= Read Level+ Correct Factor

EUT:	WarriorG1	Model:	XM-JPG1-2
Temperature:	25 °C	Relative Humidity:	55%
Test Voltage:	DC 3.6V		
Ant. Pol.	Horizontal		
Test Mode:	TX N(HT20) Mode 2437MHz		
Remark:	No report for the emission which more than 10 dB below the prescribed limit.		

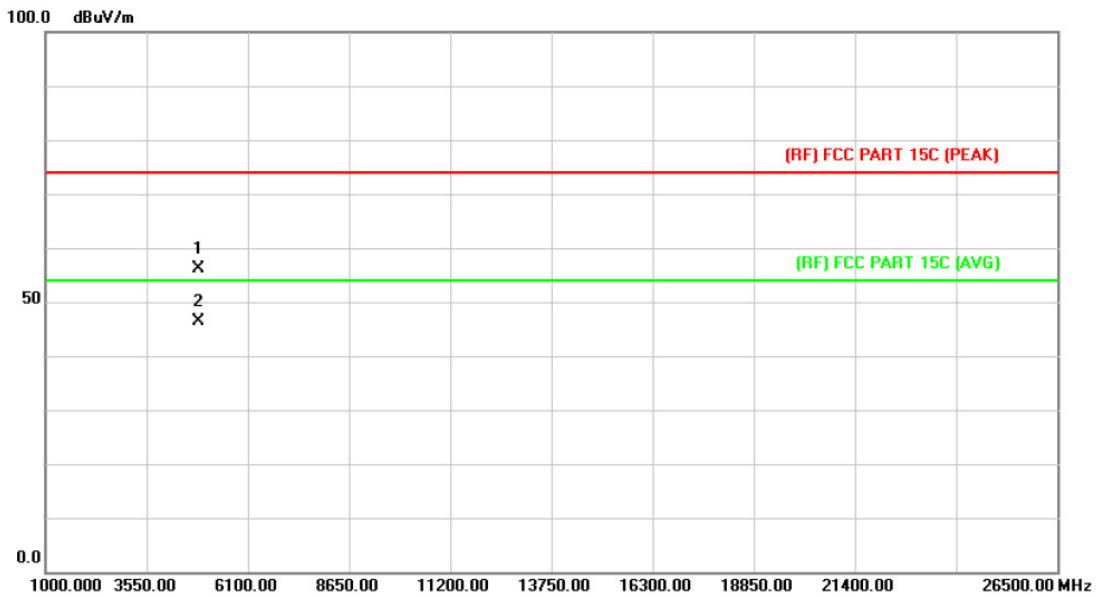

No.	Mk.	Freq.	Reading Level	Correct Factor	Measurement	Limit	Over	Detector
		MHz	dBuV	dB/m	dBuV/m	dBuV/m	dB	
1		4874.058	42.22	13.86	56.08	74.00	-17.92	peak
2	*	4874.298	32.52	13.86	46.38	54.00	-7.62	AVG

Emission Level= Read Level+ Correct Factor

EUT:	WarriorG1	Model:	XM-JPG1-2
Temperature:	25 °C	Relative Humidity:	55%
Test Voltage:	DC 3.6V		
Ant. Pol.	Vertical		
Test Mode:	TX N(HT20) Mode 2437MHz		
Remark:	No report for the emission which more than 10 dB below the prescribed limit.		

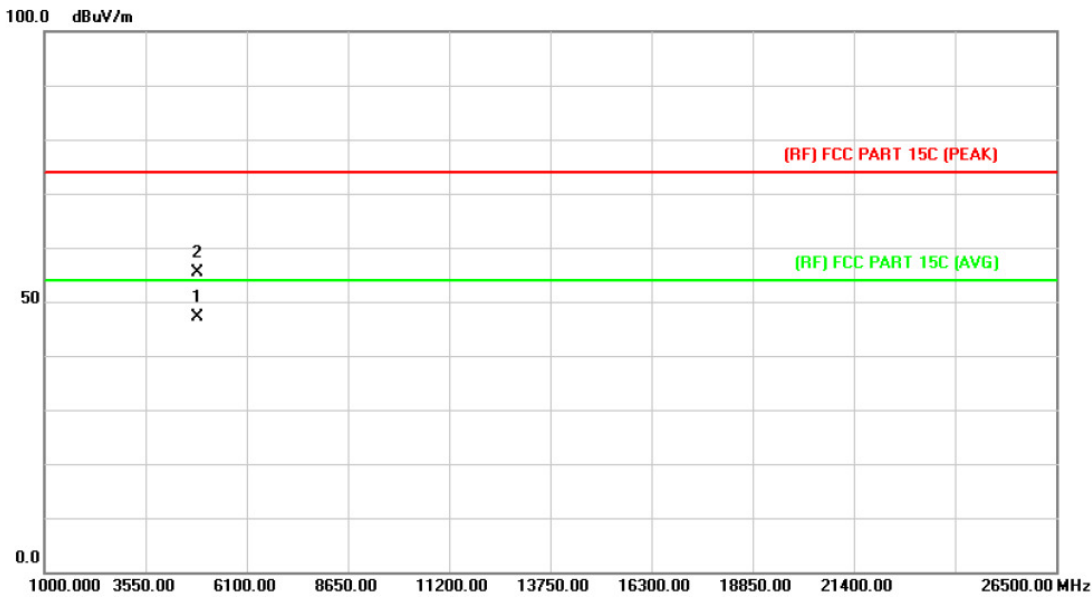

No.	Mk.	Freq.	Reading Level	Correct Factor	Measurement	Limit	Over	Detector
		MHz	dBuV	dB/m	dBuV/m	dBuV/m	dB	
1	*	4873.854	33.35	13.86	47.21	54.00	-6.79	AVG
2		4874.651	41.52	13.86	55.38	74.00	-18.62	peak

Emission Level= Read Level+ Correct Factor

EUT:	WarriorG1	Model:	XM-JPG1-2
Temperature:	25 °C	Relative Humidity:	55%
Test Voltage:	DC 3.6V		
Ant. Pol.	Horizontal		
Test Mode:	TX N(HT20) Mode 2462MHz		
Remark:	No report for the emission which more than 10 dB below the prescribed limit.		

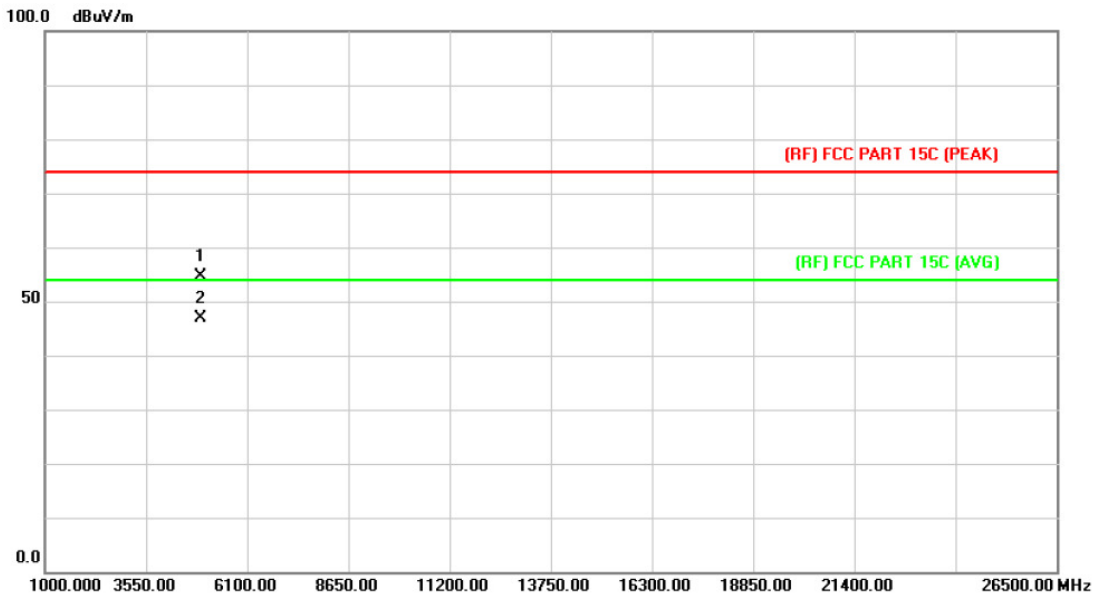

No.	Mk.	Freq.	Reading Level	Correct Factor	Measurement	Limit	Over	Detector
		MHz	dBuV	dB/m	dBuV/m	dBuV/m	dB	
1		4923.899	40.53	14.15	54.68	74.00	-19.32	peak
2	*	4924.158	32.72	14.15	46.87	54.00	-7.13	AVG

Emission Level= Read Level+ Correct Factor

EUT:	WarriorG1	Model:	XM-JPG1-2
Temperature:	25 °C	Relative Humidity:	55%
Test Voltage:	DC 3.6V		
Ant. Pol.	Vertical		
Test Mode:	TX N(HT20) Mode 2462MHz		
Remark:	No report for the emission which more than 10 dB below the prescribed limit.		

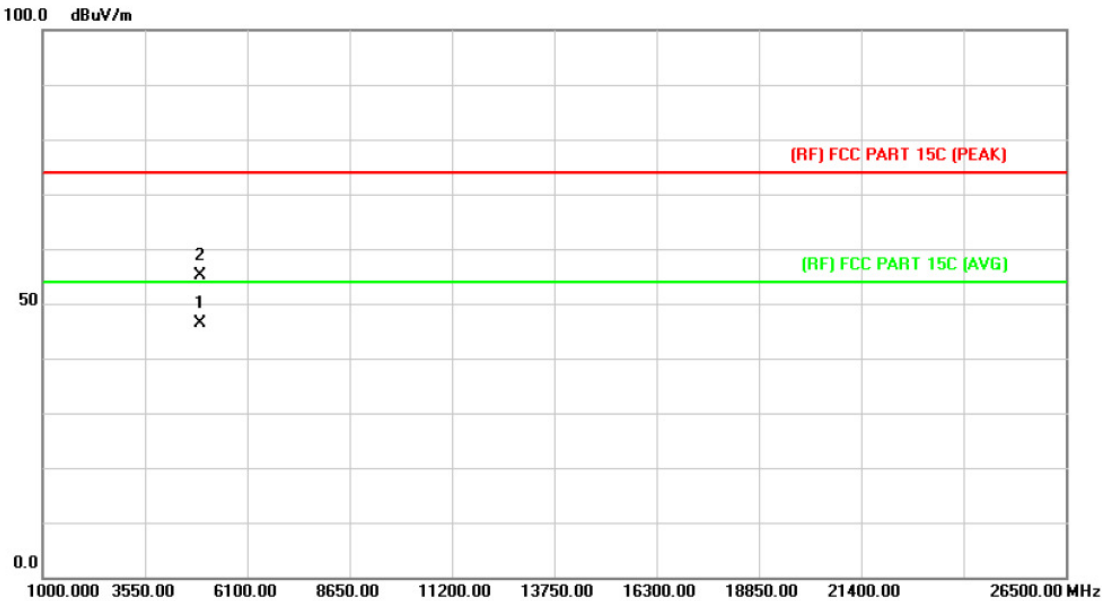

No.	Mk.	Freq. MHz	Reading Level dBuV	Correct Factor dB/m	Measure- ment dBuV/m	Limit dBuV/m	Over dB	Detector
1	*	4924.084	32.17	14.15	46.32	54.00	-7.68	AVG
2		4924.485	40.94	14.15	55.09	74.00	-18.91	peak

Emission Level= Read Level+ Correct Factor

EUT:	WarriorG1	Model:	XM-JPG1-2
Temperature:	25 °C	Relative Humidity:	55%
Test Voltage:	DC 3.6V		
Ant. Pol.	Horizontal		
Test Mode:	TX N(HT40) Mode 2422MHz		
Remark:	No report for the emission which more than 10 dB below the prescribed limit.		

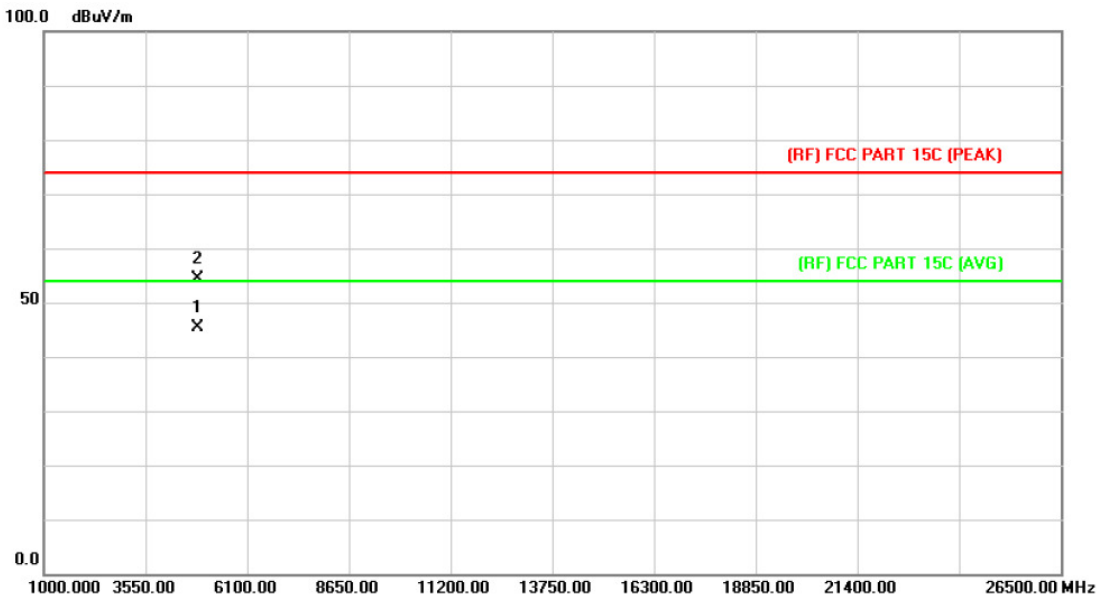

No.	Mk.	Freq. MHz	Reading Level dBuV	Correct Factor dB/m	Measure- ment dBuV/m	Limit dBuV/m	Over dB	Detector
1	*	4843.174	31.63	13.68	45.31	54.00	-8.69	AVG
2		4844.251	40.58	13.68	54.26	74.00	-19.74	peak

Emission Level= Read Level+ Correct Factor

EUT:	WarriorG1	Model:	XM-JPG1-2
Temperature:	25 °C	Relative Humidity:	55%
Test Voltage:	DC 3.6V		
Ant. Pol.	Vertical		
Test Mode:	TX N(HT40) Mode 2422MHz		
Remark:	No report for the emission which more than 10 dB below the prescribed limit.		

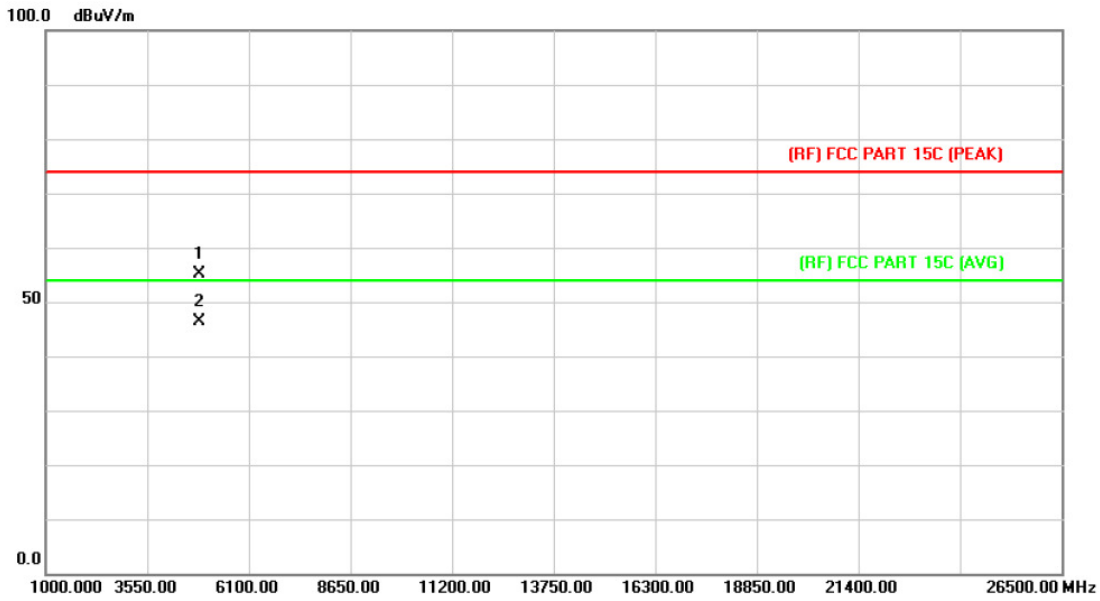

No.	Mk.	Freq.	Reading Level	Correct Factor	Measurement	Limit	Over	Detector
		MHz	dBuV	dB/m	dBuV/m	dBuV/m	dB	
1		4843.854	41.34	13.68	55.02	74.00	-18.98	peak
2	*	4844.621	32.64	13.68	46.32	54.00	-7.68	AVG

Emission Level= Read Level+ Correct Factor

EUT:	WarriorG1	Model:	XM-JPG1-2
Temperature:	25 °C	Relative Humidity:	55%
Test Voltage:	DC 3.6V		
Ant. Pol.	Horizontal		
Test Mode:	TX N(HT40) Mode 2437MHz		
Remark:	No report for the emission which more than 10 dB below the prescribed limit.		

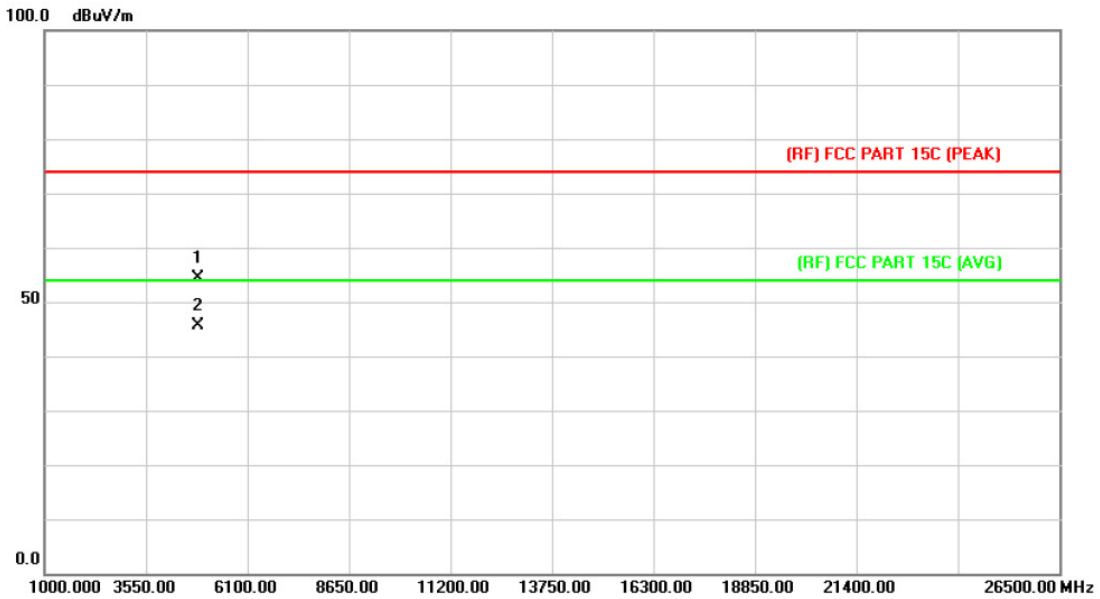

No.	Mk.	Freq.	Reading Level	Correct Factor	Measurement	Limit	Over	
		MHz	dBuV	dB/m	dBuV/m	dBuV/m	dB	Detector
1		4873.845	40.40	13.86	54.26	74.00	-19.74	peak
2	*	4874.365	31.81	13.86	45.67	54.00	-8.33	AVG

Emission Level= Read Level+ Correct Factor

EUT:	WarriorG1	Model:	XM-JPG1-2
Temperature:	25 °C	Relative Humidity:	55%
Test Voltage:	DC 3.6V		
Ant. Pol.	Vertical		
Test Mode:	TX N(HT40) Mode 2437MHz		
Remark:	No report for the emission which more than 10 dB below the prescribed limit.		

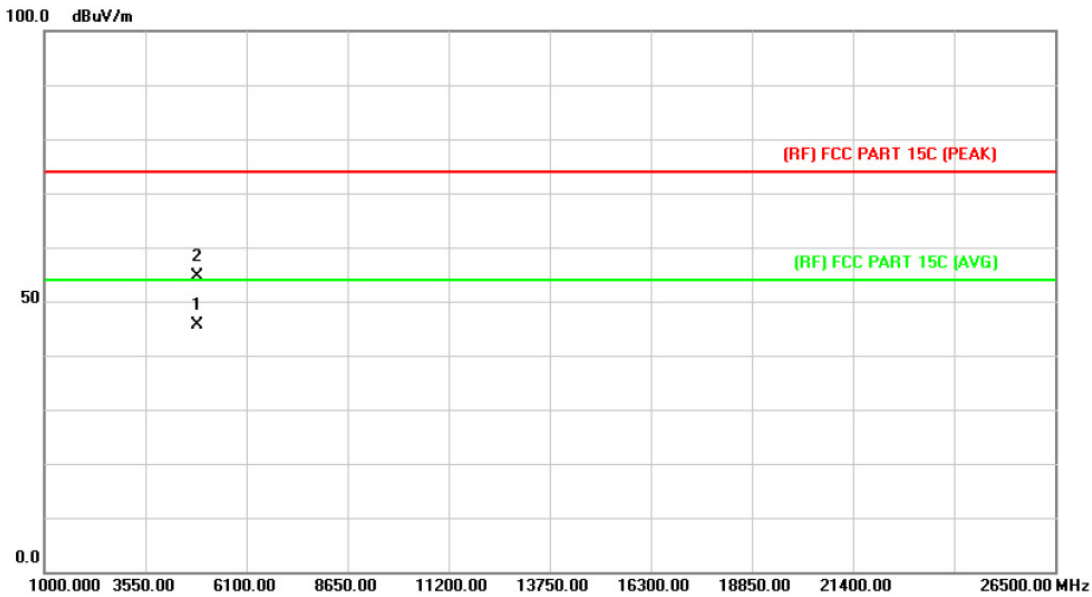

No.	Mk.	Freq. MHz	Reading Level dBuV	Correct Factor dB/m	Measure- ment dBuV/m	Limit dBuV/m	Over dB	Detector
1	*	4874.254	31.82	13.86	45.68	54.00	-8.32	AVG
2		4874.325	40.83	13.86	54.69	74.00	-19.31	peak

Emission Level= Read Level+ Correct Factor

EUT:	WarriorG1	Model:	XM-JPG1-2
Temperature:	25 °C	Relative Humidity:	55%
Test Voltage:	DC 3.6V		
Ant. Pol.	Horizontal		
Test Mode:	TX N(HT40) Mode 2452MHz		
Remark:	No report for the emission which more than 10 dB below the prescribed limit.		

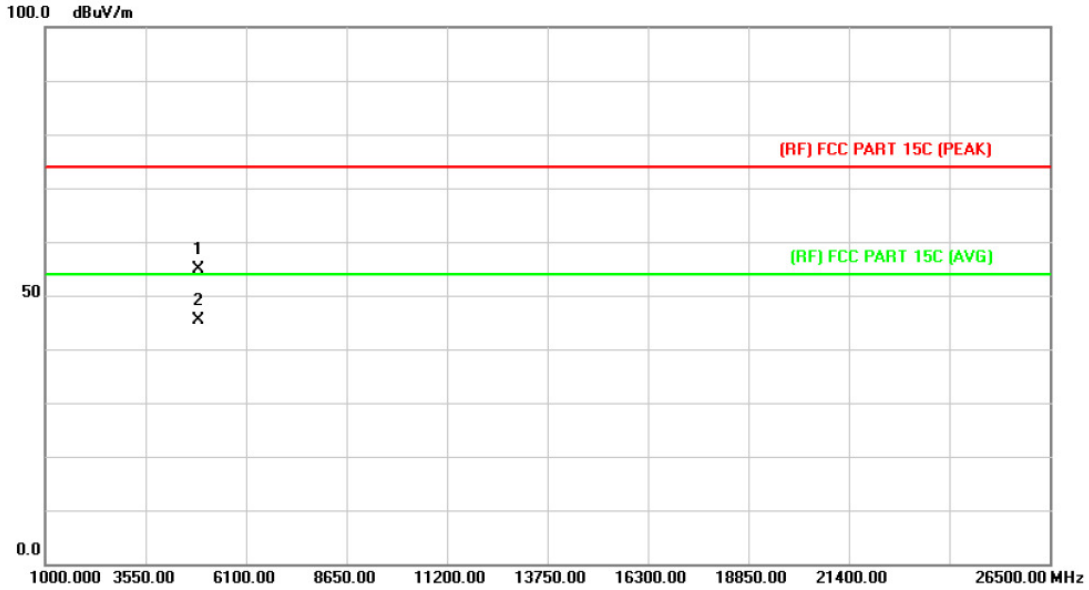

No.	Mk.	Freq.	Reading Level	Correct Factor	Measurement	Limit	Over	Detector
		MHz	dBuV	dB/m	dBuV/m	dBuV/m	dB	
1		4904.021	40.95	14.03	54.98	74.00	-19.02	peak
2	*	4904.670	31.33	14.03	45.36	54.00	-8.64	AVG

Emission Level= Read Level+ Correct Factor

EUT:	WarriorG1	Model:	XM-JPG1-2
Temperature:	25 °C	Relative Humidity:	55%
Test Voltage:	DC 3.6V		
Ant. Pol.	Vertical		
Test Mode:	TX N(HT40) Mode 2452MHz		
Remark:	No report for the emission which more than 10 dB below the prescribed limit.		

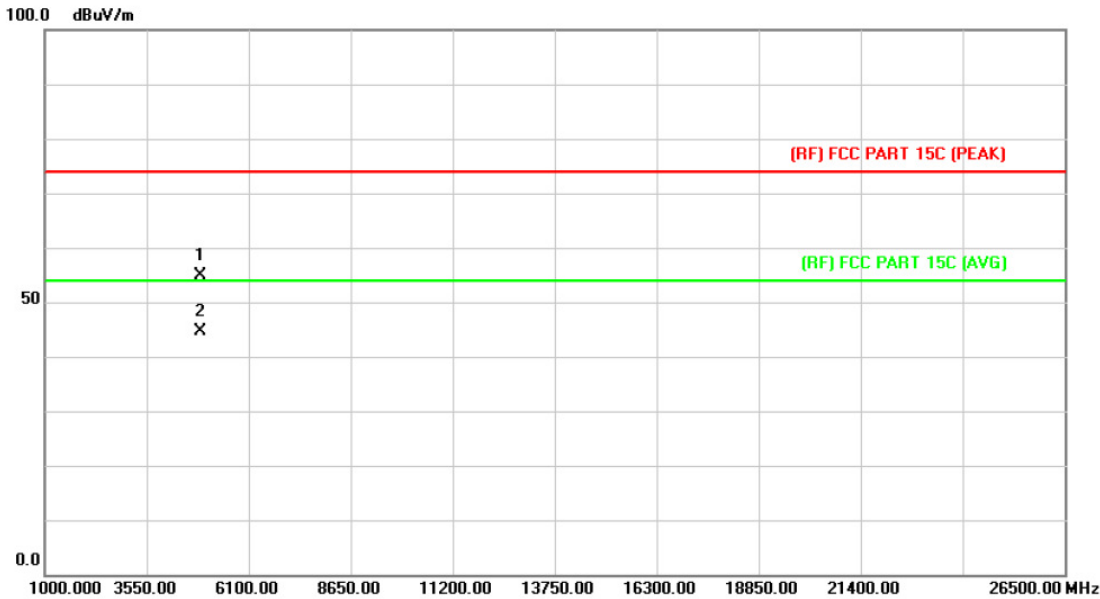

No.	Mk.	Freq. MHz	Reading Level dBuV	Correct Factor dB/m	Measure- ment dBuV/m	Limit dBuV/m	Over dB	Detector
1		4903.988	40.86	14.03	54.89	74.00	-19.11	peak
2	*	4904.351	30.66	14.03	44.69	54.00	-9.31	AVG

Emission Level= Read Level+ Correct Factor

6. Restricted Bands Requirement

6.1 Test Standard and Limit

6.1.1 Test Standard

FCC Part 15.209 FCC Part 15.205

6.1.2 Test Limit

Restricted Frequency Band (MHz)	Class B (dBuV/m)(at 3 M)	
	Peak	Average
2310 ~2390	74	54
2483.5 ~2500	74	54

6.2 Test Setup

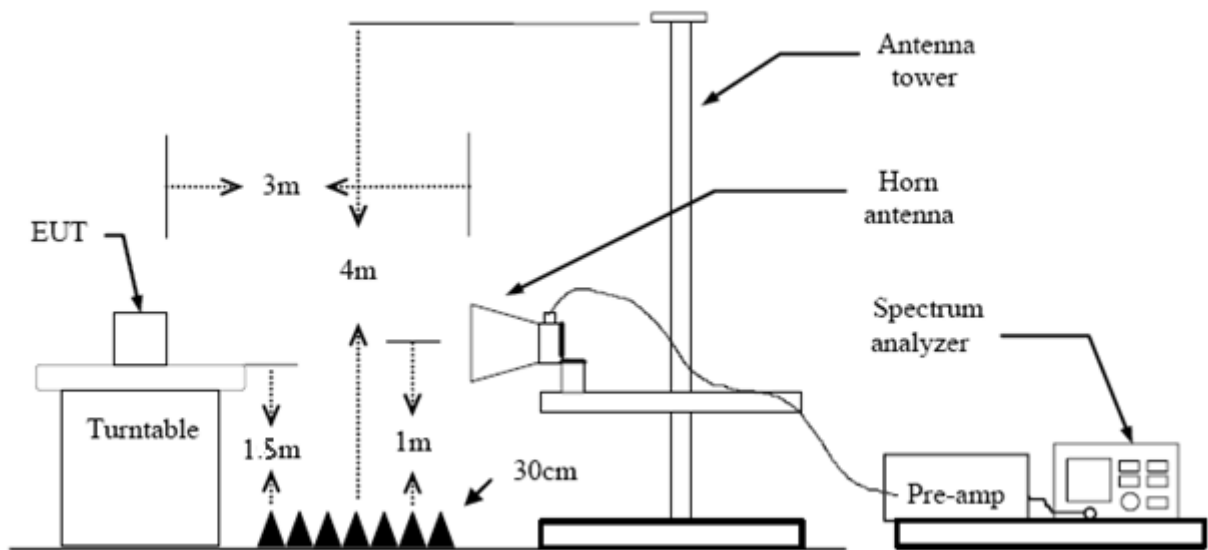

6.3 Test Procedure

- (1) The measuring distance of 3m shall be used for measurements at frequency up to 1GHz and above 1 GHz. The EUT was placed on a rotating 0.8m high above ground, the table was rotated 360 degrees to determine the position of the highest radiation.
- (2) Measurements at frequency above 1GHz. The EUT was placed on a rotating 1.5m high above the ground. RF absorbers covered the ground plane with a minimum area of 3.0m by 3.0m between the EUT and measurement receiver antenna. The RF absorber shall not exceed 30cm in high above the conducting floor. The table was rotated 360 degrees to determine the position of the highest radiation.
- (3) The Test antenna shall vary between 1m and 4m, Both Horizontal and Vertical antenna are set to make measurement.

- (4) The initial step in collecting conducted emission data is a spectrum analyzer peak detector mode pre-scanning the measurement frequency range. Significant peaks are then marked and then Quasi Peak detector mode re-measured.
- (5) If the Peak Mode measured value compliance with and lower than Quasi Peak Mode Limit Bellow 1 GHz, the EUT shall be deemed to meet QP Limits and then no additional QP Mode measurement performed. But the Peak Value and average value both need to comply with applicable limit above 1 GHz.
- (6) Testing frequency range below 1GHz the measuring instrument use VBW=120 kHz with Quasi-peak detection.
- (7) Testing frequency range above 1GHz the measuring instrument use RBW=1 MHz and VBW=3 MHz with Peak Detector for Peak Values, and use RBW=1 MHz and VBW=10 Hz with Peak Detector for Average Values.
- (8) For the actual test configuration, please see the test setup photo.

6.4 EUT Operating Condition

The Equipment Under Test was set to Continual Transmitting in maximum power.

6.5 Test Data

Please see the next page.

(1) Radiation Test

EUT:	WarriorG1	Model:	XM-JPG1-2
Temperature:	25 °C	Relative Humidity:	55%
Test Voltage:	DC 3.6V		
Ant. Pol.	Horizontal		
Test Mode:	TX B Mode 2412MHz		
Remark:	N/A		

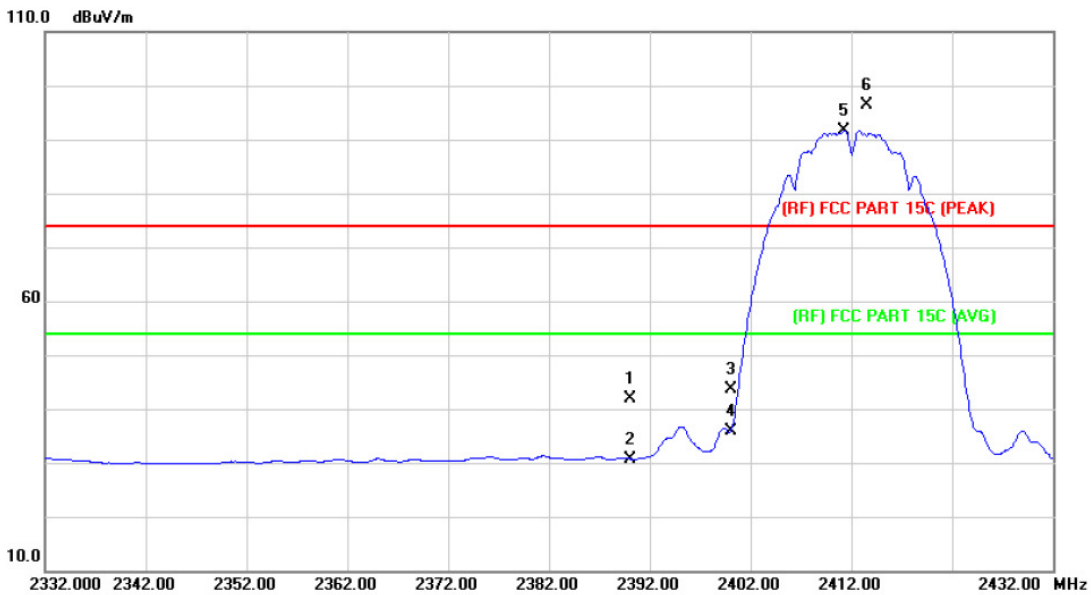

No.	Mk.	Freq. MHz	Reading Level dBuV	Correct Factor dB/m	Measure- ment dBuV/m	Limit dBuV/m	Over dB	Detector
1		2390.000	43.32	0.77	44.09	74.00	-29.91	peak
2		2390.000	30.79	0.77	31.56	54.00	-22.44	AVG
3	*	2411.300	90.70	0.86	91.56	Fundamental Frequency		AVG
4	X	2413.400	95.37	0.86	96.23	Fundamental Frequency		peak

Emission Level= Read Level+ Correct Factor

EUT:	WarriorG1	Model:	XM-JPG1-2
Temperature:	25 °C	Relative Humidity:	55%
Test Voltage:	DC 3.6V		
Ant. Pol.	Vertical		
Test Mode:	TX B Mode 2412MHz		
Remark:	N/A		

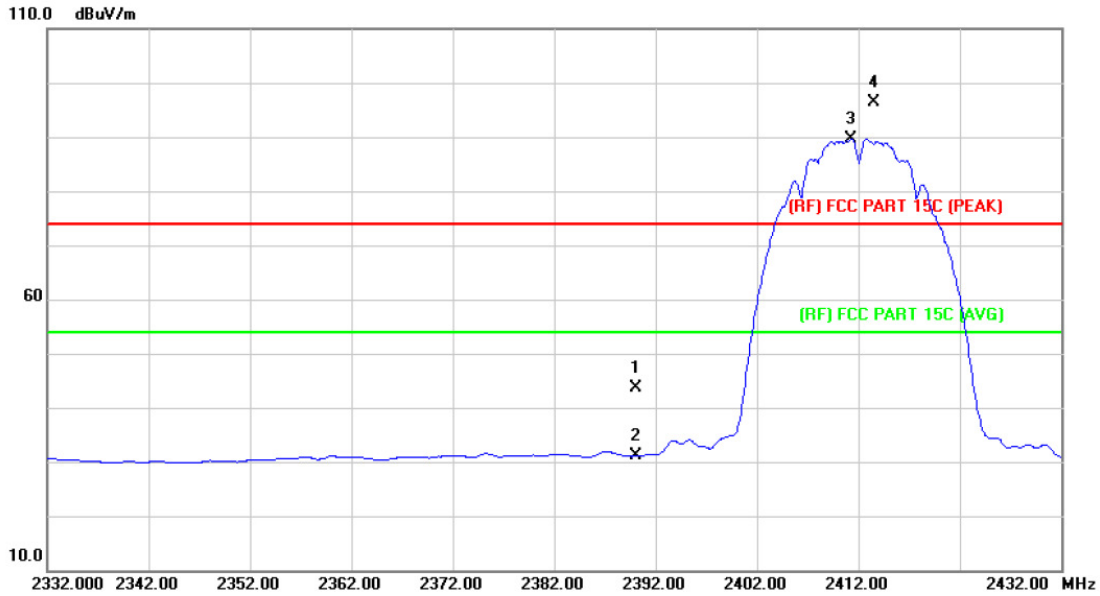

No.	Mk.	Freq. MHz	Reading Level dBuV	Correct Factor dB/m	Measure- ment dBuV/m	Limit dBuV/m	Over dB	Detector
1		2390.000	42.82	0.77	43.59	74.00	-30.41	peak
2		2390.000	30.24	0.77	31.01	54.00	-22.99	AVG
3	*	2411.300	88.86	0.86	89.72	Fundamental Frequency		AVG
4	X	2413.500	95.55	0.86	96.41	Fundamental Frequency		peak

Emission Level= Read Level+ Correct Factor

EUT:	WarriorG1	Model:	XM-JPG1-2
Temperature:	25 °C	Relative Humidity:	55%
Test Voltage:	DC 3.6V		
Ant. Pol.	Horizontal		
Test Mode:	TX B Mode 2462MHz		
Remark:	N/A		

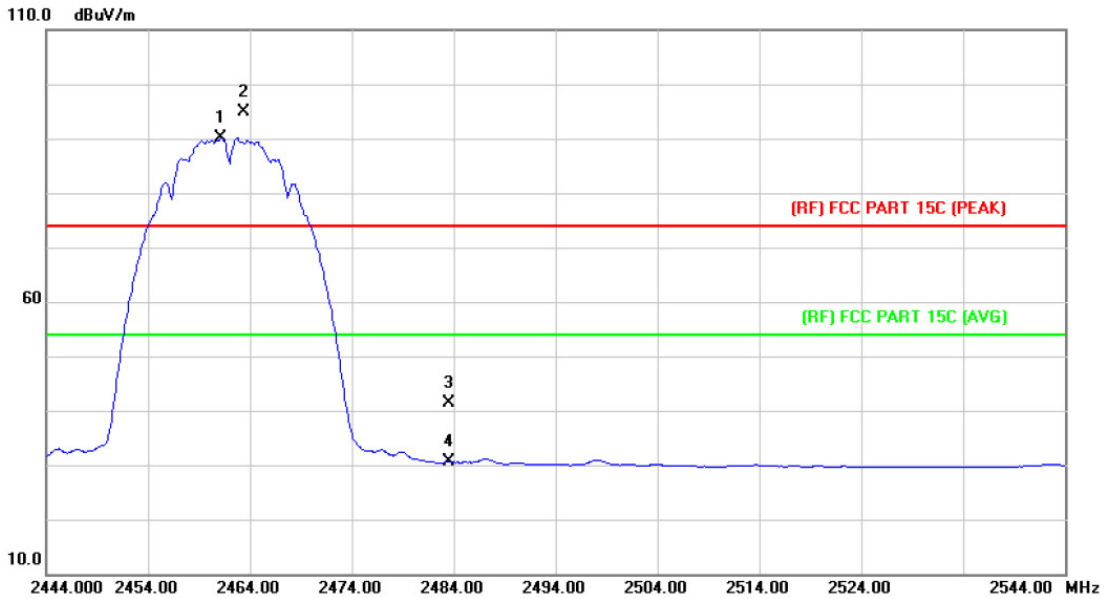

No.	Mk.	Freq. MHz	Reading Level dBuV	Correct Factor dB/m	Measure- ment dBuV/m	Limit dBuV/m	Over dB	Detector
1	*	2461.200	89.04	1.07	90.11			AVG
2	X	2463.400	93.74	1.08	94.82			peak
3		2483.500	40.16	1.17	41.33	74.00	-32.67	peak
4		2483.500	29.54	1.17	30.71	54.00	-23.29	AVG

Emission Level= Read Level+ Correct Factor

EUT:	WarriorG1	Model:	XM-JPG1-2
Temperature:	25 °C	Relative Humidity:	55%
Test Voltage:	DC 3.6V		
Ant. Pol.	Vertical		
Test Mode:	TX B Mode 2462MHz		
Remark:	N/A		

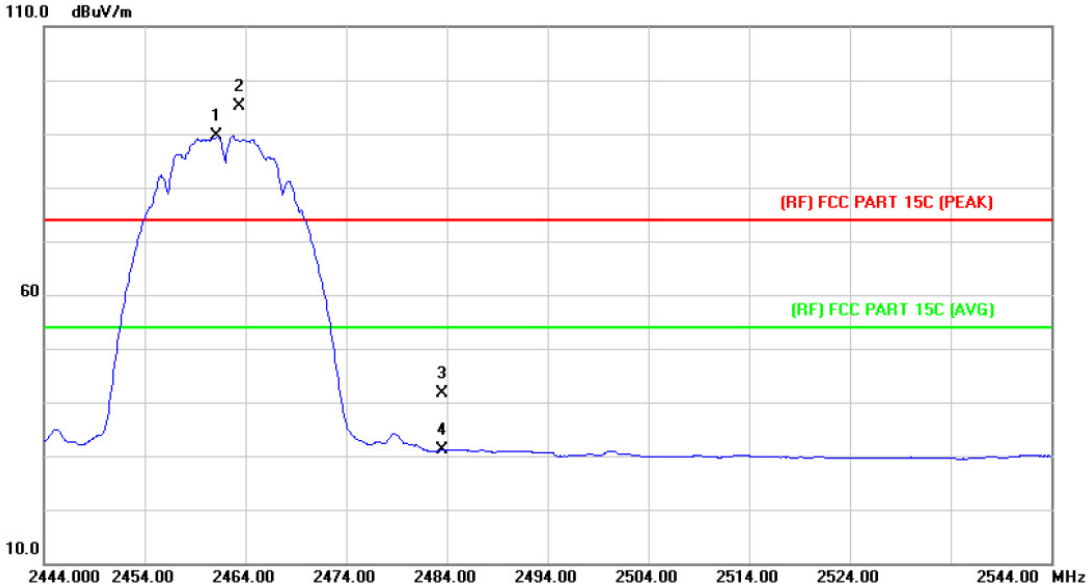

No.	Mk.	Freq. MHz	Reading Level dBuV	Correct Factor dB/m	Measure- ment dBuV/m	Limit dBuV/m	Over dB	Detector
1	*	2461.200	88.49	1.07	89.56	Fundamental Frequency		AVG
2	X	2463.400	94.16	1.08	95.24	Fundamental Frequency		peak
3		2483.500	40.40	1.17	41.57	74.00	-32.43	peak
4		2483.500	29.87	1.17	31.04	54.00	-22.96	AVG

Emission Level= Read Level+ Correct Factor

EUT:	WarriorG1	Model:	XM-JPG1-2
Temperature:	25 °C	Relative Humidity:	55%
Test Voltage:	DC 3.6V		
Ant. Pol.	Horizontal		
Test Mode:	TX G Mode 2412MHz		
Remark:	N/A		

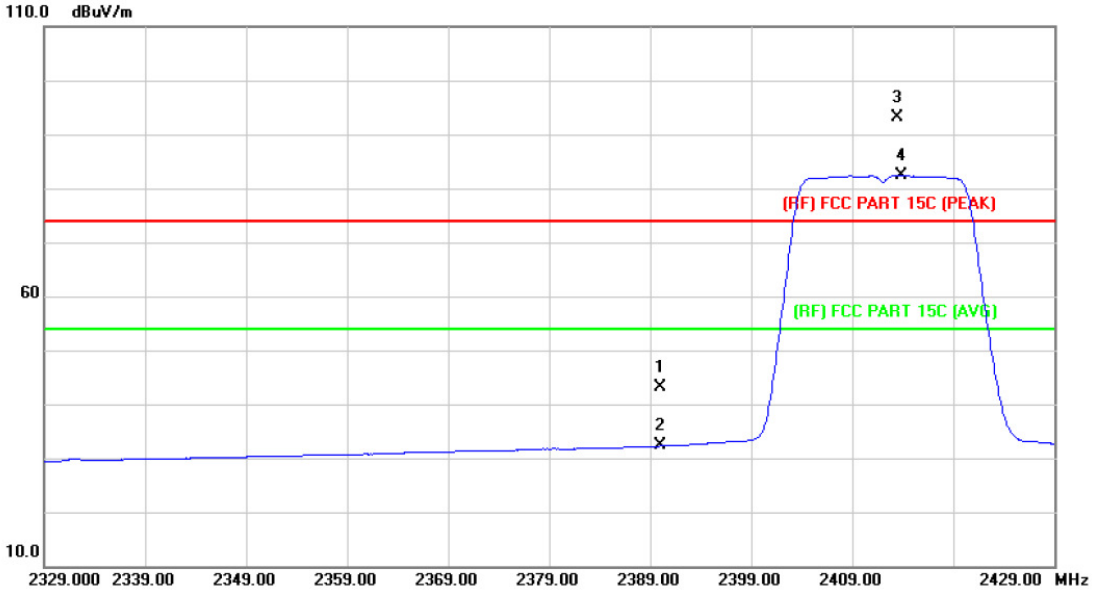

No.	Mk.	Freq.	Reading Level	Correct Factor	Measurement	Limit	Over	Detector
		MHz	dBuV	dB/m	dBuV/m	dBuV/m	dB	
1		2390.000	42.27	0.77	43.04	74.00	-30.96	peak
2		2390.000	31.52	0.77	32.29	54.00	-21.71	AVG
3	X	2413.400	92.23	0.86	93.09	Fundamental Frequency		peak
4	*	2413.800	81.59	0.86	82.45	Fundamental Frequency		AVG

Emission Level= Read Level+ Correct Factor

EUT:	WarriorG1	Model:	XM-JPG1-2
Temperature:	25 °C	Relative Humidity:	55%
Test Voltage:	DC 3.6V		
Ant. Pol.	Vertical		
Test Mode:	TX G Mode 2412MHz		
Remark:	N/A		

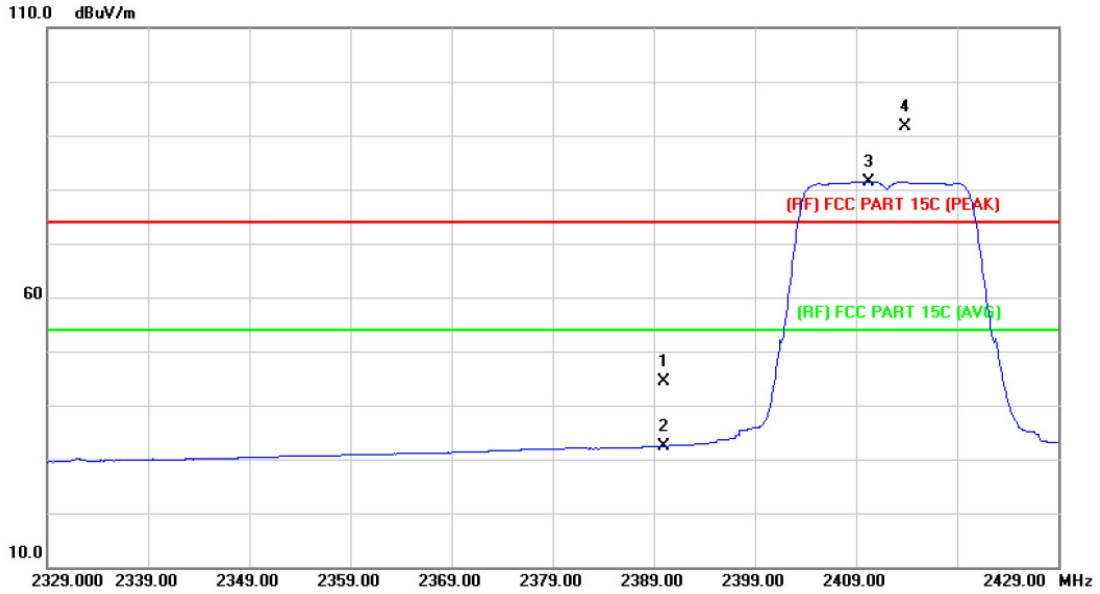

No.	Mk.	Freq. MHz	Reading Level dBuV	Correct Factor dB/m	Measure- ment dBuV/m	Limit dBuV/m	Over dB	Detector
1		2390.000	43.67	0.77	44.44	74.00	-29.56	peak
2		2390.000	31.68	0.77	32.45	54.00	-21.55	AVG
3	*	2410.300	80.64	0.85	81.49	Fundamental Frequency		AVG
4	X	2413.800	90.83	0.86	91.69	Fundamental Frequency		peak

Emission Level= Read Level+ Correct Factor

EUT:	WarriorG1	Model:	XM-JPG1-2
Temperature:	25 °C	Relative Humidity:	55%
Test Voltage:	DC 3.6V		
Ant. Pol.	Horizontal		
Test Mode:	TX G Mode 2462MHz		
Remark:	N/A		

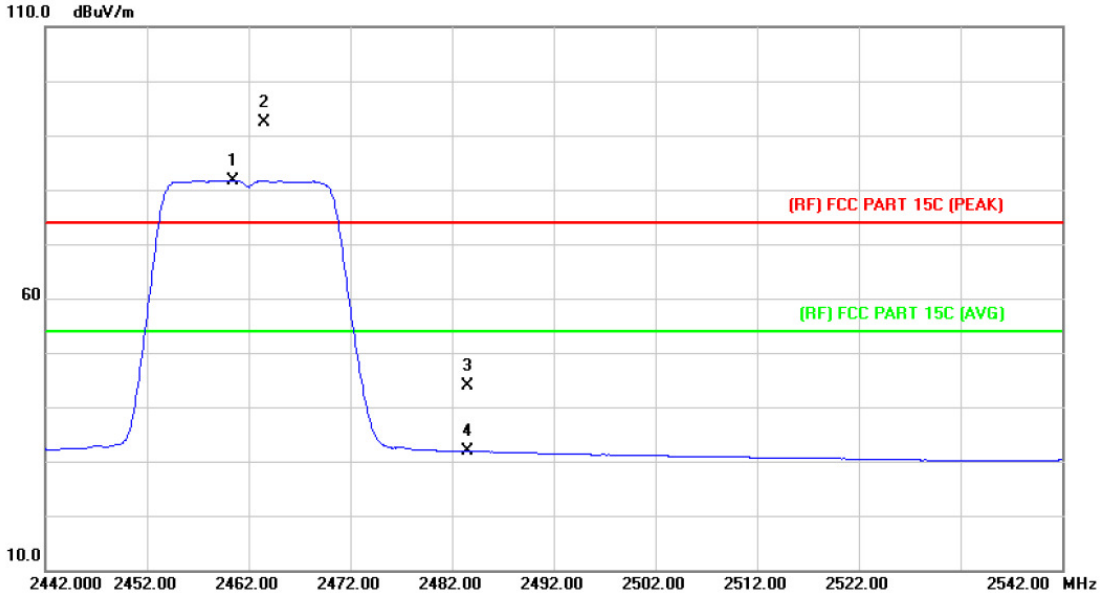

No.	Mk.	Freq. MHz	Reading Level dBuV	Correct Factor dB/m	Measure- ment dBuV/m	Limit dBuV/m	Over dB	Detector
1	*	2460.400	80.68	1.06	81.74	Fundamental Frequency		AVG
2	X	2463.500	91.29	1.08	92.37	Fundamental Frequency		peak
3		2483.500	42.62	1.17	43.79	74.00	-30.21	peak
4		2483.500	30.60	1.17	31.77	54.00	-22.23	AVG

Emission Level= Read Level+ Correct Factor

EUT:	WarriorG1	Model:	XM-JPG1-2
Temperature:	25 °C	Relative Humidity:	55%
Test Voltage:	DC 3.6V		
Ant. Pol.	Vertical		
Test Mode:	TX G Mode 2462MHz		
Remark:	N/A		

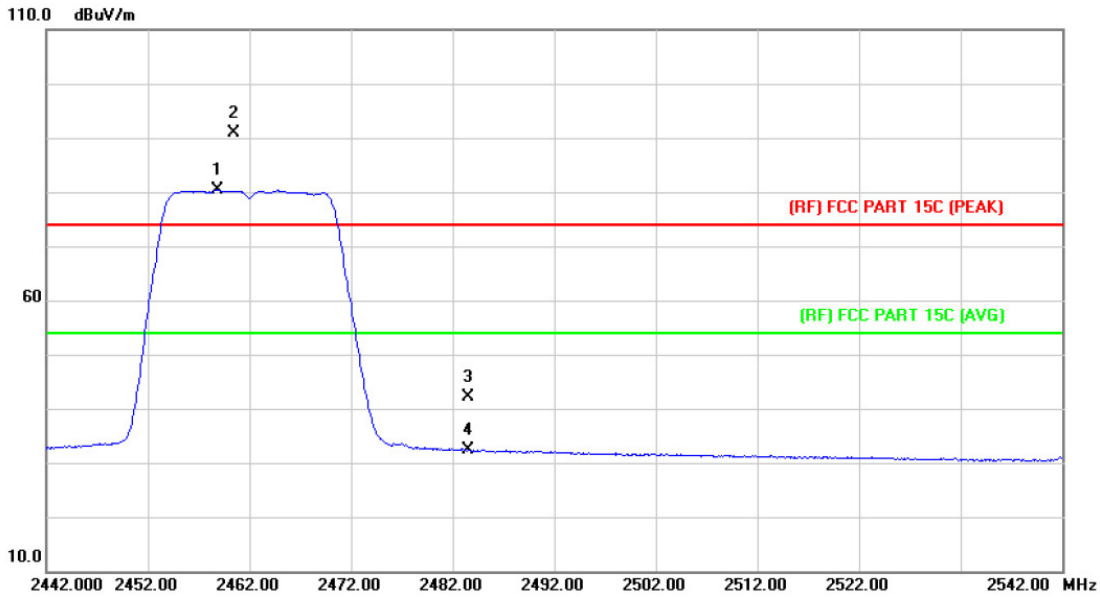

No.	Mk.	Freq. MHz	Reading Level dBuV	Correct Factor dB/m	Measure- ment dBuV/m	Limit dBuV/m	Over dB	Detector
1	*	2458.800	79.27	1.06	80.33	Fundamental Frequency		AVG
2	X	2460.500	89.83	1.06	90.89	Fundamental Frequency		peak
3		2483.500	41.04	1.17	42.21	74.00	-31.79	peak
4		2483.500	31.10	1.17	32.27	54.00	-21.73	AVG

Emission Level= Read Level+ Correct Factor

EUT:	WarriorG1	Model:	XM-JPG1-2
Temperature:	25 °C	Relative Humidity:	55%
Test Voltage:	DC 3.6V		
Ant. Pol.	Horizontal		
Test Mode:	TX N(HT20) Mode 2412MHz		
Remark:	N/A		

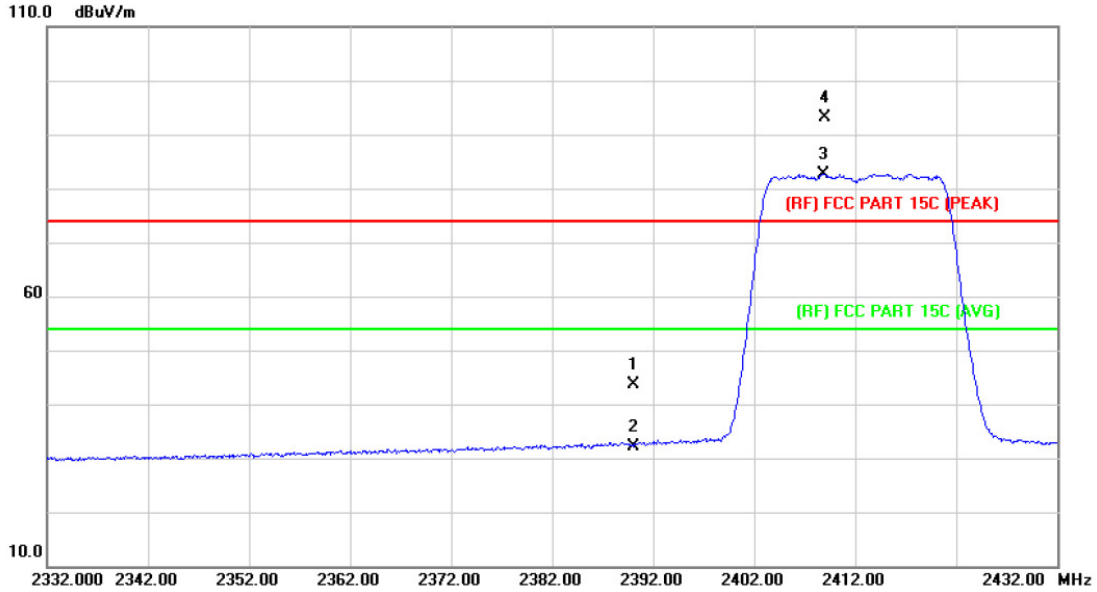

No.	Mk.	Freq.	Reading Level	Correct Factor	Measurement	Limit	Over	Detector
		MHz	dBuV	dB/m	dBuV/m	dBuV/m	dB	
1		2390.000	42.97	0.77	43.74	74.00	-30.26	peak
2		2390.000	31.46	0.77	32.23	54.00	-21.77	AVG
3	*	2408.900	81.86	0.85	82.71	Fundamental Frequency		AVG
4	X	2409.000	92.23	0.85	93.08	Fundamental Frequency		peak

Emission Level= Read Level+ Correct Factor

EUT:	WarriorG1	Model:	XM-JPG1-2
Temperature:	25 °C	Relative Humidity:	55%
Test Voltage:	DC 3.6V		
Ant. Pol.	Vertical		
Test Mode:	TX N(HT20) Mode 2412MHz		
Remark:	N/A		

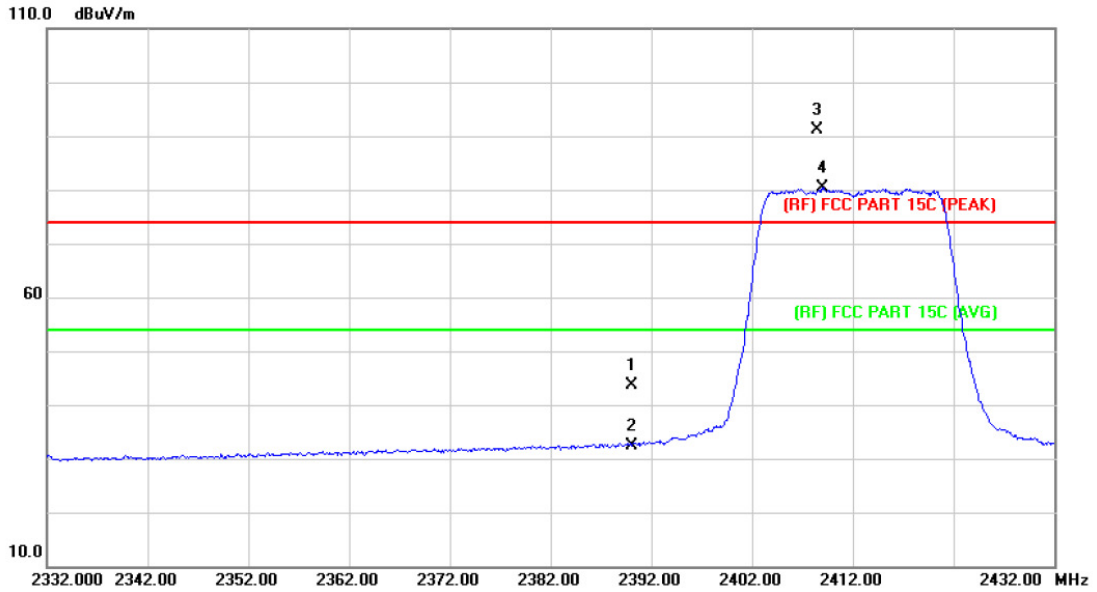

No.	Mk.	Freq.	Reading Level	Correct Factor	Measurement	Limit	Over	Detector
		MHz	dBuV	dB/m	dBuV/m	dBuV/m	dB	
1		2390.000	42.92	0.77	43.69	74.00	-30.31	peak
2		2390.000	31.67	0.77	32.44	54.00	-21.56	AVG
3	X	2408.400	90.20	0.85	91.05	Fundamental Frequency		peak
4	*	2409.000	79.47	0.85	80.32	Fundamental Frequency		AVG

Emission Level= Read Level+ Correct Factor

EUT:	WarriorG1	Model:	XM-JPG1-2
Temperature:	25 °C	Relative Humidity:	55%
Test Voltage:	DC 3.6V		
Ant. Pol.	Horizontal		
Test Mode:	TX N(HT20) Mode 2462MHz		
Remark:	N/A		

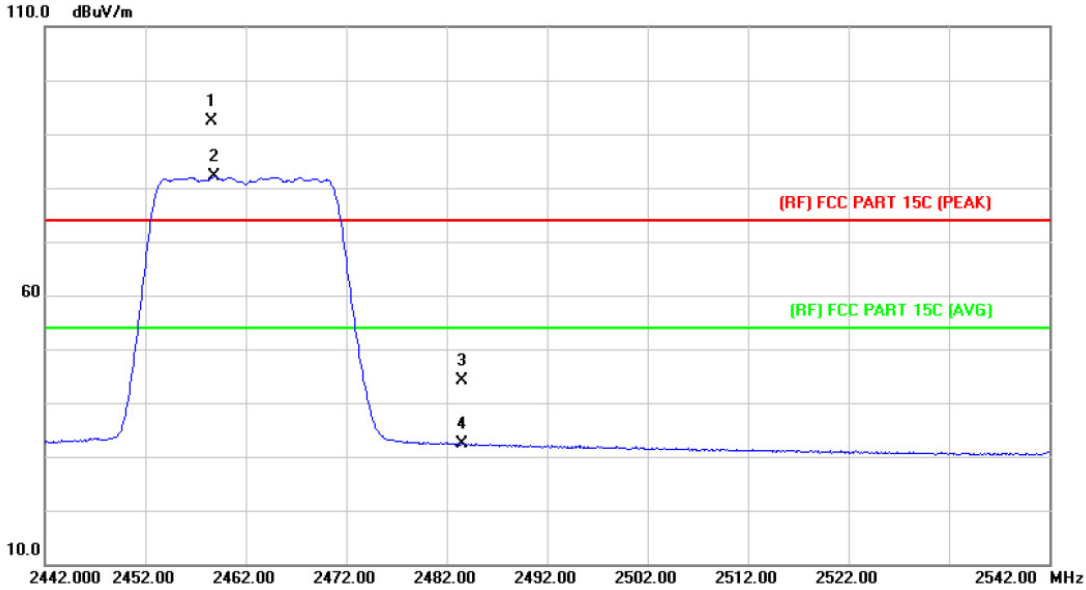

No.	Mk.	Freq. MHz	Reading Level dBuV	Correct Factor dB/m	Measure- ment dBuV/m	Limit dBuV/m	Over dB	Detector
1	X	2458.600	91.30	1.06	92.36	Fundamental Frequency		peak
2	*	2458.800	81.00	1.06	82.06	Fundamental Frequency		AVG
3		2483.500	42.90	1.17	44.07	74.00	-29.93	peak
4		2483.500	31.16	1.17	32.33	54.00	-21.67	AVG

Emission Level= Read Level+ Correct Factor

EUT:	WarriorG1	Model:	XM-JPG1-2
Temperature:	25 °C	Relative Humidity:	55%
Test Voltage:	DC 3.6V		
Ant. Pol.	Vertical		
Test Mode:	TX N(HT20) Mode 2462MHz		
Remark:	N/A		

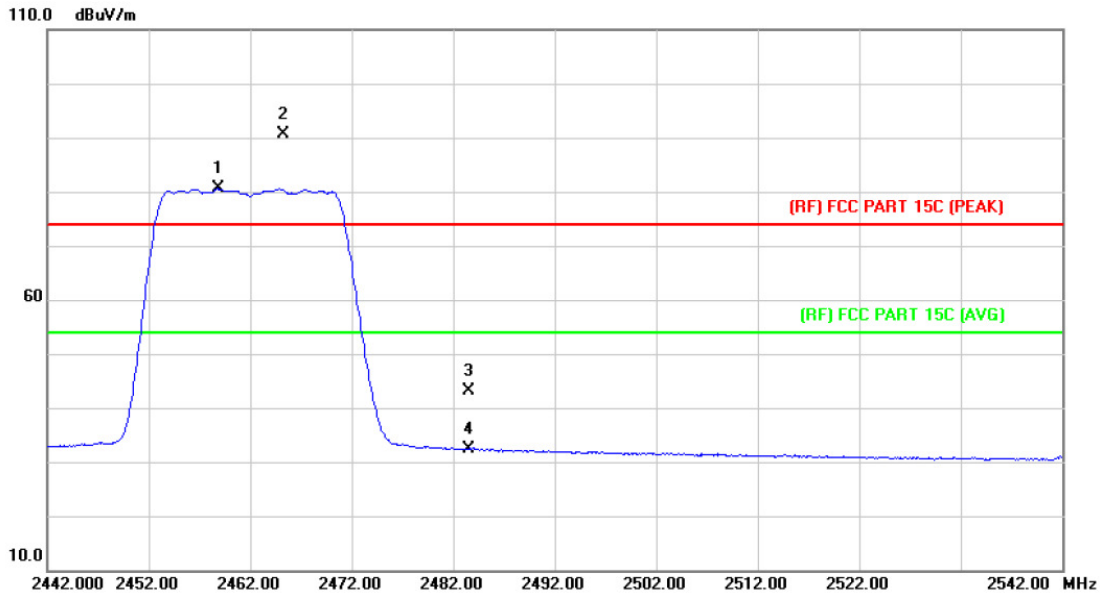

No.	Mk.	Freq. MHz	Reading Level dBuV	Correct Factor dB/m	Measure- ment dBuV/m	Limit dBuV/m	Over dB	Detector
1	*	2458.800	79.47	1.06	80.53	Fundamental Frequency		AVG
2	X	2465.300	89.58	1.09	90.67	Fundamental Frequency		peak
3		2483.500	41.95	1.17	43.12	74.00	-30.88	peak
4		2483.500	31.18	1.17	32.35	54.00	-21.65	AVG

Emission Level= Read Level+ Correct Factor

EUT:	WarriorG1	Model:	XM-JPG1-2
Temperature:	25 °C	Relative Humidity:	55%
Test Voltage:	DC 3.6V		
Ant. Pol.	Horizontal		
Test Mode:	TX N(HT40) Mode 2422MHz		
Remark:	N/A		

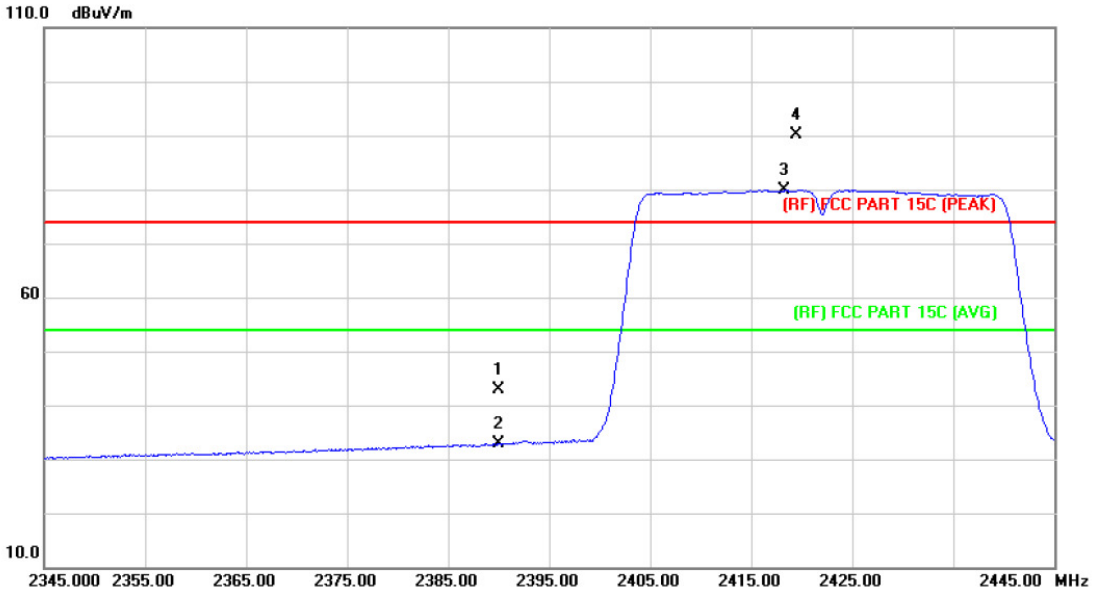

No.	Mk.	Freq. MHz	Reading Level dBuV	Correct Factor dB/m	Measure- ment dBuV/m	Limit dBuV/m	Over dB	Detector
1		2390.000	42.07	0.77	42.84	74.00	-31.16	peak
2		2390.000	32.07	0.77	32.84	54.00	-21.16	AVG
3	*	2418.300	78.98	0.89	79.87	Fundamental Frequency		AVG
4	X	2419.500	89.29	0.89	90.18	Fundamental Frequency		peak

Emission Level= Read Level+ Correct Factor

EUT:	WarriorG1	Model:	XM-JPG1-2
Temperature:	25 °C	Relative Humidity:	55%
Test Voltage:	DC 3.6V		
Ant. Pol.	Vertical		
Test Mode:	TX N(HT40) Mode 2422MHz		
Remark:	N/A		

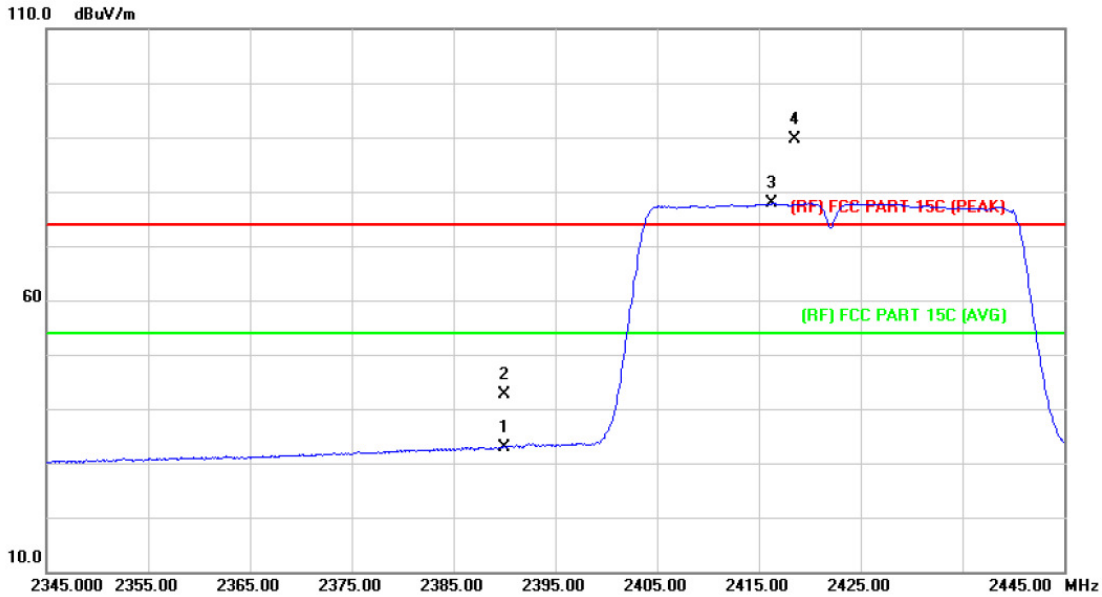

No.	Mk.	Freq. MHz	Reading Level dBuV	Correct Factor dB/m	Measure- ment dBuV/m	Limit dBuV/m	Over dB	Detector
1		2390.000	41.89	0.77	42.66	74.00	-31.34	peak
2		2390.000	32.23	0.77	33.00	54.00	-21.00	AVG
3	*	2416.300	76.96	0.88	77.84	Fundamental Frequency		AVG
4	X	2418.600	88.68	0.89	89.57	Fundamental Frequency		peak

Emission Level= Read Level+ Correct Factor

EUT:	WarriorG1	Model:	XM-JPG1-2
Temperature:	25 °C	Relative Humidity:	55%
Test Voltage:	DC 3.6V		
Ant. Pol.	Horizontal		
Test Mode:	TX N(HT40) Mode 2452MHz		
Remark:	N/A		

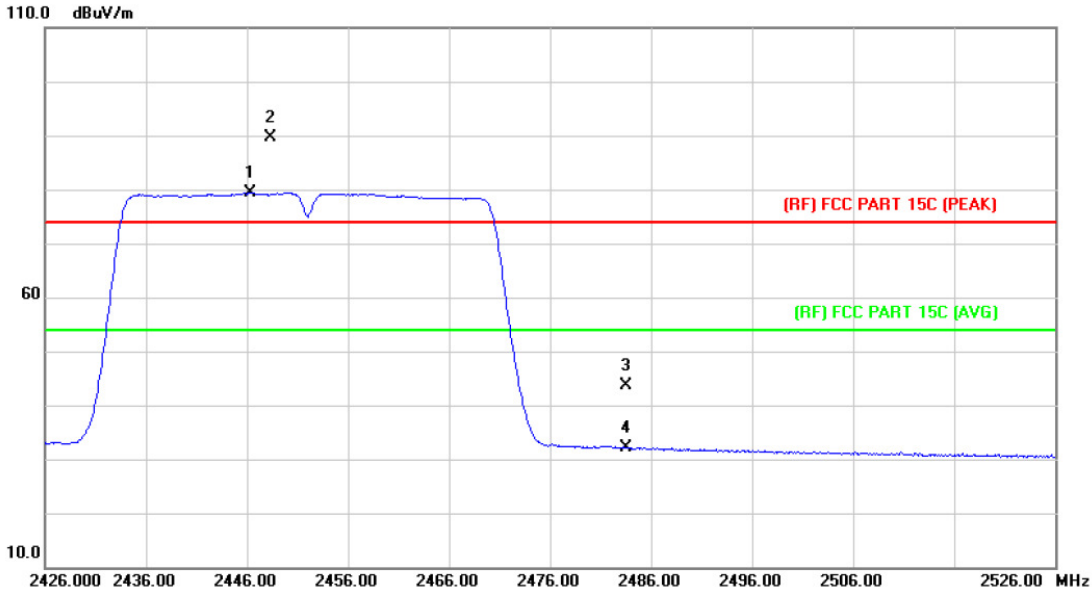

No.	Mk.	Freq. MHz	Reading Level dBuV	Correct Factor dB/m	Measure- ment dBuV/m	Limit dBuV/m	Over dB	Detector
1	*	2446.300	78.35	1.01	79.36	Fundamental Frequency		AVG
2	X	2448.300	88.67	1.02	89.69	Fundamental Frequency		peak
3		2483.500	42.43	1.17	43.60	74.00	-30.40	peak
4		2483.500	31.02	1.17	32.19	54.00	-21.81	AVG

Emission Level= Read Level+ Correct Factor

EUT:	WarriorG1	Model:	XM-JPG1-2
Temperature:	25 °C	Relative Humidity:	55%
Test Voltage:	DC 3.6V		
Ant. Pol.	Vertical		
Test Mode:	TX N(HT40) Mode 2452MHz		
Remark:	N/A		

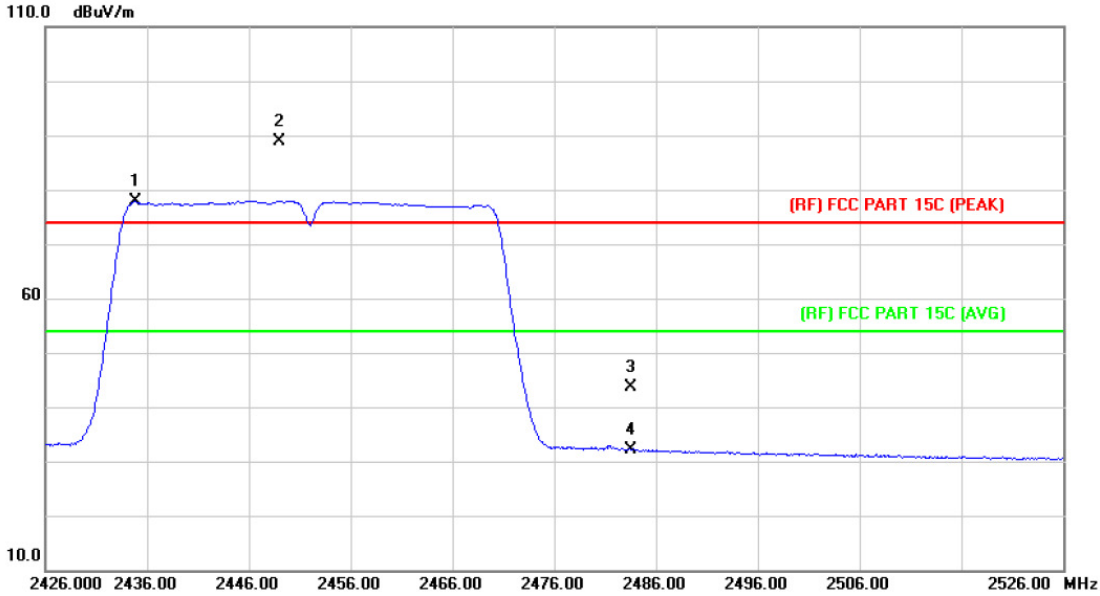

No.	Mk.	Freq. MHz	Reading Level dBuV	Correct Factor dB/m	Measure- ment dBuV/m	Limit dBuV/m	Over dB	Detector
1	*	2434.900	76.99	0.97	77.96	Fundamental Frequency		AVG
2	X	2449.000	87.95	1.02	88.97	Fundamental Frequency		peak
3		2483.500	42.54	1.17	43.71	74.00	-30.29	peak
4		2483.500	30.94	1.17	32.11	54.00	-21.89	AVG

Emission Level= Read Level+ Correct Factor

(2) Conducted Test

EUT:	WarriorG1	Model:	XM-JPG1-2
Temperature:	25 °C	Relative Humidity:	55%
Test Voltage:	DC 3.6V		
Test Mode:	TX B Mode 2412MHz / TX B Mode 2462MHz		
Remark:	The EUT is programed in continuously transmitting mode		

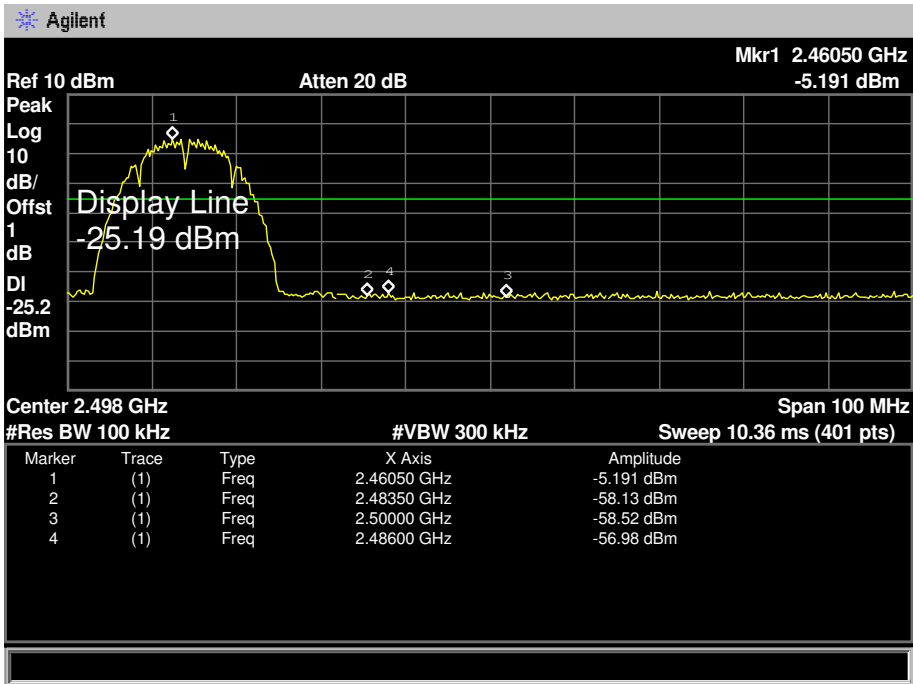
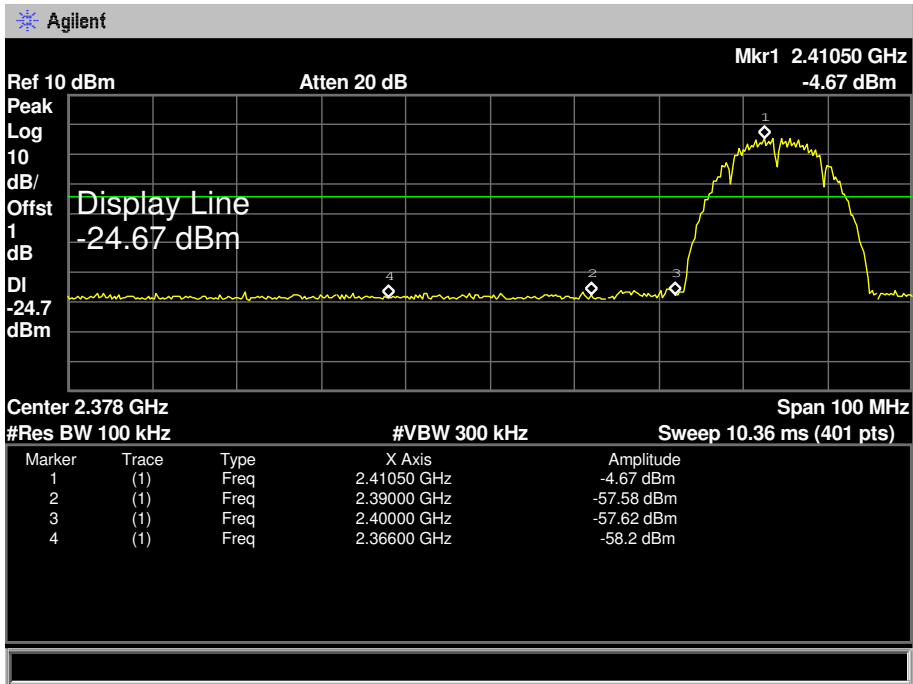

EUT:	WarriorG1	Model:	XM-JPG1-2
Temperature:	25 °C	Relative Humidity:	55%
Test Voltage:	DC 3.6V		
Test Mode:	TX G Mode 2412MHz / TX G Mode 2462MHz		
Remark:	The EUT is programed in continuously transmitting mode		

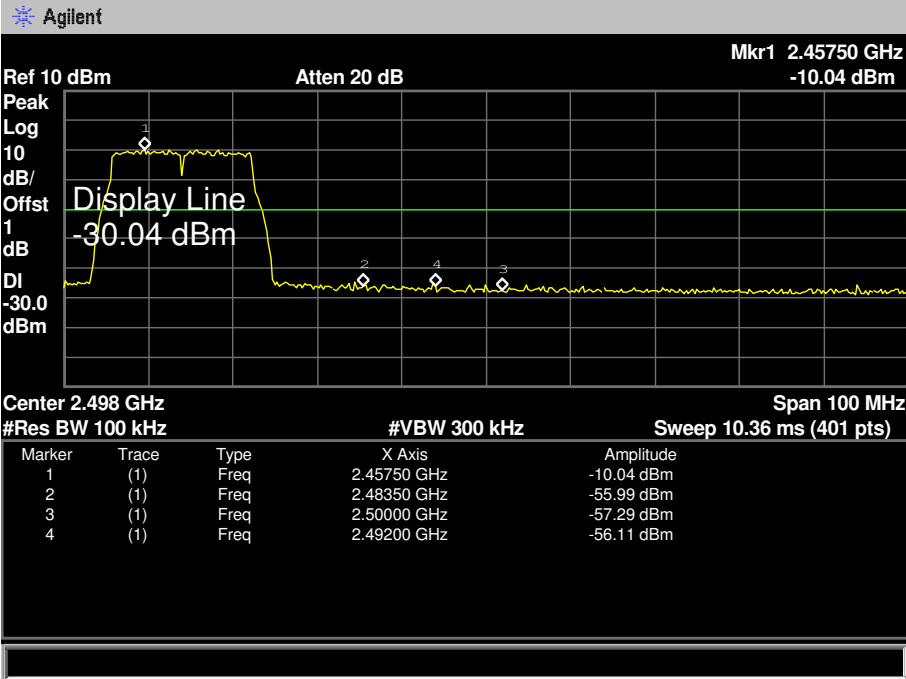
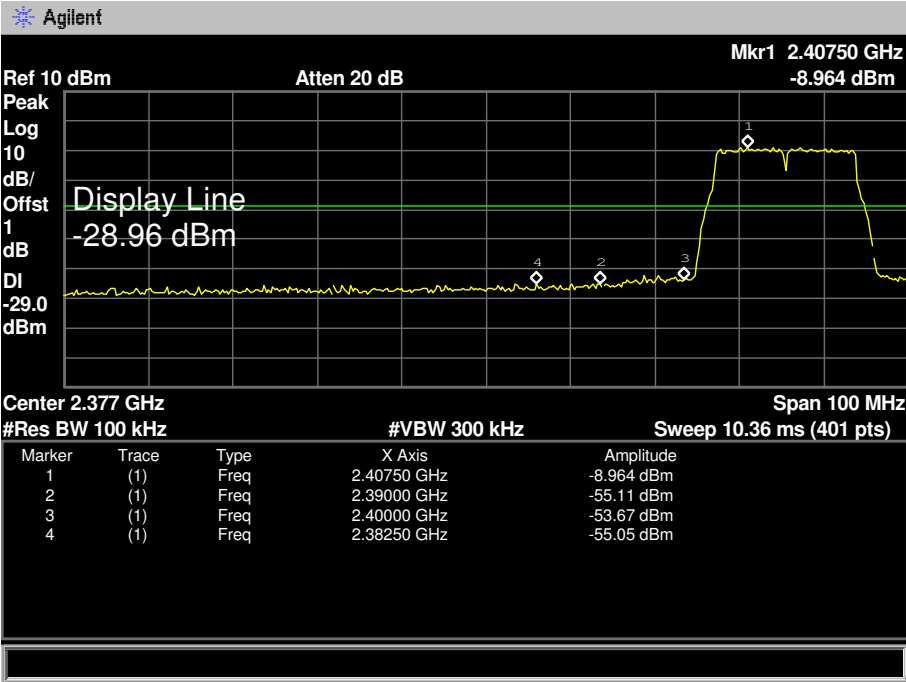

EUT:	WarriorG1	Model:	XM-JPG1-2
Temperature:	25 °C	Relative Humidity:	55%
Test Voltage:	DC 3.6V		
Test Mode:	TX N(HT20) Mode 2412MHz / TX N(HT20) Mode 2462MHz		
Remark:	The EUT is programed in continuously transmitting mode		

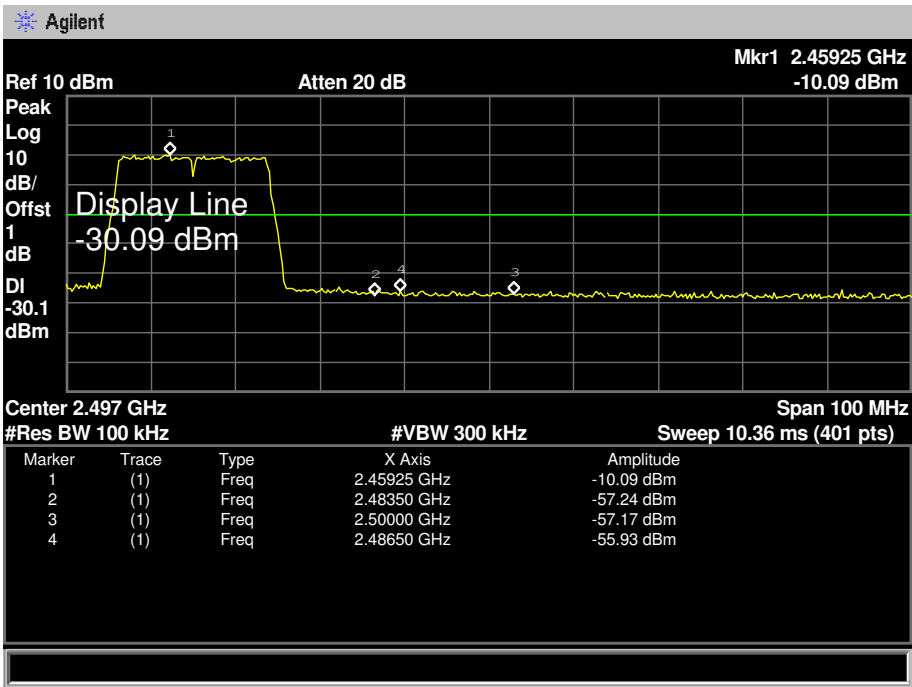
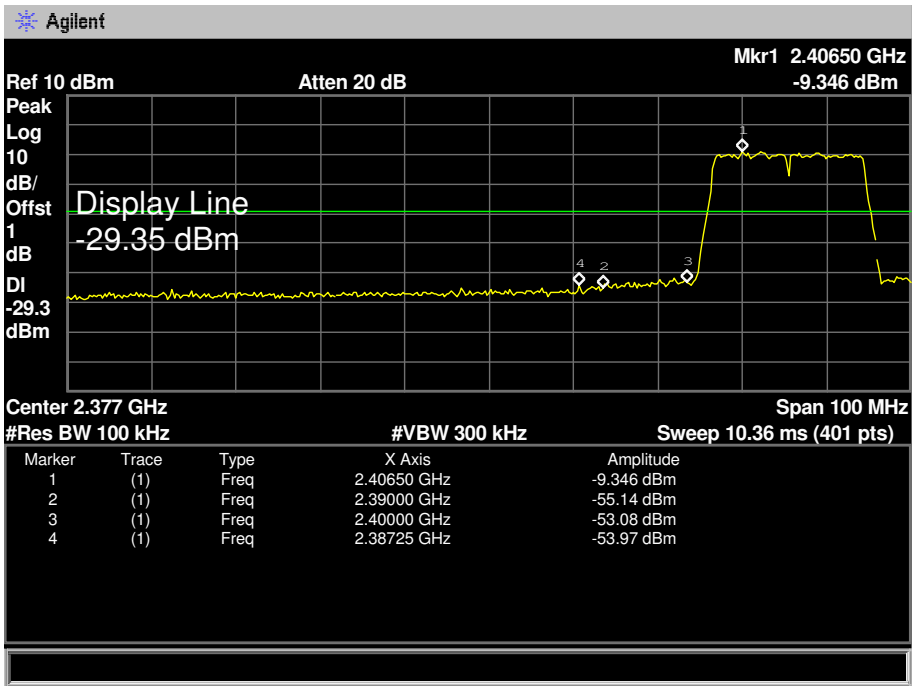

EUT:	WarriorG1	Model:	XM-JPG1-2
Temperature:	25 °C	Relative Humidity:	55%
Test Voltage:	DC 3.6V		
Test Mode:	TX N(HT40) Mode 2422MHz / TX N(HT40) Mode 2452MHz		
Remark:	The EUT is programed in continuously transmitting mode		

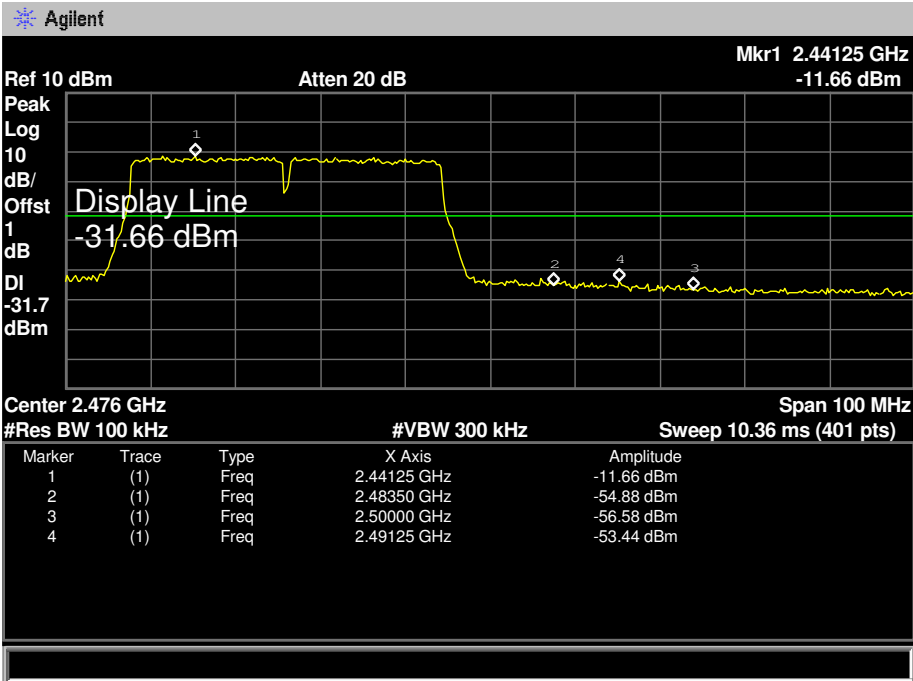
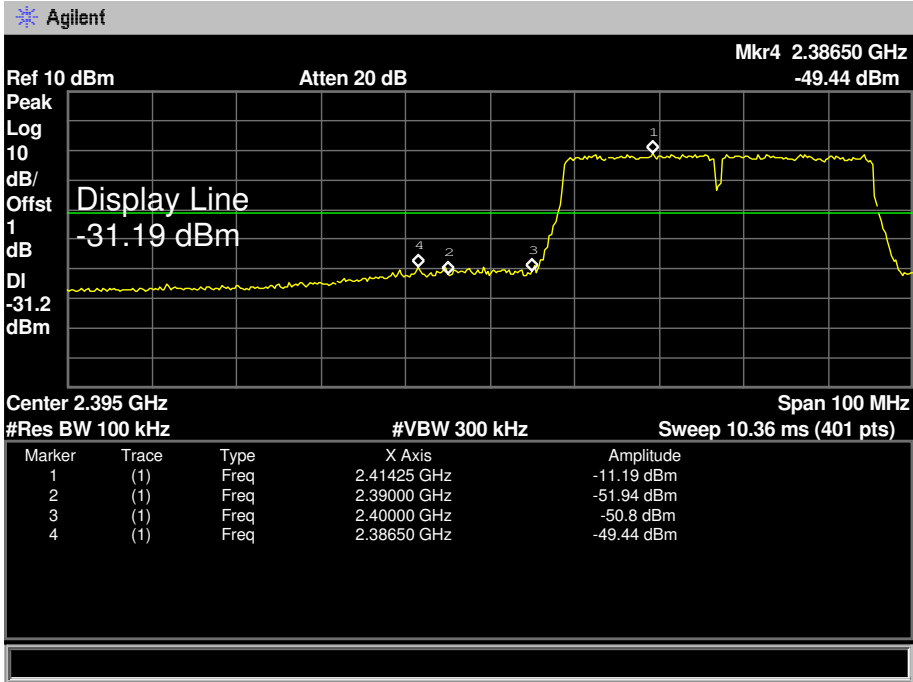

7. Bandwidth Test

7.1 Test Standard and Limit

- 7.1.1 Test Standard
FCC Part 15.247 (a)(2)
- 7.1.2 Test Limit

FCC Part 15 Subpart C(15.247)/RSS-210		
Test Item	Limit	Frequency Range(MHz)
Bandwidth	≥ 500 KHz (6dB bandwidth)	2400~2483.5

7.2 Test Setup

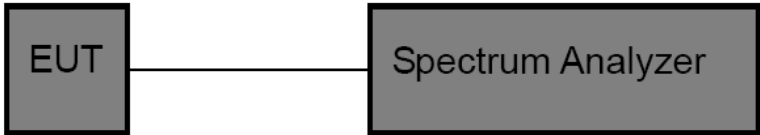

7.3 Test Procedure

- (1) The EUT was directly connected to the spectrum analyzer and antenna output port as show in the block diagram above.
- (2) The bandwidth is measured at an amplitude level reduced 6dB from the reference level. The reference level is the level of the highest amplitude signal observed from the transmitter at the fundamental frequency. Once the reference level is established, the equipment is conditioned with typical modulating signal to produce the worst -case (i.e the widest) bandwidth.
- (3) Measure the channel separation the spectrum analyzer was set to Resolution Bandwidth:100 kHz, and Video Bandwidth:300 kHz, Detector: Peak, Sweep Time set auto.

7.4 EUT Operating Condition

The EUT was set to continuously transmitting in each mode and low, middle and high channel for the test.

7.5 Test Data

EUT:	WarriorG1	Model:	XM-JPG1-2
Temperature:	25 °C	Relative Humidity:	55%
Test Voltage:	DC 3.6V		
Test Mode:	TX 802.11B Mode		
Channel frequency (MHz)	6dB Bandwidth (MHz)	99% Bandwidth (MHz)	Limit (MHz)
2412	10.059	14.4608	≥0.5
2437	10.067	14.4298	
2462	10.060	14.4538	
802.11B Mode			
2412 MHz			

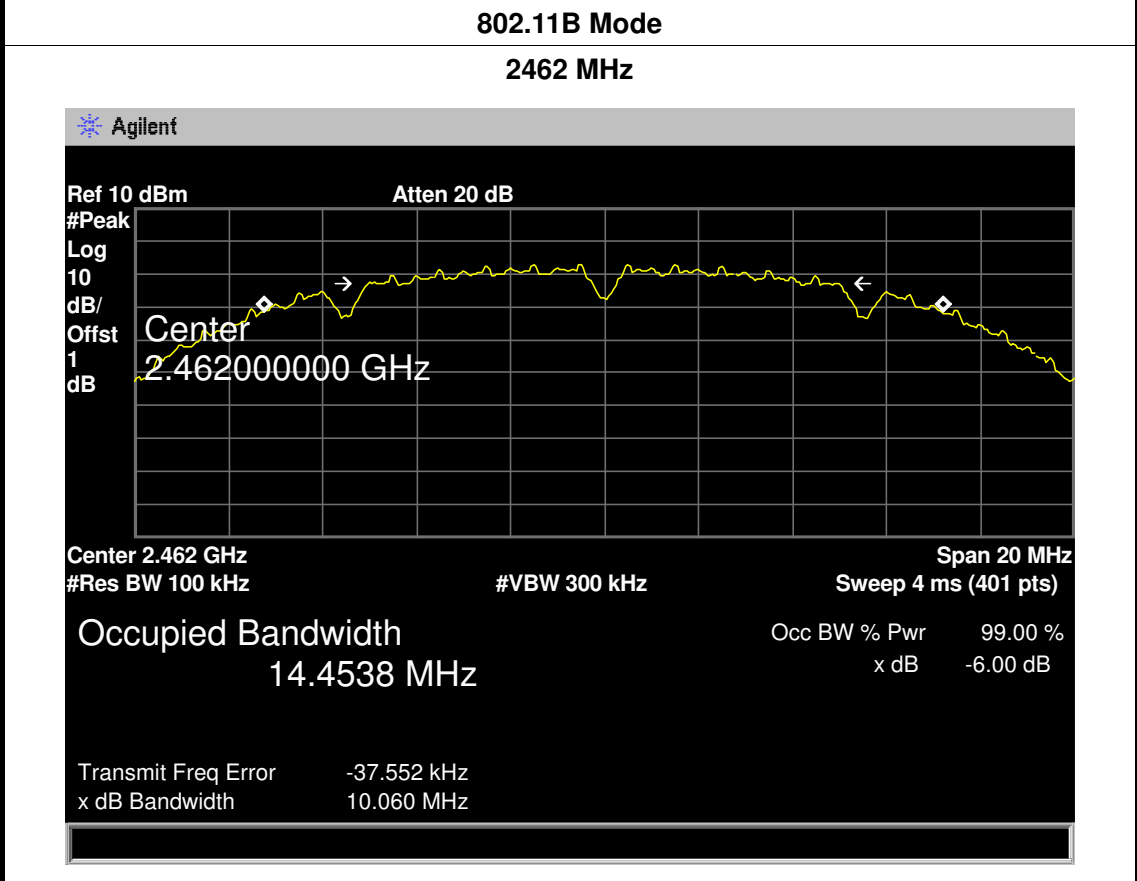
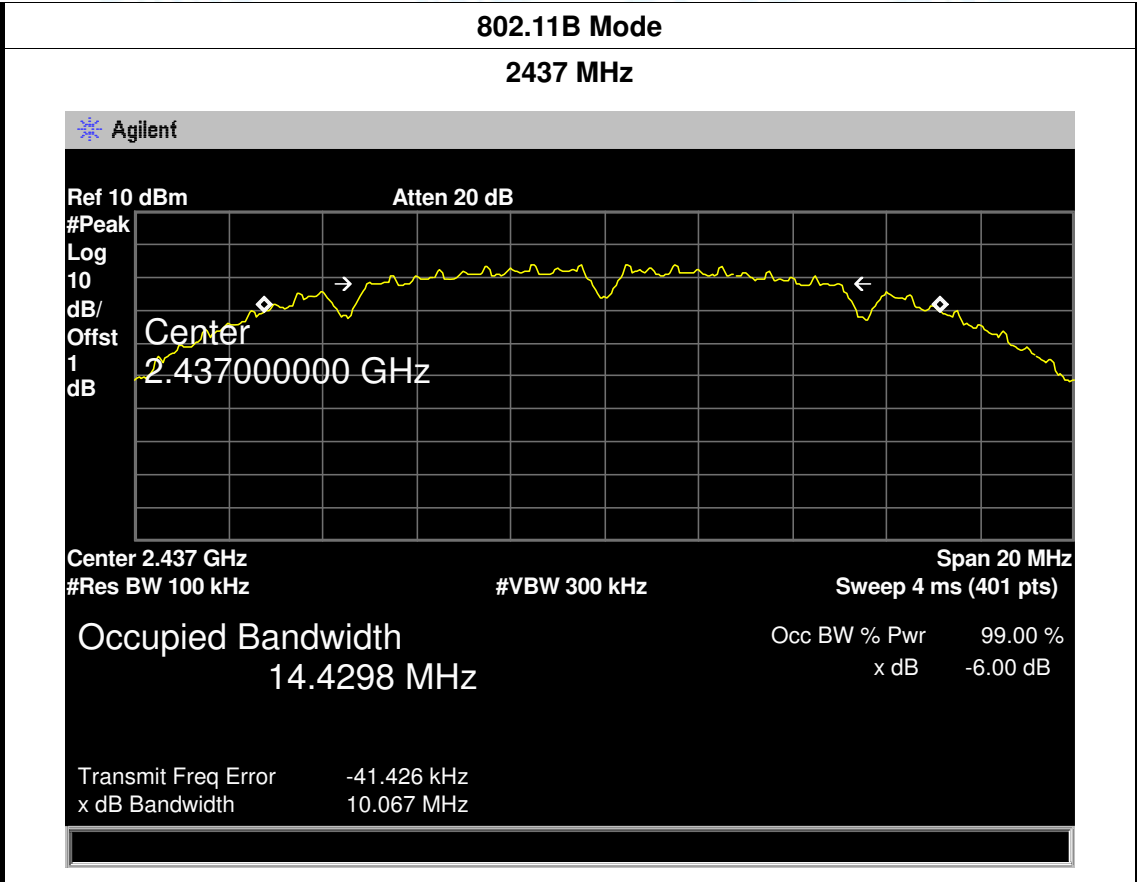

EUT:	WarriorG1	Model:	XM-JPG1-2
Temperature:	25 °C	Relative Humidity:	55%
Test Voltage:	DC 3.6V		
Test Mode:	TX 802.11G Mode		
Channel frequency (MHz)	6dB Bandwidth (MHz)	99% Bandwidth (MHz)	Limit (MHz)
2412	16.582	16.5247	>=0.5
2437	16.582	16.5220	
2462	16.616	16.5310	

802.11G Mode

2412 MHz

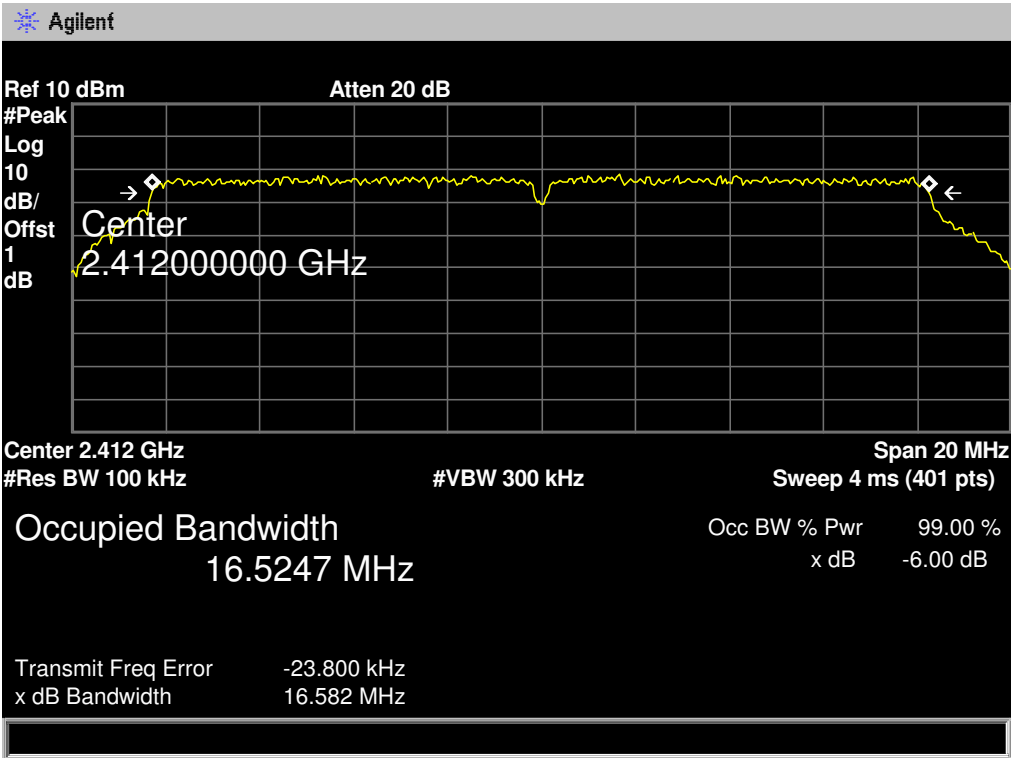

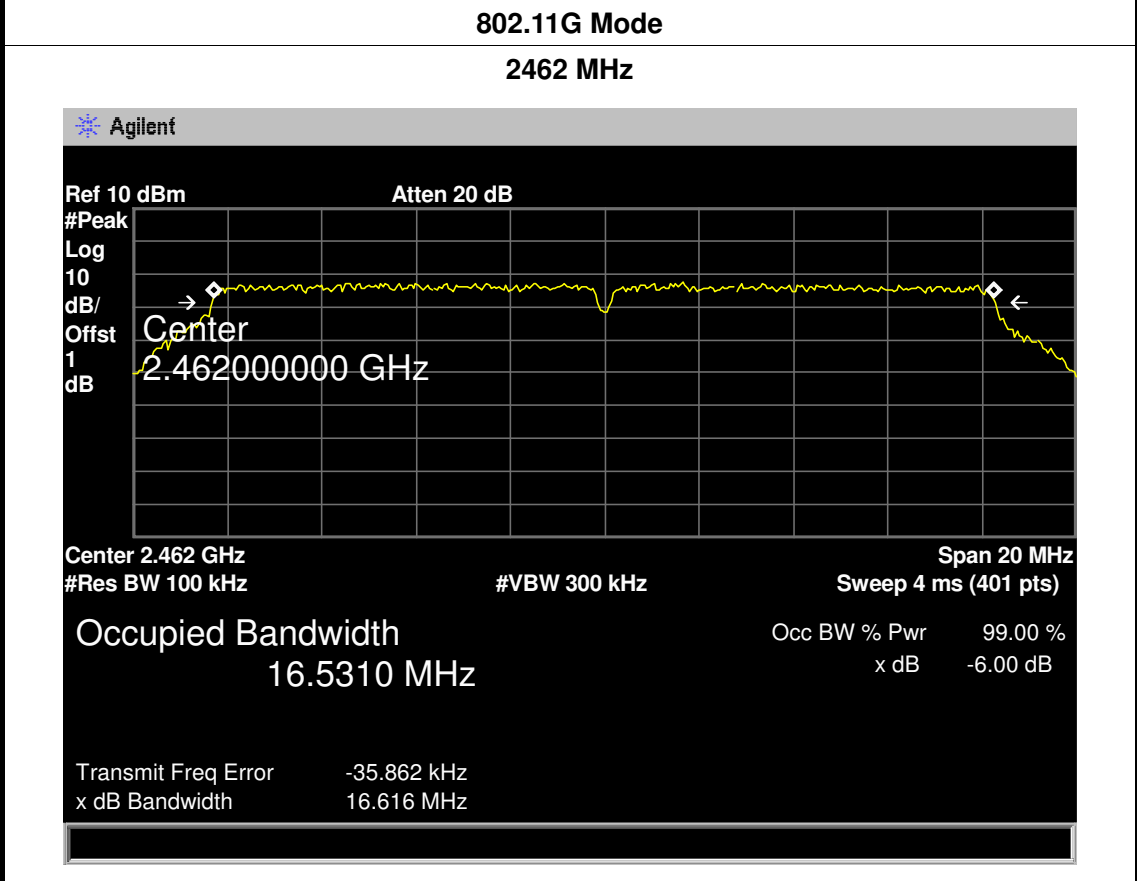
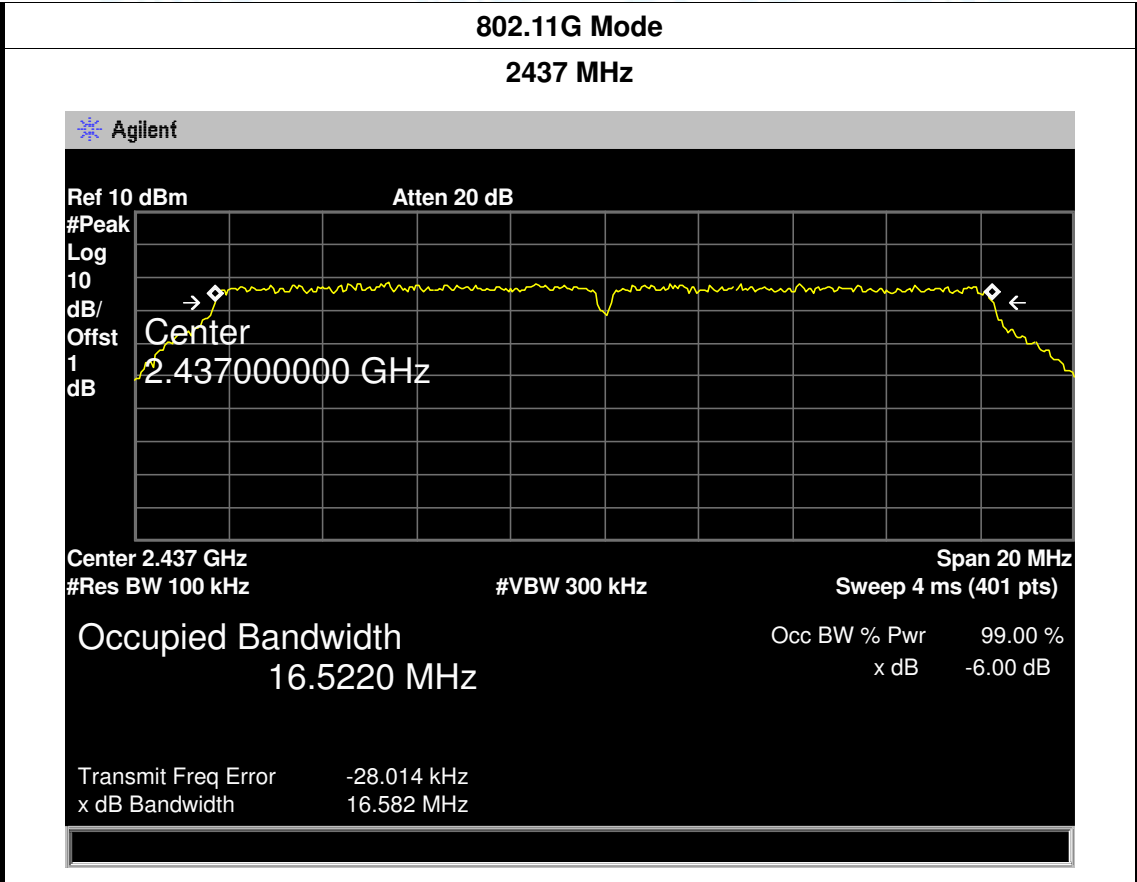

EUT:	WarriorG1	Model:	XM-JPG1-2
Temperature:	25 °C	Relative Humidity:	55%
Test Voltage:	DC 3.6V		
Test Mode:	TX 802.11N(HT20) Mode		
Channel frequency (MHz)	6dB Bandwidth (MHz)	99% Bandwidth (MHz)	Limit (MHz)
2412	17.817	17.6160	≥0.5
2437	17.829	17.6270	
2462	17.837	17.6347	

802.11N(HT20) Mode

2412 MHz

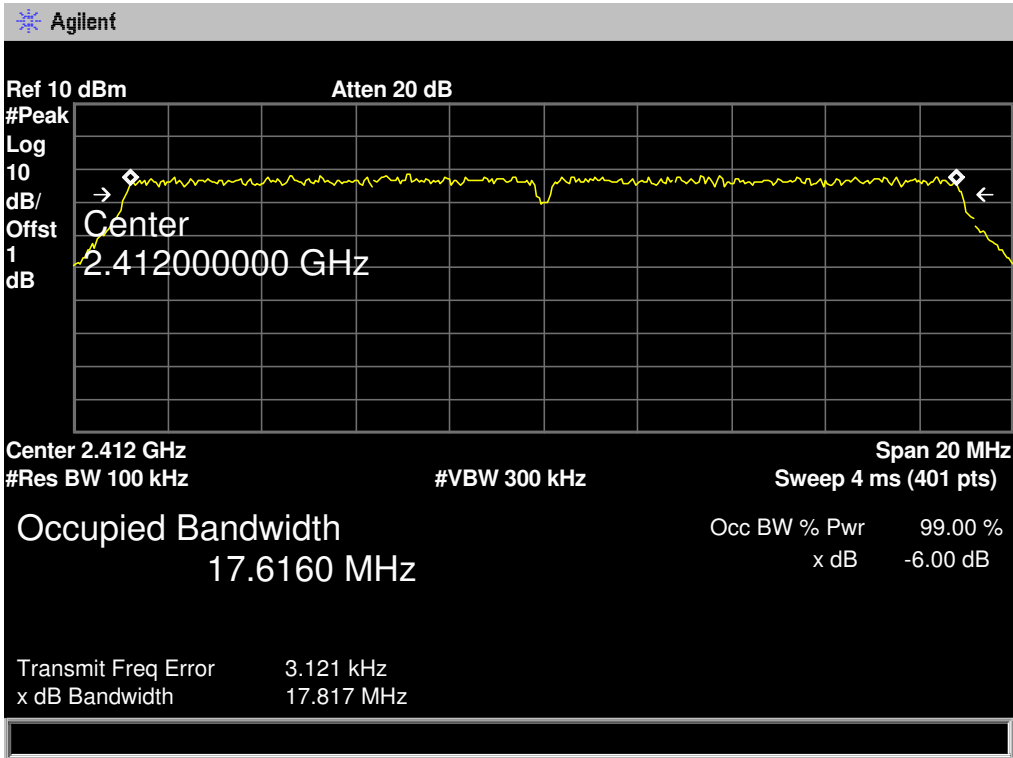

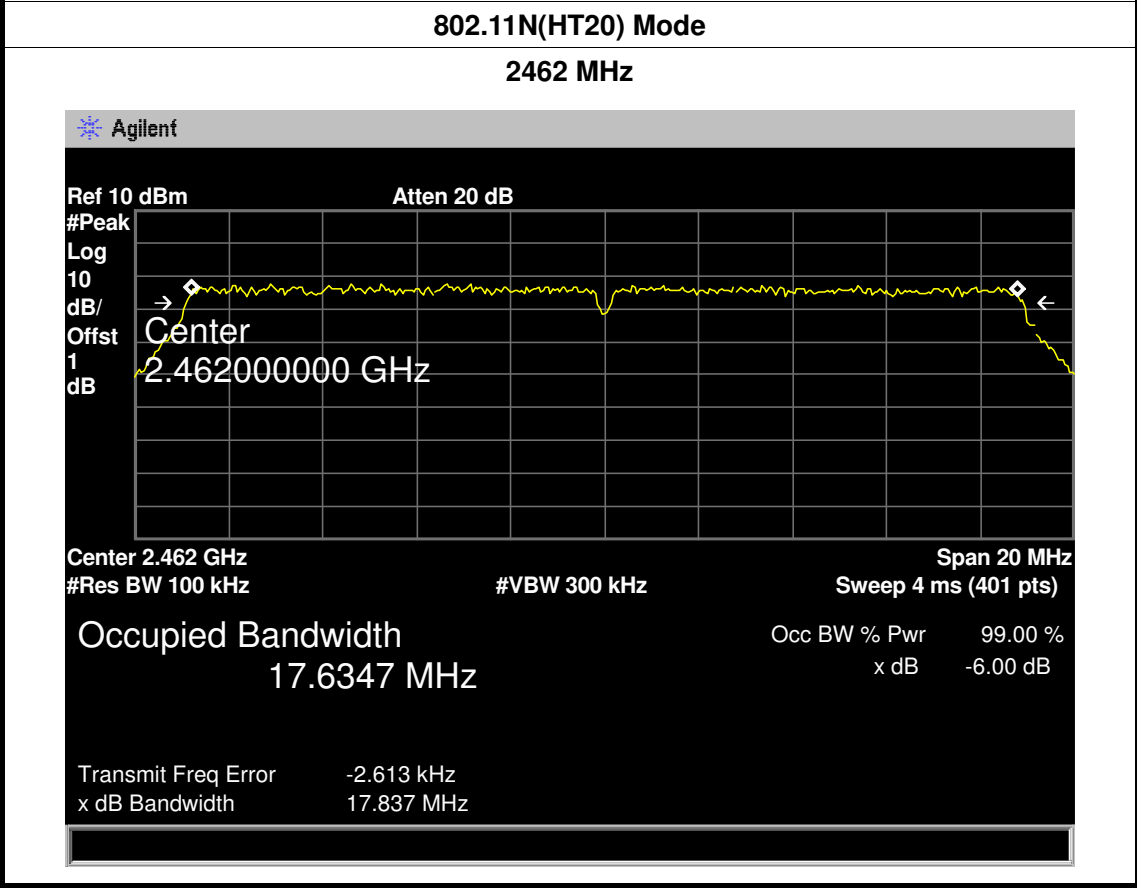
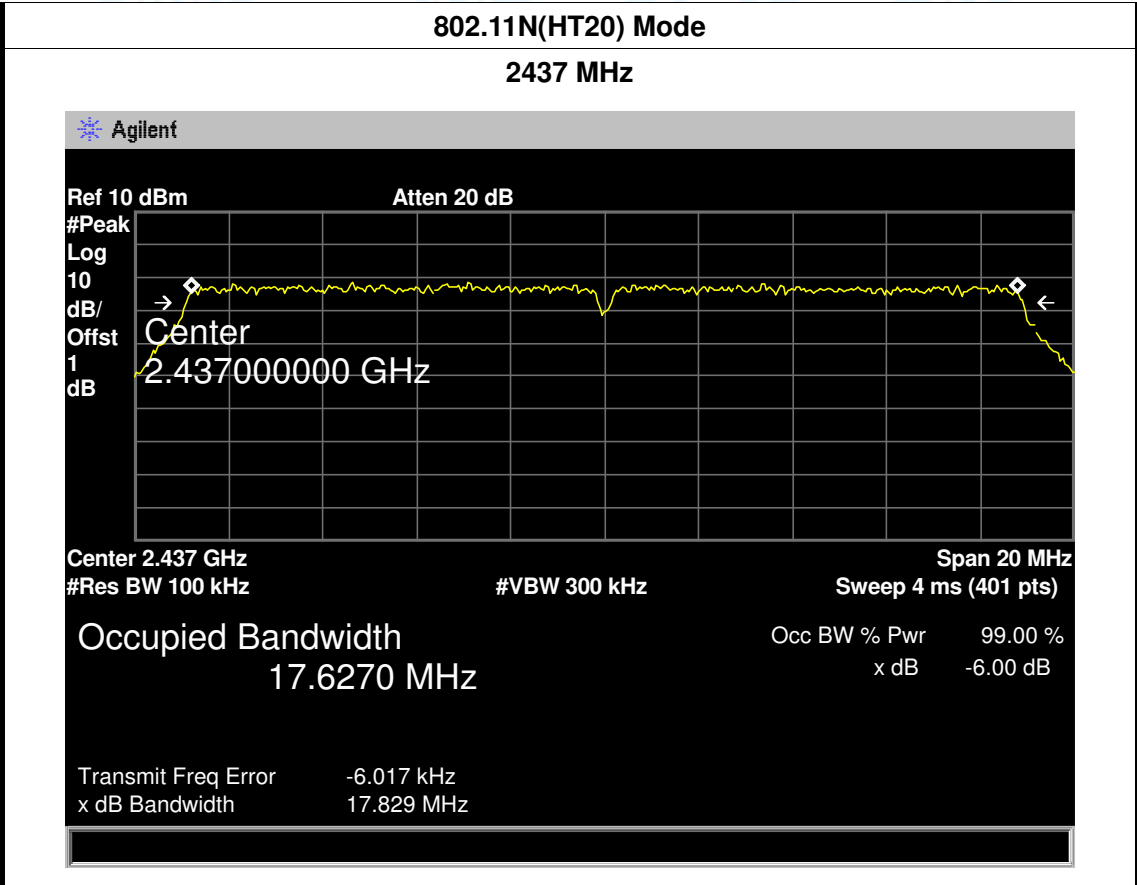

EUT:	WarriorG1	Model:	XM-JPG1-2
Temperature:	25 °C	Relative Humidity:	55%
Test Voltage:	DC 3.6V		
Test Mode:	TX 802.11N(HT40) Mode		
Channel frequency (MHz)	6dB Bandwidth (MHz)	99% Bandwidth (MHz)	Limit (MHz)
2412	36.531	36.0160	>=0.5
2437	36.557	36.0112	
2462	36.526	36.0155	
802.11N(HT40) Mode			
2422 MHz			
<p>Agilent</p> <p>Ref 10 dBm Atten 20 dB</p> <p>#Peak</p> <p>Log</p> <p>10</p> <p>dB/</p> <p>Offst</p> <p>1</p> <p>dB</p> <p>Center 2.422000000 GHz</p> <p>Center 2.422 GHz Span 40 MHz</p> <p>#Res BW 100 kHz #VBW 300 kHz Sweep 4.144 ms (401 pts)</p> <p>Occupied Bandwidth Occ BW % Pwr 99.00 %</p> <p>36.0160 MHz x dB -6.00 dB</p> <p>Transmit Freq Error -4.195 kHz</p> <p>x dB Bandwidth 36.531 MHz</p>			

802.11N(HT40) Mode

2437 MHz

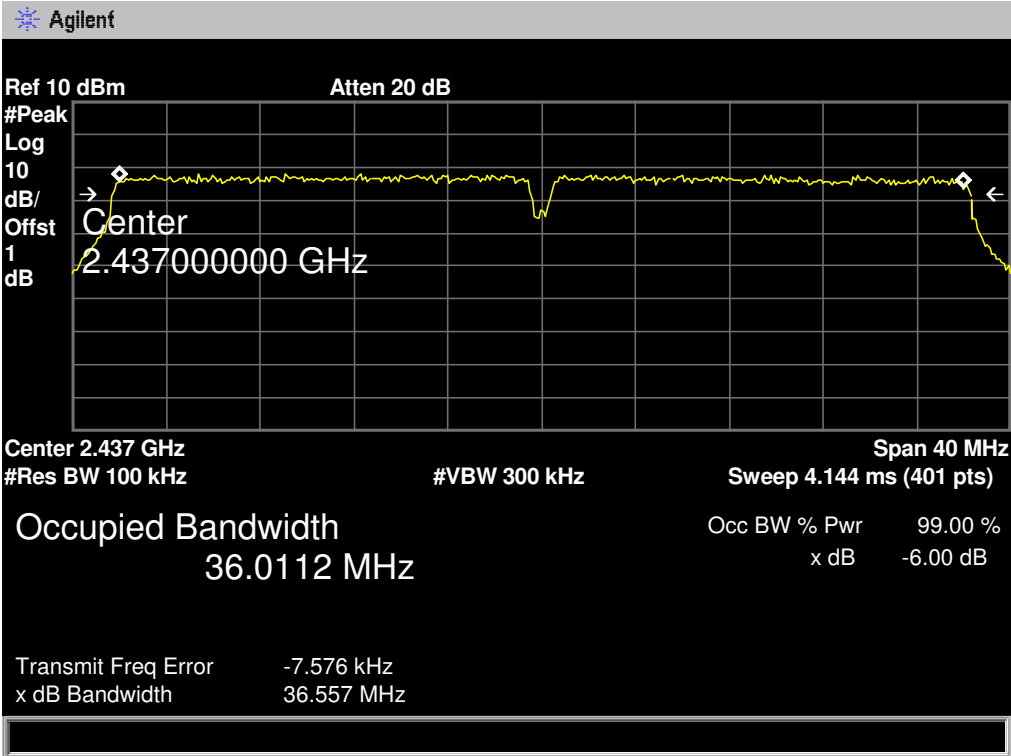

802.11N(HT40) Mode

2452 MHz

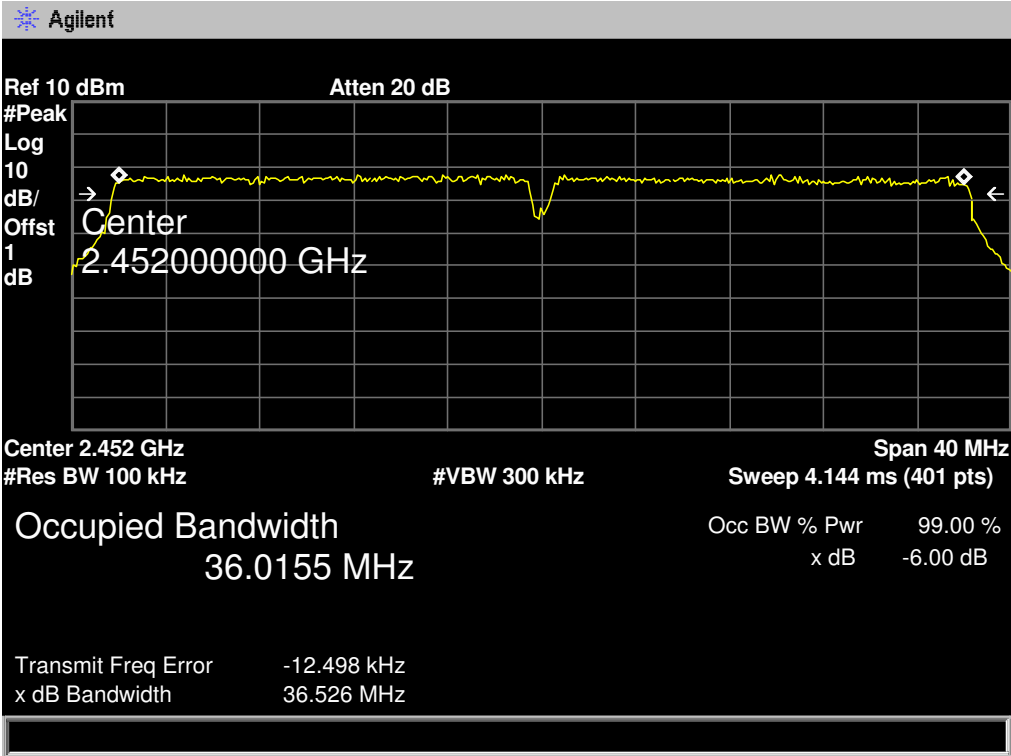

8. Peak Output Power Test

8.1 Test Standard and Limit

- 8.1.1 Test Standard
FCC Part 15.247 (b)
- 8.1.2 Test Limit

FCC Part 15 Subpart C(15.247)/RSS-210		
Test Item	Limit	Frequency Range(MHz)
Peak Output Power	1 Watt or 30 dBm	2400~2483.5

8.2 Test Setup

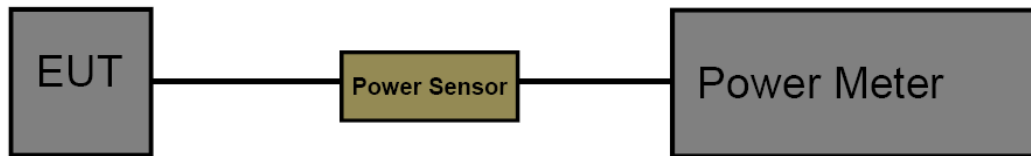

8.3 Test Procedure

The measurement is according to section 9.1.2 of KDB 558074 D01 DTS Meas Guidance v03r04.

The EUT was connected to RF power meter via a broadband power sensor as show the block above. The power sensor video bandwidth is greater than or equal to the DTS bandwidth of the equipment.

8.4 EUT Operating Condition

The EUT was set to continuously transmitting in the max power during the test.

8.5 Test Data

EUT:	WarriorG1	Model Name :	XM-JPG1-2
Temperature:	25 °C	Relative Humidity:	55%
Test Voltage:	DC 3.6V		
Mode	Channel frequency (MHz)	Test Result (dBm)	Limit (dBm)
802.11b	2412	9.12	30
	2437	9.09	
	2462	9.13	
802.11g	2412	9.01	
	2437	9.08	
	2462	9.05	
802.11n (HT20)	2412	8.97	
	2437	8.98	
	2462	9.00	
802.11n (HT40)	2422	9.02	
	2437	8.99	
	2452	8.87	
Result: PASS			

Duty Cycle		
Mode	Channel frequency (MHz)	Test Result
802.11b	2412	>98%
	2437	
	2462	
802.11g	2412	
	2437	
	2462	
802.11n (HT20)	2412	
	2437	
	2462	
802.11n (HT40)	2422	
	2437	
	2452	
Please see below plots		

802.11 B Mode 2412 MHz

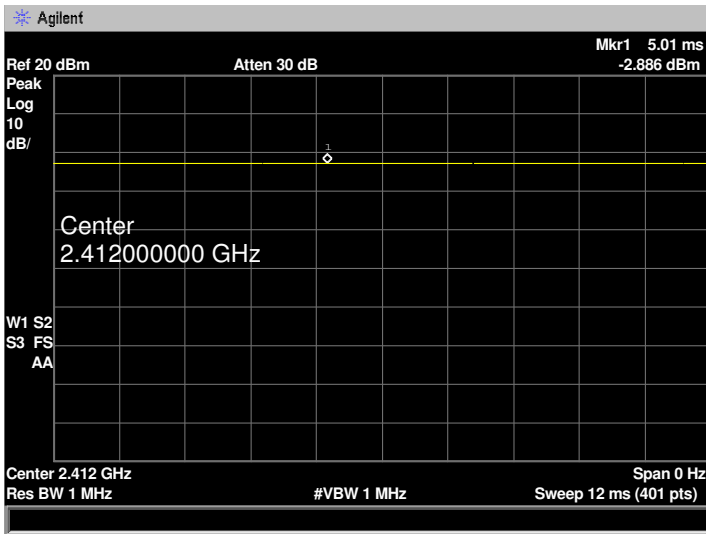

802.11 B Mode 2437 MHz

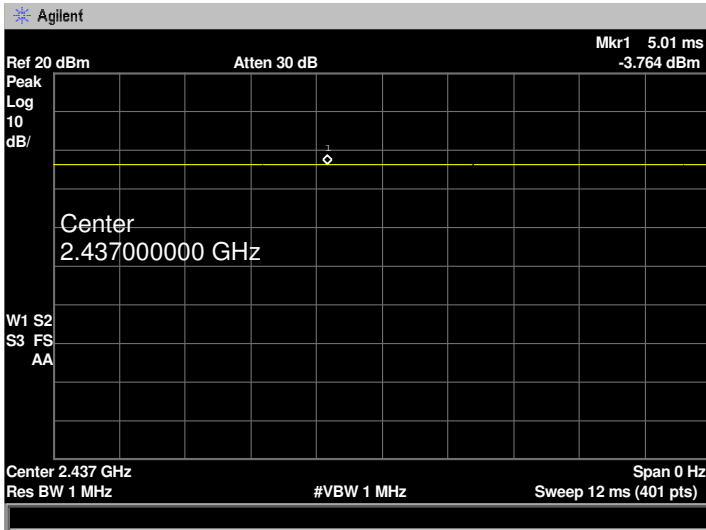

802.11 B Mode 2462 MHz

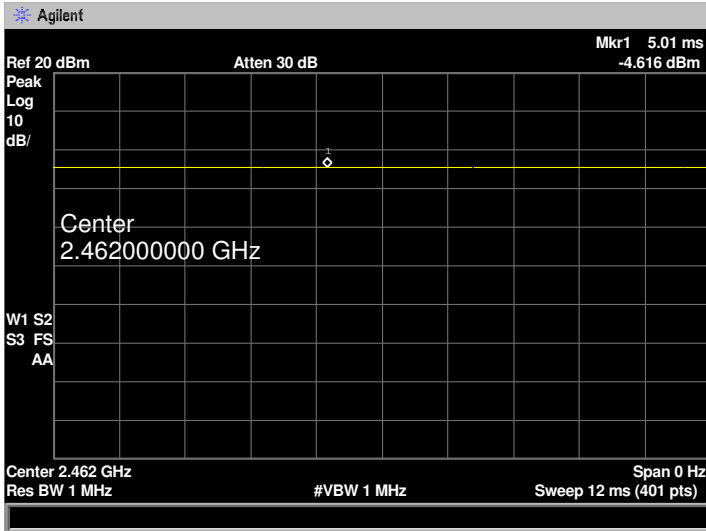

802.11 G Mode 2412 MHz

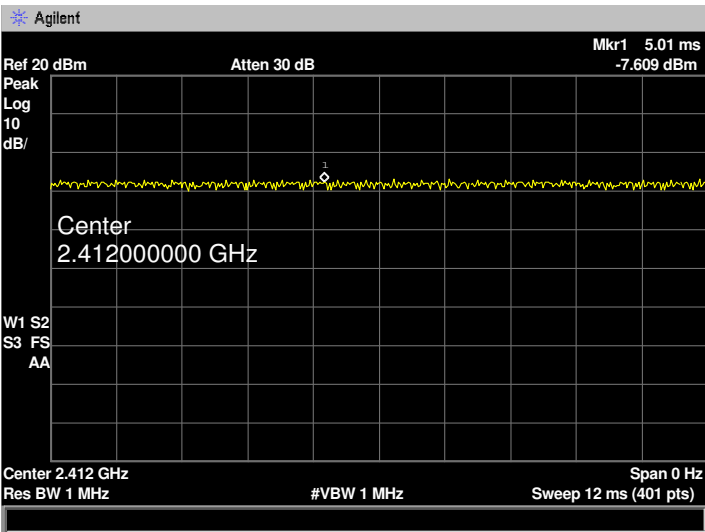

802.11 G Mode 2437 MHz

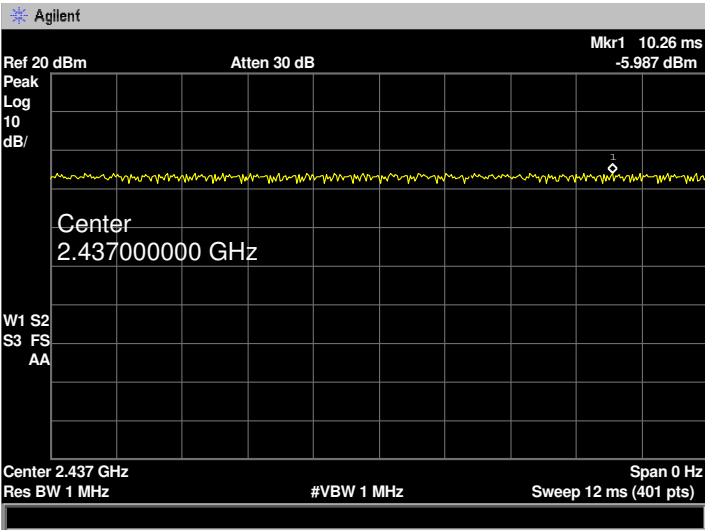

802.11 G Mode 2462 MHz

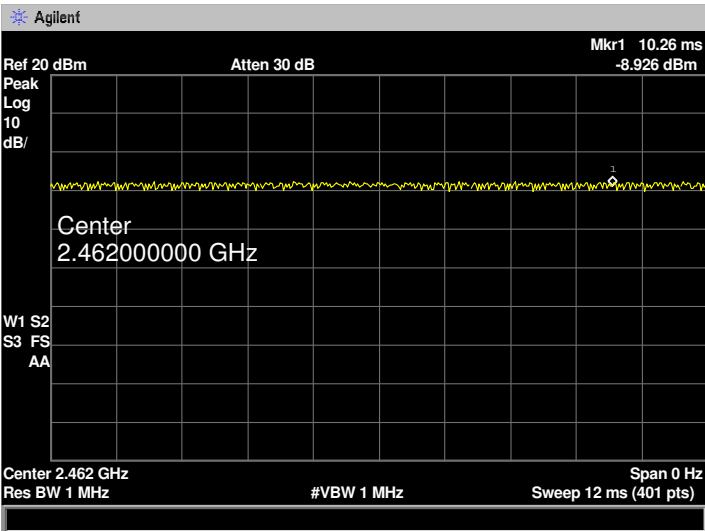

802.11 N20 Mode 2412 MHz

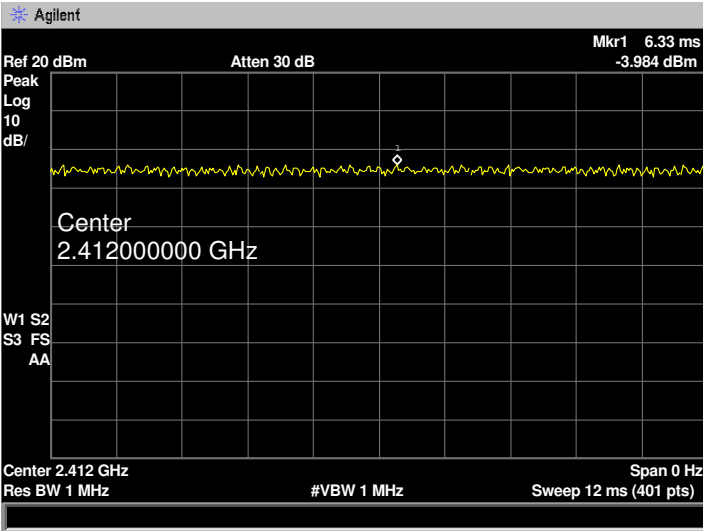

802.11 N20 Mode 2437 MHz

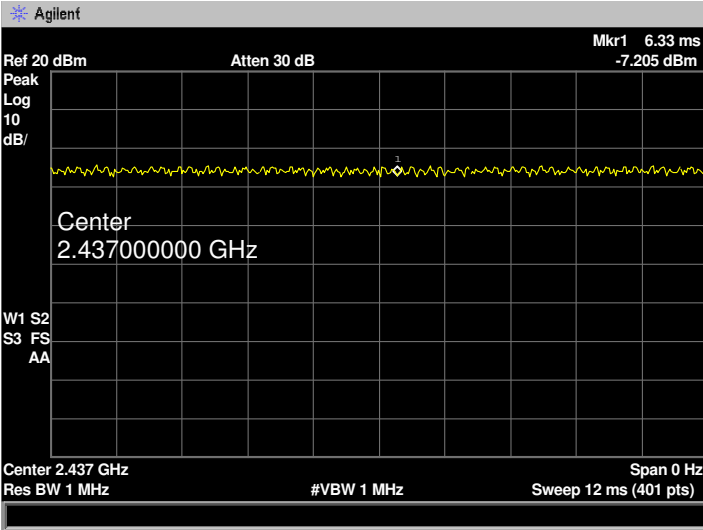

802.11 N20 Mode 2462 MHz

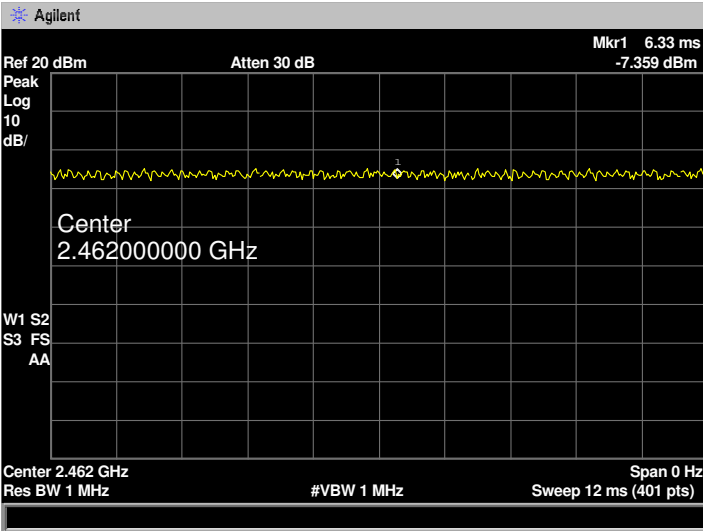

802.11 N40 Mode 2422 MHz

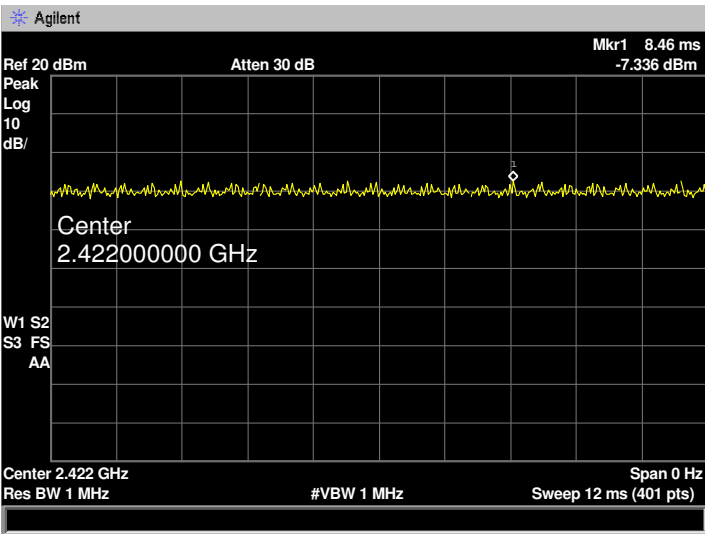

802.11 N40 Mode 2437 MHz

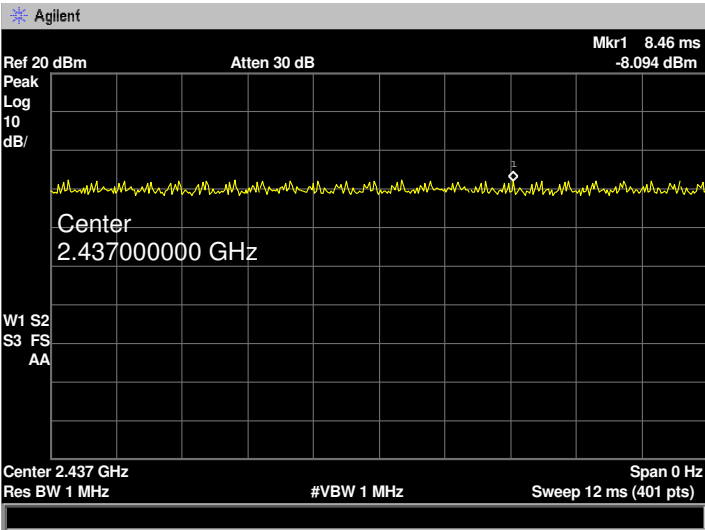

802.11 N40 Mode 2452 MHz

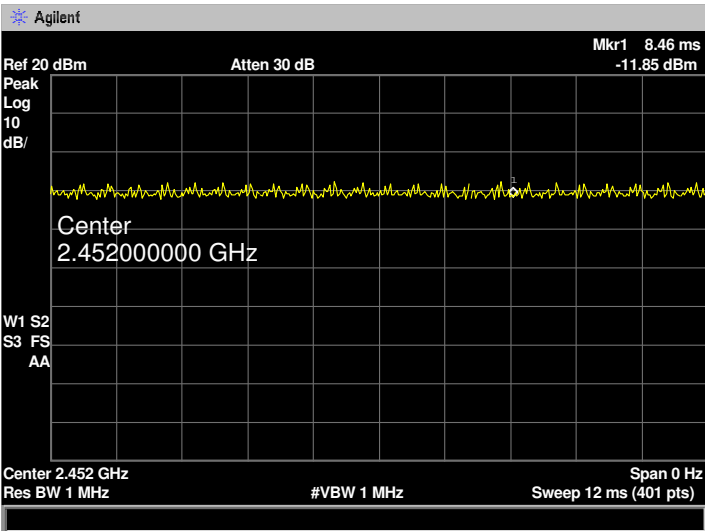

9. Power Spectral Density Test

9.1 Test Standard and Limit

9.1.1 Test Standard

FCC Part 15.247 (e)

9.1.2 Test Limit

FCC Part 15 Subpart C(15.247)		
Test Item	Limit	Frequency Range(MHz)
Power Spectral Density	8dBm(in any 3 kHz)	2400~2483.5

9.2 Test Setup

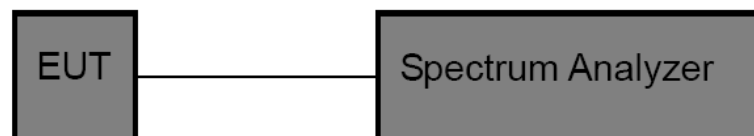

9.3 Test Procedure

The EUT was directly connected to the Spectrum Analyzer and antenna output port as show in the block diagram above. The measurement according to section 10.2 of KDB 558074 D01 DTS Meas Guidance v03r04.

- (1) The EUT was directly connected to the spectrum analyzer and antenna output port as show in the block diagram above.
- (2) Set analyser center frequency to DTS channel center frequency.
- (3) Set the span to 1.5 times the DTS bandwidth.
- (4) Set the RBW to: 3 kHz
- (5) Set the VBW to: 10 kHz
- (6) Detector: peak
- (7) Sweep time: auto
- (8) Allow trace to fully stabilize. Then use the peak marker function to determine the maximum amplitude level.

9.4 EUT Operating Condition

The EUT was set to continuously transmitting in each mode and low, middle and high channel for the test.

9.5 Test Data

EUT:	WarriorG1	Model:	XM-JPG1-2
Temperature:	25 °C	Relative Humidity:	55%
Test Voltage:	DC 3.6V		
Test Mode:	TX 802.11B Mode		
Channel Frequency (MHz)	Power Density (3 kHz/dBm)	Limit (dBm)	
2412	-24.54	8	
2437	-25.34		
2462	-26.13		
802.11B Mode			
2412 MHz			
<p>Agilent Ref 20 dBm Atten 30 dB Mkr1 2.41128 GHz Peak -24.54 dBm Log 10 dB/ Offst 1 dB Marker 2.411280000 GHz -24.54 dBm M1 S2 S3 FC AA Center 2.412 GHz Span 16 MHz #Res BW 3 kHz #VBW 10 kHz Sweep 1.83 s (401 pts)</p>			

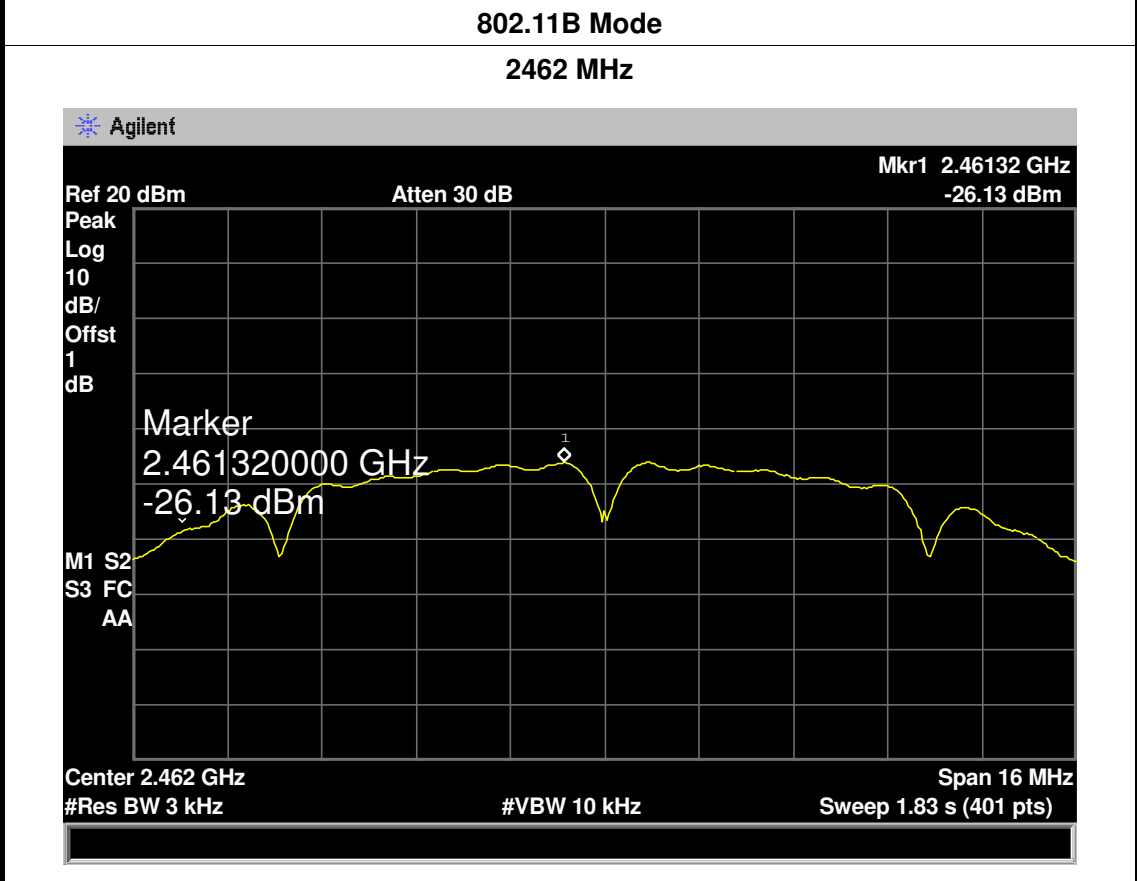
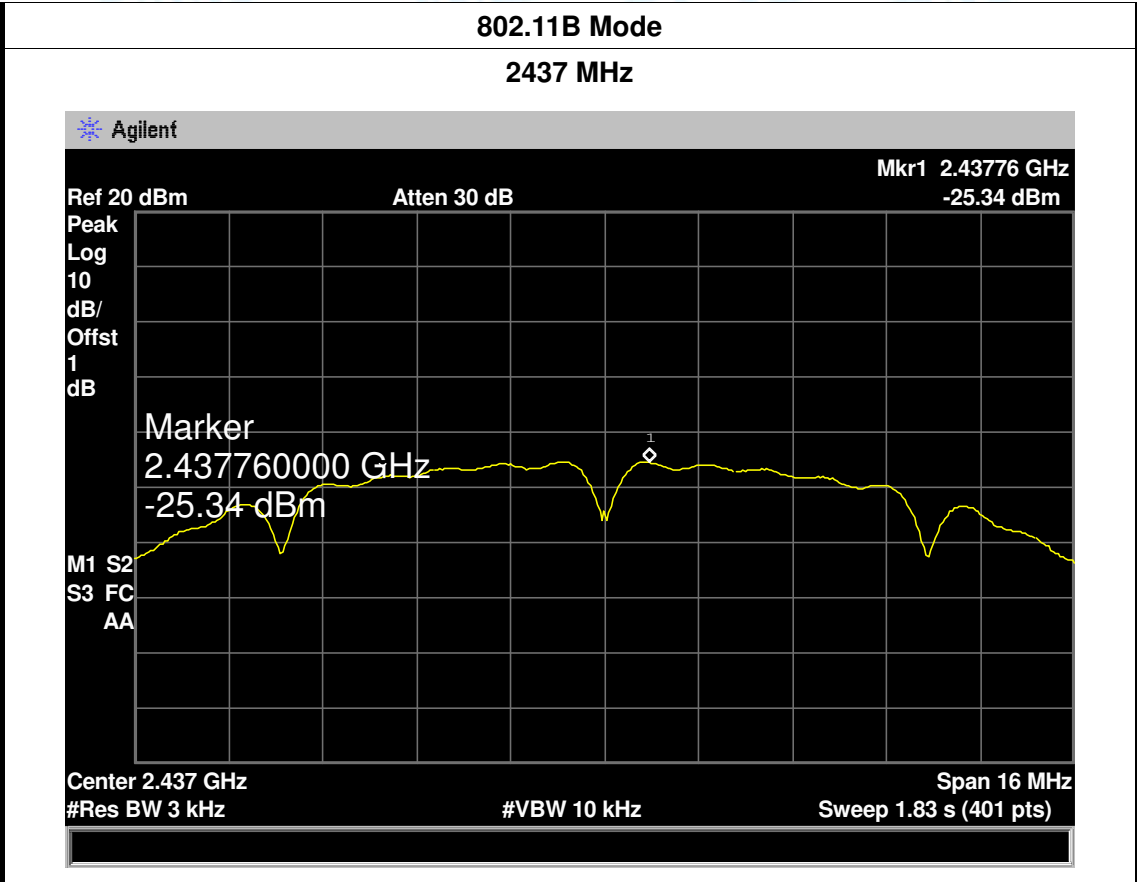

EUT:	WarriorG1	Model:	XM-JPG1-2
Temperature:	25 °C	Temperature:	25 °C
Test Voltage:	DC 3.6V		
Test Mode:	TX 802.11G Mode		
Channel Frequency (MHz)	Power Density (3 kHz/dBm)	Limit (dBm)	
2412	-21.41	8	
2437	-24.34		
2462	-24.95		
802.11G Mode			
2412 MHz			

The screenshot shows an Agilent spectrum analyzer interface. At the top, it says 'Agilent'. The main display area shows a yellow signal trace on a black grid. A marker is placed on the signal at 2.407601250 GHz, with a power density of -21.41 dBm. The plot is titled 'Mkr1 2.40760 GHz -21.41 dBm'. On the left side, there are labels for 'Ref 20 dBm', 'Atten 30 dB', 'Peak Log', '10 dB/Offst', '1 dB', 'M1 S2', 'S3 FC', and 'AA'. At the bottom, there are labels for 'Center 2.412 GHz', '#Res BW 3 kHz', '#VBW 10 kHz', 'Span 25.5 MHz', and 'Sweep 2.916 s (401 pts)'.

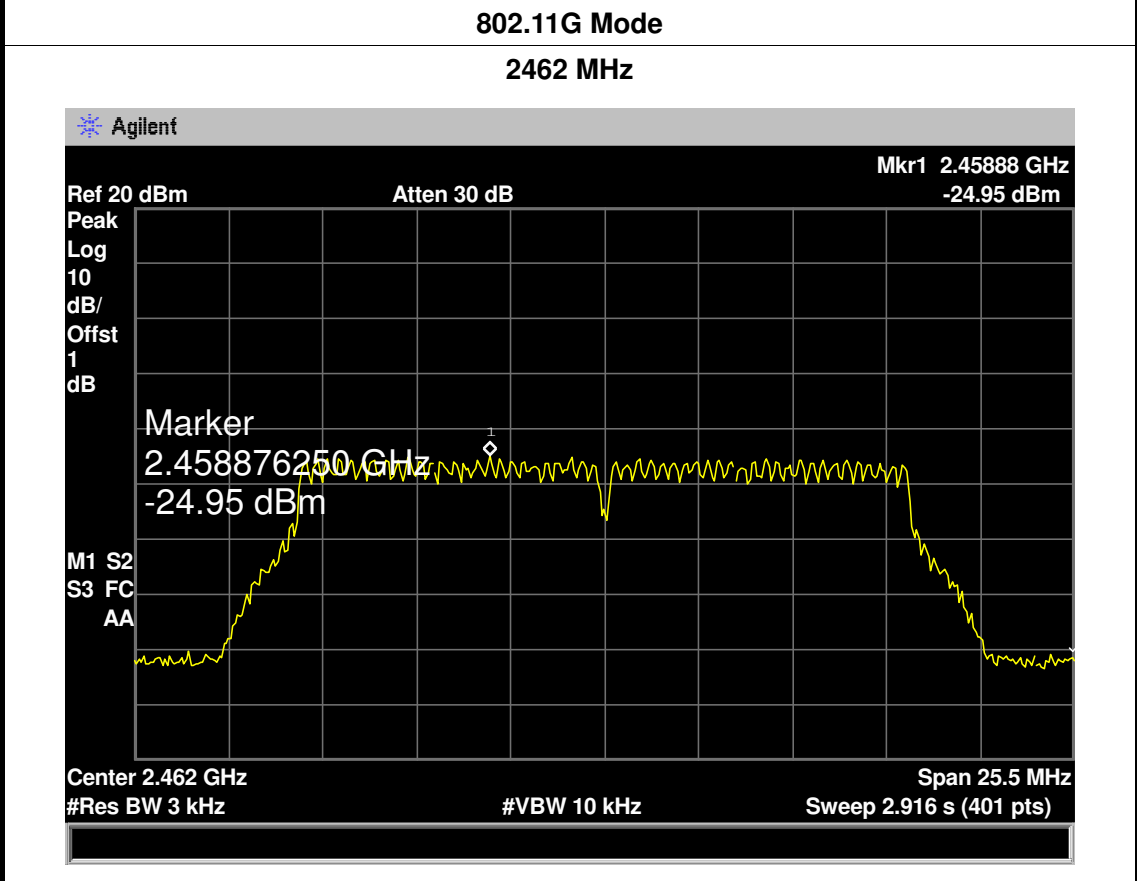
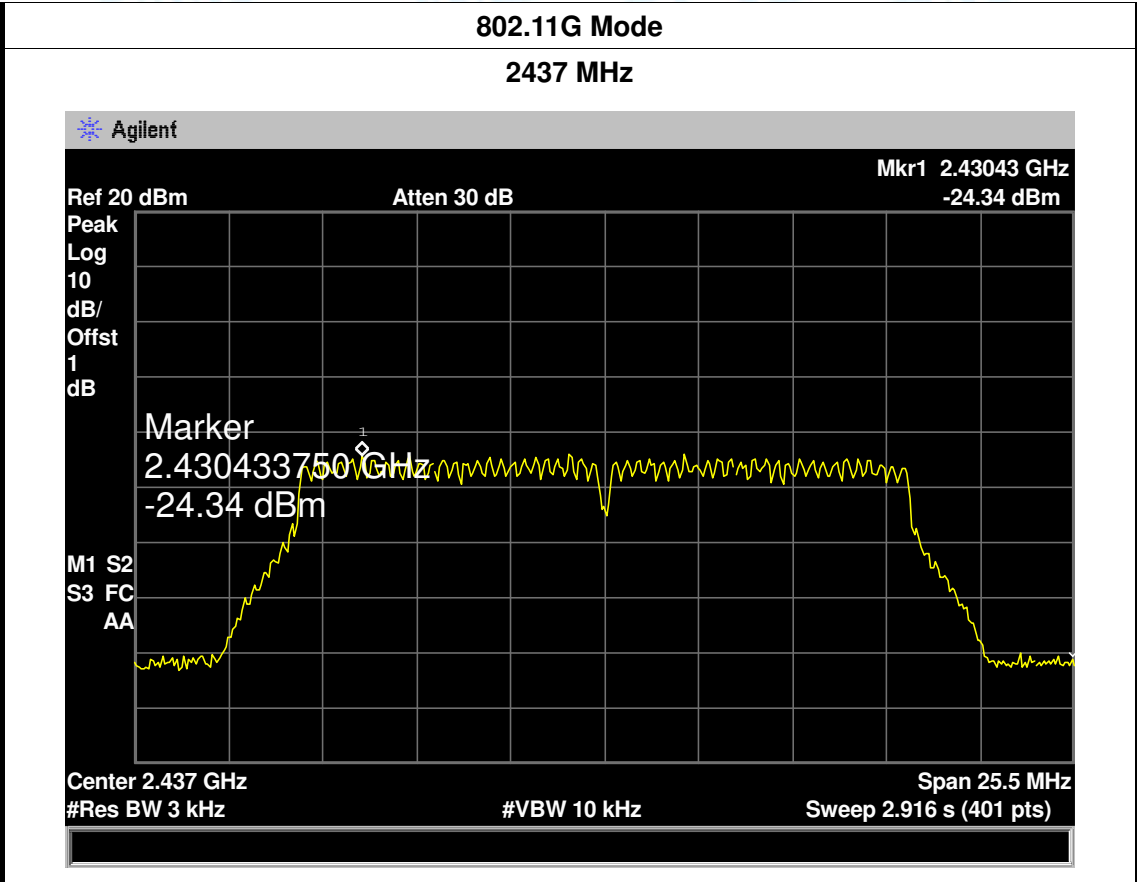

EUT:	WarriorG1	Model:	XM-JPG1-2
Temperature:	25 °C	Temperature:	25 °C
Test Voltage:	DC 3.6V		
Test Mode:	TX 802.11N(HT20) Mode		
Channel Frequency (MHz)	Power Density (3 kHz/dBm)	Limit (dBm)	
2412	-22.79	8	
2437	-24.51		
2462	-25.01		
802.11N(HT20) Mode			
2412 MHz			

The screenshot shows an Agilent spectrum analyzer interface. The main display is a grid with a yellow signal trace. A marker is placed at 2.4185475 GHz, with a power density of -22.79 dBm. The reference level is 20 dBm, and the attenuation is 30 dB. The center frequency is 2.412 GHz, and the span is 27 MHz. The resolution bandwidth is 3 kHz, and the sweep time is 3.088 seconds. The plot shows a signal with a peak at the marked frequency, with a slight dip in the middle of the channel.

802.11N(HT20) Mode

2437 MHz

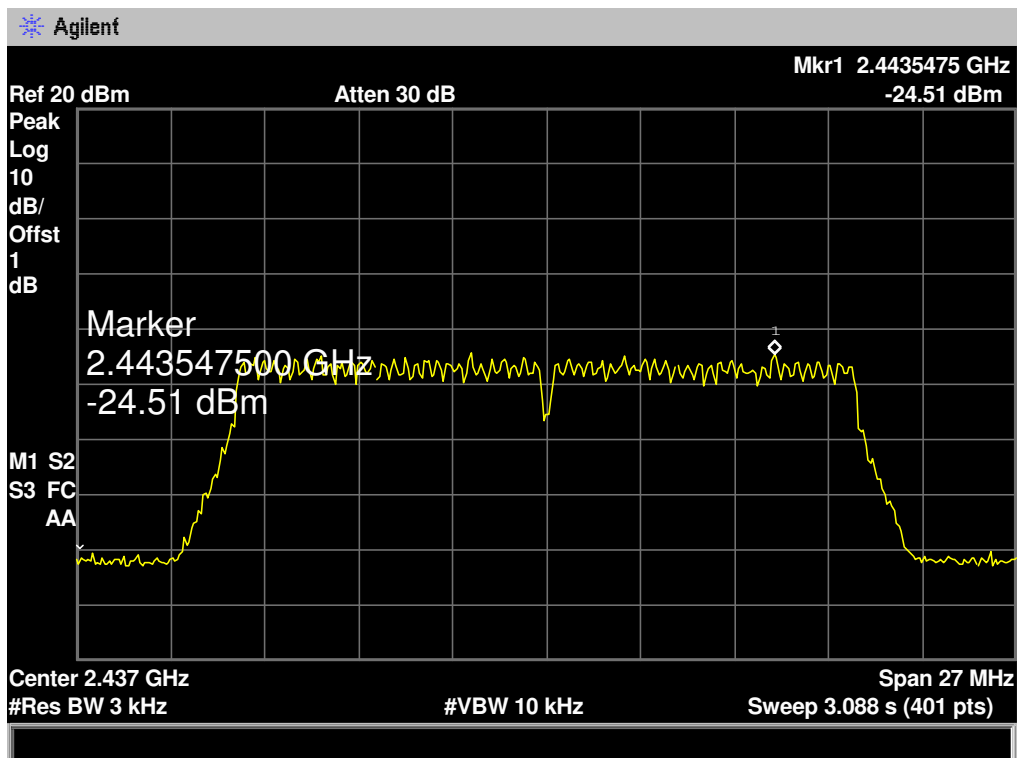

802.11N(HT20) Mode

2462 MHz

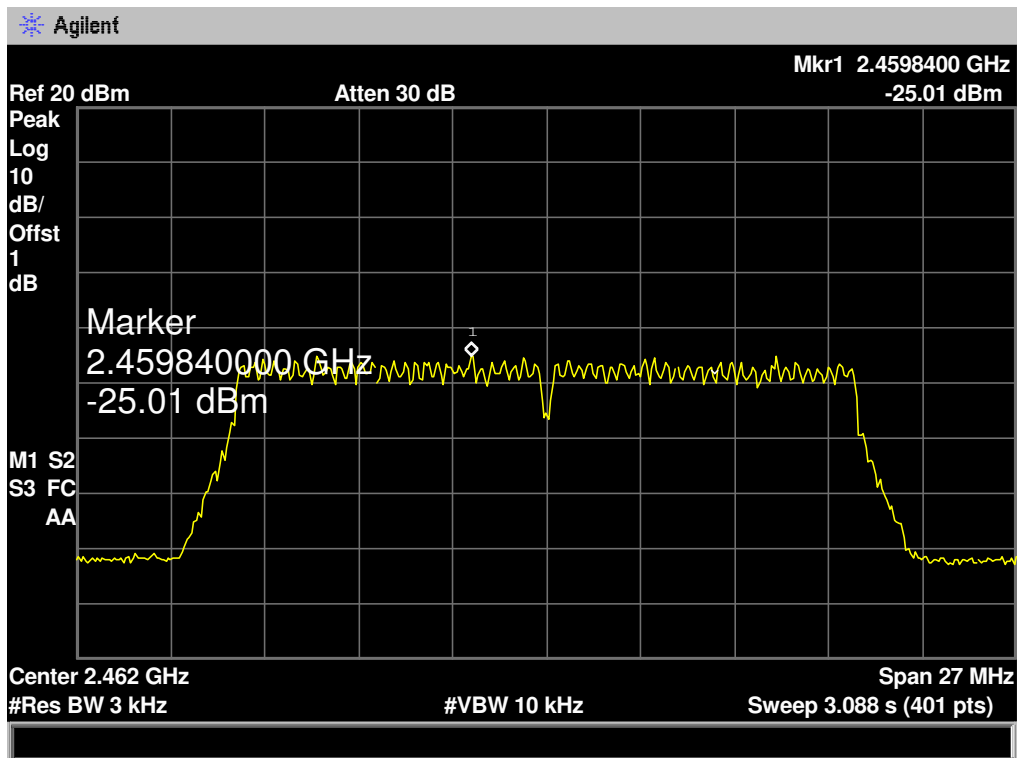

EUT:	WarriorG1	Model:	XM-JPG1-2
Temperature:	25 °C	Temperature:	25 °C
Test Voltage:	DC 3.6V		
Test Mode:	TX 802.11N(HT40) Mode		
Channel Frequency (MHz)	Power Density (3 kHz/dBm)	Limit (dBm)	
2422	-24.96	8	
2437	-24.74		
2452	-26.15		

802.11N(HT40) Mode

2422 MHz

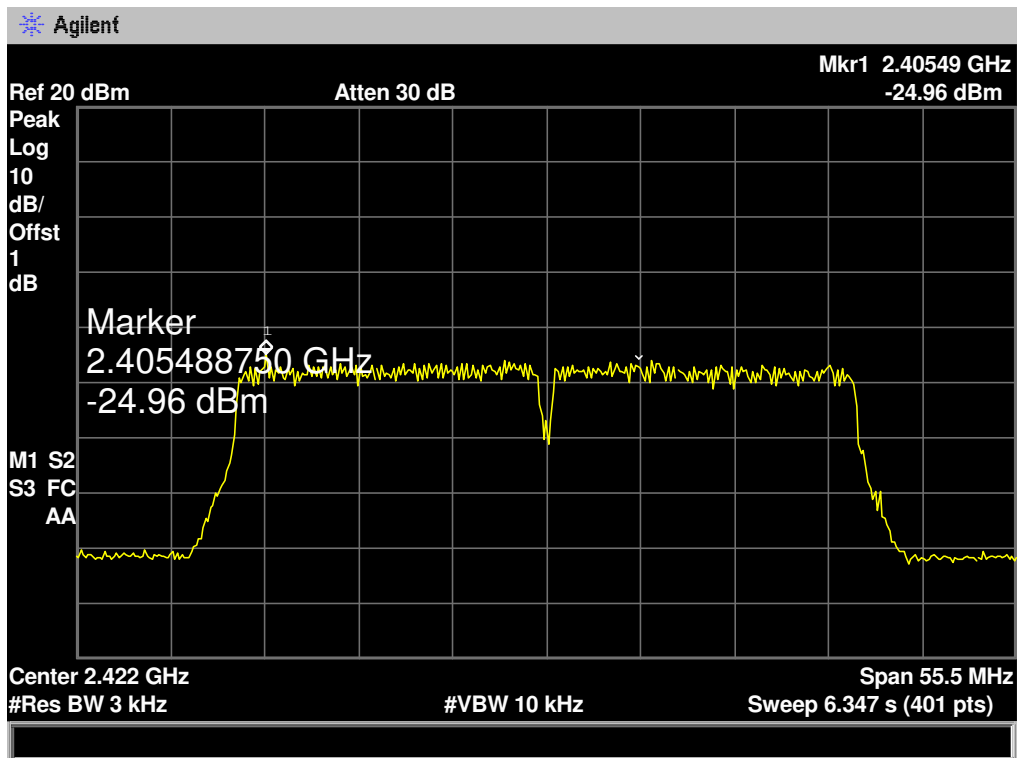

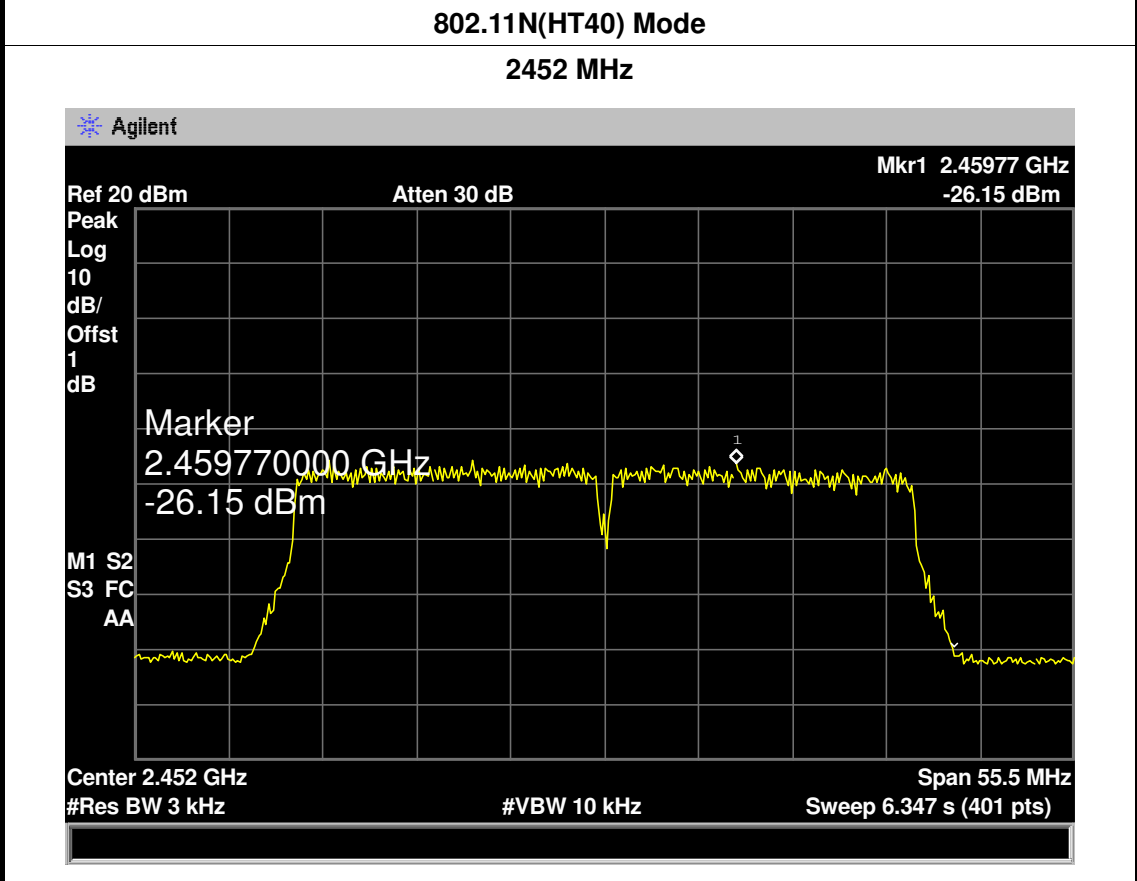
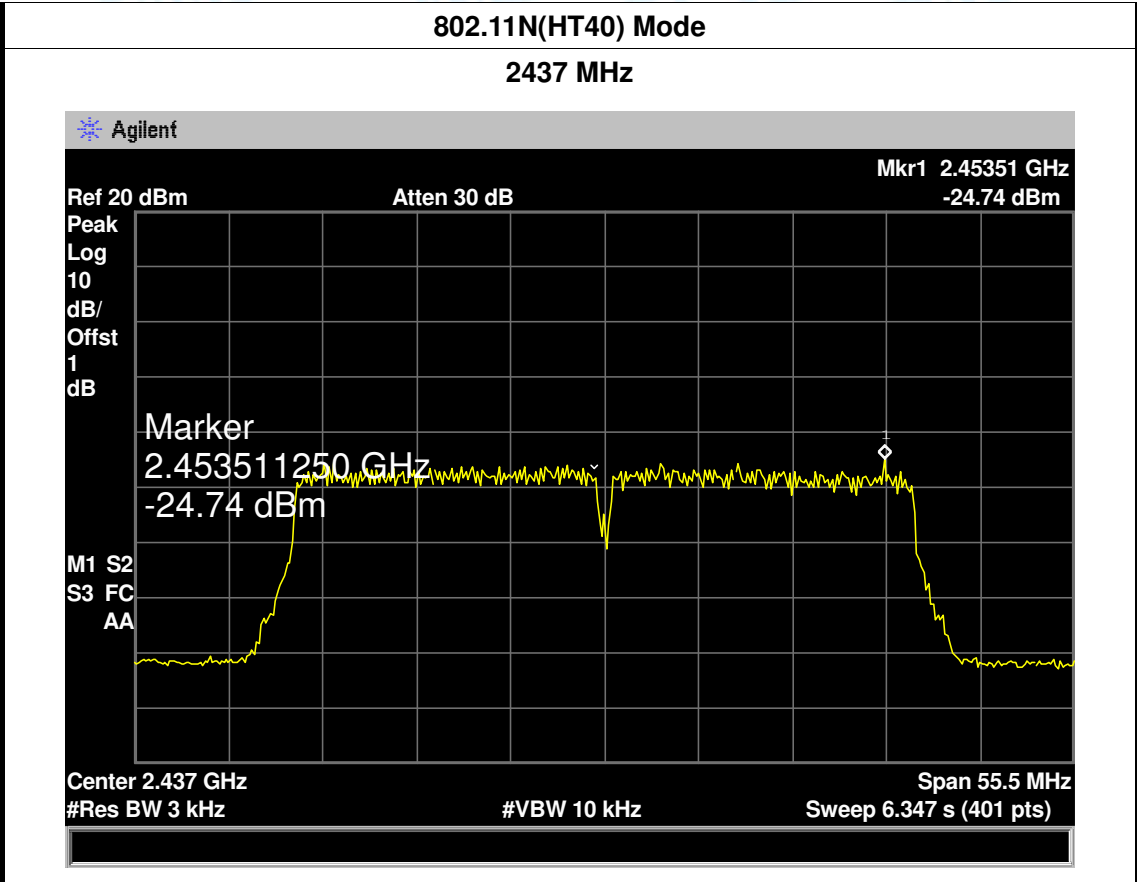

10. Antenna Requirement

10.1 Standard Requirement

10.1.1 Standard

FCC Part 15.203

10.1.2 Requirement

An intentional radiator shall be designed to ensure that no antenna other than that furnished by the responsible party shall be used with the device. The use of a permanently attached antenna or of an antenna that uses a unique coupling to the intentional radiator shall be considered sufficient to comply with the provisions of this Section. The manufacturer may design the unit so that a broken antenna can be replaced by the user, but the use of a standard antenna jack or electrical connector is prohibited.

10.2 Antenna Connected Construction

The directional gains of the antenna used for transmitting is 2 dBi, and the antenna de-signed with permanent attachment and no consideration of replacement. Please see the EUT photo for details.

Result

The EUT antenna is a PCB Antenna. It complies with the standard requirement.

Antenna Type
<input checked="" type="checkbox"/> Permanent attached antenna
<input type="checkbox"/> Unique connector antenna
<input type="checkbox"/> Professional installation antenna