

FCC TEST REPORT  
FOR  
BRITELITE ENTERPRISES  
SPEAKER

Test Model: iR-4000  
Additional No.: HT-M6-1, HT-M6-2, HT-M6-3, HT-SA6.5, HT-M6, HT-M8,  
HT-601S, HT-N91S, HT-A87, HT-A88

Prepared for : BRITELITE ENTERPRISES  
Address : 11901 SANTA MONICA BLVD 3413 LOS ANGELES, CA 90025,  
USA

Prepared by : Shenzhen LCS Compliance Testing Laboratory Ltd.  
Address : 1/F., Xingyuan Industrial Park, Tongda Road, Bao'an Avenue,  
Bao'an District, Shenzhen, Guangdong, China

Tel : (+86)755-82591330  
Fax : (+86)755-82591332  
Web : www.LCS-cert.com  
Mail : webmaster@LCS-cert.com

Date of receipt of test sample : Oct. 21, 2017  
Number of tested samples : 1  
Serial number : Prototype  
Date of Test : Oct. 22, 2017–Nov. 06, 2017  
Date of Report : Nov. 07, 2017

<b>FCC TEST REPORT</b>	
<b>FCC CFR 47 PART 15 C(15.247): 2017</b>	
<b>Report Reference No.</b> .....	<b>LCS170831044AE1</b>
<b>Date of Issue</b> .....	<b>Nov. 07, 2017</b>
<b>Testing Laboratory Name</b> .....	<b>Shenzhen LCS Compliance Testing Laboratory Ltd.</b>
<b>Address</b> .....	1/F., Xingyuan Industrial Park, Tongda Road, Bao'an Avenue, Bao'an District, Shenzhen, Guangdong, China
<b>Testing Location/ Procedure</b> .....	Full application of Harmonised standards <input checked="" type="checkbox"/> Partial application of Harmonised standards <input type="checkbox"/> Other standard testing method <input type="checkbox"/>
<b>Applicant's Name</b> .....	<b>BRITELITE ENTERPRISES</b>
<b>Address</b> .....	11901 SANTA MONICA BLVD 3413 LOS ANGELES, CA 90025, USA
<b>Test Specification</b>	
<b>Standard</b> .....	FCC CFR 47 PART 15 C(15.247): 2016
<b>Test Report Form No.</b> .....	LCSEMC-1.0
<b>TRF Originator</b> .....	Shenzhen LCS Compliance Testing Laboratory Ltd.
<b>Master TRF</b> .....	Dated 2011-03
<b>Shenzhen LCS Compliance Testing Laboratory Ltd. All rights reserved.</b>	
This publication may be reproduced in whole or in part for non-commercial purposes as long as the Shenzhen LCS Compliance Testing Laboratory Ltd. is acknowledged as copyright owner and source of the material. Shenzhen LCS Compliance Testing Laboratory Ltd. takes no responsibility for and will not assume liability for damages resulting from the reader's interpretation of the reproduced material due to its placement and context.	
<b>Test Item Description.</b> .....	<b>SPEAKER</b>
<b>Trade Mark</b> .....	N/A
<b>Test Model</b> .....	iR-4000
	MODEL NO: SJ-09012001
<b>Ratings</b> .....	INPUT:100-240V~, 50/60Hz, 0.8A
	OUTPUT: Output: 9V===1.2A
<b>Result</b> .....	<b>Positive</b>

**Compiled by:**

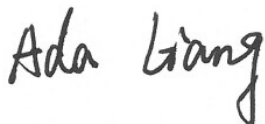

Ada Liang/ File administrators

**Supervised by:**



Glin Lu/ Technique principal

**Approved by:**



Gavin Liang/ Manager



**Revision History**

Revision	Issue Date	Revisions	Revised By
00	Nov. 07, 2017	Initial Issue	Gavin Liang

**Table of Contents**

**Page**

<b>1. SUMMARY.....</b>	<b>6</b>
1.1. TEST STANDARDS.....	6
1.2. TEST DESCRIPTION.....	6
1.3. TEST FACILITY.....	7
1.4. STATEMENT OF THE MEASUREMENT UNCERTAINTY.....	7
<b>2. GENERAL INFORMATION.....</b>	<b>8</b>
2.1. ENVIRONMENTAL CONDITIONS.....	8
2.2. GENERAL DESCRIPTION OF EUT.....	8
2.3. DESCRIPTION OF TEST MODES AND TEST FREQUENCY.....	8
2.4. EQUIPMENTS USED DURING THE TEST.....	9
2.5. RELATED SUBMITTAL(S) / GRANT (S).....	9
2.6. MODIFICATIONS.....	10
<b>3. TEST CONDITIONS AND RESULTS.....</b>	<b>11</b>
3.1. CONDUCTED EMISSIONS TEST.....	11
3.2. RADIATED EMISSIONS AND BAND EDGE.....	14
3.3. MAXIMUM PEAK OUTPUT POWER.....	21
3.4. 20dB BANDWIDTH.....	25
3.5. FREQUENCY SEPARATION.....	29
3.6. NUMBER OF HOPPING FREQUENCY.....	31
3.7. TIME OF OCCUPANCY (DWELL TIME).....	33
3.8. OUT-OF-BAND EMISSIONS.....	37
3.9. PSEUDORANDOM FREQUENCY HOPPING SEQUENCE.....	45
3.10. ANTENNA REQUIREMENT.....	46
<b>4. TEST SETUP PHOTOS OF THE EUT.....</b>	<b>47</b>
<b>5. PHOTOS OF THE EUT.....</b>	<b>48</b>

# 1. SUMMARY

## 1.1. TEST STANDARDS

The tests were performed according to following standards:

**FCC Rules Part 15.247:** Frequency Hopping, Direct Spread Spectrum and Hybrid Systems that are in operation within the bands of 902-928 MHz, 2400-2483.5 MHz, and 5725-5850 MHz

**ANSI C63.10: 2013:** American National Standard for Testing Unlicensed Wireless Devices

**ANSI C63.4: 2014:** –American National Standard for Methods of Measurement of Radio-Noise Emissions from Low-Voltage Electrical and Electronic Equipment in the Range of 9 kHz to 40GHz  
Range of 9 kHz to 40GHz

**KDB558074 D01 V03r05:** Guidance for Performing Compliance Measurements on Digital Transmission Systems (DTS) Operating Under §15.247

## 1.2. Test Description

FCC PART 15.247		
FCC Part 15.207	AC Power Conducted Emission	PASS
FCC Part 15.247(a)(1)(i)	20dB Bandwidth	PASS
FCC Part 15.247(d)	Spurious RF Conducted Emission	PASS
FCC Part 15.247(b)	Maximum Peak Output Power	PASS
FCC Part 15.247(b)	Pseudorandom Frequency Hopping Sequence	PASS
FCC Part 15.247(a)(1)(iii)	Number of hopping frequency& Time of Occupancy	PASS
FCC Part 15.247(a)(1)	Frequency Separation	PASS
FCC Part 15.205/15.209	Radiated Emissions	PASS
FCC Part 15.247(d)	Band Edge Compliance of RF Emission	PASS
FCC Part 15.203/15.247 (b)	Antenna Requirement	PASS

### 1.3. Test Facility

#### 1.3.1 Address of the test laboratory

Shenzhen LCS Compliance Testing Laboratory Ltd.  
 1/F., Xingyuan Industrial Park, Tongda Road, Bao'an Avenue, Bao'an District, Shenzhen, Guangdong, China

There is one 3m semi-anechoic chamber fulfils CISPR 16-1-4 according to ANSI C63.10:2013 and CISPR 16-1-4:2010 SVSWR requirement for radiated emission above 1GHz.

#### 1.3.2 Laboratory accreditation

The test facility is recognized, certified, or accredited by the following organizations:

- CNAS Registration Number. is L4595.
- FCC Registration Number. is 254912.
- Industry Canada Registration Number. is 9642A-1.
- ESMD Registration Number. is ARCB0108.
- UL Registration Number. is 100571-492.
- TUV SUD Registration Number. is SCN1081.
- TUV RH Registration Number. is UA 50296516-001

### 1.4. Statement of the measurement uncertainty

The data and results referenced in this document are true and accurate. The reader is cautioned that there may be errors within the calibration limits of the equipment and facilities. The measurement uncertainty was calculated for all measurements listed in this test report acc. To CISPR 16 – 4 “Specification for radio disturbance and immunity measuring apparatus and methods – Part 4: Uncertainty in EMC Measurements” and is documented in the LCS quality system acc. To DIN EN ISO/IEC 17025. Furthermore, component and process variability of devices similar to that tested may result in additional deviation. The manufacturer has the sole responsibility of continued compliance of the device.

Test Item	Frequency Range	Uncertainty	Note
Radiation Uncertainty	9KHz~30MHz	3.10dB	(1)
	30MHz~200MHz	2.96dB	(1)
	200MHz~1000MHz	3.10dB	(1)
	1GHz~26.5GHz	3.80dB	(1)
	26.5GHz~40GHz	3.90dB	(1)
Conduction Uncertainty	150kHz~30MHz	1.63dB	(1)
Power disturbance	30MHz~300MHz	1.60dB	(1)

(1) This uncertainty represents an expanded uncertainty expressed at approximately the 95% confidence level using a coverage factor of k=2.

## 2. GENERAL INFORMATION

### 2.1. Environmental conditions

During the measurement the environmental conditions were within the listed ranges:

Normal Temperature:	25°C
Relative Humidity:	55 %
Air Pressure:	101 kPa

### 2.2. General Description of EUT

Product Name:	SPEAKER
Model/Type reference:	iR-4000
Power supply:	DC 7.4V from battery
Adapter information:	Model: SJ-09012001 Input: 100-240V~, 50/60Hz, 0.8A Output: 9V---1.2A
<b>Bluetooth :</b>	
Version:	Supported BT3.0
Modulation:	GFSK, $\pi/4$ DQPSK, 8DPSK
Operation frequency:	2402MHz~2480MHz
Channel number:	79
Channel separation:	1MHz
Antenna type:	PCB antenna
Antenna gain:	0dBi

Note: For more details, please refer to the user’s manual of the EUT.

### 2.3. Description of Test Modes and Test Frequency

The Applicant provides communication tools software to control the EUT for staying in continuous transmitting (Duty Cycle more than 98%) and receiving mode for testing .There are 79 channels provided to the EUT and Channel 00/39/78 were selected to test.

#### Operation Frequency :

Channel	Frequency (MHz)
00	2402
01	2403
:	:
38	2440
39	2441
40	2442
:	:
77	2479
78	2480



Preliminary tests were performed in each mode and packet length of BT, and found worst case as below, finally test were conducted at those mode and recorded in this report.

Test Items	Worst case
Conducted Emissions	DH5 Middle channel
Radiated Emissions and Band Edge	2DH5
Maximum Conducted Output Power	DH5/2DH5/3DH5
20dB Bandwidth	DH5/2DH5/3DH5
Frequency Separation	DH5/2DH5/3DH5 Middle channel
Number of hopping frequency	DH5/2DH5/3DH5
Time of Occupancy (Dwell Time)	DH1/DH3/DH5 Middle channel 2DH1/2DH3/2DH5 Middle channel 3DH1/3DH3/3DH5 Middle channel
Out-of-band Emissions	DH5/2DH5/3DH5

## 2.4. Equipments Used during the Test

Item	Equipment	Manufacturer	Model No.	Serial No.	Last Cal.	Next Cal.
1	EMC Receiver	R&S	ESCS 30	100174	2017-06-18	2018-06-17
2	Signal analyzer	Agilent	E4448A(External mixers to 40GHz)	US44300469	2017-07-16	2018-06-17
3	Spectrum Analyzer	Agilent	N9020A	MY50510140	2017-10-27	2018-10-26
4	LISN	MESS Tec	NNB-2/16Z	99079	2017-06-18	2018-06-17
5	LISN	EMCO	3819/2NM	9703-1839	2017-06-18	2018-06-17
6	RF Cable-CON	UTIFLEX	3102-26886-4	CB049	2017-06-18	2018-06-17
7	ISN	SCHAFFNER	ISN ST08	21653	2017-06-18	2018-06-17
8	3m Semi Anechoic Chamber	SIDT FRANKONIA	SAC-3M	03CH03-HY	2017-06-18	2018-06-17
9	Amplifier	SCHAFFNER	COA9231A	18667	2017-06-18	2018-06-17
10	Amplifier	Agilent	8449B	3008A02120	2017-06-16	2018-06-15
11	Amplifier	MITEQ	AMF-6F-260400	9121372	2017-06-16	2018-06-15
12	Loop Antenna	R&S	HFH2-Z2	860004/001	2017-06-18	2018-06-17
13	By-log Antenna	SCHWARZBECK	VULB9163	9163-470	2017-06-10	2018-06-09
14	Horn Antenna	EMCO	3115	6741	2017-06-10	2018-06-09
15	Horn Antenna	SCHWARZBECK	BBHA9170	BBHA9170154	2017-06-10	2018-06-09
16	RF Cable-R03m	Jye Bao	RG142	CB021	2017-06-18	2018-06-17
17	RF Cable-HIGH	SUHNER	SUCOFLEX 106	03CH03-HY	2017-06-18	2018-06-17
18	Power Sensor	R&S	NRV-Z81	100458	2017-06-18	2018-06-17
19	Power Sensor	R&S	NRV-Z32	10057	2017-06-18	2018-06-17
20	Power Meter	R&S	NRVS	100444	2017-06-18	2018-06-17

The calibration interval was one year

## 2.5. Related Submittal(s) / Grant (s)

This submittal(s) (test report) is intended to comply with Section 15.247 of the FCC Part 15, Subpart C Rules.

## **2.6. Modifications**

No modifications were implemented to meet testing criteria.

### 3. TEST CONDITIONS AND RESULTS

#### 3.1. Conducted Emissions Test

**LIMIT**

FCC CFR Title 47 Part 15 Subpart C Section 15.207

Frequency range (MHz)	Limit (dBuV)	
	Quasi-peak	Average
0.15-0.5	66 to 56*	56 to 46*
0.5-5	56	46
5-30	60	50

\* Decreases with the logarithm of the frequency.

**TEST CONFIGURATION**

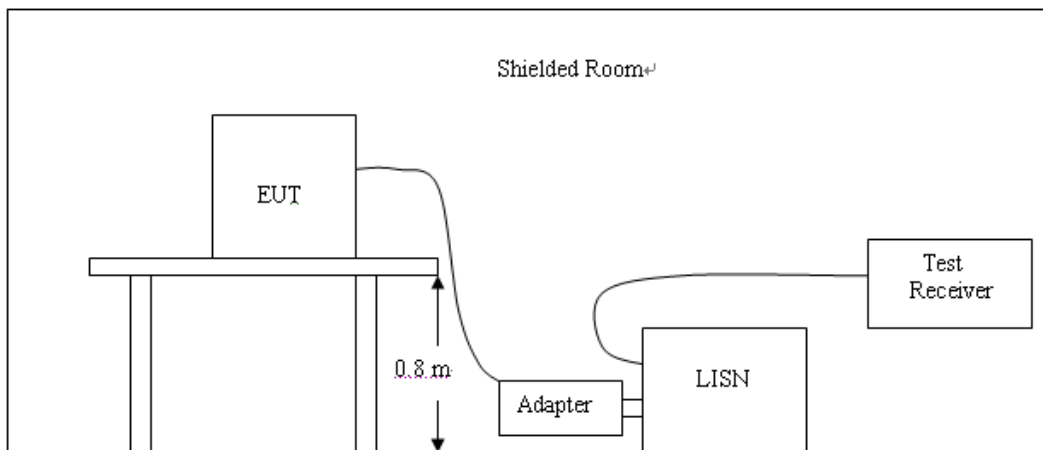

**TEST PROCEDURE**

1. The equipment was set up as per the test configuration to simulate typical actual usage per the user’s manual. The EUT is a tabletop system; a wooden table with a height of 0.8 meters is used and is placed on the ground plane as per ANSI C63.10:2013.
2. Support equipment, if needed, was placed as per ANSI C63.10:2013.
3. All I/O cables were positioned to simulate typical actual usage as per ANSI C63.10:2013.
4. The adapter received AC120V/60Hz power through a Line Impedance Stabilization Network (LISN) which supplied power source and was grounded to the ground plane.
5. All support equipments received AC power from a second LISN, if any.
6. The EUT test program was started. Emissions were measured on each current carrying line of the EUT using a spectrum Analyzer / Receiver connected to the LISN powering the EUT. The LISN has two monitoring points: Line 1 (Hot Side) and Line 2 (Neutral Side). Two scans were taken: one with Line 1 connected to Analyzer / Receiver and Line 2 connected to a 50 ohm load; the second scan had Line 1 connected to a 50 ohm load and Line 2 connected to the Analyzer / Receiver.
7. Analyzer / Receiver scanned from 150 KHz to 30MHz for emissions in each of the test modes.
8. During the above scans, the emissions were maximized by cable manipulation.

**TEST RESULTS**

Remark: All modes of GFSK, π/4DQPSK, and 8DPSK were test at Low, Middle, and High channel; only the worst result of GFSK Middle Channel was reported as below:

**SCAN TABLE: "Voltage (9K-30M)FIN"**  
 Short Description: 150K-30M Voltage

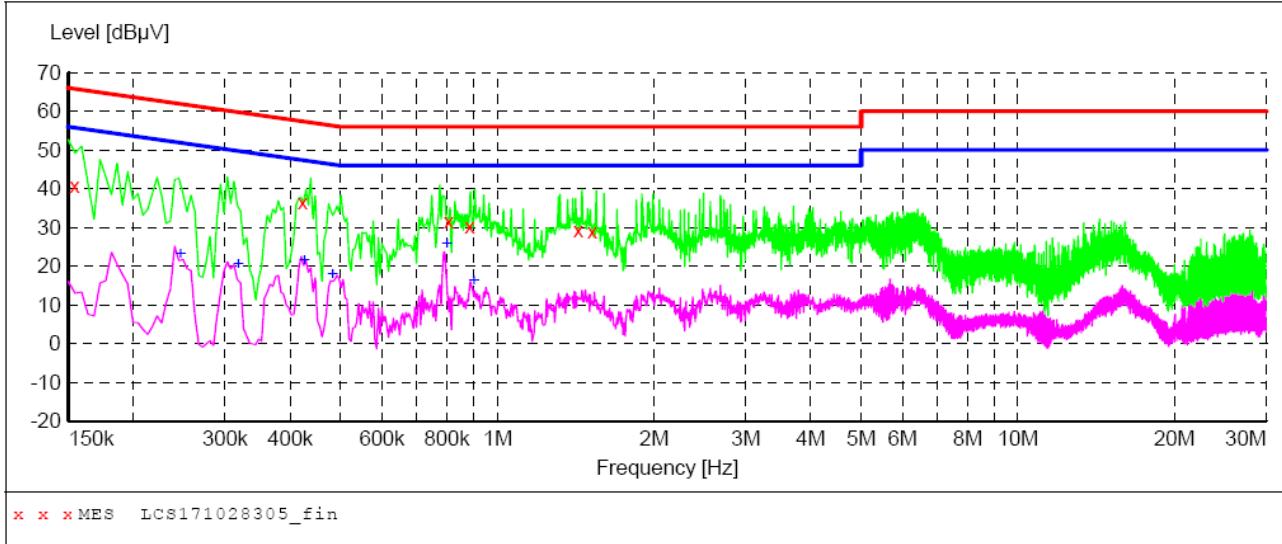

**MEASUREMENT RESULT: "LCS171028305\_fin"**

10/28/2017 14:45

Frequency MHz	Level dBµV	Transd dB	Limit dBµV	Margin dB	Detector	Line	PE
0.154000	40.70	10.2	66	25.1	QP	L1	GND
0.422000	36.40	10.2	57	21.0	QP	L1	GND
0.806000	31.40	10.2	56	24.6	QP	L1	GND
0.884000	30.20	10.2	56	25.8	QP	L1	GND
1.430000	29.10	10.3	56	26.9	QP	L1	GND
1.520000	29.00	10.3	56	27.0	QP	L1	GND

**MEASUREMENT RESULT: "LCS171028305\_fin2"**

10/28/2017 14:45

Frequency MHz	Level dBµV	Transd dB	Limit dBµV	Margin dB	Detector	Line	PE
0.246000	23.00	10.2	52	28.9	AV	L1	GND
0.318000	20.30	10.2	50	29.5	AV	L1	GND
0.426000	21.30	10.2	47	26.0	AV	L1	GND
0.482000	17.90	10.2	46	28.4	AV	L1	GND
0.800000	25.50	10.2	46	20.5	AV	L1	GND
0.902000	16.20	10.2	46	29.8	AV	L1	GND

**SCAN TABLE: "Voltage (9K-30M)FIN"**

Short Description: 150K-30M Voltage

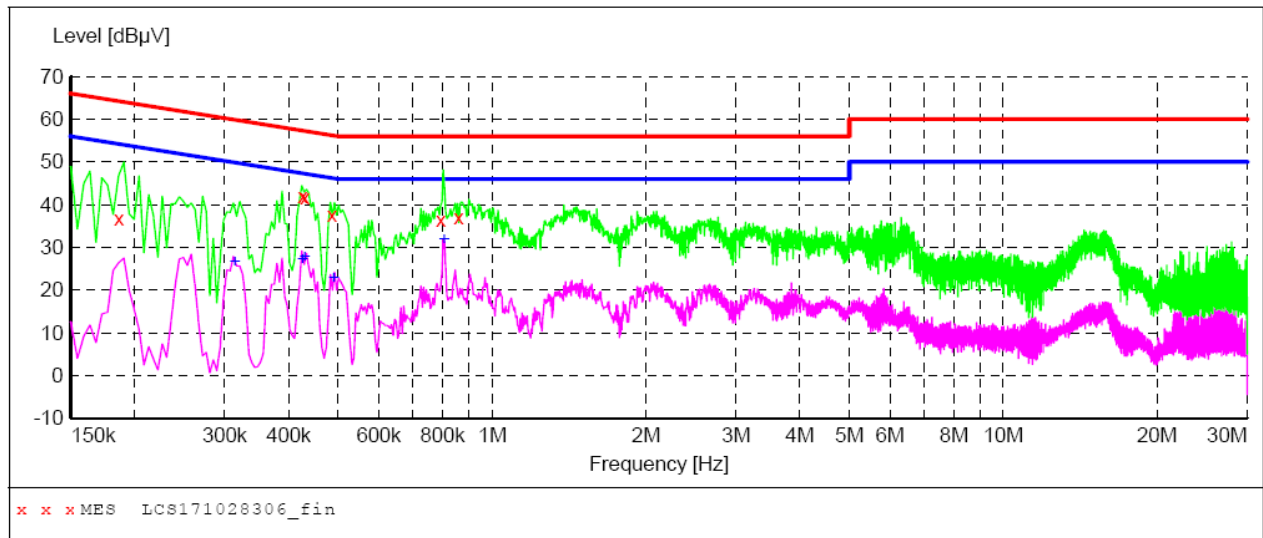

**MEASUREMENT RESULT: "LCS171028306\_fin"**

10/28/2017 14:48

Frequency MHz	Level dBµV	Transd dB	Limit dBµV	Margin dB	Detector	Line	PE
0.186000	36.70	10.2	64	27.5	QP	N	GND
0.426000	42.00	10.2	57	15.3	QP	N	GND
0.430000	41.70	10.2	57	15.6	QP	N	GND
0.486000	37.50	10.2	56	18.7	QP	N	GND
0.794000	36.40	10.2	56	19.6	QP	N	GND
0.860000	37.10	10.2	56	18.9	QP	N	GND

**MEASUREMENT RESULT: "LCS171028306\_fin2"**

10/28/2017 14:48

Frequency MHz	Level dBµV	Transd dB	Limit dBµV	Margin dB	Detector	Line	PE
0.314000	26.60	10.2	50	23.3	AV	N	GND
0.426000	27.20	10.2	47	20.1	AV	N	GND
0.430000	27.70	10.2	47	19.6	AV	N	GND
0.490000	22.60	10.2	46	23.6	AV	N	GND
0.806000	31.70	10.2	46	14.3	AV	N	GND

### 3.2. Radiated Emissions and Band Edge

#### Limit

For intentional device, according to § 15.209(a), the general requirement of field strength of radiated emission out of authorized band shall not exceed the following table at a 3 meters measurement distance.

In addition, radiated emissions which fall in the restricted bands, as defined in §15.205(a), must also comply with the radiated emission limits specified in §15.209(a)

Radiated emission limits

Frequency (MHz)	Distance (Meters)	Radiated (dBµV/m)	Radiated (µV/m)
0.009-0.49	3	$20\log(2400/F(\text{KHz}))+40\log(300/3)$	$2400/F(\text{KHz})$
0.49-1.705	3	$20\log(24000/F(\text{KHz}))+40\log(30/3)$	$24000/F(\text{KHz})$
1.705-30	3	$20\log(30)+40\log(30/3)$	30
30-88	3	40.0	100
88-216	3	43.5	150
216-960	3	46.0	200
Above 960	3	54.0	500

#### TEST CONFIGURATION

(A) Radiated Emission Test Set-Up, Frequency Below 30MHz

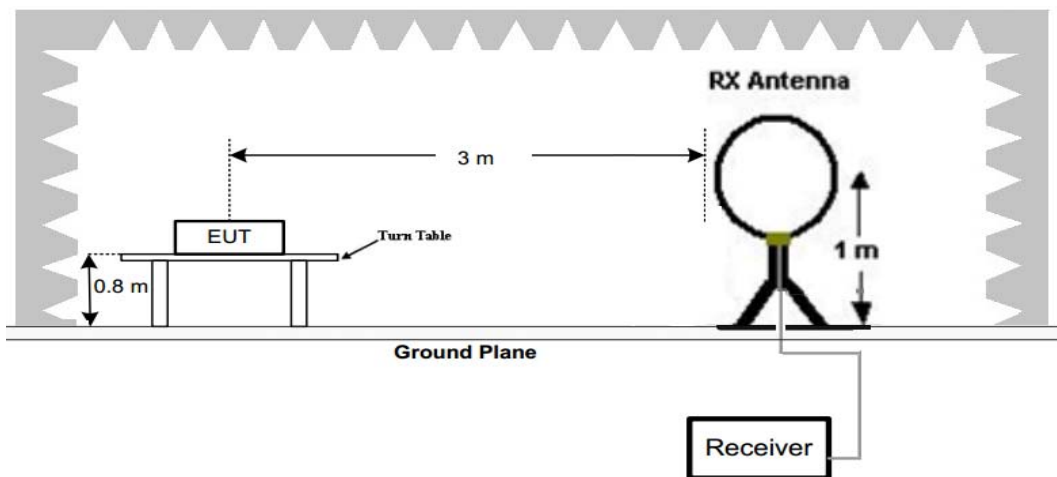

(B) Radiated Emission Test Set-Up, Frequency below 1000MHz

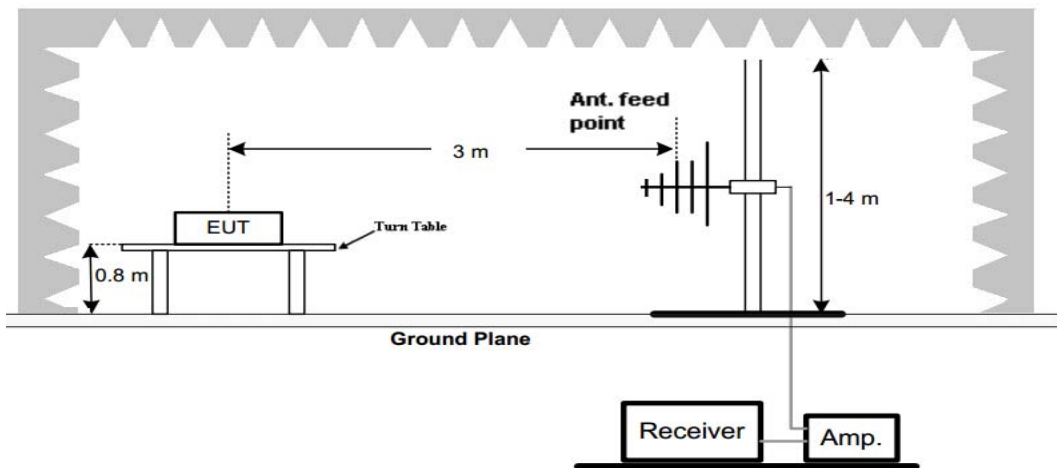

(C) Radiated Emission Test Set-Up, Frequency above 1000MHz

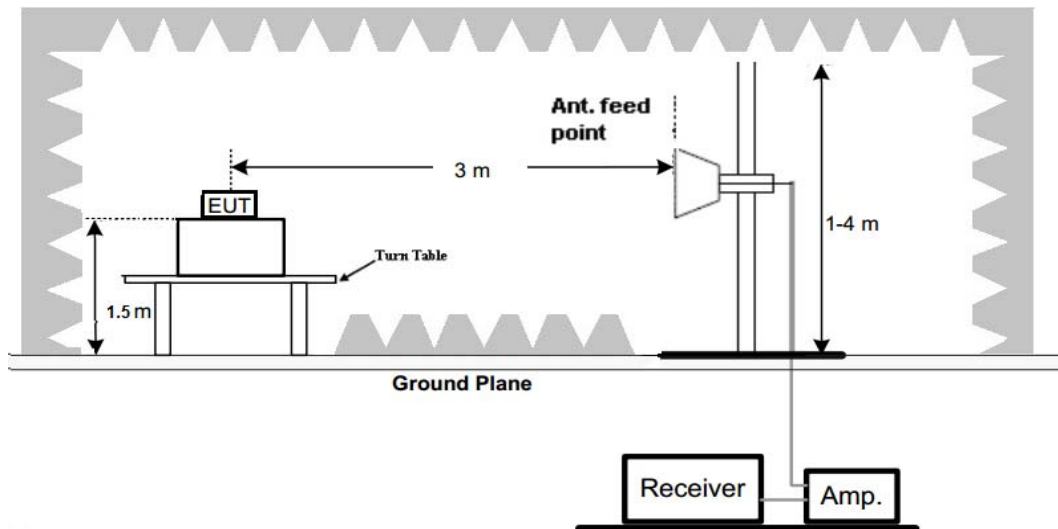

**Test Procedure**

1. Below 1GHz measurement the EUT is placed on a turntable which is 0.8m above ground plane, and above 1GHz measurement EUT was placed on a low permittivity and low loss tangent turn table which is 1.5m above ground plane.
2. Maximum procedure was performed by raising the receiving antenna from 1m to 4m and rotating the turn table from 0° to 360° to acquire the highest emissions from EUT
3. And also, each emission was to be maximized by changing the polarization of receiving antenna both horizontal and vertical.
4. Repeat above procedures until all frequency measurements have been completed.

**TEST RESULTS**

Remark:

1. We measured Radiated Emission at GFSK,  $\pi/4$  DQPSK and 8DPSK mode from 9 KHz to 25GHz and recorded worst case at  $\pi/4$  DQPSK 2DH5 mode.
2. For below 1GHz testing recorded worst at  $\pi/4$  DQPSK 2DH5 low channel.
3. Radiated emission test from 9 KHz to 10th harmonic of fundamental was verified, and no emission found except system noise floor in 9 KHz to 30MHz and not recorded in this report.

For 30MHz-1GHz

Horizontal

**SWEEP TABLE: "test (30M-1G)"**

Short Description:		Field Strength			
Start	Stop	Detector	Meas. Time	IF Bandw.	Transducer
30.0 MHz	1.0 GHz	MaxPeak	300.0 ms	120 kHz	JB1

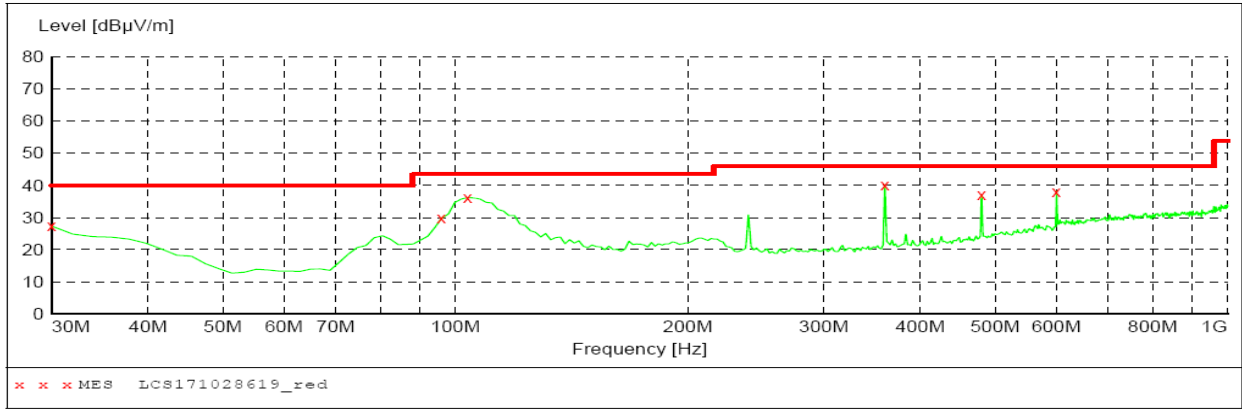

**MEASUREMENT RESULT: "LCS171028619\_red"**

10/28/2017 5:58PM

Frequency MHz	Level dBµV/m	Transd dB	Limit dBµV/m	Margin dB	Det.	Height cm	Azimuth deg	Polarization
30.000000	27.30	22.1	40.0	12.7	---	0.0	0.00	HORIZONTAL
95.960000	29.80	10.3	43.5	13.7	---	0.0	0.00	HORIZONTAL
103.720000	36.20	12.1	43.5	7.3	---	0.0	0.00	HORIZONTAL
359.800000	40.20	17.5	46.0	5.8	---	0.0	0.00	HORIZONTAL
480.080000	37.10	20.1	46.0	8.9	---	0.0	0.00	HORIZONTAL
600.360000	38.10	23.0	46.0	7.9	---	0.0	0.00	HORIZONTAL

Vertical

**SWEEP TABLE: "test (30M-1G)"**

Short Description:		Field Strength			
Start	Stop	Detector	Meas. Time	IF Bandw.	Transducer
30.0 MHz	1.0 GHz	MaxPeak	300.0 ms	120 kHz	JB1

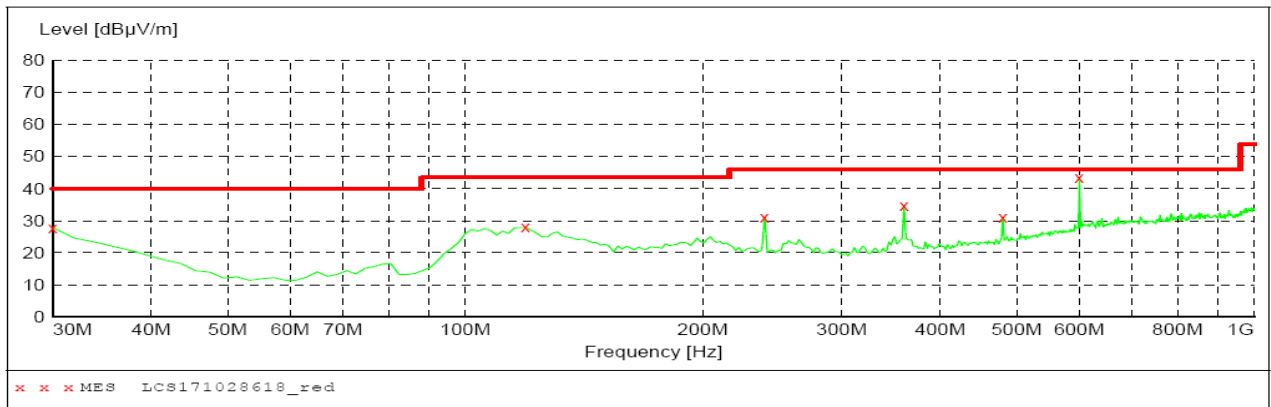

**MEASUREMENT RESULT: "LCS171028618\_red"**

10/28/2017 5:57PM

Frequency MHz	Level dBµV/m	Transd dB	Limit dBµV/m	Margin dB	Det.	Height cm	Azimuth deg	Polarization
30.000000	27.80	22.1	40.0	12.2	---	0.0	0.00	VERTICAL
119.240000	27.90	15.0	43.5	15.6	---	0.0	0.00	VERTICAL
239.520000	31.00	14.1	46.0	15.0	---	0.0	0.00	VERTICAL
359.800000	34.80	17.5	46.0	11.2	---	0.0	0.00	VERTICAL
480.080000	31.00	20.1	46.0	15.0	---	0.0	0.00	VERTICAL
600.360000	43.60	23.0	46.0	2.4	---	0.0	0.00	VERTICAL



**For 1GHz to 25GHz**

Note: GFSK,  $\pi/4$  DQPSK and 8DPSK all have been tested, only worse case  $\pi/4$  DQPSK is reported.

***Pi/4 DQPSK (above 1GHz)***

Frequency(MHz):			2402		Polarity:			HORIZONTAL	
Frequency (MHz)	Emission Level (dBuV/m)		Limit (dBuV/m)	Margin (dB)	Raw Value (dBuV)	Antenna Factor (dB/m)	Cable Factor (dB)	Pre-amplifier (dB)	Correction Factor (dB/m)
4804.00	55.52	PK	74	18.48	51.01	33.49	6.91	35.89	4.51
4804.00	46.63	AV	54	7.37	42.12	33.49	6.91	35.89	4.51
5080.21	45.75	PK	74	28.25	38.67	34.26	7.08	34.26	7.08
5080.21	--	AV	54	--	--	--	--	--	--
7206.00	47.02	PK	74	26.98	35.91	36.95	9.18	35.03	11.11
7206.00	--	AV	54	--	--	--	--	--	--

Frequency(MHz):			2402		Polarity:			VERTICAL	
Frequency (MHz)	Emission Level (dBuV/m)		Limit (dBuV/m)	Margin (dB)	Raw Value (dBuV)	Antenna Factor (dB/m)	Cable Factor (dB)	Pre-amplifier (dB)	Correction Factor (dB/m)
4804.00	54.10	PK	74	19.90	49.59	33.49	6.91	35.89	4.51
4804.00	45.37	AV	54	8.63	40.86	33.49	6.91	35.89	4.51
4992.46	45.91	PK	74	28.09	39.17	33.95	7.02	34.23	6.74
4992.46	--	AV	54	--	--	--	--	--	--
7206.00	45.18	PK	74	28.82	34.07	36.95	9.18	35.03	11.11
7206.00	--	AV	54	--	--	--	--	--	--

Frequency(MHz):			2441		Polarity:			HORIZONTAL	
Frequency (MHz)	Emission Level (dBuV/m)		Limit (dBuV/m)	Margin (dB)	Raw Value (dBuV)	Antenna Factor (dB/m)	Cable Factor (dB)	Pre-amplifier (dB)	Correction Factor (dB/m)
4882.00	56.32	PK	74	17.68	51.67	33.60	6.95	35.90	4.65
4882.00	47.40	AV	54	6.60	42.75	33.60	6.95	35.90	4.65
6912.15	44.71	PK	74	29.29	34.64	36.13	8.97	35.04	10.07
6912.15	--	AV	54	--	--	--	--	--	--
7323.00	47.69	PK	74	26.31	35.99	37.46	9.23	35.00	11.70
7323.00	--	AV	54	--	--	--	--	--	--

Frequency(MHz):			2441		Polarity:			VERTICAL	
Frequency (MHz)	Emission Level (dBuV/m)		Limit (dBuV/m)	Margin (dB)	Raw Value (dBuV)	Antenna Factor (dB/m)	Cable Factor (dB)	Pre-amplifier (dB)	Correction Factor (dB/m)
4882.00	54.64	PK	74	19.36	49.99	33.60	6.95	35.90	4.65
4882.00	46.12	AV	54	7.88	41.47	33.60	6.95	35.90	4.65
6231.48	43.96	PK	74	30.04	35.53	35.19	7.95	34.70	8.43
6231.48	--	AV	54	--	--	--	--	--	--

7323.00	45.81	PK	74	28.19	34.11	37.46	9.23	35.00	11.70
7323.00	--	AV	54	--	--	--	--	--	--

Frequency(MHz):			2480		Polarity:			HORIZONTAL	
Frequency (MHz)	Emission Level (dBuV/m)		Limit (dBuV/m)	Margin (dB)	Raw Value (dBuV)	Antenna Factor (dB/m)	Cable Factor (dB)	Pre-amplifier (dB)	Correction Factor (dB/m)
4960.00	55.93	PK	74	18.07	51.01	33.84	7.00	35.92	4.92
4960.00	46.76	AV	54	7.24	41.84	33.84	7.00	35.92	4.92
7019.68	46.28	PK	74	27.72	35.96	36.28	9.11	35.07	10.32
7019.68	--	AV	54	--	--	--	--	--	--
7440.00	46.40	PK	74	27.60	34.45	37.64	9.28	34.97	11.95
7440.00	--	AV	54	--	--	--	--	--	--

Frequency(MHz):			2480		Polarity:			VERTICAL	
Frequency (MHz)	Emission Level (dBuV/m)		Limit (dBuV/m)	Margin (dB)	Raw Value (dBuV)	Antenna Factor (dB/m)	Cable Factor (dB)	Pre-amplifier (dB)	Correction Factor (dB/m)
4960.00	54.47	PK	74	19.53	49.55	33.84	7.00	35.92	4.92
4960.00	45.45	AV	54	8.55	40.53	33.84	7.00	35.92	4.92
5854.79	47.04	PK	74	26.96	39.26	34.81	7.51	34.54	7.78
5854.79	--	AV	54	--	--	--	--	--	--
7440.00	45.52	PK	74	28.48	33.57	37.64	9.28	34.97	11.95
7440.00	--	AV	54	--	--	--	--	--	--

REMARKS:

1. Emission level (dBuV/m) =Raw Value (dBuV)+Correction Factor (dB/m)
2. Correction Factor (dB/m) = Antenna Factor (dB/m)+Cable Factor (dB)-Pre-amplifier Factor
3. Margin value = Limit value- Emission level.
4. -- Mean the PK detector measured value is below average limit.
5. The other emission levels were very low against the limit.
6. RBW1MHz VBW3MHz Peak detector is for PK value; RBW 1MHz VBW10Hz Peak detector is for AV value.

**Results of Band Edges Test (Radiated)**

Note: GFSK,  $\pi/4$  DQPSK and 8DPSK all have been tested, only worse case  $\pi/4$  DQPSK is reported.

Frequency(MHz):			2402		Polarity:			HORIZONTAL	
Frequency (MHz)	Emission Level (dBuV/m)		Limit (dBuV/m)	Margin (dB)	Raw Value (dBuV)	Antenna Factor (dB/m)	Cable Factor (dB)	Pre-amplifier (dB)	Correction Factor (dB/m)
2402.00	91.02	PK	--	--	57.62	28.78	4.61	0.00	33.40
2402.00	83.38	AV	--	--	49.98	28.78	4.61	0.00	33.40
2338.05	44.73	PK	74	29.27	11.79	28.40	4.54	0.00	32.94
2338.05	--	AV	54	--	--	--	--	--	--
2390.00	43.66	PK	74	30.34	10.34	28.72	4.60	0.00	33.32
2390.00	--	AV	54	--	--	--	--	--	--
2400.00	51.89	PK	74	22.11	18.50	28.78	4.61	0.00	33.39
2400.00	--	AV	54	--	--	--	--	--	--

Frequency(MHz):			2402		Polarity:			VERTICAL	
Frequency (MHz)	Emission Level (dBuV/m)		Limit (dBuV/m)	Margin (dB)	Raw Value (dBuV)	Antenna Factor (dB/m)	Cable Factor (dB)	Pre-amplifier (dB)	Correction Factor (dB/m)
2402.00	88.45	PK	--	--	55.05	28.78	4.61	0.00	33.40
2402.00	80.16	AV	--	--	46.76	28.78	4.61	0.00	33.40
2338.05	44.20	PK	74	29.80	11.26	28.40	4.54	0.00	32.94
2338.05	--	AV	54	--	--	--	--	--	--
2390.00	43.27	PK	74	30.73	9.95	28.72	4.60	0.00	33.32
2390.00	--	AV	54	--	--	--	--	--	--
2400.00	48.91	PK	74	25.09	15.52	28.78	4.61	0.00	33.39
2400.00	--	AV	54	--	--	--	--	--	--

Frequency(MHz):			2480		Polarity:			HORIZONTAL	
Frequency (MHz)	Emission Level (dBuV/m)		Limit (dBuV/m)	Margin (dB)	Raw Value (dBuV)	Antenna Factor (dB/m)	Cable Factor (dB)	Pre-amplifier (dB)	Correction Factor (dB/m)
2480.00	90.25	PK	--	23.75	56.63	28.92	4.70	0.00	33.62
2480.00	81.46	AV	--	12.54	47.84	28.92	4.70	0.00	33.62
2483.50	46.23	PK	74	27.77	12.60	28.93	4.70	0.00	33.63
2483.50	--	AV	54	--	--	--	--	--	--
2485.36	43.10	PK	74	30.90	9.46	28.93	4.70	0.00	33.64
2485.36	--	AV	54	--	--	--	--	--	--
2500.00	40.97	PK	74	33.03	7.29	28.96	4.72	0.00	33.68
2500.00	--	AV	54	--	--	--	--	--	--

Frequency(MHz):			2480		Polarity:			VERTICAL	
Frequency (MHz)	Emission Level (dBuV/m)		Limit (dBuV/m)	Margin (dB)	Raw Value (dBuV)	Antenna Factor (dB/m)	Cable Factor (dB)	Pre-amplifier (dB)	Correction Factor (dB/m)
2480.00	87.80	PK	--	26.20	54.18	28.92	4.70	0.00	33.62
2480.00	79.74	AV	--	14.26	46.12	28.92	4.70	0.00	33.62
2483.50	45.39	PK	74	28.61	11.76	28.93	4.70	0.00	33.63
2483.50	--	AV	54	--	--	--	--	--	--
2496.00	42.68	PK	74	31.32	9.01	28.95	4.72	0.00	33.67
2496.00	--	AV	54	--	--	--	--	--	--
2500.00	40.23	PK	74	33.77	6.55	28.96	4.72	0.00	33.68
2500.00	--	AV	54	--	--	--	--	--	--

REMARKS:

1. Emission level (dBuV/m) =Raw Value (dBuV)+Correction Factor (dB/m)
2. Correction Factor (dB/m) = Antenna Factor (dB/m)+Cable Factor (dB)-Pre-amplifier Factor
3. Margin value = Limit value- Emission level.
4. -- Mean the PK detector measured value is below average limit.
5. The other emission levels were very low against the limit.
6. RBW1MHz VBW3MHz Peak detector is for PK value; RBW 1MHz VBW10Hz Peak detector is for AV value.

### 3.3. Maximum Peak Output Power

**Limit**

The Maximum Peak Output Power Measurement is 125mW(20.97).

**Test Procedure**

Remove the antenna from the EUT and then connect a low loss RF cable from the antenna port to the spectrum.

**Test Configuration**

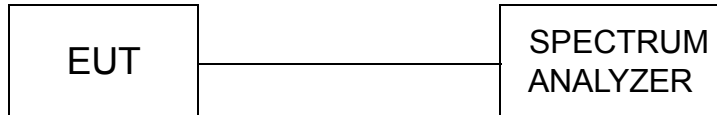

**Test Results**

Type	Channel	Output power (dBm)	Limit (dBm)	Result
GFSK	00	-4.363	20.97	Pass
	39	-3.928		
	78	-4.248		
π/4DQPSK	00	-2.843	20.97	Pass
	39	-2.865		
	78	-3.170		
8DPSK	00	-3.320	20.97	Pass
	39	-2.774		
	78	-3.097		

Note: 1.The test results including the cable lose.

Test plot as follows:

### GFSK Modulation

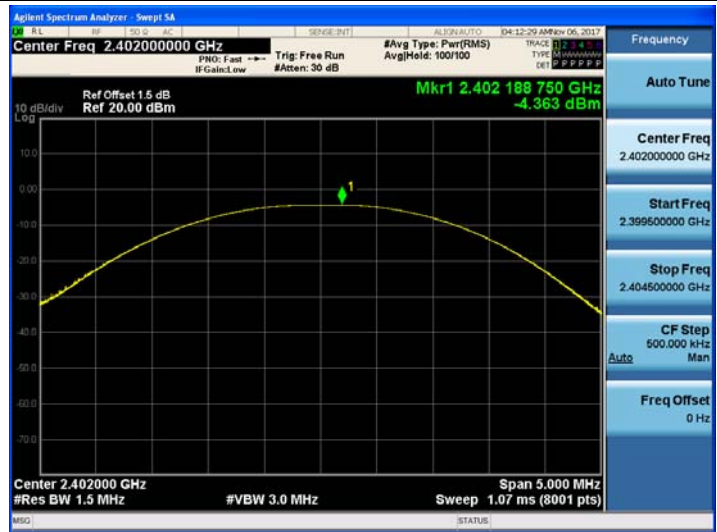

CH00

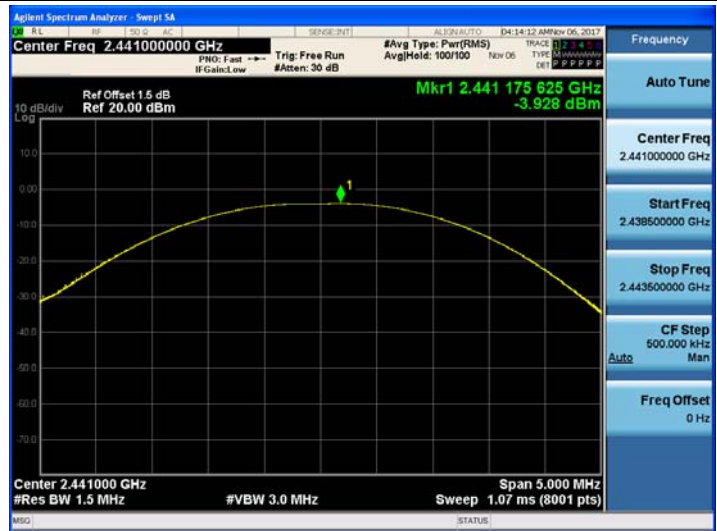

CH39

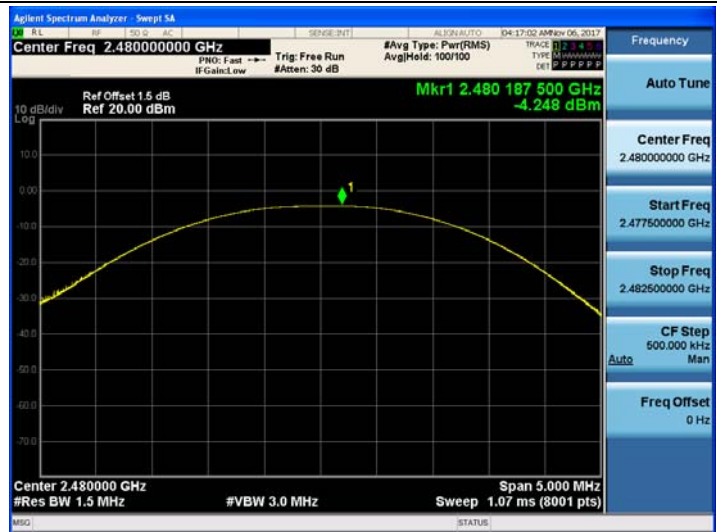

CH78

$\pi/4$ DQPSK Modulation

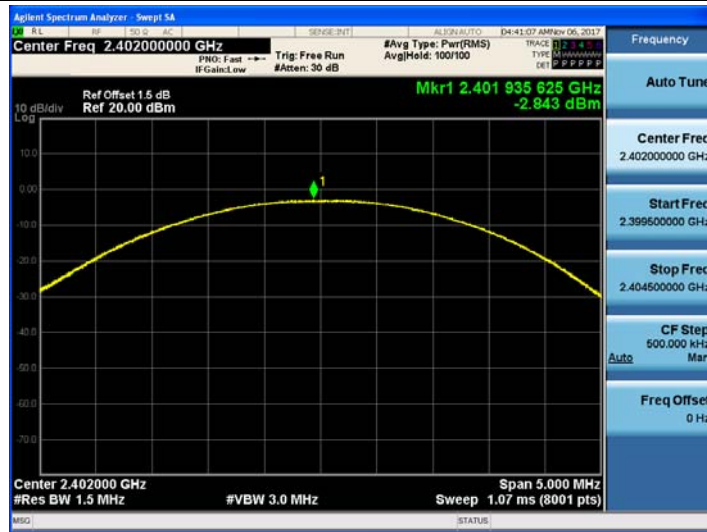

CH00

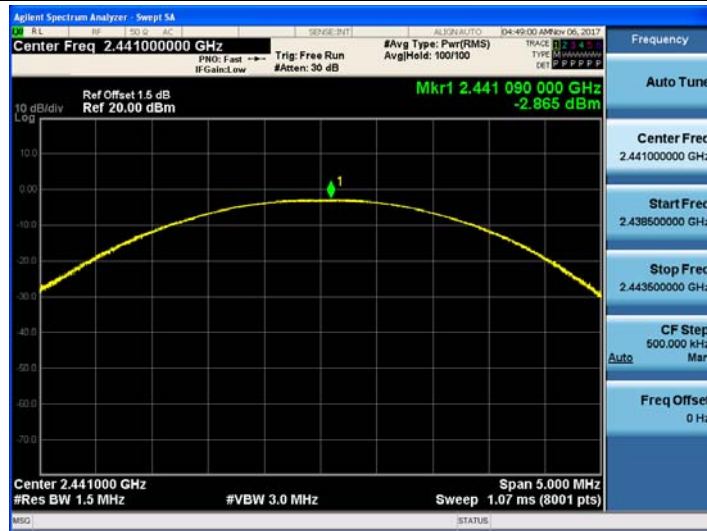

CH39

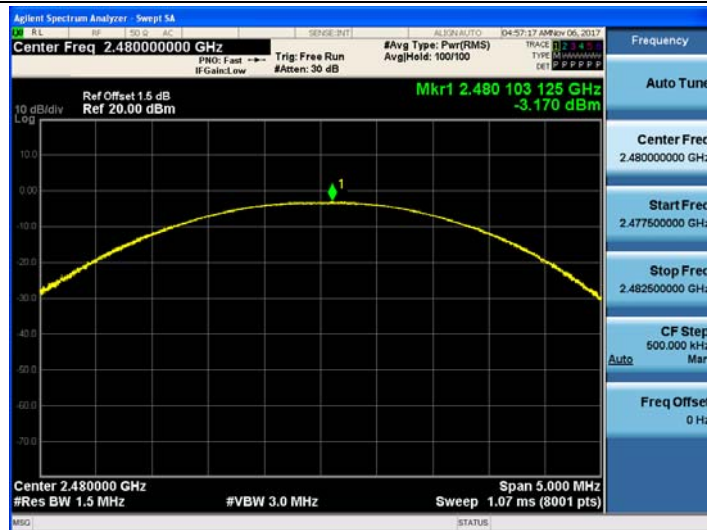

CH78

### 8DPSK Modulation

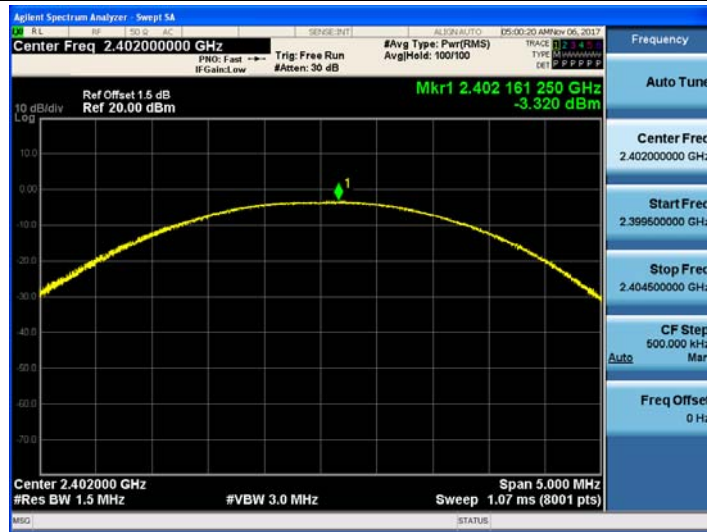

CH00

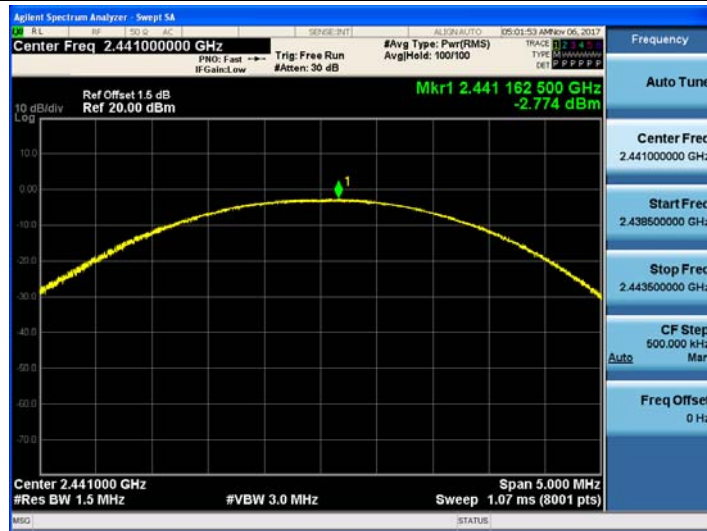

CH39

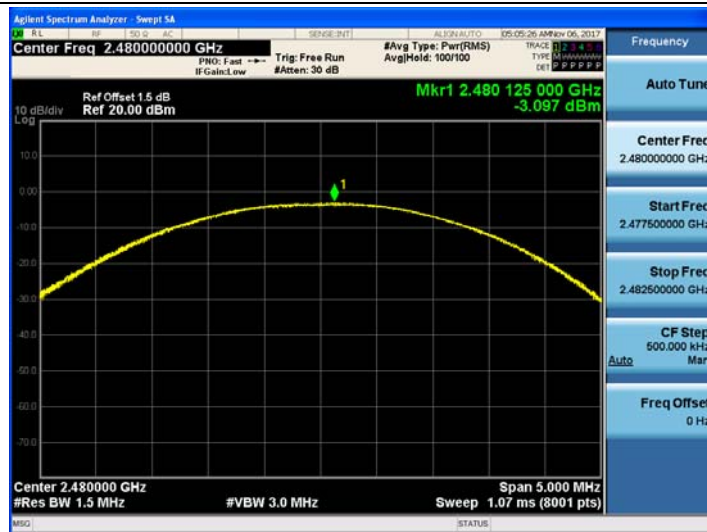

CH78



### 3.4. 20dB Bandwidth

**Limit**

For frequency hopping systems operating in the 2400MHz-2483.5MHz no limit for 20dB bandwidth.

**Test Procedure**

The transmitter output was connected to the spectrum analyzer through an attenuator. The bandwidth of the fundamental frequency was measured by spectrum analyzer with 30 KHz RBW and 100 KHz VBW.

The 20dB bandwidth is defined as the total spectrum the power of which is higher than peak power minus 20dB.

**Test Configuration**

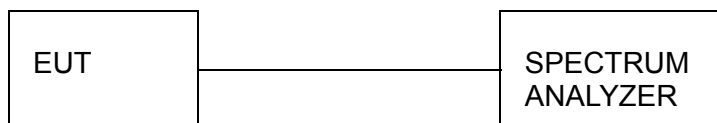

**Test Results**

Modulation	Channel	20dB bandwidth (MHz)	99% OBW (MHz)	Result
GFSK	CH00	0.9481	0.85990	Pass
	CH39	0.9479	0.85461	
	CH78	0.9543	0.85087	
π/4DQPSK	CH00	1.284	1.1732	
	CH39	1.282	1.1710	
	CH78	1.279	1.1736	
8DPSK	CH00	1.260	1.1629	
	CH39	1.259	1.1620	
	CH78	1.263	1.1614	

Test plot as follows:

GFSK Modulation

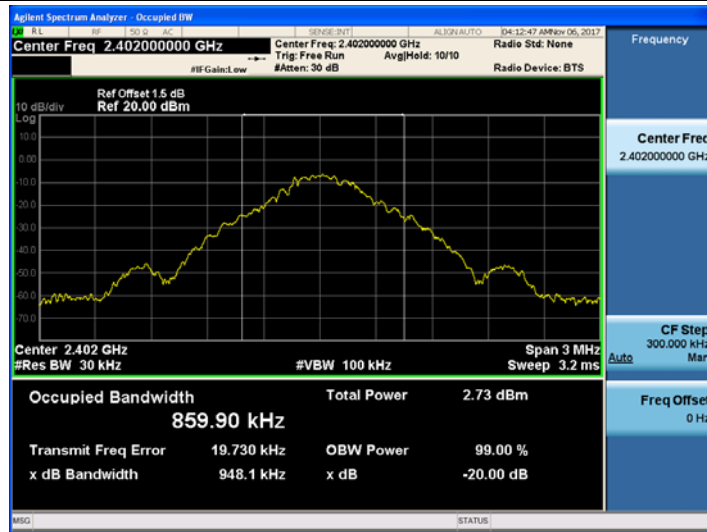

CH00

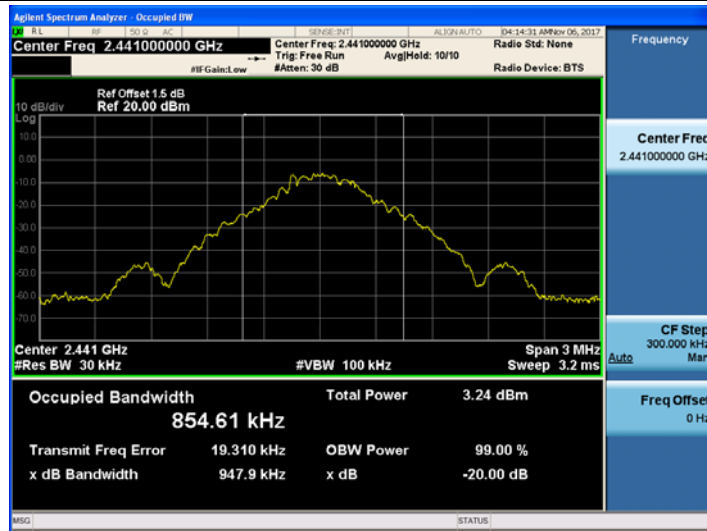

CH39

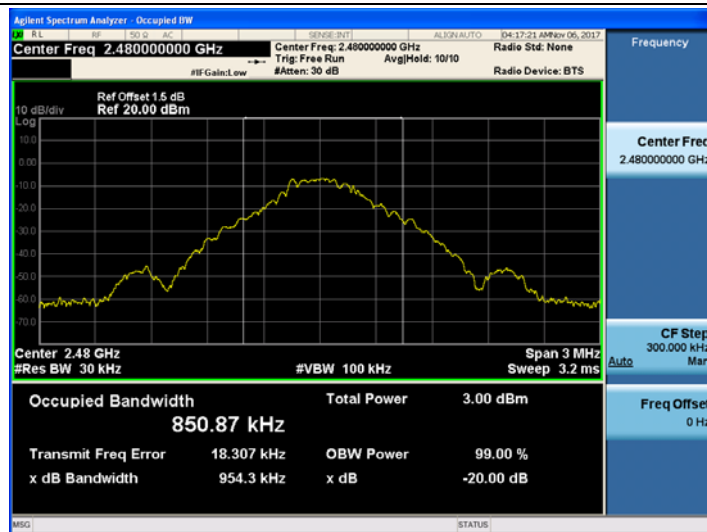

CH78

$\pi/4$ DQPSK Modulation

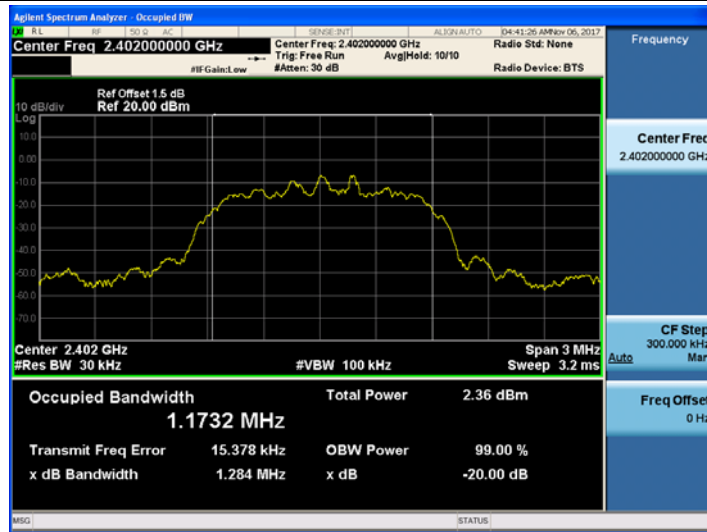

CH00

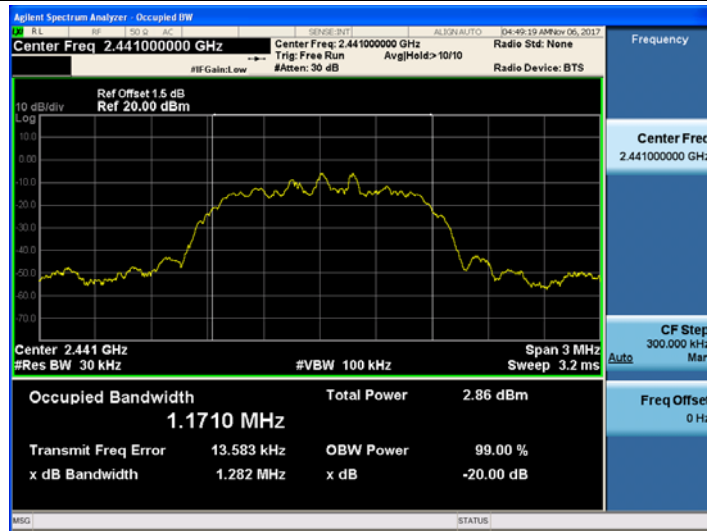

CH39

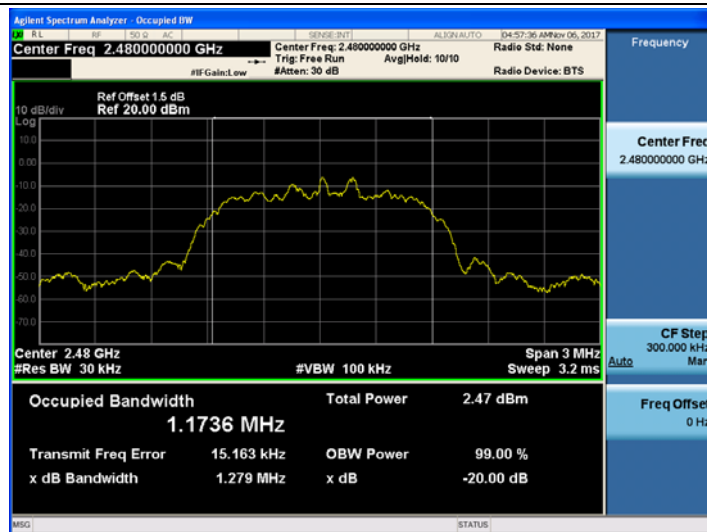

CH78

### 8DPSK Modulation

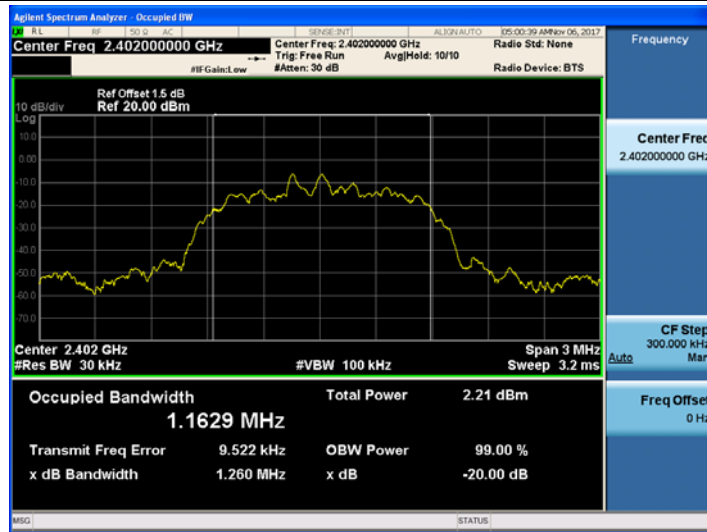

### CH00

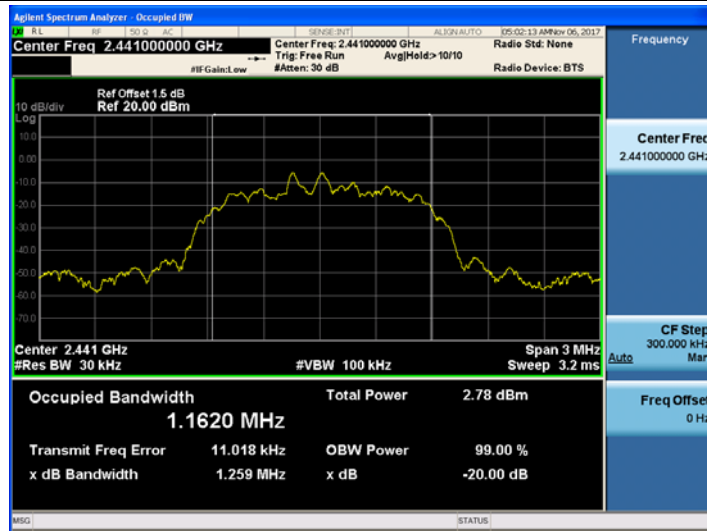

### CH39

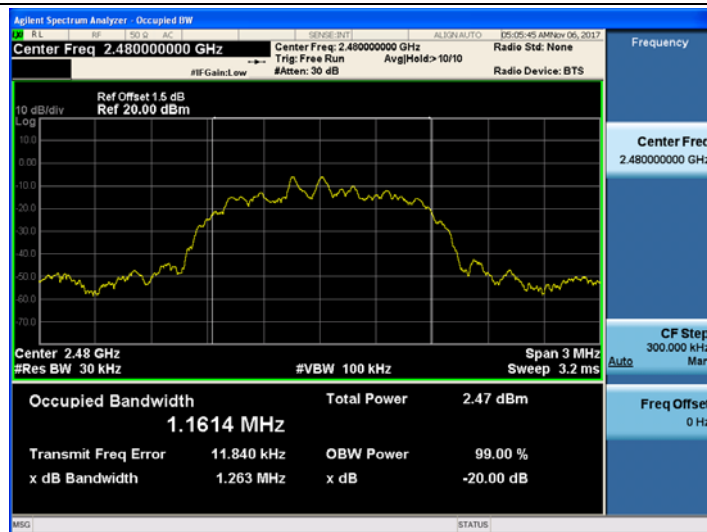

### CH78

### 3.5. Frequency Separation

#### LIMIT

According to 15.247(a)(1), frequency hopping systems shall have hopping channel carrier frequencies separated by minimum of 25KHz or the  $2/3 * 20\text{dB}$  bandwidth of the hopping channel, whichever is greater.

#### TEST PROCEDURE

The transmitter output was connected to the spectrum analyzer through an attenuator. The bandwidth of the fundamental frequency was measured by spectrum analyzer with 100 KHz RBW and 300 KHz VBW.

#### TEST CONFIGURATION

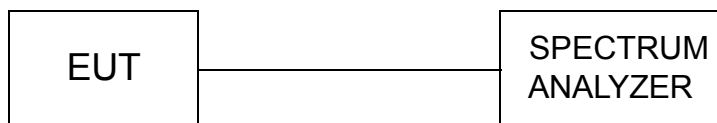

#### TEST RESULTS

Modulation	Channel	Channel Separation (MHz)	Limit(MHz)	Result
GFSK	CH39	1.039	0.632	Pass
	CH40			
$\pi/4$ DQPSK	CH39	1.153	0.856	Pass
	CH40			
8DPSK	CH39	0.844	0.842	Pass
	CH40			

Note:

We have tested all mode at high, middle and low channel, and recorded worst case at middle

Limit:  $2/3 * 20\text{dB}$  bandwidth

#### Test plot as follows:

### GFSK Modulation



### $\pi/4$ DQPSK Modulation



### 8DPSK Modulation



### 3.6. Number of hopping frequency

**Limit**

Frequency hopping systems in the 2400–2483.5 MHz band shall use at least 15 channels.

**Test Procedure**

The transmitter output was connected to the spectrum analyzer through an attenuator. Set spectrum analyzer start 2400MHz to 2483.5MHz with 100 KHz RBW and 300 KHz VBW.

**Test Configuration**

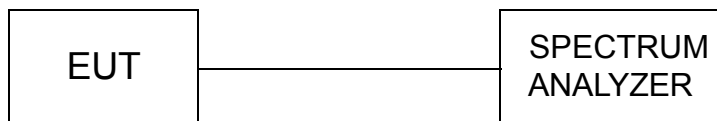

**Test Results**

Modulation	Number of Hopping Channel	Limit	Result
GFSK	79	≥15	Pass
π/4DQPSK	79		
8DPSK	79		

**Test plot as follows:**

### GFSK Modulation

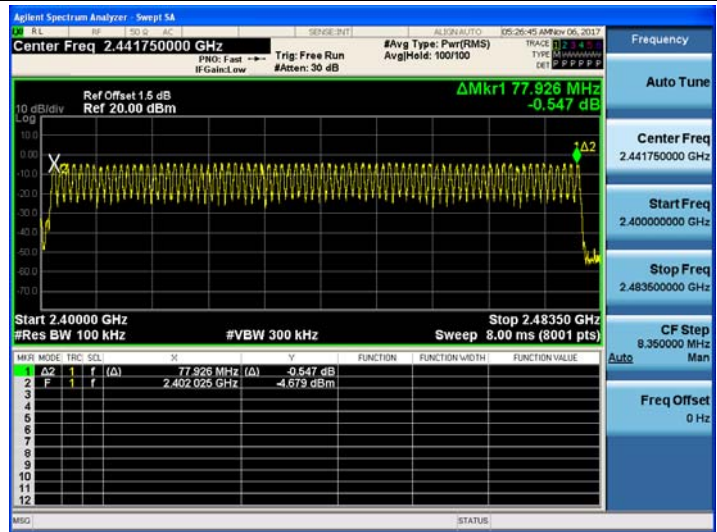

### $\pi/4$ DQPSK Modulation

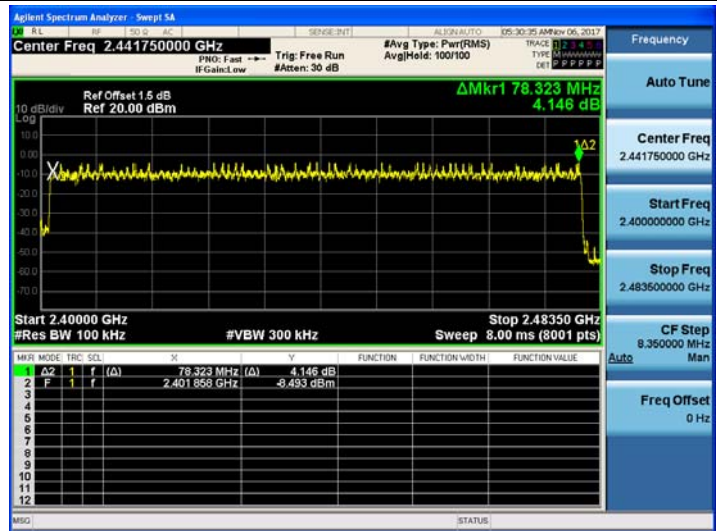

### 8DPSK Modulation

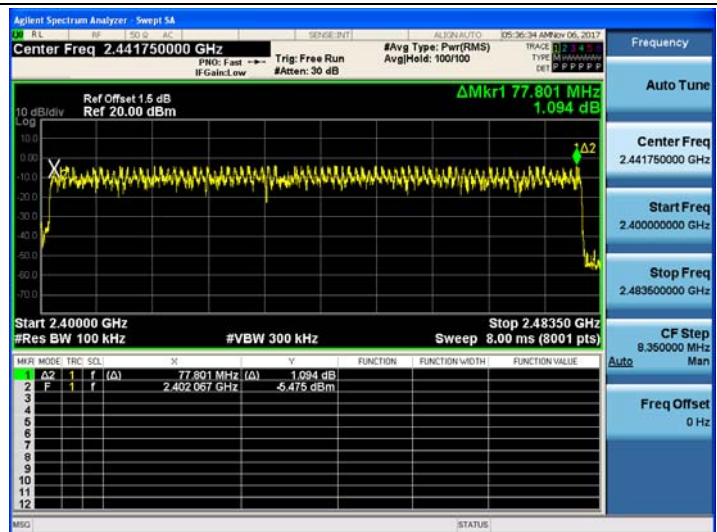



### 3.7. Time of Occupancy (Dwell Time)

#### Limit

The average time of occupancy on any channel shall not be greater than 0.4 seconds within a period of 0.4 seconds multiplied by the number of hopping channels employed.

#### Test Procedure

The transmitter output was connected to the spectrum analyzer through an attenuator. Set center frequency of spectrum analyzer=operating frequency with 1MHz RBW and 1MHz VBW, Span 0Hz.

#### Test Configuration

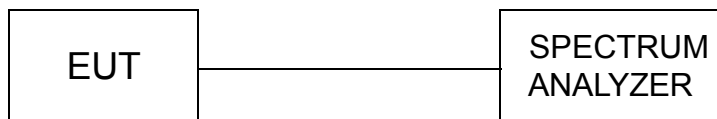

#### Test Results

Modulation	Packet	Pulse time (ms)	Dwell time (s)	Limit (s)	Result
GFSK	DH1	0.381	0.122	0.40	Pass
	DH3	1.636	0.262		
	DH5	2.884	0.308		
π/4DQPSK	2-DH1	0.388	0.124	0.40	Pass
	2-DH3	1.641	0.263		
	2-DH5	2.889	0.308		
8DPSK	3-DH1	0.389	0.124	0.40	Pass
	3-DH3	1.641	0.263		
	3-DH5	2.886	0.308		

Note:

- We have tested all mode at high,middle and low channel,and recoreded worst case at middle channel.
- $Dwell\ time = Pulse\ time\ (ms) \times (1600 \div 2 \div 79) \times 31.6\ Second$  for DH1, 2-DH1, 3-DH1  
 $Dwell\ time = Pulse\ time\ (ms) \times (1600 \div 4 \div 79) \times 31.6\ Second$  for DH3, 2-DH3, 3-DH3  
 $Dwell\ time = Pulse\ time\ (ms) \times (1600 \div 6 \div 79) \times 31.6\ Second$  for DH5, 2-DH5, 3-DH5

#### Test plot as follows:

GFSK Modulation

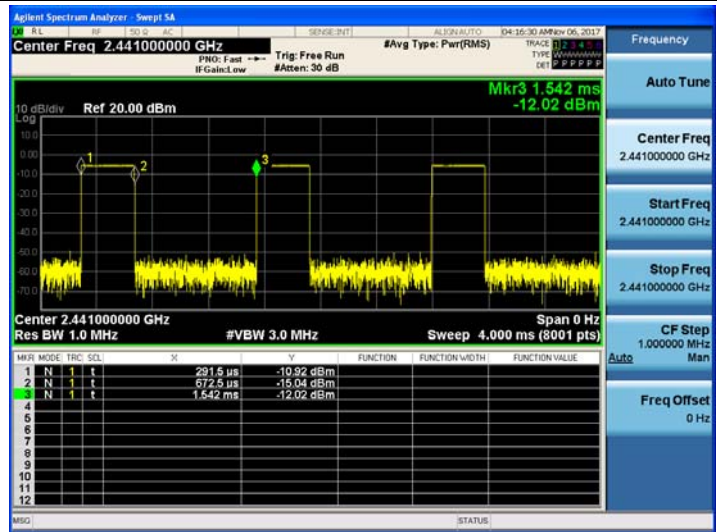

DH1

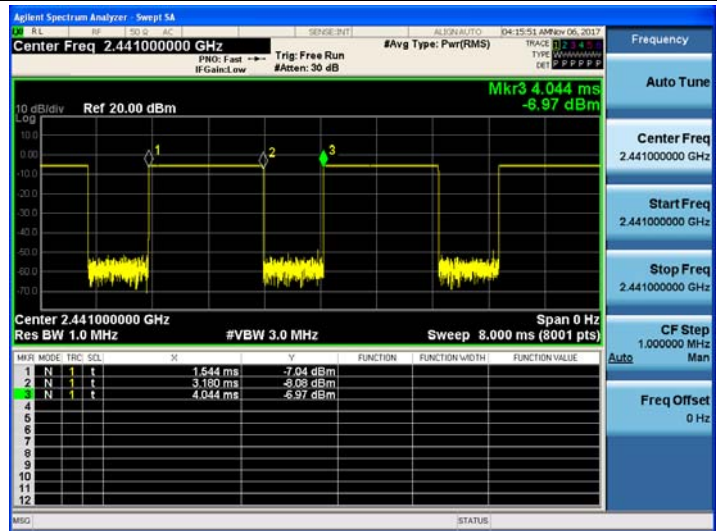

DH3

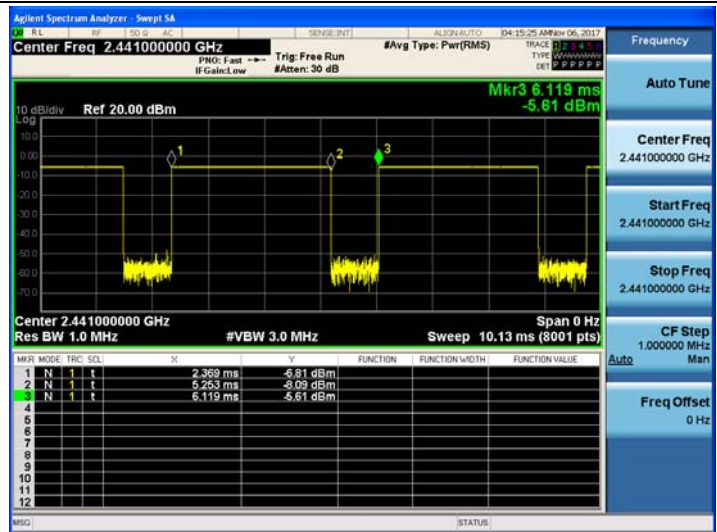

DH5

$\pi/4$ DQPSK Modulation

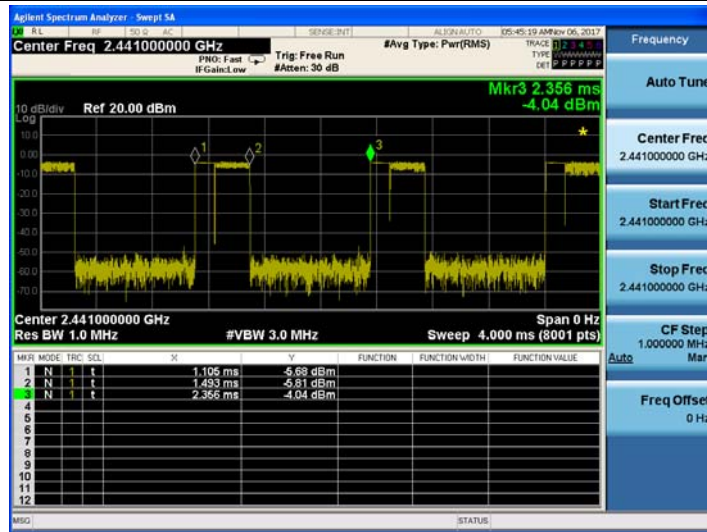

2-DH1

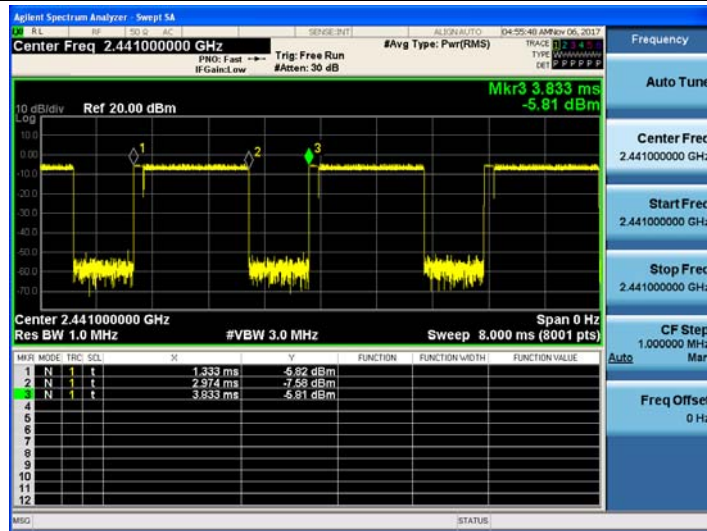

2-DH3

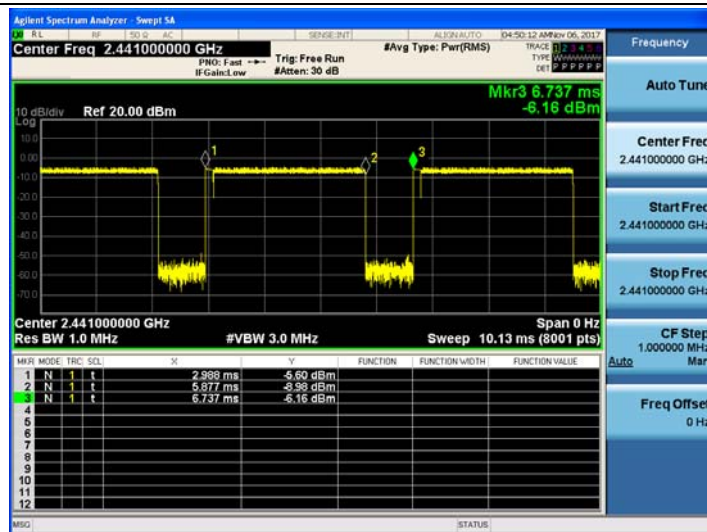

2-DH5

### 8DPSK Modulation

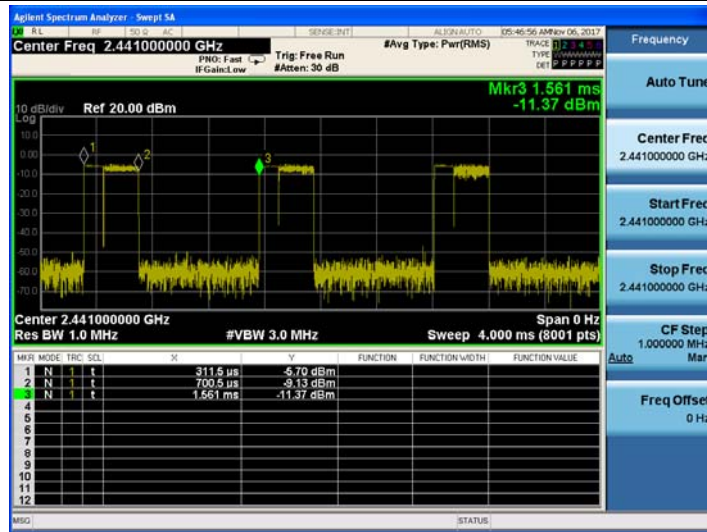

### 3-DH1

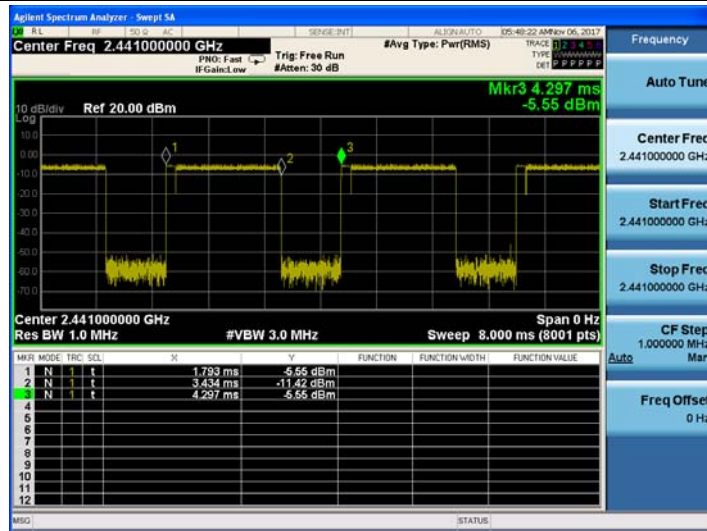

### 3-DH3

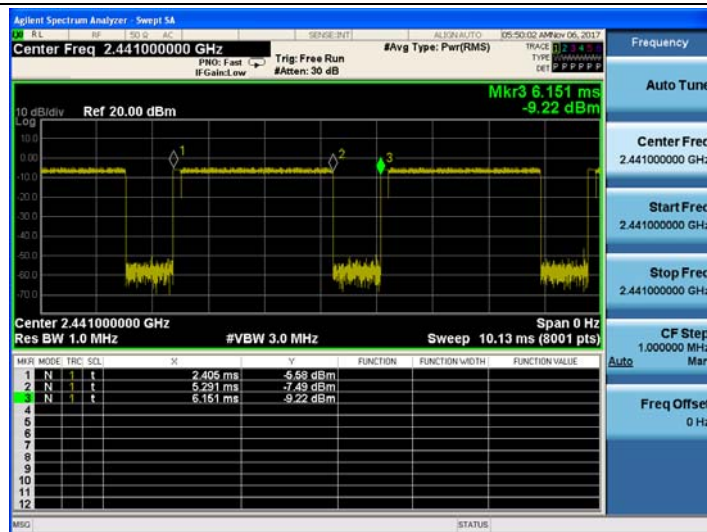

### 3-DH5

### 3.8. Out-of-band Emissions

**Limit**

In any 100 kHz bandwidth outside the frequency band in which the spread spectrum or digitally modulated intentional radiator is operating, the radio frequency power that is produced by the intentional radiator shall be at least 20 dB below that in the 100 kHz bandwidth within the band that contains the highest level of the desired power, based on either an RF conducted or a radiated measurement, provided the transmitter demonstrates compliance with the peak conducted power limits. If the transmitter complies with the conducted power limits based on the use of RMS averaging over a time interval, as permitted under paragraph (b)(3) of this section, the attenuation required under this paragraph shall be 30 dB instead of 20 dB. Attenuation below the general limits specified in §15.209(a) is not required.

**Test Procedure**

Connect the transmitter output to spectrum analyzer using a low loss RF cable, and set the spectrum analyzer to RBW=100 kHz, VBW= 300 kHz, peak detector , and max hold. Measurements utilizing these setting are made of the in-band reference level, bandedge and out-of-band emissions.

**Test Configuration**



**Test Results**

Remark: The measurement frequency range is from 30MHz to the 10th harmonic of the fundamental frequency. The lowest, middle and highest channels are tested to verify the spurious emissions and bandage measurement data.

We measured all conditions (DH1, DH3, DH5) and recorded worst case at DH5

Test plot as follows:

**GFSK CH00**



**GFSK CH39**



**Reference**

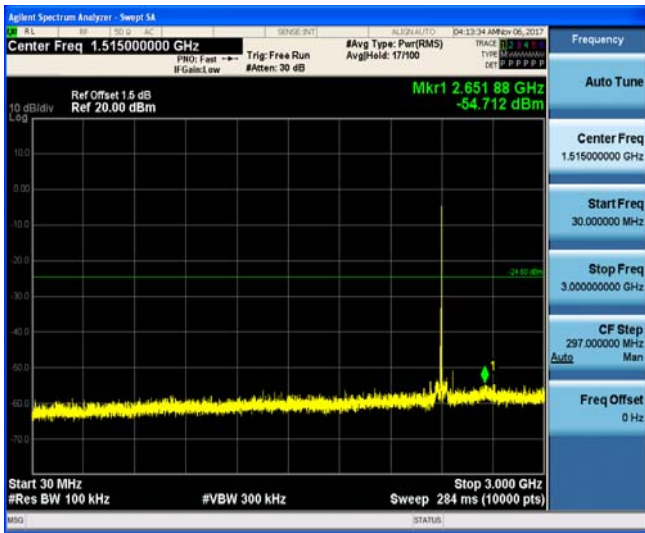

**Reference**

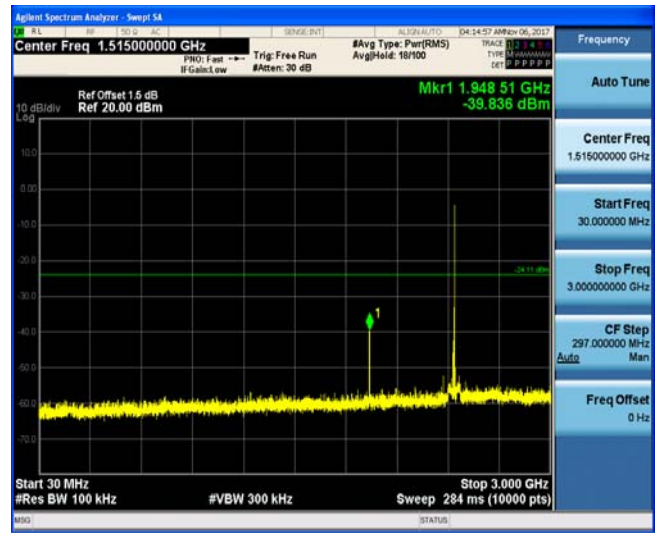

**30MHz-3GHz**

**30MHz-3GHz**



**3GHz-25GHz**

**3GHz-25GHz**

**GFSK CH78**



**$\pi$ /4DQPSK CH00**



**Reference**

**Reference**

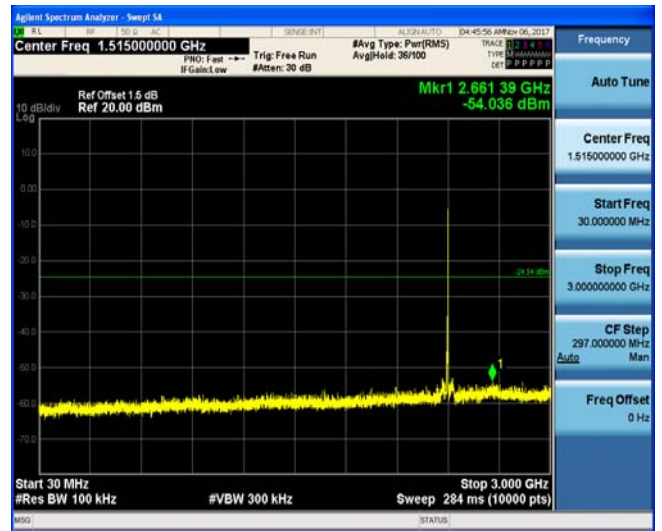
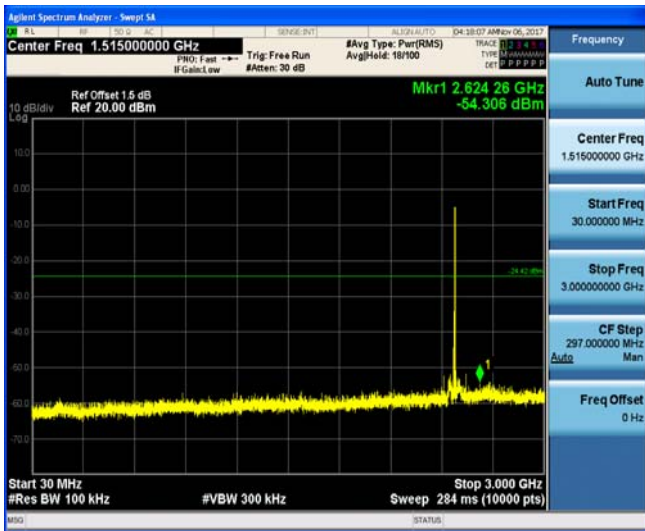

**30MHz-3GHz**

**30MHz-3GHz**

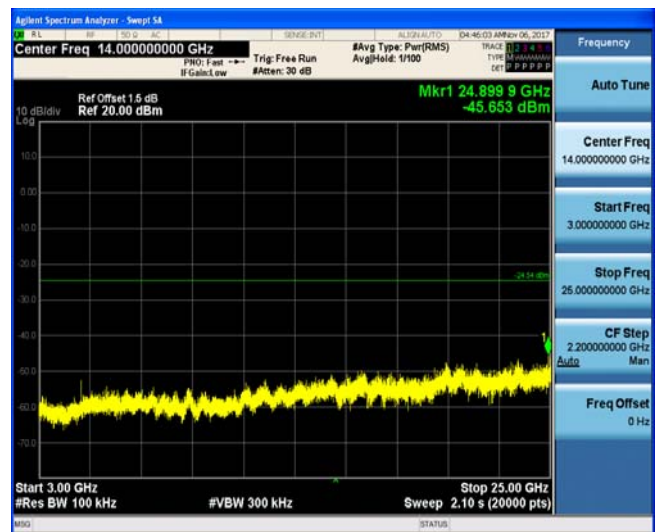

**3GHz-25GHz**

**3GHz-25GHz**

$\pi/4$ DQPSK CH39



$\pi/4$ DQPSK CH78



Reference

Reference

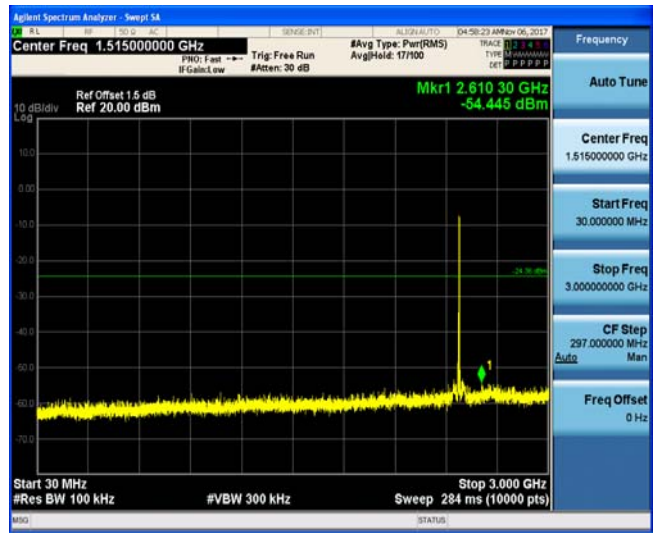
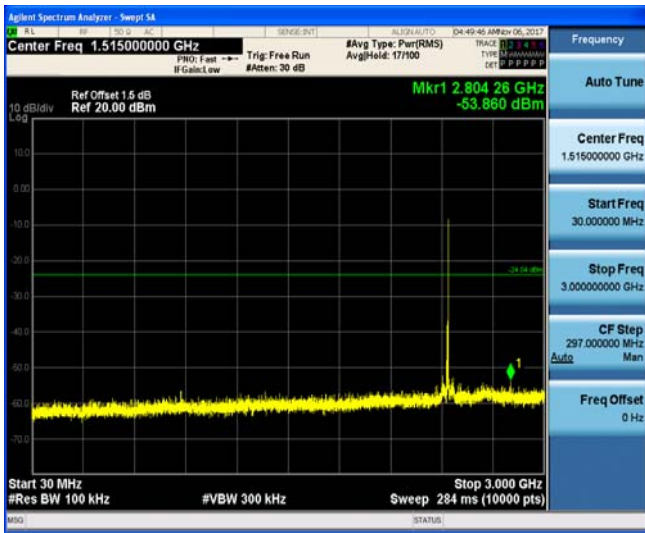

30MHz-3GHz

30MHz-3GHz



3GHz-25GHz

3GHz-25GHz



8DPSK CH00



8DPSK CH39



Reference

Reference

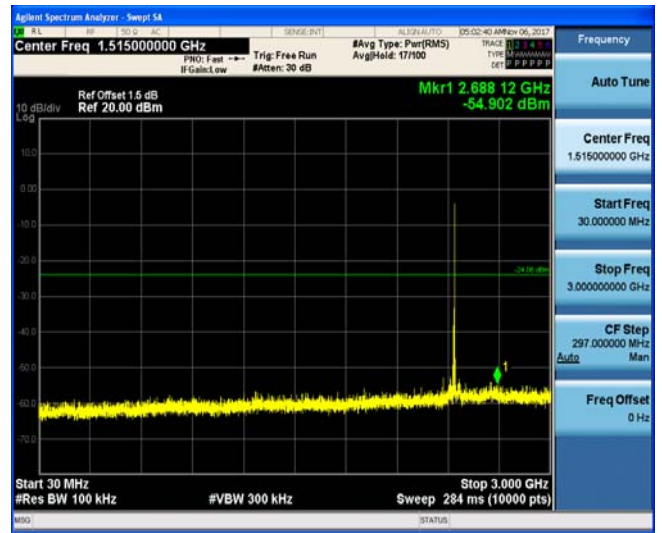
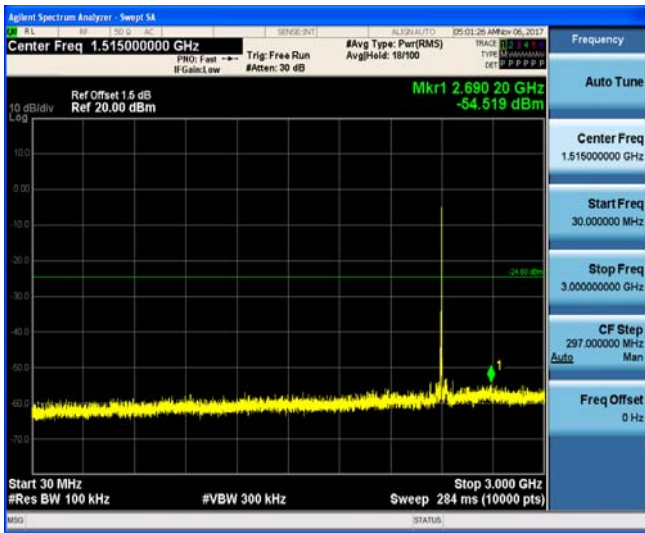

30MHz-3GHz

30MHz-3GHz

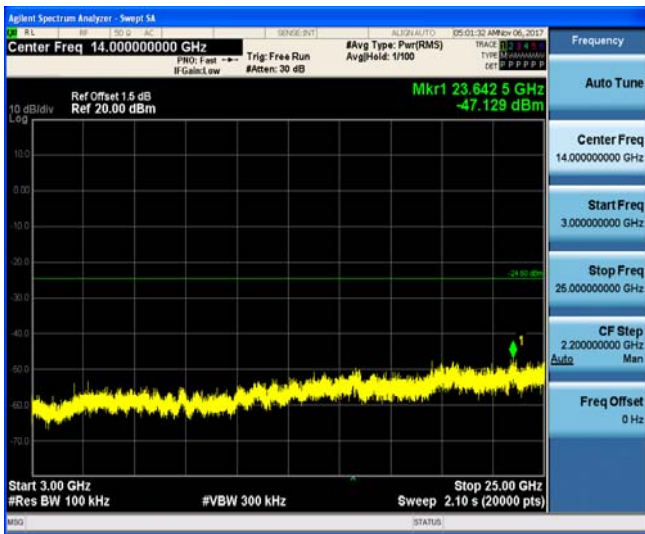

3GHz-25GHz

3GHz-25GHz

8DPSK CH78



Reference

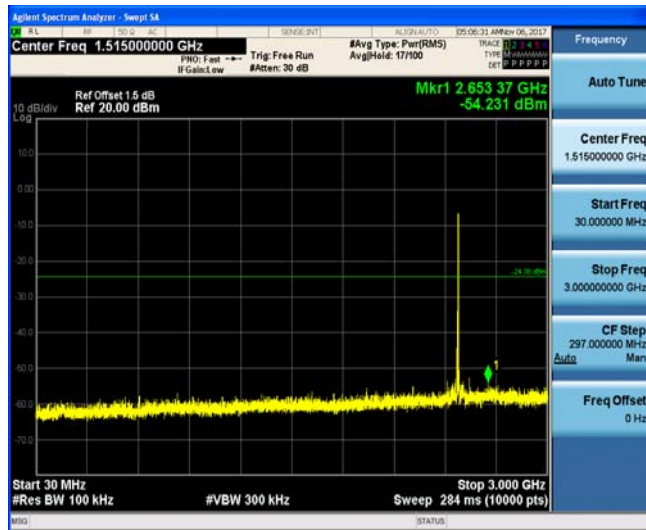

30MHz-3GHz



3GHz-25GHz

**Band-edge Measurements for RF Conducted Emissions:**

**GFSK**



Left Band edge hopping off



Right Band edge hopping off



Left Band edge hopping on

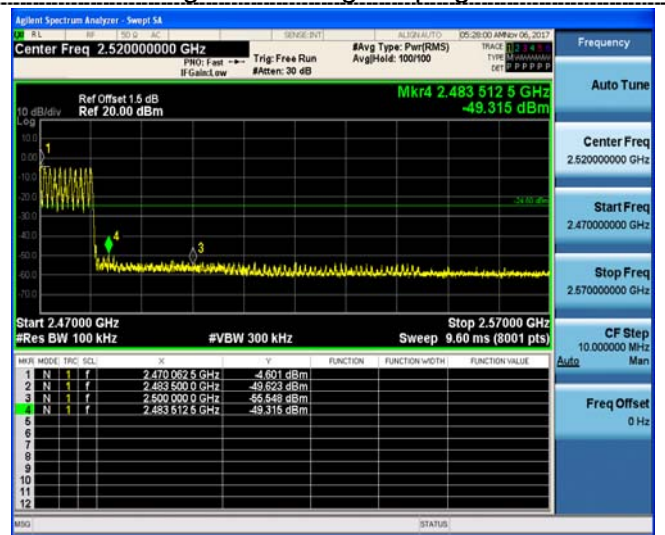

Right Band edge hopping on

**$\pi$ /4DQPSK**



Left Band edge hopping off

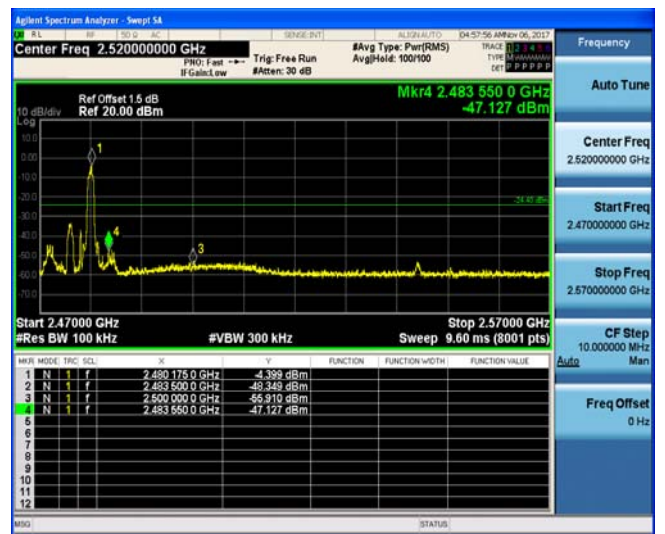

Right Band edge hopping off



Left Band edge hopping on



Right Band edge hopping on

8DPSK



Left Band edge hopping off

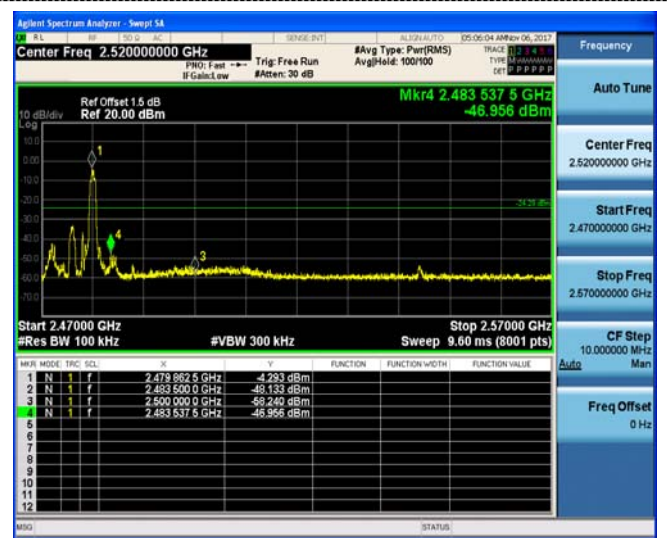

Right Band edge hopping off



Left Band edge hopping on

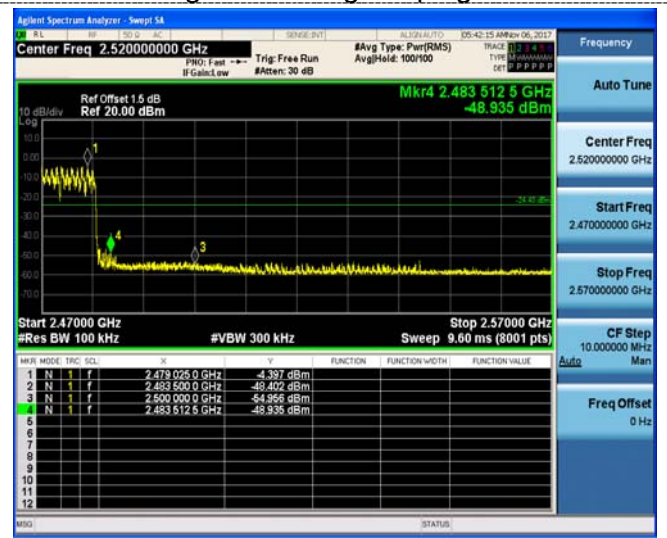

Right Band edge hopping on

### 3.9. Pseudorandom Frequency Hopping Sequence

#### TEST APPLICABLE

**For 47 CFR Part 15C section 15.247 (a) (1) requirement:**

Frequency hopping systems shall have hopping channel carrier frequencies separated by a minimum of 25 kHz or the 20 dB bandwidth of the hop-ping channel, whichever is greater. Alternatively, frequency hopping systems operating in the 2400–2483.5 MHz band may have hopping channel carrier frequencies that are separated by 25 kHz or two-thirds of the 20 dB bandwidth of the hopping channel, whichever is greater, provided the systems operate with an output power no greater than 125 mW. The system shall hop to channel frequencies that are selected at the system hopping rate from a pseudo randomly ordered list of hopping frequencies. Each frequency must be used equally on the average by each transmitter. The system receivers shall have input bandwidths that match the hop-ping channel bandwidths of their corresponding transmitters and shall shift frequencies in synchronization with the transmitted signals.

#### EUT Pseudorandom Frequency Hopping Sequence Requirement

The pseudorandom frequency hopping sequence may be generated in a nine-stage shift register whose 5<sup>th</sup> and 9<sup>th</sup> stage outputs are added in a modulo-two addition stage. And the result is fed back to the input of the first stage. The sequence begins with the first one of 9 consecutive ones, for example: the shift register is initialized with nine ones.

- Number of shift register stages:9
- Length of pseudo-random sequence:29-1=511 bits
- Longest sequence of zeros:8(non-inverted signal)

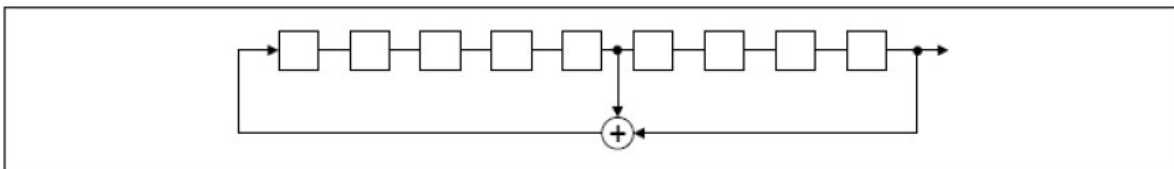

*Linear Feedback Shift Register for Generation of the PRBS sequence*

An example of pseudorandom frequency hopping sequence as follows:

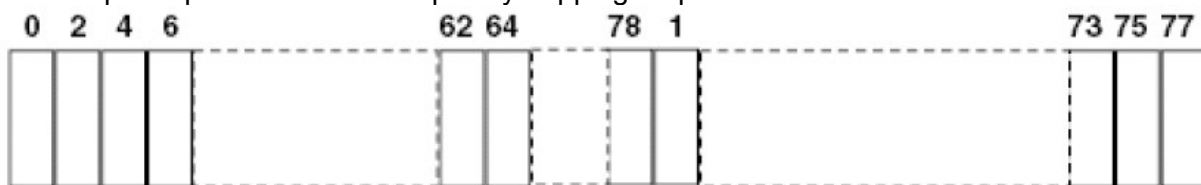

Each frequency used equally one the average by each transmitter.

The system receiver have input bandwidths that match the hopping channel bandwidths of their corresponding transmitter and shift frequencies in synchronization with the transmitted signals.

### 3.10. Antenna Requirement

#### Standard Applicable

For intentional device, according to FCC 47 CFR Section 15.203, an intentional radiator shall be designed to ensure that no antenna other than that furnished by the responsible party shall be used with the device.

And according to FCC 47 CFR Section 15.247 (c), if transmitting antennas of directional gain greater than 6dBi are used, the power shall be reduced by the amount in dB that the directional gain of the antenna exceeds 6dBi.

#### **Refer to statement below for compliance**

The manufacturer may design the unit so that the user can replace a broken antenna, but the use of a standard antenna jack or electrical connector is prohibited. Further, this requirement does not apply to intentional radiators that must be professionally installed.

#### Antenna Connected Construction

The maximum gain of antenna was 0dBi.

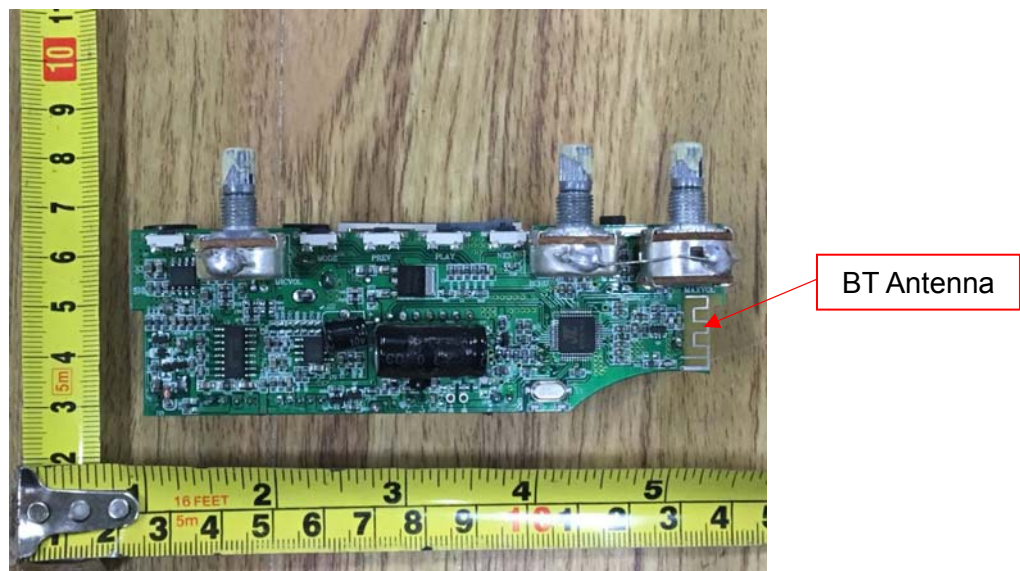

#### 4. Test Setup Photos of the EUT



## 5. Photos of the EUT

### External Photos of EUT









**Internal Photos of EUT**





FM antenna



BT antenna

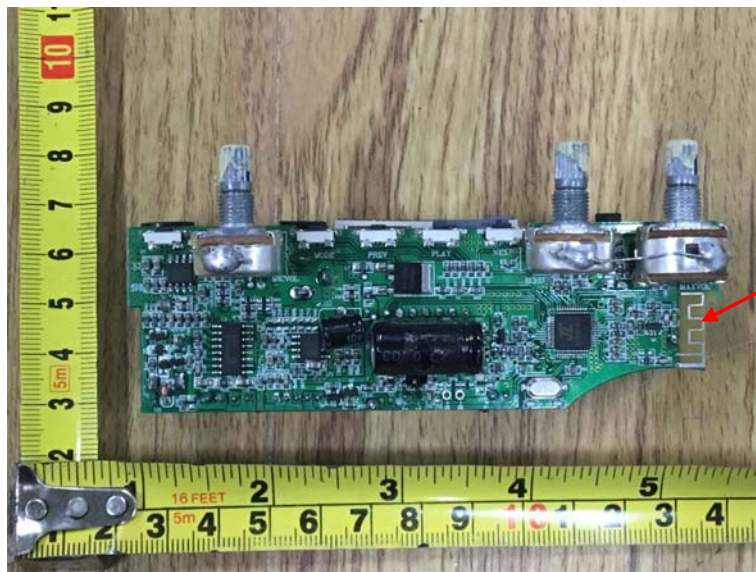

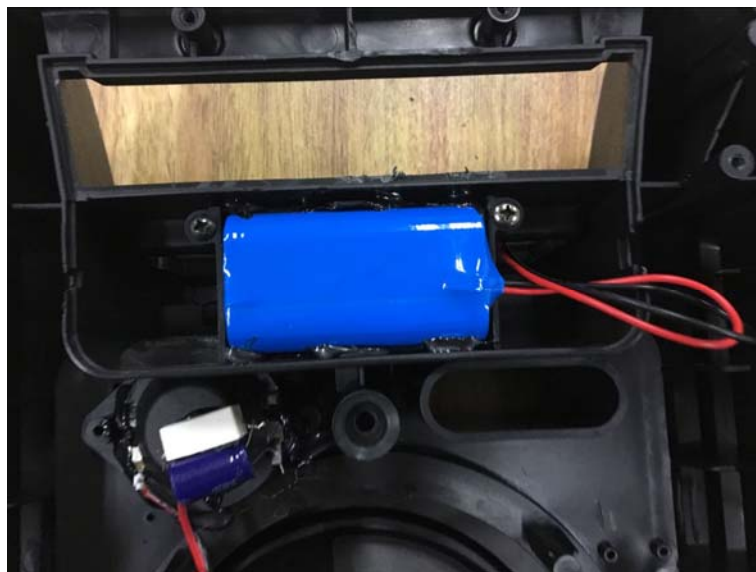

\*\*\*\*\* End of Report \*\*\*\*\*