

# ASSEMBLY AND INSTALLATION INSTRUCTIONS

T0620 / T0621  
VX21111W / VX21111BZ

**WARNING:** TO AVOID RISK OF ELECTRICAL SHOCK, BE SURE TO SHUT OFF POWER BEFORE INSTALLING OR SERVICING THIS FIXTURE.

NOTES: 1. Before installing, consult local electrical codes for wiring and grounding requirements.  
2. READ AND SAVE THESE INSTRUCTIONS.

## Hardware Package (included):

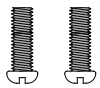

Mounting Screw X2  
#8/32 X 1/2 in



Mounting Screw X2  
#6/32 X 1/2 in

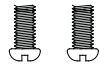

Mounting Screw X2  
#10/24 X 1/4 in

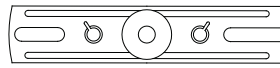

Mounting Strap



Decorative cover



Fixture Mounting Screw

## Important to Know:

1. If you are not familiar with state and local electrical codes, it is recommended that you consult with a qualified electrician.
2. This fixture requires a 120 VAC, 60 Hz power source.
3. For general safety and to avoid any possible damage to the sensor, be sure the power is switched "off" before adjustment.

**Maximum Wattage: 35 W**

**Working Temperature Range: -13°F ~ 113°F**

## Features:

1. Energy saving LED fixture.
2. Motion sensor: turns light ON automatically when motion is detected and turns light OFF automatically when motion stops.
3. Photocell keeps the light OFF during daylight hours.
4. When in manual override mode, use wall switch to change the function and perform the function conversion.

**Note: Fixture can be wall mounted or eave mounted.**



Read notes section on page.4 for additional information about mounting location of fixture.

Light fixture and sensor should be mounted as shown above when installed (depending upon type of installation)

Before installing the light fixture under an eave, the sensor head must be rotated as shown in the next two steps for proper operation and to avoid the risk of electrical shock.

For eave mounted only:

- ⦿ Swing the sensor head towards the mounting bracket.
- ⦿ Rotate the sensor head clockwise 180° so the controls face down.

The diagram illustrates the rotation of the sensor head. It starts with the sensor head in its default position, where the controls are on the side. An arrow indicates swinging the head towards the mounting bracket. A second arrow indicates rotating the head clockwise 180 degrees so that the controls are now facing downwards.

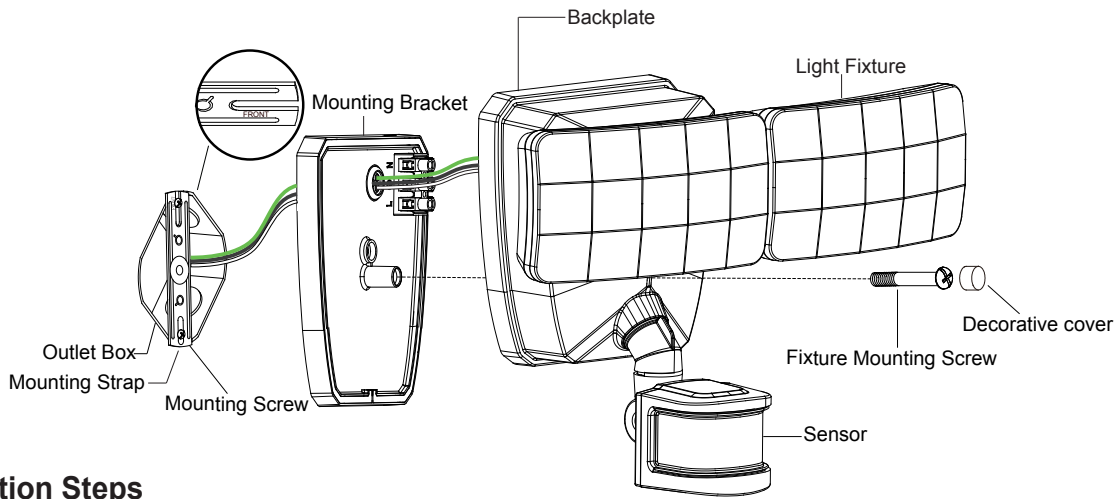

## Installation Steps

Turn off the power at fuse or circuit box.

1. The fixture mounting bracket is pre-assembled on the light fixture. Unscrew both the decorative cover and the fixture mounting screw in order to remove the mounting bracket.
2. Install the mounting strap to the outlet box with the stamped word "FRONT" facing away from the outlet box, using two mounting screws that best fit the outlet box. Mounting bracket should sit flush against wall surface when secured. (Choose one matching pair of suitable mounting screws from the 3 pairs provided).
3. Pull out the source wires from the outlet box. Connect the black wire from the outlet box to the "L" interface of the terminal station on the mounting bracket. Connect the white wire from the outlet box to the "N" interface of the terminal station on the mounting bracket. Carefully tuck the wires back into the outlet box.
4. Place mounting bracket against the outlet box, insert the mounting bracket screw through the mounting bracket hole, thread mounting bracket screw into the center hole of the mounting strap. Tighten the mounting bracket screw securely.
5. Attach the backplate of the light fixture to the mounting fixture mounting screw. Then push the decorative cover firmly into the fixture mounting screw hole on the light fixture.
6. With silicone caulking compound, caulk completely around where the back plate meets the wall surface.  
**CAUTION: Be sure to caulk completely where the back plate meets the wall surface to prevent water from seeping into the outlet box.**

Turn on the power at the main fuse or circuit breaker box.

### Adjusting the Sensor Head:

1. Aim sensor head toward desired detection area, maintaining a 5° - 40° downward angle to allow moisture to drain.  
 Note: Make sure sensor head is positioned with control knob facing towards the ground.
2. You can rotate the sensor head up and down to change the coverage area. (See Fig. 1)  
**Note: Range set too high may increase false triggering.**  
 (See Fig. 2 and Fig. 3)

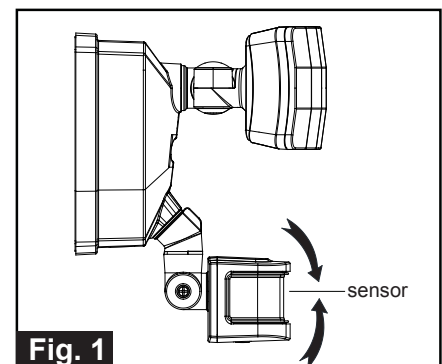
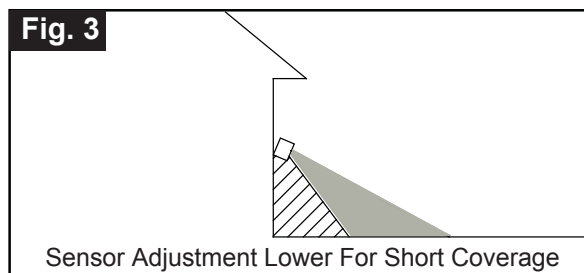
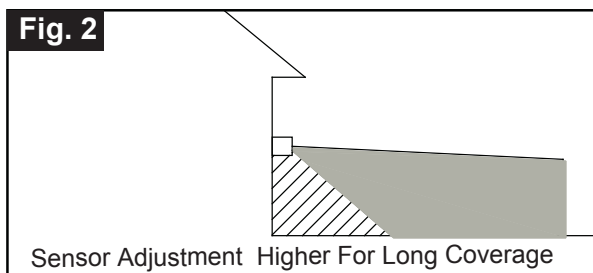
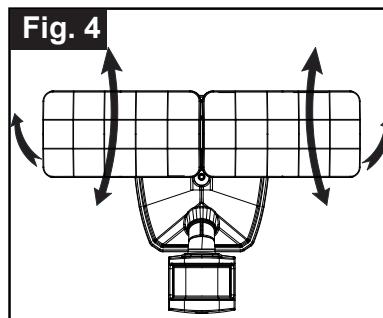

Fig. 1



### Adjusting the Light Head:

1. Gently grasp the light heads and tilt them up or down, left or right to adjust the light coverage area. Keep the light heads at least 1" (25mm) away from the sensor. (See Fig. 4)
2. Keep the light heads 30° below horizontal to avoid water damage and electrical shock.



### Sensitivity of Motion Sensor:

1. You can adjust the sensitivity of the motion sensor by using the "Sens" selector located on the bottom surface of the sensor.
2. Adjust motion sensor sensitivity to HIGH (H), MEDIUM (M), or LOW (L) to achieve desired performance.
3. Approximate range for each setting: 30 ft. (L), 50 ft. (M), 70 ft. (H).

Choose a mode by sliding the switch on the bottom of the sensor. (See Fig.5)

**Note: When power is first applied, the light will turn on to 100% brightness.**

**The sensor will take 30 seconds to warm up.**

1. TEST MODE (daytime and nighttime operation.)
  - Slide the Time switch the "Test" position.
  - The light turns to high-level brightness (5000K) when motion is detected, and stays on as long as the motion continues. Then it revert back to 2700K CCT Color and the low-level brightness (0~50%) as per setting about 5 seconds after motion is no longer detected.
2. AUTO MODE (nighttime operation only)
  - To "AUTO" mode, slide the Time switch to the desired time setting (30s/1min/3min). At dusk, the light turns on to pre-selected low-level brightness (2700K). When motion is detected, the light turns to high-level brightness (5000K) and stays on as long as motion continues. When the motion is no longer detected, the light at high-level brightness (5000K) remains on for the predetermined time you set (30s/1min/3min), then switches back to pre-selected low-level brightness (2700K) automatically.
  - The light turns off automatically at dawn.

**Note: You can adjust the low-level brightness(0~50%) by using the low-level brightness(0~50%) knob on the backplate (See Fig.6).**
3. PC MODE (nighttime operation only)
  - In "PC" mode, the light will turn on at full brightness (5000K) at dusk and remains on until dawn.

## FUNCTION AND OPERATION (continued)

### 4. 3 HOURS (3H) MODE (nighttime operation only)

- In "3H" mode, the light turns to high-level brightness (5000K) at dusk, and stays "ON" for 3 hours, then it turns to pre-selected low-level brightness (2700K). It turns to high-level brightness (5000K) when motion is detected, and stays on as long as motion continues. When motion is no longer detected, it remains on for the predetermined shut-off delay time you set (30s/1min/3min), then returns to the pre-selected low-level brightness (2700K) automatically.
- The light turns off automatically at dawn.

**Note: You can adjust the low-level brightness(0~50%) by using the low-level brightness(0~50%) knob on the backplate (See Fig.6).**

### 5. CUSTOM MODE (nighttime operation only):

- In "CUSTOM" mode, the light turn on full brightness (2700K) at dusk and off at dawn automatically.
- Set motion sensor operation to go on at a specific time. Turn the wall switch "OFF", and turn it "ON" twice within 3 seconds. The light will go into motion-sensor operation at the specified time every night. The light turns off automatically at dawn.

For example, a homeowner wants to have the light stay on high-level brightness from dusk to 8pm, and would like the light to go into "AUTO" motion sensor mode. To achieve this, the light homeowner will turn the wall switch "OFF", and turn it "ON" twice within 3 seconds. This sets the time the light goes into "AUTO" mode every day, the light will behave the same way.

To revert back to Default, turn the wall switch "OFF" and then turn it "ON" after 5 seconds.

**Note: You can adjust the low-level brightness(0~50%) by using the low-level brightness(0~50%) knob on the backplate (See Fig.6).**

**When light units are linked, the Set motion sensor operation to go at a specific time is also linked when MODE settings are in Custom.**

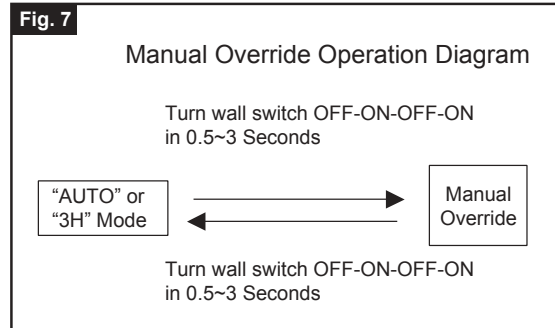

### Customization Options:

#### Shut-off Delay

- The shut-off delay is the length of time the light will stay at brightness after motion is detected.
- You can set the shut-off delay by push the switch so it points to the desired time setting (30s/1min/3min).

#### Notes:

1. The sensitivity of the motion sensor will increase as the environmental temperature gets cooler. For best performance, gently clean the lens with a soft cloth every 1 or 2 months to ensure maximum sensitivity.
2. For best performance, install fixture at least 8 feet above the ground. At such a height, the fixture will provide a detection distance of up to 70 feet at 77 degrees Fahrenheit. (See Fig.8)
3. The sensor detects movement across a detection range of 240 degrees. (See Fig.9)
4. The sensor will be more sensitive to motion across its detection path than motion directly towards it. (See Fig.10)
5. To reduce possible nuisances, do not mount the fixture near a heat source like an air conditioner, vent or furnace exhaust, or in a direction facing any reflective object or other nearby light source.

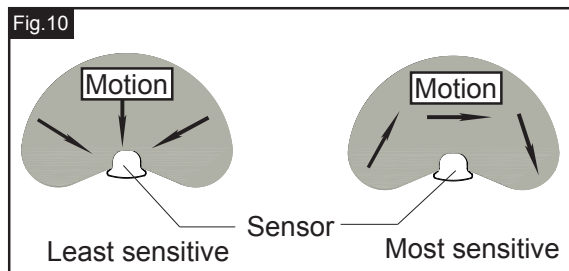
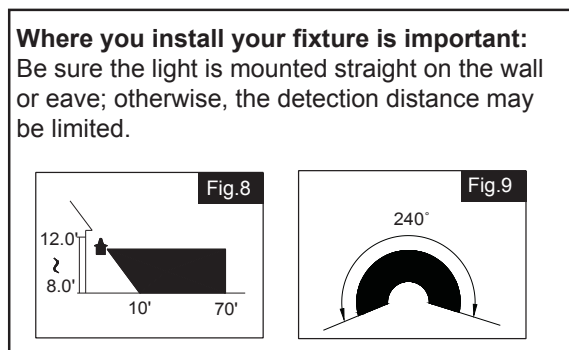

# USER GUIDE

## Setting for single light through mobile device (Take iOS for example as below. Android will be slightly different).

### Before you start

1. Search "DualuxBT" in IOS APP store or "Dualux" in Android Google Play. Install the Dualux APP onto the device. It's available for Apple and Android device.

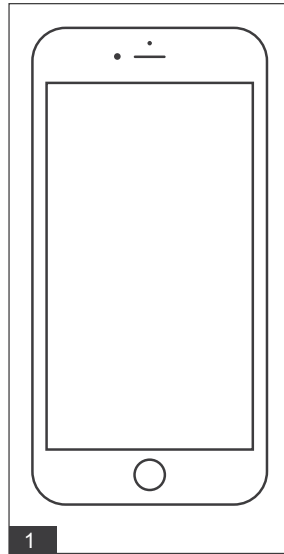

2. Start the App and click "WIFI".



3. Click "Register" for new accounts or "Login" for existing accounts.

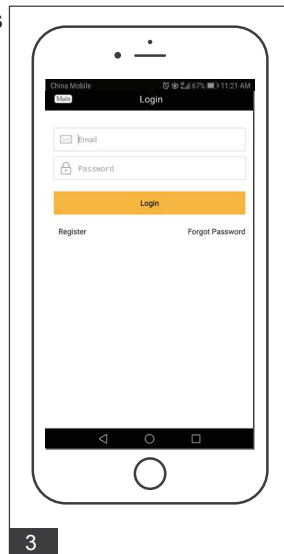

4. Enter E-Mail address, then click "Next".

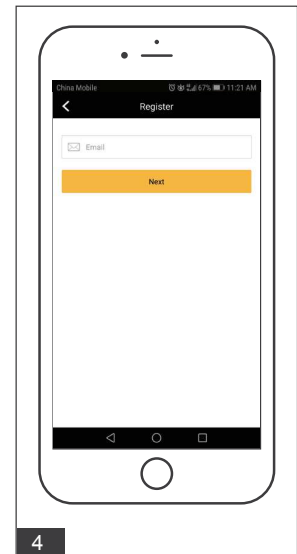

5. Enter verification code and set password, then click register.

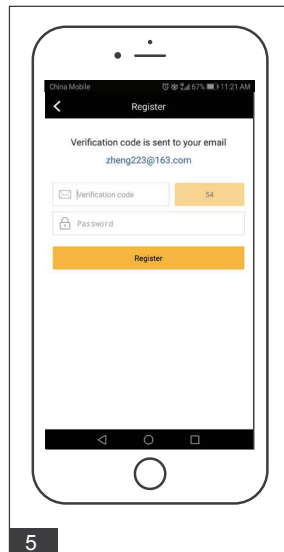

6. Click "Search for lights".

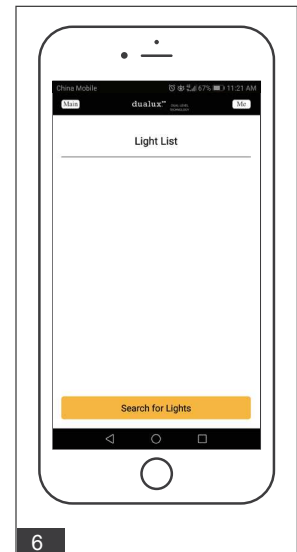

7. Follow the step 1, 2, 3 show in the phone, then click “next”.

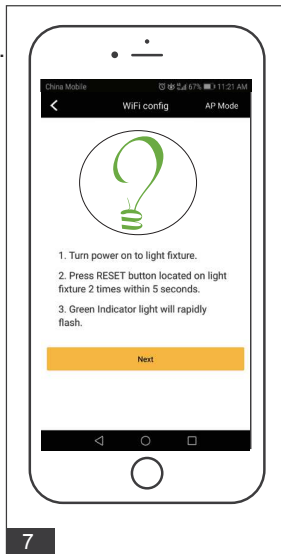

7

8. Choose a 2.4GHz WiFi network and enter the WiFi password, then click “Confirm”.

**Note: Only works with 2.4GHz WiFi networks.**

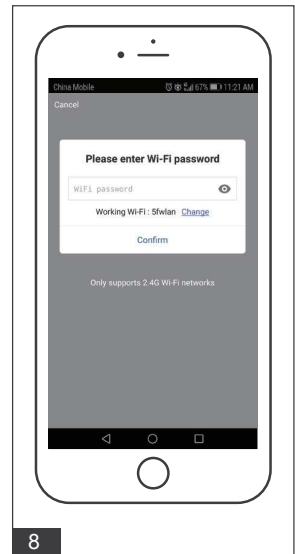

8

9. The status window will appear once the device(s) have successfully connected and the 3 bullets point on the bottom will follow by a tick.

**Note: If unsuccessful, the “Failed to Add” screen will appear. Close the App and repeat the previous steps, or connect to WiFi in AP mode (9.1~9.5).**

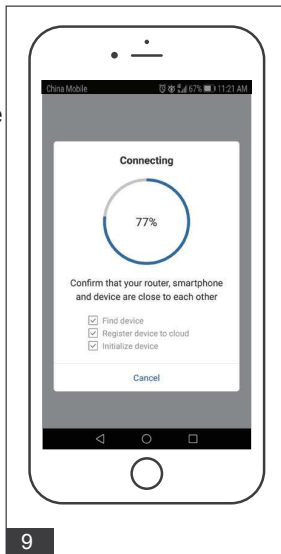

9

### AP mode setup steps (9.1~9.5).

9.1 In Fig.7 click “ AP mode” (In the upper right corner). Follow the step 1, 2, 3, 4 show in the phone, then click “next”.

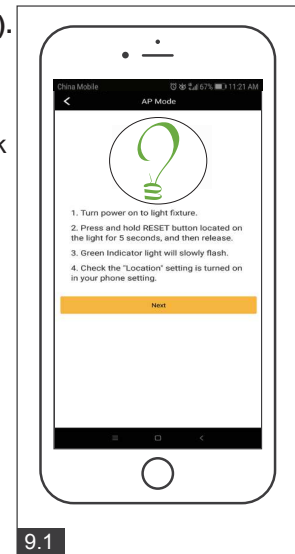

9.1

9.2 Choose a 2.4GHz WiFi network and enter the WiFi password, then click “Confirm”.

**Note: Only works with 2.4GHz WiFi networks.**



9.2

9.3 Connected to the lighting devices “WiFi (HF-XXXXXX)”. Click “Set Wi-Fi”.



9.3

# USER GUIDE (continued)

9.4 Choose a “HF-XXXXXX” WiFi to connect. (See Fig 9.4-1) then click “←” to return. (See Fig 9.4-2)

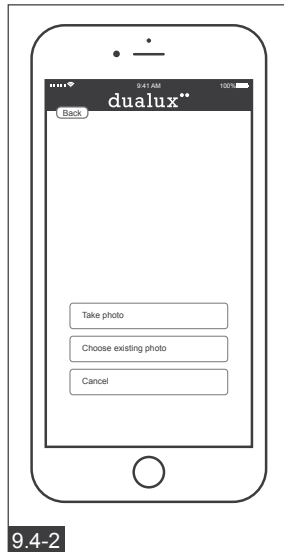
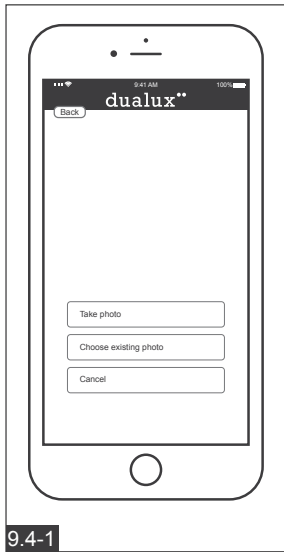

9.5 The status window will appear once the device(s) have successfully connected and the 3 bullets point on the bottom will follow by a tick.

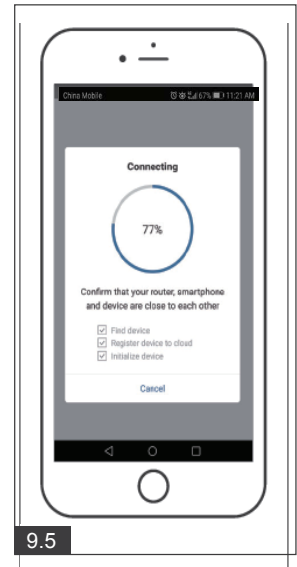

10. Successfully added device, then click “confirm”.(See Fig10-1) If you want to rename, click the “modify device name”, enter the new name and save.(See Fig10-2) The light is now ready to be controlled with the dualux App.

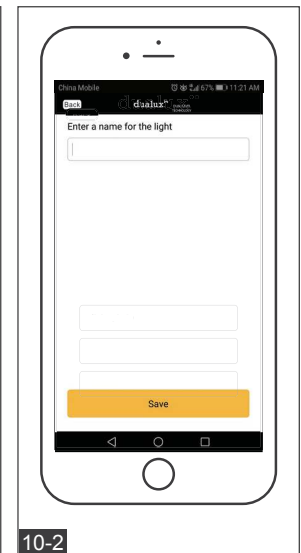
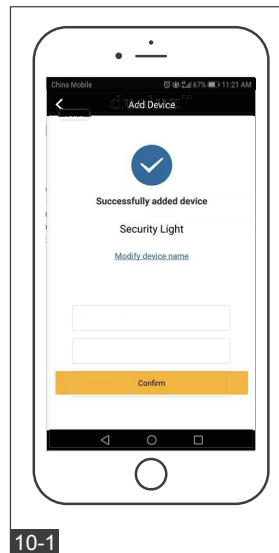

11. The new light will be shown in light list. And click “✎” icon, it will go to the setting list.

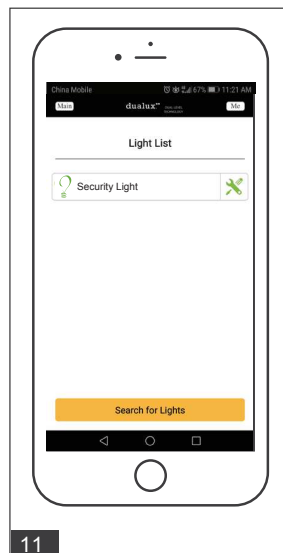

12. The Setting list, You can set up “Functions”, “Change image”, “Rename light”, and “Restore factory defaults”.



## USER GUIDE (continued)

13. Click the “Functions”, You can choose “Test”, “Auto”, or “Custom Setting”.

Select “Test” in Manual override and adjust “Detection Distance”, “Brightness” and “CCT change” as desired. Then click “Save”.

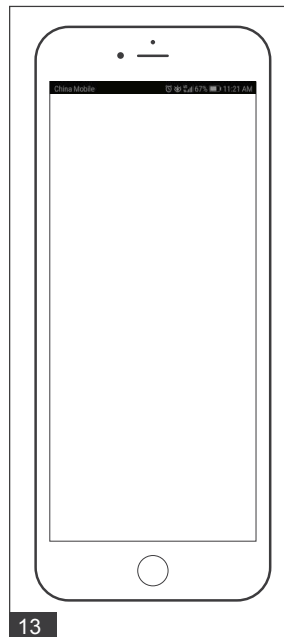

14. Select “Auto” in Manual override and adjust “Motion Delay Time”, “Detection Distance”, “Brightness” and “CCT change” as desired. Then click “Save”.

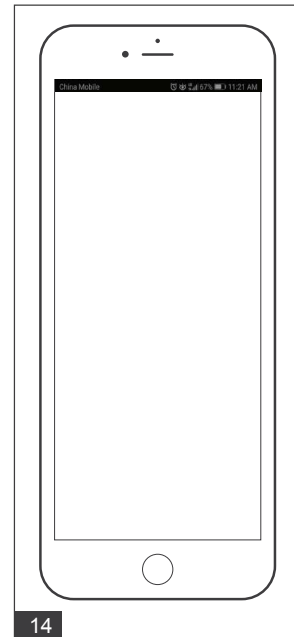





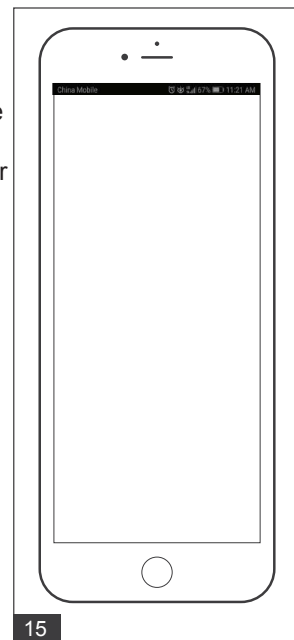

15. Select “Custom Settings” in Manual Override for Customize Early Evening Mode setting and choose option between “Duration” or “Clock Time (End Time)” to set the continuous bright light illumination duration. Within “Duration”, you may set from 0 to 12 hours for continuous bright light once lamp is activated at night. In “Clock Time (End Time)”, is the time you set to deactivate the continuous bright light according to the actual hour in the mobile device after the lamp is activated. Both option settings will return to motion-sensor operation after the continuous bright light is deactivate. 9:00 P.M. is the default in “Clock Time (End Time)”.

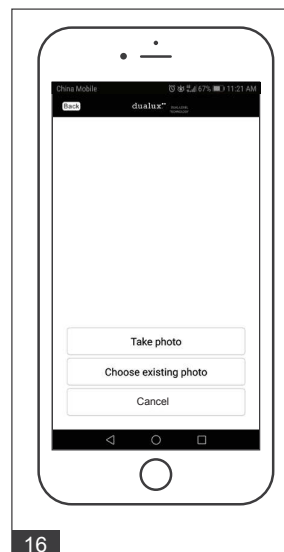
**Note: “Duration” setting will only work once per setting, it automatically go into “Clock Time (End Time) on the next day. Also if you do not click save for either option, then the settings will follow according to the switch control on the actual lamp.**



16. In Fig.13 “Change image”. And click “take photo” to take a photo.



- Android: Click “” to grasp a your desired view.  
IOS: Click “” to grasp a your desired view.
- Android: Click “” to take a photo.  
The iOS system  does not have this step.
- Android: Adjust the photo to trim the photo's "desired size. Then click “”.  
IOS: Click “Done” to take a photo. 



## USER GUIDE (continued)

17. It will turn to “change image”.  
The photo will show on it.  
(Android will be slightly different from the iOS system)

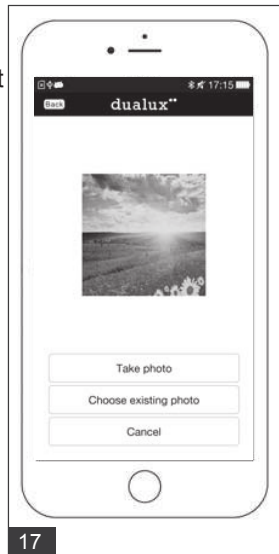

17

18. Go back to “Light list”, the photo will show on the left of “Light 1”.



18

19. Click “choose existing photo” to choose a desired image on your device. Then click “Cancel” back to “Setting” menu list.

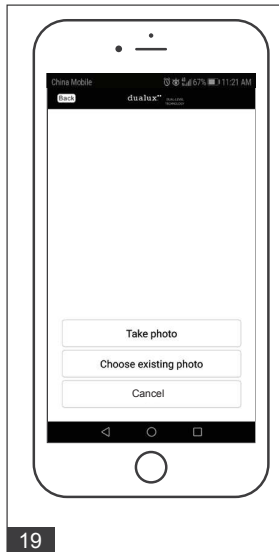

19

20. Click Fig.13 “Rename light” to enter a name for the light, then click “Save”.

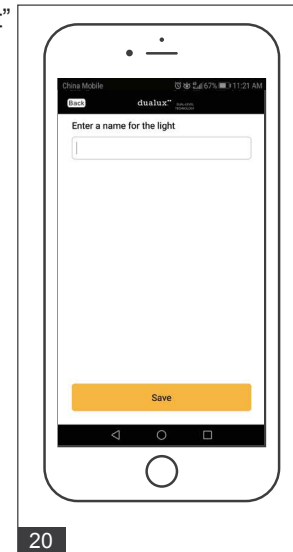

20

21. Click "Remove light" to remove the device from the light list.  
If you want to reconnect the light, press "reset button" twice within 5 seconds.



21

- Note:**
1. Manual control and App control independently.
  2. The function will execute the last settings.
  3. For achieving the best performance, make sure the wall switch is in “ON” state (daytime and nighttime).

## Voice Command Control

### **Manual Override Daytime:**

During day time, when you say “Turn On Security light”, the light will turn on and stay on all day, and then go into Auto Mode during dusk.

### **Manual Override Nighttime:**

During nighttime, when you say “Turn On Security light”, the light will turn on and stay on. The light will then turn off at dawn, and go into Auto Mode during the next dusk.

### **CCT Color Change:**

When the light is on, you may adjust the CCT Color by saying “Set Security light Warmer (or Cooler)” or you may say “Set Security light to Warm White (or Daylight)”.

### **Adjust High Level Brightness:**

Anytime when you say “turn on security light”, after the light turns on, you may adjust the High Level Brightness by saying “make security light to 50% (75%, or 100%)”, or “brighten (or dim) security light”. Then say “turn off security light” to confirm you High Level Brightness setting.

### **Adjust Low Level Brightness:**

Anytime when you say “turn off security light”, after the light turn off, you may adjust the Low Level Brightness by saying “make security light to 0% (25%, or 50%)”, or “brighten (or dim) security light”. Then say “turn off security light” to confirm your Low Level Brightness setting.

If the light fixture Mode setting was 3H/6H/PC (Set on light fixture or App), after complete voice control setting, the light will automatically switch to Auto mode.

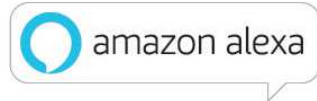

Smarter More Helpful Home Security Light That Work with Alexa Control lighting with simple voice commands.

Adjust brightness:

- Alexa, turn on/off security light;
- Alexa, make security light to 10% ~ 100% percent;
- Alexa, brighten/increase security light;
- Alexa, dim/decrease security light.

Adjust color temperature:

- Alexa, make security light warmer;
- Alexa, make security light cooler;
- Alexa, make security light to warm white;
- Alexa, make security light to soft white;
- Alexa, make security light to white;
- Alexa, make security light to daylight white

## Connecting to Alexa

1. Search "Amazon Alexa" in Google Play or Apps Store to download Amazon Alexa App and complete sign in.

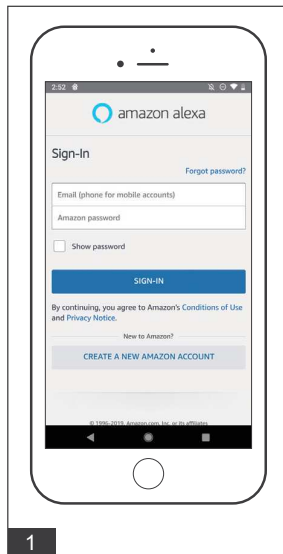

2. Select your name or someone else.

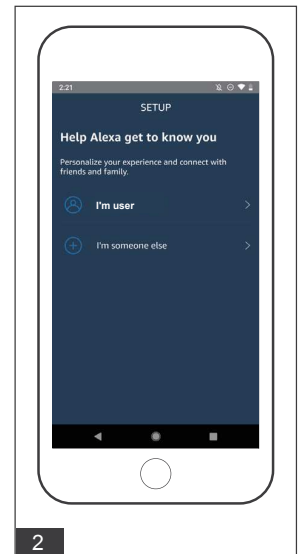

3. Start the Alexa App then click on the "Menu" (three horizontal lines icon). (In the upper left corner)

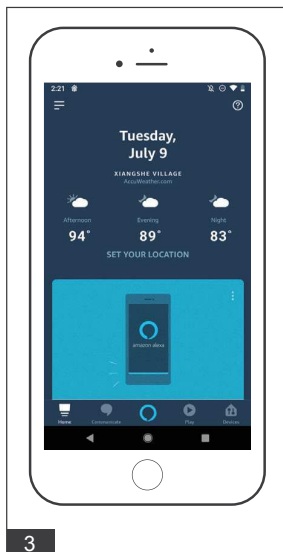

4. Select Skills & Games.

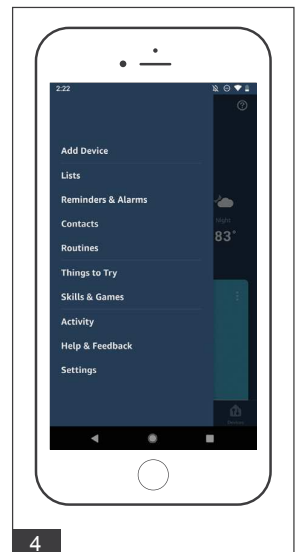

# USER GUIDE (continued)

5. In the search menu type "Innovation & Perfect". then click "Innovation & Perfect".

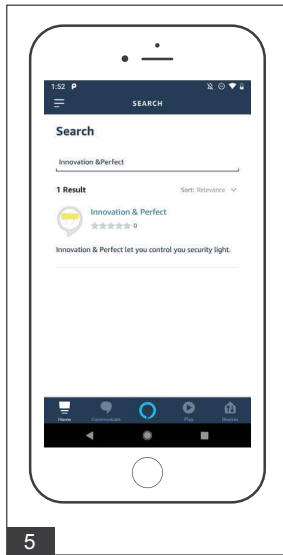

6. Click "ENABLE TO USE".

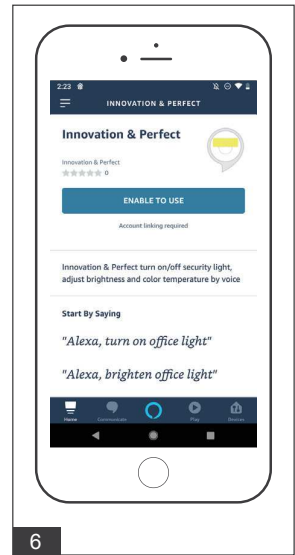

7. Enter the same user name & password that you have registered under the dualux App. Then click "Login".

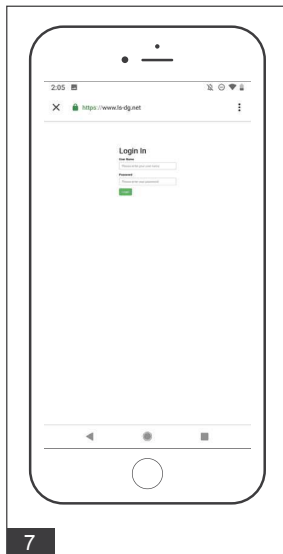

8. Once successful linked page appear, click upper left "X".



9. In Fig 9, click "discover device".

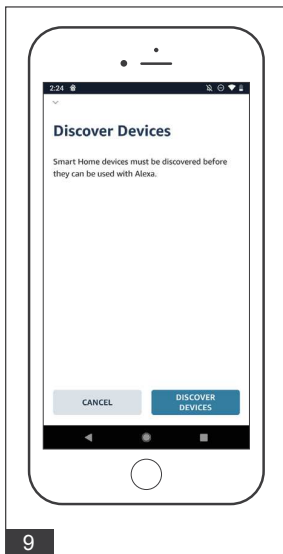

10. Discover devices for 20 seconds

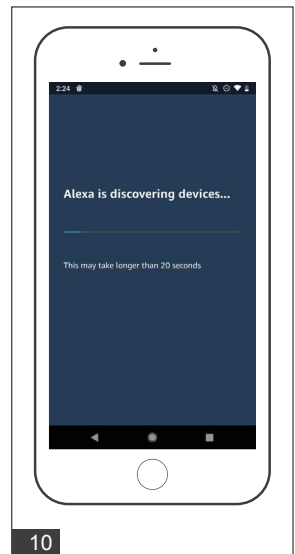

# USER GUIDE (continued)

11. When light is discovered click "set up device".

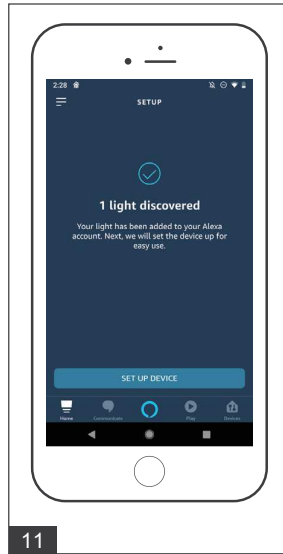

12. Add your light to a group.

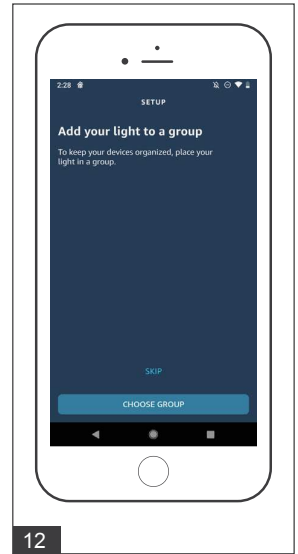

13. Select a group.

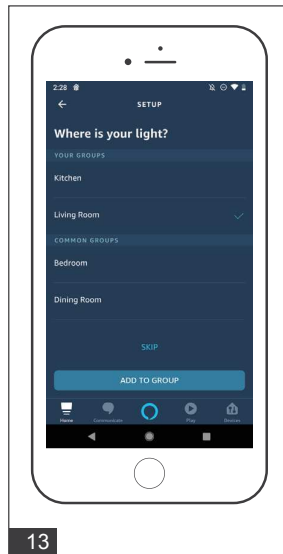

14. Light is added to a group.

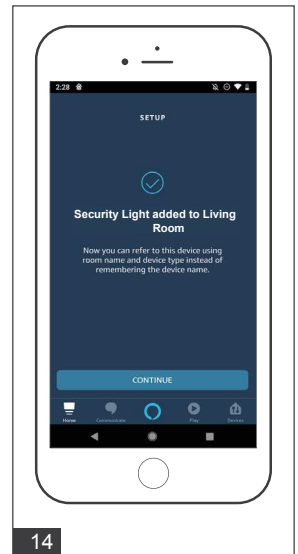

15. Click "lights".

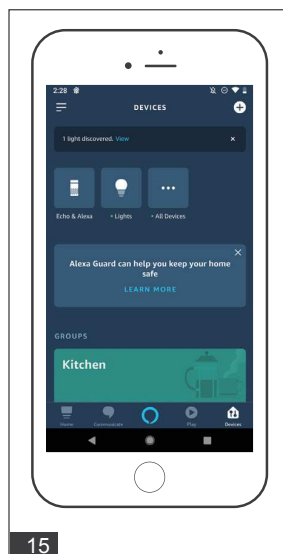

16. New device is displayed in group.

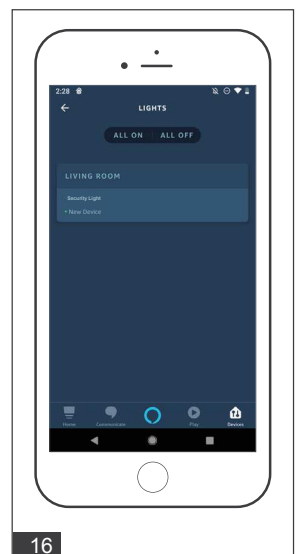

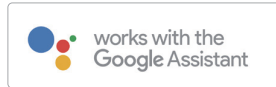

Smarter More Helpful Home Security Light That Work with Google Home Control lighting with simple voice commands.

Adjust brightness:

- Hi, Google, turn on/off security light;
- Hi, Google, make security light to 10% ~ 100% percent;
- Hi, Google, brighten/increase security light;
- Hi, Google, dim/decrease security light.

Adjust color temperature:

- Hi, Google, make security light to warm white;
- Hi, Google, make security light to soft white;
- Hi, Google, make security light to white;
- Hi, Google, make security light to daylight white.

## Connecting to Google Home

1. Search "Google Home" in Google Play or App Store to download Google Home App and complete sign in.

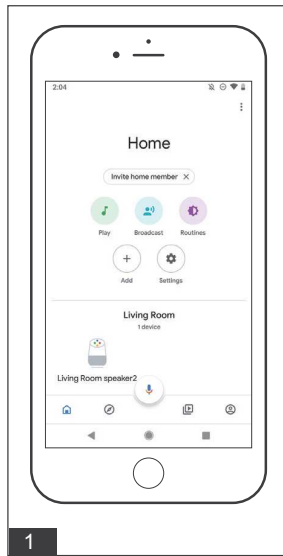

2. Click set up device.

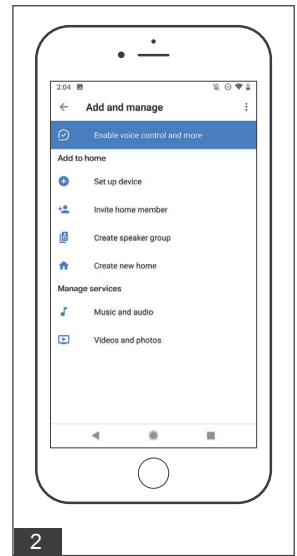

3. Select Works with Google.

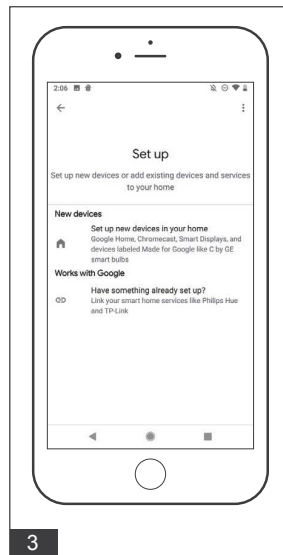

4. Select Innovation & Perfect.

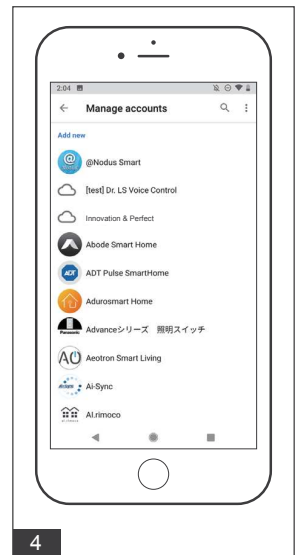

## USER GUIDE (continued)

5. Enter the same user name & password that you have registered under the dualux App.

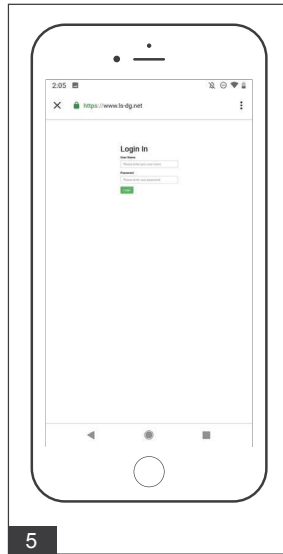

6. Wait for signing in.

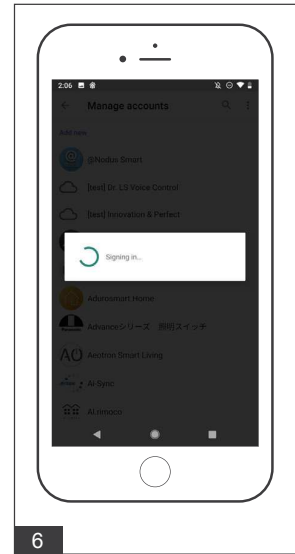

7. Go back to main page.

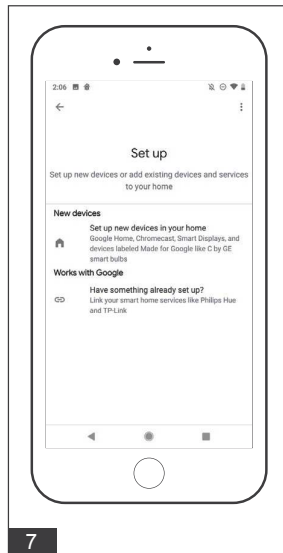

8. A device links to google home automatically.

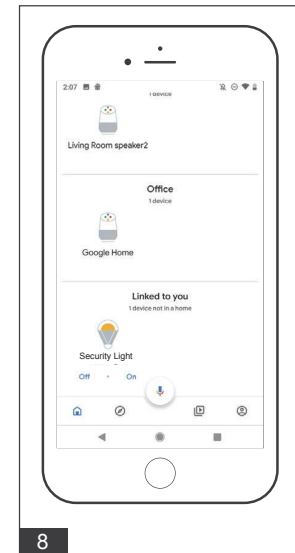

Range	Up to 70ft. (Varies with surrounding temperature)
Sensing angle	Up to 240°
Electrical load - LED	32W
Lumens	2600lm
Power requirements	120 VAC, 60Hz
Operating modes	Test, Auto, 3H, 6H, PC
Time delay	30s, 1min, 3min
Mobile device requirements	Iphone 4S or newer running IOS 10.0 x or later. Android v6.0 or later

## **Troubleshooting**

---The light does not come on at all:

1. Make sure the wall switch and circuit breaker are on.
2. Make sure the wiring is correct.
3. Cover the sensor with dark color cloth to verify that the ambient light level is not too high.

---The light comes on for no apparent reason

1. Re-aim the motion sensor.
2. Decrease the sensitivity setting.
3. Do not use a dimmer or timer to control the light fixture. Replace the dimmer or timer with a standard on/off wall

---The light flashes on and off:

1. Reposition the bulb away from the motion sensor.
2. Reposition the motion sensor.
3. The motion sensor is in "TEST" mode and warm up.

**The following parts are available for re-order if damaged or missing. Call our toll free at 1-800-887-6326.**

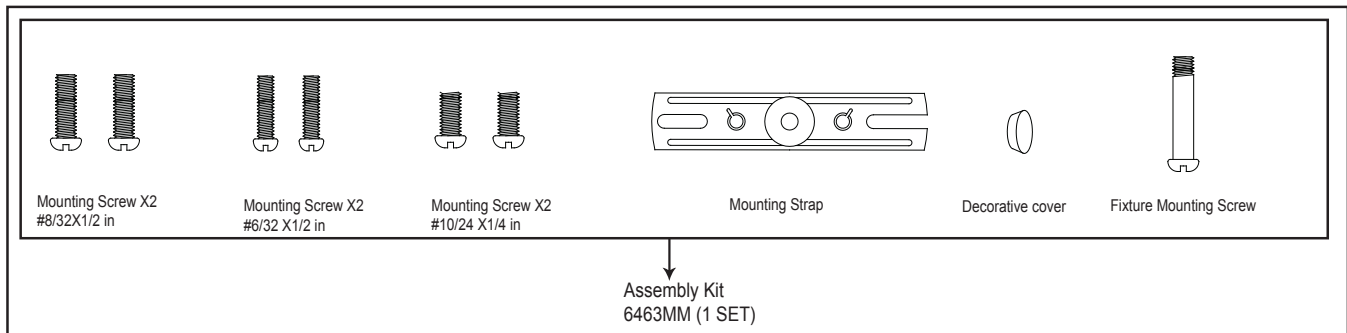

### **5-YEAR LIMITED WARRANTY:**

All products are warranted to be free of defects in material and workmanship for five (5) years from date of purchase. This warranty is limited to the correction of any such defect, or the replacement of any such defective item(s), provided that: (a) we are properly notified and consent to return of the item(s) in question;(b) the item(s) is / are returned with proof of purchase date; and (c) it is found upon inspection by us that the item(s) is / are defective as noted above. This warranty does not cover labor costs, consequential damages, nor does it apply to any item(s) that have been improperly installed, overloaded, altered, or otherwise abused by the customer, its agent(s) or employee(s). Finishes are specially excluded from the terms of this warranty since they are subject to environmental maintenance deemed beyond our control. Other than the described obligation, we assume no further liability with respect to the sale or use of our products. We make no warranty, express or implied, and disclaim any warranty of merchantability or fitness for a particular purpose.



## FCC Statement

This device complies with Part 15 of the FCC Rules. Operation is subject to the following two conditions:  
(1) this device may not cause harmful interference, and (2) this device must accept any interference received, including interference that may cause undesired operation.

Changes or modifications to this unit not expressly approved by the party responsible for compliance could void the user's authority to operate the equipment.

NOTE: This equipment has been tested and found to comply with the limits for a Class B digital device, pursuant to Part 15 of the FCC Rules. These limits are designed to provide reasonable protection against harmful interference in a residential installation. This equipment generates uses and can radiate radio frequency energy and, if not installed and used in accordance with the instructions, may cause harmful interference to radio communications.

However, there is no guarantee that interference will not occur in a particular installation. If this equipment does cause harmful interference to radio or television reception, which can be determined by turning the equipment off and on, the user is encouraged to try to correct the interference by one or more of the following measures:

- Reorient or relocate the receiving antenna.
- Increase the separation between the equipment and receiver.
- Connect the equipment into an outlet on a circuit different from that to which the receiver is connected.
- Consult the dealer or an experienced radio/TV technician for help.

This equipment complies with FCC radiation exposure limits set forth for an uncontrolled environment. This equipment should be installed and operated with a minimum distance of 20cm between the radiator & your body. This transmitter must not be co-located or operating in conjunction with any other antenna or transmitter.

