

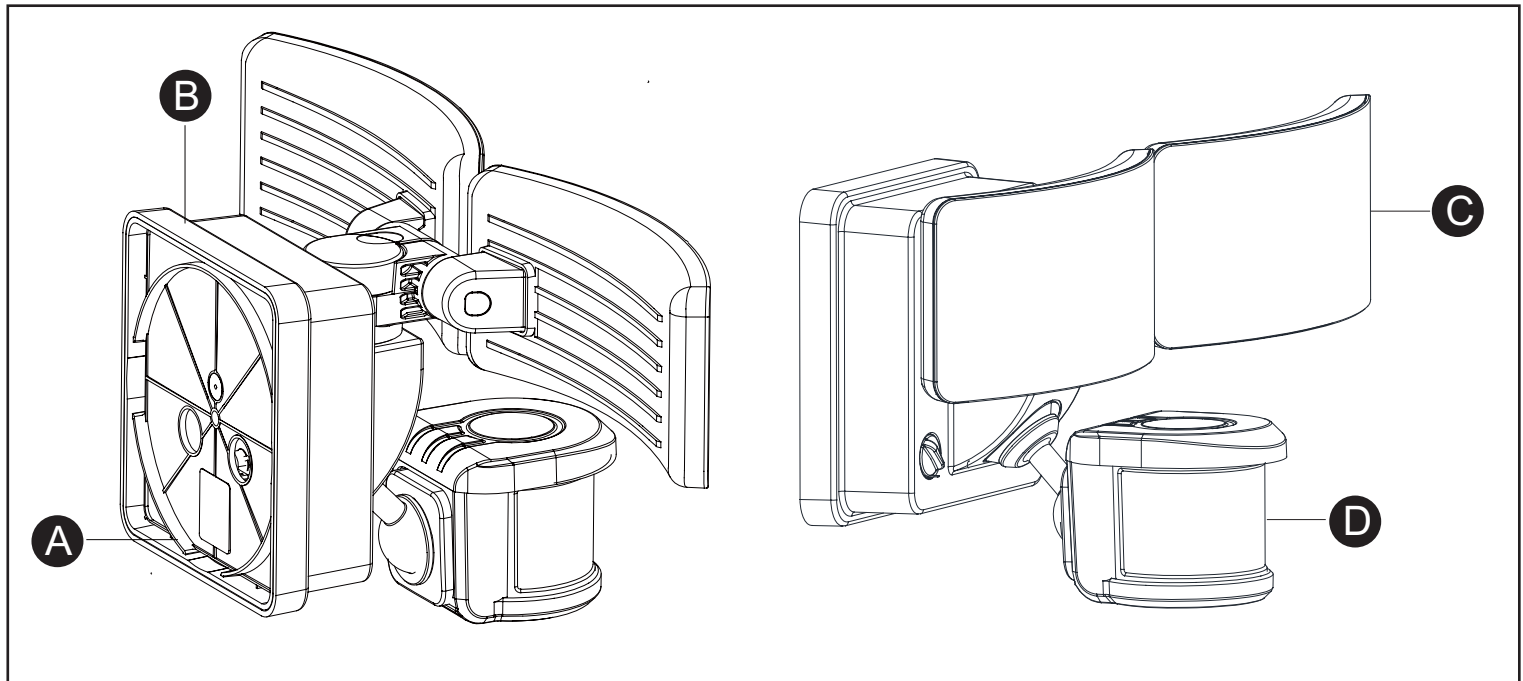

Questions, problems, missing parts?

Before returning to your retailer, call our customer service at 1-800-887-6326
 Monday – Friday 9:00 a.m. – 5:00 p.m. CST

PACKAGE CONTENTS



HARDWARE CONTENTS Note: Hardware not shown actual size.

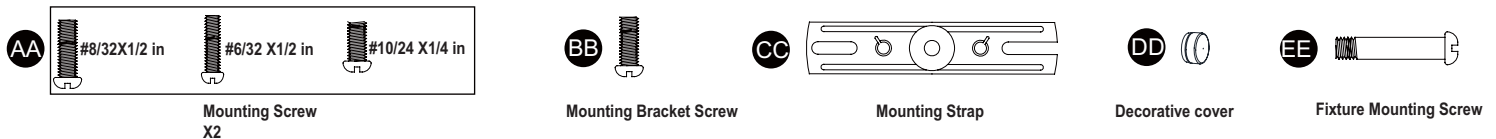

SAFETY INFORMATION

Please read and understand this entire manual before attempting to assemble, operate or install the product.

WARNING

- Turn off electricity at main fuse box (or circuit breaker box) before beginning installation by removing fuse (or switching off circuit breaker).
- Be careful not to damage or cut the wire insulation (covering) during fixture installation. Do not permit wires to contact any surface having a sharp edge. To do so may damage or cut the wire insulation, which could cause serious injury or death from electric shock.

CAUTION

- All electrical connections must be in agreement with local codes, ordinances or the national electric code (NEC). Contact your municipal building department to learn about your local codes, permits and/or inspections.
- Risk of fire – most dwellings built before 1985 have supply wire rated for 140°F/60°C. Consult a qualified electrician before installation.
- Only general ON/OFF wall switch applies for this fixture, the dimmable wall switch shouldn't be required.

Maximum Wattage: 29 W
Working Temperature Range: -4°F ~ 113°F

PREPARATION

Before beginning assembly, installation or operation of product, make sure all parts are present. Compare parts with package contents list and diagram on previous page. If any part is missing or damaged, do not attempt to assemble, install or operate the product. Contact customer service for replacement parts.

Tools Required for Assembly (not included): Screwdriver, Phillips Screwdriver, Pliers, Electrical Tape, Wire Cutters, Safety Glasses, Ladder, Wire Stripper.

ASSEMBLY INSTRUCTIONS

Important to Know

1. This fixture requires a 120 VAC, 60 Hz power source.
2. For general safety and to avoid any possible damage to the sensor, be sure the power is switched "off" before adjustment.
3. Motion sensor: turns light ON automatically when motion is detected and turns light OFF automatically when motion stops.
4. Photocell keeps the light OFF during daylight hours.

Note: Fixture can be wall mounted or eave mounted.

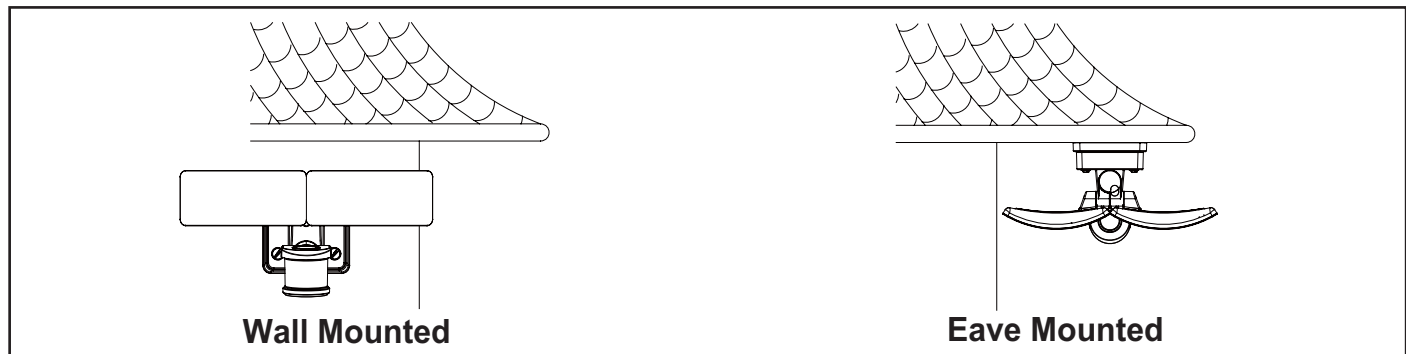

Light fixture and sensor should be mounted as shown above when installed (depending upon type of installation)

Before installing the light fixture under an eave, the sensor head must be rotated as shown in the next two steps for proper operation and to avoid the risk of electrical shock.

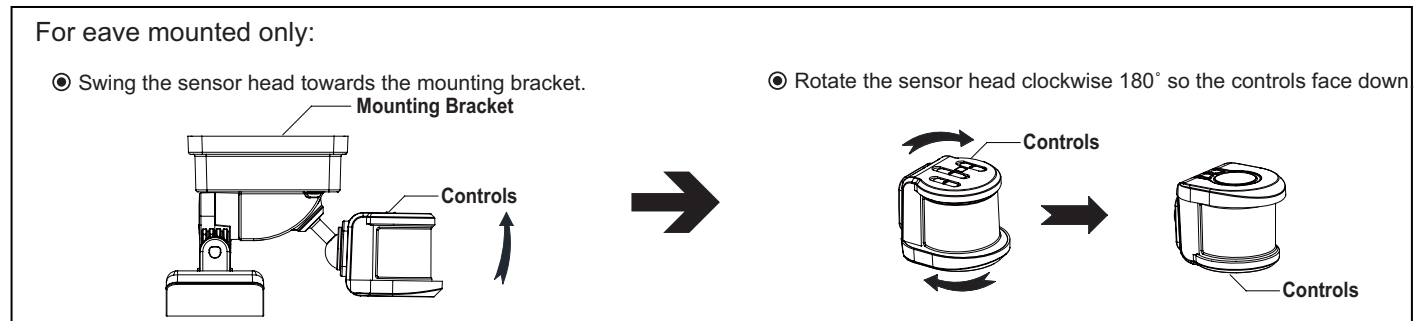

Installation Steps

Turn off the power at fuse or circuit box.

1. The fixture mounting bracket(A) is pre-assembled on the light fixture(B). Unscrew both the decorative cover(DD) and the fixture mounting screw(EF) in order to remove the mounting bracket(A).

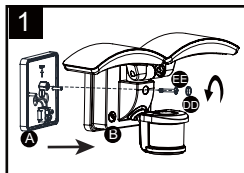

2. Install the mounting strap(CC) to the outlet box with the stamped word "FRONT" facing away from the outlet box, using two mounting screws(AA) that best fit the outlet box. Mounting bracket(A) should sit flush against wall surface when secured. (Choose one matching pair of suitable mounting screws(AA) from the 3 pairs provided).

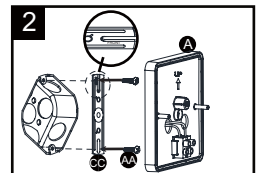

ASSEMBLY INSTRUCTIONS(continued)

3. Pull out the source wires from the outlet box. Connect the black wire from the outlet box to the "L" interface of the terminal station on the mounting bracket(A). Connect the white wire from the outlet box to the "N" interface of the terminal station on the mounting bracket(A). Carefully tuck the wires back into the outlet box.

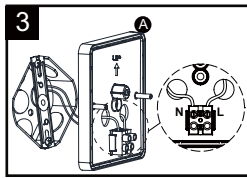

4. Place mounting bracket(A) against the outlet box, insert the mounting bracket screw(BB) through the mounting bracket hole, thread mounting bracket screw(BB) into the center hole of the mounting strap(CC). Tighten the mounting bracket screw(BB) securely.

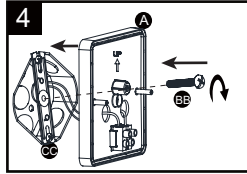

- ▲ When mounting to a wall, the "UP" arrow must point upward.
- ▲ When mounting to an eave, the "UP" arrow must point toward the building.

5. Attach the back plate(B) of the light fixture to the mounting bracket(A), secure it with the fixture mounting screw(EE). Then push the decorative cover(DD) firmly into the fixture mounting screw(EE) hole on the light fixture.

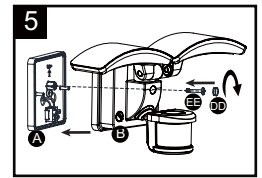

6. With silicone caulking compound, caulk completely around where the mounting bracket meets the wall surface. **CAUTION: Be sure to caulk completely where the mounting bracket meets the wall surface to prevent water from seeping into the outlet box.**

Adjusting the Sensor Head:

1. a: Aim sensor head toward desired detection area, maintaining a 5° - 40° downward angle to allow moisture to drain. (See Fig.1)
Note: Make sure sensor head is positioned with control knob facing towards the ground.
- b: You can rotate the sensor head up and down to change the coverage area. Walk through the detection zone at the farthest distance you wish to detect motion.

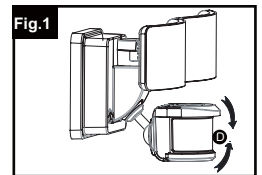

2. Range set too high may increase false triggering. (See Fig.2-1,2-2)

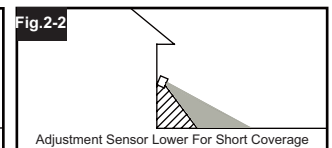
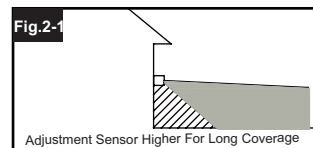

Adjusting the Light Head:

1. Gently grasp the light heads(C) and tilt them up or down, left or right to adjust the light coverage area. Keep the light heads at least 1" (25mm) away from the sensor. (See Fig.3)
2. Keep the light heads 30° below horizontal to avoid water damage and electrical shock.

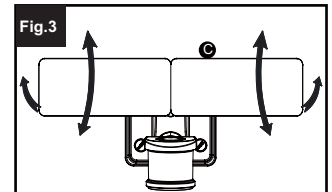

FUNCTION AND OPERATION

Sensitivity of Motion Sensor:

1. You can adjust the sensitivity of the motion sensor by using the "SENSITIVITY" selector located on the right side of the bottom surface of the sensor. (See Fig.4)
2. Adjust motion sensor sensitivity to HIGH (H), MEDIUM (M), or LOW (L) to achieve desired performance.
3. Approximate range for each setting: 25 ft. (L), 45 ft. (M), 70 ft. (H).

Choose a mode by sliding the switch on the bottom of the sensor. (See Fig.4)

Note: When power is first applied, the light will turn on to 100% brightness. The sensor will take 30 seconds to warm up.

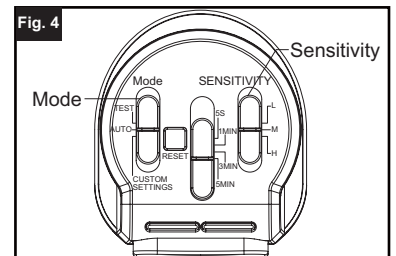

1. Test mode (daytime or nighttime operation)

- Slide the switch on the left side of the sensor to the "TEST" position. (See Fig.4)
- With the power on, the light turns to low-level brightness automatically.
- The light turns to high-level brightness when motion is detected, and stays on as long as the motion continues. Then it reverts back to low-level brightness about 5 seconds after motion is no longer detected.

Note: You can adjust the low-level (0~50%) and high-level (50~100%) brightness by using the brightness switch on the back plate. (See Fig. 5)

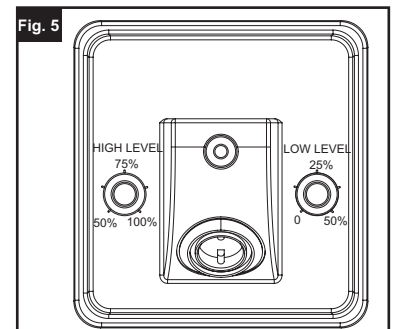

FUNCTION AND OPERATION(contiuned)

2. AUTO MODE (nighttime operation only)

- To shift to "AUTO" mode, slide Time Delay switch to the desired time setting (between 5 seconds and 5 minutes). At dusk, the light turns on to pre-selected low-level brightness. When motion is detected, the light turns to pre-selected high-level brightness and stays on as long as motion continues. When the motion is no longer detected, the light at high-level brightness remains on for the predetermined time you set (5S/1M/3M/5M), and then switches back to low level automatically.
- The light turns off automatically at dawn.

Note: You can adjust the low-level (0~50%) and high-level (50~100%) brightness by using the brightness switch on the back plate. (See Fig. 5)

3. CUSTOM SETTINGS MODE (nighttime operation only)

- At dusk, the light will turns on to pre-selected high-level brightness. And the light will turns off automatically at dawn.
- To switch to the "AUTO" mode at the specified time,turn the wall switch "OFF" then turn it "ON" within 3 seconds at your specified time.And the light will switches to "AUTO" mode automatically at the specified time every night. The light turns off automatically at dawn. To revert to "CUSTOM SETTINGS" mode,turn the wall switch "OFF" then turn it "ON" within 5 seconds again.

Note: You can adjust the low-level (0~50%) and high-level (50~100%) brightness by using the brightness switch on the back plate. (See Fig. 5)

Notes:

1. The sensitivity of the motion sensor will increase as the environmental temperature gets cooler. You may wish to make adjustments when the season changes. For best performance, gently clean the lens with a soft cloth every 1 or 2 months to assure maximum sensitivity.
2. For best performance, install fixture at least 8 feet above the ground. At such a height, the fixture will provide a detection distance of up to 70 feet at 77 degrees Fahrenheit. (See Fig.6)
3. The sensor detects movement across a detection range of 240 degrees. (See Fig.7)
4. The sensor will be more sensitive to motion across its detection path than motion directly towards it. (See Fig.8)
5. To reduce possible nuisances, do not mount the fixture near a heat source like an air conditioner, vent or furnace exhaust, or in a direction facing any reflecting object or other light source.

Where you install your fixture is important:
Be sure the light is mounted straight on the wall or eave; otherwise, the detection distance may be limited.

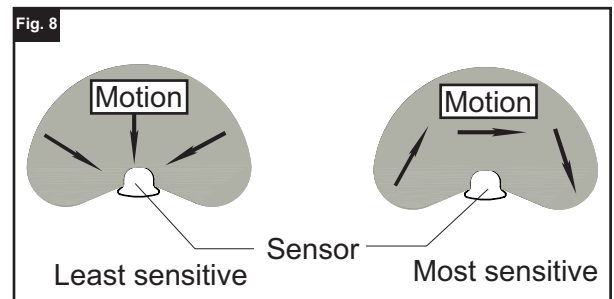
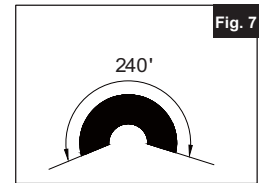
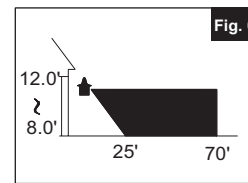

USER GUIDE

Setting for single light through mobile device (Take IOS for example as below. Android will be slightly different).

1. Search “Dualux BT” at Apple store or Android Google Play. Download the “Dualux BT” APP onto the device.



Fig.1

2. Start the APP. Turn on the Bluetooth in device settings.

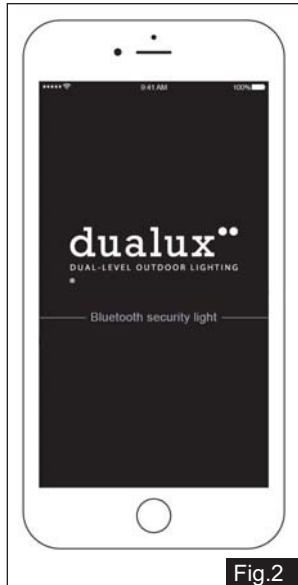

Fig.2



Fig.3

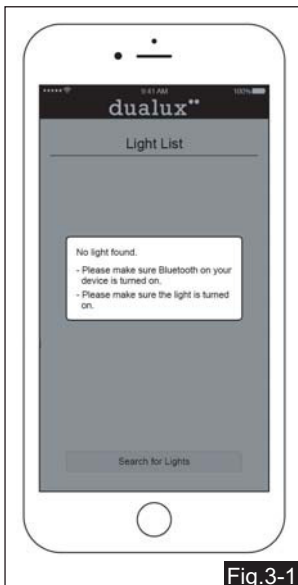

Fig.3-1

4. If there is a light in bluetooth cover range, the new light will be shown in light list. And the touch “Light 1”, App will go to the step 5 interface. And touch “✕” icon, App will go to the step 8 interface.



Fig.4

5. Select “Test” in Manual override and adjust “Detection Distance” and “Brightness” as desired. Then press “SAVE”. **Note:** If your settings on the “Manual override” mode forget to save, the settings will be performed for 2 minutes, then the light will revert to physical switch’s control on the lamp.

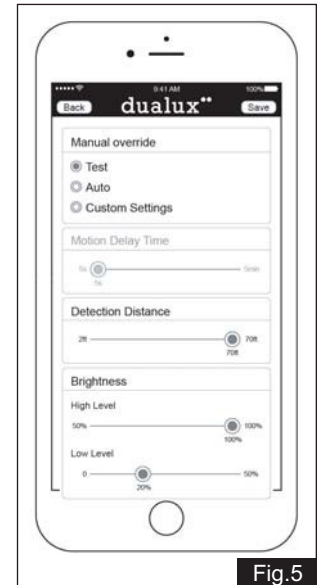

Fig.5

6. Select “AUTO” in Manual override and adjust “Motion Delay Time”, “Detection Distance” and “Brightness” as desired. Then press “SAVE”. **Note:** If your settings on the “Manual override” mode forget to save, the settings will be performed for 2 minutes, then the light will revert to physical switch’s control on the lamp.

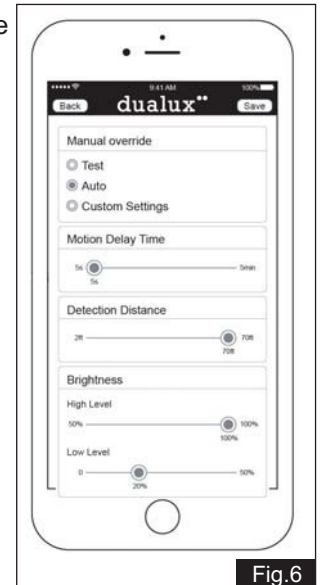

Fig.6

3. Ensure the power to the light is turned ON. Touch “Search for Lights” to search for existing lights. Make sure the bluetooth on your devices is turned on and the the light is turned on. Otherwise, the searching current light will be no result.

USER GUIDE (CONTINUED)

7. Select "Custom Settings" in Manual override. Adjust the "Duration" as desired, the "4hr" is the default. The light will turn to your setted high level brightness for your setted duaration, then turns to "AUTO" mode. The setting will be available only at this night. Next night the light will turn to "Clock time(End Time)" mode. Adjust the "Clock Time", the "9PM" is the default. The light will turn to high level brightness you set for the pre-setted "Clock Time", then turns to "AUTO" mode at your pre-setted time.

Note: If your settings on the "Manual override" mode forget to save, the settings will be performed for 2 minutes, then the light will revert to physical switch's control on the lamp.

8. Press Fig.4 "✕" icon, select "Functions", you can choose "Test", "AUTO", or "Custom Setting" which have been adjusted to edit your settings.

9. Press Fig.8 "Change image". And touch "take photo" to take a photo.

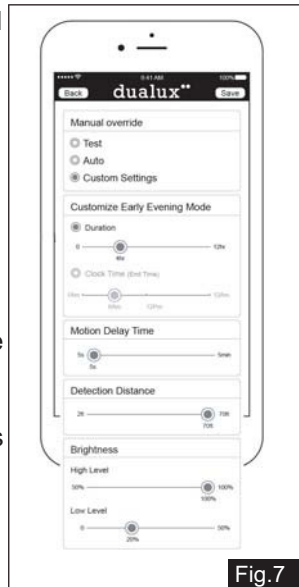

Fig.7

- 9.1 Click " " to grasp a your desired view



Fig.9-1

- 9.2 Click " " to take a photo.

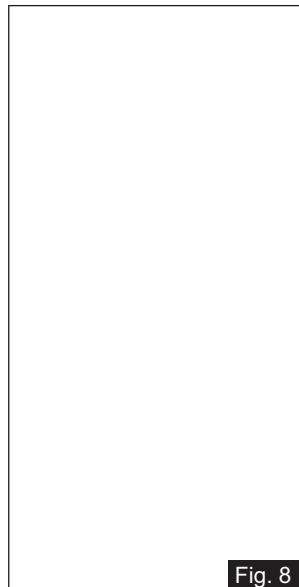

Fig. 8

- 9.3. Adjust the photo to trim the photo's desired size. Then click " ".

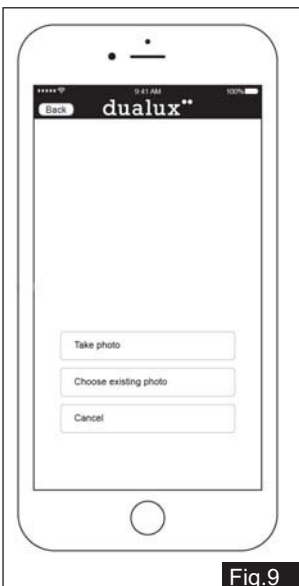
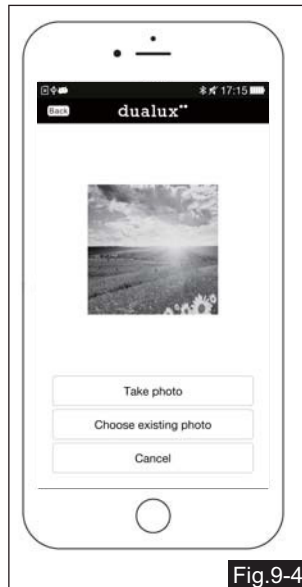

Fig.9

USER GUIDE (CONTINUED)

9.4. App will turns to “change image” interface. The photo should show on it.



9.5. Take back to “Light list” interface, the photo should show on the left of “Light 1”



10. Press Fig.9 “Change existing photo” to choose a desired image on your App. Then click “Cancel” back to “Setting” menu list.



11. Press Fig.8 “Rename light” to enter a name for the light, Then press “Save”.

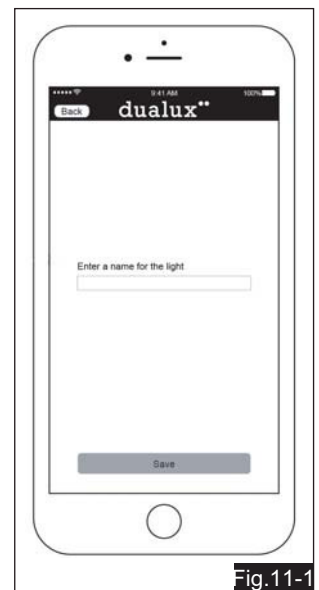

12. Press Fig.8 “Password” to set the password for bluetooth device, so that others need password to connect this lamp.



USER GUIDE (CONTINUED)

12. 1 The password must be 4 to 6 alpha-numeric characters. Enter new password and verify it then press “Save”.



Fig. 12-1

13. Press Fig.8 “Restore factory defaults” to restore your settings (only the light name and password) to the original conditions.

Note: The photo’s settings can’t be restored by using this function.



Fig. 13

- 13.1 Keep pressing the “reset” button on the light for 5 seconds, the light will flash three times. Then press “Back” button.

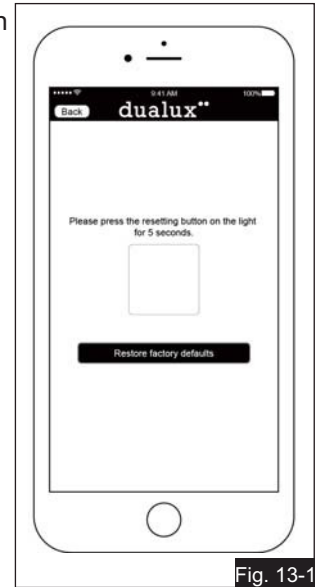

Fig. 13-1

Note: 1. Manual control and App control independently.

2. The function which is executed is the latest settings.

3. When call again after power cut, the function will revert to physical switch’s control on the lamp.







4. For achieving the best performance, make sure the wall switch is in “ON” state (daytime and nighttime).

5. Once the power fails, the light will revert to physical switch’s control on the lamp.

Range	Up to 70ft. (21.3m)(Varies with surrounding temperature)
Sensing angle	Up to 240
Electrical load - LED	29W
Lumens	2600lm
Power requirements	120 VAC, 60Hz
Operating modes	Test, Auto, Customer setting, Manual
Time delay	5s, 1min, 3min, 5min
Mobile device requirements	Iphone 4S or newer running IOS 8.0 x or later. Android v4.4 or later Phone must also have Bluetooth version 4.0 or later

The following parts are available for re-order if damaged or missing. Call us toll-free at 1-800-887-6326

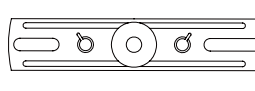
Spare Parts List:

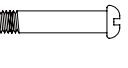
 #8/32X1/2 in	 #6/32 X1/2 in	 #10/24 X1/4 in				
Mounting Screw X2			Mounting Bracket Screw	Mounting Strap	Decorative cover	Fixture Mounting Screw

↓
Assembly Kit
5569MM (1 SET) for 356-9243
5570MM (1 SET) for 356-9244

CARE AND MAINTENANCE

- To clean, turn off and wipe with a damp, non-abrasive cloth.

TROUBLESHOOTING

1) The light does not come on at all:

- Make sure the wall switch and circuit breaker are on.
- Make sure the wiring is correct.
- Make sure the Daylight turn-on(photocell) is in effect.
- Make sure the motion sensor is aimed in the right direction to cover the desired area.
- Make sure the outside air temperature is not close to the same as a person's body heat.

2) The light comes on during the day.

- Make sure the motion sensor does not be installed in a relatively dark location.

If unable to fix any of the above issues, please consult a certified electrician.

FIVE-YEAR LIMITED WARRANTY: If, during normal use, this PATRIOT LIGHTING® lighting fixture breaks or fails due to a defect in material workmanship within five (5) years from the date of original purchase, simply bring this lighting fixture with the original sales receipt back to your nearest MENARDS® retail store. At its discretion, PATRIOT LIGHTING® agrees to have the product or any defective part(s) repaired or replaced with the same or similar PATRIOT LIGHTING® product or part free of charge, within the stated warranty period, when returned by the original purchaser with original sales receipt. This warranty; (1) excludes expendable parts including but not limited to light bulbs; (2) does not cover damage that has resulted from abuse or misuse; and (3) does not cover any losses, labor, injuries to persons/property or costs. This warranty does give you specific legal rights and you may have other rights, which vary from state to state.

FCC Statement

Any Changes or modifications not expressly approved by the party responsible for compliance could void the user's authority to operate the equipment.

This device complies with part 15 of the FCC Rules. Operation is subject to the following two conditions:

- (1) This device may not cause harmful interference, and
- (2) this device must accept any interference received, including interference that may cause undesired operation.

This equipment complies with FCC radiation exposure limits set forth for an uncontrolled environment. This equipment should be installed and operated with minimum distance 20cm between the radiator& your body.

This transmitter must not be co-located or operating in conjunction with any other antenna or transmitter.



Questions, problems, missing parts?

Before returning to your retailer, call our customer service at 1-800-887-6326
Monday – Friday 9:00 a.m. – 5:00 p.m. CST