

## ELECTROMAGNETIC EMISSIONS COMPLIANCE REPORT

**Applicant:** Montblanc-Simplo GmbH  
Hellgrundweg 100 22525 Hamburg, Germany

**Product Name:** Montblanc SUMMIT LITE

**Brand Name:** Montblanc

**Model No.:** SXL20

**Model Difference:** N/A

**Report Number:** ER/2020/70076

**FCC ID:** 2AENP-SXL20

**IC:** 20163-SXL20

**FCC Rule Part:** §15.247, Cat: DTS

**IC RSS:** RSS-247 issue 2 Feb 2017

**Issue Date:** Oct. 05, 2020

**Date of Test:** Jul. 13, 2020 ~ Aug. 14, 2020

**Date of EUT Re-  
ceived:** Jul. 13, 2020

### We hereby certify that:

The above equipment was tested by SGS Taiwan Ltd. Central RF Lab. The test data, data evaluation, test procedures, and equipment configurations shown in this report were made in accordance with the procedures given in ANSI C63.10:2013 and the energy emitted by the sample EUT tested as described in this report is in compliance with conducted and radiated emission limits.

The test results of this report relate only to the tested sample identified in this report.

Approved By:

CHUN-CHIEH, CHEN

Chun Chieh Chen / Supervisor



Unless otherwise stated the results shown in this test report refer only to the sample(s) tested and such sample(s) are retained for 90 days only.

除非另有說明，此報告結果僅對測試之樣品負責，同時此樣品僅保留90天。本報告未經本公司書面許可，不可部份複製。

This document is issued by the Company subject to its General Conditions of Service printed overleaf, available on request or accessible at <http://www.sgs.com.tw/Terms-and-Conditions> and for electronic format documents, subject to Terms and Conditions for Electronic Documents at <http://www.sgs.com.tw/Terms-and-Conditions>. Attention is drawn to the limitation of liability, indemnification and jurisdiction issues defined therein. Any holder of this document is advised that information contained hereon reflects the Company's findings at the time of its intervention only and within the limits of Client's instructions, if any. The Company's sole responsibility is to its Client and this document does not exonerate parties to a transaction from exercising all their rights and obligations under the transaction documents. This document cannot be reproduced except in full, without prior written approval of the Company. Any unauthorized alteration, forgery or falsification of the content or appearance of this document is unlawful and offenders may be prosecuted to the fullest extent of the law.

## Revision History

Report Number	Revision	Description	Issue Date	Remark
ER/2020/70076	Rev.00	Original.	Oct. 05, 2020	Revised By: Karen Huang

**Note:**

1、Disclaimer

Antenna information is provided by the applicant, test results of this report are applicable to the sample EUT received.

Unless otherwise stated the results shown in this test report refer only to the sample(s) tested and such sample(s) are retained for 90 days only.

除非另有說明，此報告結果僅對測試之樣品負責，同時此樣品僅保留90天。本報告未經本公司書面許可，不可部份複製。

This document is issued by the Company subject to its General Conditions of Service printed overleaf, available on request or accessible at <http://www.sgs.com.tw/Terms-and-Conditions> and for electronic format documents, subject to Terms and Conditions for Electronic Documents at <http://www.sgs.com.tw/Terms-and-Conditions>. Attention is drawn to the limitation of liability, indemnification and jurisdiction issues defined therein. Any holder of this document is advised that information contained hereon reflects the Company's findings at the time of its intervention only and within the limits of Client's instructions, if any. The Company's sole responsibility is to its Client and this document does not exonerate parties to a transaction from exercising all their rights and obligations under the transaction documents. This document cannot be reproduced except in full, without prior written approval of the Company. Any unauthorized alteration, forgery or falsification of the content or appearance of this document is unlawful and offenders may be prosecuted to the fullest extent of the law.

## Table of Contents

1	GENERAL INFORMATION.....	4
2	SYSTEM TEST CONFIGURATION .....	6
3	SUMMARY OF TEST RESULTS .....	9
4	DESCRIPTION OF TEST MODES.....	10
5	MEASUREMENT UNCERTAINTY.....	13
6	CONDUCTED EMISSION TEST .....	14
7	DUTY CYCLE OF TEST SIGNAL.....	18
8	PEAK OUTPUT POWER MEASUREMENT .....	20
9	6dB & 99% BANDWIDTH MEASUREMENT .....	23
10	CONDUCTED BAND EDGES AND SPURIOUS EMISSION MEASUREMENT .....	32
11	RADIATED BANEDGE AND SPURIOUS EMISSION MEASUREMENT.....	43
12	POWER SPECTRAL DENSITY .....	104
13	ANTENNA REQUIREMENT .....	110

Unless otherwise stated the results shown in this test report refer only to the sample(s) tested and such sample(s) are retained for 90 days only.

除非另有說明，此報告結果僅對測試之樣品負責，同時此樣品僅保留90天。本報告未經本公司書面許可，不可部份複製。

This document is issued by the Company subject to its General Conditions of Service printed overleaf, available on request or accessible at <http://www.sgs.com.tw/Terms-and-Conditions> and for electronic format documents, subject to Terms and Conditions for Electronic Documents at <http://www.sgs.com.tw/Terms-and-Conditions>. Attention is drawn to the limitation of liability, indemnification and jurisdiction issues defined therein. Any holder of this document is advised that information contained hereon reflects the Company's findings at the time of its intervention only and within the limits of Client's instructions, if any. The Company's sole responsibility is to its Client and this document does not exonerate parties to a transaction from exercising all their rights and obligations under the transaction documents. This document cannot be reproduced except in full, without prior written approval of the Company. Any unauthorized alteration, forgery or falsification of the content or appearance of this document is unlawful and offenders may be prosecuted to the fullest extent of the law.

## 1 GENERAL INFORMATION

### 1.1 Product description

Product Name:	Montblanc SUMMIT LITE	
Brand Name:	Montblanc	
Model No.:	SXL20	
Model Difference:	N/A	
USB Cable:	Model No.: SRB-A004, Supplier: Saibao(Jiangxi) Communication Industrial Co., Ltd.	
Cradle:	Model No.: SRB-A005A, Supplier: Saibao(Jiangxi) Communication Industrial Co., Ltd.	
Power Supply:	3.85Vdc from rechargeable Lithium polymer battery or 5Vdc from USB port	
	Battery:	Model No.: HAGP482427SD, Supplier: TIANJIN LISHEN BATTERY JOINT-STOCK CO., LTD.

Wi-Fi 802.11	Frequency Range	Channels	Rated Power (dBm)	Modulation Technology
b	2412-2472	13	17.94	DSSS,
g			19.34	OFDM
n_HT20			19.16(SISO)	
Modulation type:		CCK, DQPSK, DBPSK for DSSS 64QAM, 16QAM, QPSK, BPSK for OFDM		
Transistion Rate:		802.11 b: 1/2/5.5/11 Mbps 802.11 g: 6/9/12/18/24/36/48/54 Mbps 802.11 n_HT20MHz: 6.5 – 72.2 Mbps		

### 1.2 Antenna Designation

Antenna Type	Brand	Antenna Part No.	Freq. (MHz)	Peak An- tenna Gain (dBi)
Loop	INPAQ	23A1DBW3100	2402~2480	-3.91

Unless otherwise stated the results shown in this test report refer only to the sample(s) tested and such sample(s) are retained for 90 days only.

除非另有說明，此報告結果僅對測試之樣品負責，同時此樣品僅保留90天。本報告未經本公司書面許可，不可部份複製。

This document is issued by the Company subject to its General Conditions of Service printed overleaf, available on request or accessible at <http://www.sgs.com.tw/Terms-and-Conditions> and for electronic format documents, subject to Terms and Conditions for Electronic Documents at <http://www.sgs.com.tw/Terms-and-Conditions>. Attention is drawn to the limitation of liability, indemnification and jurisdiction issues defined therein. Any holder of this document is advised that information contained hereon reflects the Company's findings at the time of its intervention only and within the limits of Client's instructions, if any. The Company's sole responsibility is to its Client and this document does not exonerate parties to a transaction from exercising all their rights and obligations under the transaction documents. This document cannot be reproduced except in full, without prior written approval of the Company. Any unauthorized alteration, forgery or falsification of the content or appearance of this document is unlawful and offenders may be prosecuted to the fullest extent of the law.

### 1.3 Test Methodology of Applied Standards

FCC Part 15, Subpart C §15.247  
FCC KDB 558074 D01 15.247 Meas Guidance v05r02  
RSS-247 issue 2 Feb. 2017  
RSS-Gen. issue 5, Amendment 1, March 2019  
ANSI C63.10:2013

### 1.4 Test Facility

SGS Taiwan Ltd. Central RF Lab (TAF code 3702)  
No.134, Wu Kung Road, New Taipei Industrial Park, Wuku District, New Taipei City, Taiwan 24803  
FCC Designation number: TW0027  
ISED CAB identifier: TW3702

### 1.5 Special Accessories

There are no special accessories used while test was conducted.

### 1.6 Equipment Modifications

There was no modification incorporated into the EUT.

Unless otherwise stated the results shown in this test report refer only to the sample(s) tested and such sample(s) are retained for 90 days only.

除非另有說明，此報告結果僅對測試之樣品負責，同時此樣品僅保留90天。本報告未經本公司書面許可，不可部份複製。

This document is issued by the Company subject to its General Conditions of Service printed overleaf, available on request or accessible at <http://www.sgs.com.tw/Terms-and-Conditions> and for electronic format documents, subject to Terms and Conditions for Electronic Documents at <http://www.sgs.com.tw/Terms-and-Conditions>. Attention is drawn to the limitation of liability, indemnification and jurisdiction issues defined therein. Any holder of this document is advised that information contained hereon reflects the Company's findings at the time of its intervention only and within the limits of Client's instructions, if any. The Company's sole responsibility is to its Client and this document does not exonerate parties to a transaction from exercising all their rights and obligations under the transaction documents. This document cannot be reproduced except in full, without prior written approval of the Company. Any unauthorized alteration, forgery or falsification of the content or appearance of this document is unlawful and offenders may be prosecuted to the fullest extent of the law.

## 2 SYSTEM TEST CONFIGURATION

### 2.1 EUT Configuration

The EUT configuration for testing is installed on RF field strength measurement to meet the Commissions requirement and operating in a manner which intends to maximize its emission characteristics in a continuous normal application.

### 2.2 EUT Exercise

An engineering test mode (software/firmware) that applicant provided was utilized to manipulate the EUT into transmit, selection of the test channel, and modulation scheme.

### 2.3 Test Procedure

#### 2.3.1 Conducted Emissions

The EUT is placed on a table which is 0.8 m above ground plane. Conducted emissions from the EUT measured in the frequency range between 0.15 MHz and 30MHz. The CISPR Quasi-Peak and Average detector mode is employed. The two LISNs provide 50uH/50 ohm of coupling impedance for the measuring instrument. Both lines of the power mains connected to the EUT were checked for maximum conducted interference.

#### 2.3.2 Conducted Test (RF)

The active antenna port of the unlicensed wireless device is connected to the spectrum analyzer with attenuator to protect the instrumentation. If a second antenna port is available, it is tested at one operating frequency, with other port(s) appropriately terminated, to verify it has similar output characteristics as the fully tested port.

#### 2.3.3 Radiated Emissions

The EUT is placed on a turn table. For emissions testing at or below 1 GHz, the table height shall be 0.8 m above the reference ground plane. For emission measurements above 1 GHz, the table height shall be 1.5 m. The turn table shall rotate 360 degrees to determine the position of maximum emission level. EUT is set 3m away from the receiving antenna which varied from 1m to 4m to find out the highest emission. And also, each emission was to be maximized by changing the polarization of receiving antenna both horizontal and vertical. In order to find out the max. emission, the relative positions of this transmitter (EUT) was rotated through three orthogonal axes and measurement procedures for electric field radiated emissions above 1 GHz the EUT measurement is to be made "while keeping the antenna in the 'cone of radiation' from that area and pointed at the area both in azimuth and elevation, with polarization oriented for maximum response." is still within the 3dB illumination BW of the measurement antenna.

Unless otherwise stated the results shown in this test report refer only to the sample(s) tested and such sample(s) are retained for 90 days only.

除非另有說明，此報告結果僅對測試之樣品負責，同時此樣品僅保留90天。本報告未經本公司書面許可，不可部份複製。

This document is issued by the Company subject to its General Conditions of Service printed overleaf, available on request or accessible at <http://www.sgs.com.tw/Terms-and-Conditions> and for electronic format documents, subject to Terms and Conditions for Electronic Documents at <http://www.sgs.com.tw/Terms-and-Conditions>. Attention is drawn to the limitation of liability, indemnification and jurisdiction issues defined therein. Any holder of this document is advised that information contained hereon reflects the Company's findings at the time of its intervention only and within the limits of Client's instructions, if any. The Company's sole responsibility is to its Client and this document does not exonerate parties to a transaction from exercising all their rights and obligations under the transaction documents. This document cannot be reproduced except in full, without prior written approval of the Company. Any unauthorized alteration, forgery or falsification of the content or appearance of this document is unlawful and offenders may be prosecuted to the fullest extent of the law.

## 2.4 Measurement Results Explanation Example

### 2.4.1 Radiated Emission Test Sites For Measurements From 9 kHz To 30 MHz

Radiated emission below 30MHz is measured in a 9m\*9m\*6m semi-anechoic chamber, the measurements correspond to those obtained at an open-field test site.

There is a comparison data of both open-field test site and semi-Anechoic chamber, and the result came out very similar.

### 2.4.2 For all conducted test items:

The offset level is set in the spectrum analyzer to compensate the RF cable loss and attenuation factor between EUT conducted port and spectrum analyzer. With the offset compensation, the spectrum analyzer reading level is exactly EUT RF output level.

Unless otherwise stated the results shown in this test report refer only to the sample(s) tested and such sample(s) are retained for 90 days only.

除非另有說明，此報告結果僅對測試之樣品負責，同時此樣品僅保留90天。本報告未經本公司書面許可，不可部份複製。

This document is issued by the Company subject to its General Conditions of Service printed overleaf, available on request or accessible at <http://www.sgs.com.tw/Terms-and-Conditions> and for electronic format documents, subject to Terms and Conditions for Electronic Documents at <http://www.sgs.com.tw/Terms-and-Conditions>. Attention is drawn to the limitation of liability, indemnification and jurisdiction issues defined therein. Any holder of this document is advised that information contained hereon reflects the Company's findings at the time of its intervention only and within the limits of Client's instructions, if any. The Company's sole responsibility is to its Client and this document does not exonerate parties to a transaction from exercising all their rights and obligations under the transaction documents. This document cannot be reproduced except in full, without prior written approval of the Company. Any unauthorized alteration, forgery or falsification of the content or appearance of this document is unlawful and offenders may be prosecuted to the fullest extent of the law.

## 2.5 Configuration of Tested System

Fig. 2-1 Radiated Emission & Conducted (AC powerline) configuration

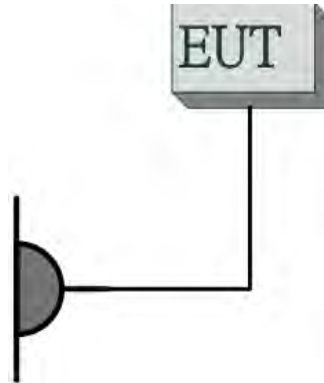

Fig. 2-2 Conducted (Antenna Port) Configuration Emission

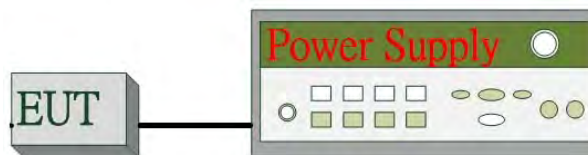

Table 2-1 Equipment Used in Tested System

Item	Equipment	Mfr/Brand	Model/Type No.	Series No.	Data Cable	Power Cord
1.	WLAN Test Software	N/A	N/A	N/A	N/A	N/A
2.	DC Power Supply	Agilent	E3640A	MY40005907	N/A	N/A
3.	Adapter	Apple	A1385	N/A	N/A	N/A

Unless otherwise stated the results shown in this test report refer only to the sample(s) tested and such sample(s) are retained for 90 days only.

除非另有說明，此報告結果僅對測試之樣品負責，同時此樣品僅保留90天。本報告未經本公司書面許可，不可部份複製。

This document is issued by the Company subject to its General Conditions of Service printed overleaf, available on request or accessible at <http://www.sgs.com.tw/Terms-and-Conditions> and for electronic format documents, subject to Terms and Conditions for Electronic Documents at <http://www.sgs.com.tw/Terms-and-Conditions>. Attention is drawn to the limitation of liability, indemnification and jurisdiction issues defined therein. Any holder of this document is advised that information contained hereon reflects the Company's findings at the time of its intervention only and within the limits of Client's instructions, if any. The Company's sole responsibility is to its Client and this document does not exonerate parties to a transaction from exercising all their rights and obligations under the transaction documents. This document cannot be reproduced except in full, without prior written approval of the Company. Any unauthorized alteration, forgery or falsification of the content or appearance of this document is unlawful and offenders may be prosecuted to the fullest extent of the law.



### 3 SUMMARY OF TEST RESULTS

FCC Rules	IC Rules	Description Of Test	Result
§15.207(a)	RSS-Gen §8.8	AC Power Line Conducted Emission	Compliant
§15.247(b) (3)	RSS-247 §5.4 d	Peak Output Power	Compliant
§15.247(a)(2)	RSS-247 §5.1 a RSS-Gen §6.7	6dB & 99% Emission Bandwidth	Compliant
§15.205 §15.209 §15.247(d)	RSS-247 §5.5 RSS-Gen §8.10	Conducted Band Edge and Spurious Emission	Compliant
§15.205 §15.209 §15.247(d)	RSS-247 §5.5 RSS-Gen §8.9 RSS-Gen §8.10 RSS-Gen §6.13	Radiated Band Edge and Spurious Emission	Compliant
§15.247(e)	RSS-247 §5.2 b	Power Spectral Density	Compliant
§15.203 §15.247(b)	RSS- Gen §6.8	Antenna Requirement	Compliant

Unless otherwise stated the results shown in this test report refer only to the sample(s) tested and such sample(s) are retained for 90 days only.

除非另有說明，此報告結果僅對測試之樣品負責，同時此樣品僅保留90天。本報告未經本公司書面許可，不可部份複製。

This document is issued by the Company subject to its General Conditions of Service printed overleaf, available on request or accessible at <http://www.sgs.com.tw/Terms-and-Conditions> and for electronic format documents, subject to Terms and Conditions for Electronic Documents at <http://www.sgs.com.tw/Terms-and-Conditions>. Attention is drawn to the limitation of liability, indemnification and jurisdiction issues defined therein. Any holder of this document is advised that information contained hereon reflects the Company's findings at the time of its intervention only and within the limits of Client's instructions, if any. The Company's sole responsibility is to its Client and this document does not exonerate parties to a transaction from exercising all their rights and obligations under the transaction documents. This document cannot be reproduced except in full, without prior written approval of the Company. Any unauthorized alteration, forgery or falsification of the content or appearance of this document is unlawful and offenders may be prosecuted to the fullest extent of the law.

## 4 DESCRIPTION OF TEST MODES

### 4.1 Operated in 2400 ~ 2483.5MHz Band

13 channels are provided for 802.11b/g/n 20M.

CHANNEL	FREQUENCY (MHz)
1	2412
2	2417
3	2422
4	2427
5	2432
6	2437
7	2442
8	2447
9	2452
10	2457
11	2462
12	2467
13	2472

Note: EUT serial number is MGHL02702.

Unless otherwise stated the results shown in this test report refer only to the sample(s) tested and such sample(s) are retained for 90 days only.

除非另有說明，此報告結果僅對測試之樣品負責，同時此樣品僅保留90天。本報告未經本公司書面許可，不可部份複製。

This document is issued by the Company subject to its General Conditions of Service printed overleaf, available on request or accessible at <http://www.sgs.com.tw/Terms-and-Conditions> and for electronic format documents, subject to Terms and Conditions for Electronic Documents at <http://www.sgs.com.tw/Terms-and-Conditions>. Attention is drawn to the limitation of liability, indemnification and jurisdiction issues defined therein. Any holder of this document is advised that information contained hereon reflects the Company's findings at the time of its intervention only and within the limits of Client's instructions, if any. The Company's sole responsibility is to its Client and this document does not exonerate parties to a transaction from exercising all their rights and obligations under the transaction documents. This document cannot be reproduced except in full, without prior written approval of the Company. Any unauthorized alteration, forgery or falsification of the content or appearance of this document is unlawful and offenders may be prosecuted to the fullest extent of the law.

#### 4.2 The Worst Test Modes and Channel Details

1. The EUT has been tested under operating condition.
2. Test program used to control the EUT for staying in continuous transmitting and receiving mode is programmed.
3. Investigation has been done on all the possible configurations for searching the worst case.  
The gevin UE is pre-scanned among below modes.

Modulation	Transmission Chain				Single	Multiple
					Transmission	Transmission
					Spatial	Spatial
<input checked="" type="checkbox"/> 802.11 b	<input checked="" type="checkbox"/> Ch0	<input type="checkbox"/> Ch1	<input type="checkbox"/> Ch2	<input type="checkbox"/> Ch3	<input checked="" type="checkbox"/> 1TX	<input type="checkbox"/> 2TX
<input checked="" type="checkbox"/> 802.11 g	<input checked="" type="checkbox"/> Ch0	<input type="checkbox"/> Ch1	<input type="checkbox"/> Ch2	<input type="checkbox"/> Ch3	<input checked="" type="checkbox"/> 1TX	<input type="checkbox"/> 2TX
<input checked="" type="checkbox"/> 802.11 n	<input checked="" type="checkbox"/> Ch0	<input type="checkbox"/> Ch1	<input type="checkbox"/> Ch2	<input type="checkbox"/> Ch3	<input checked="" type="checkbox"/> SISO	<input type="checkbox"/> MIMO

4. Therefore, below summary is the modes of test configuration that yield the highest reading and generate the highest emission chosen to carry out the relevantly mandatory test items.

Unless otherwise stated the results shown in this test report refer only to the sample(s) tested and such sample(s) are retained for 90 days only.

除非另有說明，此報告結果僅對測試之樣品負責，同時此樣品僅保留90天。本報告未經本公司書面許可，不可部份複製。

This document is issued by the Company subject to its General Conditions of Service printed overleaf, available on request or accessible at <http://www.sgs.com.tw/Terms-and-Conditions> and for electronic format documents, subject to Terms and Conditions for Electronic Documents at <http://www.sgs.com.tw/Terms-and-Conditions>. Attention is drawn to the limitation of liability, indemnification and jurisdiction issues defined therein. Any holder of this document is advised that information contained hereon reflects the Company's findings at the time of its intervention only and within the limits of Client's instructions, if any. The Company's sole responsibility is to its Client and this document does not exonerate parties to a transaction from exercising all their rights and obligations under the transaction documents. This document cannot be reproduced except in full, without prior written approval of the Company. Any unauthorized alteration, forgery or falsification of the content or appearance of this document is unlawful and offenders may be prosecuted to the fullest extent of the law.

#### 4.3 Radiated Emission Test:

MODE	AVAILABLE CHANNEL	TESTED CHANNEL	MODULATION	DATA RATE (Mbps)	ANTENNA PORT
<b>RADIATED EMISSION TEST (BELOW 1 GHz)</b>					
802.11g	1 to 13	6	OFDM	6	Ch0
<b>RADIATED EMISSION TEST (ABOVE 1 GHz)</b>					
802.11b	1 to 13	1, 6, 11, 12, 13	DSSS	1	Ch0
802.11g	1 to 13	1, 6, 11, 12, 13	OFDM	6	Ch0
802.11n 20M	1 to 13	1, 6, 11, 12, 13	OFDM	MCS 0	SISO

**Note:**

The field strength of radiation emission was measured as EUT stand-up position (H mode) and lie down position (E1, E2 mode) for 802.11b/g/n WLAN Transmitter for channel Low, Mid and High, the worst case H position was reported.

#### 4.4 Antenna Port Conducted Measurement:

<b>CONDUCTED TEST</b>					
MODE	AVAILABLE CHANNEL	TESTED CHANNEL	MODULATION	DATA RATE (Mbps)	ANTENNA PORT
802.11b	1 to 13	1, 6, 11, 12, 13	DSSS	1	Ch0
802.11g	1 to 13	1, 6, 11, 12, 13	OFDM	6	Ch0
802.11n 20M	1 to 13	1, 6, 11, 12, 13	OFDM	MCS 0	SISO

Unless otherwise stated the results shown in this test report refer only to the sample(s) tested and such sample(s) are retained for 90 days only.

除非另有說明，此報告結果僅對測試之樣品負責，同時此樣品僅保留90天。本報告未經本公司書面許可，不可部份複製。

This document is issued by the Company subject to its General Conditions of Service printed overleaf, available on request or accessible at <http://www.sgs.com.tw/Terms-and-Conditions> and for electronic format documents, subject to Terms and Conditions for Electronic Documents at <http://www.sgs.com.tw/Terms-and-Conditions>. Attention is drawn to the limitation of liability, indemnification and jurisdiction issues defined therein. Any holder of this document is advised that information contained hereon reflects the Company's findings at the time of its intervention only and within the limits of Client's instructions, if any. The Company's sole responsibility is to its Client and this document does not exonerate parties to a transaction from exercising all their rights and obligations under the transaction documents. This document cannot be reproduced except in full, without prior written approval of the Company. Any unauthorized alteration, forgery or falsification of the content or appearance of this document is unlawful and offenders may be prosecuted to the fullest extent of the law.

## 5 MEASUREMENT UNCERTAINTY

Test Items	Uncertainty
AC Power Line Conducted Emission	+/- 2.586 dB
Peak Output Power	+/- 0.84 dB
6dB Bandwidth	+/- 51.33 Hz
100 KHz Bandwidth Of Frequency Band Edges	+/- 0.84 dB
Peak Power Density	+/- 1.3 dB
Temperature	+/- 0.65 °C
Humidity	+/- 4.6 %
DC / AC Power Source	DC= +/- 0.13%, AC= +/- 0.2%

Radiated Spurious Emission Measurement Uncertainty	
<b>Polarization: Vertical</b>	9kHz~30MHz: +2.3dB
	30MHz - 180MHz: +/- 3.37dB
	180MHz -417MHz: +/- 3.19dB
	0.417GHz-1GHz: +/- 3.19dB
	1GHz - 18GHz: +/- 4.04dB
	18GHz - 40GHz: +/- 4.04dB
<b>Polarization: Horizontal</b>	9kHz~30MHz: +2.3dB
	30MHz - 167MHz: +/- 4.22dB
	167MHz -500MHz: +/- 3.44dB
	0.5GHz-1GHz: +/- 3.39dB
	1GHz - 18GHz: +/- 4.08dB
	18GHz - 40GHz: +/- 4.08dB

### Note:

1. This uncertainty represents an expanded uncertainty expressed at approximately the 95% confidence level using a coverage factor of k=2.
2. The conformity assessment statement in this report is based solely on the test results, measurement uncertainty is excluded.

Unless otherwise stated the results shown in this test report refer only to the sample(s) tested and such sample(s) are retained for 90 days only.

除非另有說明，此報告結果僅對測試之樣品負責，同時此樣品僅保留90天。本報告未經本公司書面許可，不可部份複製。

This document is issued by the Company subject to its General Conditions of Service printed overleaf, available on request or accessible at <http://www.sgs.com.tw/Terms-and-Conditions> and for electronic format documents, subject to Terms and Conditions for Electronic Documents at <http://www.sgs.com.tw/Terms-and-Conditions>. Attention is drawn to the limitation of liability, indemnification and jurisdiction issues defined therein. Any holder of this document is advised that information contained hereon reflects the Company's findings at the time of its intervention only and within the limits of Client's instructions, if any. The Company's sole responsibility is to its Client and this document does not exonerate parties to a transaction from exercising all their rights and obligations under the transaction documents. This document cannot be reproduced except in full, without prior written approval of the Company. Any unauthorized alteration, forgery or falsification of the content or appearance of this document is unlawful and offenders may be prosecuted to the fullest extent of the law.

## 6 CONDUCTED EMISSION TEST

### 6.1 Standard Applicable

Frequency range within 150kHz to 30MHz shall not exceed the Limit table as below.

Frequency range MHz	Limits dB(uV)	
	Quasi-peak	Average
0.15 to 0.50	66 to 56	56 to 46
0.50 to 5	56	46
5 to 30	60	50

Note

- The lower limit shall apply at the transition frequencies
- The limit decreases linearly with the logarithm of the frequency in the range 0.15 MHz to 0.50 MHz.

### 6.2 Measurement Equipment Used

Conducted Emission Test Site					
EQUIPMENT TYPE	MFR	MODEL NUMBER	SERIAL NUMBER	LAST CAL.	CAL DUE.
EMI Test Receiver	R&S	ESCI 7	100759	07/13/2020	07/12/2021
LISN	SCHWARZ-BECK	NSLK 8127	8127-465	04/09/2020	04/08/2021
Coaxial Cables	N/A	Coaxial Cable	161207	12/07/2019	12/06/2020
Test Software	audix	e3	Ver. 6.11-20180413	N.C.R	N.C.R

### 6.3 EUT Setup

- The conducted emission tests were performed in the test site, using the setup in accordance with the ANSI 63.10:2013.
- The AC/DC Power adaptor of EUT was plug-in LISN. The EUT was placed flushed with the rear of the table.
- The LISN was connected with 120Vac/60Hz power source.

Unless otherwise stated the results shown in this test report refer only to the sample(s) tested and such sample(s) are retained for 90 days only.

除非另有說明，此報告結果僅對測試之樣品負責，同時此樣品僅保留90天。本報告未經本公司書面許可，不可部份複製。

This document is issued by the Company subject to its General Conditions of Service printed overleaf, available on request or accessible at <http://www.sgs.com.tw/Terms-and-Conditions> and for electronic format documents, subject to Terms and Conditions for Electronic Documents at <http://www.sgs.com.tw/Terms-and-Conditions>. Attention is drawn to the limitation of liability, indemnification and jurisdiction issues defined therein. Any holder of this document is advised that information contained hereon reflects the Company's findings at the time of its intervention only and within the limits of Client's instructions, if any. The Company's sole responsibility is to its Client and this document does not exonerate parties to a transaction from exercising all their rights and obligations under the transaction documents. This document cannot be reproduced except in full, without prior written approval of the Company. Any unauthorized alteration, forgery or falsification of the content or appearance of this document is unlawful and offenders may be prosecuted to the fullest extent of the law.

## 6.4 Test SET-UP (Block Diagram of Configuration)

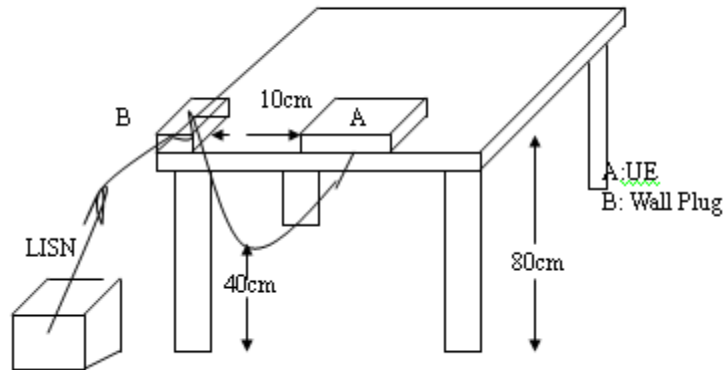

## 6.5 Measurement Procedure

1. The EUT was placed on a table which is 0.8m above ground plane.
2. Maximum procedure was performed on the six highest emissions to ensure EUT compliance.
3. Repeat above procedures until all phases of power being supplied by given UE are completed

## 6.6 Measurement Result

Note: Refer to next page for measurement data and plots.

Note2: The \* reveals the worst-case results that closet to the limit.

Unless otherwise stated the results shown in this test report refer only to the sample(s) tested and such sample(s) are retained for 90 days only.

除非另有說明，此報告結果僅對測試之樣品負責，同時此樣品僅保留90天。本報告未經本公司書面許可，不可部份複製。

This document is issued by the Company subject to its General Conditions of Service printed overleaf, available on request or accessible at <http://www.sgs.com.tw/Terms-and-Conditions> and for electronic format documents, subject to Terms and Conditions for Electronic Documents at <http://www.sgs.com.tw/Terms-and-Conditions>. Attention is drawn to the limitation of liability, indemnification and jurisdiction issues defined therein. Any holder of this document is advised that information contained hereon reflects the Company's findings at the time of its intervention only and within the limits of Client's instructions, if any. The Company's sole responsibility is to its Client and this document does not exonerate parties to a transaction from exercising all their rights and obligations under the transaction documents. This document cannot be reproduced except in full, without prior written approval of the Company. Any unauthorized alteration, forgery or falsification of the content or appearance of this document is unlawful and offenders may be prosecuted to the fullest extent of the law.

## AC POWER LINE CONDUCTED EMISSION TEST DATA

Report Number :ER-2020-70076  
 Test Mode :WLAN 2.4G  
 Power :AC 120V/60Hz  
 Probe :L  
 Note :

Test Site :Conduction 6F  
 Test Date :2020-08-13  
 Temp./Humi. :25.3/56  
 Engineer :Neo

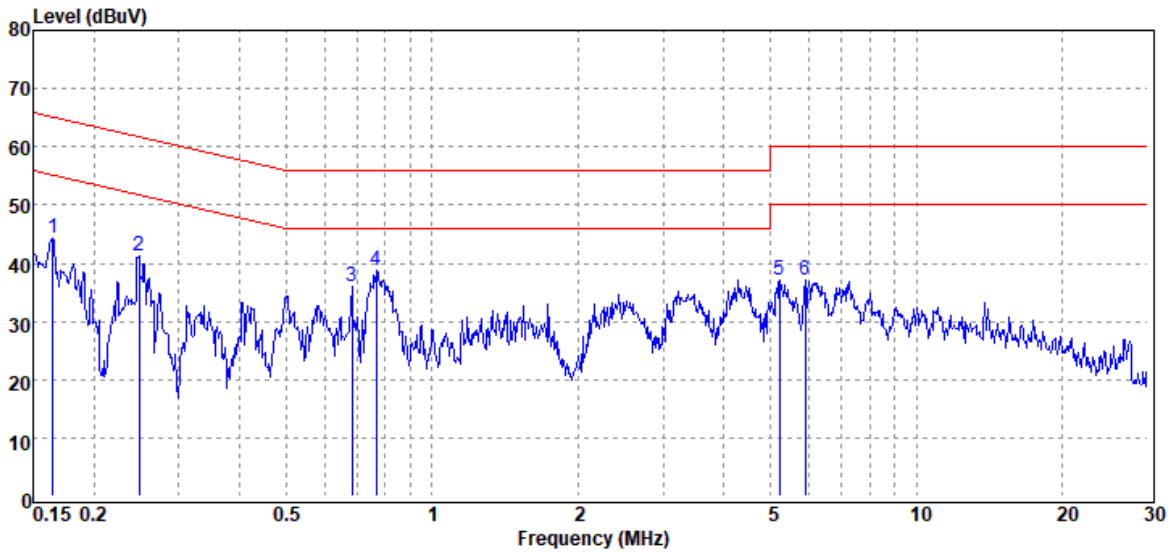

Freq. MHz	Detector Mode PK/QP/AV	Spectrum Reading Level dBμV	Factor dB	Actual FS dBμV	Limit dBμV	Margin dB
0.17	Peak	42.19	2.14	44.33	65.21	-20.88
0.25	Peak	39.15	2.14	41.29	61.82	-20.53
0.68	Peak	33.84	2.17	36.01	56.00	-19.99
0.77	Peak	36.64	2.17	38.81	56.00	-17.19
5.22	Peak	34.52	2.56	37.08	60.00	-22.92
5.90	Peak	34.59	2.61	37.20	60.00	-22.80

Unless otherwise stated the results shown in this test report refer only to the sample(s) tested and such sample(s) are retained for 90 days only.

除非另有說明，此報告結果僅對測試之樣品負責，同時此樣品僅保留90天。本報告未經本公司書面許可，不可部份複製。

This document is issued by the Company subject to its General Conditions of Service printed overleaf, available on request or accessible at <http://www.sgs.com.tw/Terms-and-Conditions> and for electronic format documents, subject to Terms and Conditions for Electronic Documents at <http://www.sgs.com.tw/Terms-and-Conditions>. Attention is drawn to the limitation of liability, indemnification and jurisdiction issues defined therein. Any holder of this document is advised that information contained hereon reflects the Company's findings at the time of its intervention only and within the limits of Client's instructions, if any. The Company's sole responsibility is to its Client and this document does not exonerate parties to a transaction from exercising all their rights and obligations under the transaction documents. This document cannot be reproduced except in full, without prior written approval of the Company. Any unauthorized alteration, forgery or falsification of the content or appearance of this document is unlawful and offenders may be prosecuted to the fullest extent of the law.



Report Number :ER-2020-70076  
 Test Mode :WLAN 2.4G  
 Power :AC 120V/60Hz  
 Probe :N  
 Note: :

Test Site :Conduction 6F  
 Test Date :2020-08-13  
 Temp./Humi. :25.3/56  
 Engineer :Neo

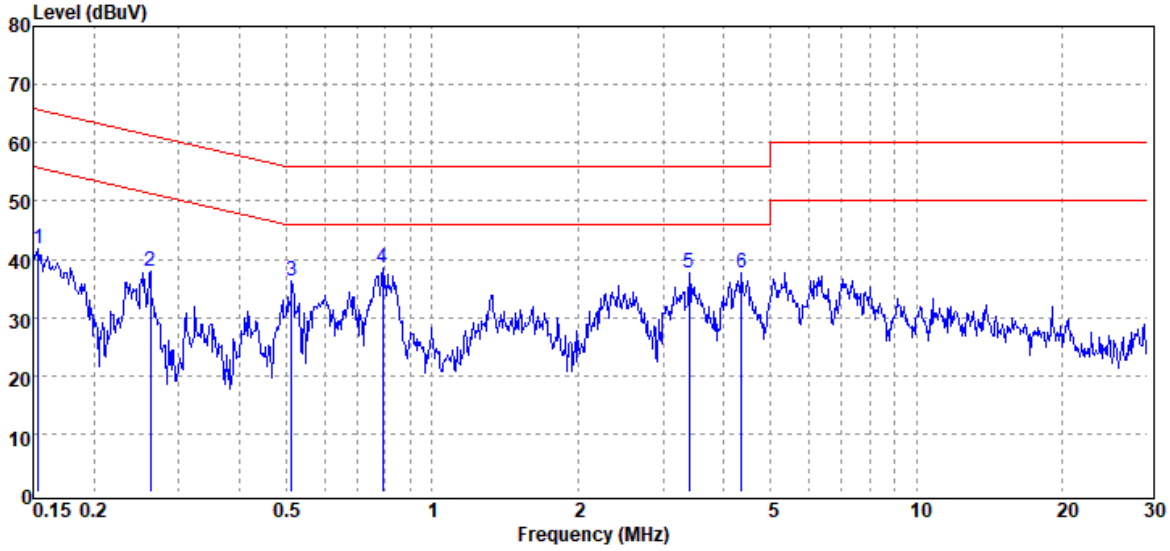

Freq. MHz	Detector Mode	Spectrum Reading Level dB $\mu$ V	Factor dB	Actual FS dB $\mu$ V	Limit dB $\mu$ V	Margin dB
0.15	Peak	39.72	2.21	41.93	65.78	-23.85
0.26	Peak	35.79	2.21	38.00	61.38	-23.38
0.51	Peak	33.94	2.22	36.16	56.00	-19.84
0.79	Peak	36.25	2.24	38.49	56.00	-17.51
3.40	Peak	35.25	2.38	37.63	56.00	-18.37
4.36	Peak	35.28	2.43	37.71	56.00	-18.29

Unless otherwise stated the results shown in this test report refer only to the sample(s) tested and such sample(s) are retained for 90 days only.

除非另有說明，此報告結果僅對測試之樣品負責，同時此樣品僅保留90天。本報告未經本公司書面許可，不可部份複製。

This document is issued by the Company subject to its General Conditions of Service printed overleaf, available on request or accessible at <http://www.sgs.com.tw/Terms-and-Conditions> and for electronic format documents, subject to Terms and Conditions for Electronic Documents at <http://www.sgs.com.tw/Terms-and-Conditions>. Attention is drawn to the limitation of liability, indemnification and jurisdiction issues defined therein. Any holder of this document is advised that information contained hereon reflects the Company's findings at the time of its intervention only and within the limits of Client's instructions, if any. The Company's sole responsibility is to its Client and this document does not exonerate parties to a transaction from exercising all their rights and obligations under the transaction documents. This document cannot be reproduced except in full, without prior written approval of the Company. Any unauthorized alteration, forgery or falsification of the content or appearance of this document is unlawful and offenders may be prosecuted to the fullest extent of the law.

## 7 DUTY CYCLE OF TEST SIGNAL

Pre-analysis Check: While conducting average power measurement, duty cycle of each mode shall be checked to ensure its duty cycle in order to compensate for the loss due to insufficient ratio of duty cycle. All duty cycle is pre-scanned, and result as obtained below shows only the most representative ones where duty cycle is conducted as the given transmission with given virtual operation that expresses the percentage.

### 7.1 Measurement Procedure:

1. Set span = Zero
2. RBW = 8MHz
3. VBW = 8MHz,
4. Detector = Peak

### 7.2 Duty Cycle:

	Duty Cycle (%) = Ton / (Ton+Toff)	Duty Factor (dB) =10*log ( 1/Duty Cycle )	1/T (kHz)	VBW setting (kHz)
802.11b	97.63	0.10	0.12	1.00
802.11g	87.32	0.59	0.73	1.00
802.11n_20	86.51	0.63	0.78	1.00

$b = 97.63\%$ ,  $g = 87.32\%$ ,  $n\_ht\_20 = 86.51\%$

Unless otherwise stated the results shown in this test report refer only to the sample(s) tested and such sample(s) are retained for 90 days only.

除非另有說明，此報告結果僅對測試之樣品負責，同時此樣品僅保留90天。本報告未經本公司書面許可，不可部份複製。

This document is issued by the Company subject to its General Conditions of Service printed overleaf, available on request or accessible at <http://www.sgs.com.tw/Terms-and-Conditions> and for electronic format documents, subject to Terms and Conditions for Electronic Documents at <http://www.sgs.com.tw/Terms-and-Conditions>. Attention is drawn to the limitation of liability, indemnification and jurisdiction issues defined therein. Any holder of this document is advised that information contained hereon reflects the Company's findings at the time of its intervention only and within the limits of Client's instructions, if any. The Company's sole responsibility is to its Client and this document does not exonerate parties to a transaction from exercising all their rights and obligations under the transaction documents. This document cannot be reproduced except in full, without prior written approval of the Company. Any unauthorized alteration, forgery or falsification of the content or appearance of this document is unlawful and offenders may be prosecuted to the fullest extent of the law.

### 7.3 Duty Cycle test plots

802.11 b mode



802.11 n HT20 mode



802.11 g mode



Unless otherwise stated the results shown in this test report refer only to the sample(s) tested and such sample(s) are retained for 90 days only.

除非另有說明，此報告結果僅對測試之樣品負責，同時此樣品僅保留90天。本報告未經本公司書面許可，不可部份複製。

This document is issued by the Company subject to its General Conditions of Service printed overleaf, available on request or accessible at <http://www.sgs.com.tw/Terms-and-Conditions> and for electronic format documents, subject to Terms and Conditions for Electronic Documents at <http://www.sgs.com.tw/Terms-and-Conditions>. Attention is drawn to the limitation of liability, indemnification and jurisdiction issues defined therein. Any holder of this document is advised that information contained hereon reflects the Company's findings at the time of its intervention only and within the limits of Client's instructions, if any. The Company's sole responsibility is to its Client and this document does not exonerate parties to a transaction from exercising all their rights and obligations under the transaction documents. This document cannot be reproduced except in full, without prior written approval of the Company. Any unauthorized alteration, forgery or falsification of the content or appearance of this document is unlawful and offenders may be prosecuted to the fullest extent of the law.

## 8 PEAK OUTPUT POWER MEASUREMENT

### 8.1 Standard Applicable

For systems using digital modulation in the 2400-2483.5 MHz bands, the limit for peak output power is 1Watt.

If the transmitting antenna of directional gain greater than 6dBi are used the peak output power from the intentional radiator shall be reduced below the above stated value by the amount in dB that the directional gain of the Antenna exceeds 6dBi.

In case of point-to-point operation, the limit has to be reduced by 1dB for every 3dB that the directional gain of Antenna exceeds 6dBi.

The antenna gain is not grater than 6 dBi. Therefore, reduction of power is not required.

### 8.2 Measurement Equipment Used

Conducted Emission Test Site					
EQUIPMENT TYPE	MFR	MODEL NUMBER	SERIAL NUMBER	LAST CAL.	CAL DUE.
Power Sensor	Agilent	U2021X	MY53480015	04/22/2020	04/21/2021
Power Sensor	Agilent	U2021X	MY53480018	04/22/2020	04/21/2021
Power Sensor	Agilent	U2021X	MY53480009	04/22/2020	04/21/2021
DC Power Supply	Agilent	E3640A	MY40005907	10/22/2019	10/21/2020
Attenuator	Mini-Circuit	BW-S10W2+	2	01/02/2020	01/01/2021

### 8.3 Test Set-up

Power Meter:

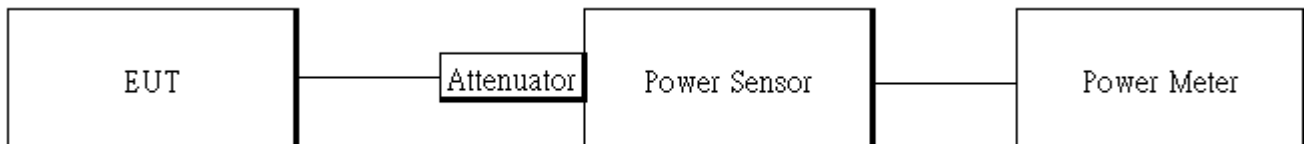

Unless otherwise stated the results shown in this test report refer only to the sample(s) tested and such sample(s) are retained for 90 days only.

除非另有說明，此報告結果僅對測試之樣品負責，同時此樣品僅保留90天。本報告未經本公司書面許可，不可部份複製。

This document is issued by the Company subject to its General Conditions of Service printed overleaf, available on request or accessible at <http://www.sgs.com.tw/Terms-and-Conditions> and for electronic format documents, subject to Terms and Conditions for Electronic Documents at <http://www.sgs.com.tw/Terms-and-Conditions>. Attention is drawn to the limitation of liability, indemnification and jurisdiction issues defined therein. Any holder of this document is advised that information contained hereon reflects the Company's findings at the time of its intervention only and within the limits of Client's instructions, if any. The Company's sole responsibility is to its Client and this document does not exonerate parties to a transaction from exercising all their rights and obligations under the transaction documents. This document cannot be reproduced except in full, without prior written approval of the Company. Any unauthorized alteration, forgery or falsification of the content or appearance of this document is unlawful and offenders may be prosecuted to the fullest extent of the law.

## 8.4 Measurement Procedure

1. Place the EUT on the table and set it in transmitting mode.
2. The testing follows the Measurement Procedure of FCC KDB 558074 D01 DTS Meas. Guidance .
3. Remove the antenna from the EUT and then connect a low loss RF cable from the antenna port to the power meter.

### Power Meter:

It is used as the auxiliary test equipment to conduct the output power measurement.

4. Record the max. Reading as observed from Spectrum or Power Meter.

**\* Note: The duty cycle factor is compensated to obtain the maximum value of measurement in average.**

## 8.5 Measurement Result

802.11b Ch0					
CH	Freq. (MHz)	Data Rate	Peak Output Power (dBm)	Limit (dBm)	RESULT
1	2412	1	17.83	30.00	PASS
6	2437	1	17.93	30.00	PASS
11	2462	1	17.49	30.00	PASS
12	2467	1	17.74	30.00	PASS
13	2472	1	17.94	30.00	PASS
802.11b Ch0					
CH	Freq. (MHz)	Data Rate	Max. Avg. Output include tune up tolerance Power (dBm)	Limit (dBm)	RESULT
1	2412	1	14.98	30.00	PASS
6	2437	1	14.89	30.00	PASS
11	2462	1	14.76	30.00	PASS
12	2467	1	14.99	30.00	PASS
13	2472	1	14.96	30.00	PASS

Unless otherwise stated the results shown in this test report refer only to the sample(s) tested and such sample(s) are retained for 90 days only.

除非另有說明，此報告結果僅對測試之樣品負責，同時此樣品僅保留90天。本報告未經本公司書面許可，不可部份複製。

This document is issued by the Company subject to its General Conditions of Service printed overleaf, available on request or accessible at <http://www.sgs.com.tw/Terms-and-Conditions> and for electronic format documents, subject to Terms and Conditions for Electronic Documents at <http://www.sgs.com.tw/Terms-and-Conditions>. Attention is drawn to the limitation of liability, indemnification and jurisdiction issues defined therein. Any holder of this document is advised that information contained hereon reflects the Company's findings at the time of its intervention only and within the limits of Client's instructions, if any. The Company's sole responsibility is to its Client and this document does not exonerate parties to a transaction from exercising all their rights and obligations under the transaction documents. This document cannot be reproduced except in full, without prior written approval of the Company. Any unauthorized alteration, forgery or falsification of the content or appearance of this document is unlawful and offenders may be prosecuted to the fullest extent of the law.

802.11g Ch0					
CH	Freq. (MHz)	Data Rate	Peak Output Power (dBm)	Limit (dBm)	RESULT
1	2412	6	18.78	30.00	PASS
6	2437	6	19.09	30.00	PASS
11	2462	6	18.78	30.00	PASS
12	2467	6	19.34	30.00	PASS
13	2472	6	13.69	30.00	PASS
802.11g Ch0					
CH	Freq. (MHz)	Data Rate	Max. Avg. Output include tune up tolerance Power (dBm)	Limit (dBm)	RESULT
1	2412	6	9.88	30.00	PASS
6	2437	6	9.99	30.00	PASS
11	2462	6	9.55	30.00	PASS
12	2467	6	9.70	30.00	PASS
13	2472	6	3.92	30.00	PASS

802.11n_HT20M Ch0					
CH	Freq. (MHz)	Data Rate	Peak Output Power (dBm)	Limit (dBm)	RESULT
1	2412	MCS0	19.16	30.00	PASS
6	2437	MCS0	18.98	30.00	PASS
11	2462	MCS0	18.87	30.00	PASS
12	2467	MCS0	18.92	30.00	PASS
13	2472	MCS0	13.73	30.00	PASS
802.11n_HT20M Ch0					
CH	Freq. (MHz)	Data Rate	Max. Avg. Output include tune up tolerance Power (dBm)	Limit (dBm)	RESULT
1	2412	MCS0	9.99	30.00	PASS
6	2437	MCS0	9.95	30.00	PASS
11	2462	MCS0	9.68	30.00	PASS
12	2467	MCS0	9.90	30.00	PASS
13	2472	MCS0	3.97	30.00	PASS

**\* Note: The duty cycle factor is compensated to obtain the maximum value of measurement in average.**

Unless otherwise stated the results shown in this test report refer only to the sample(s) tested and such sample(s) are retained for 90 days only.

除非另有說明，此報告結果僅對測試之樣品負責，同時此樣品僅保留90天。本報告未經本公司書面許可，不可部份複製。

This document is issued by the Company subject to its General Conditions of Service printed overleaf, available on request or accessible at <http://www.sgs.com.tw/Terms-and-Conditions> and for electronic format documents, subject to Terms and Conditions for Electronic Documents at <http://www.sgs.com.tw/Terms-and-Conditions>. Attention is drawn to the limitation of liability, indemnification and jurisdiction issues defined therein. Any holder of this document is advised that information contained hereon reflects the Company's findings at the time of its intervention only and within the limits of Client's instructions, if any. The Company's sole responsibility is to its Client and this document does not exonerate parties to a transaction from exercising all their rights and obligations under the transaction documents. This document cannot be reproduced except in full, without prior written approval of the Company. Any unauthorized alteration, forgery or falsification of the content or appearance of this document is unlawful and offenders may be prosecuted to the fullest extent of the law.

## 9 6DB & 99% BANDWIDTH MEASUREMENT

### 9.1 Standard Applicable

The minimum 6 dB bandwidth shall be at least 500 kHz.

### 9.2 Measurement Equipment Used

Conducted Emission Test Site					
EQUIPMENT TYPE	MFR	MODEL NUMBER	SERIAL NUMBER	LAST CAL.	CAL DUE.
EXA Spectrum Analyzer	Agilent	N9010A	MY50420195	05/06/2020	05/05/2021
DC Power Supply	Agilent	E3640A	MY40005907	10/22/2019	10/21/2020
Attenuator	Mini-Circuit	BW-S10W2+	2	01/02/2020	01/01/2021
DC Block	Mini-Circuits	BLK-18-S+	1	01/02/2020	01/01/2021

### 9.3 Test Set-up

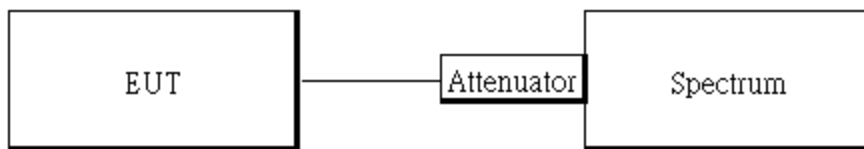

### 9.4 Measurement Procedure

1. Place the EUT on the table and set it in transmitting mode.
2. The testing follows the Measurement Procedure of FCC KDB 558074 D01 DTS Meas. Guidance .
3. Remove the antenna from the EUT and then connect a low loss RF cable from the antenna port to the spectrum analyzer.
4. Set the spectrum analyzer as  
RBW= 1 % to 5% of OBW ,  
VBW = 3 X RBW,  
Span= 2 to 5 times of the OBW,  
Sweep=auto,  
Detector = Peak, and Max hold for 20dB Bandwidth test.
5. Mark the peak frequency and -20dB (upper and lower) frequency
6. Set the spectrum analyzer as  
RBW= 1 % to 5% of 99% Bandwidth ,  
VBW ≥ 3 X RBW,  
Span= large enough to capture all products of the modulation process,  
Sweep=auto,  
Detector = Peak, and Max hold for 99% Bandwidth test.
7. Turn on the 99% bandwidth function, max reading.
8. Repeat above procedures until all test default channel is completed

Unless otherwise stated the results shown in this test report refer only to the sample(s) tested and such sample(s) are retained for 90 days only.

除非另有說明，此報告結果僅對測試之樣品負責，同時此樣品僅保留90天。本報告未經本公司書面許可，不可部份複製。

This document is issued by the Company subject to its General Conditions of Service printed overleaf, available on request or accessible at <http://www.sgs.com.tw/Terms-and-Conditions> and for electronic format documents, subject to Terms and Conditions for Electronic Documents at <http://www.sgs.com.tw/Terms-and-Conditions>. Attention is drawn to the limitation of liability, indemnification and jurisdiction issues defined therein. Any holder of this document is advised that information contained hereon reflects the Company's findings at the time of its intervention only and within the limits of Client's instructions, if any. The Company's sole responsibility is to its Client and this document does not exonerate parties to a transaction from exercising all their rights and obligations under the transaction documents. This document cannot be reproduced except in full, without prior written approval of the Company. Any unauthorized alteration, forgery or falsification of the content or appearance of this document is unlawful and offenders may be prosecuted to the fullest extent of the law.

## 9.5 6dB Bandwidth

### 802.11b Ch0

Freq. (MHz)	6dB BW (kHz)	Limit (kHz)	Result
2412	<b>9061</b>	> 500	PASS
2437	8599	> 500	PASS
2462	8575	> 500	PASS
2467	8577	> 500	PASS
2472	<b>9032</b>	> 500	PASS

### 802.11g Ch0

Freq. (MHz)	6dB BW (kHz)	Limit (kHz)	Result
2412	16410	> 500	PASS
2437	<b>16440</b>	> 500	PASS
2462	16420	> 500	PASS
2467	16430	> 500	PASS
2472	16420	> 500	PASS

### 802.11\_n\_HT20 Ch0

Freq. (MHz)	6dB BW (kHz)	Limit (kHz)	Result
2412	17620	> 500	PASS
2437	17620	> 500	PASS
2462	<b>17630</b>	> 500	PASS
2467	17610	> 500	PASS
2472	17610	> 500	PASS

*\*Refer to next page for plots*

Unless otherwise stated the results shown in this test report refer only to the sample(s) tested and such sample(s) are retained for 90 days only.  
除非另有說明，此報告結果僅對測試之樣品負責，同時此樣品僅保留90天。本報告未經本公司書面許可，不可部份複製。

This document is issued by the Company subject to its General Conditions of Service printed overleaf, available on request or accessible at <http://www.sgs.com.tw/Terms-and-Conditions> and for electronic format documents, subject to Terms and Conditions for Electronic Documents at <http://www.sgs.com.tw/Terms-and-Conditions>. Attention is drawn to the limitation of liability, indemnification and jurisdiction issues defined therein. Any holder of this document is advised that information contained hereon reflects the Company's findings at the time of its intervention only and within the limits of Client's instructions, if any. The Company's sole responsibility is to its Client and this document does not exonerate parties to a transaction from exercising all their rights and obligations under the transaction documents. This document cannot be reproduced except in full, without prior written approval of the Company. Any unauthorized alteration, forgery or falsification of the content or appearance of this document is unlawful and offenders may be prosecuted to the fullest extent of the law.



OBW 6dB\_802.11b\_20MHz\_Chain0\_2412MHz

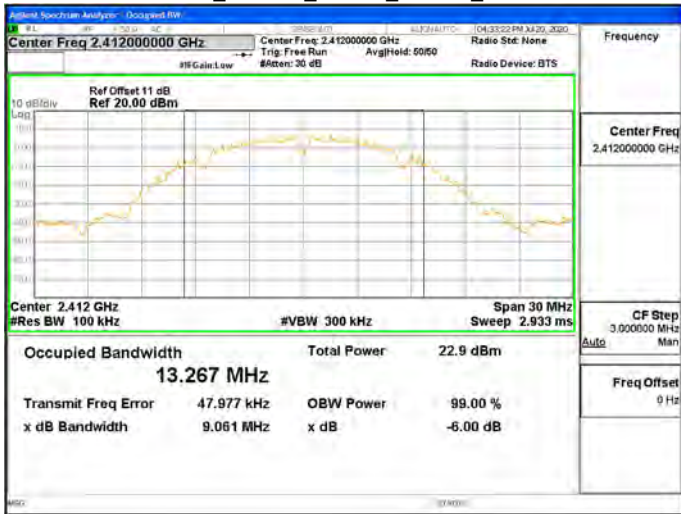

OBW 6dB\_802.11b\_20MHz\_Chain0\_2467MHz

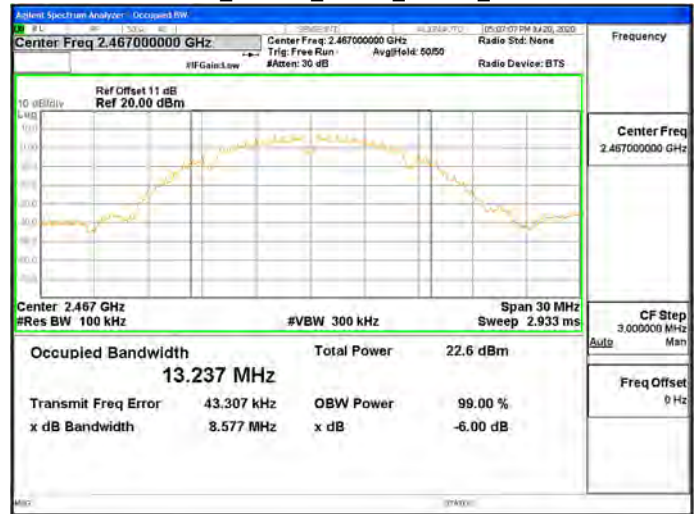

OBW 6dB\_802.11b\_20MHz\_Chain0\_2437MHz



OBW 6dB\_802.11b\_20MHz\_Chain0\_2472MHz



OBW 6dB\_802.11b\_20MHz\_Chain0\_2462MHz

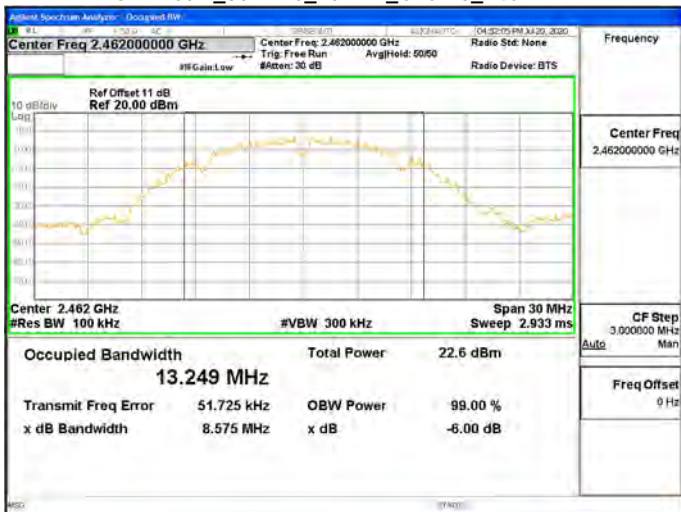

OBW 6dB\_802.11g\_20MHz\_Chain0\_2412MHz



Unless otherwise stated the results shown in this test report refer only to the sample(s) tested and such sample(s) are retained for 90 days only.

除非另有說明，此報告結果僅對測試之樣品負責，同時此樣品僅保留90天。本報告未經本公司書面許可，不可份複製。

This document is issued by the Company subject to its General Conditions of Service printed overleaf, available on request or accessible at <http://www.sgs.com.tw/Terms-and-Conditions> and for electronic format documents, subject to Terms and Conditions for Electronic Documents at <http://www.sgs.com.tw/Terms-and-Conditions>. Attention is drawn to the limitation of liability, indemnification and jurisdiction issues defined therein. Any holder of this document is advised that information contained hereon reflects the Company's findings at the time of its intervention only and within the limits of Client's instructions, if any. The Company's sole responsibility is to its Client and this document does not exonerate parties to a transaction from exercising all their rights and obligations under the transaction documents. This document cannot be reproduced except in full, without prior written approval of the Company. Any unauthorized alteration, forgery or falsification of the content or appearance of this document is unlawful and offenders may be prosecuted to the fullest extent of the law.

OBW 6dB\_802.11g\_20MHz\_Chain0\_2437MHz

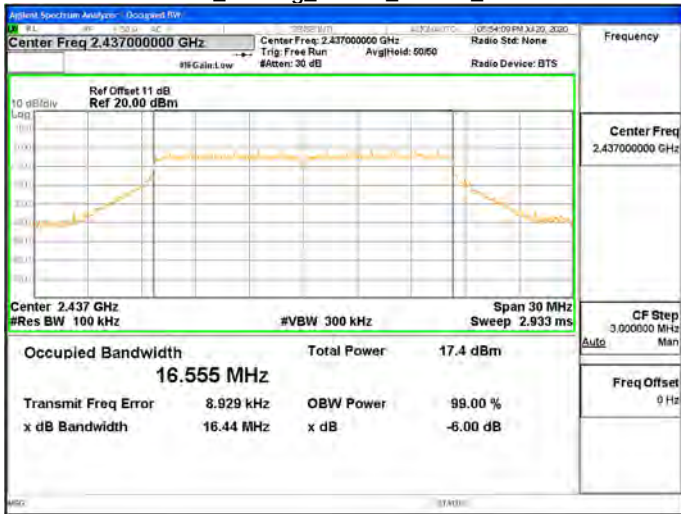

OBW 6dB\_802.11g\_20MHz\_Chain0\_2472MHz

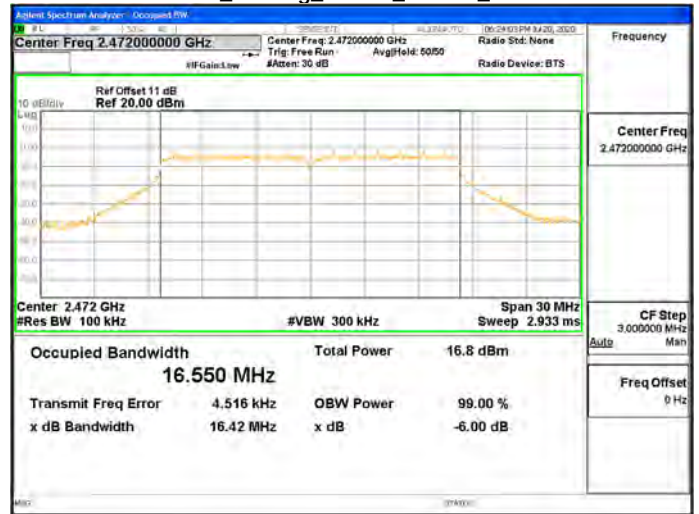

OBW 6dB\_802.11g\_20MHz\_Chain0\_2462MHz



OBW 6dB\_802.11n\_20MHz\_Chain0\_2412MHz



OBW 6dB\_802.11g\_20MHz\_Chain0\_2467MHz



OBW 6dB\_802.11n\_20MHz\_Chain0\_2437MHz



Unless otherwise stated the results shown in this test report refer only to the sample(s) tested and such sample(s) are retained for 90 days only.

除非另有說明，此報告結果僅對測試之樣品負責，同時此樣品僅保留90天。本報告未經本公司書面許可，不可部份複製。

This document is issued by the Company subject to its General Conditions of Service printed overleaf, available on request or accessible at <http://www.sgs.com.tw/Terms-and-Conditions> and for electronic format documents, subject to Terms and Conditions for Electronic Documents at <http://www.sgs.com.tw/Terms-and-Conditions>. Attention is drawn to the limitation of liability, indemnification and jurisdiction issues defined therein. Any holder of this document is advised that information contained hereon reflects the Company's findings at the time of its intervention only and within the limits of Client's instructions, if any. The Company's sole responsibility is to its Client and this document does not exonerate parties to a transaction from exercising all their rights and obligations under the transaction documents. This document cannot be reproduced except in full, without prior written approval of the Company. Any unauthorized alteration, forgery or falsification of the content or appearance of this document is unlawful and offenders may be prosecuted to the fullest extent of the law.

OBW 6dB\_802.11n\_20MHz\_Chain0\_2462MHz

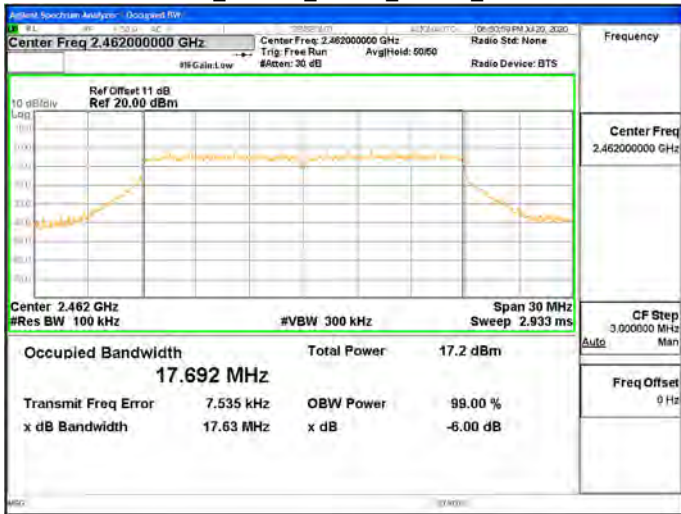

OBW 6dB\_802.11n\_20MHz\_Chain0\_2467MHz



OBW 6dB\_802.11n\_20MHz\_Chain0\_2472MHz



Unless otherwise stated the results shown in this test report refer only to the sample(s) tested and such sample(s) are retained for 90 days only.

除非另有說明，此報告結果僅對測試之樣品負責，同時此樣品僅保留90天。本報告未經本公司書面許可，不可部份複製。

This document is issued by the Company subject to its General Conditions of Service printed overleaf, available on request or accessible at <http://www.sgs.com.tw/Terms-and-Conditions> and for electronic format documents, subject to Terms and Conditions for Electronic Documents at <http://www.sgs.com.tw/Terms-and-Conditions>. Attention is drawn to the limitation of liability, indemnification and jurisdiction issues defined therein. Any holder of this document is advised that information contained hereon reflects the Company's findings at the time of its intervention only and within the limits of Client's instructions, if any. The Company's sole responsibility is to its Client and this document does not exonerate parties to a transaction from exercising all their rights and obligations under the transaction documents. This document cannot be reproduced except in full, without prior written approval of the Company. Any unauthorized alteration, forgery or falsification of the content or appearance of this document is unlawful and offenders may be prosecuted to the fullest extent of the law.

## 9.6 99% Bandwidth

802.11b Ch0	
Freq. (MHz)	99% BW (MHz)
2412	13.297
2437	<b>13.323</b>
2462	13.284
2467	<b>13.281</b>
2472	13.27

802.11g Ch0	
Freq. (MHz)	99% BW (MHz)
2412	17.091
2437	<b>17.11</b>
2462	17.087
2467	<b>17.076</b>
2472	17.06

802.11n_HT20M Ch0	
Freq. (MHz)	99% BW (MHz)
2412	18.07
2437	18.07
2462	18.064
2467	<b>18.093</b>
2472	18.077

Unless otherwise stated the results shown in this test report refer only to the sample(s) tested and such sample(s) are retained for 90 days only.

除非另有說明，此報告結果僅對測試之樣品負責，同時此樣品僅保留90天。本報告未經本公司書面許可，不可部份複製。

This document is issued by the Company subject to its General Conditions of Service printed overleaf, available on request or accessible at <http://www.sgs.com.tw/Terms-and-Conditions> and for electronic format documents, subject to Terms and Conditions for Electronic Documents at <http://www.sgs.com.tw/Terms-and-Conditions>. Attention is drawn to the limitation of liability, indemnification and jurisdiction issues defined therein. Any holder of this document is advised that information contained hereon reflects the Company's findings at the time of its intervention only and within the limits of Client's instructions, if any. The Company's sole responsibility is to its Client and this document does not exonerate parties to a transaction from exercising all their rights and obligations under the transaction documents. This document cannot be reproduced except in full, without prior written approval of the Company. Any unauthorized alteration, forgery or falsification of the content or appearance of this document is unlawful and offenders may be prosecuted to the fullest extent of the law.

IC OBW 99%\_802.11b\_20MHz\_Chain0\_2412MHz

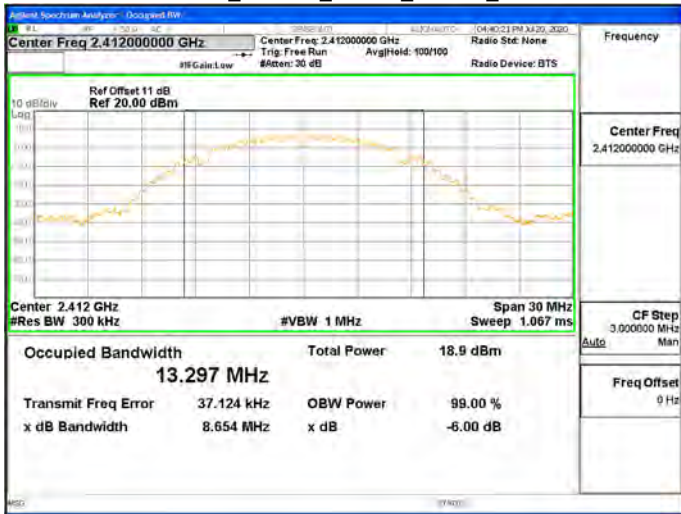

IC OBW 99%\_802.11b\_20MHz\_Chain0\_2467MHz

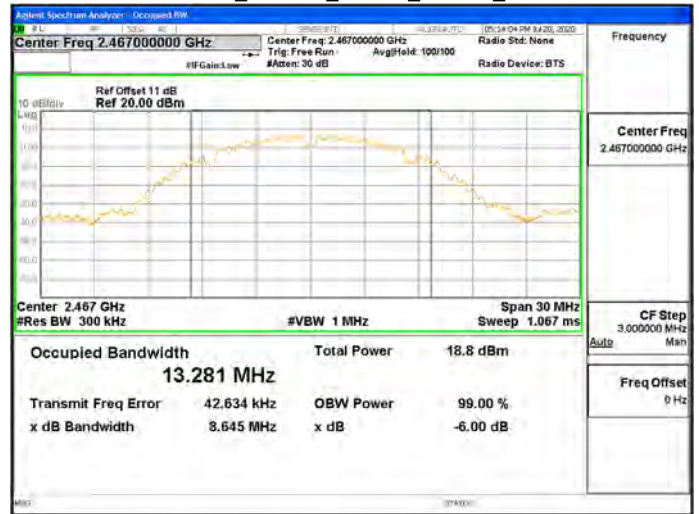

IC OBW 99%\_802.11b\_20MHz\_Chain0\_2437MHz

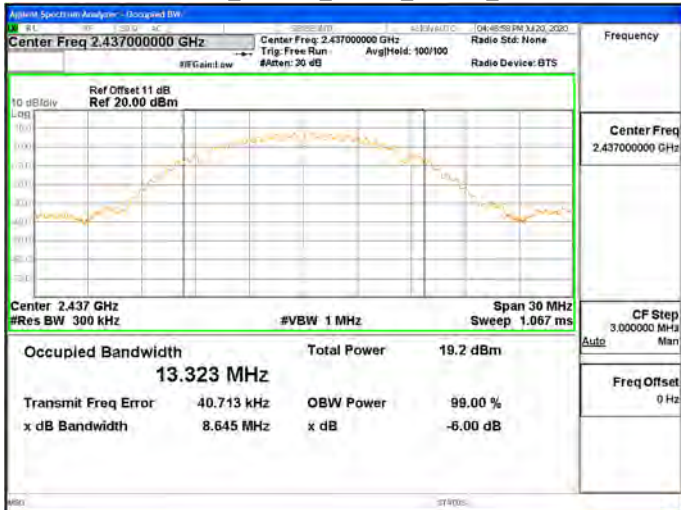

IC OBW 99%\_802.11b\_20MHz\_Chain0\_2472MHz

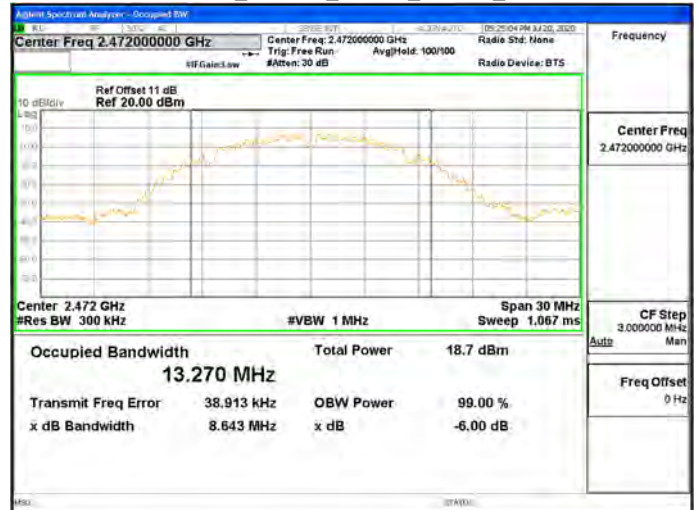

IC OBW 99%\_802.11b\_20MHz\_Chain0\_2462MHz

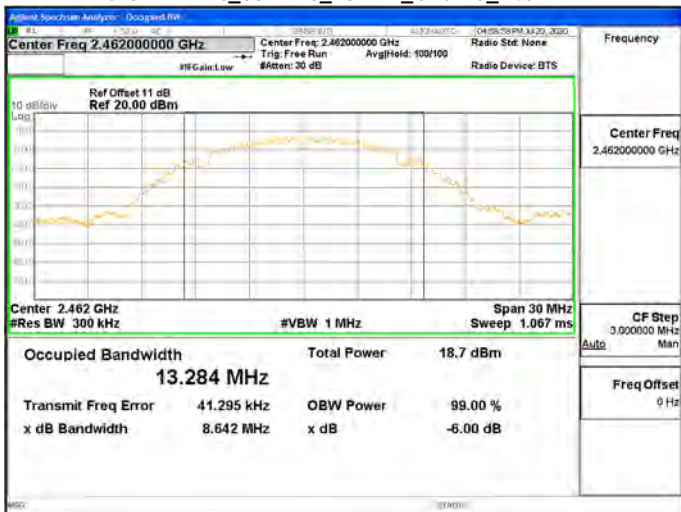

IC OBW 99%\_802.11g\_20MHz\_Chain0\_2412MHz



Unless otherwise stated the results shown in this test report refer only to the sample(s) tested and such sample(s) are retained for 90 days only.

除非另有說明，此報告結果僅對測試之樣品負責，同時此樣品僅保留90天。本報告未經本公司書面許可，不可份複製。

This document is issued by the Company subject to its General Conditions of Service printed overleaf, available on request or accessible at <http://www.sgs.com.tw/Terms-and-Conditions> and for electronic format documents, subject to Terms and Conditions for Electronic Documents at <http://www.sgs.com.tw/Terms-and-Conditions>. Attention is drawn to the limitation of liability, indemnification and jurisdiction issues defined therein. Any holder of this document is advised that information contained hereon reflects the Company's findings at the time of its intervention only and within the limits of Client's instructions, if any. The Company's sole responsibility is to its Client and this document does not exonerate parties to a transaction from exercising all their rights and obligations under the transaction documents. This document cannot be reproduced except in full, without prior written approval of the Company. Any unauthorized alteration, forgery or falsification of the content or appearance of this document is unlawful and offenders may be prosecuted to the fullest extent of the law.

IC OBW 99%\_802.11g\_20MHz\_Chain0\_2437MHz



IC OBW 99%\_802.11g\_20MHz\_Chain0\_2472MHz



IC OBW 99%\_802.11g\_20MHz\_Chain0\_2462MHz



IC OBW 99%\_802.11n\_20MHz\_Chain0\_2412MHz



IC OBW 99%\_802.11g\_20MHz\_Chain0\_2467MHz



IC OBW 99%\_802.11n\_20MHz\_Chain0\_2437MHz



Unless otherwise stated the results shown in this test report refer only to the sample(s) tested and such sample(s) are retained for 90 days only.

除非另有說明，此報告結果僅對測試之樣品負責，同時此樣品僅保留90天。本報告未經本公司書面許可，不可份複製。

This document is issued by the Company subject to its General Conditions of Service printed overleaf, available on request or accessible at <http://www.sgs.com.tw/Terms-and-Conditions> and for electronic format documents, subject to Terms and Conditions for Electronic Documents at <http://www.sgs.com.tw/Terms-and-Conditions>. Attention is drawn to the limitation of liability, indemnification and jurisdiction issues defined therein. Any holder of this document is advised that information contained hereon reflects the Company's findings at the time of its intervention only and within the limits of Client's instructions, if any. The Company's sole responsibility is to its Client and this document does not exonerate parties to a transaction from exercising all their rights and obligations under the transaction documents. This document cannot be reproduced except in full, without prior written approval of the Company. Any unauthorized alteration, forgery or falsification of the content or appearance of this document is unlawful and offenders may be prosecuted to the fullest extent of the law.

IC OBW 99%\_802.11n\_20MHz\_Chain0\_2462MHz



IC OBW 99%\_802.11n\_20MHz\_Chain0\_2467MHz



IC OBW 99%\_802.11n\_20MHz\_Chain0\_2472MHz



Unless otherwise stated the results shown in this test report refer only to the sample(s) tested and such sample(s) are retained for 90 days only.

除非另有說明，此報告結果僅對測試之樣品負責，同時此樣品僅保留90天。本報告未經本公司書面許可，不可部份複製。

This document is issued by the Company subject to its General Conditions of Service printed overleaf, available on request or accessible at <http://www.sgs.com.tw/Terms-and-Conditions> and for electronic format documents, subject to Terms and Conditions for Electronic Documents at <http://www.sgs.com.tw/Terms-and-Conditions>. Attention is drawn to the limitation of liability, indemnification and jurisdiction issues defined therein. Any holder of this document is advised that information contained hereon reflects the Company's findings at the time of its intervention only and within the limits of Client's instructions, if any. The Company's sole responsibility is to its Client and this document does not exonerate parties to a transaction from exercising all their rights and obligations under the transaction documents. This document cannot be reproduced except in full, without prior written approval of the Company. Any unauthorized alteration, forgery or falsification of the content or appearance of this document is unlawful and offenders may be prosecuted to the fullest extent of the law.

## 10 CONDUCTED BAND EDGES AND SPURIOUS EMISSION MEASUREMENT

### 10.1 Standard Applicable

In any 100 kHz bandwidth outside the frequency band in which the spread spectrum or digitally modulated intentional radiator is operating, the radio frequency power that is produced by the intentional radiator shall be at least 20 dB below that in the 100 kHz bandwidth within the band that contains the highest level of the desired power, based on either an RF conducted or a radiated measurement, provided the transmitter demonstrates compliance with the peak conducted power limits.

In addition, radiated emissions which fall in the restricted bands, as defined in §15.205(a) & RSS-Gen §8.10, must also comply with the radiated emission limits specified in §15.209(a) & RSS-Gen §8.9.

### 10.2 Measurement Equipment Used

Conducted Emission Test Site					
EQUIPMENT TYPE	MFR	MODEL NUMBER	SERIAL NUMBER	LAST CAL.	CAL DUE.
EXA Spectrum Analyzer	Agilent	N9010A	MY50420195	05/06/2020	05/05/2021
DC Power Supply	Agilent	E3640A	MY40005907	10/22/2019	10/21/2020
Attenuator	Mini-Circuit	BW-S10W2+	2	01/02/2020	01/01/2021
DC Block	Mini-Circuits	BLK-18-S+	1	01/02/2020	01/01/2021

### 10.3 Test SET-UP

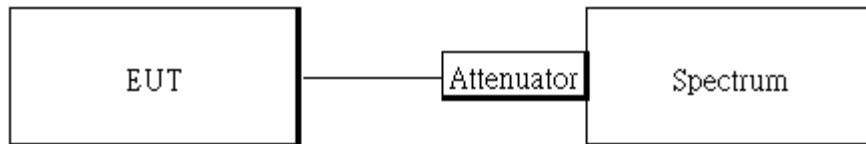

### 10.4 Measurement Procedure

Unless otherwise stated the results shown in this test report refer only to the sample(s) tested and such sample(s) are retained for 90 days only.

除非另有說明，此報告結果僅對測試之樣品負責，同時此樣品僅保留90天。本報告未經本公司書面許可，不可部份複製。

This document is issued by the Company subject to its General Conditions of Service printed overleaf, available on request or accessible at <http://www.sgs.com.tw/Terms-and-Conditions> and for electronic format documents, subject to Terms and Conditions for Electronic Documents at <http://www.sgs.com.tw/Terms-and-Conditions>. Attention is drawn to the limitation of liability, indemnification and jurisdiction issues defined therein. Any holder of this document is advised that information contained hereon reflects the Company's findings at the time of its intervention only and within the limits of Client's instructions, if any. The Company's sole responsibility is to its Client and this document does not exonerate parties to a transaction from exercising all their rights and obligations under the transaction documents. This document cannot be reproduced except in full, without prior written approval of the Company. Any unauthorized alteration, forgery or falsification of the content or appearance of this document is unlawful and offenders may be prosecuted to the fullest extent of the law.



**Reference Level of Emission Limit:**

1. Set analyzer center frequency to DTS channel center frequency.
2. The testing follows the Measurement Procedure of FCC KDB 558074 D01 DTS Meas. Guidance .
3. Set the span to 1.5 times the DTS channel bandwidth.
4. Set the RBW = 100kHz & VBW = 300 kHz.
5. Detector = peak.
6. Sweep time = auto couple.
7. Trace mode = max hold.
8. Allow trace to fully stabilize.
9. Use the peak marker function to determine the maximum amplitude level.

**Conducted Band Edge:**

1. To connect Antenna Port of EUT to Spectrum.
2. The testing follows the Measurement Procedure of FCC KDB 558074 D01 DTS Meas. Guidance .
3. Remove the antenna from the EUT and then connect a low loss RF cable from the antenna port to the spectrum analyzer.
4. Set start to edge frequency, and stop frequency of spectrum analyzer so as to encompass the spectrum to be examined.
5. Set the spectrum analyzer as RBW=100 kHz, VBW=300 kHz, Detector = Peak, Sweep = auto
6. Mark the highest reading of the emission as the reference level measurement.
7. Set DL as the limit = reading on marker 1 – 20dBm
8. Marker on frequency, 2.3999GHz and 2.4836GHz, and examine shall 100 kHz immediately outside the authorized (2400~2483.5) be attenuated by 20dB at least relative to the maximum emission of power.
9. Repeat above procedures until all default test channel (low, middle, and high) was complete.

Unless otherwise stated the results shown in this test report refer only to the sample(s) tested and such sample(s) are retained for 90 days only.  
除非另有說明，此報告結果僅對測試之樣品負責，同時此樣品僅保留90天。本報告未經本公司書面許可，不可部份複製。

This document is issued by the Company subject to its General Conditions of Service printed overleaf, available on request or accessible at <http://www.sgs.com.tw/Terms-and-Conditions> and for electronic format documents, subject to Terms and Conditions for Electronic Documents at <http://www.sgs.com.tw/Terms-and-Conditions>. Attention is drawn to the limitation of liability, indemnification and jurisdiction issues defined therein. Any holder of this document is advised that information contained hereon reflects the Company's findings at the time of its intervention only and within the limits of Client's instructions, if any. The Company's sole responsibility is to its Client and this document does not exonerate parties to a transaction from exercising all their rights and obligations under the transaction documents. This document cannot be reproduced except in full, without prior written approval of the Company. Any unauthorized alteration, forgery or falsification of the content or appearance of this document is unlawful and offenders may be prosecuted to the fullest extent of the law.

### Conducted Spurious Emission:

1. To connect Antenna Port of EUT to Spectrum
2. The testing follows the Measurement Procedure of FCC KDB 558074 D01 DTS Meas. Guidance .
3. Set RBW = 100 kHz & VBW= 300 kHz, Detector =Peak, Sweep = Auto.
4. Allow trace to fully stabilize.
5. Use the peak marker function to determine the maximum power level in any 100 kHz band segment within the fundamental EBW.
6. Repeat above procedures until all default test channel measured were complete.

### 10.5 Measurement Result

Reference Level of Limit 802.11b mode		
Freq. (MHz)	PSD (dBm)	Reference Level of Limit (dBm)
2412	6.89	-13.11
2437	7.24	-12.76
2462	6.89	-13.11
2467	6.93	-13.07
2472	6.97	-13.03

Reference Level of Limit 802.11g mode		
Freq. (MHz)	PSD (dBm)	Reference Level of Limit (dBm)
2412	-1.08	-21.08
2437	-0.78	-20.78
2462	-1.28	-21.28
2467	-1.08	-21.08
2472	-1.50	-21.50

Reference Level of Limit 802.11n20 mode		
Freq. (MHz)	PSD (dBm)	Reference Level of Limit (dBm)
2412	-0.80	-20.80
2437	-0.84	-20.84
2462	-1.17	-21.17
2467	-1.06	-21.06
2472	-1.36	-21.36

Unless otherwise stated the results shown in this test report refer only to the sample(s) tested and such sample(s) are retained for 90 days only.  
除非另有說明，此報告結果僅對測試之樣品負責，同時此樣品僅保留90天。本報告未經本公司書面許可，不可部份複製。

This document is issued by the Company subject to its General Conditions of Service printed overleaf, available on request or accessible at <http://www.sgs.com.tw/Terms-and-Conditions> and for electronic format documents, subject to Terms and Conditions for Electronic Documents at <http://www.sgs.com.tw/Terms-and-Conditions>. Attention is drawn to the limitation of liability, indemnification and jurisdiction issues defined therein. Any holder of this document is advised that information contained hereon reflects the Company's findings at the time of its intervention only and within the limits of Client's instructions, if any. The Company's sole responsibility is to its Client and this document does not exonerate parties to a transaction from exercising all their rights and obligations under the transaction documents. This document cannot be reproduced except in full, without prior written approval of the Company. Any unauthorized alteration, forgery or falsification of the content or appearance of this document is unlawful and offenders may be prosecuted to the fullest extent of the law.

Reference Level\_802.11b\_20MHz\_Chain0\_2412MHz

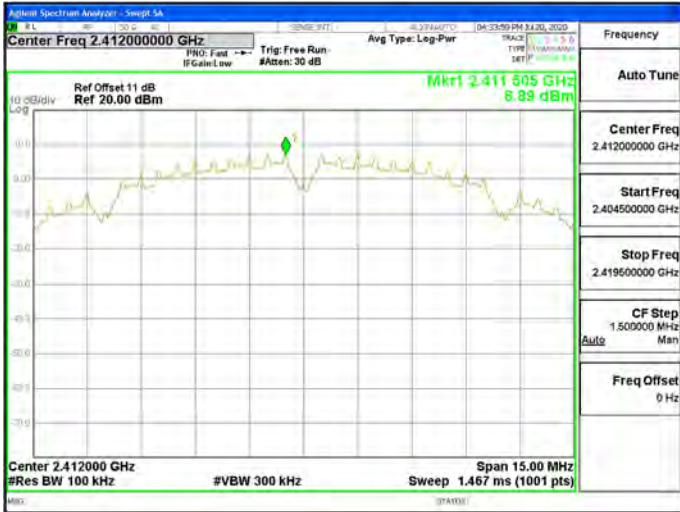

Reference Level\_802.11b\_20MHz\_Chain0\_2467MHz



Reference Level\_802.11b\_20MHz\_Chain0\_2437MHz

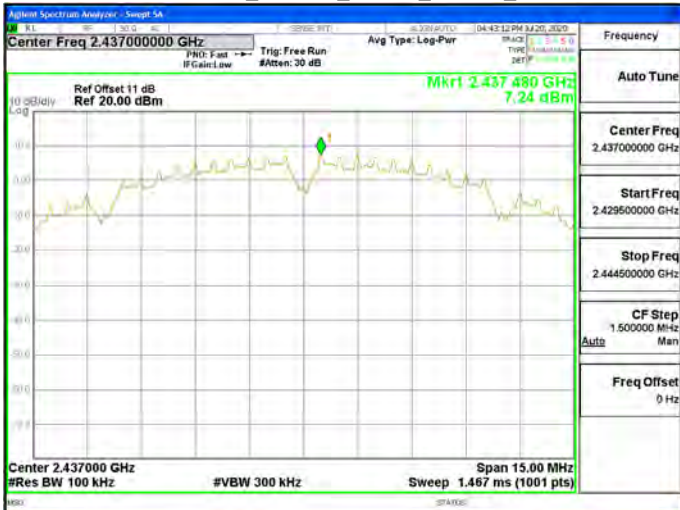

Reference Level\_802.11b\_20MHz\_Chain0\_2472MHz

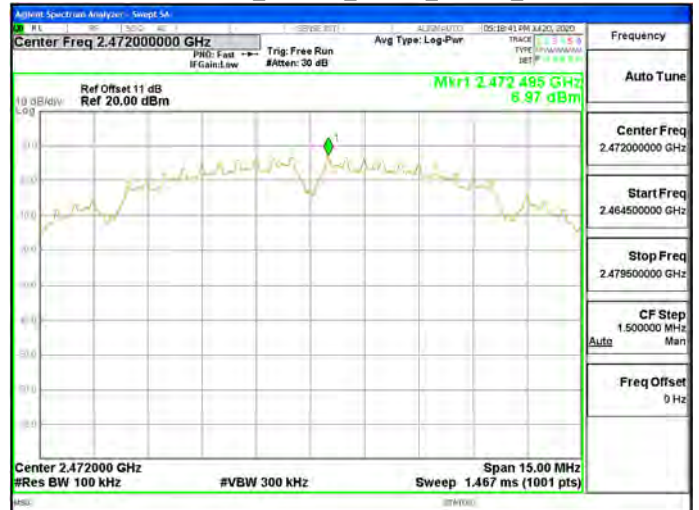

Reference Level\_802.11b\_20MHz\_Chain0\_2462MHz

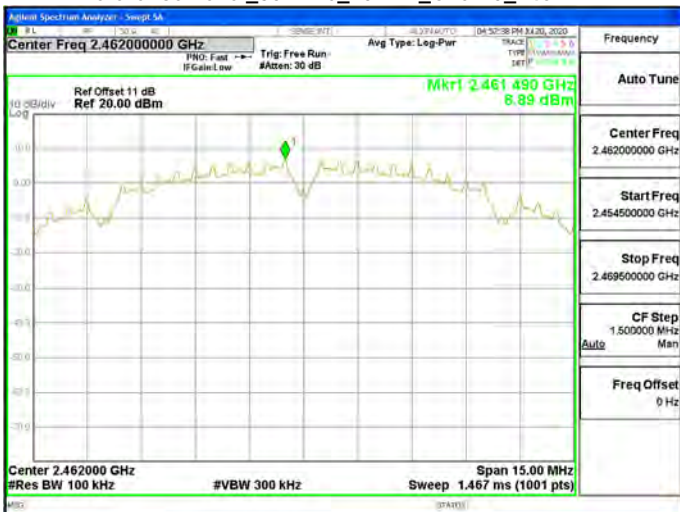

Reference Level\_802.11g\_20MHz\_Chain0\_2412MHz

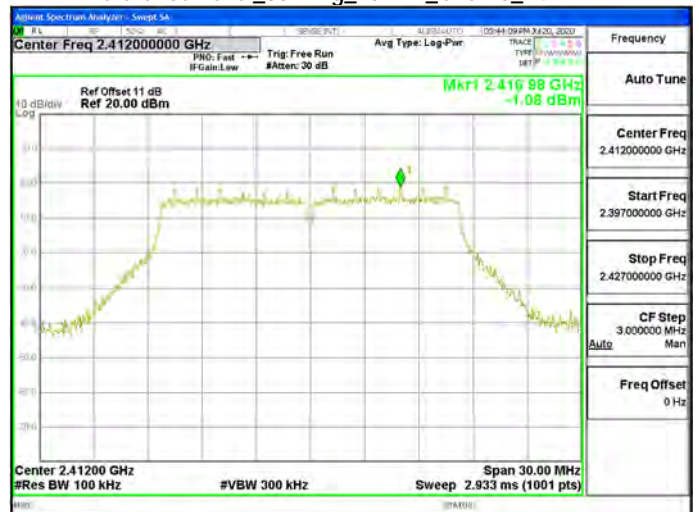

Unless otherwise stated the results shown in this test report refer only to the sample(s) tested and such sample(s) are retained for 90 days only.

除非另有說明，此報告結果僅對測試之樣品負責，同時此樣品僅保留90天。本報告未經本公司書面許可，不可部份複製。

This document is issued by the Company subject to its General Conditions of Service printed overleaf, available on request or accessible at <http://www.sgs.com.tw/Terms-and-Conditions> and for electronic format documents, subject to Terms and Conditions for Electronic Documents at <http://www.sgs.com.tw/Terms-and-Conditions>. Attention is drawn to the limitation of liability, indemnification and jurisdiction issues defined therein. Any holder of this document is advised that information contained hereon reflects the Company's findings at the time of its intervention only and within the limits of Client's instructions, if any. The Company's sole responsibility is to its Client and this document does not exonerate parties to a transaction from exercising all their rights and obligations under the transaction documents. This document cannot be reproduced except in full, without prior written approval of the Company. Any unauthorized alteration, forgery or falsification of the content or appearance of this document is unlawful and offenders may be prosecuted to the fullest extent of the law.

Reference Level\_802.11g\_20MHz\_Chain0\_2437MHz

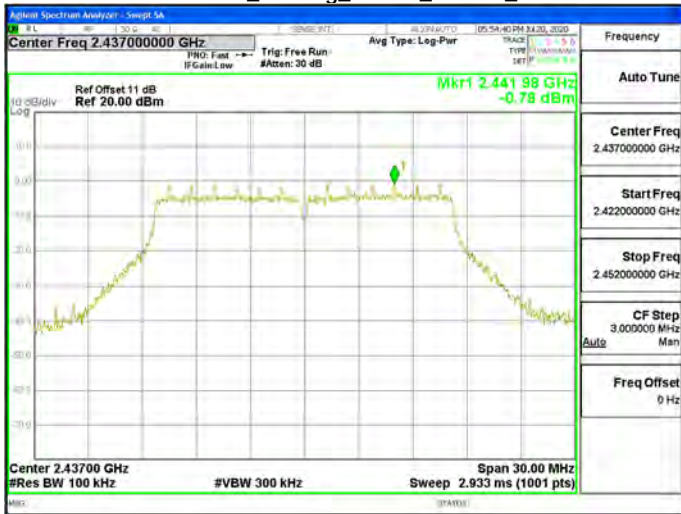

Reference Level\_802.11g\_20MHz\_Chain0\_2472MHz

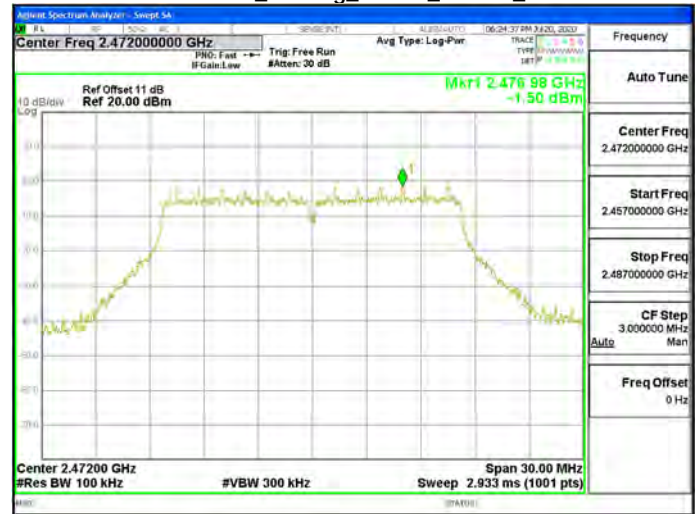

Reference Level\_802.11g\_20MHz\_Chain0\_2462MHz



Reference Level\_802.11n\_20MHz\_Chain0\_2412MHz



Reference Level\_802.11g\_20MHz\_Chain0\_2467MHz



Reference Level\_802.11n\_20MHz\_Chain0\_2437MHz



Unless otherwise stated the results shown in this test report refer only to the sample(s) tested and such sample(s) are retained for 90 days only.

除非另有說明，此報告結果僅對測試之樣品負責，同時此樣品僅保留90天。本報告未經本公司書面許可，不可部份複製。

This document is issued by the Company subject to its General Conditions of Service printed overleaf, available on request or accessible at <http://www.sgs.com.tw/Terms-and-Conditions> and for electronic format documents, subject to Terms and Conditions for Electronic Documents at <http://www.sgs.com.tw/Terms-and-Conditions>. Attention is drawn to the limitation of liability, indemnification and jurisdiction issues defined therein. Any holder of this document is advised that information contained hereon reflects the Company's findings at the time of its intervention only and within the limits of Client's instructions, if any. The Company's sole responsibility is to its Client and this document does not exonerate parties to a transaction from exercising all their rights and obligations under the transaction documents. This document cannot be reproduced except in full, without prior written approval of the Company. Any unauthorized alteration, forgery or falsification of the content or appearance of this document is unlawful and offenders may be prosecuted to the fullest extent of the law.

Reference Level\_802.11n\_20MHz\_Chain0\_2462MHz

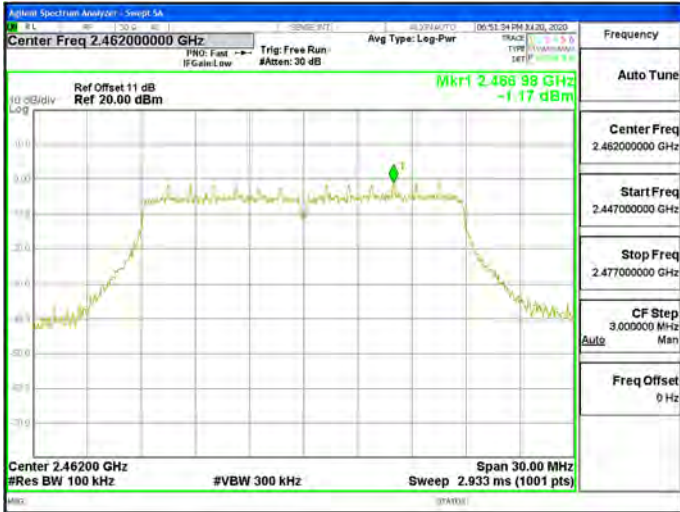

Reference Level\_802.11n\_20MHz\_Chain0\_2467MHz

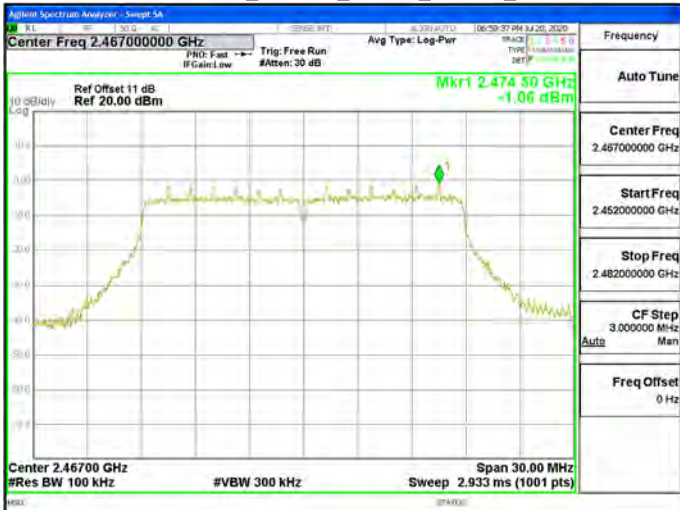

Reference Level\_802.11n\_20MHz\_Chain0\_2472MHz



Unless otherwise stated the results shown in this test report refer only to the sample(s) tested and such sample(s) are retained for 90 days only.

除非另有說明，此報告結果僅對測試之樣品負責，同時此樣品僅保留90天。本報告未經本公司書面許可，不可部份複製。

This document is issued by the Company subject to its General Conditions of Service printed overleaf, available on request or accessible at <http://www.sgs.com.tw/Terms-and-Conditions> and for electronic format documents, subject to Terms and Conditions for Electronic Documents at <http://www.sgs.com.tw/Terms-and-Conditions>. Attention is drawn to the limitation of liability, indemnification and jurisdiction issues defined therein. Any holder of this document is advised that information contained hereon reflects the Company's findings at the time of its intervention only and within the limits of Client's instructions, if any. The Company's sole responsibility is to its Client and this document does not exonerate parties to a transaction from exercising all their rights and obligations under the transaction documents. This document cannot be reproduced except in full, without prior written approval of the Company. Any unauthorized alteration, forgery or falsification of the content or appearance of this document is unlawful and offenders may be prosecuted to the fullest extent of the law.

Band Edge\_802.11b\_20MHz\_Chain0\_2412MHz



Band Edge\_802.11b\_20MHz\_Chain0\_2472MHz

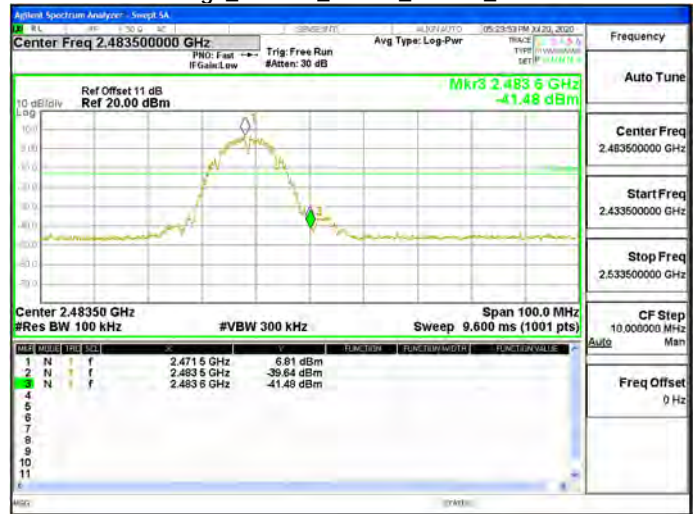

Band Edge\_802.11b\_20MHz\_Chain0\_2462MHz



Band Edge\_802.11g\_20MHz\_Chain0\_2412MHz

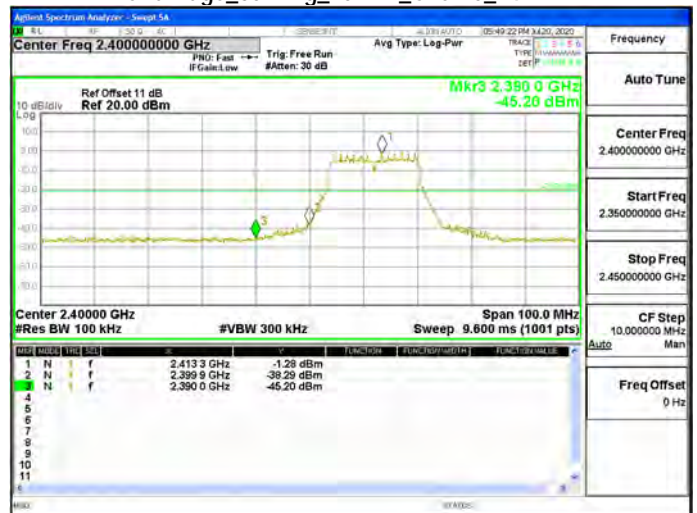

Band Edge\_802.11b\_20MHz\_Chain0\_2467MHz

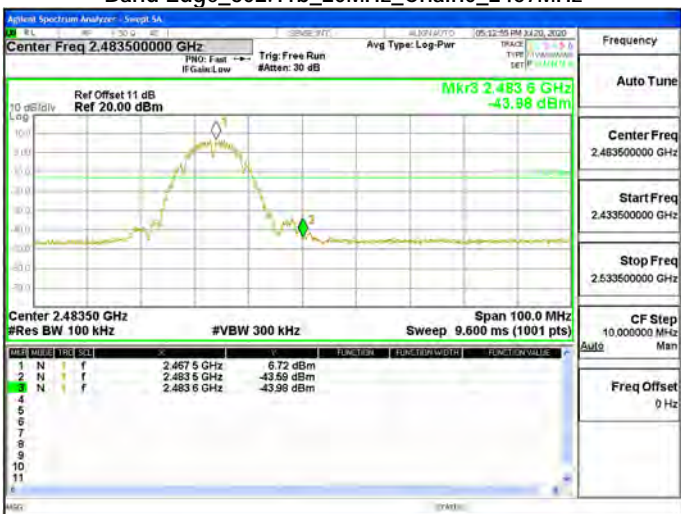

Band Edge\_802.11g\_20MHz\_Chain0\_2462MHz



Unless otherwise stated the results shown in this test report refer only to the sample(s) tested and such sample(s) are retained for 90 days only.

除非另有說明，此報告結果僅對測試之樣品負責，同時此樣品僅保留90天。本報告未經本公司書面許可，不可部份複製。

This document is issued by the Company subject to its General Conditions of Service printed overleaf, available on request or accessible at <http://www.sgs.com.tw/Terms-and-Conditions> and for electronic format documents, subject to Terms and Conditions for Electronic Documents at <http://www.sgs.com.tw/Terms-and-Conditions>. Attention is drawn to the limitation of liability, indemnification and jurisdiction issues defined therein. Any holder of this document is advised that information contained hereon reflects the Company's findings at the time of its intervention only and within the limits of Client's instructions, if any. The Company's sole responsibility is to its Client and this document does not exonerate parties to a transaction from exercising all their rights and obligations under the transaction documents. This document cannot be reproduced except in full, without prior written approval of the Company. Any unauthorized alteration, forgery or falsification of the content or appearance of this document is unlawful and offenders may be prosecuted to the fullest extent of the law.

Band Edge\_802.11g\_20MHz\_Chain0\_2467MHz

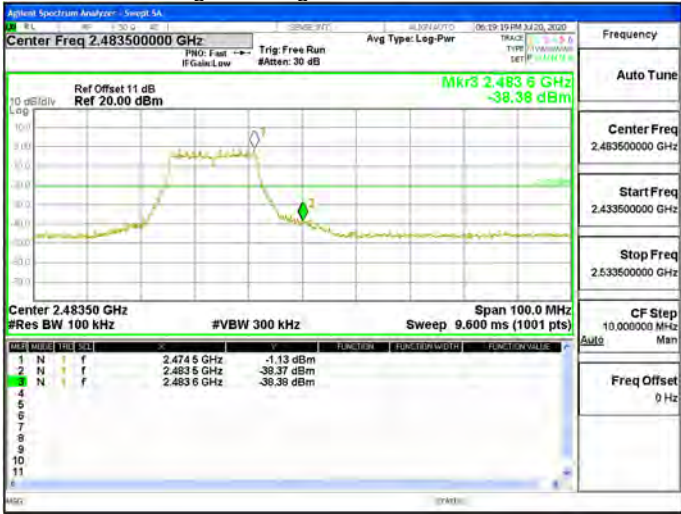

Band Edge\_802.11n\_20MHz\_Chain0\_2462MHz

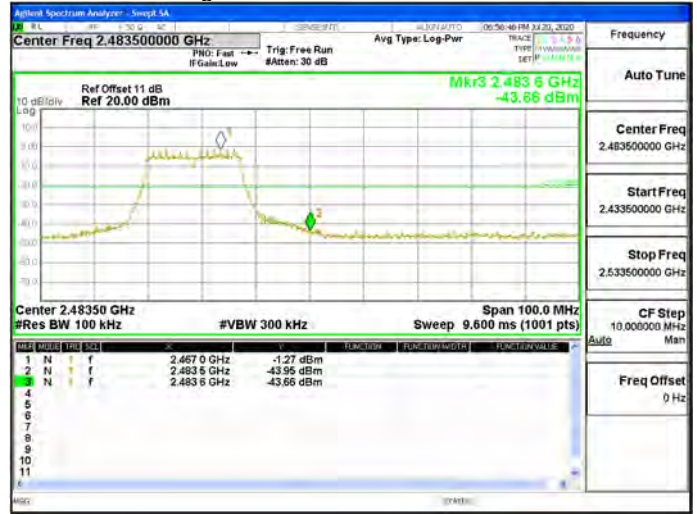

Band Edge\_802.11g\_20MHz\_Chain0\_2472MHz



Band Edge\_802.11n\_20MHz\_Chain0\_2467MHz

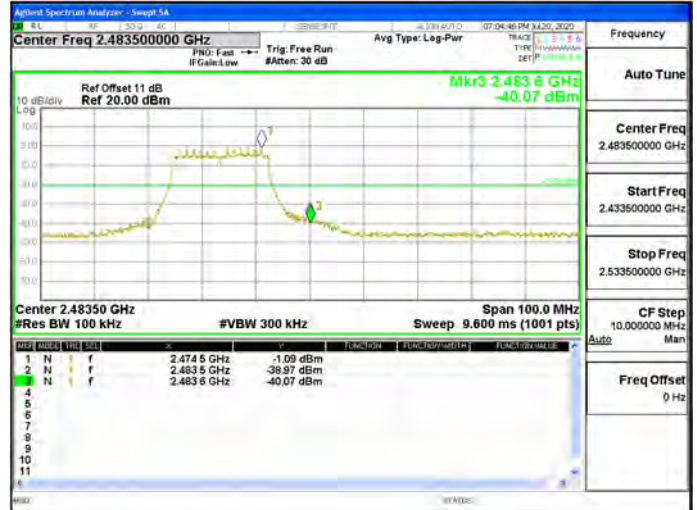

Band Edge\_802.11n\_20MHz\_Chain0\_2412MHz



Band Edge\_802.11n\_20MHz\_Chain0\_2472MHz



Unless otherwise stated the results shown in this test report refer only to the sample(s) tested and such sample(s) are retained for 90 days only.

除非另有說明，此報告結果僅對測試之樣品負責，同時此樣品僅保留90天。本報告未經本公司書面許可，不可部份複製。

This document is issued by the Company subject to its General Conditions of Service printed overleaf, available on request or accessible at <http://www.sgs.com.tw/Terms-and-Conditions> and for electronic format documents, subject to Terms and Conditions for Electronic Documents at <http://www.sgs.com.tw/Terms-and-Conditions>. Attention is drawn to the limitation of liability, indemnification and jurisdiction issues defined therein. Any holder of this document is advised that information contained hereon reflects the Company's findings at the time of its intervention only and within the limits of Client's instructions, if any. The Company's sole responsibility is to its Client and this document does not exonerate parties to a transaction from exercising all their rights and obligations under the transaction documents. This document cannot be reproduced except in full, without prior written approval of the Company. Any unauthorized alteration, forgery or falsification of the content or appearance of this document is unlawful and offenders may be prosecuted to the fullest extent of the law.

Spurious Emission\_802.11b\_20MHz\_Chain0\_2412MHz



Spurious Emission\_802.11b\_20MHz\_Chain0\_2467MHz

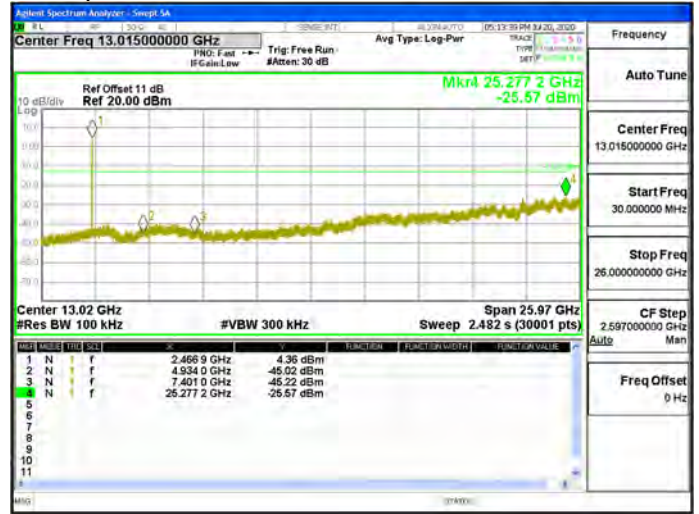

Spurious Emission\_802.11b\_20MHz\_Chain0\_2437MHz



Spurious Emission\_802.11b\_20MHz\_Chain0\_2472MHz



Spurious Emission\_802.11b\_20MHz\_Chain0\_2462MHz

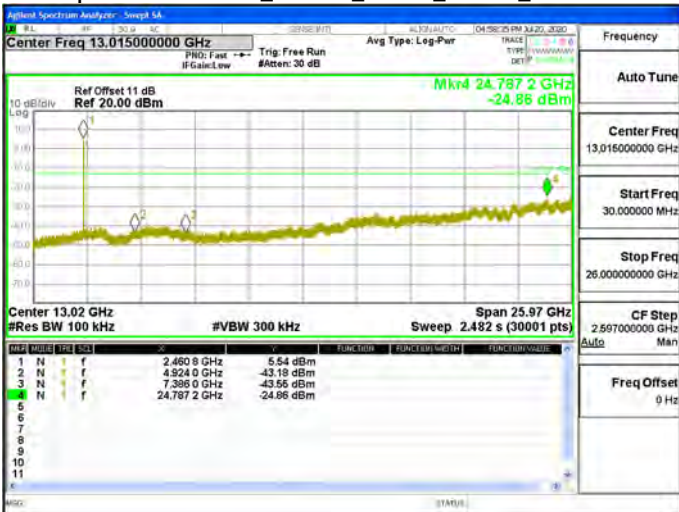

Spurious Emission\_802.11g\_20MHz\_Chain0\_2412MHz



Unless otherwise stated the results shown in this test report refer only to the sample(s) tested and such sample(s) are retained for 90 days only.

除非另有說明，此報告結果僅對測試之樣品負責，同時此樣品僅保留90天。本報告未經本公司書面許可，不可部份複製。

This document is issued by the Company subject to its General Conditions of Service printed overleaf, available on request or accessible at <http://www.sgs.com.tw/Terms-and-Conditions> and for electronic format documents, subject to Terms and Conditions for Electronic Documents at <http://www.sgs.com.tw/Terms-and-Conditions>. Attention is drawn to the limitation of liability, indemnification and jurisdiction issues defined therein. Any holder of this document is advised that information contained hereon reflects the Company's findings at the time of its intervention only and within the limits of Client's instructions, if any. The Company's sole responsibility is to its Client and this document does not exonerate parties to a transaction from exercising all their rights and obligations under the transaction documents. This document cannot be reproduced except in full, without prior written approval of the Company. Any unauthorized alteration, forgery or falsification of the content or appearance of this document is unlawful and offenders may be prosecuted to the fullest extent of the law.



Spurious Emission\_802.11g\_20MHz\_Chain0\_2437MHz



Spurious Emission\_802.11g\_20MHz\_Chain0\_2472MHz



Spurious Emission\_802.11g\_20MHz\_Chain0\_2462MHz



Spurious Emission\_802.11n\_20MHz\_Chain0\_2412MHz



Spurious Emission\_802.11g\_20MHz\_Chain0\_2467MHz



Spurious Emission\_802.11n\_20MHz\_Chain0\_2437MHz



Unless otherwise stated the results shown in this test report refer only to the sample(s) tested and such sample(s) are retained for 90 days only.

除非另有說明，此報告結果僅對測試之樣品負責，同時此樣品僅保留90天。本報告未經本公司書面許可，不可部份複製。

This document is issued by the Company subject to its General Conditions of Service printed overleaf, available on request or accessible at <http://www.sgs.com.tw/Terms-and-Conditions> and for electronic format documents, subject to Terms and Conditions for Electronic Documents at <http://www.sgs.com.tw/Terms-and-Conditions>. Attention is drawn to the limitation of liability, indemnification and jurisdiction issues defined therein. Any holder of this document is advised that information contained hereon reflects the Company's findings at the time of its intervention only and within the limits of Client's instructions, if any. The Company's sole responsibility is to its Client and this document does not exonerate parties to a transaction from exercising all their rights and obligations under the transaction documents. This document cannot be reproduced except in full, without prior written approval of the Company. Any unauthorized alteration, forgery or falsification of the content or appearance of this document is unlawful and offenders may be prosecuted to the fullest extent of the law.

Spurious Emission\_802.11n\_20MHz\_Chain0\_2462MHz



Spurious Emission\_802.11n\_20MHz\_Chain0\_2467MHz

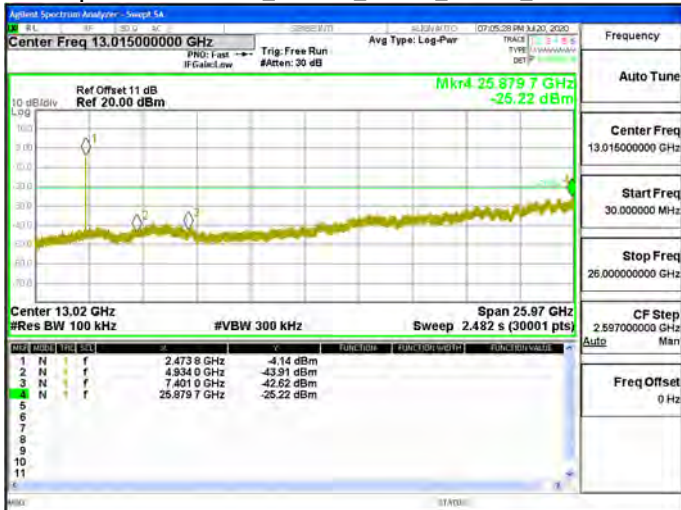

Spurious Emission\_802.11n\_20MHz\_Chain0\_2472MHz



Unless otherwise stated the results shown in this test report refer only to the sample(s) tested and such sample(s) are retained for 90 days only.

除非另有說明，此報告結果僅對測試之樣品負責，同時此樣品僅保留90天。本報告未經本公司書面許可，不可部份複製。

This document is issued by the Company subject to its General Conditions of Service printed overleaf, available on request or accessible at <http://www.sgs.com.tw/Terms-and-Conditions> and for electronic format documents, subject to Terms and Conditions for Electronic Documents at <http://www.sgs.com.tw/Terms-and-Conditions>. Attention is drawn to the limitation of liability, indemnification and jurisdiction issues defined therein. Any holder of this document is advised that information contained hereon reflects the Company's findings at the time of its intervention only and within the limits of Client's instructions, if any. The Company's sole responsibility is to its Client and this document does not exonerate parties to a transaction from exercising all their rights and obligations under the transaction documents. This document cannot be reproduced except in full, without prior written approval of the Company. Any unauthorized alteration, forgery or falsification of the content or appearance of this document is unlawful and offenders may be prosecuted to the fullest extent of the law.

## 11 RADIATED BANDEDGE AND SPURIOUS EMISSION MEASUREMENT

### 11.1 Standard Applicable

In any 100 kHz bandwidth outside the frequency band in which the spread spectrum or digitally modulated intentional radiator is operating, the radio frequency power that is produced by the intentional radiator shall be at least 20 dB below that in the 100 kHz bandwidth within the band that contains the highest level of the desired power, based on either an RF conducted or a radiated measurement, provided the transmitter demonstrates compliance with the peak conducted power limits. In addition, radiated emissions which fall in the restricted bands must also comply with the §15.209 and RSS-Gen §8.9 Table 5 and 6 limit as below. And according to §15.33(a) (1) & RSS-Gen §6.13.2.a, for an intentional radiator operates below 10GHz, the frequency range of measurements: to the tenth harmonic of the highest fundamental frequency or to 40GHz, whichever is lower.

Frequency (MHz)	Field strength (microvolts/meter)	Distance (meters)
0.009-0.490	2400/F(kHz)	300
0.490-1.705	24000/F(kHz)	30
1.705-30	30	30
30-88	100	3
88-216	150	3
216-960	200	3
Above 960	500	3

**Note:**

1. The lower limit shall apply at the transition frequencies.
2. Emission level (dBμV/m) = 20 log Emission level (μV/m)

Unless otherwise stated the results shown in this test report refer only to the sample(s) tested and such sample(s) are retained for 90 days only.

除非另有說明，此報告結果僅對測試之樣品負責，同時此樣品僅保留90天。本報告未經本公司書面許可，不可部份複製。

This document is issued by the Company subject to its General Conditions of Service printed overleaf, available on request or accessible at <http://www.sgs.com.tw/Terms-and-Conditions> and for electronic format documents, subject to Terms and Conditions for Electronic Documents at <http://www.sgs.com.tw/Terms-and-Conditions>. Attention is drawn to the limitation of liability, indemnification and jurisdiction issues defined therein. Any holder of this document is advised that information contained hereon reflects the Company's findings at the time of its intervention only and within the limits of Client's instructions, if any. The Company's sole responsibility is to its Client and this document does not exonerate parties to a transaction from exercising all their rights and obligations under the transaction documents. This document cannot be reproduced except in full, without prior written approval of the Company. Any unauthorized alteration, forgery or falsification of the content or appearance of this document is unlawful and offenders may be prosecuted to the fullest extent of the law.

## 11.2 Measurement Equipment Used:

966 Chamber					
EQUIPMENT TYPE	MFR	MODEL NUMBER	SERIAL NUMBER	LAST CAL.	CAL DUE.
Horn Antenna	Schwarzbeck	BBHA9170	184	12/25/2019	12/24/2020
Horn Antenna	Schwarzbeck	BBHA9120D	D803	12/20/2019	12/19/2020
Bi-log Antenna	TESEO	CBL 6112D	35242 & AT-N0555	01/13/2020	01/12/2021
Loop Antenna	ETS.LINDGREN	6502	148045	10/15/2019	10/14/2020
Spectrum Analyzer	Agilent	E4446A	MY51100003	10/23/2019	10/22/2020
EMI Test Receiver	R&S	ESCI 7	100759	07/13/2020	07/12/2021
Pre-Amplifier	EMC Instruments	EMC184045B	980135	01/02/2020	01/01/2021
Pre-Amplifier	EMC Instruments	EMC051825	980152	01/02/2020	01/01/2021
Pre-Amplifier	HP	8447D	2944A09469	01/02/2020	01/01/2021
Attenuator	Mini-Circuit	BW-S10W2+	4	01/02/2020	01/01/2021
Filter 2400-2483.5 MHz	EWT	EWT-14-0166	M1	01/02/2020	01/01/2021
High Pass Filter	WI	WHKX4.0/18G-10SS	22	01/02/2020	01/01/2021
Coaxial Cable	Huber Suhner	succoflex 102	MY2622/2	01/02/2020	01/01/2021
Coaxial Cable	Huber Suhner	succoflex 104A	800086/4a	01/02/2020	01/01/2021
Coaxial Cable	Huber Suhner	EMC 104-SM-SM-2000	160123	01/02/2020	01/01/2021

Unless otherwise stated the results shown in this test report refer only to the sample(s) tested and such sample(s) are retained for 90 days only.

除非另有說明，此報告結果僅對測試之樣品負責，同時此樣品僅保留90天。本報告未經本公司書面許可，不可部份複製。

This document is issued by the Company subject to its General Conditions of Service printed overleaf, available on request or accessible at <http://www.sgs.com.tw/Terms-and-Conditions> and for electronic format documents, subject to Terms and Conditions for Electronic Documents at <http://www.sgs.com.tw/Terms-and-Conditions>. Attention is drawn to the limitation of liability, indemnification and jurisdiction issues defined therein. Any holder of this document is advised that information contained hereon reflects the Company's findings at the time of its intervention only and within the limits of Client's instructions, if any. The Company's sole responsibility is to its Client and this document does not exonerate parties to a transaction from exercising all their rights and obligations under the transaction documents. This document cannot be reproduced except in full, without prior written approval of the Company. Any unauthorized alteration, forgery or falsification of the content or appearance of this document is unlawful and offenders may be prosecuted to the fullest extent of the law.

### 11.3 Test SET-UP

(A) Radiated Emission Test Set-UP Frequency Below 30MHz.

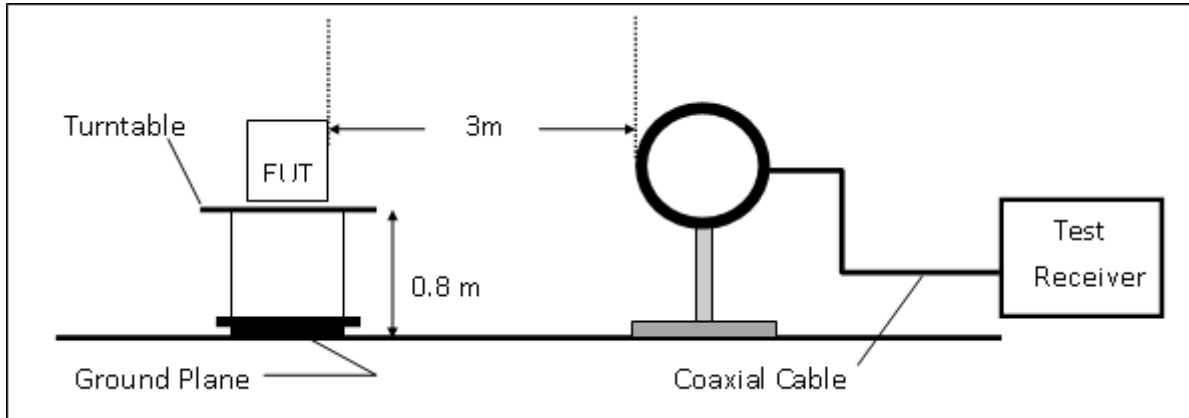

(B) Radiated Emission Test Set-UP, Frequency form 30MHz to 1000MHz

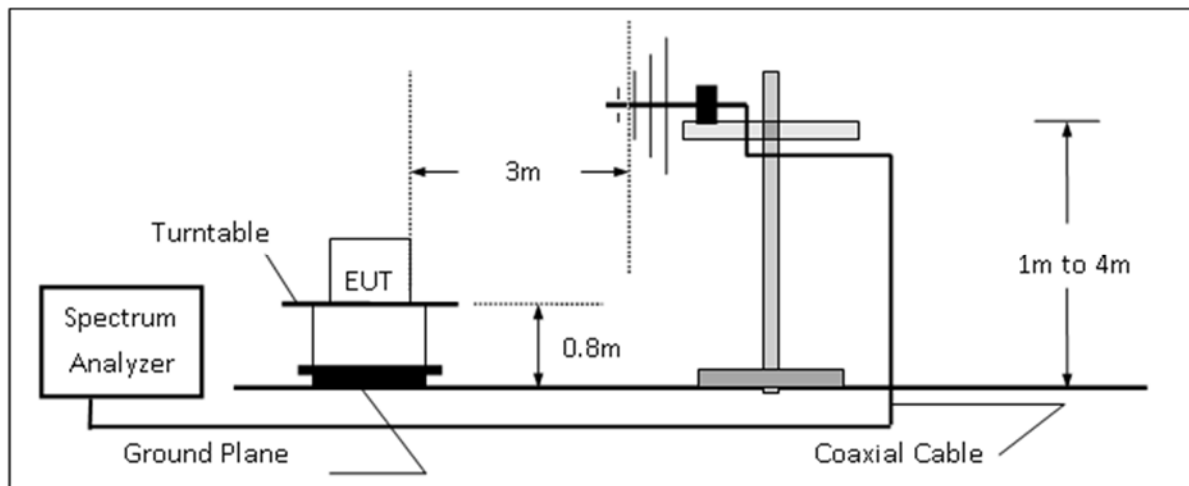

(C) Radiated Emission Test Set-UP Frequency Over 1 GHz

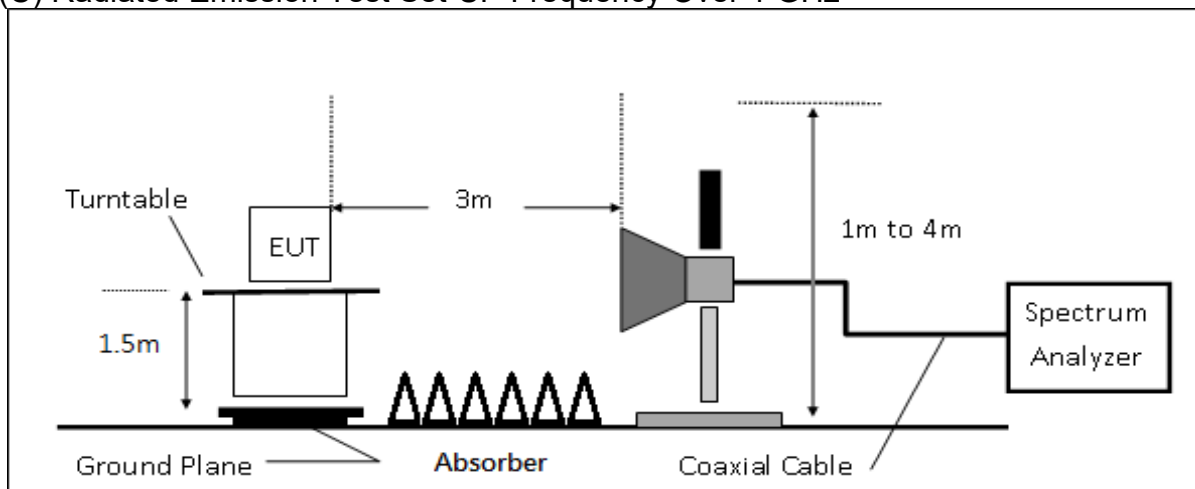

Unless otherwise stated the results shown in this test report refer only to the sample(s) tested and such sample(s) are retained for 90 days only.

除非另有說明，此報告結果僅對測試之樣品負責，同時此樣品僅保留90天。本報告未經本公司書面許可，不可部份複製。

This document is issued by the Company subject to its General Conditions of Service printed overleaf, available on request or accessible at <http://www.sgs.com.tw/Terms-and-Conditions> and for electronic format documents, subject to Terms and Conditions for Electronic Documents at <http://www.sgs.com.tw/Terms-and-Conditions>. Attention is drawn to the limitation of liability, indemnification and jurisdiction issues defined therein. Any holder of this document is advised that information contained hereon reflects the Company's findings at the time of its intervention only and within the limits of Client's instructions, if any. The Company's sole responsibility is to its Client and this document does not exonerate parties to a transaction from exercising all their rights and obligations under the transaction documents. This document cannot be reproduced except in full, without prior written approval of the Company. Any unauthorized alteration, forgery or falsification of the content or appearance of this document is unlawful and offenders may be prosecuted to the fullest extent of the law.

## 11.4 Measurement Procedure

1. The testing follows the Measurement Procedure of FCC KDB 558074 D01 DTS Meas. Guidance .
2. The EUT was placed on a turn table with 0.8m for frequency < 1GHz and 1.5m for frequency > 1GHz above ground plane.
3. The turn table shall rotate 360 degrees to determine the position of maximum emission level.
4. EUT is set 3m away from the receiving antenna which varied from 1m to 4m to find out the highest emissions.
5. When measurement procedures for electric field radiated emissions above 1 GHz the EUT measurement is to be made “while keeping the antenna in the ‘cone of radiation’ from that area and pointed at the area both in azimuth and elevation, with polarization oriented for maximum response.” is still within the 3dB illumination BW of the measurement antenna.
6. Set the spectrum analyzer as RBW=120 kHz and VBW=300 kHz for Peak Detector (PK) and Quasi-peak (QP) at frequency below 1 GHz.
7. Set the spectrum analyzer as RBW=1 MHz, VBW=3 MHz for Peak Detector at frequency above 1 GHz.
8. Set the spectrum analyzer as RBW=1 MHz, VBW=10 Hz (Duty cycle > 98%) or VBW ≥ 1/T (Duty cycle < 98%) for Average Detector at frequency above 1 GHz.
9. The test-receiver system was set to quasi-peak detect function and specified bandwidth with maximum hold mode when the test frequency is below 1 GHz.
10. Maximum procedure was performed on the six highest emissions to ensure EUT compliance.
11. And also, each emission was to be maximized by changing the polarization of receiving antenna both horizontal and vertical. On spectrum, change spectrum mode in linear display mode, and reduce VBW = 10Hz if average reading is measured.
12. Repeat above procedures until all default test channel measured were complete.

Unless otherwise stated the results shown in this test report refer only to the sample(s) tested and such sample(s) are retained for 90 days only.

除非另有說明，此報告結果僅對測試之樣品負責，同時此樣品僅保留90天。本報告未經本公司書面許可，不可部份複製。

This document is issued by the Company subject to its General Conditions of Service printed overleaf, available on request or accessible at <http://www.sgs.com.tw/Terms-and-Conditions> and for electronic format documents, subject to Terms and Conditions for Electronic Documents at <http://www.sgs.com.tw/Terms-and-Conditions>. Attention is drawn to the limitation of liability, indemnification and jurisdiction issues defined therein. Any holder of this document is advised that information contained hereon reflects the Company's findings at the time of its intervention only and within the limits of Client's instructions, if any. The Company's sole responsibility is to its Client and this document does not exonerate parties to a transaction from exercising all their rights and obligations under the transaction documents. This document cannot be reproduced except in full, without prior written approval of the Company. Any unauthorized alteration, forgery or falsification of the content or appearance of this document is unlawful and offenders may be prosecuted to the fullest extent of the law.

## 11.5 Field Strength Calculation

The field strength is calculated by adding the Antenna Factor and Cable Factor and subtracting the Amplifier Gain and Duty Cycle Correction Factor (if any) from the measured reading. The basic equation with a sample calculation is as follows:

$$FS = RA + AF + CL - AG$$

**Where** *FS* = Field Strength

*CL* = Cable Attenuation Factor (Cable Loss)

*RA* = Reading Amplitude

*AG* = Amplifier Gain

*AF* = Antenna Factor

The limit of the emission level is expressed in dBuV/m, which converts  $20 \cdot \log(uV/m)$

Actual FS(dB $\mu$ V/m) = SPA. Reading level(dB $\mu$ V) + Factor(dB)

Factor(dB) = Antenna Factor(dB $\mu$ V/m) + Cable Loss(dB) – Pre\_Amplifier Gain(dB)

## 11.6 Test Results of Radiated Spurious Emissions form 9 kHz to 30 MHz

The low frequency, which started from 9 kHz to 30MHz, was pre-scanned and the result which was 20dB lower than the limit per 15.31(o) & RSS-GEN §6.13.2 was not reported.

## 11.7 Measurement Result

### Note:

1. Refer to next page spectrum analyzer data chart and tabular data sheets.
2. Measurements are completed at peak and average level, the mark of average is the highest emission in restricted bands

Unless otherwise stated the results shown in this test report refer only to the sample(s) tested and such sample(s) are retained for 90 days only.  
除非另有說明，此報告結果僅對測試之樣品負責，同時此樣品僅保留90天。本報告未經本公司書面許可，不可部份複製。

This document is issued by the Company subject to its General Conditions of Service printed overleaf, available on request or accessible at <http://www.sgs.com.tw/Terms-and-Conditions> and for electronic format documents, subject to Terms and Conditions for Electronic Documents at <http://www.sgs.com.tw/Terms-and-Conditions>. Attention is drawn to the limitation of liability, indemnification and jurisdiction issues defined therein. Any holder of this document is advised that information contained hereon reflects the Company's findings at the time of its intervention only and within the limits of Client's instructions, if any. The Company's sole responsibility is to its Client and this document does not exonerate parties to a transaction from exercising all their rights and obligations under the transaction documents. This document cannot be reproduced except in full, without prior written approval of the Company. Any unauthorized alteration, forgery or falsification of the content or appearance of this document is unlawful and offenders may be prosecuted to the fullest extent of the law.

### 11.7.1 Radiated Band Edge Measurement Result

Report Number	:ER/2020/70076	Test Site	:SAC I Chamber
Operation Mode	:802.11b	Test Date	:2020-08-11
Test Frequency	:2412 MHz	Temp./Humi.	:26.5/67
Test Mode	:Bandedge CH Low	Antenna Pol.	:VERTICAL
EUT Pol	:H Plane	Engineer	:Neo

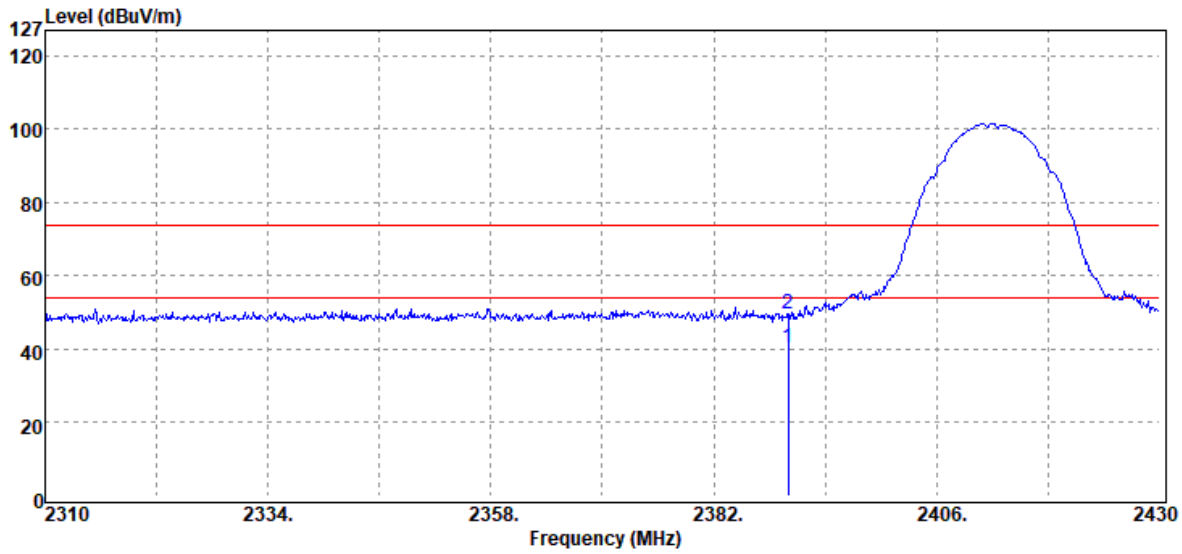

Freq. MHz	Detector Mode	Spectrum Reading Level dB $\mu$ V	Factor dB	Actual FS dB $\mu$ V/m	Limit @3m dB $\mu$ V/m	Margin dB
2390.00	Average	33.01	7.46	40.47	54.00	-13.53
2390.00	Peak	42.06	7.46	49.52	74.00	-24.48

Unless otherwise stated the results shown in this test report refer only to the sample(s) tested and such sample(s) are retained for 90 days only.

除非另有說明，此報告結果僅對測試之樣品負責，同時此樣品僅保留90天。本報告未經本公司書面許可，不可部份複製。

This document is issued by the Company subject to its General Conditions of Service printed overleaf, available on request or accessible at <http://www.sgs.com.tw/Terms-and-Conditions> and for electronic format documents, subject to Terms and Conditions for Electronic Documents at <http://www.sgs.com.tw/Terms-and-Conditions>. Attention is drawn to the limitation of liability, indemnification and jurisdiction issues defined therein. Any holder of this document is advised that information contained hereon reflects the Company's findings at the time of its intervention only and within the limits of Client's instructions, if any. The Company's sole responsibility is to its Client and this document does not exonerate parties to a transaction from exercising all their rights and obligations under the transaction documents. This document cannot be reproduced except in full, without prior written approval of the Company. Any unauthorized alteration, forgery or falsification of the content or appearance of this document is unlawful and offenders may be prosecuted to the fullest extent of the law.



Report Number	:ER/2020/70076	Test Site	:SAC I Chamber
Operation Mode	:802.11b	Test Date	:2020-08-11
Test Frequency	:2412 MHz	Temp./Humi.	:26.5/67
Test Mode	:Bandedge CH Low	Antenna Pol.	:HORIZONTAL
EUT Pol	:H Plane	Engineer	:Neo

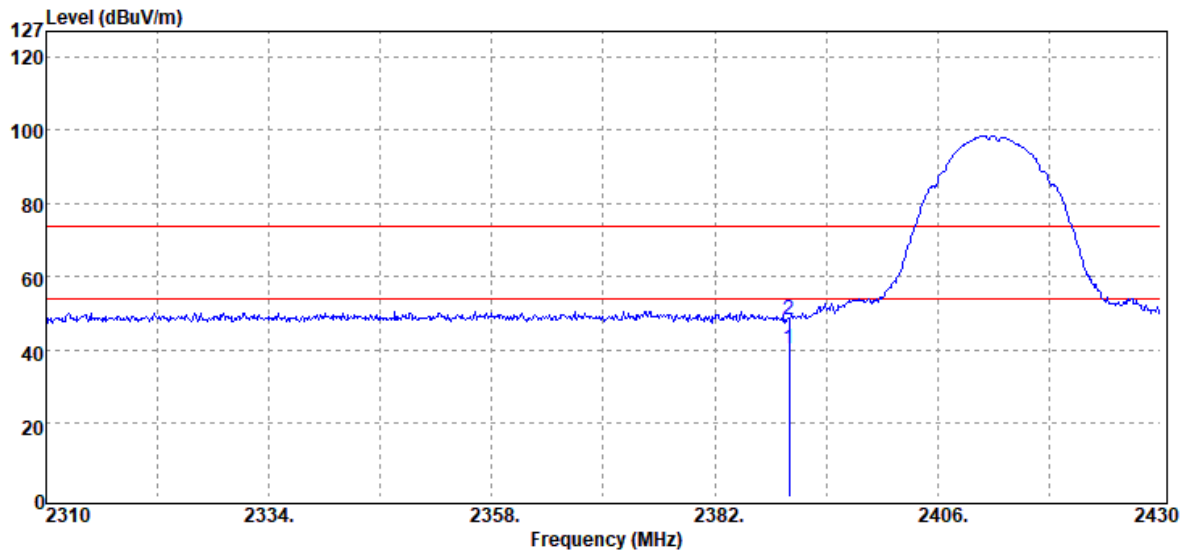

Freq. MHz	Detector Mode	Spectrum Reading Level dB $\mu$ V	Factor dB	Actual FS dB $\mu$ V/m	Limit @3m dB $\mu$ V/m	Margin dB
2390.00	Average	32.89	7.46	40.35	54.00	-13.65
2390.00	Peak	40.69	7.46	48.15	74.00	-25.85

Unless otherwise stated the results shown in this test report refer only to the sample(s) tested and such sample(s) are retained for 90 days only.

除非另有說明，此報告結果僅對測試之樣品負責，同時此樣品僅保留90天。本報告未經本公司書面許可，不可部份複製。

This document is issued by the Company subject to its General Conditions of Service printed overleaf, available on request or accessible at <http://www.sgs.com.tw/Terms-and-Conditions> and for electronic format documents, subject to Terms and Conditions for Electronic Documents at <http://www.sgs.com.tw/Terms-and-Conditions>. Attention is drawn to the limitation of liability, indemnification and jurisdiction issues defined therein. Any holder of this document is advised that information contained hereon reflects the Company's findings at the time of its intervention only and within the limits of Client's instructions, if any. The Company's sole responsibility is to its Client and this document does not exonerate parties to a transaction from exercising all their rights and obligations under the transaction documents. This document cannot be reproduced except in full, without prior written approval of the Company. Any unauthorized alteration, forgery or falsification of the content or appearance of this document is unlawful and offenders may be prosecuted to the fullest extent of the law.

Report Number	:ER/2020/70076	Test Site	:SAC I Chamber
Operation Mode	:802.11b	Test Date	:2020-08-11
Test Frequency	:2462 MHz	Temp./Humi.	:26.5/67
Test Mode	:Bandedge CH High	Antenna Pol.	:VERTICAL
EUT Pol	:H Plane	Engineer	:Neo

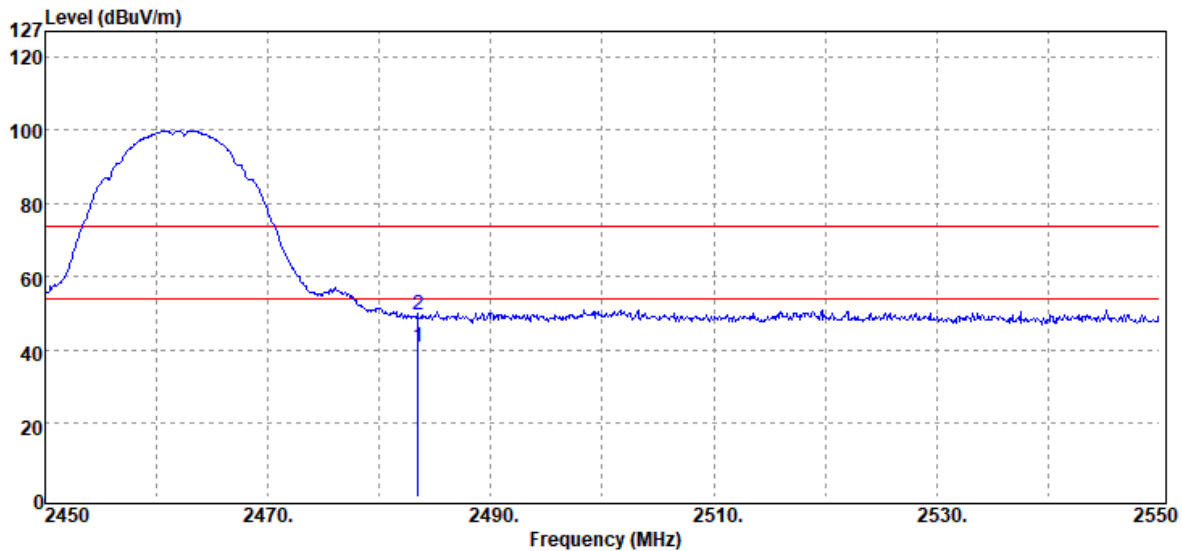

Freq.	Detector	Spectrum	Factor	Actual	Limit	Margin
MHz	Mode	Reading Level	dB	FS	@3m	dB
	PK/QP/AV	dB $\mu$ V		dB $\mu$ V/m	dB $\mu$ V/m	
2483.50	Average	33.19	7.46	40.65	54.00	-13.35
2483.50	Peak	42.10	7.46	49.56	74.00	-24.44

Unless otherwise stated the results shown in this test report refer only to the sample(s) tested and such sample(s) are retained for 90 days only.

除非另有說明，此報告結果僅對測試之樣品負責，同時此樣品僅保留90天。本報告未經本公司書面許可，不可部份複製。

This document is issued by the Company subject to its General Conditions of Service printed overleaf, available on request or accessible at <http://www.sgs.com.tw/Terms-and-Conditions> and for electronic format documents, subject to Terms and Conditions for Electronic Documents at <http://www.sgs.com.tw/Terms-and-Conditions>. Attention is drawn to the limitation of liability, indemnification and jurisdiction issues defined therein. Any holder of this document is advised that information contained hereon reflects the Company's findings at the time of its intervention only and within the limits of Client's instructions, if any. The Company's sole responsibility is to its Client and this document does not exonerate parties to a transaction from exercising all their rights and obligations under the transaction documents. This document cannot be reproduced except in full, without prior written approval of the Company. Any unauthorized alteration, forgery or falsification of the content or appearance of this document is unlawful and offenders may be prosecuted to the fullest extent of the law.

Report Number	:ER/2020/70076	Test Site	:SAC I Chamber
Operation Mode	:802.11b	Test Date	:2020-08-11
Test Frequency	:2462 MHz	Temp./Humi.	:26.5/67
Test Mode	:Bandedge CH High	Antenna Pol.	:HORIZONTAL
EUT Pol	:H Plane	Engineer	:Neo

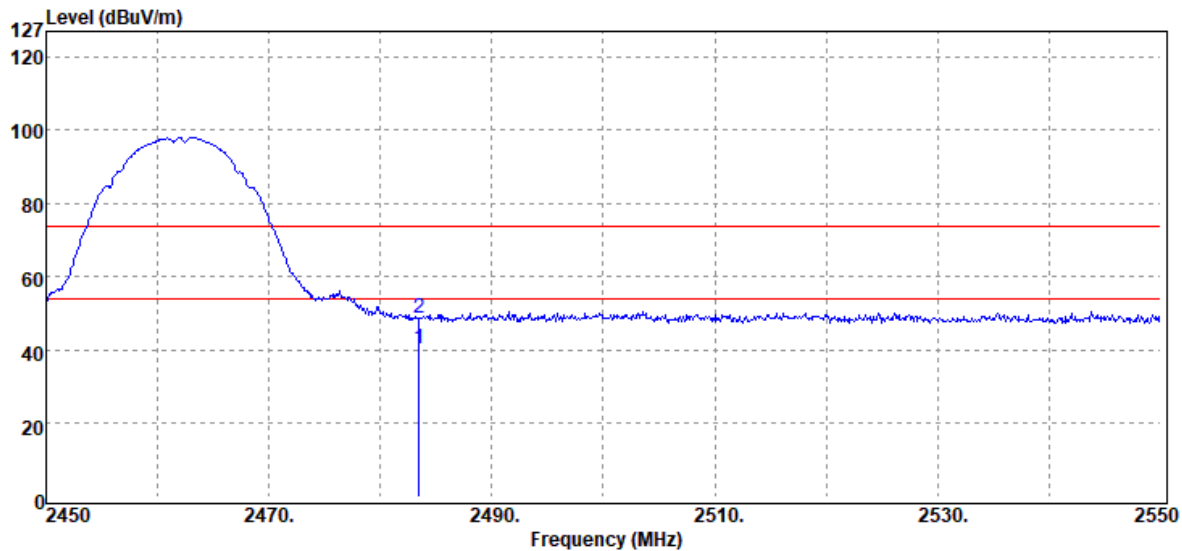

Freq.	Detector	Spectrum	Factor	Actual	Limit	Margin
MHz	Mode	Reading Level	dB	FS	@3m	dB
	PK/QP/AV	dB $\mu$ V		dB $\mu$ V/m	dB $\mu$ V/m	
2483.50	Average	32.98	7.46	40.44	54.00	-13.56
2483.50	Peak	41.38	7.46	48.84	74.00	-25.16

Unless otherwise stated the results shown in this test report refer only to the sample(s) tested and such sample(s) are retained for 90 days only.

除非另有說明，此報告結果僅對測試之樣品負責，同時此樣品僅保留90天。本報告未經本公司書面許可，不可部份複製。

This document is issued by the Company subject to its General Conditions of Service printed overleaf, available on request or accessible at <http://www.sgs.com.tw/Terms-and-Conditions> and for electronic format documents, subject to Terms and Conditions for Electronic Documents at <http://www.sgs.com.tw/Terms-and-Conditions>. Attention is drawn to the limitation of liability, indemnification and jurisdiction issues defined therein. Any holder of this document is advised that information contained hereon reflects the Company's findings at the time of its intervention only and within the limits of Client's instructions, if any. The Company's sole responsibility is to its Client and this document does not exonerate parties to a transaction from exercising all their rights and obligations under the transaction documents. This document cannot be reproduced except in full, without prior written approval of the Company. Any unauthorized alteration, forgery or falsification of the content or appearance of this document is unlawful and offenders may be prosecuted to the fullest extent of the law.

Report Number	:ER/2020/70076	Test Site	:SAC I Chamber
Operation Mode	:802.11b	Test Date	:2020-08-11
Test Frequency	:2467 MHz	Temp./Humi.	:26.5/67
Test Mode	:Bandedge CH High	Antenna Pol.	:VERTICAL
EUT Pol	:H Plane	Engineer	:Neo

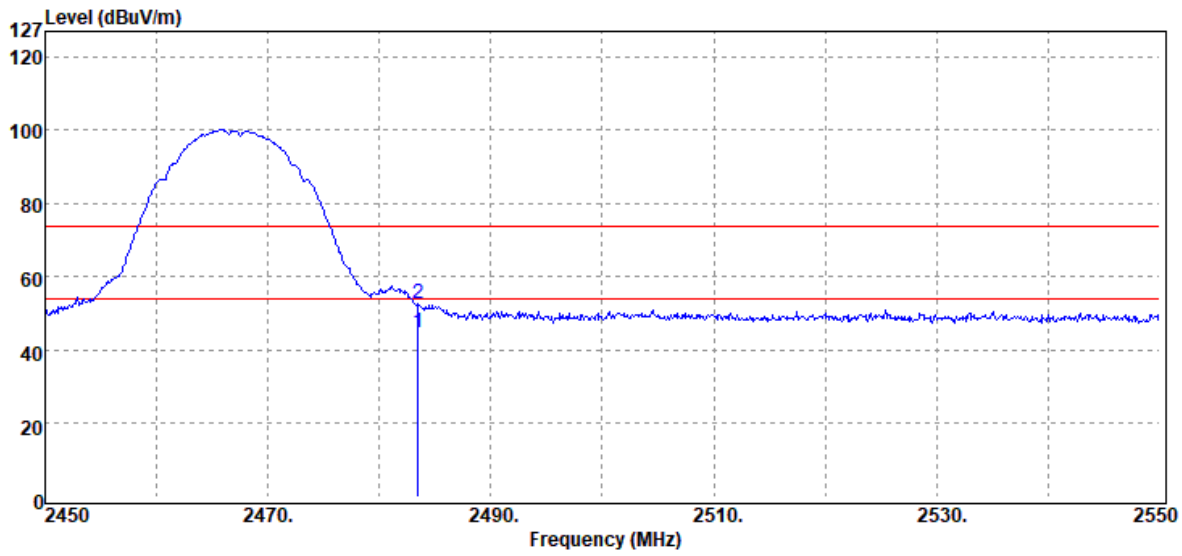

Freq. MHz	Detector Mode	Spectrum Reading Level dB $\mu$ V	Factor dB	Actual FS dB $\mu$ V/m	Limit @3m dB $\mu$ V/m	Margin dB
2483.50	Average	37.56	7.46	45.02	54.00	-8.98
2483.50	Peak	45.49	7.46	52.95	74.00	-21.05

Unless otherwise stated the results shown in this test report refer only to the sample(s) tested and such sample(s) are retained for 90 days only.

除非另有說明，此報告結果僅對測試之樣品負責，同時此樣品僅保留90天。本報告未經本公司書面許可，不可部份複製。

This document is issued by the Company subject to its General Conditions of Service printed overleaf, available on request or accessible at <http://www.sgs.com.tw/Terms-and-Conditions> and for electronic format documents, subject to Terms and Conditions for Electronic Documents at <http://www.sgs.com.tw/Terms-and-Conditions>. Attention is drawn to the limitation of liability, indemnification and jurisdiction issues defined therein. Any holder of this document is advised that information contained hereon reflects the Company's findings at the time of its intervention only and within the limits of Client's instructions, if any. The Company's sole responsibility is to its Client and this document does not exonerate parties to a transaction from exercising all their rights and obligations under the transaction documents. This document cannot be reproduced except in full, without prior written approval of the Company. Any unauthorized alteration, forgery or falsification of the content or appearance of this document is unlawful and offenders may be prosecuted to the fullest extent of the law.

Report Number	:ER/2020/70076	Test Site	:SAC I Chamber
Operation Mode	:802.11b	Test Date	:2020-08-11
Test Frequency	:2467 MHz	Temp./Humi.	:26.5/67
Test Mode	:Bandedge CH High	Antenna Pol.	:HORIZONTAL
EUT Pol	:H Plane	Engineer	:Neo

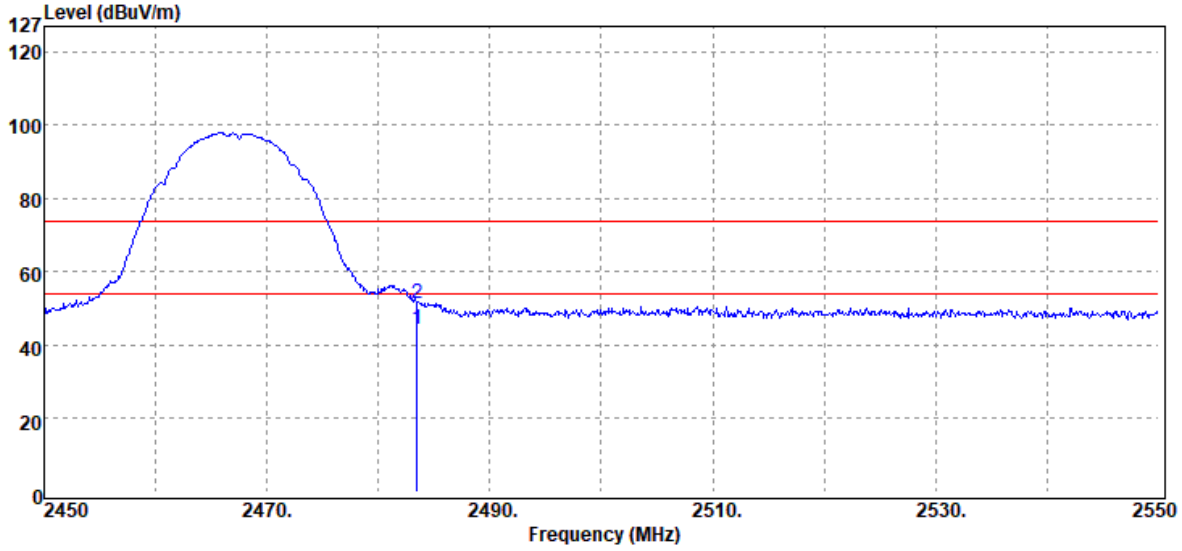

Freq. MHz	Detector Mode	Spectrum Reading Level dB $\mu$ V	Factor dB	Actual FS dB $\mu$ V/m	Limit @3m dB $\mu$ V/m	Margin dB
2483.50	Average	36.75	7.46	44.21	54.00	-9.79
2483.50	Peak	43.83	7.46	51.29	74.00	-22.71

Unless otherwise stated the results shown in this test report refer only to the sample(s) tested and such sample(s) are retained for 90 days only.

除非另有說明，此報告結果僅對測試之樣品負責，同時此樣品僅保留90天。本報告未經本公司書面許可，不可部份複製。

This document is issued by the Company subject to its General Conditions of Service printed overleaf, available on request or accessible at <http://www.sgs.com.tw/Terms-and-Conditions> and for electronic format documents, subject to Terms and Conditions for Electronic Documents at <http://www.sgs.com.tw/Terms-and-Conditions>. Attention is drawn to the limitation of liability, indemnification and jurisdiction issues defined therein. Any holder of this document is advised that information contained hereon reflects the Company's findings at the time of its intervention only and within the limits of Client's instructions, if any. The Company's sole responsibility is to its Client and this document does not exonerate parties to a transaction from exercising all their rights and obligations under the transaction documents. This document cannot be reproduced except in full, without prior written approval of the Company. Any unauthorized alteration, forgery or falsification of the content or appearance of this document is unlawful and offenders may be prosecuted to the fullest extent of the law.

Report Number	:ER/2020/70076	Test Site	:SAC I Chamber
Operation Mode	:802.11b	Test Date	:2020-08-11
Test Frequency	:2472 MHz	Temp./Humi.	:26.5/67
Test Mode	:Bandedge CH High	Antenna Pol.	:VERTICAL
EUT Pol	:H Plane	Engineer	:Neo

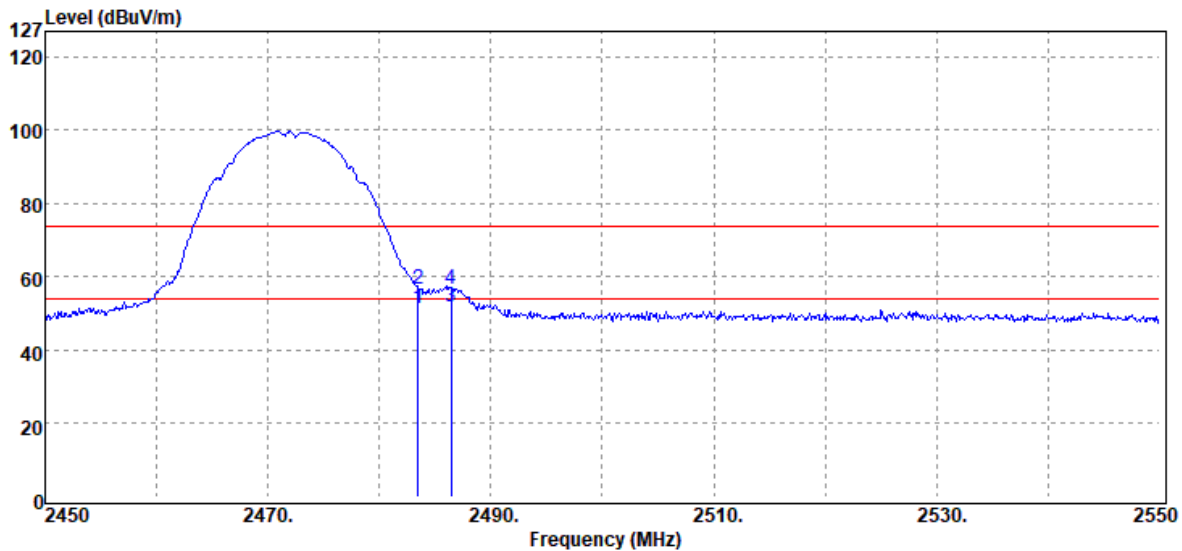

Freq.	Detector	Spectrum	Factor	Actual	Limit	Margin
MHz	Mode	Reading Level	dB	FS	@3m	dB
	PK/QP/AV	dBμV		dBμV/m	dBμV/m	
2483.50	Average	44.14	7.46	51.60	54.00	-2.40
2483.50	Peak	49.40	7.46	56.86	74.00	-17.14
2486.40	Average	44.38	7.46	51.84	54.00	-2.16
2486.40	Peak	49.21	7.46	56.67	74.00	-17.33

Unless otherwise stated the results shown in this test report refer only to the sample(s) tested and such sample(s) are retained for 90 days only.

除非另有說明，此報告結果僅對測試之樣品負責，同時此樣品僅保留90天。本報告未經本公司書面許可，不可部份複製。

This document is issued by the Company subject to its General Conditions of Service printed overleaf, available on request or accessible at <http://www.sgs.com.tw/Terms-and-Conditions> and for electronic format documents, subject to Terms and Conditions for Electronic Documents at <http://www.sgs.com.tw/Terms-and-Conditions>. Attention is drawn to the limitation of liability, indemnification and jurisdiction issues defined therein. Any holder of this document is advised that information contained hereon reflects the Company's findings at the time of its intervention only and within the limits of Client's instructions, if any. The Company's sole responsibility is to its Client and this document does not exonerate parties to a transaction from exercising all their rights and obligations under the transaction documents. This document cannot be reproduced except in full, without prior written approval of the Company. Any unauthorized alteration, forgery or falsification of the content or appearance of this document is unlawful and offenders may be prosecuted to the fullest extent of the law.

Report Number	:ER/2020/70076	Test Site	:SAC I Chamber
Operation Mode	:802.11b	Test Date	:2020-08-11
Test Frequency	:2472 MHz	Temp./Humi.	:26.5/67
Test Mode	:Bandedge CH High	Antenna Pol.	:HORIZONTAL
EUT Pol	:H Plane	Engineer	:Neo

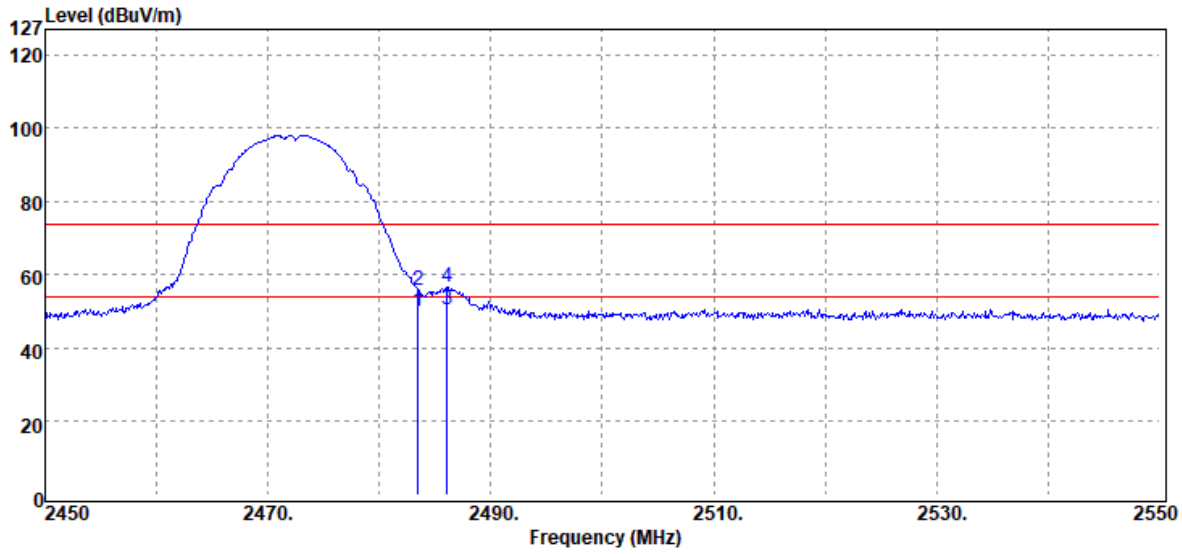

Freq.	Detector	Spectrum	Factor	Actual	Limit	Margin
MHz	Mode	Reading Level	dB	FS	@3m	dB
	PK/QP/AV	dBμV		dBμV/m	dBμV/m	
2483.50	Average	42.84	7.46	50.30	54.00	-3.70
2483.50	Peak	48.55	7.46	56.01	74.00	-17.99
2486.10	Average	43.06	7.46	50.52	54.00	-3.48
2486.10	Peak	49.22	7.46	56.68	74.00	-17.32

Unless otherwise stated the results shown in this test report refer only to the sample(s) tested and such sample(s) are retained for 90 days only.

除非另有說明，此報告結果僅對測試之樣品負責，同時此樣品僅保留90天。本報告未經本公司書面許可，不可部份複製。

This document is issued by the Company subject to its General Conditions of Service printed overleaf, available on request or accessible at <http://www.sgs.com.tw/Terms-and-Conditions> and for electronic format documents, subject to Terms and Conditions for Electronic Documents at <http://www.sgs.com.tw/Terms-and-Conditions>. Attention is drawn to the limitation of liability, indemnification and jurisdiction issues defined therein. Any holder of this document is advised that information contained hereon reflects the Company's findings at the time of its intervention only and within the limits of Client's instructions, if any. The Company's sole responsibility is to its Client and this document does not exonerate parties to a transaction from exercising all their rights and obligations under the transaction documents. This document cannot be reproduced except in full, without prior written approval of the Company. Any unauthorized alteration, forgery or falsification of the content or appearance of this document is unlawful and offenders may be prosecuted to the fullest extent of the law.

Report Number	:ER/2020/70076	Test Site	:SAC I Chamber
Operation Mode	:802.11g	Test Date	:2020-08-11
Test Frequency	:2412 MHz	Temp./Humi.	:26.5/67
Test Mode	:Bandedge CH Low	Antenna Pol.	:VERTICAL
EUT Pol	:H Plane	Engineer	:Neo

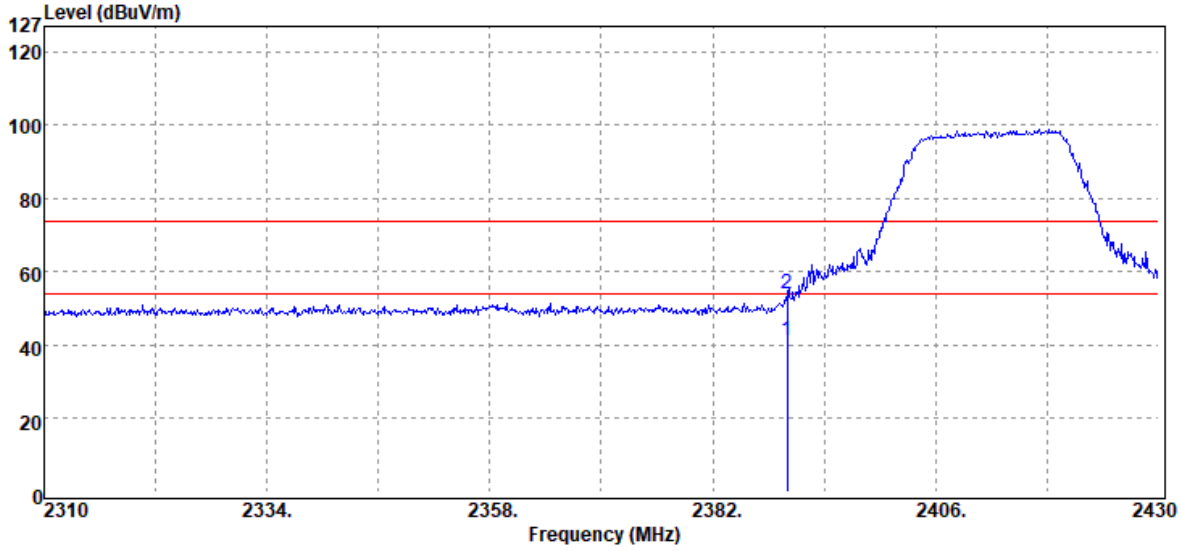

Freq. MHz	Detector Mode	Spectrum Reading Level dB $\mu$ V	Factor dB	Actual FS dB $\mu$ V/m	Limit @3m dB $\mu$ V/m	Margin dB
2390.00	Average	34.05	7.46	41.51	54.00	-12.49
2390.00	Peak	46.47	7.46	53.93	74.00	-20.07

Unless otherwise stated the results shown in this test report refer only to the sample(s) tested and such sample(s) are retained for 90 days only.

除非另有說明，此報告結果僅對測試之樣品負責，同時此樣品僅保留90天。本報告未經本公司書面許可，不可部份複製。

This document is issued by the Company subject to its General Conditions of Service printed overleaf, available on request or accessible at <http://www.sgs.com.tw/Terms-and-Conditions> and for electronic format documents, subject to Terms and Conditions for Electronic Documents at <http://www.sgs.com.tw/Terms-and-Conditions>. Attention is drawn to the limitation of liability, indemnification and jurisdiction issues defined therein. Any holder of this document is advised that information contained hereon reflects the Company's findings at the time of its intervention only and within the limits of Client's instructions, if any. The Company's sole responsibility is to its Client and this document does not exonerate parties to a transaction from exercising all their rights and obligations under the transaction documents. This document cannot be reproduced except in full, without prior written approval of the Company. Any unauthorized alteration, forgery or falsification of the content or appearance of this document is unlawful and offenders may be prosecuted to the fullest extent of the law.



Report Number	:ER/2020/70076	Test Site	:SAC I Chamber
Operation Mode	:802.11g	Test Date	:2020-08-11
Test Frequency	:2412 MHz	Temp./Humi.	:26.5/67
Test Mode	:Bandedge CH Low	Antenna Pol.	:HORIZONTAL
EUT Pol	:H Plane	Engineer	:Neo

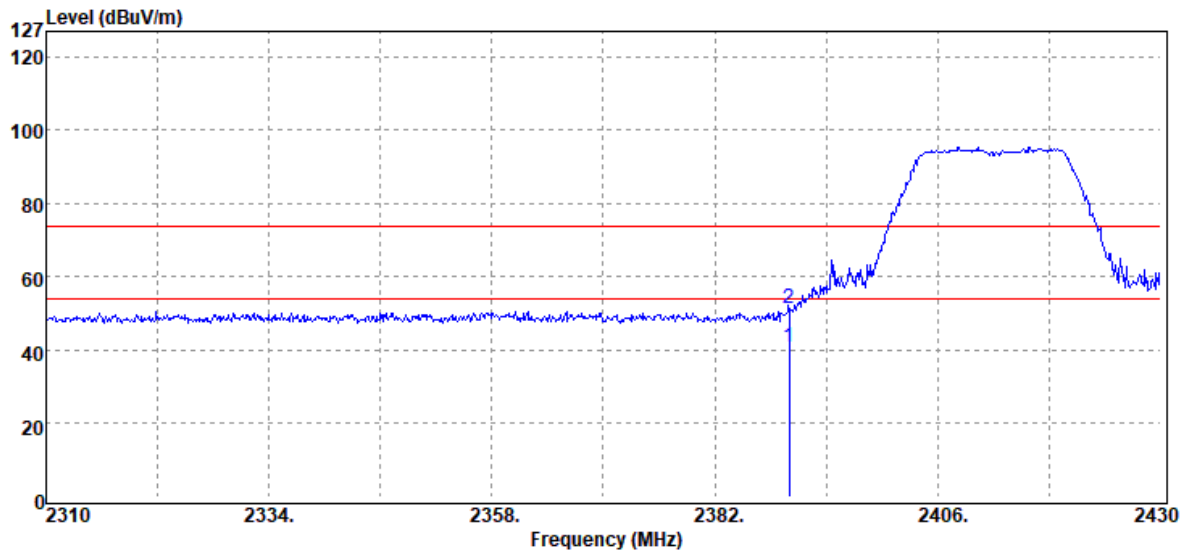

Freq. MHz	Detector Mode	Spectrum Reading Level dB $\mu$ V	Factor dB	Actual FS dB $\mu$ V/m	Limit @3m dB $\mu$ V/m	Margin dB
2390.00	Average	33.47	7.46	40.93	54.00	-13.07
2390.00	Peak	44.12	7.46	51.58	74.00	-22.42

Unless otherwise stated the results shown in this test report refer only to the sample(s) tested and such sample(s) are retained for 90 days only.

除非另有說明，此報告結果僅對測試之樣品負責，同時此樣品僅保留90天。本報告未經本公司書面許可，不可部份複製。

This document is issued by the Company subject to its General Conditions of Service printed overleaf, available on request or accessible at <http://www.sgs.com.tw/Terms-and-Conditions> and for electronic format documents, subject to Terms and Conditions for Electronic Documents at <http://www.sgs.com.tw/Terms-and-Conditions>. Attention is drawn to the limitation of liability, indemnification and jurisdiction issues defined therein. Any holder of this document is advised that information contained hereon reflects the Company's findings at the time of its intervention only and within the limits of Client's instructions, if any. The Company's sole responsibility is to its Client and this document does not exonerate parties to a transaction from exercising all their rights and obligations under the transaction documents. This document cannot be reproduced except in full, without prior written approval of the Company. Any unauthorized alteration, forgery or falsification of the content or appearance of this document is unlawful and offenders may be prosecuted to the fullest extent of the law.

Report Number	:ER/2020/70076	Test Site	:SAC I Chamber
Operation Mode	:802.11g	Test Date	:2020-08-11
Test Frequency	:2462 MHz	Temp./Humi.	:26.5/67
Test Mode	:Bandedge CH High	Antenna Pol.	:VERTICAL
EUT Pol	:H Plane	Engineer	:Neo

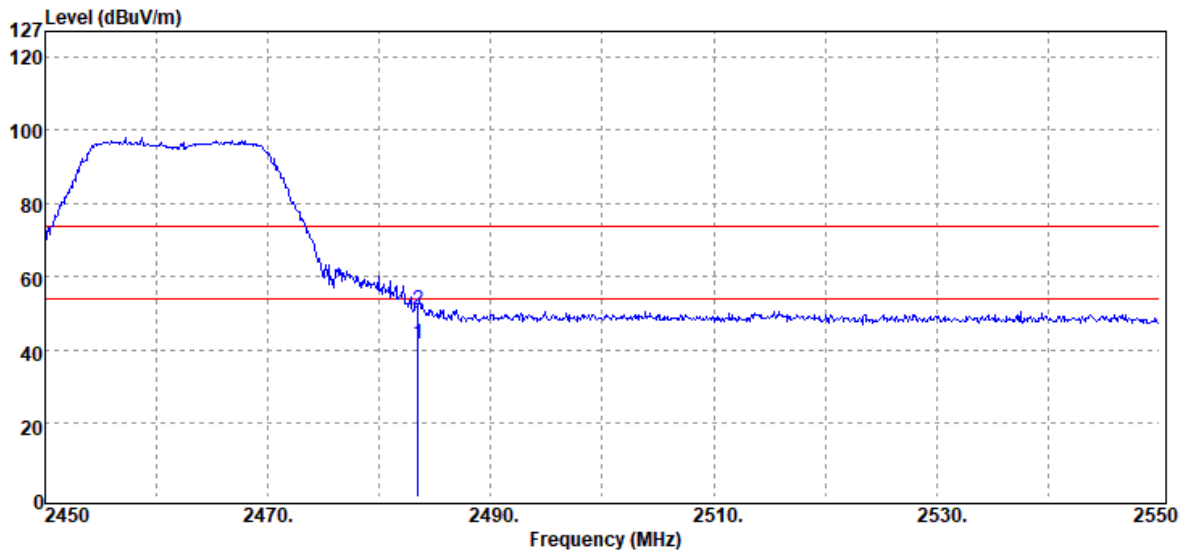

Freq.	Detector	Spectrum	Factor	Actual	Limit	Margin
MHz	Mode	Reading Level	dB	FS	@3m	dB
	PK/QP/AV	dBμV		dBμV/m	dBμV/m	
2483.50	Average	34.15	7.46	41.61	54.00	-12.39
2483.50	Peak	43.64	7.46	51.10	74.00	-22.90

Unless otherwise stated the results shown in this test report refer only to the sample(s) tested and such sample(s) are retained for 90 days only.

除非另有說明，此報告結果僅對測試之樣品負責，同時此樣品僅保留90天。本報告未經本公司書面許可，不可部份複製。

This document is issued by the Company subject to its General Conditions of Service printed overleaf, available on request or accessible at <http://www.sgs.com.tw/Terms-and-Conditions> and for electronic format documents, subject to Terms and Conditions for Electronic Documents at <http://www.sgs.com.tw/Terms-and-Conditions>. Attention is drawn to the limitation of liability, indemnification and jurisdiction issues defined therein. Any holder of this document is advised that information contained hereon reflects the Company's findings at the time of its intervention only and within the limits of Client's instructions, if any. The Company's sole responsibility is to its Client and this document does not exonerate parties to a transaction from exercising all their rights and obligations under the transaction documents. This document cannot be reproduced except in full, without prior written approval of the Company. Any unauthorized alteration, forgery or falsification of the content or appearance of this document is unlawful and offenders may be prosecuted to the fullest extent of the law.

Report Number	:ER/2020/70076	Test Site	:SAC I Chamber
Operation Mode	:802.11g	Test Date	:2020-08-11
Test Frequency	:2462 MHz	Temp./Humi.	:26.5/67
Test Mode	:Bandedge CH High	Antenna Pol.	:HORIZONTAL
EUT Pol	:H Plane	Engineer	:Neo

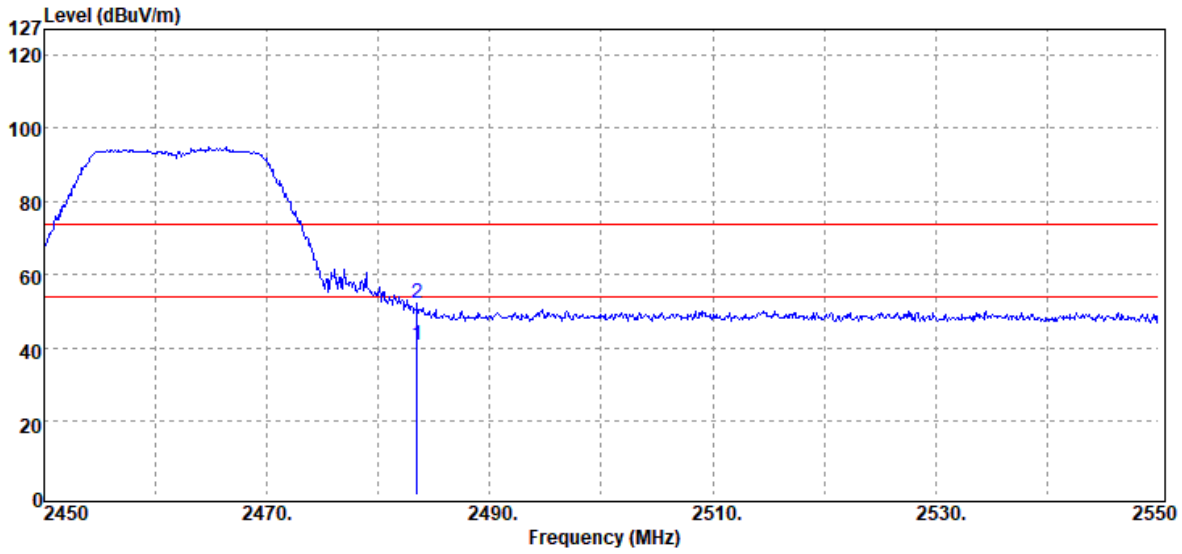

Freq. MHz	Detector Mode	Spectrum Reading Level dB $\mu$ V	Factor dB	Actual FS dB $\mu$ V/m	Limit @3m dB $\mu$ V/m	Margin dB
2483.50	Average	33.55	7.46	41.01	54.00	-12.99
2483.50	Peak	44.97	7.46	52.43	74.00	-21.57

Unless otherwise stated the results shown in this test report refer only to the sample(s) tested and such sample(s) are retained for 90 days only.

除非另有說明，此報告結果僅對測試之樣品負責，同時此樣品僅保留90天。本報告未經本公司書面許可，不可部份複製。

This document is issued by the Company subject to its General Conditions of Service printed overleaf, available on request or accessible at <http://www.sgs.com.tw/Terms-and-Conditions> and for electronic format documents, subject to Terms and Conditions for Electronic Documents at <http://www.sgs.com.tw/Terms-and-Conditions>. Attention is drawn to the limitation of liability, indemnification and jurisdiction issues defined therein. Any holder of this document is advised that information contained hereon reflects the Company's findings at the time of its intervention only and within the limits of Client's instructions, if any. The Company's sole responsibility is to its Client and this document does not exonerate parties to a transaction from exercising all their rights and obligations under the transaction documents. This document cannot be reproduced except in full, without prior written approval of the Company. Any unauthorized alteration, forgery or falsification of the content or appearance of this document is unlawful and offenders may be prosecuted to the fullest extent of the law.

Report Number	:ER/2020/70076	Test Site	:SAC I Chamber
Operation Mode	:802.11g	Test Date	:2020-08-11
Test Frequency	:2467 MHz	Temp./Humi.	:26.5/67
Test Mode	:Bandedge CH High	Antenna Pol.	:VERTICAL
EUT Pol	:H Plane	Engineer	:Neo

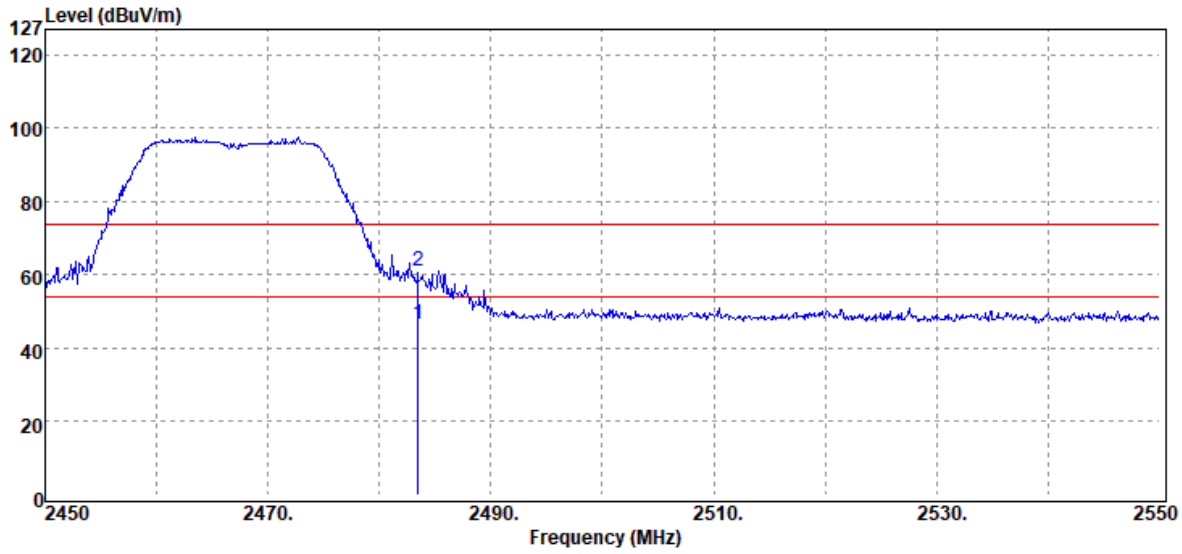

Freq. MHz	Detector Mode	Spectrum Reading Level dB $\mu$ V	Factor dB	Actual FS dB $\mu$ V/m	Limit @3m dB $\mu$ V/m	Margin dB
2483.50	Average	39.23	7.46	46.69	54.00	-7.31
2483.50	Peak	53.81	7.46	61.27	74.00	-12.73

Unless otherwise stated the results shown in this test report refer only to the sample(s) tested and such sample(s) are retained for 90 days only.

除非另有說明，此報告結果僅對測試之樣品負責，同時此樣品僅保留90天。本報告未經本公司書面許可，不可部份複製。

This document is issued by the Company subject to its General Conditions of Service printed overleaf, available on request or accessible at <http://www.sgs.com.tw/Terms-and-Conditions> and for electronic format documents, subject to Terms and Conditions for Electronic Documents at <http://www.sgs.com.tw/Terms-and-Conditions>. Attention is drawn to the limitation of liability, indemnification and jurisdiction issues defined therein. Any holder of this document is advised that information contained hereon reflects the Company's findings at the time of its intervention only and within the limits of Client's instructions, if any. The Company's sole responsibility is to its Client and this document does not exonerate parties to a transaction from exercising all their rights and obligations under the transaction documents. This document cannot be reproduced except in full, without prior written approval of the Company. Any unauthorized alteration, forgery or falsification of the content or appearance of this document is unlawful and offenders may be prosecuted to the fullest extent of the law.

Report Number	:ER/2020/70076	Test Site	:SAC I Chamber
Operation Mode	:802.11g	Test Date	:2020-08-11
Test Frequency	:2467 MHz	Temp./Humi.	:26.5/67
Test Mode	:Bandedge CH High	Antenna Pol.	:HORIZONTAL
EUT Pol	:H Plane	Engineer	:Neo

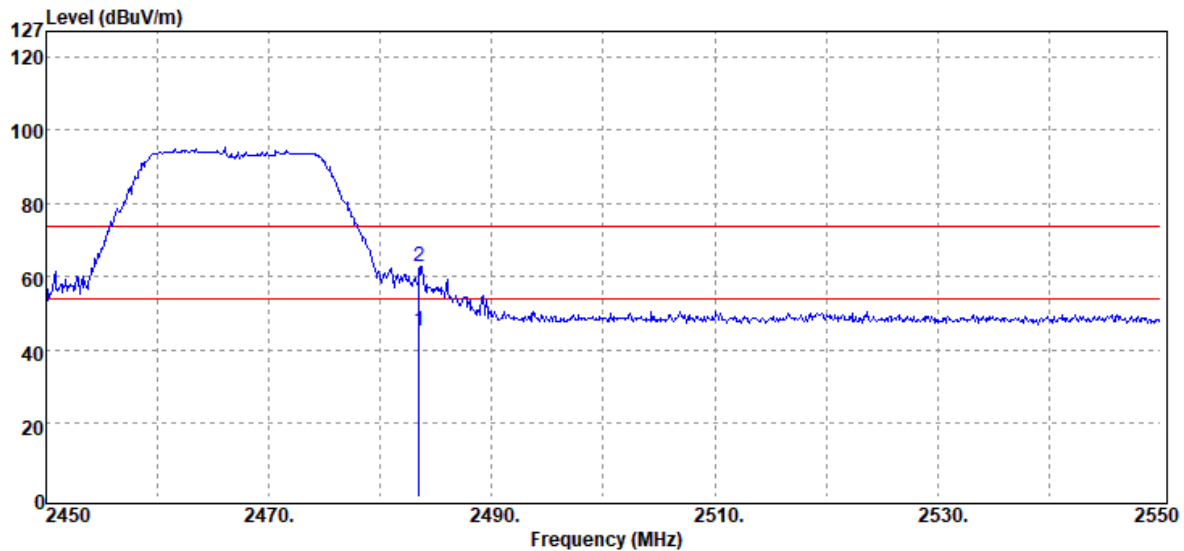

Freq.	Detector	Spectrum	Factor	Actual	Limit	Margin
MHz	Mode	Reading Level	dB	FS	@3m	dB
	PK/QP/AV	dB $\mu$ V		dB $\mu$ V/m	dB $\mu$ V/m	
2483.50	Average	37.95	7.46	45.41	54.00	-8.59
2483.50	Peak	55.49	7.46	62.95	74.00	-11.05

Unless otherwise stated the results shown in this test report refer only to the sample(s) tested and such sample(s) are retained for 90 days only.

除非另有說明，此報告結果僅對測試之樣品負責，同時此樣品僅保留90天。本報告未經本公司書面許可，不可部份複製。

This document is issued by the Company subject to its General Conditions of Service printed overleaf, available on request or accessible at <http://www.sgs.com.tw/Terms-and-Conditions> and for electronic format documents, subject to Terms and Conditions for Electronic Documents at <http://www.sgs.com.tw/Terms-and-Conditions>. Attention is drawn to the limitation of liability, indemnification and jurisdiction issues defined therein. Any holder of this document is advised that information contained hereon reflects the Company's findings at the time of its intervention only and within the limits of Client's instructions, if any. The Company's sole responsibility is to its Client and this document does not exonerate parties to a transaction from exercising all their rights and obligations under the transaction documents. This document cannot be reproduced except in full, without prior written approval of the Company. Any unauthorized alteration, forgery or falsification of the content or appearance of this document is unlawful and offenders may be prosecuted to the fullest extent of the law.

Report Number	:ER/2020/70076	Test Site	:SAC I Chamber
Operation Mode	:802.11g	Test Date	:2020-08-17
Test Frequency	:2472 MHz	Temp./Humi.	:27.2/73
Test Mode	:Bandedge CH High	Antenna Pol.	:VERTICAL
EUT Pol	:H Plane	Engineer	:Neo

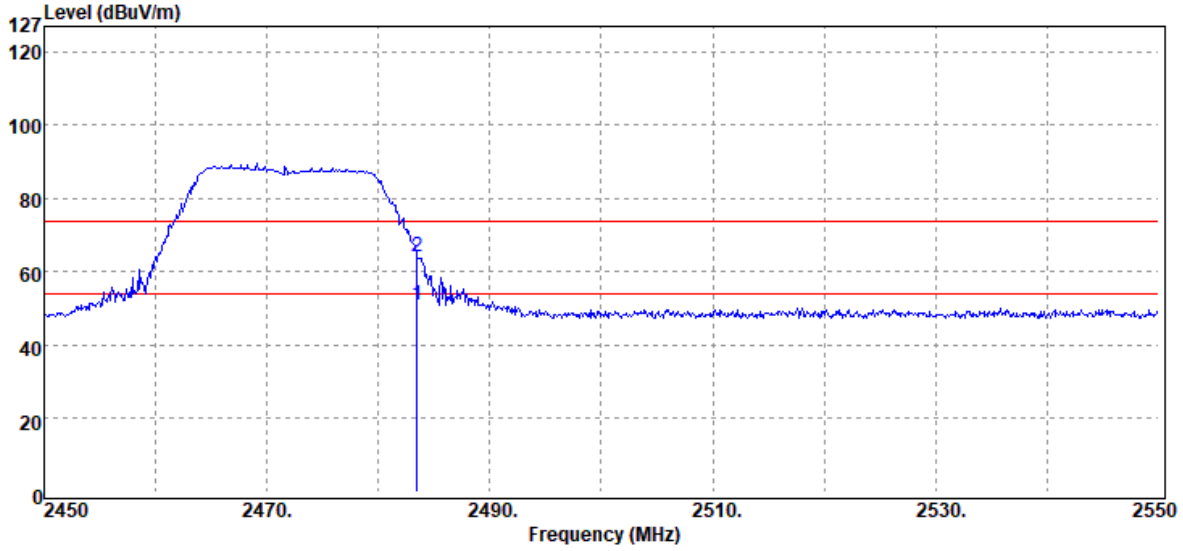

Freq. MHz	Detector Mode	Spectrum Reading Level dB $\mu$ V	Factor dB	Actual FS dB $\mu$ V/m	Limit @3m dB $\mu$ V/m	Margin dB
2483.50	Average	43.46	7.46	50.92	54.00	-3.08
2483.50	Peak	56.75	7.46	64.21	74.00	-9.79

Unless otherwise stated the results shown in this test report refer only to the sample(s) tested and such sample(s) are retained for 90 days only.

除非另有說明，此報告結果僅對測試之樣品負責，同時此樣品僅保留90天。本報告未經本公司書面許可，不可部份複製。

This document is issued by the Company subject to its General Conditions of Service printed overleaf, available on request or accessible at <http://www.sgs.com.tw/Terms-and-Conditions> and for electronic format documents, subject to Terms and Conditions for Electronic Documents at <http://www.sgs.com.tw/Terms-and-Conditions>. Attention is drawn to the limitation of liability, indemnification and jurisdiction issues defined therein. Any holder of this document is advised that information contained hereon reflects the Company's findings at the time of its intervention only and within the limits of Client's instructions, if any. The Company's sole responsibility is to its Client and this document does not exonerate parties to a transaction from exercising all their rights and obligations under the transaction documents. This document cannot be reproduced except in full, without prior written approval of the Company. Any unauthorized alteration, forgery or falsification of the content or appearance of this document is unlawful and offenders may be prosecuted to the fullest extent of the law.

Report Number	:ER/2020/70076	Test Site	:SAC I Chamber
Operation Mode	:802.11g	Test Date	:2020-08-17
Test Frequency	:2472 MHz	Temp./Humi.	:27.2/73
Test Mode	:Bandedge CH High	Antenna Pol.	:HORIZONTAL
EUT Pol	:H Plane	Engineer	:Neo

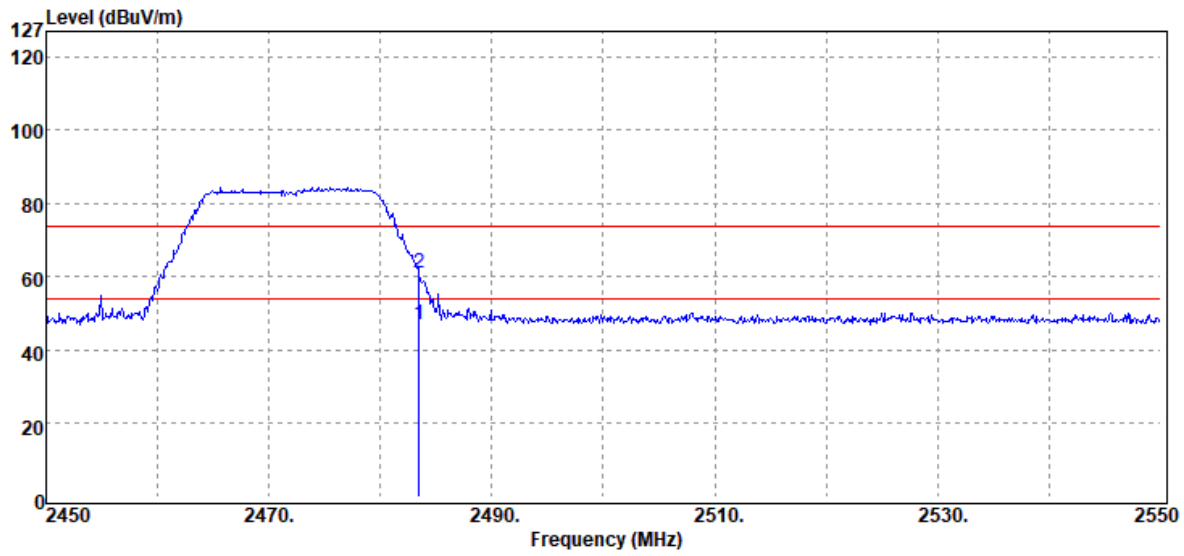

Freq.	Detector	Spectrum	Factor	Actual	Limit	Margin
MHz	Mode	Reading Level	dB	FS	@3m	dB
	PK/QP/AV	dB $\mu$ V		dB $\mu$ V/m	dB $\mu$ V/m	
2483.50	Average	39.72	7.46	47.18	54.00	-6.82
2483.50	Peak	53.60	7.46	61.06	74.00	-12.94

Unless otherwise stated the results shown in this test report refer only to the sample(s) tested and such sample(s) are retained for 90 days only.

除非另有說明，此報告結果僅對測試之樣品負責，同時此樣品僅保留90天。本報告未經本公司書面許可，不可部份複製。

This document is issued by the Company subject to its General Conditions of Service printed overleaf, available on request or accessible at <http://www.sgs.com.tw/Terms-and-Conditions> and for electronic format documents, subject to Terms and Conditions for Electronic Documents at <http://www.sgs.com.tw/Terms-and-Conditions>. Attention is drawn to the limitation of liability, indemnification and jurisdiction issues defined therein. Any holder of this document is advised that information contained hereon reflects the Company's findings at the time of its intervention only and within the limits of Client's instructions, if any. The Company's sole responsibility is to its Client and this document does not exonerate parties to a transaction from exercising all their rights and obligations under the transaction documents. This document cannot be reproduced except in full, without prior written approval of the Company. Any unauthorized alteration, forgery or falsification of the content or appearance of this document is unlawful and offenders may be prosecuted to the fullest extent of the law.

Report Number	:ER/2020/70076	Test Site	:SAC I Chamber
Operation Mode	:802.11n20	Test Date	:2020-08-12
Test Frequency	:2412 MHz	Temp./Humi.	:26.5/71
Test Mode	:Bandedge CH Low	Antenna Pol.	:VERTICAL
EUT Pol	:H Plane	Engineer	:Neo

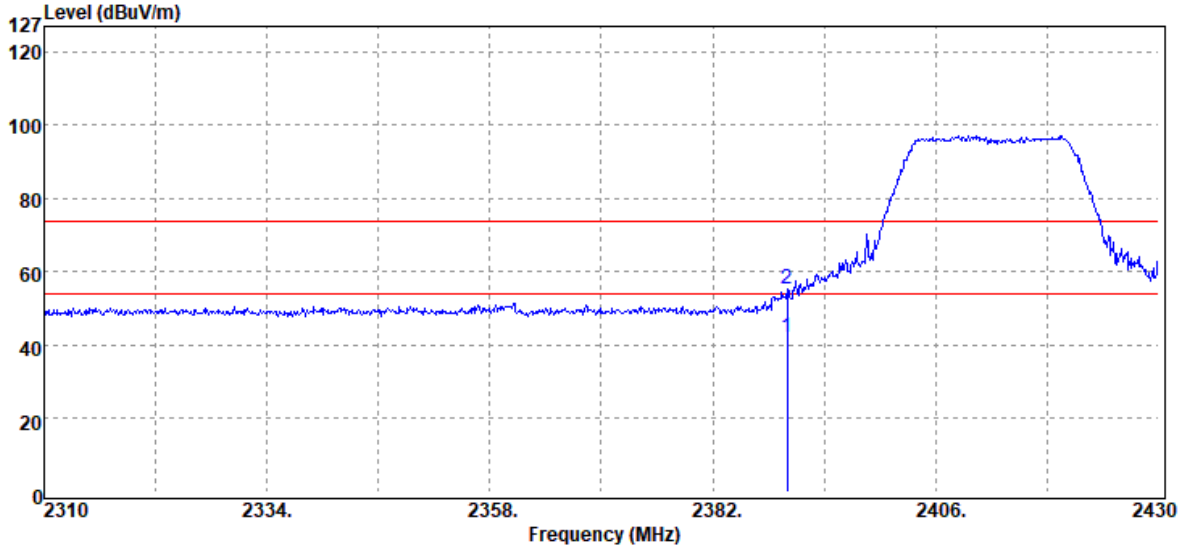

Freq. MHz	Detector Mode	Spectrum Reading Level d $\mu$ V	Factor dB	Actual FS d $\mu$ V/m	Limit @3m d $\mu$ V/m	Margin dB
2390.00	Average	34.73	7.46	42.19	54.00	-11.81
2390.00	Peak	47.79	7.46	55.25	74.00	-18.75

Unless otherwise stated the results shown in this test report refer only to the sample(s) tested and such sample(s) are retained for 90 days only.

除非另有說明，此報告結果僅對測試之樣品負責，同時此樣品僅保留90天。本報告未經本公司書面許可，不可部份複製。

This document is issued by the Company subject to its General Conditions of Service printed overleaf, available on request or accessible at <http://www.sgs.com.tw/Terms-and-Conditions> and for electronic format documents, subject to Terms and Conditions for Electronic Documents at <http://www.sgs.com.tw/Terms-and-Conditions>. Attention is drawn to the limitation of liability, indemnification and jurisdiction issues defined therein. Any holder of this document is advised that information contained hereon reflects the Company's findings at the time of its intervention only and within the limits of Client's instructions, if any. The Company's sole responsibility is to its Client and this document does not exonerate parties to a transaction from exercising all their rights and obligations under the transaction documents. This document cannot be reproduced except in full, without prior written approval of the Company. Any unauthorized alteration, forgery or falsification of the content or appearance of this document is unlawful and offenders may be prosecuted to the fullest extent of the law.



Report Number	:ER/2020/70076	Test Site	:SAC I Chamber
Operation Mode	:802.11n20	Test Date	:2020-08-12
Test Frequency	:2412 MHz	Temp./Humi.	:26.5/71
Test Mode	:Bandedge CH Low	Antenna Pol.	:HORIZONTAL
EUT Pol	:H Plane	Engineer	:Neo

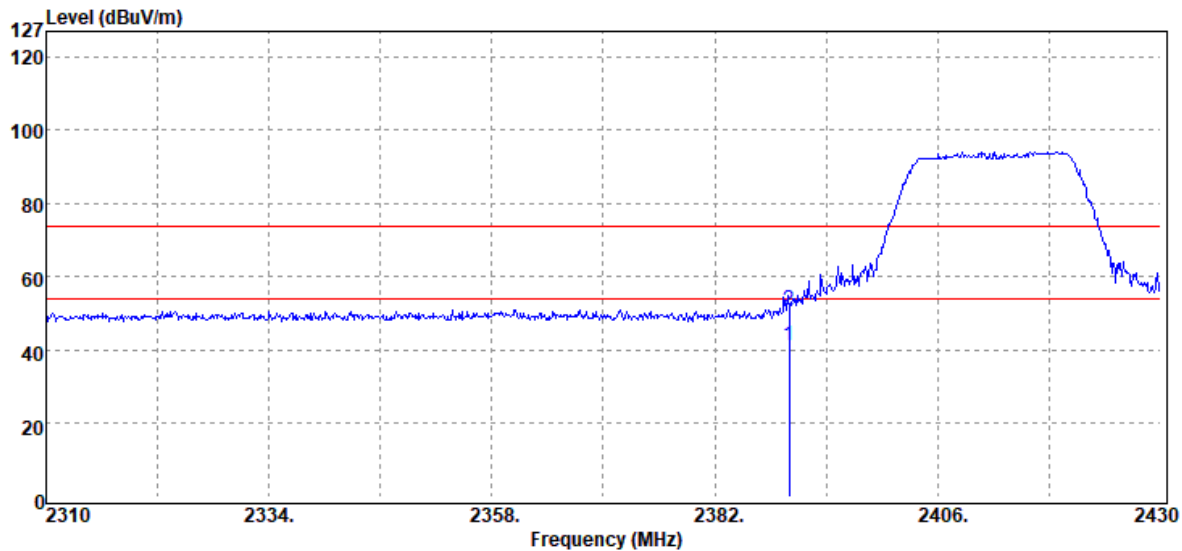

Freq. MHz	Detector Mode	Spectrum Reading Level dB $\mu$ V	Factor dB	Actual FS dB $\mu$ V/m	Limit @3m dB $\mu$ V/m	Margin dB
2390.00	Average	33.96	7.46	41.42	54.00	-12.58
2390.00	Peak	43.50	7.46	50.96	74.00	-23.04

Unless otherwise stated the results shown in this test report refer only to the sample(s) tested and such sample(s) are retained for 90 days only.

除非另有說明，此報告結果僅對測試之樣品負責，同時此樣品僅保留90天。本報告未經本公司書面許可，不可部份複製。

This document is issued by the Company subject to its General Conditions of Service printed overleaf, available on request or accessible at <http://www.sgs.com.tw/Terms-and-Conditions> and for electronic format documents, subject to Terms and Conditions for Electronic Documents at <http://www.sgs.com.tw/Terms-and-Conditions>. Attention is drawn to the limitation of liability, indemnification and jurisdiction issues defined therein. Any holder of this document is advised that information contained hereon reflects the Company's findings at the time of its intervention only and within the limits of Client's instructions, if any. The Company's sole responsibility is to its Client and this document does not exonerate parties to a transaction from exercising all their rights and obligations under the transaction documents. This document cannot be reproduced except in full, without prior written approval of the Company. Any unauthorized alteration, forgery or falsification of the content or appearance of this document is unlawful and offenders may be prosecuted to the fullest extent of the law.

Report Number	:ER/2020/70076	Test Site	:SAC I Chamber
Operation Mode	:802.11n20	Test Date	:2020-08-12
Test Frequency	:2462 MHz	Temp./Humi.	:26.5/71
Test Mode	:Bandedge CH High	Antenna Pol.	:VERTICAL
EUT Pol	:H Plane	Engineer	:Neo

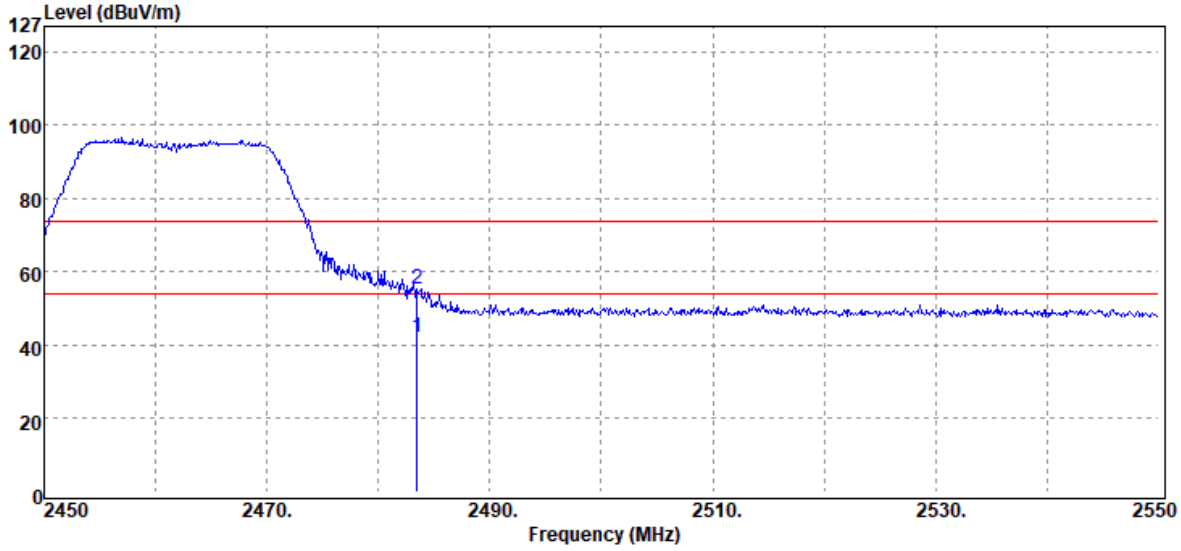

Freq. MHz	Detector Mode	Spectrum Reading Level dB $\mu$ V	Factor dB	Actual FS dB $\mu$ V/m	Limit @3m dB $\mu$ V/m	Margin dB
2483.50	Average	34.56	7.46	42.02	54.00	-11.98
2483.50	Peak	47.92	7.46	55.38	74.00	-18.62

Unless otherwise stated the results shown in this test report refer only to the sample(s) tested and such sample(s) are retained for 90 days only.

除非另有說明，此報告結果僅對測試之樣品負責，同時此樣品僅保留90天。本報告未經本公司書面許可，不可部份複製。

This document is issued by the Company subject to its General Conditions of Service printed overleaf, available on request or accessible at <http://www.sgs.com.tw/Terms-and-Conditions> and for electronic format documents, subject to Terms and Conditions for Electronic Documents at <http://www.sgs.com.tw/Terms-and-Conditions>. Attention is drawn to the limitation of liability, indemnification and jurisdiction issues defined therein. Any holder of this document is advised that information contained hereon reflects the Company's findings at the time of its intervention only and within the limits of Client's instructions, if any. The Company's sole responsibility is to its Client and this document does not exonerate parties to a transaction from exercising all their rights and obligations under the transaction documents. This document cannot be reproduced except in full, without prior written approval of the Company. Any unauthorized alteration, forgery or falsification of the content or appearance of this document is unlawful and offenders may be prosecuted to the fullest extent of the law.

Report Number	:ER/2020/70076	Test Site	:SAC I Chamber
Operation Mode	:802.11n20	Test Date	:2020-08-12
Test Frequency	:2462 MHz	Temp./Humi.	:26.5/71
Test Mode	:Bandedge CH High	Antenna Pol.	:HORIZONTAL
EUT Pol	:H Plane	Engineer	:Neo

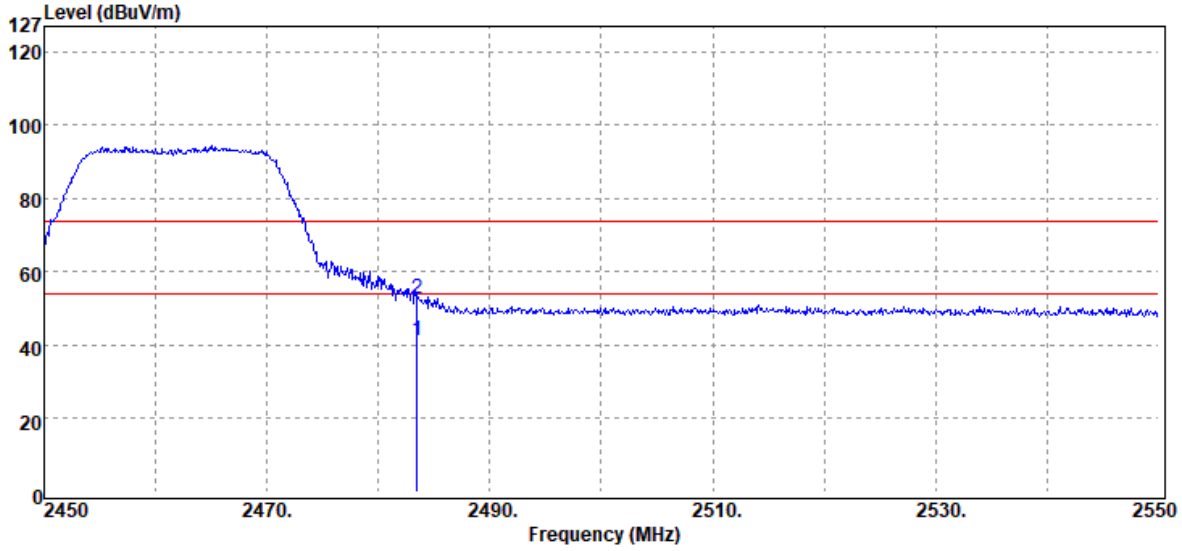

Freq. MHz	Detector Mode	Spectrum Reading Level dB $\mu$ V	Factor dB	Actual FS dB $\mu$ V/m	Limit @3m dB $\mu$ V/m	Margin dB
2483.50	Average	33.89	7.46	41.35	54.00	-12.65
2483.50	Peak	45.09	7.46	52.55	74.00	-21.45

Unless otherwise stated the results shown in this test report refer only to the sample(s) tested and such sample(s) are retained for 90 days only.

除非另有說明，此報告結果僅對測試之樣品負責，同時此樣品僅保留90天。本報告未經本公司書面許可，不可部份複製。

This document is issued by the Company subject to its General Conditions of Service printed overleaf, available on request or accessible at <http://www.sgs.com.tw/Terms-and-Conditions> and for electronic format documents, subject to Terms and Conditions for Electronic Documents at <http://www.sgs.com.tw/Terms-and-Conditions>. Attention is drawn to the limitation of liability, indemnification and jurisdiction issues defined therein. Any holder of this document is advised that information contained hereon reflects the Company's findings at the time of its intervention only and within the limits of Client's instructions, if any. The Company's sole responsibility is to its Client and this document does not exonerate parties to a transaction from exercising all their rights and obligations under the transaction documents. This document cannot be reproduced except in full, without prior written approval of the Company. Any unauthorized alteration, forgery or falsification of the content or appearance of this document is unlawful and offenders may be prosecuted to the fullest extent of the law.

Report Number	:ER/2020/70076	Test Site	:SAC I Chamber
Operation Mode	:802.11n20	Test Date	:2020-08-12
Test Frequency	:2467 MHz	Temp./Humi.	:26.5/71
Test Mode	:Bandedge CH High	Antenna Pol.	:VERTICAL
EUT Pol	:H Plane	Engineer	:Neo

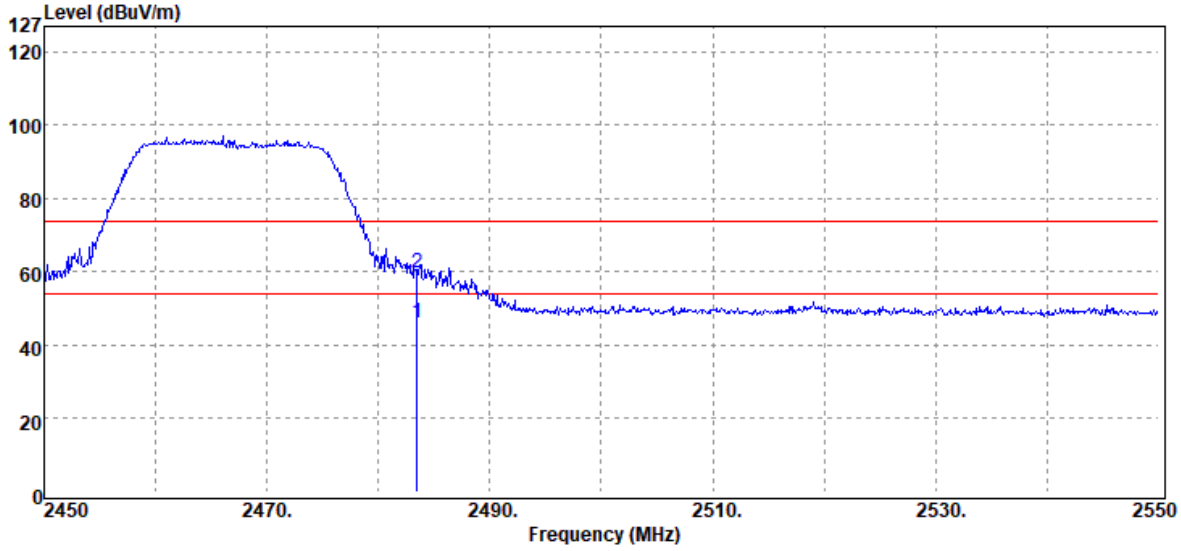

Freq. MHz	Detector Mode	Spectrum Reading Level dB $\mu$ V	Factor dB	Actual FS dB $\mu$ V/m	Limit @3m dB $\mu$ V/m	Margin dB
2483.50	Average	38.52	7.46	45.98	54.00	-8.02
2483.50	Peak	52.37	7.46	59.83	74.00	-14.17

Unless otherwise stated the results shown in this test report refer only to the sample(s) tested and such sample(s) are retained for 90 days only.

除非另有說明，此報告結果僅對測試之樣品負責，同時此樣品僅保留90天。本報告未經本公司書面許可，不可部份複製。

This document is issued by the Company subject to its General Conditions of Service printed overleaf, available on request or accessible at <http://www.sgs.com.tw/Terms-and-Conditions> and for electronic format documents, subject to Terms and Conditions for Electronic Documents at <http://www.sgs.com.tw/Terms-and-Conditions>. Attention is drawn to the limitation of liability, indemnification and jurisdiction issues defined therein. Any holder of this document is advised that information contained hereon reflects the Company's findings at the time of its intervention only and within the limits of Client's instructions, if any. The Company's sole responsibility is to its Client and this document does not exonerate parties to a transaction from exercising all their rights and obligations under the transaction documents. This document cannot be reproduced except in full, without prior written approval of the Company. Any unauthorized alteration, forgery or falsification of the content or appearance of this document is unlawful and offenders may be prosecuted to the fullest extent of the law.

Report Number	:ER/2020/70076	Test Site	:SAC I Chamber
Operation Mode	:802.11n20	Test Date	:2020-08-12
Test Frequency	:2467 MHz	Temp./Humi.	:26.5/71
Test Mode	:Bandedge CH High	Antenna Pol.	:HORIZONTAL
EUT Pol	:H Plane	Engineer	:Neo

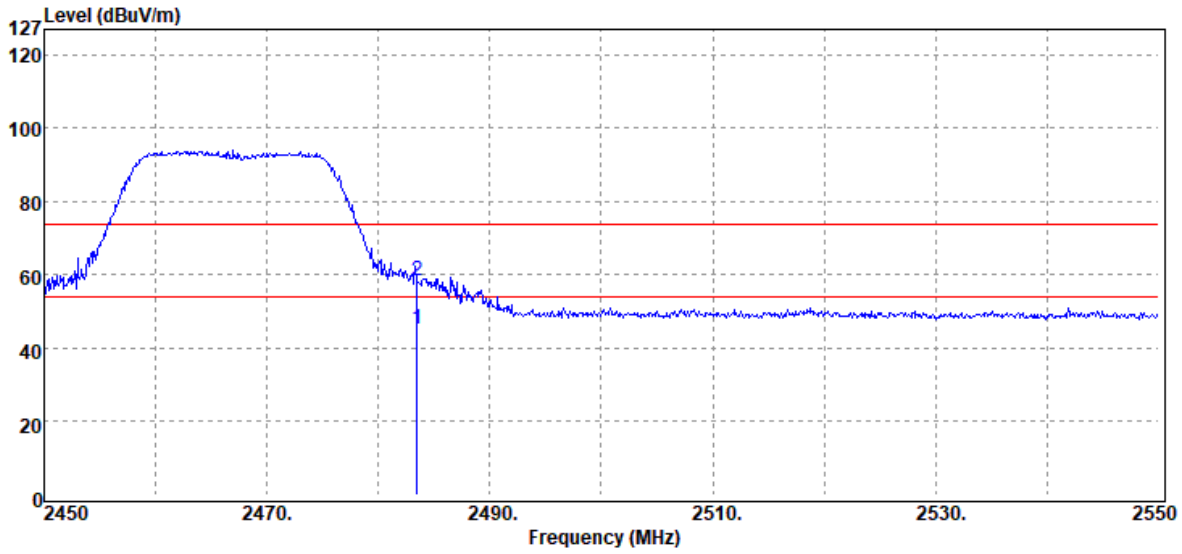

Freq. MHz	Detector Mode	Spectrum Reading Level dBµV	Factor dB	Actual FS dBµV/m	Limit @3m dBµV/m	Margin dB
2483.50	Average	37.71	7.46	45.17	54.00	-8.83
2483.50	Peak	50.82	7.46	58.28	74.00	-15.72

Unless otherwise stated the results shown in this test report refer only to the sample(s) tested and such sample(s) are retained for 90 days only.

除非另有說明，此報告結果僅對測試之樣品負責，同時此樣品僅保留90天。本報告未經本公司書面許可，不可部份複製。

This document is issued by the Company subject to its General Conditions of Service printed overleaf, available on request or accessible at <http://www.sgs.com.tw/Terms-and-Conditions> and for electronic format documents, subject to Terms and Conditions for Electronic Documents at <http://www.sgs.com.tw/Terms-and-Conditions>. Attention is drawn to the limitation of liability, indemnification and jurisdiction issues defined therein. Any holder of this document is advised that information contained hereon reflects the Company's findings at the time of its intervention only and within the limits of Client's instructions, if any. The Company's sole responsibility is to its Client and this document does not exonerate parties to a transaction from exercising all their rights and obligations under the transaction documents. This document cannot be reproduced except in full, without prior written approval of the Company. Any unauthorized alteration, forgery or falsification of the content or appearance of this document is unlawful and offenders may be prosecuted to the fullest extent of the law.

Report Number	:ER/2020/70076	Test Site	:SAC I Chamber
Operation Mode	:802.11n20	Test Date	:2020-08-17
Test Frequency	:2472 MHz	Temp./Humi.	:27.2/73
Test Mode	:Bandedge CH High	Antenna Pol.	:VERTICAL
EUT Pol	:H Plane	Engineer	:Neo

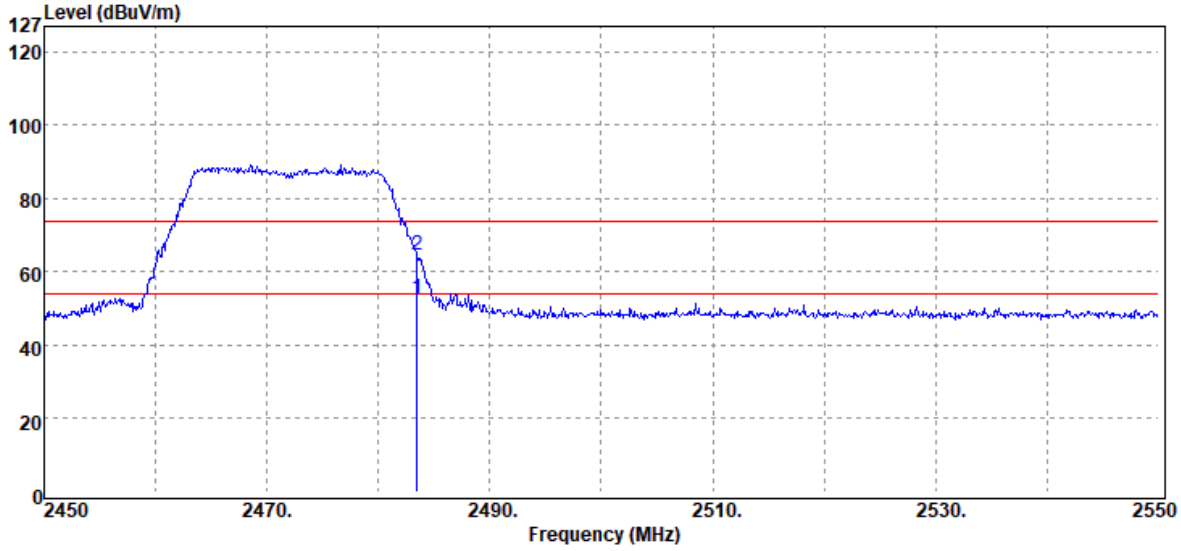

Freq. MHz	Detector Mode	Spectrum Reading Level dB $\mu$ V	Factor dB	Actual FS dB $\mu$ V/m	Limit @3m dB $\mu$ V/m	Margin dB
2483.50	Average	45.27	7.46	52.73	54.00	-1.27
2483.50	Peak	57.02	7.46	64.48	74.00	-9.52

Unless otherwise stated the results shown in this test report refer only to the sample(s) tested and such sample(s) are retained for 90 days only.

除非另有說明，此報告結果僅對測試之樣品負責，同時此樣品僅保留90天。本報告未經本公司書面許可，不可部份複製。

This document is issued by the Company subject to its General Conditions of Service printed overleaf, available on request or accessible at <http://www.sgs.com.tw/Terms-and-Conditions> and for electronic format documents, subject to Terms and Conditions for Electronic Documents at <http://www.sgs.com.tw/Terms-and-Conditions>. Attention is drawn to the limitation of liability, indemnification and jurisdiction issues defined therein. Any holder of this document is advised that information contained hereon reflects the Company's findings at the time of its intervention only and within the limits of Client's instructions, if any. The Company's sole responsibility is to its Client and this document does not exonerate parties to a transaction from exercising all their rights and obligations under the transaction documents. This document cannot be reproduced except in full, without prior written approval of the Company. Any unauthorized alteration, forgery or falsification of the content or appearance of this document is unlawful and offenders may be prosecuted to the fullest extent of the law.

Report Number	:ER/2020/70076	Test Site	:SAC I Chamber
Operation Mode	:802.11n20	Test Date	:2020-08-17
Test Frequency	:2472 MHz	Temp./Humi.	:27.2/73
Test Mode	:Bandedge CH High	Antenna Pol.	:HORIZONTAL
EUT Pol	:H Plane	Engineer	:Neo

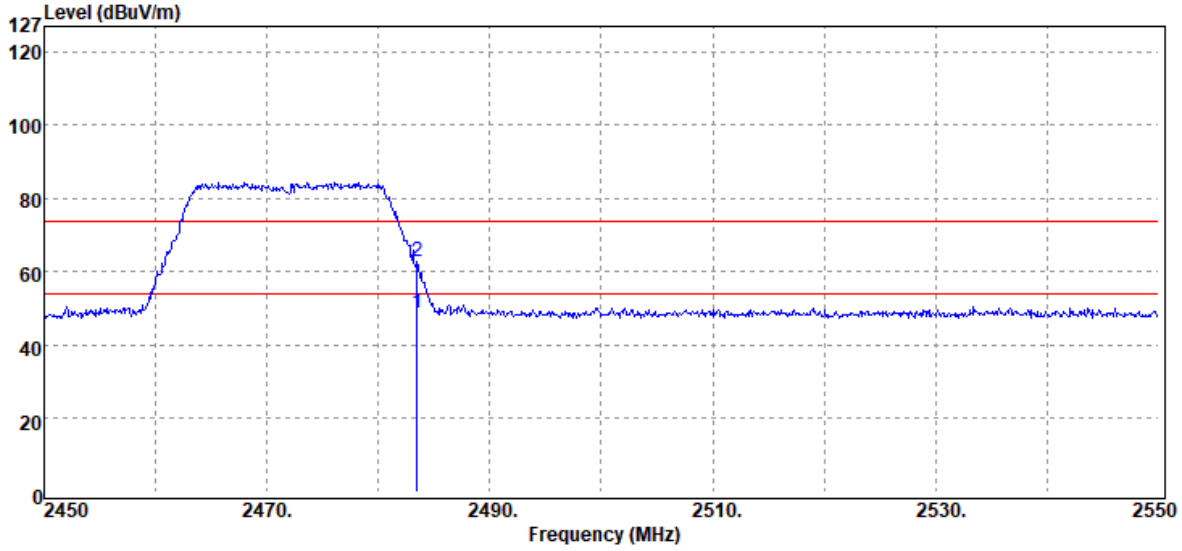

Freq.	Detector	Spectrum	Factor	Actual	Limit	Margin
MHz	Mode	Reading Level	dB	FS	@3m	dB
	PK/QP/AV	dB $\mu$ V		dB $\mu$ V/m	dB $\mu$ V/m	
2483.50	Average	41.11	7.46	48.57	54.00	-5.43
2483.50	Peak	55.59	7.46	63.05	74.00	-10.95

Unless otherwise stated the results shown in this test report refer only to the sample(s) tested and such sample(s) are retained for 90 days only.

除非另有說明，此報告結果僅對測試之樣品負責，同時此樣品僅保留90天。本報告未經本公司書面許可，不可部份複製。

This document is issued by the Company subject to its General Conditions of Service printed overleaf, available on request or accessible at <http://www.sgs.com.tw/Terms-and-Conditions> and for electronic format documents, subject to Terms and Conditions for Electronic Documents at <http://www.sgs.com.tw/Terms-and-Conditions>. Attention is drawn to the limitation of liability, indemnification and jurisdiction issues defined therein. Any holder of this document is advised that information contained hereon reflects the Company's findings at the time of its intervention only and within the limits of Client's instructions, if any. The Company's sole responsibility is to its Client and this document does not exonerate parties to a transaction from exercising all their rights and obligations under the transaction documents. This document cannot be reproduced except in full, without prior written approval of the Company. Any unauthorized alteration, forgery or falsification of the content or appearance of this document is unlawful and offenders may be prosecuted to the fullest extent of the law.

11.7.2 Below 1GHz Worst-Case Emission:

Report Number	:ER/2020/70076	Test Site	:SAC I Chamber
Operation Mode	:802.11g	Test Date	:2020-08-13
Test Frequency	:2437 MHz	Temp./Humi.	:25.0/66
Test Mode	:Tx CH Mid	Antenna Pol.	:VERTICAL
EUT Pol	:H Plane	Engineer	:Neo

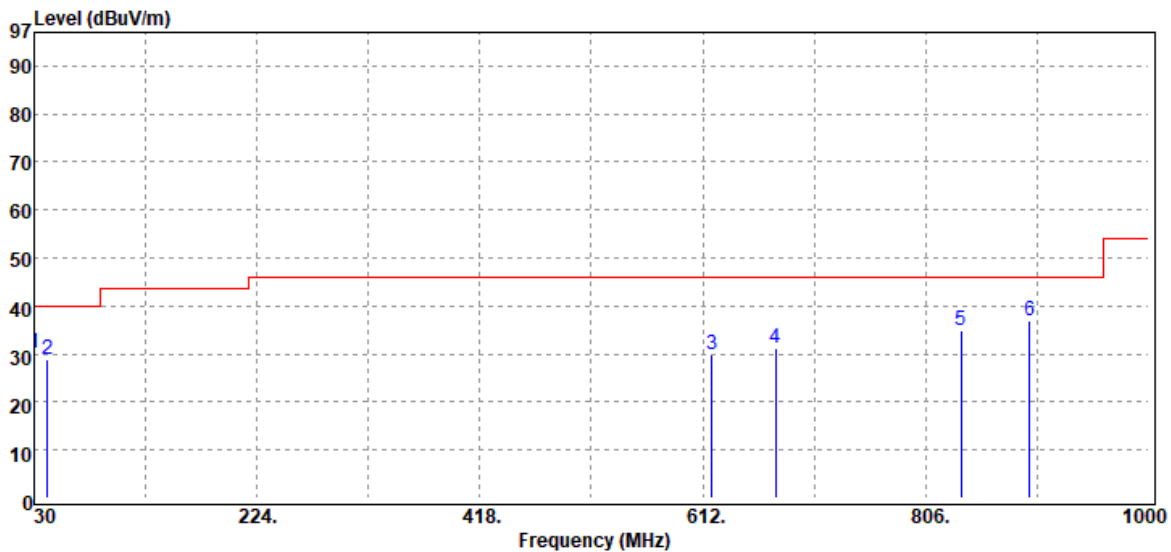

Freq. MHz	Detector Mode PK/QP/AV	Spectrum Reading Level d $\mu$ V	Factor dB	Actual FS d $\mu$ V/m	Limit @3m d $\mu$ V/m	Margin dB
30.00	Peak	34.81	-4.56	30.25	40.00	-9.75
41.64	Peak	39.66	-10.86	28.80	40.00	-11.20
619.76	Peak	33.28	-3.39	29.89	46.00	-16.11
675.05	Peak	33.50	-2.36	31.14	46.00	-14.86
837.04	Peak	34.53	0.25	34.78	46.00	-11.22
896.21	Peak	35.87	1.18	37.05	46.00	-8.95

Unless otherwise stated the results shown in this test report refer only to the sample(s) tested and such sample(s) are retained for 90 days only.

除非另有說明，此報告結果僅對測試之樣品負責，同時此樣品僅保留90天。本報告未經本公司書面許可，不可部份複製。

This document is issued by the Company subject to its General Conditions of Service printed overleaf, available on request or accessible at <http://www.sgs.com.tw/Terms-and-Conditions> and for electronic format documents, subject to Terms and Conditions for Electronic Documents at <http://www.sgs.com.tw/Terms-and-Conditions>. Attention is drawn to the limitation of liability, indemnification and jurisdiction issues defined therein. Any holder of this document is advised that information contained hereon reflects the Company's findings at the time of its intervention only and within the limits of Client's instructions, if any. The Company's sole responsibility is to its Client and this document does not exonerate parties to a transaction from exercising all their rights and obligations under the transaction documents. This document cannot be reproduced except in full, without prior written approval of the Company. Any unauthorized alteration, forgery or falsification of the content or appearance of this document is unlawful and offenders may be prosecuted to the fullest extent of the law.



Report Number :ER/2020/70076  
 Operation Mode :802.11g  
 Test Frequency :2437 MHz  
 Test Mode :Tx CH Mid  
 EUT Pol :H Plane

Test Site :SAC I Chamber  
 Test Date :2020-08-13  
 Temp./Humi. :25.0/66  
 Antenna Pol. :HORIZONTAL  
 Engineer :Neo

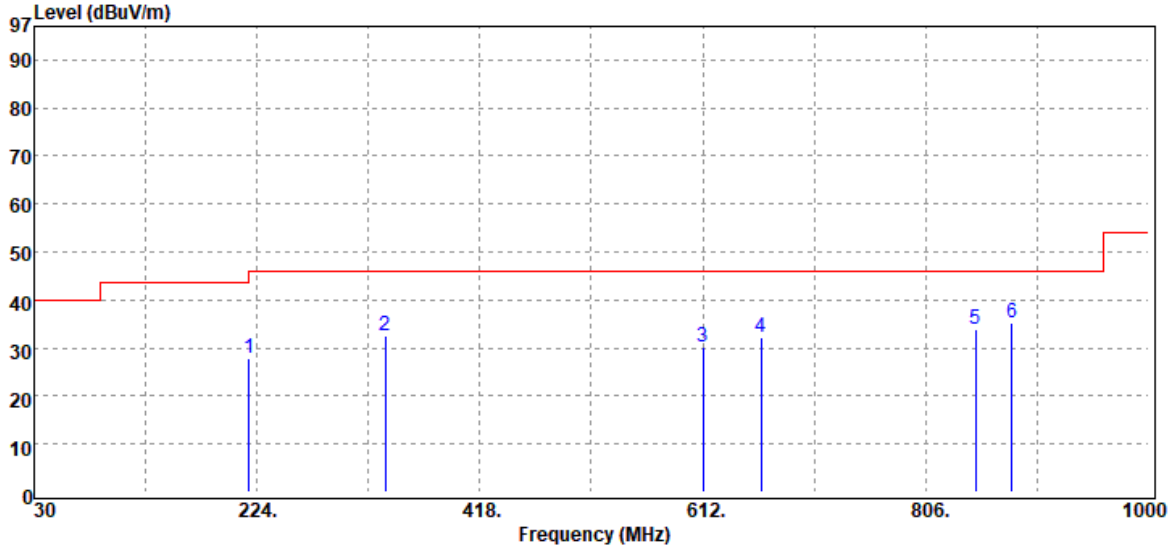

Freq. MHz	Detector Mode PK/QP/AV	Spectrum Reading Level dBμV	Factor dB	Actual FS dBμV/m	Limit @3m dBμV/m	Margin dB
217.21	Peak	39.72	-12.00	27.72	46.00	-18.28
335.55	Peak	40.18	-7.67	32.51	46.00	-13.49
612.00	Peak	33.64	-3.31	30.33	46.00	-15.67
662.44	Peak	35.35	-3.08	32.27	46.00	-13.73
849.65	Peak	33.43	0.35	33.78	46.00	-12.22
880.69	Peak	34.65	0.64	35.29	46.00	-10.71

Unless otherwise stated the results shown in this test report refer only to the sample(s) tested and such sample(s) are retained for 90 days only.

除非另有說明，此報告結果僅對測試之樣品負責，同時此樣品僅保留90天。本報告未經本公司書面許可，不可部份複製。

This document is issued by the Company subject to its General Conditions of Service printed overleaf, available on request or accessible at <http://www.sgs.com.tw/Terms-and-Conditions> and for electronic format documents, subject to Terms and Conditions for Electronic Documents at <http://www.sgs.com.tw/Terms-and-Conditions>. Attention is drawn to the limitation of liability, indemnification and jurisdiction issues defined therein. Any holder of this document is advised that information contained hereon reflects the Company's findings at the time of its intervention only and within the limits of Client's instructions, if any. The Company's sole responsibility is to its Client and this document does not exonerate parties to a transaction from exercising all their rights and obligations under the transaction documents. This document cannot be reproduced except in full, without prior written approval of the Company. Any unauthorized alteration, forgery or falsification of the content or appearance of this document is unlawful and offenders may be prosecuted to the fullest extent of the law.

**11.7.3 Above 1GHz Emission:**

Report Number	:ER/2020/70076	Test Site	:SAC I Chamber
Operation Mode	:802.11b	Test Date	:2020-08-12
Test Frequency	:2412 MHz	Temp./Humi.	:26.5/71
Test Mode	:Tx CH Low	Antenna Pol.	:VERTICAL
EUT Pol	:H Plane	Engineer	:Neo

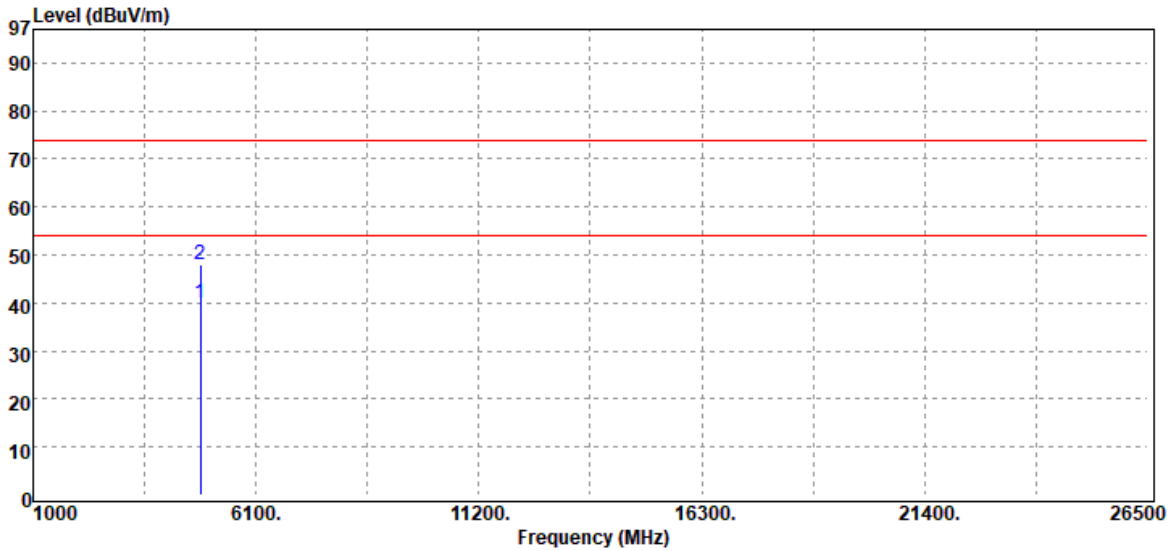

Freq. MHz	Detector Mode PK/QP/AV	Spectrum Reading Level d $\mu$ V	Factor dB	Actual FS d $\mu$ V/m	Limit @3m d $\mu$ V/m	Margin dB
4824.00	Average	25.32	14.56	39.88	54.00	-14.12
4824.00	Peak	33.30	14.56	47.86	74.00	-26.14

Unless otherwise stated the results shown in this test report refer only to the sample(s) tested and such sample(s) are retained for 90 days only.

除非另有說明，此報告結果僅對測試之樣品負責，同時此樣品僅保留90天。本報告未經本公司書面許可，不可部份複製。

This document is issued by the Company subject to its General Conditions of Service printed overleaf, available on request or accessible at <http://www.sgs.com.tw/Terms-and-Conditions> and for electronic format documents, subject to Terms and Conditions for Electronic Documents at <http://www.sgs.com.tw/Terms-and-Conditions>. Attention is drawn to the limitation of liability, indemnification and jurisdiction issues defined therein. Any holder of this document is advised that information contained hereon reflects the Company's findings at the time of its intervention only and within the limits of Client's instructions, if any. The Company's sole responsibility is to its Client and this document does not exonerate parties to a transaction from exercising all their rights and obligations under the transaction documents. This document cannot be reproduced except in full, without prior written approval of the Company. Any unauthorized alteration, forgery or falsification of the content or appearance of this document is unlawful and offenders may be prosecuted to the fullest extent of the law.

Report Number :ER/2020/70076  
 Operation Mode :802.11b  
 Test Frequency :2412 MHz  
 Test Mode :Tx CH Low  
 EUT Pol :H Plane

Test Site :SAC I Chamber  
 Test Date :2020-08-12  
 Temp./Humi. :26.5/71  
 Antenna Pol. :HORIZONTAL  
 Engineer :Neo

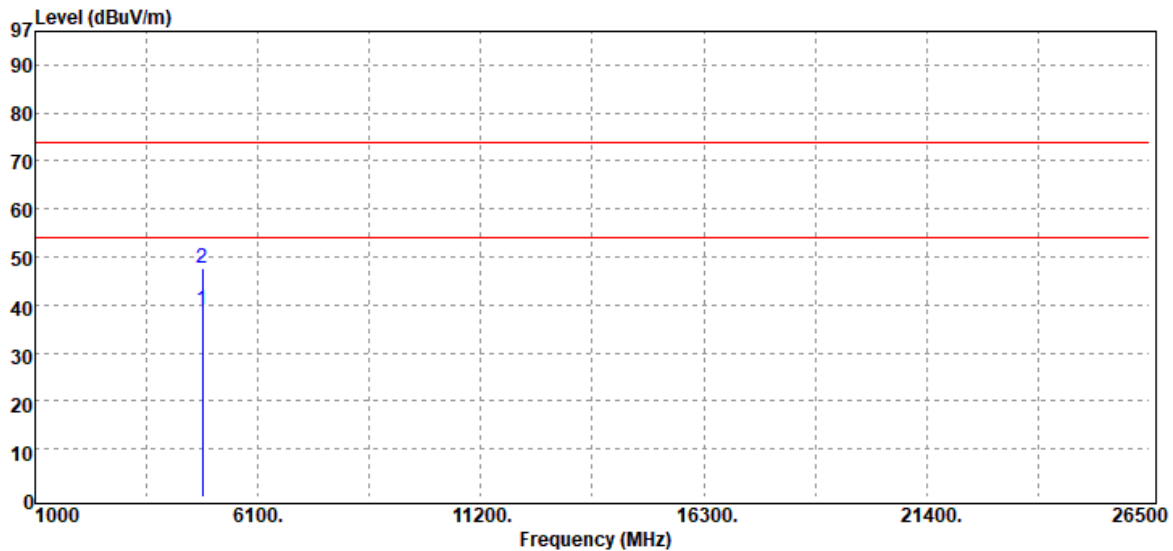

Freq. MHz	Detector Mode	Spectrum Reading Level dB $\mu$ V	Factor dB	Actual FS dB $\mu$ V/m	Limit @3m dB $\mu$ V/m	Margin dB
4824.00	Average	24.30	14.56	38.86	54.00	-15.14
4824.00	Peak	32.95	14.56	47.51	74.00	-26.49

Unless otherwise stated the results shown in this test report refer only to the sample(s) tested and such sample(s) are retained for 90 days only.

除非另有說明，此報告結果僅對測試之樣品負責，同時此樣品僅保留90天。本報告未經本公司書面許可，不可部份複製。

This document is issued by the Company subject to its General Conditions of Service printed overleaf, available on request or accessible at <http://www.sgs.com.tw/Terms-and-Conditions> and for electronic format documents, subject to Terms and Conditions for Electronic Documents at <http://www.sgs.com.tw/Terms-and-Conditions>. Attention is drawn to the limitation of liability, indemnification and jurisdiction issues defined therein. Any holder of this document is advised that information contained hereon reflects the Company's findings at the time of its intervention only and within the limits of Client's instructions, if any. The Company's sole responsibility is to its Client and this document does not exonerate parties to a transaction from exercising all their rights and obligations under the transaction documents. This document cannot be reproduced except in full, without prior written approval of the Company. Any unauthorized alteration, forgery or falsification of the content or appearance of this document is unlawful and offenders may be prosecuted to the fullest extent of the law.

Report Number :ER/2020/70076  
 Operation Mode :802.11b  
 Test Frequency :2437 MHz  
 Test Mode :Tx CH Mid  
 EUT Pol :H Plane

Test Site :SAC I Chamber  
 Test Date :2020-08-12  
 Temp./Humi. :26.5/71  
 Antenna Pol. :VERTICAL  
 Engineer :Neo

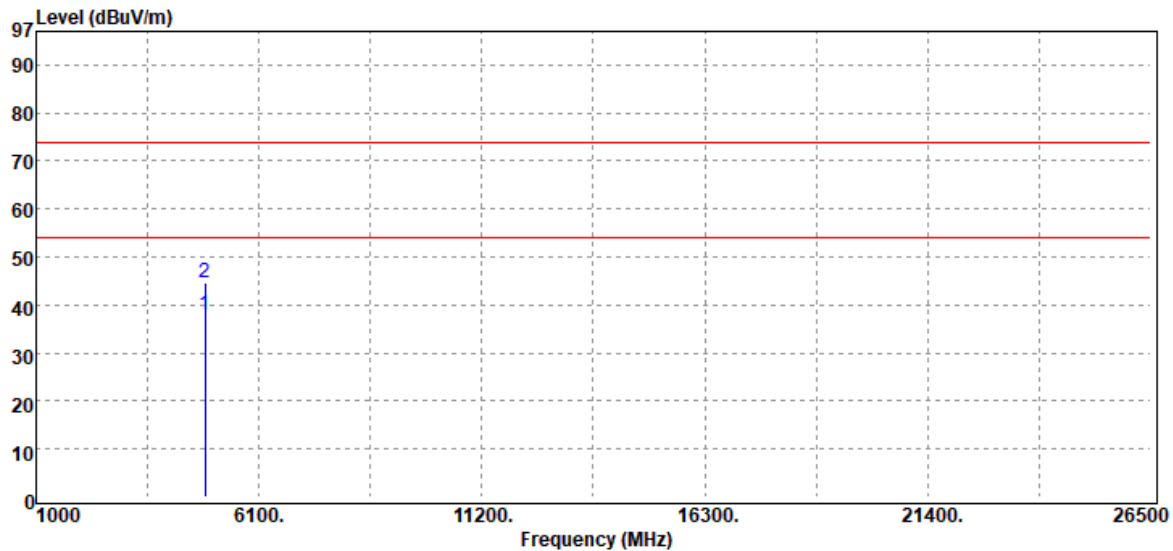

Freq. MHz	Detector Mode PK/QP/AV	Spectrum Reading Level dB $\mu$ V	Factor dB	Actual FS dB $\mu$ V/m	Limit @3m dB $\mu$ V/m	Margin dB
4874.00	Average	23.07	14.85	37.92	54.00	-16.08
4874.00	Peak	29.66	14.85	44.51	74.00	-29.49

Unless otherwise stated the results shown in this test report refer only to the sample(s) tested and such sample(s) are retained for 90 days only.

除非另有說明，此報告結果僅對測試之樣品負責，同時此樣品僅保留90天。本報告未經本公司書面許可，不可部份複製。

This document is issued by the Company subject to its General Conditions of Service printed overleaf, available on request or accessible at <http://www.sgs.com.tw/Terms-and-Conditions> and for electronic format documents, subject to Terms and Conditions for Electronic Documents at <http://www.sgs.com.tw/Terms-and-Conditions>. Attention is drawn to the limitation of liability, indemnification and jurisdiction issues defined therein. Any holder of this document is advised that information contained hereon reflects the Company's findings at the time of its intervention only and within the limits of Client's instructions, if any. The Company's sole responsibility is to its Client and this document does not exonerate parties to a transaction from exercising all their rights and obligations under the transaction documents. This document cannot be reproduced except in full, without prior written approval of the Company. Any unauthorized alteration, forgery or falsification of the content or appearance of this document is unlawful and offenders may be prosecuted to the fullest extent of the law.

Report Number :ER/2020/70076  
 Operation Mode :802.11b  
 Test Frequency :2437 MHz  
 Test Mode :Tx CH Mid  
 EUT Pol :H Plane

Test Site :SAC I Chamber  
 Test Date :2020-08-12  
 Temp./Humi. :26.5/71  
 Antenna Pol. :HORIZONTAL  
 Engineer :Neo

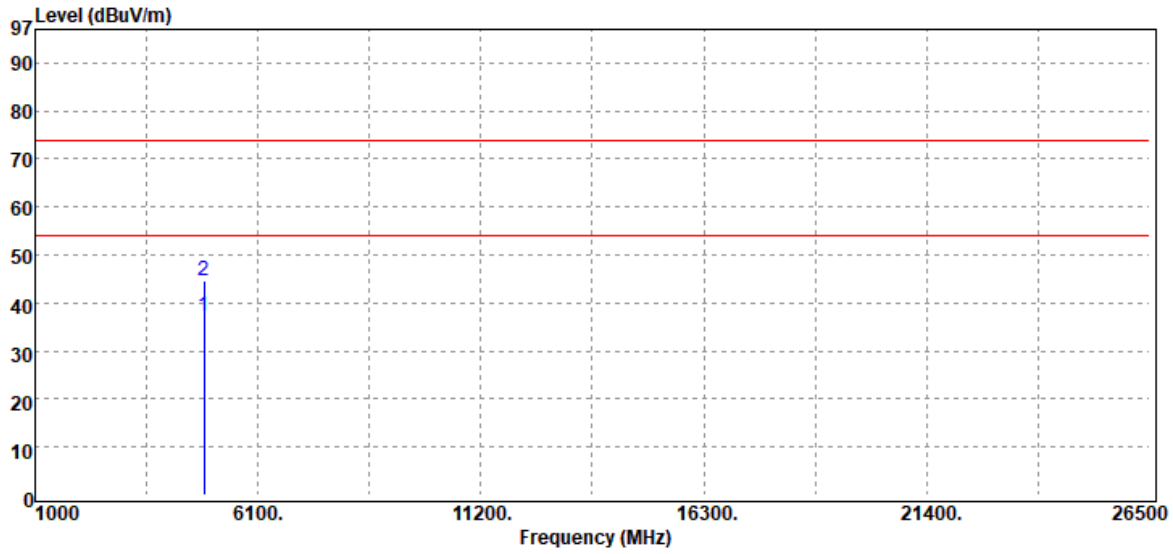

Freq. MHz	Detector Mode	Spectrum Reading Level dB $\mu$ V	Factor dB	Actual FS dB $\mu$ V/m	Limit @3m dB $\mu$ V/m	Margin dB
4874.00	Average	22.32	14.85	37.17	54.00	-16.83
4874.00	Peak	29.64	14.85	44.49	74.00	-29.51

Unless otherwise stated the results shown in this test report refer only to the sample(s) tested and such sample(s) are retained for 90 days only.

除非另有說明，此報告結果僅對測試之樣品負責，同時此樣品僅保留90天。本報告未經本公司書面許可，不可部份複製。

This document is issued by the Company subject to its General Conditions of Service printed overleaf, available on request or accessible at <http://www.sgs.com.tw/Terms-and-Conditions> and for electronic format documents, subject to Terms and Conditions for Electronic Documents at <http://www.sgs.com.tw/Terms-and-Conditions>. Attention is drawn to the limitation of liability, indemnification and jurisdiction issues defined therein. Any holder of this document is advised that information contained hereon reflects the Company's findings at the time of its intervention only and within the limits of Client's instructions, if any. The Company's sole responsibility is to its Client and this document does not exonerate parties to a transaction from exercising all their rights and obligations under the transaction documents. This document cannot be reproduced except in full, without prior written approval of the Company. Any unauthorized alteration, forgery or falsification of the content or appearance of this document is unlawful and offenders may be prosecuted to the fullest extent of the law.

Report Number :ER/2020/70076  
 Operation Mode :802.11b  
 Test Frequency :2462 MHz  
 Test Mode :Tx CH High  
 EUT Pol :H Plane

Test Site :SAC I Chamber  
 Test Date :2020-08-12  
 Temp./Humi. :26.5/71  
 Antenna Pol. :VERTICAL  
 Engineer :Neo

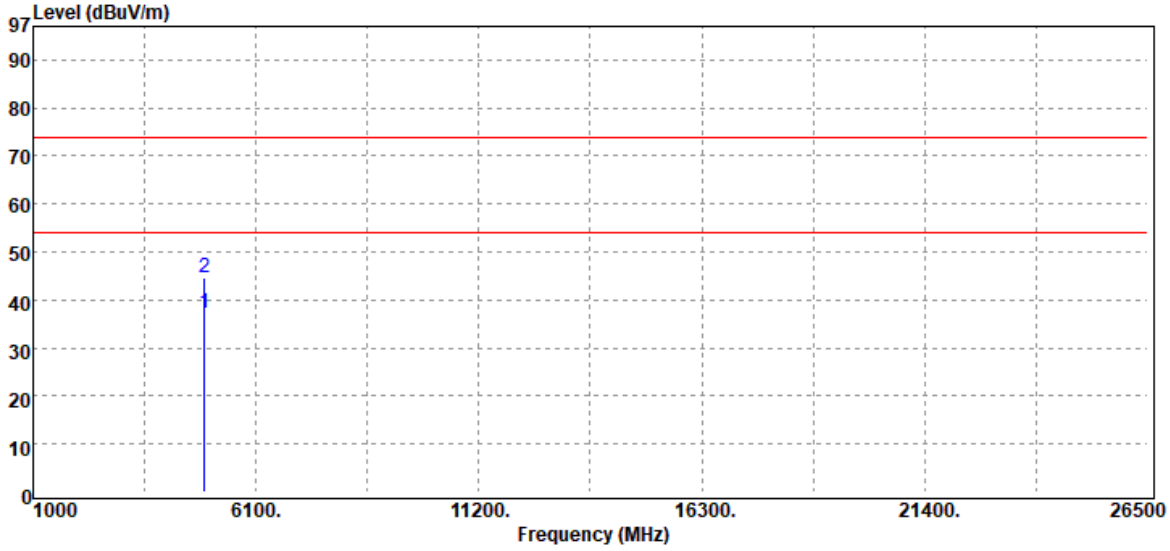

Freq. MHz	Detector Mode	Spectrum Reading Level dB $\mu$ V	Factor dB	Actual FS dB $\mu$ V/m	Limit @3m dB $\mu$ V/m	Margin dB
4924.00	Average	22.23	14.87	37.10	54.00	-16.90
4924.00	Peak	29.91	14.87	44.78	74.00	-29.22

Unless otherwise stated the results shown in this test report refer only to the sample(s) tested and such sample(s) are retained for 90 days only.

除非另有說明，此報告結果僅對測試之樣品負責，同時此樣品僅保留90天。本報告未經本公司書面許可，不可部份複製。

This document is issued by the Company subject to its General Conditions of Service printed overleaf, available on request or accessible at <http://www.sgs.com.tw/Terms-and-Conditions> and for electronic format documents, subject to Terms and Conditions for Electronic Documents at <http://www.sgs.com.tw/Terms-and-Conditions>. Attention is drawn to the limitation of liability, indemnification and jurisdiction issues defined therein. Any holder of this document is advised that information contained hereon reflects the Company's findings at the time of its intervention only and within the limits of Client's instructions, if any. The Company's sole responsibility is to its Client and this document does not exonerate parties to a transaction from exercising all their rights and obligations under the transaction documents. This document cannot be reproduced except in full, without prior written approval of the Company. Any unauthorized alteration, forgery or falsification of the content or appearance of this document is unlawful and offenders may be prosecuted to the fullest extent of the law.

Report Number :ER/2020/70076  
 Operation Mode :802.11b  
 Test Frequency :2462 MHz  
 Test Mode :Tx CH High  
 EUT Pol :H Plane

Test Site :SAC I Chamber  
 Test Date :2020-08-12  
 Temp./Humi. :26.5/71  
 Antenna Pol. :HORIZONTAL  
 Engineer :Neo

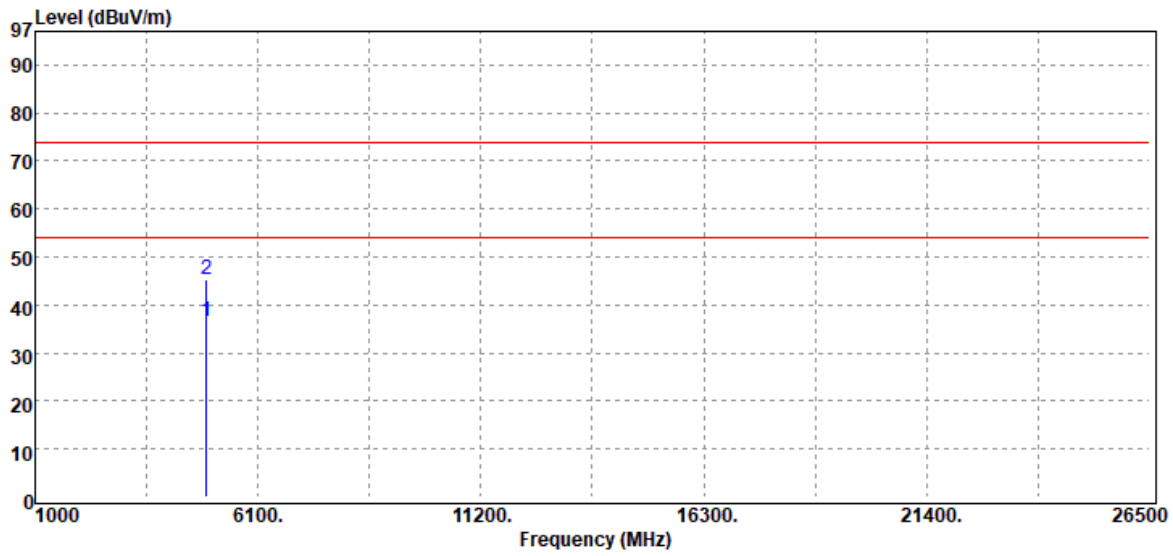

Freq. MHz	Detector Mode	Spectrum Reading Level dB $\mu$ V	Factor dB	Actual FS dB $\mu$ V/m	Limit @3m dB $\mu$ V/m	Margin dB
4924.00	Average	21.70	14.87	36.57	54.00	-17.43
4924.00	Peak	30.46	14.87	45.33	74.00	-28.67

Unless otherwise stated the results shown in this test report refer only to the sample(s) tested and such sample(s) are retained for 90 days only.

除非另有說明，此報告結果僅對測試之樣品負責，同時此樣品僅保留90天。本報告未經本公司書面許可，不可部份複製。

This document is issued by the Company subject to its General Conditions of Service printed overleaf, available on request or accessible at <http://www.sgs.com.tw/Terms-and-Conditions> and for electronic format documents, subject to Terms and Conditions for Electronic Documents at <http://www.sgs.com.tw/Terms-and-Conditions>. Attention is drawn to the limitation of liability, indemnification and jurisdiction issues defined therein. Any holder of this document is advised that information contained hereon reflects the Company's findings at the time of its intervention only and within the limits of Client's instructions, if any. The Company's sole responsibility is to its Client and this document does not exonerate parties to a transaction from exercising all their rights and obligations under the transaction documents. This document cannot be reproduced except in full, without prior written approval of the Company. Any unauthorized alteration, forgery or falsification of the content or appearance of this document is unlawful and offenders may be prosecuted to the fullest extent of the law.

Report Number :ER/2020/70076  
 Operation Mode :802.11b  
 Test Frequency :2467 MHz  
 Test Mode :Tx CH High  
 EUT Pol :H Plane

Test Site :SAC I Chamber  
 Test Date :2020-08-12  
 Temp./Humi. :26.5/71  
 Antenna Pol. :VERTICAL  
 Engineer :Neo

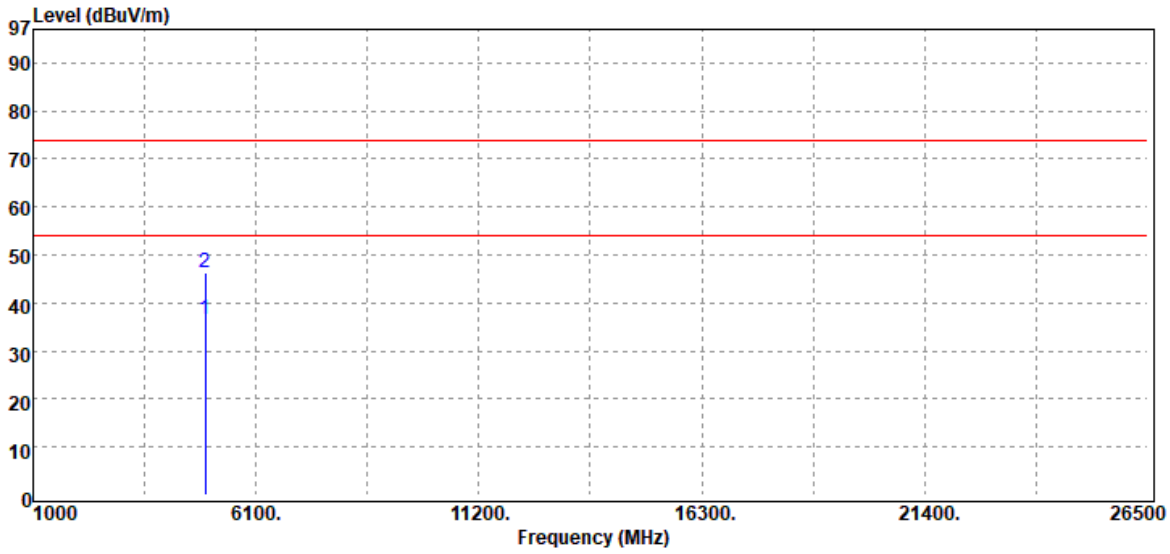

Freq. MHz	Detector Mode	Spectrum Reading Level dB $\mu$ V	Factor dB	Actual FS dB $\mu$ V/m	Limit @3m dB $\mu$ V/m	Margin dB
4934.00	Average	21.91	14.77	36.68	54.00	-17.32
4934.00	Peak	31.39	14.77	46.16	74.00	-27.84

Unless otherwise stated the results shown in this test report refer only to the sample(s) tested and such sample(s) are retained for 90 days only.

除非另有說明，此報告結果僅對測試之樣品負責，同時此樣品僅保留90天。本報告未經本公司書面許可，不可部份複製。

This document is issued by the Company subject to its General Conditions of Service printed overleaf, available on request or accessible at <http://www.sgs.com.tw/Terms-and-Conditions> and for electronic format documents, subject to Terms and Conditions for Electronic Documents at <http://www.sgs.com.tw/Terms-and-Conditions>. Attention is drawn to the limitation of liability, indemnification and jurisdiction issues defined therein. Any holder of this document is advised that information contained hereon reflects the Company's findings at the time of its intervention only and within the limits of Client's instructions, if any. The Company's sole responsibility is to its Client and this document does not exonerate parties to a transaction from exercising all their rights and obligations under the transaction documents. This document cannot be reproduced except in full, without prior written approval of the Company. Any unauthorized alteration, forgery or falsification of the content or appearance of this document is unlawful and offenders may be prosecuted to the fullest extent of the law.



Report Number :ER/2020/70076  
 Operation Mode :802.11b  
 Test Frequency :2467 MHz  
 Test Mode :Tx CH High  
 EUT Pol :H Plane

Test Site :SAC I Chamber  
 Test Date :2020-08-12  
 Temp./Humi. :26.5/71  
 Antenna Pol. :HORIZONTAL  
 Engineer :Neo

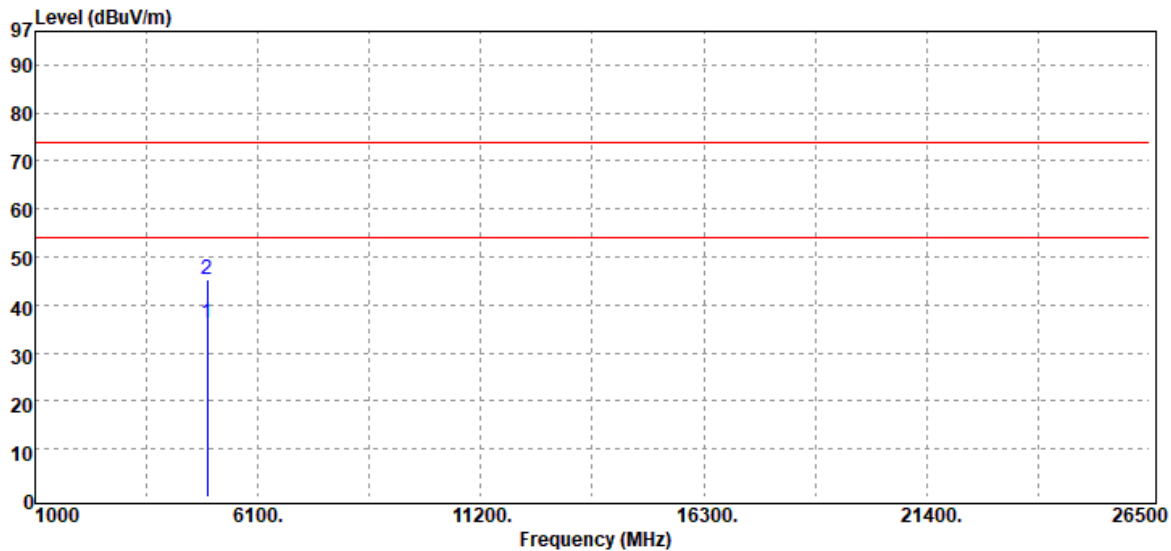

Freq. MHz	Detector Mode	Spectrum Reading Level dB $\mu$ V	Factor dB	Actual FS dB $\mu$ V/m	Limit @3m dB $\mu$ V/m	Margin dB
4934.00	Average	21.49	14.77	36.26	54.00	-17.74
4934.00	Peak	30.68	14.77	45.45	74.00	-28.55

Unless otherwise stated the results shown in this test report refer only to the sample(s) tested and such sample(s) are retained for 90 days only.

除非另有說明，此報告結果僅對測試之樣品負責，同時此樣品僅保留90天。本報告未經本公司書面許可，不可部份複製。

This document is issued by the Company subject to its General Conditions of Service printed overleaf, available on request or accessible at <http://www.sgs.com.tw/Terms-and-Conditions> and for electronic format documents, subject to Terms and Conditions for Electronic Documents at <http://www.sgs.com.tw/Terms-and-Conditions>. Attention is drawn to the limitation of liability, indemnification and jurisdiction issues defined therein. Any holder of this document is advised that information contained hereon reflects the Company's findings at the time of its intervention only and within the limits of Client's instructions, if any. The Company's sole responsibility is to its Client and this document does not exonerate parties to a transaction from exercising all their rights and obligations under the transaction documents. This document cannot be reproduced except in full, without prior written approval of the Company. Any unauthorized alteration, forgery or falsification of the content or appearance of this document is unlawful and offenders may be prosecuted to the fullest extent of the law.

Report Number :ER/2020/70076  
 Operation Mode :802.11b  
 Test Frequency :2472 MHz  
 Test Mode :Tx CH High  
 EUT Pol :H Plane

Test Site :SAC I Chamber  
 Test Date :2020-08-12  
 Temp./Humi. :26.5/71  
 Antenna Pol. :VERTICAL  
 Engineer :Neo

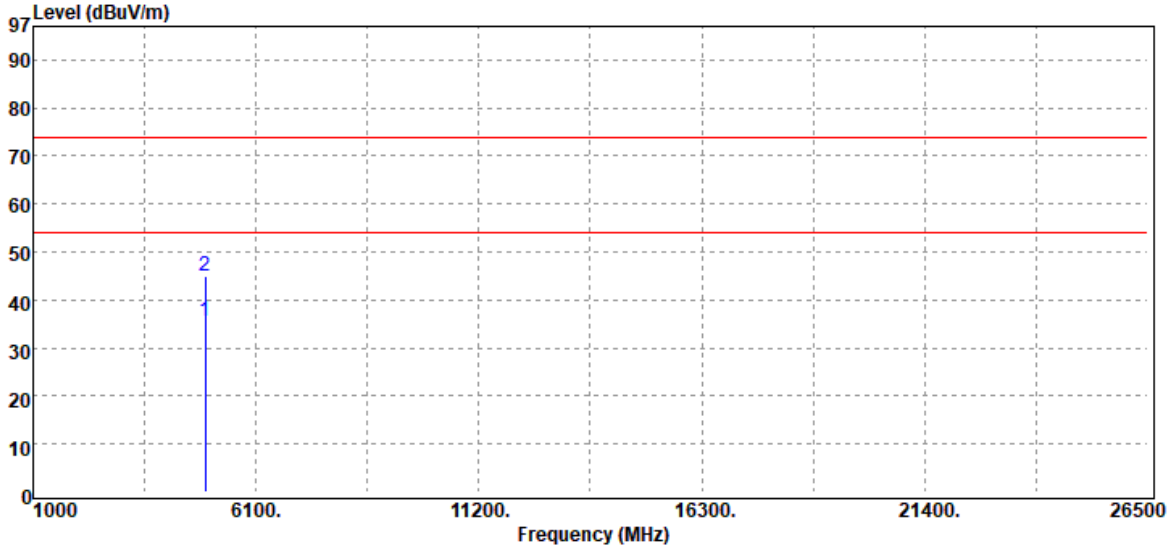

Freq. MHz	Detector Mode	Spectrum Reading Level dB $\mu$ V	Factor dB	Actual FS dB $\mu$ V/m	Limit @3m dB $\mu$ V/m	Margin dB
4944.00	Average	21.08	14.64	35.72	54.00	-18.28
4944.00	Peak	30.23	14.64	44.87	74.00	-29.13

Unless otherwise stated the results shown in this test report refer only to the sample(s) tested and such sample(s) are retained for 90 days only.

除非另有說明，此報告結果僅對測試之樣品負責，同時此樣品僅保留90天。本報告未經本公司書面許可，不可部份複製。

This document is issued by the Company subject to its General Conditions of Service printed overleaf, available on request or accessible at <http://www.sgs.com.tw/Terms-and-Conditions> and for electronic format documents, subject to Terms and Conditions for Electronic Documents at <http://www.sgs.com.tw/Terms-and-Conditions>. Attention is drawn to the limitation of liability, indemnification and jurisdiction issues defined therein. Any holder of this document is advised that information contained hereon reflects the Company's findings at the time of its intervention only and within the limits of Client's instructions, if any. The Company's sole responsibility is to its Client and this document does not exonerate parties to a transaction from exercising all their rights and obligations under the transaction documents. This document cannot be reproduced except in full, without prior written approval of the Company. Any unauthorized alteration, forgery or falsification of the content or appearance of this document is unlawful and offenders may be prosecuted to the fullest extent of the law.

Report Number :ER/2020/70076  
Operation Mode :802.11b  
Test Frequency :2472 MHz  
Test Mode :Tx CH High  
EUT Pol :H Plane

Test Site :SAC I Chamber  
Test Date :2020-08-12  
Temp./Humi. :26.5/71  
Antenna Pol. :HORIZONTAL  
Engineer :Neo

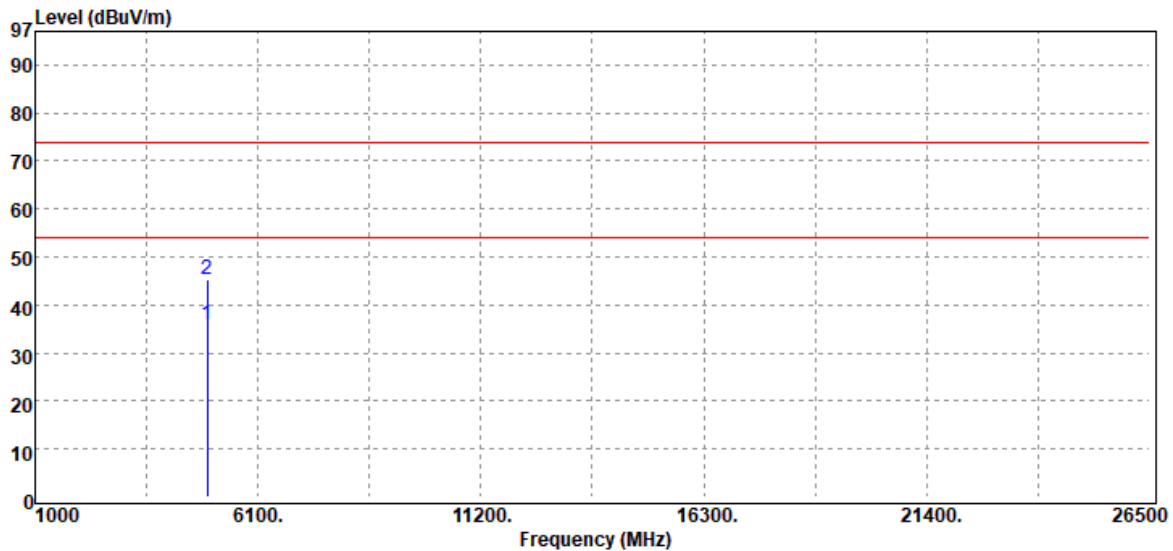

Freq. MHz	Detector Mode	Spectrum Reading Level dB $\mu$ V	Factor dB	Actual FS dB $\mu$ V/m	Limit @3m dB $\mu$ V/m	Margin dB
4944.00	Average	21.40	14.64	36.04	54.00	-17.96
4944.00	Peak	30.63	14.64	45.27	74.00	-28.73

Unless otherwise stated the results shown in this test report refer only to the sample(s) tested and such sample(s) are retained for 90 days only.

除非另有說明，此報告結果僅對測試之樣品負責，同時此樣品僅保留90天。本報告未經本公司書面許可，不可部份複製。

This document is issued by the Company subject to its General Conditions of Service printed overleaf, available on request or accessible at <http://www.sgs.com.tw/Terms-and-Conditions> and for electronic format documents, subject to Terms and Conditions for Electronic Documents at <http://www.sgs.com.tw/Terms-and-Conditions>. Attention is drawn to the limitation of liability, indemnification and jurisdiction issues defined therein. Any holder of this document is advised that information contained hereon reflects the Company's findings at the time of its intervention only and within the limits of Client's instructions, if any. The Company's sole responsibility is to its Client and this document does not exonerate parties to a transaction from exercising all their rights and obligations under the transaction documents. This document cannot be reproduced except in full, without prior written approval of the Company. Any unauthorized alteration, forgery or falsification of the content or appearance of this document is unlawful and offenders may be prosecuted to the fullest extent of the law.

Report Number :ER/2020/70076  
 Operation Mode :802.11g  
 Test Frequency :2412 MHz  
 Test Mode :Tx CH Low  
 EUT Pol :H Plane

Test Site :SAC I Chamber  
 Test Date :2020-08-12  
 Temp./Humi. :26.5/71  
 Antenna Pol. :VERTICAL  
 Engineer :Neo

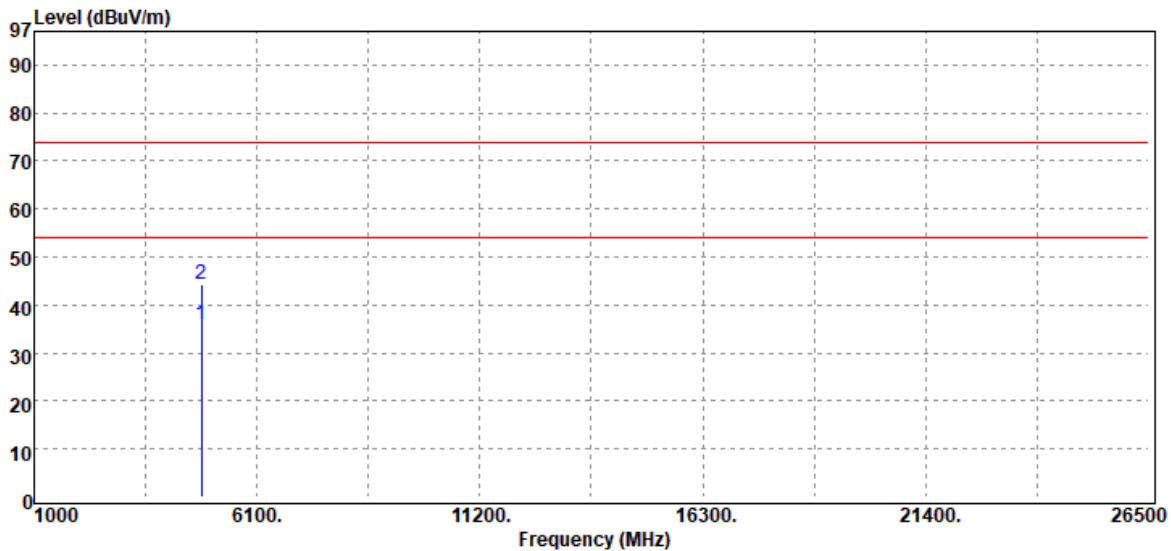

Freq. MHz	Detector Mode	Spectrum Reading Level dB $\mu$ V	Factor dB	Actual FS dB $\mu$ V/m	Limit @3m dB $\mu$ V/m	Margin dB
4824.00	Average	21.24	14.56	35.80	54.00	-18.20
4824.00	Peak	29.89	14.56	44.45	74.00	-29.55

Unless otherwise stated the results shown in this test report refer only to the sample(s) tested and such sample(s) are retained for 90 days only.

除非另有說明，此報告結果僅對測試之樣品負責，同時此樣品僅保留90天。本報告未經本公司書面許可，不可部份複製。

This document is issued by the Company subject to its General Conditions of Service printed overleaf, available on request or accessible at <http://www.sgs.com.tw/Terms-and-Conditions> and for electronic format documents, subject to Terms and Conditions for Electronic Documents at <http://www.sgs.com.tw/Terms-and-Conditions>. Attention is drawn to the limitation of liability, indemnification and jurisdiction issues defined therein. Any holder of this document is advised that information contained hereon reflects the Company's findings at the time of its intervention only and within the limits of Client's instructions, if any. The Company's sole responsibility is to its Client and this document does not exonerate parties to a transaction from exercising all their rights and obligations under the transaction documents. This document cannot be reproduced except in full, without prior written approval of the Company. Any unauthorized alteration, forgery or falsification of the content or appearance of this document is unlawful and offenders may be prosecuted to the fullest extent of the law.

Report Number :ER/2020/70076  
 Operation Mode :802.11g  
 Test Frequency :2412 MHz  
 Test Mode :Tx CH Low  
 EUT Pol :H Plane

Test Site :SAC I Chamber  
 Test Date :2020-08-12  
 Temp./Humi. :26.5/71  
 Antenna Pol. :HORIZONTAL  
 Engineer :Neo

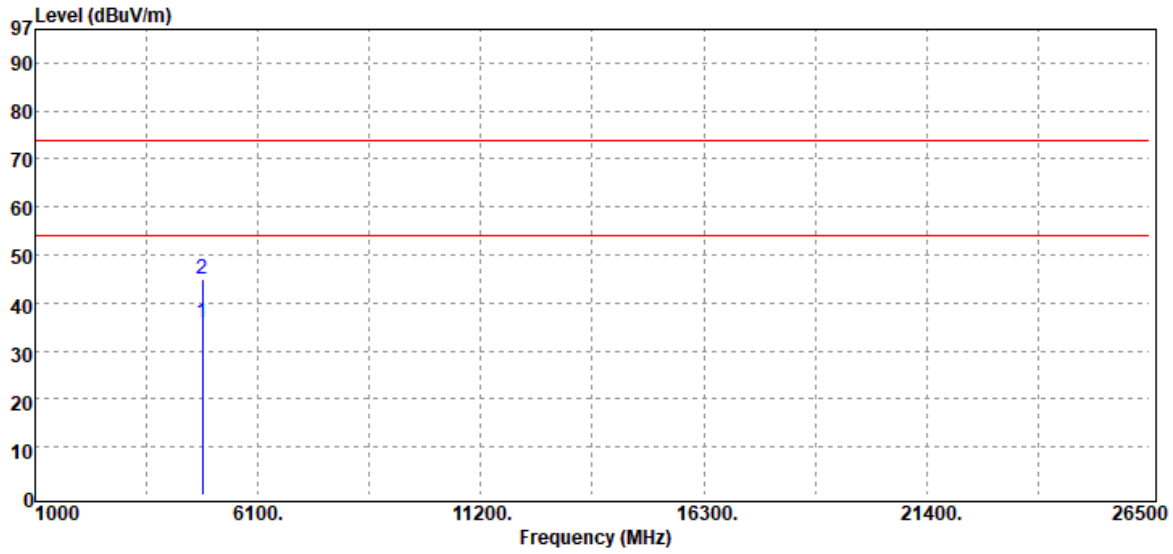

Freq. MHz	Detector Mode	Spectrum Reading Level dB $\mu$ V	Factor dB	Actual FS dB $\mu$ V/m	Limit @3m dB $\mu$ V/m	Margin dB
4824.00	Average	21.22	14.56	35.78	54.00	-18.22
4824.00	Peak	30.53	14.56	45.09	74.00	-28.91

Unless otherwise stated the results shown in this test report refer only to the sample(s) tested and such sample(s) are retained for 90 days only.

除非另有說明，此報告結果僅對測試之樣品負責，同時此樣品僅保留90天。本報告未經本公司書面許可，不可部份複製。

This document is issued by the Company subject to its General Conditions of Service printed overleaf, available on request or accessible at <http://www.sgs.com.tw/Terms-and-Conditions> and for electronic format documents, subject to Terms and Conditions for Electronic Documents at <http://www.sgs.com.tw/Terms-and-Conditions>. Attention is drawn to the limitation of liability, indemnification and jurisdiction issues defined therein. Any holder of this document is advised that information contained hereon reflects the Company's findings at the time of its intervention only and within the limits of Client's instructions, if any. The Company's sole responsibility is to its Client and this document does not exonerate parties to a transaction from exercising all their rights and obligations under the transaction documents. This document cannot be reproduced except in full, without prior written approval of the Company. Any unauthorized alteration, forgery or falsification of the content or appearance of this document is unlawful and offenders may be prosecuted to the fullest extent of the law.

Report Number :ER/2020/70076  
 Operation Mode :802.11g  
 Test Frequency :2437 MHz  
 Test Mode :Tx CH Mid  
 EUT Pol :H Plane

Test Site :SAC I Chamber  
 Test Date :2020-08-12  
 Temp./Humi. :26.5/71  
 Antenna Pol. :VERTICAL  
 Engineer :Neo

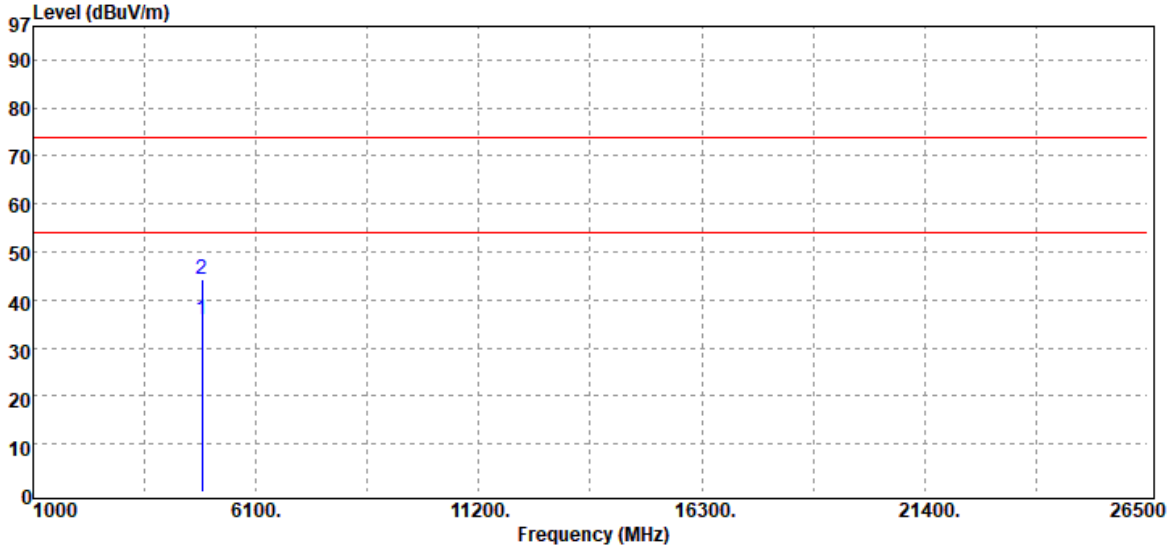

Freq. MHz	Detector Mode	Spectrum Reading Level dB $\mu$ V	Factor dB	Actual FS dB $\mu$ V/m	Limit @3m dB $\mu$ V/m	Margin dB
4874.00	Average	21.07	14.85	35.92	54.00	-18.08
4874.00	Peak	29.61	14.85	44.46	74.00	-29.54

Unless otherwise stated the results shown in this test report refer only to the sample(s) tested and such sample(s) are retained for 90 days only.

除非另有說明，此報告結果僅對測試之樣品負責，同時此樣品僅保留90天。本報告未經本公司書面許可，不可部份複製。

This document is issued by the Company subject to its General Conditions of Service printed overleaf, available on request or accessible at <http://www.sgs.com.tw/Terms-and-Conditions> and for electronic format documents, subject to Terms and Conditions for Electronic Documents at <http://www.sgs.com.tw/Terms-and-Conditions>. Attention is drawn to the limitation of liability, indemnification and jurisdiction issues defined therein. Any holder of this document is advised that information contained hereon reflects the Company's findings at the time of its intervention only and within the limits of Client's instructions, if any. The Company's sole responsibility is to its Client and this document does not exonerate parties to a transaction from exercising all their rights and obligations under the transaction documents. This document cannot be reproduced except in full, without prior written approval of the Company. Any unauthorized alteration, forgery or falsification of the content or appearance of this document is unlawful and offenders may be prosecuted to the fullest extent of the law.

Report Number :ER/2020/70076  
 Operation Mode :802.11g  
 Test Frequency :2437 MHz  
 Test Mode :Tx CH Mid  
 EUT Pol :H Plane

Test Site :SAC I Chamber  
 Test Date :2020-08-12  
 Temp./Humi. :26.5/71  
 Antenna Pol. :HORIZONTAL  
 Engineer :Neo

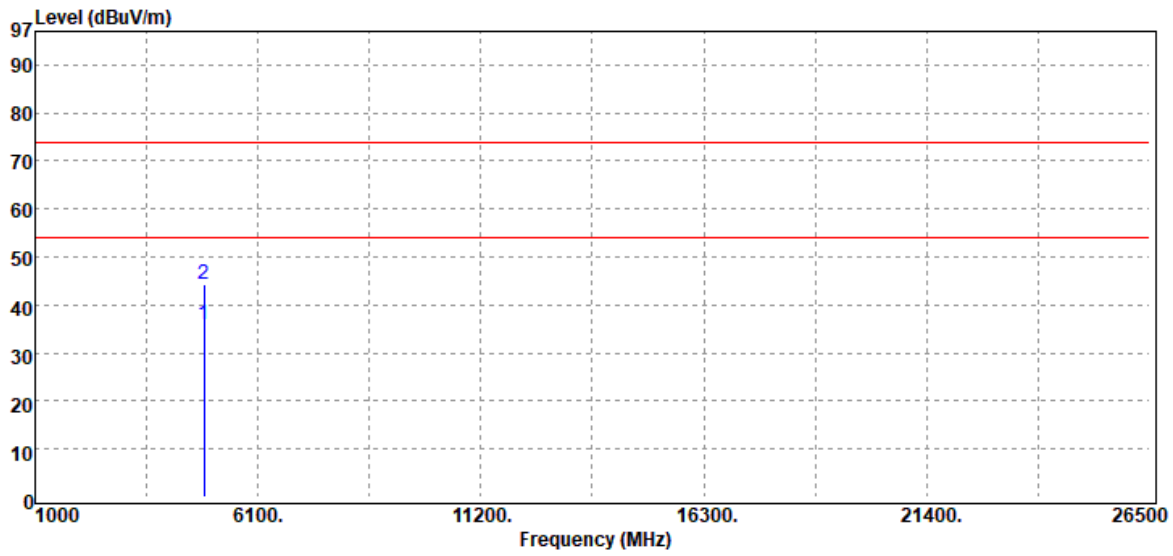

Freq. MHz	Detector Mode	Spectrum Reading Level dB $\mu$ V	Factor dB	Actual FS dB $\mu$ V/m	Limit @3m dB $\mu$ V/m	Margin dB
4874.00	Average	20.99	14.85	35.84	54.00	-18.16
4874.00	Peak	29.33	14.85	44.18	74.00	-29.82

Unless otherwise stated the results shown in this test report refer only to the sample(s) tested and such sample(s) are retained for 90 days only.

除非另有說明，此報告結果僅對測試之樣品負責，同時此樣品僅保留90天。本報告未經本公司書面許可，不可部份複製。

This document is issued by the Company subject to its General Conditions of Service printed overleaf, available on request or accessible at <http://www.sgs.com.tw/Terms-and-Conditions> and for electronic format documents, subject to Terms and Conditions for Electronic Documents at <http://www.sgs.com.tw/Terms-and-Conditions>. Attention is drawn to the limitation of liability, indemnification and jurisdiction issues defined therein. Any holder of this document is advised that information contained hereon reflects the Company's findings at the time of its intervention only and within the limits of Client's instructions, if any. The Company's sole responsibility is to its Client and this document does not exonerate parties to a transaction from exercising all their rights and obligations under the transaction documents. This document cannot be reproduced except in full, without prior written approval of the Company. Any unauthorized alteration, forgery or falsification of the content or appearance of this document is unlawful and offenders may be prosecuted to the fullest extent of the law.

Report Number :ER/2020/70076  
 Operation Mode :802.11g  
 Test Frequency :2462 MHz  
 Test Mode :Tx CH High  
 EUT Pol :H Plane

Test Site :SAC I Chamber  
 Test Date :2020-08-12  
 Temp./Humi. :26.5/71  
 Antenna Pol. :VERTICAL  
 Engineer :Neo

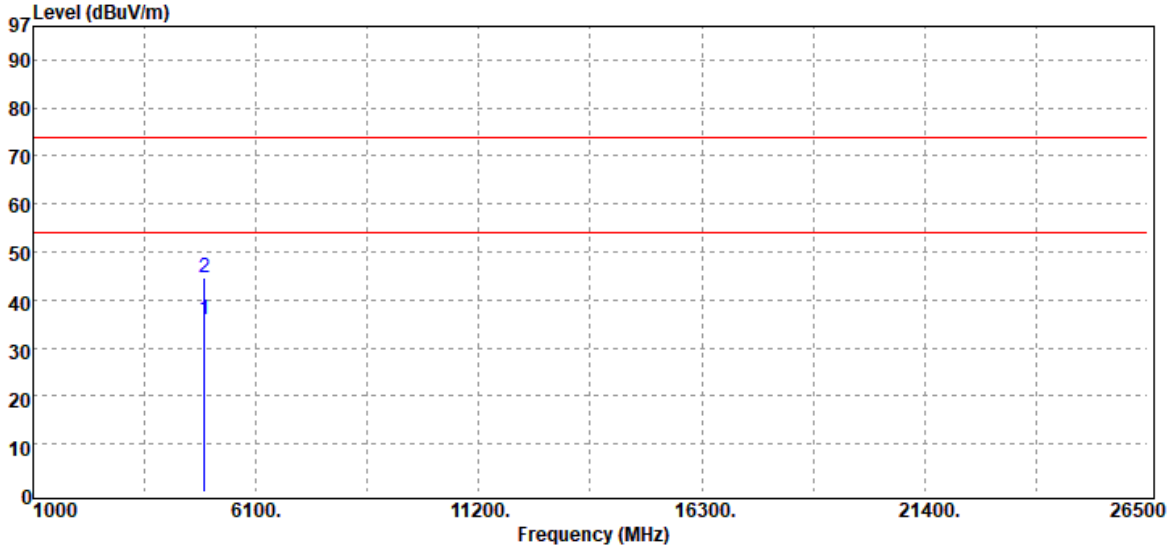

Freq. MHz	Detector Mode	Spectrum Reading Level dB $\mu$ V	Factor dB	Actual FS dB $\mu$ V/m	Limit @3m dB $\mu$ V/m	Margin dB
4924.00	Average	20.91	14.87	35.78	54.00	-18.22
4924.00	Peak	29.60	14.87	44.47	74.00	-29.53

Unless otherwise stated the results shown in this test report refer only to the sample(s) tested and such sample(s) are retained for 90 days only.

除非另有說明，此報告結果僅對測試之樣品負責，同時此樣品僅保留90天。本報告未經本公司書面許可，不可部份複製。

This document is issued by the Company subject to its General Conditions of Service printed overleaf, available on request or accessible at <http://www.sgs.com.tw/Terms-and-Conditions> and for electronic format documents, subject to Terms and Conditions for Electronic Documents at <http://www.sgs.com.tw/Terms-and-Conditions>. Attention is drawn to the limitation of liability, indemnification and jurisdiction issues defined therein. Any holder of this document is advised that information contained hereon reflects the Company's findings at the time of its intervention only and within the limits of Client's instructions, if any. The Company's sole responsibility is to its Client and this document does not exonerate parties to a transaction from exercising all their rights and obligations under the transaction documents. This document cannot be reproduced except in full, without prior written approval of the Company. Any unauthorized alteration, forgery or falsification of the content or appearance of this document is unlawful and offenders may be prosecuted to the fullest extent of the law.



Report Number :ER/2020/70076  
 Operation Mode :802.11g  
 Test Frequency :2462 MHz  
 Test Mode :Tx CH High  
 EUT Pol :H Plane

Test Site :SAC I Chamber  
 Test Date :2020-08-12  
 Temp./Humi. :26.5/71  
 Antenna Pol. :HORIZONTAL  
 Engineer :Neo

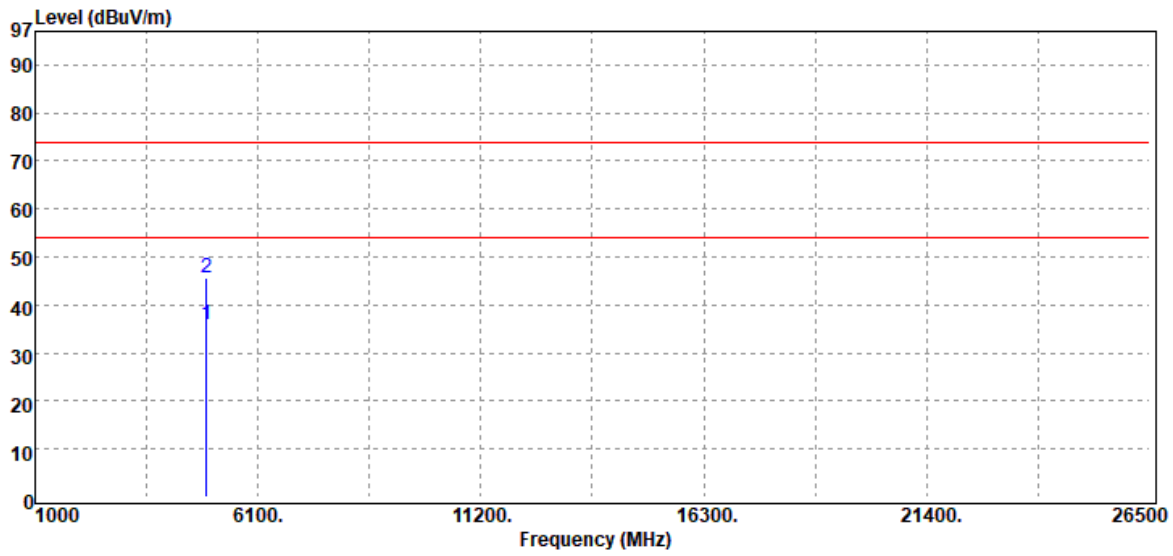

Freq. MHz	Detector Mode	Spectrum Reading Level dB $\mu$ V	Factor dB	Actual FS dB $\mu$ V/m	Limit @3m dB $\mu$ V/m	Margin dB
4924.00	Average	20.98	14.87	35.85	54.00	-18.15
4924.00	Peak	30.82	14.87	45.69	74.00	-28.31

Unless otherwise stated the results shown in this test report refer only to the sample(s) tested and such sample(s) are retained for 90 days only.

除非另有說明，此報告結果僅對測試之樣品負責，同時此樣品僅保留90天。本報告未經本公司書面許可，不可部份複製。

This document is issued by the Company subject to its General Conditions of Service printed overleaf, available on request or accessible at <http://www.sgs.com.tw/Terms-and-Conditions> and for electronic format documents, subject to Terms and Conditions for Electronic Documents at <http://www.sgs.com.tw/Terms-and-Conditions>. Attention is drawn to the limitation of liability, indemnification and jurisdiction issues defined therein. Any holder of this document is advised that information contained hereon reflects the Company's findings at the time of its intervention only and within the limits of Client's instructions, if any. The Company's sole responsibility is to its Client and this document does not exonerate parties to a transaction from exercising all their rights and obligations under the transaction documents. This document cannot be reproduced except in full, without prior written approval of the Company. Any unauthorized alteration, forgery or falsification of the content or appearance of this document is unlawful and offenders may be prosecuted to the fullest extent of the law.

Report Number :ER/2020/70076  
 Operation Mode :802.11g  
 Test Frequency :2467 MHz  
 Test Mode :Tx CH High  
 EUT Pol :H Plane

Test Site :SAC I Chamber  
 Test Date :2020-08-12  
 Temp./Humi. :26.5/71  
 Antenna Pol. :VERTICAL  
 Engineer :Neo

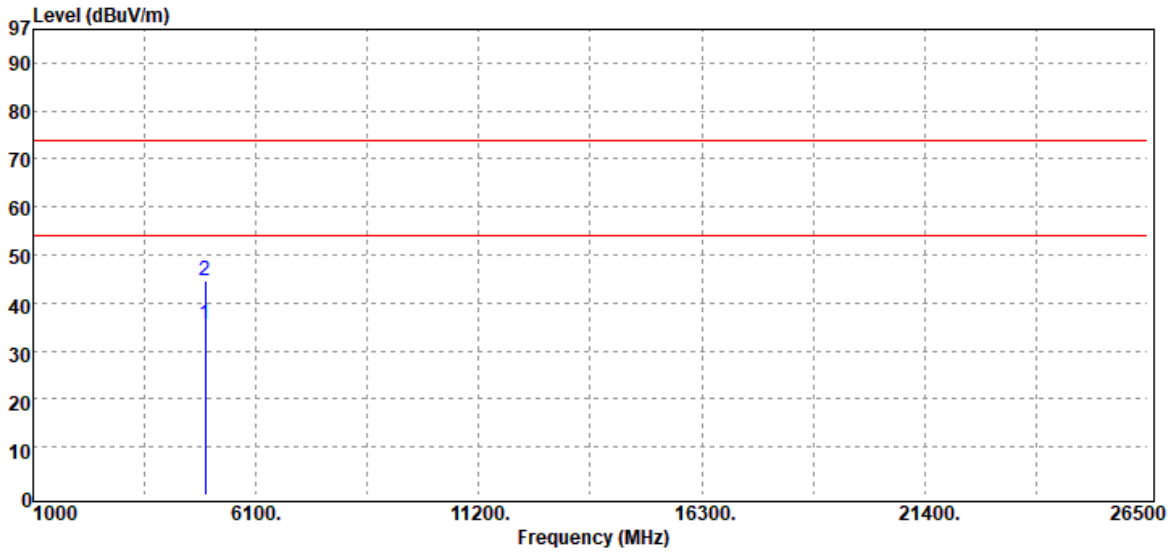

Freq. MHz	Detector Mode	Spectrum Reading Level dB $\mu$ V	Factor dB	Actual FS dB $\mu$ V/m	Limit @3m dB $\mu$ V/m	Margin dB
4934.00	Average	20.90	14.77	35.67	54.00	-18.33
4934.00	Peak	29.78	14.77	44.55	74.00	-29.45

Unless otherwise stated the results shown in this test report refer only to the sample(s) tested and such sample(s) are retained for 90 days only.

除非另有說明，此報告結果僅對測試之樣品負責，同時此樣品僅保留90天。本報告未經本公司書面許可，不可部份複製。

This document is issued by the Company subject to its General Conditions of Service printed overleaf, available on request or accessible at <http://www.sgs.com.tw/Terms-and-Conditions> and for electronic format documents, subject to Terms and Conditions for Electronic Documents at <http://www.sgs.com.tw/Terms-and-Conditions>. Attention is drawn to the limitation of liability, indemnification and jurisdiction issues defined therein. Any holder of this document is advised that information contained hereon reflects the Company's findings at the time of its intervention only and within the limits of Client's instructions, if any. The Company's sole responsibility is to its Client and this document does not exonerate parties to a transaction from exercising all their rights and obligations under the transaction documents. This document cannot be reproduced except in full, without prior written approval of the Company. Any unauthorized alteration, forgery or falsification of the content or appearance of this document is unlawful and offenders may be prosecuted to the fullest extent of the law.

Report Number :ER/2020/70076  
 Operation Mode :802.11g  
 Test Frequency :2467 MHz  
 Test Mode :Tx CH High  
 EUT Pol :H Plane

Test Site :SAC I Chamber  
 Test Date :2020-08-12  
 Temp./Humi. :26.5/71  
 Antenna Pol. :HORIZONTAL  
 Engineer :Neo

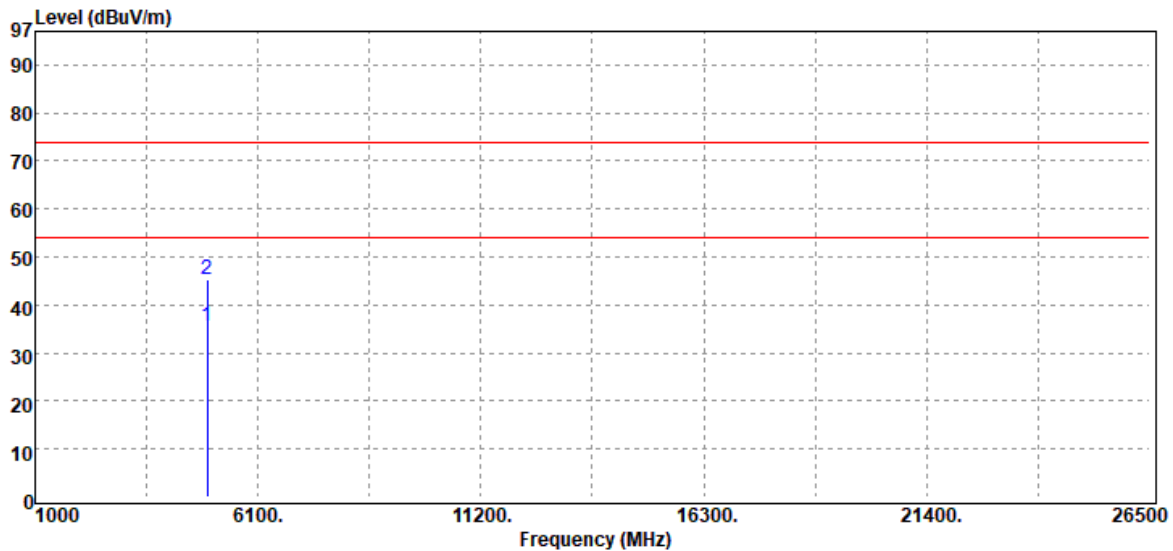

Freq. MHz	Detector Mode	Spectrum Reading Level dB $\mu$ V	Factor dB	Actual FS dB $\mu$ V/m	Limit @3m dB $\mu$ V/m	Margin dB
4934.00	Average	20.86	14.77	35.63	54.00	-18.37
4934.00	Peak	30.40	14.77	45.17	74.00	-28.83

Unless otherwise stated the results shown in this test report refer only to the sample(s) tested and such sample(s) are retained for 90 days only.

除非另有說明，此報告結果僅對測試之樣品負責，同時此樣品僅保留90天。本報告未經本公司書面許可，不可部份複製。

This document is issued by the Company subject to its General Conditions of Service printed overleaf, available on request or accessible at <http://www.sgs.com.tw/Terms-and-Conditions> and for electronic format documents, subject to Terms and Conditions for Electronic Documents at <http://www.sgs.com.tw/Terms-and-Conditions>. Attention is drawn to the limitation of liability, indemnification and jurisdiction issues defined therein. Any holder of this document is advised that information contained hereon reflects the Company's findings at the time of its intervention only and within the limits of Client's instructions, if any. The Company's sole responsibility is to its Client and this document does not exonerate parties to a transaction from exercising all their rights and obligations under the transaction documents. This document cannot be reproduced except in full, without prior written approval of the Company. Any unauthorized alteration, forgery or falsification of the content or appearance of this document is unlawful and offenders may be prosecuted to the fullest extent of the law.

Report Number :ER/2020/70076  
 Operation Mode :802.11g  
 Test Frequency :2472 MHz  
 Test Mode :Tx CH High  
 EUT Pol :H Plane

Test Site :SAC I Chamber  
 Test Date :2020-08-17  
 Temp./Humi. :27.2/73  
 Antenna Pol. :VERTICAL  
 Engineer :Neo

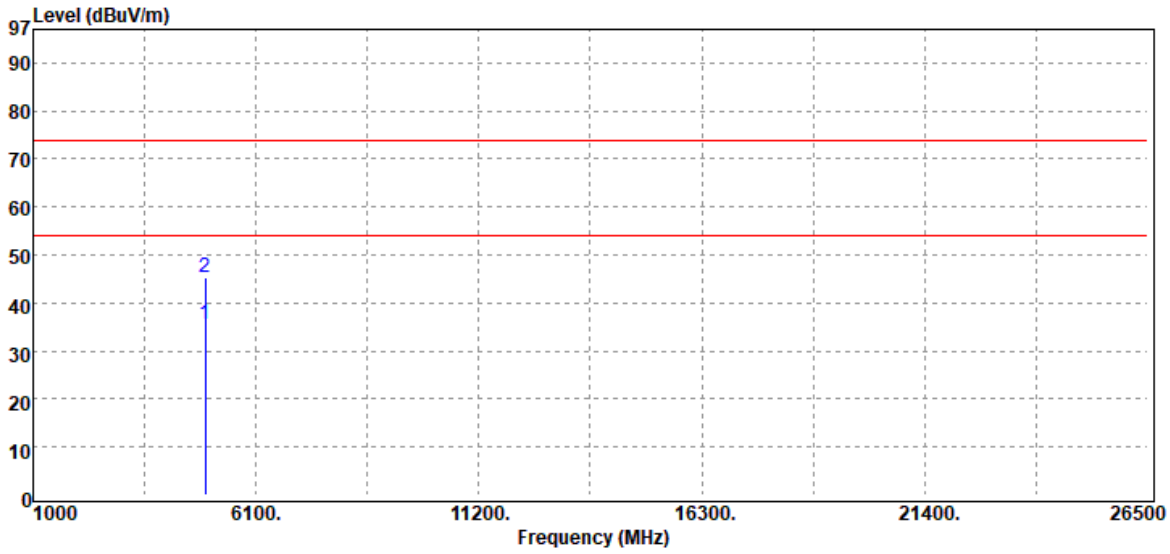

Freq. MHz	Detector Mode	Spectrum Reading Level dB $\mu$ V	Factor dB	Actual FS dB $\mu$ V/m	Limit @3m dB $\mu$ V/m	Margin dB
4944.00	Average	21.08	14.64	35.72	54.00	-18.28
4944.00	Peak	30.62	14.64	45.26	74.00	-28.74

Unless otherwise stated the results shown in this test report refer only to the sample(s) tested and such sample(s) are retained for 90 days only.

除非另有說明，此報告結果僅對測試之樣品負責，同時此樣品僅保留90天。本報告未經本公司書面許可，不可部份複製。

This document is issued by the Company subject to its General Conditions of Service printed overleaf, available on request or accessible at <http://www.sgs.com.tw/Terms-and-Conditions> and for electronic format documents, subject to Terms and Conditions for Electronic Documents at <http://www.sgs.com.tw/Terms-and-Conditions>. Attention is drawn to the limitation of liability, indemnification and jurisdiction issues defined therein. Any holder of this document is advised that information contained hereon reflects the Company's findings at the time of its intervention only and within the limits of Client's instructions, if any. The Company's sole responsibility is to its Client and this document does not exonerate parties to a transaction from exercising all their rights and obligations under the transaction documents. This document cannot be reproduced except in full, without prior written approval of the Company. Any unauthorized alteration, forgery or falsification of the content or appearance of this document is unlawful and offenders may be prosecuted to the fullest extent of the law.

Report Number :ER/2020/70076  
 Operation Mode :802.11g  
 Test Frequency :2472 MHz  
 Test Mode :Tx CH High  
 EUT Pol :H Plane

Test Site :SAC I Chamber  
 Test Date :2020-08-17  
 Temp./Humi. :27.2/73  
 Antenna Pol. :HORIZONTAL  
 Engineer :Neo

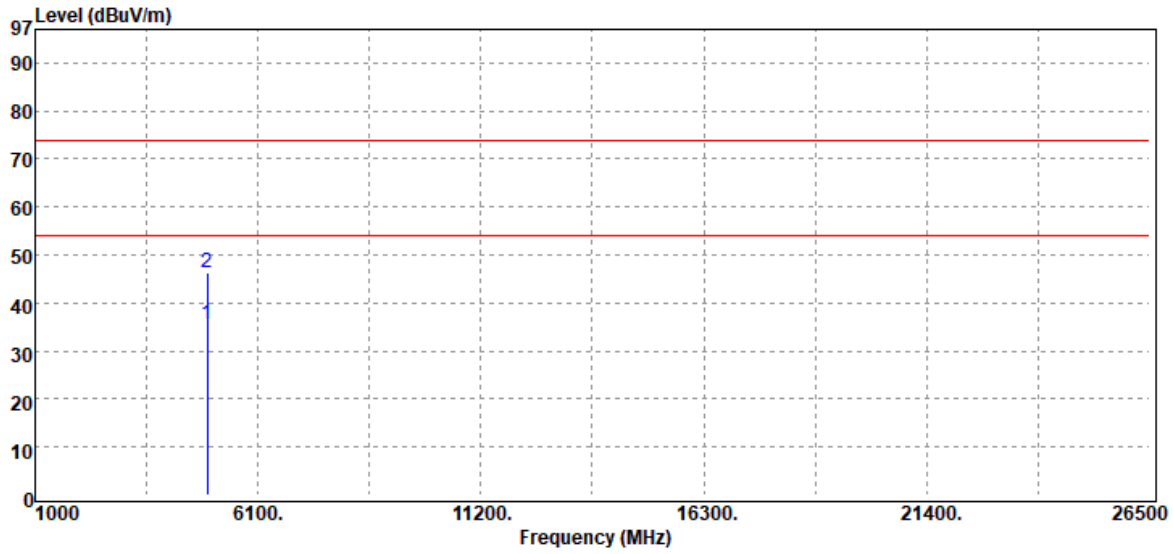

Freq. MHz	Detector Mode	Spectrum Reading Level dB $\mu$ V	Factor dB	Actual FS dB $\mu$ V/m	Limit @3m dB $\mu$ V/m	Margin dB
4944.00	Average	20.96	14.64	35.60	54.00	-18.40
4944.00	Peak	31.76	14.64	46.40	74.00	-27.60

Unless otherwise stated the results shown in this test report refer only to the sample(s) tested and such sample(s) are retained for 90 days only.

除非另有說明，此報告結果僅對測試之樣品負責，同時此樣品僅保留90天。本報告未經本公司書面許可，不可部份複製。

This document is issued by the Company subject to its General Conditions of Service printed overleaf, available on request or accessible at <http://www.sgs.com.tw/Terms-and-Conditions> and for electronic format documents, subject to Terms and Conditions for Electronic Documents at <http://www.sgs.com.tw/Terms-and-Conditions>. Attention is drawn to the limitation of liability, indemnification and jurisdiction issues defined therein. Any holder of this document is advised that information contained hereon reflects the Company's findings at the time of its intervention only and within the limits of Client's instructions, if any. The Company's sole responsibility is to its Client and this document does not exonerate parties to a transaction from exercising all their rights and obligations under the transaction documents. This document cannot be reproduced except in full, without prior written approval of the Company. Any unauthorized alteration, forgery or falsification of the content or appearance of this document is unlawful and offenders may be prosecuted to the fullest extent of the law.

Report Number :ER/2020/70076  
 Operation Mode :802.11n20  
 Test Frequency :2412 MHz  
 Test Mode :Tx CH Low  
 EUT Pol :H Plane

Test Site :SAC I Chamber  
 Test Date :2020-08-12  
 Temp./Humi. :26.5/71  
 Antenna Pol. :VERTICAL  
 Engineer :Neo

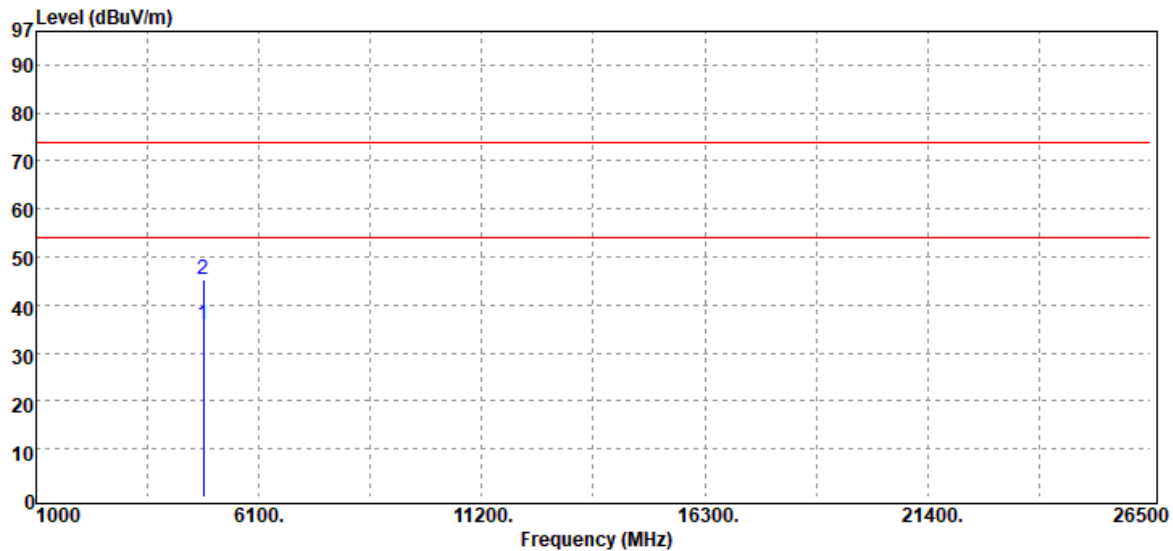

Freq. MHz	Detector Mode PK/QP/AV	Spectrum Reading Level dB $\mu$ V	Factor dB	Actual FS dB $\mu$ V/m	Limit @3m dB $\mu$ V/m	Margin dB
4824.00	Average	21.30	14.56	35.86	54.00	-18.14
4824.00	Peak	30.85	14.56	45.41	74.00	-28.59

Unless otherwise stated the results shown in this test report refer only to the sample(s) tested and such sample(s) are retained for 90 days only.

除非另有說明，此報告結果僅對測試之樣品負責，同時此樣品僅保留90天。本報告未經本公司書面許可，不可部份複製。

This document is issued by the Company subject to its General Conditions of Service printed overleaf, available on request or accessible at <http://www.sgs.com.tw/Terms-and-Conditions> and for electronic format documents, subject to Terms and Conditions for Electronic Documents at <http://www.sgs.com.tw/Terms-and-Conditions>. Attention is drawn to the limitation of liability, indemnification and jurisdiction issues defined therein. Any holder of this document is advised that information contained hereon reflects the Company's findings at the time of its intervention only and within the limits of Client's instructions, if any. The Company's sole responsibility is to its Client and this document does not exonerate parties to a transaction from exercising all their rights and obligations under the transaction documents. This document cannot be reproduced except in full, without prior written approval of the Company. Any unauthorized alteration, forgery or falsification of the content or appearance of this document is unlawful and offenders may be prosecuted to the fullest extent of the law.

Report Number :ER/2020/70076  
 Operation Mode :802.11n20  
 Test Frequency :2412 MHz  
 Test Mode :Tx CH Low  
 EUT Pol :H Plane

Test Site :SAC I Chamber  
 Test Date :2020-08-12  
 Temp./Humi. :26.5/71  
 Antenna Pol. :HORIZONTAL  
 Engineer :Neo

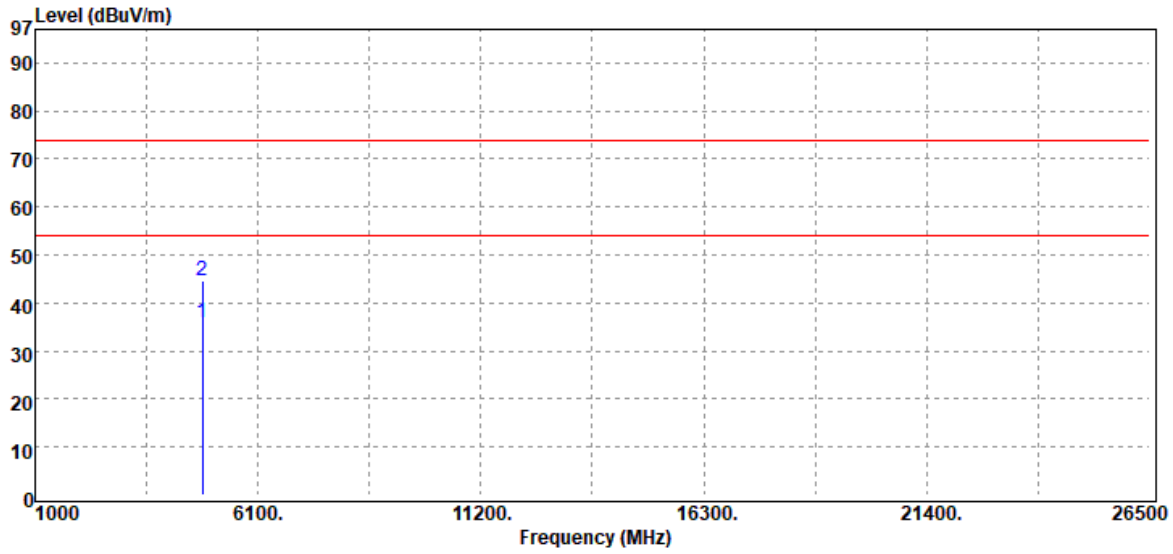

Freq. MHz	Detector Mode	Spectrum Reading Level dB $\mu$ V	Factor dB	Actual FS dB $\mu$ V/m	Limit @3m dB $\mu$ V/m	Margin dB
4824.00	Average	21.35	14.56	35.91	54.00	-18.09
4824.00	Peak	30.08	14.56	44.64	74.00	-29.36

Unless otherwise stated the results shown in this test report refer only to the sample(s) tested and such sample(s) are retained for 90 days only.

除非另有說明，此報告結果僅對測試之樣品負責，同時此樣品僅保留90天。本報告未經本公司書面許可，不可部份複製。

This document is issued by the Company subject to its General Conditions of Service printed overleaf, available on request or accessible at <http://www.sgs.com.tw/Terms-and-Conditions> and for electronic format documents, subject to Terms and Conditions for Electronic Documents at <http://www.sgs.com.tw/Terms-and-Conditions>. Attention is drawn to the limitation of liability, indemnification and jurisdiction issues defined therein. Any holder of this document is advised that information contained hereon reflects the Company's findings at the time of its intervention only and within the limits of Client's instructions, if any. The Company's sole responsibility is to its Client and this document does not exonerate parties to a transaction from exercising all their rights and obligations under the transaction documents. This document cannot be reproduced except in full, without prior written approval of the Company. Any unauthorized alteration, forgery or falsification of the content or appearance of this document is unlawful and offenders may be prosecuted to the fullest extent of the law.

Report Number :ER/2020/70076  
 Operation Mode :802.11n20  
 Test Frequency :2437 MHz  
 Test Mode :Tx CH Mid  
 EUT Pol :H Plane

Test Site :SAC I Chamber  
 Test Date :2020-08-12  
 Temp./Humi. :26.5/71  
 Antenna Pol. :VERTICAL  
 Engineer :Neo

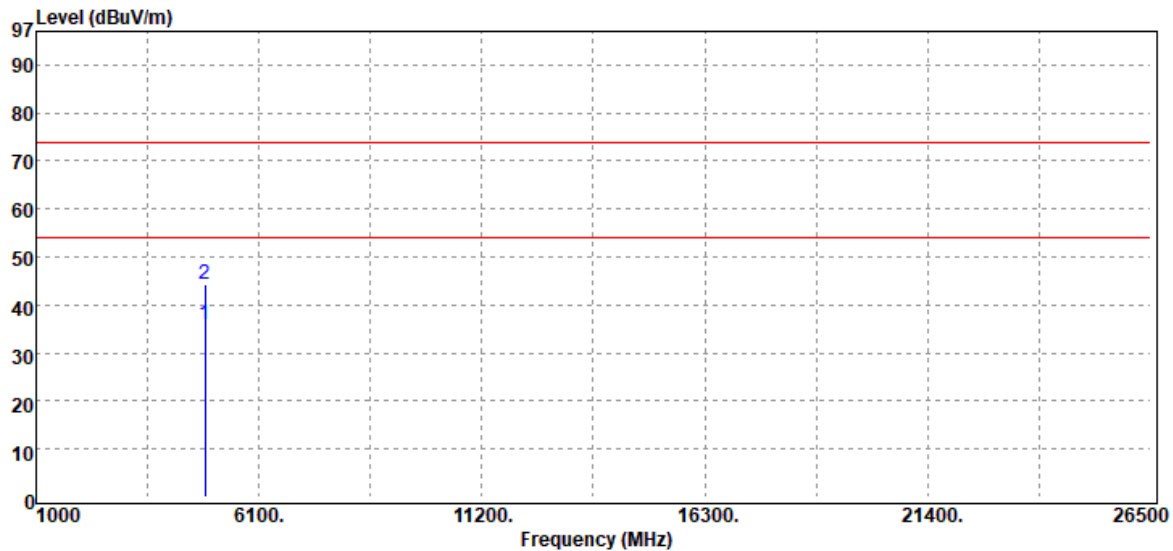

Freq. MHz	Detector Mode	Spectrum Reading Level dB $\mu$ V	Factor dB	Actual FS dB $\mu$ V/m	Limit @3m dB $\mu$ V/m	Margin dB
4874.00	Average	21.17	14.85	36.02	54.00	-17.98
4874.00	Peak	29.39	14.85	44.24	74.00	-29.76

Unless otherwise stated the results shown in this test report refer only to the sample(s) tested and such sample(s) are retained for 90 days only.

除非另有說明，此報告結果僅對測試之樣品負責，同時此樣品僅保留90天。本報告未經本公司書面許可，不可部份複製。

This document is issued by the Company subject to its General Conditions of Service printed overleaf, available on request or accessible at <http://www.sgs.com.tw/Terms-and-Conditions> and for electronic format documents, subject to Terms and Conditions for Electronic Documents at <http://www.sgs.com.tw/Terms-and-Conditions>. Attention is drawn to the limitation of liability, indemnification and jurisdiction issues defined therein. Any holder of this document is advised that information contained hereon reflects the Company's findings at the time of its intervention only and within the limits of Client's instructions, if any. The Company's sole responsibility is to its Client and this document does not exonerate parties to a transaction from exercising all their rights and obligations under the transaction documents. This document cannot be reproduced except in full, without prior written approval of the Company. Any unauthorized alteration, forgery or falsification of the content or appearance of this document is unlawful and offenders may be prosecuted to the fullest extent of the law.



Report Number :ER/2020/70076  
 Operation Mode :802.11n20  
 Test Frequency :2437 MHz  
 Test Mode :Tx CH Mid  
 EUT Pol :H Plane

Test Site :SAC I Chamber  
 Test Date :2020-08-12  
 Temp./Humi. :26.5/71  
 Antenna Pol. :HORIZONTAL  
 Engineer :Neo

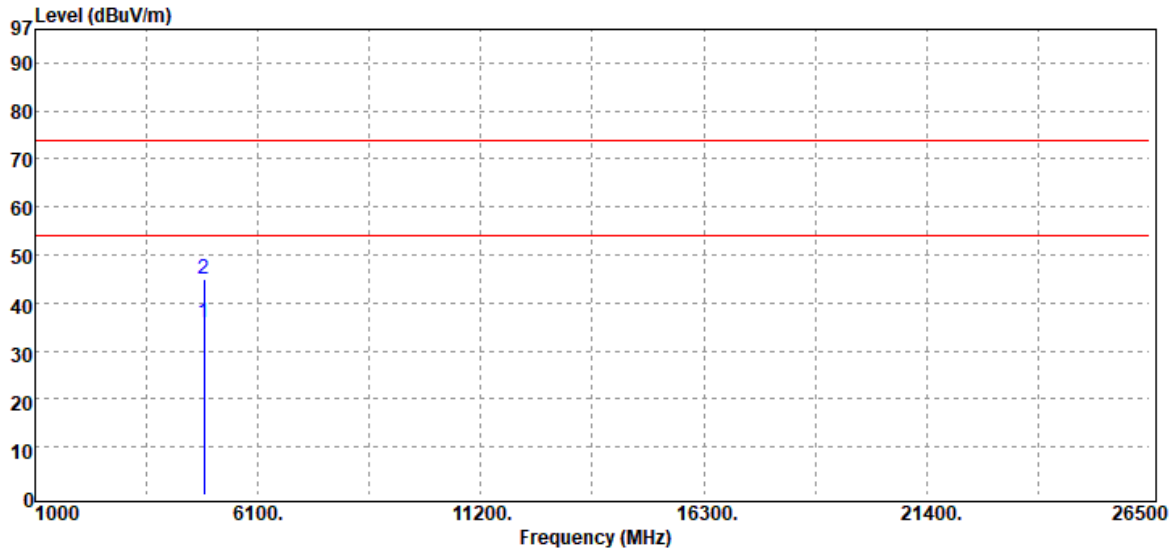

Freq. MHz	Detector Mode	Spectrum Reading Level dB $\mu$ V	Factor dB	Actual FS dB $\mu$ V/m	Limit @3m dB $\mu$ V/m	Margin dB
4874.00	Average	20.99	14.85	35.84	54.00	-18.16
4874.00	Peak	30.16	14.85	45.01	74.00	-28.99

Unless otherwise stated the results shown in this test report refer only to the sample(s) tested and such sample(s) are retained for 90 days only.

除非另有說明，此報告結果僅對測試之樣品負責，同時此樣品僅保留90天。本報告未經本公司書面許可，不可部份複製。

This document is issued by the Company subject to its General Conditions of Service printed overleaf, available on request or accessible at <http://www.sgs.com.tw/Terms-and-Conditions> and for electronic format documents, subject to Terms and Conditions for Electronic Documents at <http://www.sgs.com.tw/Terms-and-Conditions>. Attention is drawn to the limitation of liability, indemnification and jurisdiction issues defined therein. Any holder of this document is advised that information contained hereon reflects the Company's findings at the time of its intervention only and within the limits of Client's instructions, if any. The Company's sole responsibility is to its Client and this document does not exonerate parties to a transaction from exercising all their rights and obligations under the transaction documents. This document cannot be reproduced except in full, without prior written approval of the Company. Any unauthorized alteration, forgery or falsification of the content or appearance of this document is unlawful and offenders may be prosecuted to the fullest extent of the law.

Report Number :ER/2020/70076  
 Operation Mode :802.11n20  
 Test Frequency :2462 MHz  
 Test Mode :Tx CH High  
 EUT Pol :H Plane

Test Site :SAC I Chamber  
 Test Date :2020-08-12  
 Temp./Humi. :26.5/71  
 Antenna Pol. :VERTICAL  
 Engineer :Neo

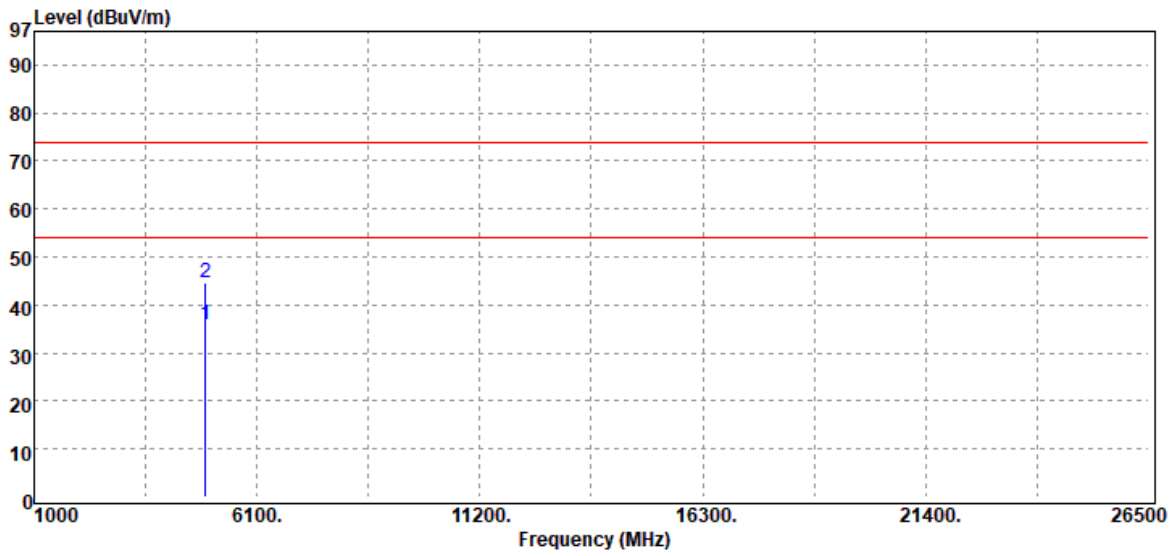

Freq. MHz	Detector Mode	Spectrum Reading Level dB $\mu$ V	Factor dB	Actual FS dB $\mu$ V/m	Limit @3m dB $\mu$ V/m	Margin dB
4924.00	Average	20.88	14.87	35.75	54.00	-18.25
4924.00	Peak	29.80	14.87	44.67	74.00	-29.33

Unless otherwise stated the results shown in this test report refer only to the sample(s) tested and such sample(s) are retained for 90 days only.

除非另有說明，此報告結果僅對測試之樣品負責，同時此樣品僅保留90天。本報告未經本公司書面許可，不可部份複製。

This document is issued by the Company subject to its General Conditions of Service printed overleaf, available on request or accessible at <http://www.sgs.com.tw/Terms-and-Conditions> and for electronic format documents, subject to Terms and Conditions for Electronic Documents at <http://www.sgs.com.tw/Terms-and-Conditions>. Attention is drawn to the limitation of liability, indemnification and jurisdiction issues defined therein. Any holder of this document is advised that information contained hereon reflects the Company's findings at the time of its intervention only and within the limits of Client's instructions, if any. The Company's sole responsibility is to its Client and this document does not exonerate parties to a transaction from exercising all their rights and obligations under the transaction documents. This document cannot be reproduced except in full, without prior written approval of the Company. Any unauthorized alteration, forgery or falsification of the content or appearance of this document is unlawful and offenders may be prosecuted to the fullest extent of the law.

Report Number :ER/2020/70076  
 Operation Mode :802.11n20  
 Test Frequency :2462 MHz  
 Test Mode :Tx CH High  
 EUT Pol :H Plane

Test Site :SAC I Chamber  
 Test Date :2020-08-12  
 Temp./Humi. :26.5/71  
 Antenna Pol. :HORIZONTAL  
 Engineer :Neo

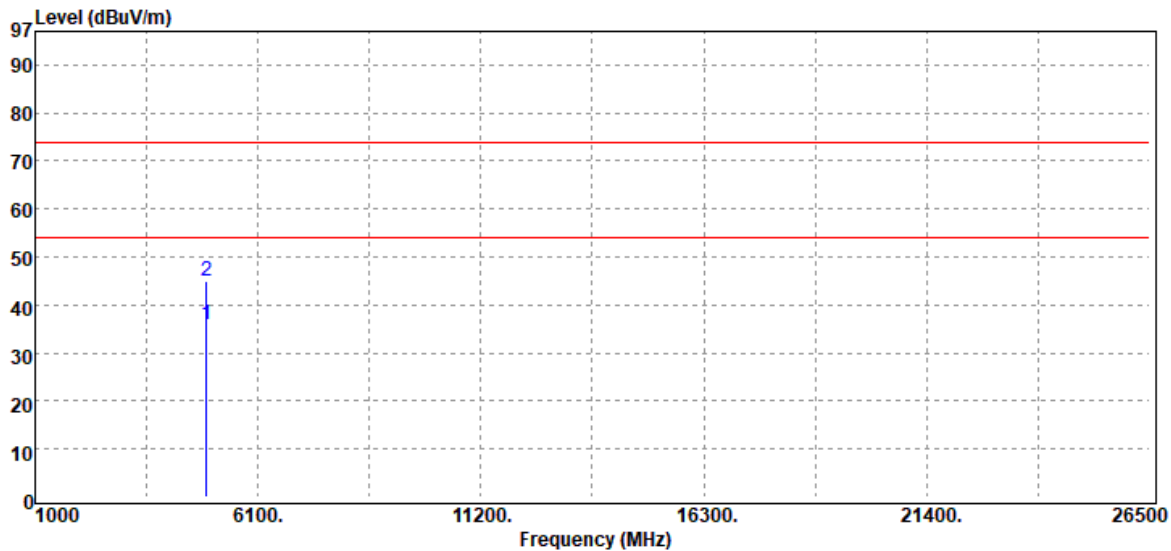

Freq. MHz	Detector Mode	Spectrum Reading Level dB $\mu$ V	Factor dB	Actual FS dB $\mu$ V/m	Limit @3m dB $\mu$ V/m	Margin dB
4924.00	Average	20.91	14.87	35.78	54.00	-18.22
4924.00	Peak	30.07	14.87	44.94	74.00	-29.06

Unless otherwise stated the results shown in this test report refer only to the sample(s) tested and such sample(s) are retained for 90 days only.

除非另有說明，此報告結果僅對測試之樣品負責，同時此樣品僅保留90天。本報告未經本公司書面許可，不可部份複製。

This document is issued by the Company subject to its General Conditions of Service printed overleaf, available on request or accessible at <http://www.sgs.com.tw/Terms-and-Conditions> and for electronic format documents, subject to Terms and Conditions for Electronic Documents at <http://www.sgs.com.tw/Terms-and-Conditions>. Attention is drawn to the limitation of liability, indemnification and jurisdiction issues defined therein. Any holder of this document is advised that information contained hereon reflects the Company's findings at the time of its intervention only and within the limits of Client's instructions, if any. The Company's sole responsibility is to its Client and this document does not exonerate parties to a transaction from exercising all their rights and obligations under the transaction documents. This document cannot be reproduced except in full, without prior written approval of the Company. Any unauthorized alteration, forgery or falsification of the content or appearance of this document is unlawful and offenders may be prosecuted to the fullest extent of the law.

Report Number :ER/2020/70076  
 Operation Mode :802.11n20  
 Test Frequency :2467 MHz  
 Test Mode :Tx CH High  
 EUT Pol :H Plane

Test Site :SAC I Chamber  
 Test Date :2020-08-12  
 Temp./Humi. :26.5/71  
 Antenna Pol. :VERTICAL  
 Engineer :Neo

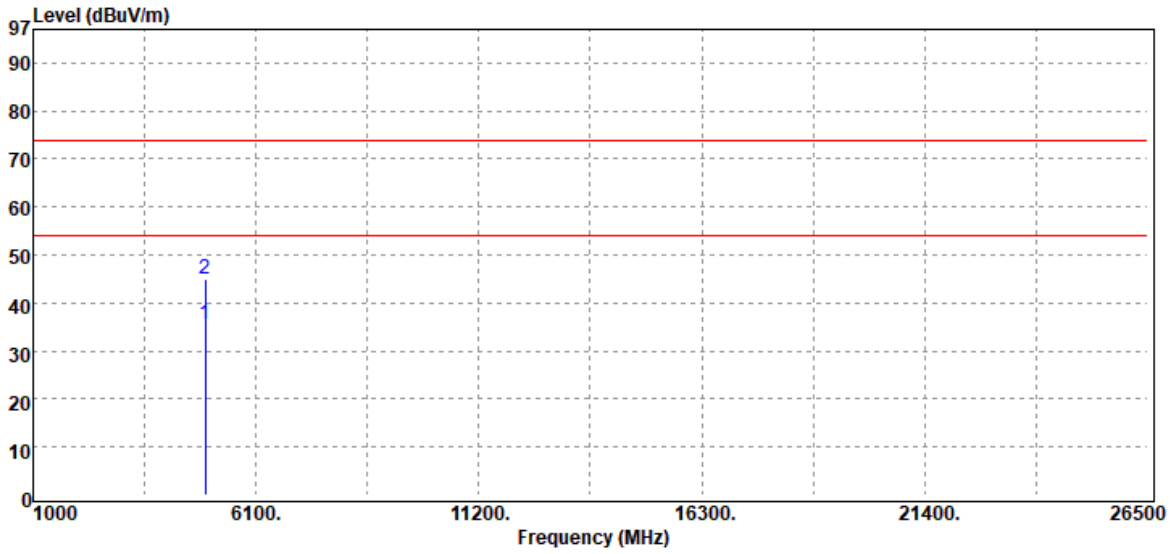

Freq. MHz	Detector Mode	Spectrum Reading Level dB $\mu$ V	Factor dB	Actual FS dB $\mu$ V/m	Limit @3m dB $\mu$ V/m	Margin dB
4934.00	Average	20.92	14.77	35.69	54.00	-18.31
4934.00	Peak	30.07	14.77	44.84	74.00	-29.16

Unless otherwise stated the results shown in this test report refer only to the sample(s) tested and such sample(s) are retained for 90 days only.

除非另有說明，此報告結果僅對測試之樣品負責，同時此樣品僅保留90天。本報告未經本公司書面許可，不可部份複製。

This document is issued by the Company subject to its General Conditions of Service printed overleaf, available on request or accessible at <http://www.sgs.com.tw/Terms-and-Conditions> and for electronic format documents, subject to Terms and Conditions for Electronic Documents at <http://www.sgs.com.tw/Terms-and-Conditions>. Attention is drawn to the limitation of liability, indemnification and jurisdiction issues defined therein. Any holder of this document is advised that information contained hereon reflects the Company's findings at the time of its intervention only and within the limits of Client's instructions, if any. The Company's sole responsibility is to its Client and this document does not exonerate parties to a transaction from exercising all their rights and obligations under the transaction documents. This document cannot be reproduced except in full, without prior written approval of the Company. Any unauthorized alteration, forgery or falsification of the content or appearance of this document is unlawful and offenders may be prosecuted to the fullest extent of the law.

Report Number :ER/2020/70076  
 Operation Mode :802.11n20  
 Test Frequency :2467 MHz  
 Test Mode :Tx CH High  
 EUT Pol :H Plane

Test Site :SAC I Chamber  
 Test Date :2020-08-12  
 Temp./Humi. :26.5/71  
 Antenna Pol. :HORIZONTAL  
 Engineer :Neo

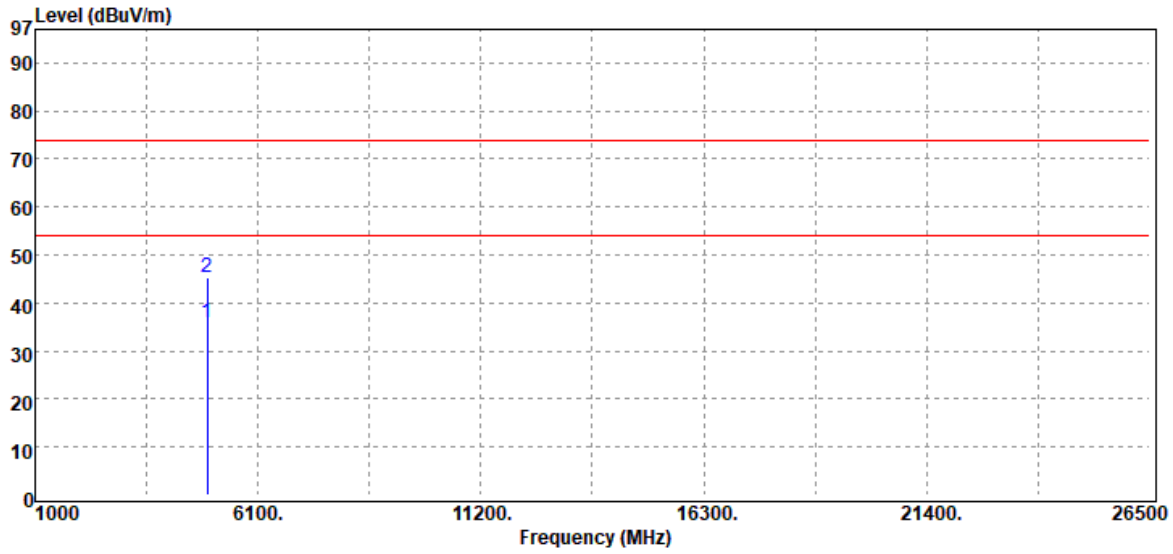

Freq. MHz	Detector Mode	Spectrum Reading Level dB $\mu$ V	Factor dB	Actual FS dB $\mu$ V/m	Limit @3m dB $\mu$ V/m	Margin dB
4934.00	Average	21.01	14.77	35.78	54.00	-18.22
4934.00	Peak	30.70	14.77	45.47	74.00	-28.53

Unless otherwise stated the results shown in this test report refer only to the sample(s) tested and such sample(s) are retained for 90 days only.

除非另有說明，此報告結果僅對測試之樣品負責，同時此樣品僅保留90天。本報告未經本公司書面許可，不可部份複製。

This document is issued by the Company subject to its General Conditions of Service printed overleaf, available on request or accessible at <http://www.sgs.com.tw/Terms-and-Conditions> and for electronic format documents, subject to Terms and Conditions for Electronic Documents at <http://www.sgs.com.tw/Terms-and-Conditions>. Attention is drawn to the limitation of liability, indemnification and jurisdiction issues defined therein. Any holder of this document is advised that information contained hereon reflects the Company's findings at the time of its intervention only and within the limits of Client's instructions, if any. The Company's sole responsibility is to its Client and this document does not exonerate parties to a transaction from exercising all their rights and obligations under the transaction documents. This document cannot be reproduced except in full, without prior written approval of the Company. Any unauthorized alteration, forgery or falsification of the content or appearance of this document is unlawful and offenders may be prosecuted to the fullest extent of the law.

Report Number :ER/2020/70076  
 Operation Mode :802.11n20  
 Test Frequency :2472 MHz  
 Test Mode :Tx CH High  
 EUT Pol :H Plane

Test Site :SAC I Chamber  
 Test Date :2020-08-17  
 Temp./Humi. :27.2/73  
 Antenna Pol. :VERTICAL  
 Engineer :Neo

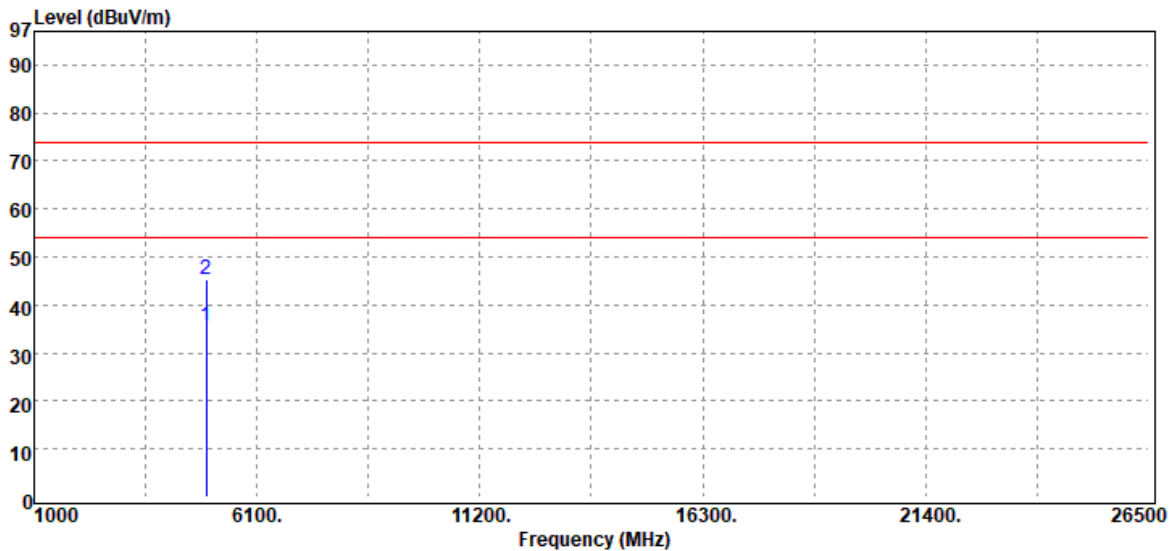

Freq. MHz	Detector Mode	Spectrum Reading Level dB $\mu$ V	Factor dB	Actual FS dB $\mu$ V/m	Limit @3m dB $\mu$ V/m	Margin dB
4944.00	Average	20.90	14.64	35.54	54.00	-18.46
4944.00	Peak	30.71	14.64	45.35	74.00	-28.65

Unless otherwise stated the results shown in this test report refer only to the sample(s) tested and such sample(s) are retained for 90 days only.

除非另有說明，此報告結果僅對測試之樣品負責，同時此樣品僅保留90天。本報告未經本公司書面許可，不可部份複製。

This document is issued by the Company subject to its General Conditions of Service printed overleaf, available on request or accessible at <http://www.sgs.com.tw/Terms-and-Conditions> and for electronic format documents, subject to Terms and Conditions for Electronic Documents at <http://www.sgs.com.tw/Terms-and-Conditions>. Attention is drawn to the limitation of liability, indemnification and jurisdiction issues defined therein. Any holder of this document is advised that information contained hereon reflects the Company's findings at the time of its intervention only and within the limits of Client's instructions, if any. The Company's sole responsibility is to its Client and this document does not exonerate parties to a transaction from exercising all their rights and obligations under the transaction documents. This document cannot be reproduced except in full, without prior written approval of the Company. Any unauthorized alteration, forgery or falsification of the content or appearance of this document is unlawful and offenders may be prosecuted to the fullest extent of the law.

Report Number :ER/2020/70076  
 Operation Mode :802.11n20  
 Test Frequency :2472 MHz  
 Test Mode :Tx CH High  
 EUT Pol :H Plane

Test Site :SAC I Chamber  
 Test Date :2020-08-17  
 Temp./Humi. :27.2/73  
 Antenna Pol. :HORIZONTAL  
 Engineer :Neo

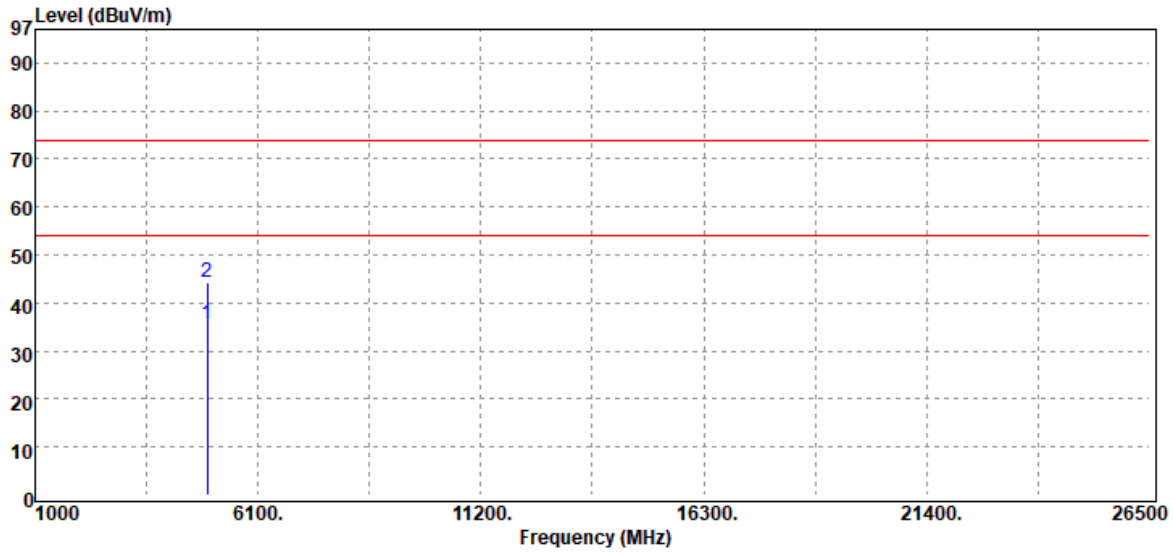

Freq. MHz	Detector Mode	Spectrum Reading Level dB $\mu$ V	Factor dB	Actual FS dB $\mu$ V/m	Limit @3m dB $\mu$ V/m	Margin dB
4944.00	Average	20.93	14.64	35.57	54.00	-18.43
4944.00	Peak	29.68	14.64	44.32	74.00	-29.68

Unless otherwise stated the results shown in this test report refer only to the sample(s) tested and such sample(s) are retained for 90 days only.

除非另有說明，此報告結果僅對測試之樣品負責，同時此樣品僅保留90天。本報告未經本公司書面許可，不可部份複製。

This document is issued by the Company subject to its General Conditions of Service printed overleaf, available on request or accessible at <http://www.sgs.com.tw/Terms-and-Conditions> and for electronic format documents, subject to Terms and Conditions for Electronic Documents at <http://www.sgs.com.tw/Terms-and-Conditions>. Attention is drawn to the limitation of liability, indemnification and jurisdiction issues defined therein. Any holder of this document is advised that information contained hereon reflects the Company's findings at the time of its intervention only and within the limits of Client's instructions, if any. The Company's sole responsibility is to its Client and this document does not exonerate parties to a transaction from exercising all their rights and obligations under the transaction documents. This document cannot be reproduced except in full, without prior written approval of the Company. Any unauthorized alteration, forgery or falsification of the content or appearance of this document is unlawful and offenders may be prosecuted to the fullest extent of the law.

## 12 POWER SPECTRAL DENSITY

### 12.1 Standard Applicable

Per Part 15.247 (e)

The power spectral density conducted from the intentional radiator to the antenna shall not be greater than 8dBm in any 3 kHz band during any time interval of continuous transmission.

This power spectral density shall be determined in accordance with the provisions of paragraph (b) of this section. The same method of determining the conducted output power shall be used to determine the power spectral density.

### 12.2 Measurement Equipment Used

Conducted Emission Test Site					
EQUIPMENT TYPE	MFR	MODEL NUMBER	SERIAL NUMBER	LAST CAL.	CAL DUE.
EXA Spectrum Analyzer	Agilent	N9010A	MY50420195	05/06/2020	05/05/2021
DC Power Supply	Agilent	E3640A	MY40005907	10/22/2019	10/21/2020
Attenuator	Mini-Circuit	BW-S10W2+	2	01/02/2020	01/01/2021
DC Block	Mini-Circuits	BLK-18-S+	1	01/02/2020	01/01/2021

### 12.3 Test Set-up

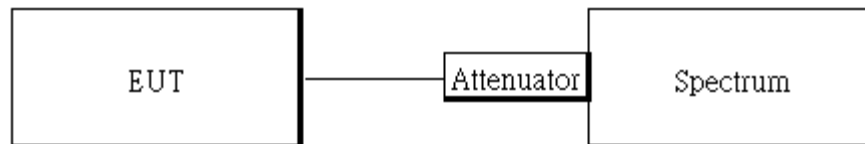

Unless otherwise stated the results shown in this test report refer only to the sample(s) tested and such sample(s) are retained for 90 days only.

除非另有說明，此報告結果僅對測試之樣品負責，同時此樣品僅保留90天。本報告未經本公司書面許可，不可部份複製。

This document is issued by the Company subject to its General Conditions of Service printed overleaf, available on request or accessible at <http://www.sgs.com.tw/Terms-and-Conditions> and for electronic format documents, subject to Terms and Conditions for Electronic Documents at <http://www.sgs.com.tw/Terms-and-Conditions>. Attention is drawn to the limitation of liability, indemnification and jurisdiction issues defined therein. Any holder of this document is advised that information contained hereon reflects the Company's findings at the time of its intervention only and within the limits of Client's instructions, if any. The Company's sole responsibility is to its Client and this document does not exonerate parties to a transaction from exercising all their rights and obligations under the transaction documents. This document cannot be reproduced except in full, without prior written approval of the Company. Any unauthorized alteration, forgery or falsification of the content or appearance of this document is unlawful and offenders may be prosecuted to the fullest extent of the law.



## 12.4 Measurement Procedure

1. Set analyzer center frequency to DTS channel center frequency.
2. The testing follows the Measurement Procedure of FCC KDB 558074 D01 DTS Meas. Guidance .
3. Set the span to 1.5 times the DTS channel bandwidth.
4. Set the RBW = 3 kHz & VBW = 10 kHz.
5. Detector = peak.
6. Sweep time = auto couple.
7. Trace mode = max hold.
8. Allow trace to fully stabilize.
9. Use the peak marker function to determine the maximum amplitude level.

The antenna gain is not greater than 6 dBi. Therefore, reduction of power is not required.

Unless otherwise stated the results shown in this test report refer only to the sample(s) tested and such sample(s) are retained for 90 days only.  
除非另有說明，此報告結果僅對測試之樣品負責，同時此樣品僅保留90天。本報告未經本公司書面許可，不可部份複製。

This document is issued by the Company subject to its General Conditions of Service printed overleaf, available on request or accessible at <http://www.sgs.com.tw/Terms-and-Conditions> and for electronic format documents, subject to Terms and Conditions for Electronic Documents at <http://www.sgs.com.tw/Terms-and-Conditions>. Attention is drawn to the limitation of liability, indemnification and jurisdiction issues defined therein. Any holder of this document is advised that information contained hereon reflects the Company's findings at the time of its intervention only and within the limits of Client's instructions, if any. The Company's sole responsibility is to its Client and this document does not exonerate parties to a transaction from exercising all their rights and obligations under the transaction documents. This document cannot be reproduced except in full, without prior written approval of the Company. Any unauthorized alteration, forgery or falsification of the content or appearance of this document is unlawful and offenders may be prosecuted to the fullest extent of the law.

## 12.5 Power spectral density

POWER DENSITY 802.11b_Ch0			
Freq. (MHz)	PSD (dBm/3kHz)	Limit (dBm/3kHz)	Result
2412	-7.94	8.00	PASS
2437	-7.19	8.00	PASS
2462	-6.99	8.00	PASS
2467	-6.92	8.00	PASS
2472	-7.08	8.00	PASS

POWER DENSITY 802.11g_Ch0			
Freq. (MHz)	PSD (dBm/3kHz)	Limit (dBm/3kHz)	Result
2412	-15.55	8.00	PASS
2437	-14.67	8.00	PASS
2462	-15.51	8.00	PASS
2467	-15.31	8.00	PASS
2472	-21.59	8.00	PASS

POWER DENSITY 802.11n HT20_Ch0			
Freq. (MHz)	PSD (dBm/3kHz)	Limit (dBm/3kHz)	Result
2412	-16.16	8.00	PASS
2437	-14.54	8.00	PASS
2462	-15.60	8.00	PASS
2467	-15.94	8.00	PASS
2472	-22.33	8.00	PASS

\*Refer to next page for plots

Unless otherwise stated the results shown in this test report refer only to the sample(s) tested and such sample(s) are retained for 90 days only.

除非另有說明，此報告結果僅對測試之樣品負責，同時此樣品僅保留90天。本報告未經本公司書面許可，不可部份複製。

This document is issued by the Company subject to its General Conditions of Service printed overleaf, available on request or accessible at <http://www.sgs.com.tw/Terms-and-Conditions> and for electronic format documents, subject to Terms and Conditions for Electronic Documents at <http://www.sgs.com.tw/Terms-and-Conditions>. Attention is drawn to the limitation of liability, indemnification and jurisdiction issues defined therein. Any holder of this document is advised that information contained hereon reflects the Company's findings at the time of its intervention only and within the limits of Client's instructions, if any. The Company's sole responsibility is to its Client and this document does not exonerate parties to a transaction from exercising all their rights and obligations under the transaction documents. This document cannot be reproduced except in full, without prior written approval of the Company. Any unauthorized alteration, forgery or falsification of the content or appearance of this document is unlawful and offenders may be prosecuted to the fullest extent of the law.

Power Density\_802.11b\_20MHz\_Chain0\_2412MHz



Power Density\_802.11b\_20MHz\_Chain0\_2467MHz



Power Density\_802.11b\_20MHz\_Chain0\_2437MHz



Power Density\_802.11b\_20MHz\_Chain0\_2472MHz

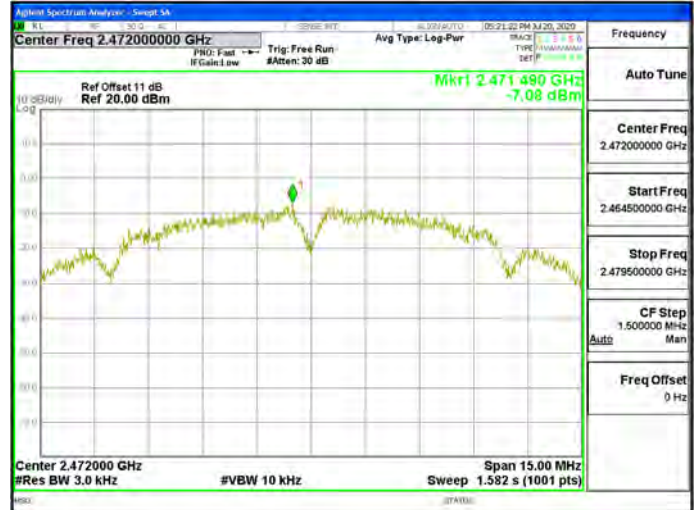

Power Density\_802.11b\_20MHz\_Chain0\_2462MHz



Power Density\_802.11g\_20MHz\_Chain0\_2412MHz

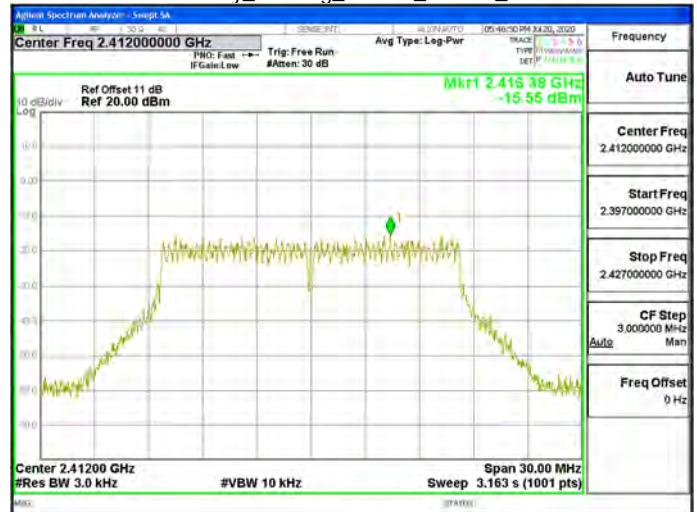

Unless otherwise stated the results shown in this test report refer only to the sample(s) tested and such sample(s) are retained for 90 days only.

除非另有說明，此報告結果僅對測試之樣品負責，同時此樣品僅保留90天。本報告未經本公司書面許可，不可部份複製。

This document is issued by the Company subject to its General Conditions of Service printed overleaf, available on request or accessible at <http://www.sgs.com.tw/Terms-and-Conditions> and for electronic format documents, subject to Terms and Conditions for Electronic Documents at <http://www.sgs.com.tw/Terms-and-Conditions>. Attention is drawn to the limitation of liability, indemnification and jurisdiction issues defined therein. Any holder of this document is advised that information contained hereon reflects the Company's findings at the time of its intervention only and within the limits of Client's instructions, if any. The Company's sole responsibility is to its Client and this document does not exonerate parties to a transaction from exercising all their rights and obligations under the transaction documents. This document cannot be reproduced except in full, without prior written approval of the Company. Any unauthorized alteration, forgery or falsification of the content or appearance of this document is unlawful and offenders may be prosecuted to the fullest extent of the law.

Power Density\_802.11g\_20MHz\_Chain0\_2437MHz

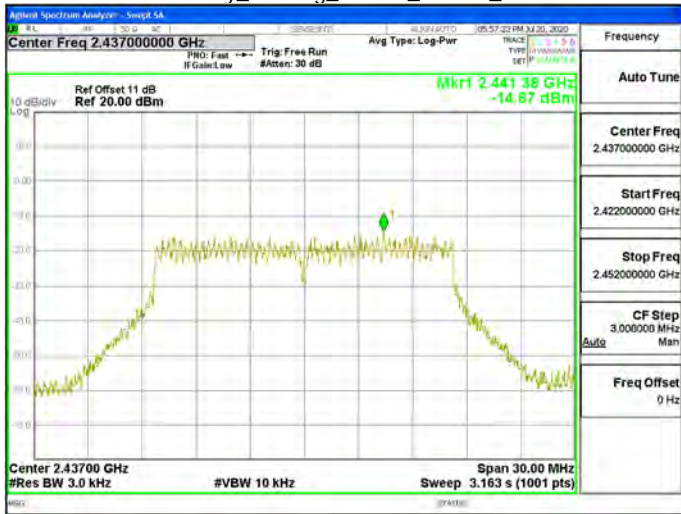

Power Density\_802.11g\_20MHz\_Chain0\_2472MHz

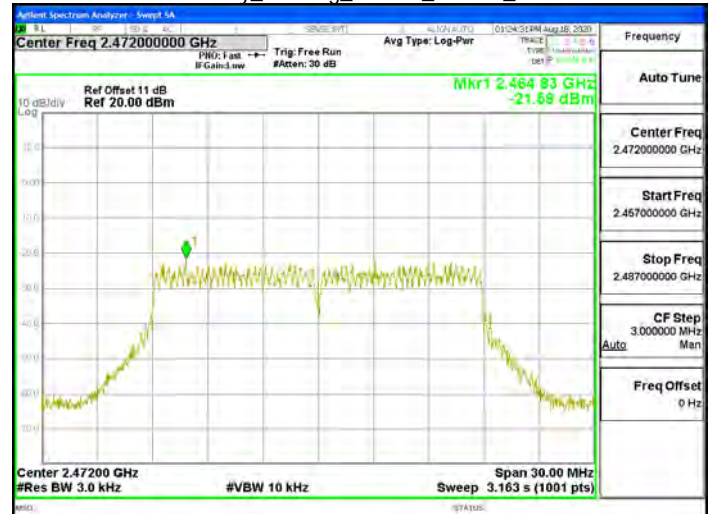

Power Density\_802.11g\_20MHz\_Chain0\_2462MHz

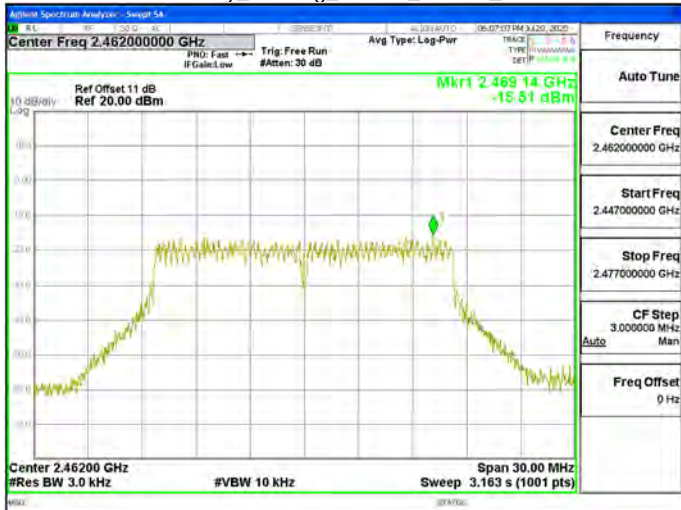

Power Density\_802.11n\_20MHz\_Chain0\_2412MHz

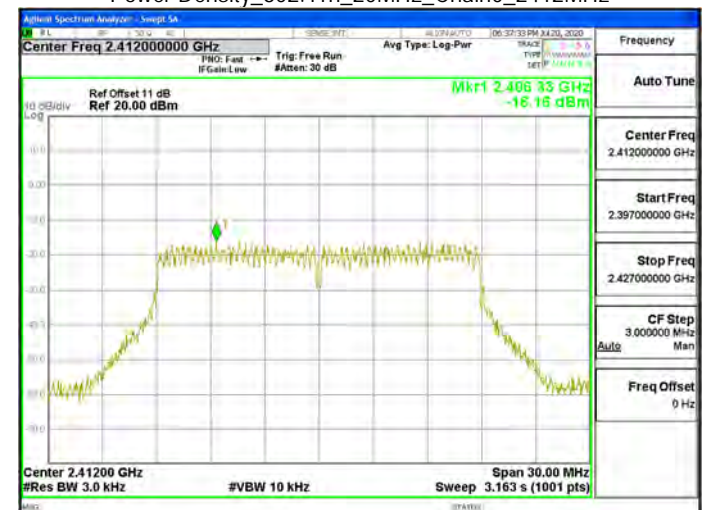

Power Density\_802.11g\_20MHz\_Chain0\_2467MHz



Power Density\_802.11n\_20MHz\_Chain0\_2437MHz

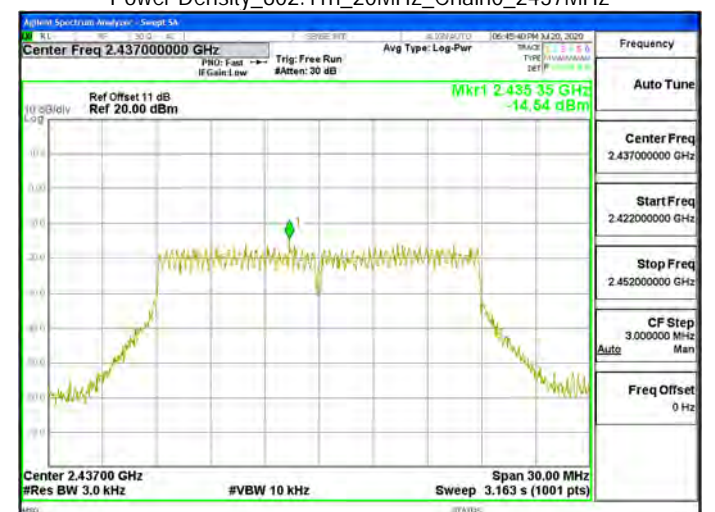

Unless otherwise stated the results shown in this test report refer only to the sample(s) tested and such sample(s) are retained for 90 days only.

除非另有說明，此報告結果僅對測試之樣品負責，同時此樣品僅保留90天。本報告未經本公司書面許可，不可部份複製。

This document is issued by the Company subject to its General Conditions of Service printed overleaf, available on request or accessible at <http://www.sgs.com.tw/Terms-and-Conditions> and for electronic format documents, subject to Terms and Conditions for Electronic Documents at <http://www.sgs.com.tw/Terms-and-Conditions>. Attention is drawn to the limitation of liability, indemnification and jurisdiction issues defined therein. Any holder of this document is advised that information contained hereon reflects the Company's findings at the time of its intervention only and within the limits of Client's instructions, if any. The Company's sole responsibility is to its Client and this document does not exonerate parties to a transaction from exercising all their rights and obligations under the transaction documents. This document cannot be reproduced except in full, without prior written approval of the Company. Any unauthorized alteration, forgery or falsification of the content or appearance of this document is unlawful and offenders may be prosecuted to the fullest extent of the law.

Power Density\_802.11n\_20MHz\_Chain0\_2462MHz

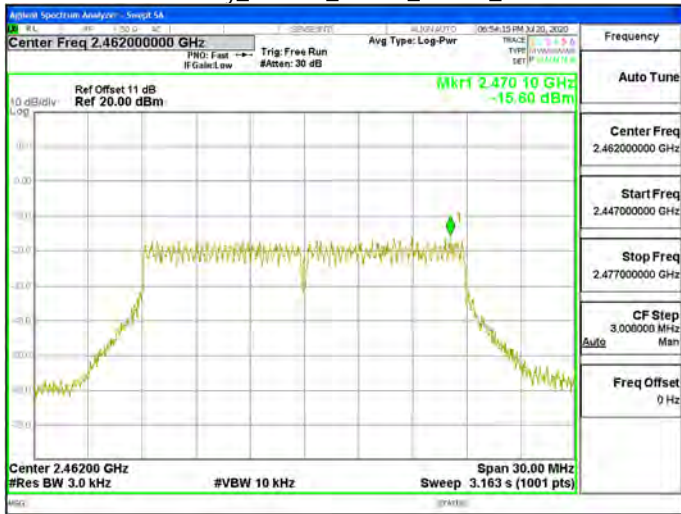

Power Density\_802.11n\_20MHz\_Chain0\_2467MHz

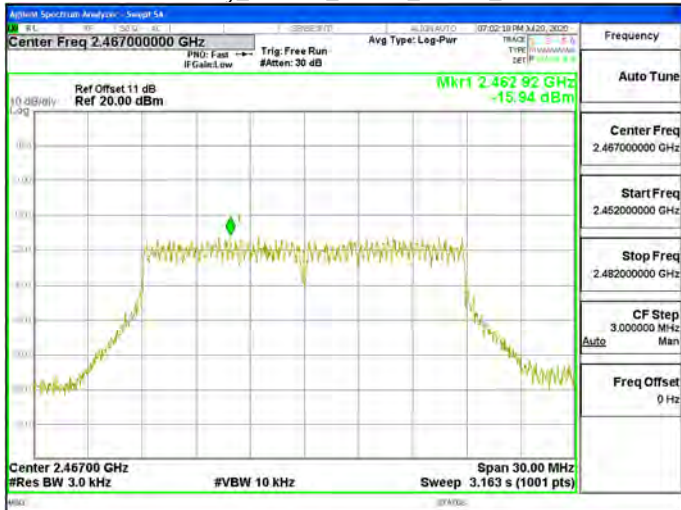

Power Density\_802.11n\_20MHz\_Chain0\_2472MHz



Unless otherwise stated the results shown in this test report refer only to the sample(s) tested and such sample(s) are retained for 90 days only.

除非另有說明，此報告結果僅對測試之樣品負責，同時此樣品僅保留90天。本報告未經本公司書面許可，不可部份複製。

This document is issued by the Company subject to its General Conditions of Service printed overleaf, available on request or accessible at <http://www.sgs.com.tw/Terms-and-Conditions> and for electronic format documents, subject to Terms and Conditions for Electronic Documents at <http://www.sgs.com.tw/Terms-and-Conditions>. Attention is drawn to the limitation of liability, indemnification and jurisdiction issues defined therein. Any holder of this document is advised that information contained hereon reflects the Company's findings at the time of its intervention only and within the limits of Client's instructions, if any. The Company's sole responsibility is to its Client and this document does not exonerate parties to a transaction from exercising all their rights and obligations under the transaction documents. This document cannot be reproduced except in full, without prior written approval of the Company. Any unauthorized alteration, forgery or falsification of the content or appearance of this document is unlawful and offenders may be prosecuted to the fullest extent of the law.

## 13 ANTENNA REQUIREMENT

### 13.1 Standard Applicable

For intentional device, according to §15.203, an intentional radiator shall be designed to ensure that no antenna other than furnished by the responsible party shall be used with the device.

If the transmitting antenna is greater than 6dBi, the power shall be reduced by the same level in dB comparing to gain minus 6dBi.

### 13.2 Antenna Connected Construction

The antenna is designed with unique RF connector and no consideration of replacement. Please see EUT photo for details.

*~ End of Report ~*

Unless otherwise stated the results shown in this test report refer only to the sample(s) tested and such sample(s) are retained for 90 days only.

除非另有說明，此報告結果僅對測試之樣品負責，同時此樣品僅保留90天。本報告未經本公司書面許可，不可部份複製。

This document is issued by the Company subject to its General Conditions of Service printed overleaf, available on request or accessible at <http://www.sgs.com.tw/Terms-and-Conditions> and for electronic format documents, subject to Terms and Conditions for Electronic Documents at <http://www.sgs.com.tw/Terms-and-Conditions>. Attention is drawn to the limitation of liability, indemnification and jurisdiction issues defined therein. Any holder of this document is advised that information contained hereon reflects the Company's findings at the time of its intervention only and within the limits of Client's instructions, if any. The Company's sole responsibility is to its Client and this document does not exonerate parties to a transaction from exercising all their rights and obligations under the transaction documents. This document cannot be reproduced except in full, without prior written approval of the Company. Any unauthorized alteration, forgery or falsification of the content or appearance of this document is unlawful and offenders may be prosecuted to the fullest extent of the law.