

FCC SAR Test Report

APPLICANT : Montblanc-Simplo GmbH
EQUIPMENT : Smart watch
BRAND NAME : MONTBLANC
MODEL NAME : S2C19
FCC ID : 2AENP-S2C19
STANDARD : FCC 47 CFR Part 2 (2.1093)
ANSI/IEEE C95.1-1992
IEEE 1528-2013

The product was received on Aug. 08, 2019 and testing was started from Aug. 25, 2019 and completed on Sep. 03, 2019. We, Sporton International (Kunshan) Inc, would like to declare that the tested sample has been evaluated in accordance with the procedures and had been in compliance with the applicable technical standards.

The test results in this report apply exclusively to the tested model / sample. Without written approval of Sporton International (Kunshan) Inc., the test report shall not be reproduced except in full.

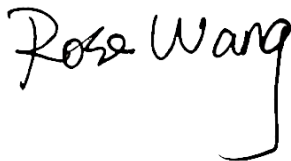

Reviewed by: Rose Wang / Supervisor

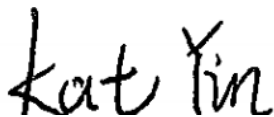

Approved by: Kat Yin / Manager



Sporton International (Kunshan) Inc.

No. 1098, Pengxi North Road, Kunshan Economic Development Zone Jiangsu Province 215300
People's Republic of China



Table of Contents

1. Statement of Compliance 4
2. Administration Data 5
3. Guidance Applied..... 5
4. Equipment Under Test (EUT) Information 6
4.1 General Information 6
4.2 General LTE SAR Test and Reporting Considerations 7
5. RF Exposure Limits..... 9
5.1 Uncontrolled Environment..... 9
5.2 Controlled Environment..... 9
6. Specific Absorption Rate (SAR).....10
6.1 Introduction10
6.2 SAR Definition.....10
7. System Description and Setup11
7.1 E-Field Probe12
7.2 Data Acquisition Electronics (DAE)12
7.3 Phantom.....13
7.4 Device Holder.....14
8. Measurement Procedures15
8.1 Spatial Peak SAR Evaluation15
8.2 Power Reference Measurement.....16
8.3 Area Scan16
8.4 Zoom Scan.....17
8.5 Volume Scan Procedures.....17
8.6 Power Drift Monitoring.....17
9. Test Equipment List18
10. System Verification19
10.1 Tissue Simulating Liquids.....19
10.2 Tissue Verification20
10.3 System Performance Check Results.....21
11. RF Exposure Positions22
11.1 Limb-Worn Accessory.....22
12. Conducted RF Output Power (Unit: dBm).....23
13. Bluetooth Exclusions Applied36
14. SAR Test Results37
14.1 Next to Mouth SAR38
14.2 Wrist-Worn SAR.....39
15. Simultaneous Transmission Analysis.....40
15.1 Next to Mouth Exposure Conditions.....41
15.2 Wrist-Worn Exposure Conditions41
16. Uncertainty Assessment42
17. References.....43
Appendix A. Plots of System Performance Check
Appendix B. Plots of High SAR Measurement
Appendix C. DASy Calibration Certificate
Appendix D. Test Setup Photos



Revision History

REPORT NO.	VERSION	DESCRIPTION	ISSUED DATE
FA980807-01	Rev. 01	Initial issue of report	Sep. 24, 2019

1. Statement of Compliance

The maximum results of Specific Absorption Rate (SAR) found during testing for **Montblanc-Simplo GmbH, Smart watch, S2C19**, are as follows.

1g Next to Mouth SAR:

Equipment Class	Frequency Band	Highest SAR Summary		Highest Simultaneous Transmission 1g SAR (W/kg)
		Next to Mouth SAR (Separation 10mm)	1g SAR (W/kg)	
Licensed	LTE	Band 13	<0.10	1.07
		Band 5	<0.10	
		Band 4	0.67	
		Band 2	0.79	
		Band 7	0.91	
DTS	WLAN	2.4GHz WLAN	0.17	1.07
Date of Testing:			2019/8/25~2019/9/3	

10g Extremity SAR:

Equipment Class	Frequency Band	Highest SAR Summary		Highest Simultaneous Transmission 10g SAR (W/kg)
		Wrist-worn SAR (Separation 0mm)	10g SAR (W/kg)	
Licensed	LTE	Band 13	0.27	2.17
		Band 5	0.22	
		Band 4	1.98	
		Band 2	1.07	
		Band 7	1.13	
DTS	WLAN	2.4GHz WLAN	0.19	2.17
Date of Testing:			2019/8/25~2019/9/3	

Declaration of Conformity:

The test results with all measurement uncertainty excluded are presented in accordance with the regulation limits or requirements declared by manufacturers.

Comments and Explanations:

The declared of product specification for EUT presented in the report are provided by the manufacturer, and the manufacturer takes all the responsibilities for the accuracy of product specification.

This device is in compliance with Specific Absorption Rate (SAR) for general population/uncontrolled 1g SAR exposure limits (1.6 W/kg) and 10g Extremity SAR (4.0 W/kg) specified in FCC 47 CFR part 2 (2.1093) and ANSI/IEEE C95.1-1992, and had been tested in accordance with the measurement methods and procedures specified in IEEE 1528-2013 and FCC KDB publications.



2. Administration Data

Sporton International (Kunshan) Inc. is accredited to ISO/IEC 17025:2017 by American Association for Laboratory Accreditation with Certificate Number 5145.02.

Testing Laboratory		
Test Firm	Sporton International (Kunshan) Inc.	
Test Site Location	No. 1098, Pengxi North Road, Kunshan Economic Development Zone Jiangsu Province 215300 People's Republic of China TEL : +86-512-57900158 FAX : +86-512-57900958	
Test Site No.	FCC Designation No.	FCC Test Firm Registration No.
	CN1257	314309

Applicant	
Company Name	Montblanc-Simplo GmbH
Address	Hellgrundweg 100, 22525 Hamburg, Germany

Manufacturer	
Company Name	Montblanc-Simplo GmbH
Address	Hellgrundweg 100, 22525 Hamburg, Germany

3. Guidance Applied

The Specific Absorption Rate (SAR) testing specification, method, and procedure for this device is in accordance with the following standards:

- FCC 47 CFR Part 2 (2.1093)
- ANSI/IEEE C95.1-1992
- IEEE 1528-2013
- FCC KDB 865664 D01 SAR Measurement 100 MHz to 6 GHz v01r04
- FCC KDB 865664 D02 SAR Reporting v01r02
- FCC KDB 447498 D01 General RF Exposure Guidance v06
- FCC KDB 248227 D01 802.11 Wi-Fi SAR v02r02
- FCC KDB 941225 D05 SAR for LTE Devices v02r05

4. Equipment Under Test (EUT) Information

4.1 General Information

Product Feature & Specification	
Equipment Name	Smart watch
Brand Name	MONTBLANC
Model Name	S2C19
FCC ID	2AENP-S2C19
IMEI Code	359635100000819
Wireless Technology and Frequency Range	LTE Band 2: 1850.7 MHz ~ 1909.3 MHz LTE Band 4: 1710.7 MHz ~ 1754.3 MHz LTE Band 5: 824.7 MHz ~ 848.3 MHz LTE Band 7: 2502.5 MHz ~ 2567.5 MHz LTE Band 13: 779.5 MHz ~ 784.5 MHz WLAN 2.4GHz Band: 2412 MHz ~ 2462 MHz Bluetooth: 2402 MHz ~ 2480 MHz NFC : 13.56 MHz(Rx only)
Mode	LTE: QPSK, 16QAM WLAN 2.4GHz 802.11b/g/n HT20/HT40 Bluetooth BR/EDR/LE NFC:ASK
HW Version	LLDM820D1-3
SW Version	LLDQ6001
EUT Stage	Identical Prototype
Remark:	
1. This device supports voice function. 2. This device supports VoIP in LTE (e.g. for 3rd-party VoIP), LTE supports VoLTE operation. 3. There device has two type watch straps, they have no effect on SAR distribution, so only chose one strap to perform SAR testing.	



4.2 General LTE SAR Test and Reporting Considerations

Summarized necessary items addressed in KDB 941225 D05 v02r05																																																															
FCC ID	2AENP-S2C19																																																														
Equipment Name	Smart watch																																																														
Operating Frequency Range of each LTE transmission band	LTE Band 2: 1850.7 MHz ~ 1909.3 MHz LTE Band 4: 1710.7 MHz ~ 1754.3 MHz LTE Band 5: 824.7 MHz ~ 848.3 MHz LTE Band 7: 2502.5 MHz ~ 2567.5 MHz LTE Band 13: 779.5 MHz ~ 784.5 MHz																																																														
Channel Bandwidth	LTE Band 2: 1.4MHz, 3MHz, 5MHz, 10MHz, 15MHz, 20MHz LTE Band 4: 1.4MHz, 3MHz, 5MHz, 10MHz, 15MHz, 20MHz LTE Band 5: 1.4MHz, 3MHz, 5MHz, 10MHz LTE Band 7: 5MHz, 10MHz, 15MHz, 20MHz LTE Band 13: 5MHz, 10MHz																																																														
uplink modulations used	QPSK / 16QAM																																																														
LTE Voice / Data requirements	Voice and Data																																																														
LTE Release Version	R10, Cat1																																																														
LTE CA supported	No																																																														
LTE MPR permanently built-in by design	<p>Table 6.2.3-1: Maximum Power Reduction (MPR) for Power Class 1, 2 and 3</p> <table border="1"> <thead> <tr> <th rowspan="2">Modulation</th> <th colspan="6">Channel bandwidth / Transmission bandwidth (N_{RB})</th> <th rowspan="2">MPR (dB)</th> </tr> <tr> <th>1.4 MHz</th> <th>3.0 MHz</th> <th>5 MHz</th> <th>10 MHz</th> <th>15 MHz</th> <th>20 MHz</th> </tr> </thead> <tbody> <tr> <td>QPSK</td> <td>> 5</td> <td>> 4</td> <td>> 8</td> <td>> 12</td> <td>> 16</td> <td>> 18</td> <td>≤ 1</td> </tr> <tr> <td>16 QAM</td> <td>≤ 5</td> <td>≤ 4</td> <td>≤ 8</td> <td>≤ 12</td> <td>≤ 16</td> <td>≤ 18</td> <td>≤ 1</td> </tr> <tr> <td>16 QAM</td> <td>> 5</td> <td>> 4</td> <td>> 8</td> <td>> 12</td> <td>> 16</td> <td>> 18</td> <td>≤ 2</td> </tr> <tr> <td>64 QAM</td> <td>≤ 5</td> <td>≤ 4</td> <td>≤ 8</td> <td>≤ 12</td> <td>≤ 16</td> <td>≤ 18</td> <td>≤ 2</td> </tr> <tr> <td>64 QAM</td> <td>> 5</td> <td>> 4</td> <td>> 8</td> <td>> 12</td> <td>> 16</td> <td>> 18</td> <td>≤ 3</td> </tr> <tr> <td>256 QAM</td> <td colspan="6">≥ 1</td> <td>≤ 5</td> </tr> </tbody> </table>	Modulation	Channel bandwidth / Transmission bandwidth (N _{RB})						MPR (dB)	1.4 MHz	3.0 MHz	5 MHz	10 MHz	15 MHz	20 MHz	QPSK	> 5	> 4	> 8	> 12	> 16	> 18	≤ 1	16 QAM	≤ 5	≤ 4	≤ 8	≤ 12	≤ 16	≤ 18	≤ 1	16 QAM	> 5	> 4	> 8	> 12	> 16	> 18	≤ 2	64 QAM	≤ 5	≤ 4	≤ 8	≤ 12	≤ 16	≤ 18	≤ 2	64 QAM	> 5	> 4	> 8	> 12	> 16	> 18	≤ 3	256 QAM	≥ 1						≤ 5
Modulation	Channel bandwidth / Transmission bandwidth (N _{RB})						MPR (dB)																																																								
	1.4 MHz	3.0 MHz	5 MHz	10 MHz	15 MHz	20 MHz																																																									
QPSK	> 5	> 4	> 8	> 12	> 16	> 18	≤ 1																																																								
16 QAM	≤ 5	≤ 4	≤ 8	≤ 12	≤ 16	≤ 18	≤ 1																																																								
16 QAM	> 5	> 4	> 8	> 12	> 16	> 18	≤ 2																																																								
64 QAM	≤ 5	≤ 4	≤ 8	≤ 12	≤ 16	≤ 18	≤ 2																																																								
64 QAM	> 5	> 4	> 8	> 12	> 16	> 18	≤ 3																																																								
256 QAM	≥ 1						≤ 5																																																								
LTE A-MPR	In the base station simulator configuration, Network Setting value is set to NS_01 to disable A-MPR during SAR testing and the LTE SAR tests was transmitting on all TTI frames (Maximum TTI)																																																														
Spectrum plots for RB configuration	A properly configured base station simulator was used for the SAR and power measurement; therefore, spectrum plots for each RB allocation and offset configuration are not included in the SAR report.																																																														



Transmission (H, M, L) channel numbers and frequencies in each LTE band												
LTE Band 2												
	Bandwidth 1.4 MHz		Bandwidth 3 MHz		Bandwidth 5 MHz		Bandwidth 10 MHz		Bandwidth 15 MHz		Bandwidth 20 MHz	
	Ch. #	Freq. (MHz)	Ch. #	Freq. (MHz)	Ch. #	Freq. (MHz)	Ch. #	Freq. (MHz)	Ch. #	Freq. (MHz)	Ch. #	Freq. (MHz)
L	18607	1850.7	18615	1851.5	18625	1852.5	18650	1855	18675	1857.5	18700	1860
M	18900	1880	18900	1880	18900	1880	18900	1880	18900	1880	18900	1880
H	19193	1909.3	19185	1908.5	19175	1907.5	19150	1905	19125	1902.5	19100	1900
LTE Band 4												
	Bandwidth 1.4 MHz		Bandwidth 3 MHz		Bandwidth 5 MHz		Bandwidth 10 MHz		Bandwidth 15 MHz		Bandwidth 20 MHz	
	Ch. #	Freq. (MHz)	Ch. #	Freq. (MHz)	Ch. #	Freq. (MHz)	Ch. #	Freq. (MHz)	Ch. #	Freq. (MHz)	Ch. #	Freq. (MHz)
L	19957	1710.7	19965	1711.5	19975	1712.5	20000	1715	20025	1717.5	20050	1720
M	20175	1732.5	20175	1732.5	20175	1732.5	20175	1732.5	20175	1732.5	20175	1732.5
H	20393	1754.3	20385	1753.5	20375	1752.5	20350	1750	20325	1747.5	20300	1745
LTE Band 5												
	Bandwidth 1.4 MHz		Bandwidth 3 MHz		Bandwidth 5 MHz		Bandwidth 10 MHz					
	Ch. #	Freq. (MHz)	Ch. #	Freq. (MHz)	Ch. #	Freq. (MHz)	Ch. #	Freq. (MHz)	Ch. #	Freq. (MHz)	Ch. #	Freq. (MHz)
L	20407	824.7	20415	825.5	20425	826.5	20450	829				
M	20525	836.5	20525	836.5	20525	836.5	20525	836.5				
H	20643	848.3	20635	847.5	20625	846.5	20600	844				
LTE Band 7												
	Bandwidth 5 MHz		Bandwidth 10 MHz		Bandwidth 15 MHz		Bandwidth 20 MHz					
	Ch. #	Freq. (MHz)	Ch. #	Freq. (MHz)	Ch. #	Freq. (MHz)	Ch. #	Freq. (MHz)	Ch. #	Freq. (MHz)	Ch. #	Freq. (MHz)
L	20775	2502.5	20800	2505	20825	2507.5	20850	2510				
M	21100	2535	21100	2535	21100	2535	21100	2535				
H	21425	2567.5	21400	2565	21375	2562.5	21350	2560				
LTE Band 13												
	Bandwidth 5 MHz				Bandwidth 10 MHz							
	Channel #		Freq.(MHz)		Channel #		Freq.(MHz)					
L	23205		779.5		23230		782					
M	23230		782									
H	23255		784.5									



5. RF Exposure Limits

5.1 Uncontrolled Environment

Uncontrolled Environments are defined as locations where there is the exposure of individuals who have no knowledge or control of their exposure. The general population/uncontrolled exposure limits are applicable to situations in which the general public may be exposed or in which persons who are exposed as a consequence of their employment may not be made fully aware of the potential for exposure or cannot exercise control over their exposure. Members of the general public would come under this category when exposure is not employment-related; for example, in the case of a wireless transmitter that exposes persons in its vicinity.

5.2 Controlled Environment

Controlled Environments are defined as locations where there is exposure that may be incurred by persons who are aware of the potential for exposure, (i.e. as a result of employment or occupation). In general, occupational/controlled exposure limits are applicable to situations in which persons are exposed as a consequence of their employment, who have been made fully aware of the potential for exposure and can exercise control over their exposure. The exposure category is also applicable when the exposure is of a transient nature due to incidental passage through a location where the exposure levels may be higher than the general population/uncontrolled limits, but the exposed person is fully aware of the potential for exposure and can exercise control over his or her exposure by leaving the area or by some other appropriate means.

Limits for Occupational/Controlled Exposure (W/kg)

Table with 3 columns: Whole-Body, Partial-Body, Hands, Wrists, Feet and Ankles. Values: 0.4, 8.0, 20.0

Limits for General Population/Uncontrolled Exposure (W/kg)

Table with 3 columns: Whole-Body, Partial-Body, Hands, Wrists, Feet and Ankles. Values: 0.08, 1.6, 4.0

- 1. Whole-Body SAR is averaged over the entire body, partial-body SAR is averaged over any 1gram of tissue defined as a tissue volume in the shape of a cube. SAR for hands, wrists, feet and ankles is averaged over any 10 grams of tissue defined as a tissue volume in the shape of a cube.

6. Specific Absorption Rate (SAR)

6.1 Introduction

SAR is related to the rate at which energy is absorbed per unit mass in an object exposed to a radio field. The SAR distribution in a biological body is complicated and is usually carried out by experimental techniques or numerical modeling. The standard recommends limits for two tiers of groups, occupational/controlled and general population/uncontrolled, based on a person's awareness and ability to exercise control over his or her exposure. In general, occupational/controlled exposure limits are higher than the limits for general population/uncontrolled.

6.2 SAR Definition

The SAR definition is the time derivative (rate) of the incremental energy (dW) absorbed by (dissipated in) an incremental mass (dm) contained in a volume element (dv) of a given density (ρ). The equation description is as below:

$$\text{SAR} = \frac{d}{dt} \left(\frac{dW}{dm} \right) = \frac{d}{dt} \left(\frac{dW}{\rho dv} \right)$$

SAR is expressed in units of Watts per kilogram (W/kg)

$$\text{SAR} = \frac{\sigma |E|^2}{\rho}$$

Where: σ is the conductivity of the tissue, ρ is the mass density of the tissue and E is the RMS electrical field strength.

7. System Description and Setup

The DASY system used for performing compliance tests consists of the following items:

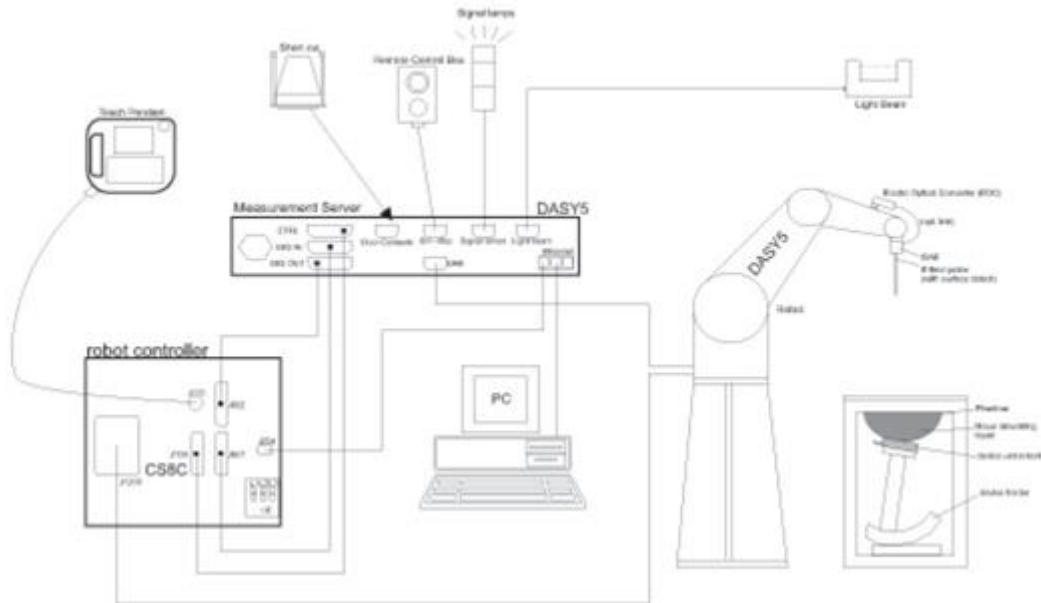

- A standard high precision 6-axis robot with controller, teach pendant and software. An arm extension for accommodating the data acquisition electronics (DAE).
- An isotropic Field probe optimized and calibrated for the targeted measurement.
- A data acquisition electronics (DAE) which performs the signal amplification, signal multiplexing, AD-conversion, offset measurements, mechanical surface detection, collision detection, etc. The unit is battery powered with standard or rechargeable batteries. The signal is optically transmitted to the EOC.
- The Electro-optical converter (EOC) performs the conversion from optical to electrical signals for the digital communication to the DAE. To use optical surface detection, a special version of the EOC is required. The EOC signal is transmitted to the measurement server.
- The function of the measurement server is to perform the time critical tasks such as signal filtering, control of the robot operation and fast movement interrupts.
- The Light Beam used is for probe alignment. This improves the (absolute) accuracy of the probe positioning.
- A computer running WinXP or Win7 and the DASY5 software.
- Remote control and teach pendant as well as additional circuitry for robot safety such as warning lamps, etc.
- The phantom, the device holder and other accessories according to the targeted measurement.

7.1 E-Field Probe

The SAR measurement is conducted with the dosimetric probe (manufactured by SPEAG).The probe is specially designed and calibrated for use in liquid with high permittivity. The dosimetric probe has special calibration in liquid at different frequency. This probe has a built in optical surface detection system to prevent from collision with phantom.

<ES3DV3 Probe>

Construction	Symmetric design with triangular core Interleaved sensors Built-in shielding against static charges PEEK enclosure material (resistant to organic solvents, e.g., DGBE)	
Frequency	10 MHz – 4 GHz; Linearity: ± 0.2 dB (30 MHz – 4 GHz)	
Directivity	± 0.2 dB in TSL (rotation around probe axis) ± 0.3 dB in TSL (rotation normal to probe axis)	
Dynamic Range	5 μ W/g – >100 mW/g; Linearity: ± 0.2 dB	
Dimensions	Overall length: 337 mm (tip: 20 mm) Tip diameter: 3.9 mm (body: 12 mm) Distance from probe tip to dipole centers: 3.0 mm	

7.2 Data Acquisition Electronics (DAE)

The data acquisition electronics (DAE) consists of a highly sensitive electrometer-grade preamplifier with auto-zeroing, a channel and gain-switching multiplexer, a fast 16 bit AD-converter and a command decoder and control logic unit. Transmission to the measurement server is accomplished through an optical downlink for data and status information as well as an optical uplink for commands and the clock.

The input impedance of the DAE is 200 MOhm; the inputs are symmetrical and floating. Common mode rejection is above 80 dB.



Fig 5.1 Photo of DAE

7.3 Phantom

<SAM Twin Phantom>

Shell Thickness	2 ± 0.2 mm; Center ear point: 6 ± 0.2 mm
Filling Volume	Approx. 25 liters
Dimensions	Length: 1000 mm; Width: 500 mm; Height: adjustable feet
Measurement Areas	Left Hand, Right Hand, Flat Phantom



The bottom plate contains three pair of bolts for locking the device holder. The device holder positions are adjusted to the standard measurement positions in the three sections. A white cover is provided to tap the phantom during off-periods to prevent water evaporation and changes in the liquid parameters. On the phantom top, three reference markers are provided to identify the phantom position with respect to the robot.

<ELI Phantom>

Shell Thickness	2 ± 0.2 mm (sagging: <1%)
Filling Volume	Approx. 30 liters
Dimensions	Major ellipse axis: 600 mm Minor axis: 400 mm

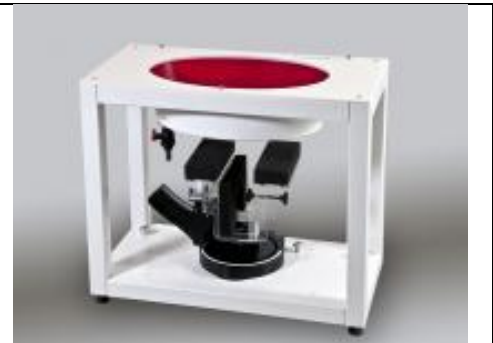

The ELI phantom is intended for compliance testing of handheld and body-mounted wireless devices in the frequency range of 30 MHz to 6 GHz. ELI4 is fully compatible with standard and all known tissue simulating liquids.

7.4 Device Holder

<Mounting Device for Hand-Held Transmitter>

In combination with the Twin SAM V5.0/V5.0c or ELI phantoms, the Mounting Device for Hand-Held Transmitters enables rotation of the mounted transmitter device to specified spherical coordinates. At the heads, the rotation axis is at the ear opening. Transmitter devices can be easily and accurately positioned according to IEC 62209-1, IEEE 1528, FCC, or other specifications. The device holder can be locked for positioning at different phantom sections (left head, right head, flat). And upgrade kit to Mounting Device to enable easy mounting of wider devices like big smart-phones, e-books, small tablets, etc. It holds devices with width up to 140 mm.



Mounting Device for Hand-Held Transmitters



Mounting Device Adaptor for Wide-Phones

<Mounting Device for Laptops and other Body-Worn Transmitters>

The extension is lightweight and made of POM, acrylic glass and foam. It fits easily on the upper part of the mounting device in place of the phone positioned. The extension is fully compatible with the SAM Twin and ELI phantoms.



Mounting Device for Laptops

8. Measurement Procedures

The measurement procedures are as follows:

<Conducted power measurement>

- (a) For WWAN power measurement, use base station simulator to configure EUT WWAN transmission in conducted connection with RF cable, at maximum power in each supported wireless interface and frequency band.
- (b) Read the WWAN RF power level from the base station simulator.
- (c) For WLAN/BT power measurement, use engineering software to configure EUT WLAN/BT continuously transmission, at maximum RF power in each supported wireless interface and frequency band
- (d) Connect EUT RF port through RF cable to the power meter, and measure WLAN/BT output power

<SAR measurement>

- (a) Use base station simulator to configure EUT WWAN transmission in radiated connection, and engineering software to configure EUT WLAN/BT continuously transmission, at maximum RF power, in the highest power channel.
- (b) Place the EUT in the positions as Appendix D demonstrates.
- (c) Set scan area, grid size and other setting on the DASY software.
- (d) Measure SAR results for the highest power channel on each testing position.
- (e) Find out the largest SAR result on these testing positions of each band
- (f) Measure SAR results for other channels in worst SAR testing position if the reported SAR of highest power channel is larger than 0.8 W/kg

According to the test standard, the recommended procedure for assessing the peak spatial-average SAR value consists of the following steps:

- (a) Power reference measurement
- (b) Area scan
- (c) Zoom scan
- (d) Power drift measurement

8.1 Spatial Peak SAR Evaluation

The procedure for spatial peak SAR evaluation has been implemented according to the test standard. It can be conducted for 1g and 10g, as well as for user-specific masses. The DASY software includes all numerical procedures necessary to evaluate the spatial peak SAR value.

The base for the evaluation is a "cube" measurement. The measured volume must include the 1g and 10g cubes with the highest averaged SAR values. For that purpose, the center of the measured volume is aligned to the interpolated peak SAR value of a previously performed area scan.

The entire evaluation of the spatial peak values is performed within the post-processing engine (SEMCAD). The system always gives the maximum values for the 1g and 10g cubes. The algorithm to find the cube with highest averaged SAR is divided into the following stages:

- (a) Extraction of the measured data (grid and values) from the Zoom Scan
- (b) Calculation of the SAR value at every measurement point based on all stored data (A/D values and measurement parameters)
- (c) Generation of a high-resolution mesh within the measured volume
- (d) Interpolation of all measured values from the measurement grid to the high-resolution grid
- (e) Extrapolation of the entire 3-D field distribution to the phantom surface over the distance from sensor to surface
- (f) Calculation of the averaged SAR within masses of 1g and 10g

8.2 Power Reference Measurement

The Power Reference Measurement and Power Drift Measurements are for monitoring the power drift of the device under test in the batch process. The minimum distance of probe sensors to surface determines the closest measurement point to phantom surface. This distance cannot be smaller than the distance of sensor calibration points to probe tip as defined in the probe properties.

8.3 Area Scan

The area scan is used as a fast scan in two dimensions to find the area of high field values, before doing a fine measurement around the hot spot. The sophisticated interpolation routines implemented in DASY software can find the maximum found in the scanned area, within a range of the global maximum. The range (in dB0 is specified in the standards for compliance testing. For example, a 2 dB range is required in IEEE standard 1528 and IEC 62209 standards, whereby 3 dB is a requirement when compliance is assessed in accordance with the ARIB standard (Japan), if only one zoom scan follows the area scan, then only the absolute maximum will be taken as reference. For cases where multiple maximums are detected, the number of zoom scans has to be increased accordingly.

Area scan parameters extracted from FCC KDB 865664 D01v01r04 SAR measurement 100 MHz to 6 GHz.

	≤ 3 GHz	> 3 GHz
Maximum distance from closest measurement point (geometric center of probe sensors) to phantom surface	5 ± 1 mm	$\frac{1}{2} \cdot \delta \cdot \ln(2) \pm 0.5$ mm
Maximum probe angle from probe axis to phantom surface normal at the measurement location	30° ± 1°	20° ± 1°
Maximum area scan spatial resolution: Δx_{Area} , Δy_{Area}	≤ 2 GHz: ≤ 15 mm 2 – 3 GHz: ≤ 12 mm	3 – 4 GHz: ≤ 12 mm 4 – 6 GHz: ≤ 10 mm
	When the x or y dimension of the test device, in the measurement plane orientation, is smaller than the above, the measurement resolution must be ≤ the corresponding x or y dimension of the test device with at least one measurement point on the test device.	

8.4 Zoom Scan

Zoom scans are used assess the peak spatial SAR values within a cubic averaging volume containing 1 gram and 10 gram of simulated tissue. The zoom scan measures points (refer to table below) within a cube shoes base faces are centered on the maxima found in a preceding area scan job within the same procedure. When the measurement is done, the zoom scan evaluates the averaged SAR for 1 gram and 10 gram and displays these values next to the job's label.

Zoom scan parameters extracted from FCC KDB 865664 D01v01r04 SAR measurement 100 MHz to 6 GHz.

		≤ 3 GHz	> 3 GHz	
Maximum zoom scan spatial resolution: $\Delta x_{Zoom}, \Delta y_{Zoom}$		≤ 2 GHz: ≤ 8 mm 2 – 3 GHz: ≤ 5 mm*	3 – 4 GHz: ≤ 5 mm* 4 – 6 GHz: ≤ 4 mm*	
Maximum zoom scan spatial resolution, normal to phantom surface	uniform grid: $\Delta z_{Zoom}(n)$	≤ 5 mm	3 – 4 GHz: ≤ 4 mm 4 – 5 GHz: ≤ 3 mm 5 – 6 GHz: ≤ 2 mm	
	graded grid	$\Delta z_{Zoom}(1)$: between 1 st two points closest to phantom surface	≤ 4 mm	3 – 4 GHz: ≤ 3 mm 4 – 5 GHz: ≤ 2.5 mm 5 – 6 GHz: ≤ 2 mm
		$\Delta z_{Zoom}(n>1)$: between subsequent points	$\leq 1.5 \cdot \Delta z_{Zoom}(n-1)$	
Minimum zoom scan volume	x, y, z	≥ 30 mm	3 – 4 GHz: ≥ 28 mm 4 – 5 GHz: ≥ 25 mm 5 – 6 GHz: ≥ 22 mm	
Note: δ is the penetration depth of a plane-wave at normal incidence to the tissue medium; see draft standard IEEE P1528-2011 for details. * When zoom scan is required and the <i>reported</i> SAR from the <i>area scan based 1-g SAR estimation</i> procedures of KDB 447498 is ≤ 1.4 W/kg, ≤ 8 mm, ≤ 7 mm and ≤ 5 mm zoom scan resolution may be applied, respectively, for 2 GHz to 3 GHz, 3 GHz to 4 GHz and 4 GHz to 6 GHz.				

8.5 Volume Scan Procedures

The volume scan is used for assess overlapping SAR distributions for antennas transmitting in different frequency bands. It is equivalent to an oversized zoom scan used in standalone measurements. The measurement volume will be used to enclose all the simultaneous transmitting antennas. For antennas transmitting simultaneously in different frequency bands, the volume scan is measured separately in each frequency band. In order to sum correctly to compute the 1g aggregate SAR, the EUT remain in the same test position for all measurements and all volume scan use the same spatial resolution and grid spacing. When all volume scan were completed, the software, SEMCAD postprocessor can combine and subsequently superpose these measurement data to calculating the multiband SAR.

8.6 Power Drift Monitoring

All SAR testing is under the EUT install full charged battery and transmit maximum output power. In DASy measurement software, the power reference measurement and power drift measurement procedures are used for monitoring the power drift of EUT during SAR test. Both these procedures measure the field at a specified reference position before and after the SAR testing. The software will calculate the field difference in dB. If the power drifts more than 5%, the SAR will be retested.



9. Test Equipment List

Manufacturer	Name of Equipment	Type/Model	Serial Number	Calibration	
				Last Cal.	Due Date
SPEAG	750MHz System Validation Kit	D750V3	1087	2019/3/27	2020/3/26
SPEAG	835MHz System Validation Kit	D835V2	4d151	2019/3/27	2020/3/26
SPEAG	1750MHz System Validation Kit	D1750V2	1090	2019/3/27	2020/3/26
SPEAG	1900MHz System Validation Kit	D1900V2	5d170	2019/3/26	2020/3/25
SPEAG	2450MHz System Validation Kit	D2450V2	908	2019/3/25	2020/3/24
SPEAG	2600MHz System Validation Kit	D2600V2	1061	2018/12/7	2019/12/6
SPEAG	Data Acquisition Electronics	DAE4	1279	2018/10/22	2019/10/21
SPEAG	Dosimetric E-Field Probe	ES3DV3	3279	2019/3/4	2020/3/3
SPEAG	SAM Twin Phantom	QD 000 P40 CB	TP-1697	NCR	NCR
SPEAG	Phone Positioner	N/A	N/A	NCR	NCR
Anritsu	Radio Communication Analyzer	MT8821C	6201432831	2019/4/17	2020/4/16
Agilent	Wireless Communication Test Set	E5515C	MY52102706	2019/4/17	2020/4/16
Agilent	ENA Series Network Analyzer	E5071C	MY46111157	2019/4/17	2020/4/16
SPEAG	Dielectric Probe Kit	DAK-3.5	1138	2018/11/20	2019/11/19
Anritsu	Vector Signal Generator	MG3710A	6201682672	2019/1/14	2020/1/13
Rohde & Schwarz	Power Meter	NRVD	102081	2019/8/19	2020/8/18
Rohde & Schwarz	Power Sensor	NRV-Z5	100538	2019/8/19	2020/8/18
Rohde & Schwarz	Power Sensor	NRV-Z5	100539	2019/8/19	2020/8/18
R&S	CBT BLUETOOTH TESTER	CBT	101641	2019/1/14	2020/1/13
EXA	Spectrum Analyzer	FSV7	101631	2019/1/14	2020/1/13
Testo	Hygrometer	608-H1	1241332126	2019/8/20	2020/8/19
FLUKE	DIGITAC THERMOMETER	51II	97240029	2019/8/7	2020/8/6
BONN	POWER AMPLIFIER	BLMA 0830-3	087193A	Note	
BONN	POWER AMPLIFIER	BLMA 2060-2	087193B	Note	
ARRA	Power Divider	A3200-2	N/A	Note	
MCL	Attenuation1	BW-S10W5+	N/A	Note	
MCL	Attenuation2	BW-S10W5+	N/A	Note	
MCL	Attenuation3	BW-S10W5+	N/A	Note	
Agilent	Dual Directional Coupler	778D	20500	Note	
Agilent	Dual Directional Coupler	11691D	MY48151020	Note	

Note:

Prior to system verification and validation, the path loss from the signal generator to the system check source and the power meter, which includes the amplifier, cable, attenuator and directional coupler, was measured by the network analyzer. The reading of the power meter was offset by the path loss difference between the path to the power meter and the path to the system check source to monitor the actual power level fed to the system check source.

10. System Verification

10.1 Tissue Simulating Liquids

For the measurement of the field distribution inside the SAM phantom with DASY, the phantom must be filled with around 25 liters of homogeneous body tissue simulating liquid. For head SAR testing, the liquid height from the ear reference point (ERP) of the phantom to the liquid top surface is larger than 15 cm, which is shown in Fig. 10.1. For body SAR testing, the liquid height from the center of the flat phantom to the liquid top surface is larger than 15 cm, which is shown in Fig. 10.2.

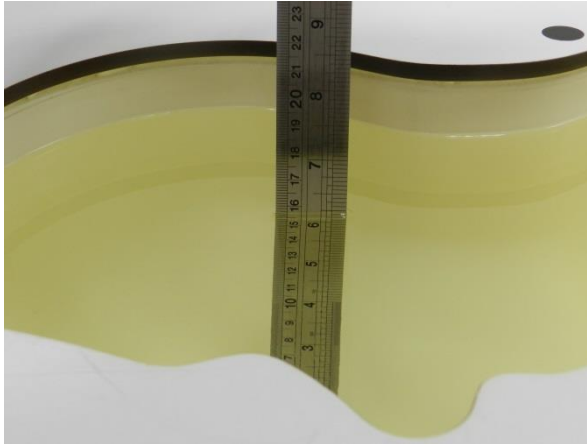

Fig 10.1 Photo of Liquid Height for Head SAR

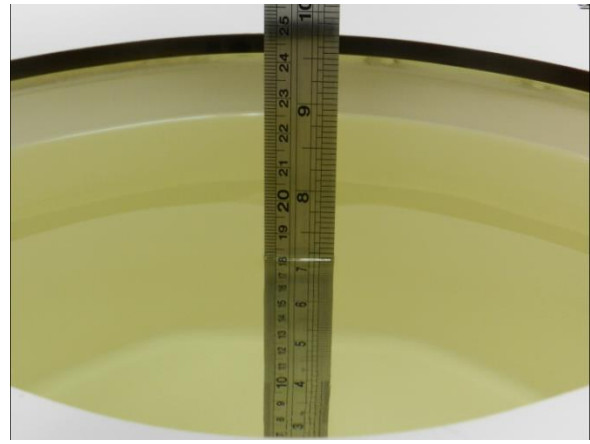

Fig 10.2 Photo of Liquid Height for Body SAR

10.2 Tissue Verification

The following tissue formulations are provided for reference only as some of the parameters have not been thoroughly verified. The composition of ingredients may be modified accordingly to achieve the desired target tissue parameters required for routine SAR evaluation.

Frequency (MHz)	Water (%)	Sugar (%)	Cellulose (%)	Salt (%)	Preventol (%)	DGBE (%)	Conductivity (σ)	Permittivity (ε _r)
For Head								
835	40.3	57.9	0.2	1.4	0.2	0	0.90	41.5
1800, 1900, 2000	55.2	0	0	0.3	0	44.5	1.40	40.0
2450	55.0	0	0	0	0	45.0	1.80	39.2
2600	54.8	0	0	0.1	0	45.1	1.96	39.0

<Tissue Dielectric Parameter Check Results>

Frequency (MHz)	Tissue Type	Liquid Temp. (°C)	Conductivity (σ)	Permittivity (ε _r)	Conductivity Target (σ)	Permittivity Target (ε _r)	Delta (σ) (%)	Delta (ε _r) (%)	Limit (%)	Date
750	Head	22.7	0.879	43.090	0.89	41.90	-1.24	2.84	±5	2019/8/25
835	Head	22.7	0.914	41.643	0.90	41.50	1.56	0.34	±5	2019/8/25
1750	Head	22.6	1.326	41.821	1.37	40.10	-3.21	4.29	±5	2019/9/1
1900	Head	22.8	1.423	38.836	1.40	40.00	1.64	-2.91	±5	2019/9/1
2450	Head	22.7	1.869	38.891	1.80	39.20	3.83	-0.79	±5	2019/9/3
2600	Head	22.7	2.049	38.257	1.96	39.00	4.54	-1.91	±5	2019/9/3

10.3 System Performance Check Results

Comparing to the original SAR value provided by SPEAG, the verification data should be within its specification of 10 %. Below table shows the target SAR and measured SAR after normalized to 1W input power. The table below indicates the system performance check can meet the variation criterion and the plots can be referred to Appendix A of this report.

<1g SAR>

Date	Frequency (MHz)	Tissue Type	Input Power (mW)	Dipole S/N	Probe S/N	DAE S/N	Measured 1g SAR (W/kg)	Targeted 1g SAR (W/kg)	Normalized 1g SAR (W/kg)	Deviation (%)
2019/8/25	750	Head	250	1087	3279	1279	2.09	8.36	8.36	0.00
2019/8/25	835	Head	250	4d151	3279	1279	2.43	9.30	9.72	4.52
2019/9/1	1750	Head	250	1090	3279	1279	8.77	36.40	35.08	-3.63
2019/9/1	1900	Head	250	5d170	3279	1279	9.70	39.00	38.8	-0.51
2019/9/3	2450	Head	250	908	3279	1279	13.40	52.80	53.6	1.52
2019/9/3	2600	Head	250	1061	3279	1279	14.10	57.70	56.4	-2.25

<10g SAR>

Date	Frequency (MHz)	Tissue Type	Input Power (mW)	Dipole S/N	Probe S/N	DAE S/N	Measured 10g SAR (W/kg)	Targeted 10g SAR (W/kg)	Normalized 10g SAR (W/kg)	Deviation (%)
2019/8/25	750	Head	250	1087	3279	1279	1.39	5.65	5.56	-1.59
2019/8/25	835	Head	250	4d151	3279	1279	1.59	6.16	6.36	3.25
2019/9/1	1750	Head	250	1090	3279	1279	4.66	19.20	18.64	-2.92
2019/9/1	1900	Head	250	5d170	3279	1279	4.96	20.30	19.84	-2.27
2019/9/3	2450	Head	250	908	3279	1279	6.41	24.20	25.64	5.95
2019/9/3	2600	Head	250	1061	3279	1279	6.06	25.90	24.24	-6.41

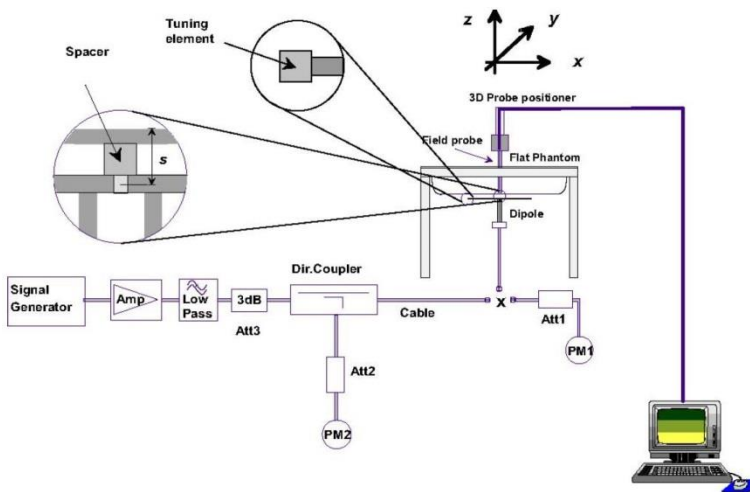

Fig 8.3.1 System Performance Check Setup



Fig 8.3.2 Setup Photo

11. RF Exposure Positions

11.1 Limb-Worn Accessory

A limb-worn device is a unit whose intended use includes being strapped to the arm of the user while transmitting. The strap shall be opened so that it is divided into two parts as following picture. The device shall be positioned directly against the phantom surface with the strap straightened as much as possible and the back of the device towards the phantom. If the strap cannot normally be opened to allow placing in direct contact with the phantom surface, it may be necessary to break the strap of the device but ensuring to not damage the antenna.

The device can use speak to Mouth mode, So this SAR test should be evaluated too. Adjust the distance between the device surface and the flat phantom to 10mm.

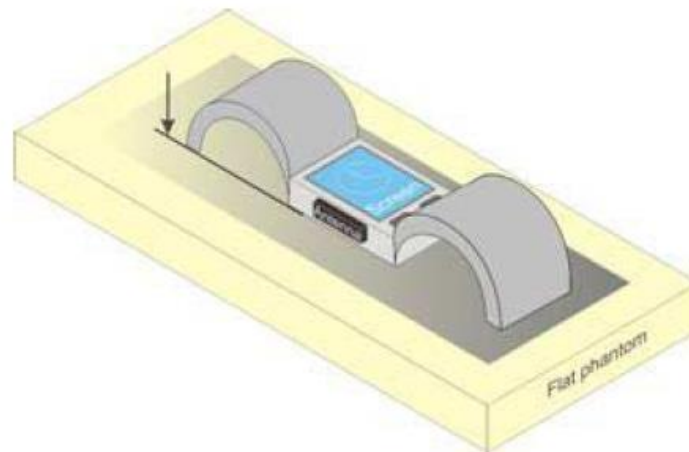



12. Conducted RF Output Power (Unit: dBm)

<LTE Conducted Power>

General Note:

1. Anritsu MT8820C base station simulator was used to setup the connection with EUT; the frequency band, channel bandwidth, RB allocation configuration, modulation type are set in the base station simulator to configure EUT transmitting at maximum power and at different configurations which are requested to be reported to FCC, for conducted power measurement and SAR testing.
2. Per KDB 941225 D05v02r05, when a properly configured base station simulator is used for the SAR and power measurements, spectrum plots for each RB allocation and offset configuration is not required.
3. Per KDB 941225 D05v02r05, start with the largest channel bandwidth and measure SAR for QPSK with 1 RB allocation, using the RB offset and required test channel combination with the highest maximum output power for RB offsets at the upper edge, middle and lower edge of each required test channel.
4. Per KDB 941225 D05v02r05, 50% RB allocation for QPSK SAR testing follows 1RB QPSK allocation procedure.
5. Per KDB 941225 D05v02r05, for QPSK with 100% RB allocation, SAR is not required when the highest maximum output power for 100 % RB allocation is less than the highest maximum output power in 50% and 1 RB allocations and the highest reported SAR for 1 RB and 50% RB allocation are ≤ 0.8 W/kg. Otherwise, SAR is measured for the highest output power channel; and if the reported SAR is > 1.45 W/kg, the remaining required test channels must also be tested.
6. Per KDB 941225 D05v02r05, 16QAM/64QAM output power for each RB allocation configuration is $>$ not $\frac{1}{2}$ dB higher than the same configuration in QPSK and the reported SAR for the QPSK configuration is ≤ 1.45 W/kg; Per KDB 941225 D05v02r05, 16QAM/64QAM SAR testing is not required.
7. Per KDB 941225 D05v02r05, smaller bandwidth output power for each RB allocation configuration is $>$ not $\frac{1}{2}$ dB higher than the same configuration in the largest supported bandwidth, and the reported SAR for the largest supported bandwidth is ≤ 1.45 W/kg; Per KDB 941225 D05v02r05, smaller bandwidth SAR testing is not required.
8. For LTE B4 / B5 the maximum bandwidth does not support three non-overlapping channels, per KDB 941225 D05v02r05, when a device supports overlapping channel assignment in a channel bandwidth configuration, the middle channel of the group of overlapping channels should be selected for testing.



<LTE Band 2>

BW [MHz]	Modulation	RB Size	RB Offset	Power Low Ch. / Freq.	Power Middle Ch. / Freq.	Power High Ch. / Freq.	Tune-up limit (dBm)	MPR (dB)
Channel				18700	18900	19100		
Frequency (MHz)				1860	1880	1900		
20	QPSK	1	0	22.87	22.68	23.14	24	0
20	QPSK	1	49	22.78	22.95	22.93		
20	QPSK	1	99	22.76	22.74	22.94		
20	QPSK	50	0	21.54	21.88	21.99	23	1
20	QPSK	50	24	21.50	21.66	21.75		
20	QPSK	50	50	21.52	21.88	21.95		
20	QPSK	100	0	21.40	21.59	21.69	23	1
20	16QAM	1	0	21.70	21.43	21.65		
20	16QAM	1	49	21.23	21.25	21.62		
20	16QAM	1	99	21.31	21.20	21.50	23	1
20	16QAM	12	0	21.47	21.35	21.59		
20	16QAM	12	44	21.44	21.64	21.54		
20	16QAM	12	88	21.41	21.49	21.71	22	2
20	16QAM	27	0	20.67	20.80	20.80		
Channel				18675	18900	19125		
Frequency (MHz)				1857.5	1880	1902.5		
15	QPSK	1	0	22.80	22.98	22.75		
15	QPSK	1	37	22.63	23.06	23.13	24	0
15	QPSK	1	74	22.64	22.75	22.91		
15	QPSK	36	0	21.96	21.79	21.96		
15	QPSK	36	20	21.61	21.95	21.97	23	1
15	QPSK	36	39	21.79	21.85	21.87		
15	QPSK	75	0	21.62	21.75	21.76		
15	16QAM	1	0	21.74	21.56	21.76	23	1
15	16QAM	1	37	21.80	21.90	21.45		
15	16QAM	1	74	21.95	21.48	21.77		
15	16QAM	12	0	21.42	21.52	21.43	23	1
15	16QAM	12	31	21.51	21.43	21.40		
15	16QAM	12	63	21.56	21.53	21.38		
15	16QAM	27	0	20.81	20.90	20.92	22	2



Channel				18650	18900	19150	Tune-up limit (dBm)	MPR (dB)
Frequency (MHz)				1855	1880	1905		
10	QPSK	1	0	22.98	22.91	23.03	24	0
10	QPSK	1	25	22.72	22.92	22.91		
10	QPSK	1	49	22.87	22.80	23.06		
10	QPSK	25	0	21.91	22.02	22.13	23	1
10	QPSK	25	12	21.83	21.98	22.10		
10	QPSK	25	25	21.84	22.01	22.20		
10	QPSK	50	0	21.87	22.01	22.25	23	1
10	16QAM	1	0	21.74	21.70	21.93		
10	16QAM	1	25	22.00	22.12	22.09		
10	16QAM	1	49	21.77	21.67	21.78	23	1
10	16QAM	12	0	21.56	21.47	21.54		
10	16QAM	12	19	21.47	21.56	21.38		
10	16QAM	12	38	21.37	21.36	21.56	22	2
10	16QAM	27	0	20.70	20.83	21.02		
Channel				18625	18900	19175	Tune-up limit (dBm)	MPR (dB)
Frequency (MHz)				1852.5	1880	1907.5		
5	QPSK	1	0	22.73	22.43	22.64	24	0
5	QPSK	1	12	22.90	22.60	22.92		
5	QPSK	1	24	22.46	22.48	22.78		
5	QPSK	12	0	21.59	21.51	21.73	23	1
5	QPSK	12	7	21.65	21.54	21.82		
5	QPSK	12	13	21.50	21.62	21.88		
5	QPSK	25	0	21.55	21.50	21.71	23	1
5	16QAM	1	0	21.14	21.17	21.20		
5	16QAM	1	12	21.55	21.43	21.63		
5	16QAM	1	24	21.45	21.58	21.58	22	2
5	16QAM	12	0	20.61	20.52	20.57		
5	16QAM	12	7	20.77	20.56	20.67		
5	16QAM	12	13	20.59	20.53	20.72	22	2
5	16QAM	25	0	20.66	20.51	20.76		



Channel				18615	18900	19185	Tune-up limit (dBm)	MPR (dB)
Frequency (MHz)				1851.5	1880	1908.5		
3	QPSK	1	0	22.62	22.49	22.85	24	0
3	QPSK	1	8	22.89	22.66	22.82		
3	QPSK	1	14	22.66	22.54	22.70		
3	QPSK	8	0	21.62	21.57	21.87	23	1
3	QPSK	8	4	21.74	21.67	21.86		
3	QPSK	8	7	21.77	21.69	21.79		
3	QPSK	15	0	21.65	21.60	21.90	23	1
3	16QAM	1	0	21.71	21.68	21.45		
3	16QAM	1	8	21.85	21.74	21.75		
3	16QAM	1	14	21.72	21.76	21.44	22	2
3	16QAM	8	0	20.70	20.74	21.06		
3	16QAM	8	4	20.83	20.84	21.02		
3	16QAM	8	7	20.78	20.85	20.79	22	2
3	16QAM	15	0	20.95	20.62	20.98		
Channel				18607	18900	19193	Tune-up limit (dBm)	MPR (dB)
Frequency (MHz)				1850.7	1880	1909.3		
1.4	QPSK	1	0	22.62	22.62	23.01	24	0
1.4	QPSK	1	3	22.81	22.66	23.02		
1.4	QPSK	1	5	22.66	22.62	22.93		
1.4	QPSK	3	0	22.68	22.73	22.99		
1.4	QPSK	3	1	22.79	22.79	23.09		
1.4	QPSK	3	3	22.71	22.78	22.95	23	1
1.4	QPSK	6	0	21.67	21.66	21.91		
1.4	16QAM	1	0	21.69	21.54	21.78	23	1
1.4	16QAM	1	3	21.78	21.38	21.45		
1.4	16QAM	1	5	21.75	21.51	21.64		
1.4	16QAM	3	0	21.71	21.61	21.55		
1.4	16QAM	3	1	21.63	21.95	21.48		
1.4	16QAM	3	3	21.58	21.95	21.80	22	2
1.4	16QAM	6	0	20.57	20.72	20.72		



<LTE Band 4>

BW [MHz]	Modulation	RB Size	RB Offset	Power Low Ch. / Freq.	Power Middle Ch. / Freq.	Power High Ch. / Freq.	Tune-up limit (dBm)	MPR (dB)
Channel				20050	20175	20300		
Frequency (MHz)				1720	1732.5	1745		
20	QPSK	1	0	22.91	23.12	23.20	24	0
20	QPSK	1	49	22.74	23.23	23.16		
20	QPSK	1	99	22.84	23.11	23.02		
20	QPSK	50	0	21.88	22.22	22.27	23	1
20	QPSK	50	24	21.78	22.28	22.03		
20	QPSK	50	50	21.83	22.14	22.00		
20	16QAM	1	0	22.14	21.86	21.98	23	1
20	16QAM	1	49	21.78	22.24	21.97		
20	16QAM	1	99	21.92	22.09	21.91		
20	16QAM	12	0	21.67	21.72	21.93	23	1
20	16QAM	12	44	21.47	21.75	21.80		
20	16QAM	12	88	21.64	21.79	21.77		
20	16QAM	27	0	20.95	20.89	21.37	22	2
Channel				20025	20175	20325	Tune-up limit (dBm)	MPR (dB)
Frequency (MHz)				1717.5	1732.5	1747.5		
15	QPSK	1	0	23.04	22.89	23.05		
15	QPSK	1	37	22.67	22.95	23.11		
15	QPSK	1	74	22.79	23.01	23.09		
15	QPSK	36	0	21.88	22.12	22.05	23	1
15	QPSK	36	20	21.75	22.14	21.98		
15	QPSK	36	39	21.70	22.18	22.08		
15	QPSK	75	0	21.88	22.13	22.14	23	1
15	16QAM	1	0	22.03	21.71	21.99		
15	16QAM	1	37	21.68	22.00	22.01		
15	16QAM	1	74	21.75	21.76	22.12	23	1
15	16QAM	12	0	21.48	21.74	21.95		
15	16QAM	12	31	21.46	21.83	21.73		
15	16QAM	12	63	21.64	21.96	21.81	23	1
15	16QAM	12	63	21.64	21.96	21.81		
15	16QAM	27	0	20.95	21.08	21.14	22	2



Channel				20000	20175	20350	Tune-up limit (dBm)	MPR (dB)
Frequency (MHz)				1715	1732.5	1750		
10	QPSK	1	0	22.96	23.05	23.00	24	0
10	QPSK	1	25	22.64	22.91	22.90		
10	QPSK	1	49	22.74	22.94	22.98		
10	QPSK	25	0	21.85	22.09	22.00	23	1
10	QPSK	25	12	21.83	22.17	22.08		
10	QPSK	25	25	21.75	22.09	22.05		
10	QPSK	50	0	21.85	22.06	22.04	23	1
10	16QAM	1	0	21.52	21.95	21.78		
10	16QAM	1	25	21.65	22.02	21.76		
10	16QAM	1	49	21.55	21.95	21.84	23	1
10	16QAM	12	0	21.54	21.87	21.83		
10	16QAM	12	19	21.71	21.74	21.77		
10	16QAM	12	38	21.37	21.87	21.76	22	2
10	16QAM	27	0	21.09	21.12	21.09		
Channel				19975	20175	20375	Tune-up limit (dBm)	MPR (dB)
Frequency (MHz)				1712.5	1732.5	1752.5		
5	QPSK	1	0	22.70	23.05	22.82	24	0
5	QPSK	1	12	22.80	22.96	22.81		
5	QPSK	1	24	22.64	22.94	22.94		
5	QPSK	12	0	21.67	22.03	21.76	23	1
5	QPSK	12	7	21.60	21.97	21.91		
5	QPSK	12	13	21.59	21.88	21.96		
5	QPSK	25	0	21.70	22.07	21.83	23	1
5	16QAM	1	0	21.38	21.56	21.58		
5	16QAM	1	12	21.45	21.56	21.76		
5	16QAM	1	24	21.42	21.73	21.87	22	2
5	16QAM	12	0	20.70	20.84	20.69		
5	16QAM	12	7	20.56	20.94	20.77		
5	16QAM	12	13	20.47	20.75	20.92	22	2
5	16QAM	25	0	20.82	20.90	20.87		



Channel				19965	20175	20385	Tune-up limit (dBm)	MPR (dB)
Frequency (MHz)				1711.5	1732.5	1753.5		
3	QPSK	1	0	22.70	23.05	22.90	24	0
3	QPSK	1	8	22.85	23.00	22.85		
3	QPSK	1	14	22.60	22.57	23.06		
3	QPSK	8	0	21.66	21.82	21.79	23	1
3	QPSK	8	4	21.62	21.95	21.89		
3	QPSK	8	7	21.67	21.96	21.85		
3	QPSK	15	0	21.55	21.93	21.86	23	1
3	16QAM	1	0	21.18	21.41	21.31		
3	16QAM	1	8	21.31	21.61	21.62		
3	16QAM	1	14	21.12	21.13	21.60	22	2
3	16QAM	8	0	20.60	20.99	20.88		
3	16QAM	8	4	20.67	20.86	20.97		
3	16QAM	8	7	20.64	21.04	20.85	22	2
3	16QAM	15	0	20.61	20.90	20.85		
Channel				19957	20175	20393	Tune-up limit (dBm)	MPR (dB)
Frequency (MHz)				1710.7	1732.5	1754.3		
1.4	QPSK	1	0	22.96	23.06	23.10	24	0
1.4	QPSK	1	3	22.83	23.03	23.21		
1.4	QPSK	1	5	22.79	22.97	23.06		
1.4	QPSK	3	0	23.02	23.09	23.16		
1.4	QPSK	3	1	23.10	23.10	23.19		
1.4	QPSK	3	3	22.83	23.09	23.13	23	1
1.4	QPSK	6	0	21.90	22.19	22.16		
1.4	16QAM	1	0	21.53	21.86	21.81	23	1
1.4	16QAM	1	3	21.72	21.84	21.92		
1.4	16QAM	1	5	21.67	21.64	21.75		
1.4	16QAM	3	0	21.72	22.16	22.06		
1.4	16QAM	3	1	21.80	22.15	22.09		
1.4	16QAM	3	3	21.78	22.07	22.06	22	2
1.4	16QAM	6	0	20.85	21.06	21.02		



<LTE Band 5>

BW [MHz]	Modulation	RB Size	RB Offset	Power Low Ch. / Freq.	Power Middle Ch. / Freq.	Power High Ch. / Freq.	Tune-up limit (dBm)	MPR (dB)
Channel				20450	20525	20600		
Frequency (MHz)				829	836.5	844		
10	QPSK	1	0	22.80	22.96	22.82	24	0
10	QPSK	1	25	22.79	23.06	23.08		
10	QPSK	1	49	22.77	22.95	22.85		
10	QPSK	25	0	21.87	21.91	21.99	23	1
10	QPSK	25	12	21.89	21.92	21.88		
10	QPSK	25	25	22.01	21.93	21.95		
10	QPSK	50	0	21.93	21.83	21.99	23	1
10	16QAM	1	0	21.93	21.50	21.47		
10	16QAM	1	25	21.97	21.56	21.85		
10	16QAM	1	49	21.78	21.48	21.87	23	1
10	16QAM	12	0	21.95	21.96	21.73		
10	16QAM	12	19	21.83	21.60	21.82		
10	16QAM	12	38	21.82	21.85	21.70	23	1
10	16QAM	12	38	21.82	21.85	21.70		
10	16QAM	27	0	20.78	20.78	20.78		
Channel				20425	20525	20625	Tune-up limit (dBm)	MPR (dB)
Frequency (MHz)				826.5	836.5	846.5		
5	QPSK	1	0	22.65	22.80	22.93		
5	QPSK	1	12	22.68	22.82	23.05	24	0
5	QPSK	1	24	22.67	22.93	22.87		
5	QPSK	12	0	21.66	21.80	21.87		
5	QPSK	12	7	21.61	21.77	21.66	23	1
5	QPSK	12	13	21.60	21.76	21.87		
5	QPSK	25	0	21.74	21.85	21.76		
5	16QAM	1	0	21.42	21.47	21.87	23	1
5	16QAM	1	12	21.48	21.48	21.60		
5	16QAM	1	24	21.42	21.52	21.45		
5	16QAM	12	0	20.82	20.99	20.86	22	2
5	16QAM	12	7	20.72	20.69	20.71		
5	16QAM	12	13	20.70	20.56	20.83		
5	16QAM	25	0	20.81	20.84	20.92	22	2



Channel				20415	20525	20635	Tune-up limit (dBm)	MPR (dB)
Frequency (MHz)				825.5	836.5	847.5		
3	QPSK	1	0	22.84	22.93	22.62	24	0
3	QPSK	1	8	22.65	22.81	22.91		
3	QPSK	1	14	22.65	22.67	23.01		
3	QPSK	8	0	21.60	21.62	21.69	23	1
3	QPSK	8	4	21.59	21.73	21.78		
3	QPSK	8	7	21.50	21.70	21.78		
3	QPSK	15	0	21.54	21.66	21.74	23	1
3	16QAM	1	0	21.54	21.93	21.57		
3	16QAM	1	8	21.51	21.80	21.87		
3	16QAM	1	14	21.48	21.95	21.54	22	2
3	16QAM	8	0	20.80	20.49	20.68		
3	16QAM	8	4	20.85	20.77	20.95		
3	16QAM	8	7	20.76	20.76	20.98	22	2
3	16QAM	15	0	20.76	20.50	20.89		
Channel				20407	20525	20643	Tune-up limit (dBm)	MPR (dB)
Frequency (MHz)				824.7	836.5	848.3		
1.4	QPSK	1	0	22.83	22.86	22.91	24	0
1.4	QPSK	1	3	22.88	23.00	23.00		
1.4	QPSK	1	5	22.81	22.90	22.96		
1.4	QPSK	3	0	22.85	22.95	23.04		
1.4	QPSK	3	1	22.96	23.05	22.93		
1.4	QPSK	3	3	22.87	22.95	23.01	23	1
1.4	QPSK	6	0	21.87	21.91	21.98		
1.4	16QAM	1	0	21.56	21.89	21.90	23	1
1.4	16QAM	1	3	21.42	21.48	21.60		
1.4	16QAM	1	5	21.41	21.87	21.52		
1.4	16QAM	3	0	21.83	21.87	21.65		
1.4	16QAM	3	1	21.92	22.04	21.82		
1.4	16QAM	3	3	21.93	22.05	21.79	22	2
1.4	16QAM	6	0	20.65	20.79	20.74		



<LTE Band 7>

BW [MHz]	Modulation	RB Size	RB Offset	Power Low Ch. / Freq.	Power Middle Ch. / Freq.	Power High Ch. / Freq.	Tune-up limit (dBm)	MPR (dB)
Channel				20850	21100	21350		
Frequency (MHz)				2510	2535	2560		
20	QPSK	1	0	22.87	22.86	22.84	24	0
20	QPSK	1	49	22.88	23.25	22.84		
20	QPSK	1	99	22.80	22.78	22.89		
20	QPSK	50	0	22.02	21.94	22.02	23	1
20	QPSK	50	24	22.08	22.01	22.07		
20	QPSK	50	50	22.01	22.17	22.01		
20	QPSK	100	0	22.11	22.17	22.04	23	1
20	16QAM	1	0	22.45	22.29	21.98		
20	16QAM	1	49	22.15	22.04	22.48		
20	16QAM	1	99	22.03	22.19	22.24	23	1
20	16QAM	12	0	22.12	22.01	22.37		
20	16QAM	12	44	22.01	22.01	22.20		
20	16QAM	12	88	22.19	22.20	22.34	22	2
20	16QAM	27	0	21.07	21.14	21.22		
Channel				20825	21100	21375		
Frequency (MHz)				2507.5	2535	2562.5		
15	QPSK	1	0	22.65	22.91	22.90	24	0
15	QPSK	1	37	22.99	22.82	23.05		
15	QPSK	1	74	22.82	22.95	22.95		
15	QPSK	36	0	22.02	22.00	22.09	23	1
15	QPSK	36	20	22.04	22.04	22.06		
15	QPSK	36	39	21.96	22.13	22.14		
15	QPSK	75	0	22.59	22.64	22.63	23	1
15	16QAM	1	0	22.09	22.46	22.28		
15	16QAM	1	37	22.11	22.40	22.46		
15	16QAM	1	74	22.23	22.43	22.29	23	1
15	16QAM	12	0	22.10	22.01	22.01		
15	16QAM	12	31	22.10	22.05	22.03		
15	16QAM	12	63	22.10	22.13	22.05	22	2
15	16QAM	27	0	21.18	21.24	21.44		



Channel				20800	21100	21400	Tune-up limit (dBm)	MPR (dB)
Frequency (MHz)				2505	2535	2565		
10	QPSK	1	0	22.79	22.82	23.13	24	0
10	QPSK	1	25	22.97	23.01	23.16		
10	QPSK	1	49	22.97	22.87	23.07		
10	QPSK	25	0	22.00	22.26	22.37	23	1
10	QPSK	25	12	21.98	22.21	22.38		
10	QPSK	25	25	22.10	22.28	22.35		
10	QPSK	50	0	22.07	22.32	22.41	23	1
10	16QAM	1	0	22.51	22.15	22.13		
10	16QAM	1	25	22.56	22.44	22.22		
10	16QAM	1	49	22.52	22.55	22.21	23	1
10	16QAM	12	0	21.99	22.13	22.07		
10	16QAM	12	19	22.14	22.26	22.11		
10	16QAM	12	38	21.91	22.32	22.22	22	2
10	16QAM	27	0	21.34	21.47	21.75		
Channel				20775	21100	21425	Tune-up limit (dBm)	MPR (dB)
Frequency (MHz)				2502.5	2535	2567.5		
5	QPSK	1	0	23.10	23.10	23.12	24	0
5	QPSK	1	12	23.15	23.16	23.12		
5	QPSK	1	24	23.10	23.12	23.19		
5	QPSK	12	0	22.38	22.50	22.56	23	1
5	QPSK	12	7	22.38	22.45	22.54		
5	QPSK	12	13	22.40	22.46	22.53		
5	QPSK	25	0	22.36	22.50	22.55	23	1
5	16QAM	1	0	21.87	22.06	21.99		
5	16QAM	1	12	22.24	22.29	22.25		
5	16QAM	1	24	21.87	22.09	22.28	22	2
5	16QAM	12	0	21.34	21.67	21.67		
5	16QAM	12	7	21.34	21.51	21.42		
5	16QAM	12	13	21.33	21.62	21.42	22	2
5	16QAM	25	0	21.48	21.64	21.60		



<LTE Band 13>

BW [MHz]	Modulation	RB Size	RB Offset	Power Low Ch. / Freq.	Power Middle Ch. / Freq.	Power High Ch. / Freq.	Tune-up limit (dBm)	MPR (dB)
Channel				23230				
Frequency (MHz)				782				
10	QPSK	1	0		22.67		24	0
10	QPSK	1	25		23.08			
10	QPSK	1	49		22.93			
10	QPSK	25	0		21.90		23	1
10	QPSK	25	12		21.79			
10	QPSK	25	25		21.75			
10	QPSK	50	0		21.74		23	1
10	16QAM	1	0		21.40			
10	16QAM	1	25		21.43			
10	16QAM	1	49		21.45		23	1
10	16QAM	12	0		21.68			
10	16QAM	12	19		21.72			
10	16QAM	12	38		21.78		23	1
10	16QAM	27	0		21.07			
Channel				23205	23230	23255	Tune-up limit (dBm)	MPR (dB)
Frequency (MHz)				779.5	782	784.5		
5	QPSK	1	0	22.36	22.80	22.61	24	0
5	QPSK	1	12	22.81	22.73	22.82		
5	QPSK	1	24	22.71	22.69	22.43		
5	QPSK	12	0	21.71	21.89	21.75	23	1
5	QPSK	12	7	21.86	21.82	21.84		
5	QPSK	12	13	21.74	21.80	21.70		
5	QPSK	25	0	21.69	21.69	21.65	23	1
5	16QAM	1	0	21.23	21.19	21.42		
5	16QAM	1	12	21.62	21.49	21.47		
5	16QAM	1	24	21.42	21.14	21.24	22	2
5	16QAM	12	0	20.78	20.61	20.75		
5	16QAM	12	7	20.80	20.63	20.85		
5	16QAM	12	13	20.63	20.61	20.81	22	2
5	16QAM	25	0	20.68	20.77	20.73		

<WLAN Conducted Power>

General Note:

1. Per KDB 248227 D01v02r02, SAR test reduction is determined according to 802.11 transmission mode configurations and certain exposure conditions with multiple test positions. In the 2.4 GHz band, separate SAR procedures are applied to DSSS and OFDM configurations to simplify DSSS test requirements. For OFDM, in both 2.4 and 5 GHz bands, an initial test configuration must be determined for each standalone and aggregated frequency band, according to the transmission mode configuration with the highest maximum output power specified for production units to perform SAR measurements. If the same highest maximum output power applies to different combinations of channel bandwidths, modulations and data rates, additional procedures are applied to determine which test configurations require SAR measurement. When applicable, an initial test position may be applied to reduce the number of SAR measurements required for next to the ear, UMPC mini-tablet or hotspot mode configurations with multiple test positions.
2. For 2.4 GHz 802.11b DSSS, either the initial test position procedure for multiple exposure test positions or the DSSS procedure for fixed exposure position is applied; these are mutually exclusive. For 2.4 GHz and 5 GHz OFDM configurations, the initial test configuration is applied to measure SAR using either the initial test position procedure for multiple exposure test position configurations or the initial test configuration procedures for fixed exposure test conditions. Based on the reported SAR of the measured configurations and maximum output power of the transmission mode configurations that are not included in the initial test configuration, the subsequent test configuration and initial test position procedures are applied to determine if SAR measurements are required for the remaining OFDM transmission configurations. In general, the number of test channels that require SAR measurement is minimized based on maximum output power measured for the test sample(s).
3. For OFDM transmission configurations in the 2.4 GHz and 5 GHz bands, When the same maximum power is specified for multiple transmission modes in a frequency band, the largest channel bandwidth, lowest order modulation, lowest data rate and lowest order 802.11a/g/n/ac mode is used for SAR measurement, on the highest measured output power channel for each frequency band.
4. DSSS and OFDM configurations are considered separately according to the required SAR procedures. SAR is measured in the initial test position using the 802.11 transmission mode configuration required by the DSSS procedure or initial test configuration and subsequent test configuration(s) according to the OFDM procedures.18 The initial test position procedure is described in the following:
 - a. When the reported SAR of the initial test position is ≤ 0.4 W/kg, further SAR measurement is not required for the other test positions in that exposure configuration and 802.11 transmission mode combinations within the frequency band or aggregated band.
 - b. When the reported SAR of the test position is > 0.4 W/kg, SAR is repeated for the 802.11 transmission mode configuration tested in the initial test position to measure the subsequent next closet/smallest test separation distance and maximum coupling position on the highest maximum output power channel, until the report SAR is ≤ 0.8 W/kg or all required test position are tested.
 - c. For all positions/configurations, when the reported SAR is > 0.8 W/kg, SAR is measured for these test positions/configurations on the subsequent next highest measured output power channel(s) until the reported SAR is ≤ 1.2 W/kg or all required channels are tested.

	Mode	Channel	Frequency (MHz)	Average power (dBm)	Tune-Up Limit	Duty Cycle %
2.4GHz WLAN	802.11b 1Mbps	1	2412	17.18	18.00	97.59
		6	2437	17.77	18.00	
		11	2462	16.74	18.00	
	802.11g 6Mbps	1	2412	12.09	13.00	87.50
		6	2437	12.44	13.00	
		11	2462	11.74	13.00	
	802.11n-HT20 MCS0	1	2412	10.08	11.00	86.70
		6	2437	10.48	11.00	
		11	2462	9.74	11.00	
	802.11n-HT40 MCS0	3	2422	6.01	9.00	85.76
		6	2437	7.35	9.00	
		9	2452	8.20	9.00	

13. Bluetooth Exclusions Applied

Mode Band	Average power(dBm)	
	Bluetooth-BR/EDR	Bluetooth-LE
2.4GHz Bluetooth	12.0	3.0

Note:

- Per KDB 447498 D01v06, the 1-g and 10-g SAR test exclusion thresholds for 100 MHz to 6 GHz at *test separation distances* ≤ 50 mm are determined by:

$$[(\text{max. power of channel, including tune-up tolerance, mW}) / (\text{min. test separation distance, mm})] \cdot [\sqrt{f(\text{GHz})}] \leq 3.0$$
 for 1-g SAR and ≤ 7.5 for 10-g extremity SAR
 - f(GHz) is the RF channel transmit frequency in GHz
 - Power and distance are rounded to the nearest mW and mm before calculation
 - The result is rounded to one decimal place for comparison

Bluetooth Max Power (dBm)	Separation Distance (mm)	Frequency (GHz)	exclusion thresholds
12.0	10	2.48	2.5

Note:

Per KDB 447498 D01v06, a distance of 10m is applied to determine SAR test exclusion. The test exclusion threshold is 2.5 which is ≤ 3, SAR testing is not required.

Bluetooth Max Power (dBm)	Separation Distance (mm)	Frequency (GHz)	exclusion thresholds
12.0	< 5	2.48	5.0

Note:

Per KDB 447498 D01v06, when the minimum test separation distance is < 5 mm, a distance of 5 mm is applied to determine SAR test exclusion. The test exclusion threshold is 5.0 which is ≤ 7.5 SAR testing is not required.



14. SAR Test Results

General Note:

1. Per KDB 447498 D01v06, the reported SAR is the measured SAR value adjusted for maximum tune-up tolerance.
 - a. Tune-up scaling Factor = tune-up limit power (mW) / EUT RF power (mW), where tune-up limit is the maximum rated power among all production units.
 - b. For SAR testing of WLAN signal with non-100% duty cycle, the measured SAR is scaled-up by the duty cycle scaling factor which is equal to "1/(duty cycle)"
 - c. For WWAN: Reported SAR(W/kg)= Measured SAR(W/kg)*Tune-up Scaling Factor
 - d. For WLAN: Reported SAR(W/kg)= Measured SAR(W/kg)* Duty Cycle scaling factor * Tune-up scaling factor
2. Per KDB 447498 D01v06, for each exposure position, testing of other required channels within the operating mode of a frequency band is not required when the *reported* 1-g or 10-g SAR for the mid-band or highest output power channel is:
 - ≤ 0.8 W/kg or 2.0 W/kg, for 1-g or 10-g respectively, when the transmission band is ≤ 100 MHz
 - ≤ 0.6 W/kg or 1.5 W/kg, for 1-g or 10-g respectively, when the transmission band is between 100 MHz and 200 MHz
 - ≤ 0.4 W/kg or 1.0 W/kg, for 1-g or 10-g respectively, when the transmission band is ≥ 200 MHz
3. Per KDB 865664 D01v01r04, for each frequency band, repeated SAR measurement is required only when the measured SAR is ≥ 0.8 W/kg.

LTE Note:

1. Per KDB 941225 D05v02r05, start with the largest channel bandwidth and measure SAR for QPSK with 1 RB allocation, using the RB offset and required test channel combination with the highest maximum output power for RB offsets at the upper edge, middle and lower edge of each required test channel.
2. Per KDB 941225 D05v02r05, 50% RB allocation for QPSK SAR testing follows 1RB QPSK allocation procedure.
3. Per KDB 941225 D05v02r05, for QPSK with 100% RB allocation, SAR is not required when the highest maximum output power for 100 % RB allocation is less than the highest maximum output power in 50% and 1 RB allocations and the highest reported SAR for 1 RB and 50% RB allocation are ≤ 0.8 W/kg. Otherwise, SAR is measured for the highest output power channel; and if the reported SAR is > 1.45 W/kg, the remaining required test channels must also be tested.
4. Per KDB 941225 D05v02r05, 16QAM/64QAM output power for each RB allocation configuration is $>$ not $\frac{1}{2}$ dB higher than the same configuration in QPSK and the reported SAR for the QPSK configuration is ≤ 1.45 W/kg; Per KDB 941225 D05v02r05, 16QAM/64QAM SAR testing is not required.
5. Per KDB 941225 D05v02r05, smaller bandwidth output power for each RB allocation configuration is $>$ not $\frac{1}{2}$ dB higher than the same configuration in the largest supported bandwidth, and the reported SAR for the largest supported bandwidth is ≤ 1.45 W/kg; Per KDB 941225 D05v02r05, smaller bandwidth SAR testing is not required.
6. For LTE B4 / B5 the maximum bandwidth does not support three non-overlapping channels, per KDB 941225 D05v02r05, when a device supports overlapping channel assignment in a channel bandwidth configuration, the middle channel of the group of overlapping channels should be selected for testing.

WLAN Note:

1. Per KDB 248227 D01v02r02, for 2.4GHz 802.11g/n SAR testing is not required when the highest reported SAR for DSSS is adjusted by the ratio of OFDM to DSSS specified maximum output power and the adjusted SAR is ≤ 1.2 W/kg.
2. When the reported SAR of the test position is > 0.4 W/kg, SAR is repeated for the 802.11 transmission mode configuration tested in the initial test position to measure the subsequent next closet/smallest test separation distance and maximum coupling test position on the highest maximum output power channel, until the report SAR is ≤ 0.8 W/kg or all required test position are tested.
3. For all positions / configurations, when the reported SAR is > 0.8 W/kg, SAR is measured for these test positions / configurations on the subsequent next highest measured output power channel(s) until the reported SAR is ≤ 1.2 W/kg or all required channels are tested.
4. During SAR testing the WLAN transmission was verified using a spectrum analyzer.



14.1 Next to Mouth SAR

<FDD LTE SAR>

Plot No.	Band	BW (MHz)	Modulation	RB Size	RB Offset	Test Position	Gap (mm)	Ch.	Freq. (MHz)	Average Power (dBm)	Tune-Up Limit (dBm)	Tune-up Scaling Factor	Power Drift (dB)	Measured 1g SAR (W/kg)	Reported 1g SAR (W/kg)
01	LTE Band 13	10M	QPSK	1	25	Next to Mouth	10mm	23230	782	23.08	24.00	1.236	0.07	0.037	0.045
	LTE Band 13	10M	QPSK	25	0	Next to Mouth	10mm	23230	782	21.90	23.00	1.288	0.03	0.025	0.033
02	LTE Band 5	10M	QPSK	1	25	Next to Mouth	10mm	20525	836.5	23.06	24.00	1.242	-0.18	0.051	0.063
	LTE Band 5	10M	QPSK	25	25	Next to Mouth	10mm	20525	836.5	21.93	23.00	1.279	0.02	0.039	0.050
03	LTE Band 4	20M	QPSK	1	49	Next to Mouth	10mm	20175	1732.5	23.23	24.00	1.194	-0.03	0.564	0.673
	LTE Band 4	20M	QPSK	50	24	Next to Mouth	10mm	20175	1732.5	22.28	23.00	1.180	0.02	0.484	0.571
04	LTE Band 2	20M	QPSK	1	0	Next to Mouth	10mm	19100	1900	23.14	24.00	1.219	-0.08	0.644	0.785
	LTE Band 2	20M	QPSK	50	0	Next to Mouth	10mm	19100	1900	21.99	23.00	1.262	0.02	0.515	0.650
05	LTE Band 7	20M	QPSK	1	49	Next to Mouth	10mm	21100	2535	23.25	24.00	1.189	0.01	0.763	0.907
	LTE Band 7	20M	QPSK	1	49	Next to Mouth	10mm	20850	2510	22.88	24.00	1.294	-0.04	0.504	0.652
	LTE Band 7	20M	QPSK	1	49	Next to Mouth	10mm	21350	2560	22.84	24.00	1.306	0.07	0.608	0.794
	LTE Band 7	20M	QPSK	50	50	Next to Mouth	10mm	21100	2535	22.17	23.00	1.211	0.08	0.615	0.745
	LTE Band 7	20M	QPSK	100	0	Next to Mouth	10mm	21100	2535	22.17	23.00	1.211	0.01	0.640	0.775

<WLAN SAR>

Plot No.	Band	Mode	Test Position	Gap (mm)	Ch.	Freq. (MHz)	Average Power (dBm)	Tune-Up Limit (dBm)	Tune-up Scaling Factor	Duty Cycle %	Duty Cycle Scaling Factor	Power Drift (dB)	Measured 1g SAR (W/kg)	Reported 1g SAR (W/kg)
06	WLAN 2.4GHz	802.11b 1Mbps	Next to Mouth	10mm	6	2437	17.77	18.00	1.054	97.59	1.025	0.04	0.154	0.166



14.2 Wrist-Worn SAR

<FDD LTE SAR>

Plot No.	Band	BW (MHz)	Modulation	RB Size	RB Offset	Test Position	Gap (mm)	Ch.	Freq. (MHz)	Average Power (dBm)	Tune-Up Limit (dBm)	Tune-up Scaling Factor	Power Drift (dB)	Measured 10g SAR (W/kg)	Reported 10g SAR (W/kg)
07	LTE Band 13	10M	QPSK	1	25	Back	0mm	23230	782	23.08	24.00	1.236	0.06	0.215	0.266
	LTE Band 13	10M	QPSK	25	0	Back	0mm	23230	782	21.90	23.00	1.288	0.07	0.170	0.219
08	LTE Band 5	10M	QPSK	1	25	Back	0mm	20525	836.5	23.06	24.00	1.242	-0.07	0.177	0.220
	LTE Band 5	10M	QPSK	25	25	Back	0mm	20525	836.5	21.93	23.00	1.279	0.01	0.143	0.183
09	LTE Band 4	20M	QPSK	1	49	Back	0mm	20175	1732.5	23.23	24.00	1.194	-0.13	1.660	1.982
	LTE Band 4	20M	QPSK	50	24	Back	0mm	20175	1732.5	22.28	23.00	1.180	0.05	1.320	1.558
10	LTE Band 2	20M	QPSK	1	0	Back	0mm	19100	1900	23.14	24.00	1.219	-0.02	0.881	1.074
	LTE Band 2	20M	QPSK	50	0	Back	0mm	19100	1900	21.99	23.00	1.262	0.01	0.608	0.767
11	LTE Band 7	20M	QPSK	1	49	Back	0mm	21100	2535	23.25	24.00	1.189	0.01	0.951	1.130
	LTE Band 7	20M	QPSK	50	50	Back	0mm	21100	2535	22.17	23.00	1.211	0.05	0.779	0.943

<WLAN SAR>

Plot No.	Band	Mode	Test Position	Gap (mm)	Ch.	Freq. (MHz)	Average Power (dBm)	Tune-Up Limit (dBm)	Tune-up Scaling Factor	Duty Cycle %	Duty Cycle Scaling Factor	Power Drift (dB)	Measured 10g SAR (W/kg)	Reported 10g SAR (W/kg)
12	WLAN 2.4GHz	802.11b 1Mbps	Back	0mm	6	2437	17.77	18.00	1.054	97.59	1.025	-0.02	0.172	0.186

15. Simultaneous Transmission Analysis

NO.	Simultaneous Transmission Configurations	Next to Mouth	Wrist worn
1.	LTE + WLAN2.4GHz	Yes	Yes
2.	LTE + Bluetooth	Yes	Yes

General Note:

1. This device supported VoIP in LTE (e.g. 3rd party VoIP), LTE supports VoLTE operation.
2. WLAN and Bluetooth share the same antenna, and cannot transmit simultaneously.
3. The Scaled SAR summation is calculated based on the same configuration and test position.
4. Per KDB 447498 D01v06, simultaneous transmission SAR is compliant if,
 - i) Scalar SAR summation < 1.6W/kg and 10g Scalar SAR summation < 4.0W/kg.
 - ii) $SPLSR = (SAR1 + SAR2)^{1.5} / (\text{min. separation distance, mm})$, and the peak separation distance is determined from the square root of $[(x1-x2)^2 + (y1-y2)^2 + (z1-z2)^2]$, where (x1, y1, z1) and (x2, y2, z2) are the coordinates of the extrapolated peak SAR locations in the zoom scan.
 - iii) If $SPLSR \leq 0.04$ for 1g SAR, $SPLSR \leq 0.10$ for 10g SAR simultaneously transmission SAR measurement is not necessary.
 - iv) Simultaneously transmission SAR measurement, and the reported multi-band SAR < 1.6W/kg .
5. For simultaneous transmission analysis, Bluetooth SAR is estimated per KDB 447498 D01v06 based on the formula below.
 - i) $(\text{max. power of channel, including tune-up tolerance, mW}) / (\text{min. test separation distance, mm}) \cdot [\sqrt{f(\text{GHz})} / x] \text{ W/kg}$ for test separation distances $\leq 50 \text{ mm}$; where $x = 7.5$ for 1-g SAR, and $x = 18.75$ for 10-g SAR.
 - ii) When the minimum separation distance is < 5mm, the distance is used 5mm to determine SAR test exclusion.
 - iii) 0.4 W/kg for 1-g SAR and 1.0 W/kg for 10-g SAR, when the test separation distances is > 50 mm.

Bluetooth Max Power	Exposure Position	Next to Mouth	Limbs-worn
	Test separation	10 mm	0 mm
12.0 dBm	Estimated SAR (W/kg)	0.333	0.266

15.1 Next to Mouth Exposure Conditions

WWAN Band		Exposure Position	1	2	3	1+2 Summed 1g SAR (W/kg)	1+3 Summed 1g SAR (W/kg)
			WWAN	2.4GHz WLAN	Bluetooth		
			1g SAR (W/kg)	1g SAR (W/kg)	Estimated 1g SAR (W/kg)		
LTE	LTE Band 2	Next to mouth at 10mm	0.785	0.166	0.333	0.95	1.12
	LTE Band 4	Next to mouth at 10mm	0.673	0.166	0.333	0.84	1.01
	LTE Band 5	Next to mouth at 10mm	0.063	0.166	0.333	0.23	0.40
	LTE Band 7	Next to mouth at 10mm	0.907	0.166	0.333	1.07	1.24
	LTE Band 13	Next to mouth at 10mm	0.045	0.166	0.333	0.21	0.38

15.2 Wrist-Worn Exposure Conditions

WWAN Band		Exposure Position	1	2	3	1+2 Summed 10g SAR (W/kg)	1+3 Summed 10g SAR (W/kg)
			WWAN	2.4GHz WLAN	Bluetooth		
			10g SAR (W/kg)	10g SAR (W/kg)	Estimated 10g SAR (W/kg)		
LTE	LTE Band 2	Back at 0mm	1.074	0.186	0.266	1.26	1.34
	LTE Band 4	Back at 0mm	1.982	0.186	0.266	2.17	2.25
	LTE Band 5	Back at 0mm	0.220	0.186	0.266	0.41	0.49
	LTE Band 7	Back at 0mm	1.130	0.186	0.266	1.32	1.40
	LTE Band 13	Back at 0mm	0.266	0.186	0.266	0.45	0.53

Test Engineer: Nick Hu, Yuan Zhao, Jiaying Chang, Yuankai Kong

-----THE END-----



16. Uncertainty Assessment

Per KDB 865664 D01 SAR measurement 100MHz to 6GHz, when the highest measured 1-g SAR within a frequency band is < 1.5 W/kg and the measured 10-g SAR within a frequency band is < 3.75 W/kg. The expanded SAR measurement uncertainty must be $\leq 30\%$, for a confidence interval of $k = 2$. If these conditions are met, extensive SAR measurement uncertainty analysis described in IEEE Std 1528-2013 is not required in SAR reports submitted for equipment approval. For this device, the highest measured 1-g SAR is less 1.5W/kg and highest measured 10-g SAR is less 3.75W/kg. Therefore, the measurement uncertainty table is not required in this report.



17. References

- [1] FCC 47 CFR Part 2 "Frequency Allocations and Radio Treaty Matters; General Rules and Regulations"
- [2] ANSI/IEEE Std. C95.1-1992, "IEEE Standard for Safety Levels with Respect to Human Exposure to Radio Frequency Electromagnetic Fields, 3 kHz to 300 GHz", September 1992
- [3] IEEE Std. 1528-2013, "IEEE Recommended Practice for Determining the Peak Spatial-Average Specific Absorption Rate (SAR) in the Human Head from Wireless Communications Devices: Measurement Techniques", Sep 2013
- [4] SPEAG DASY System Handbook
- [5] FCC KDB 865664 D01 v01r04, "SAR Measurement Requirements for 100 MHz to 6 GHz", Aug 2015.
- [6] FCC KDB 865664 D02 v01r02, "RF Exposure Compliance Reporting and Documentation Considerations" Oct 2015.
- [7] FCC KDB 447498 D01 v06, "Mobile and Portable Device RF Exposure Procedures and Equipment Authorization Policies", Oct 2015
- [8] FCC KDB 248227 D01 v02r02, "SAR Guidance for IEEE 802.11 (WiFi) Transmitters", Oct 2015.
- [9] FCC KDB 941225 D05 v02r05, "SAR Evaluation Considerations for LTE Devices", Dec 2015



Appendix A. Plots of System Performance Check

The plots are shown as follows.

System Check_Head_750MHz

DUT: D750V2 - SN:1087

Communication System: UID 0, CW (0); Frequency: 750 MHz; Duty Cycle: 1:1
Medium: HSL_750 Medium parameters used: $f = 750$ MHz; $\sigma = 0.879$ S/m; $\epsilon_r = 43.09$; $\rho = 1000$ kg/m³
Ambient Temperature : 23.3 °C ; Liquid Temperature : 22.7 °C

DASY5 Configuration:

- Probe: ES3DV3 - SN3279; ConvF(6.58, 6.58, 6.58); Calibrated: 2019.3.4
- Sensor-Surface: 3mm (Mechanical Surface Detection)
- Electronics: DAE4 Sn1279; Calibrated: 2018.10.22
- Phantom: SAM1; Type: SAM; Serial: TP-1697
- Measurement SW: DASY52, Version 52.10 (1); SEMCAD X Version 14.6.11 (7439)

Pin=250mW/Area Scan (61x61x1): Interpolated grid: dx=1.500 mm, dy=1.500 mm
Maximum value of SAR (interpolated) = 3.11 W/kg

Pin=250mW/Zoom Scan (5x5x7)/Cube 0: Measurement grid: dx=8mm, dy=8mm, dz=5mm
Reference Value = 62.63 V/m; Power Drift = -0.06 dB
Peak SAR (extrapolated) = 3.41 W/kg
SAR(1 g) = 2.09 W/kg; SAR(10 g) = 1.39 W/kg
Maximum value of SAR (measured) = 3.11 W/kg

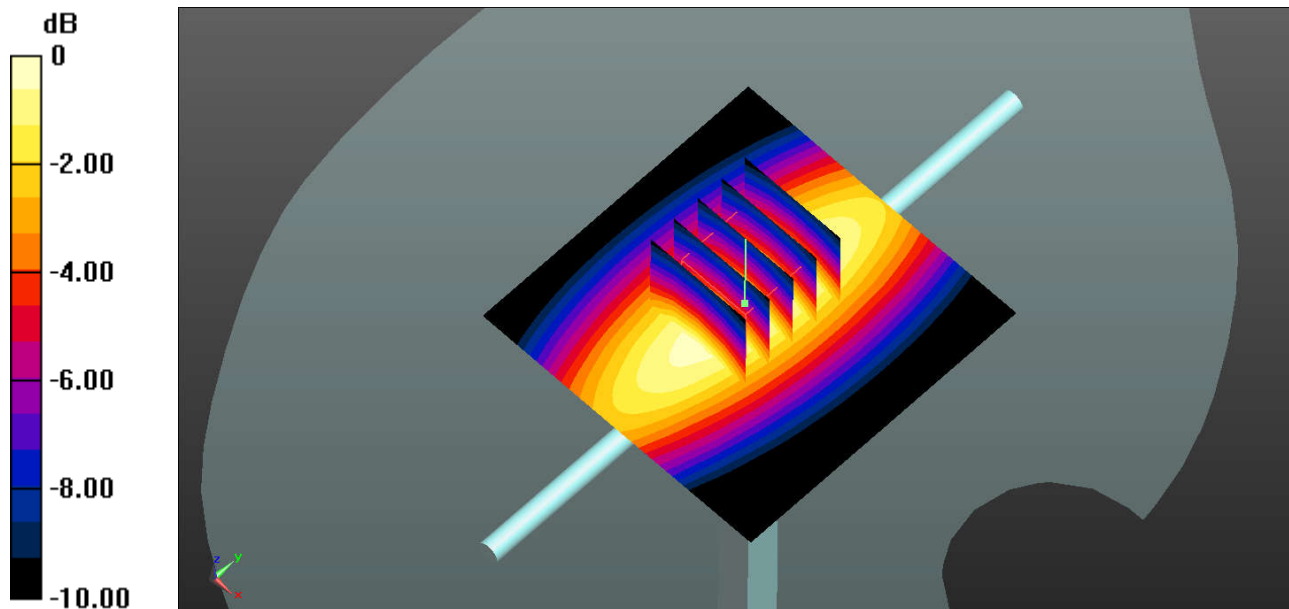

0 dB = 3.11 W/kg = 4.93 dBW/kg

System Check_Head_835MHz

DUT: D835V2 - SN:4d151

Communication System: UID 0, CW (0); Frequency: 835 MHz; Duty Cycle: 1:1

Medium: HSL_835 Medium parameters used: $f = 835 \text{ MHz}$; $\sigma = 0.914 \text{ S/m}$; $\epsilon_r = 41.643$; $\rho = 1000 \text{ kg/m}^3$

Ambient Temperature : $23.3 \text{ }^\circ\text{C}$; Liquid Temperature : $22.7 \text{ }^\circ\text{C}$

DASY5 Configuration:

- Probe: ES3DV3 - SN3279; ConvF(6.38, 6.38, 6.38); Calibrated: 2019.3.4
- Sensor-Surface: 3mm (Mechanical Surface Detection)
- Electronics: DAE4 Sn1279; Calibrated: 2018.10.22
- Phantom: SAM1; Type: SAM; Serial: TP-1697
- Measurement SW: DASY52, Version 52.10 (1); SEMCAD X Version 14.6.11 (7439)

Pin=250mW/Area Scan (61x61x1): Interpolated grid: $dx=1.500 \text{ mm}$, $dy=1.500 \text{ mm}$

Maximum value of SAR (interpolated) = 3.27 W/kg

Pin=250mW/Zoom Scan (5x5x7)/Cube 0: Measurement grid: $dx=8\text{mm}$, $dy=8\text{mm}$, $dz=5\text{mm}$

Reference Value = 61.29 V/m ; Power Drift = 0.06 dB

Peak SAR (extrapolated) = 3.69 W/kg

SAR(1 g) = 2.43 W/kg ; SAR(10 g) = 1.59 W/kg

Maximum value of SAR (measured) = 3.26 W/kg

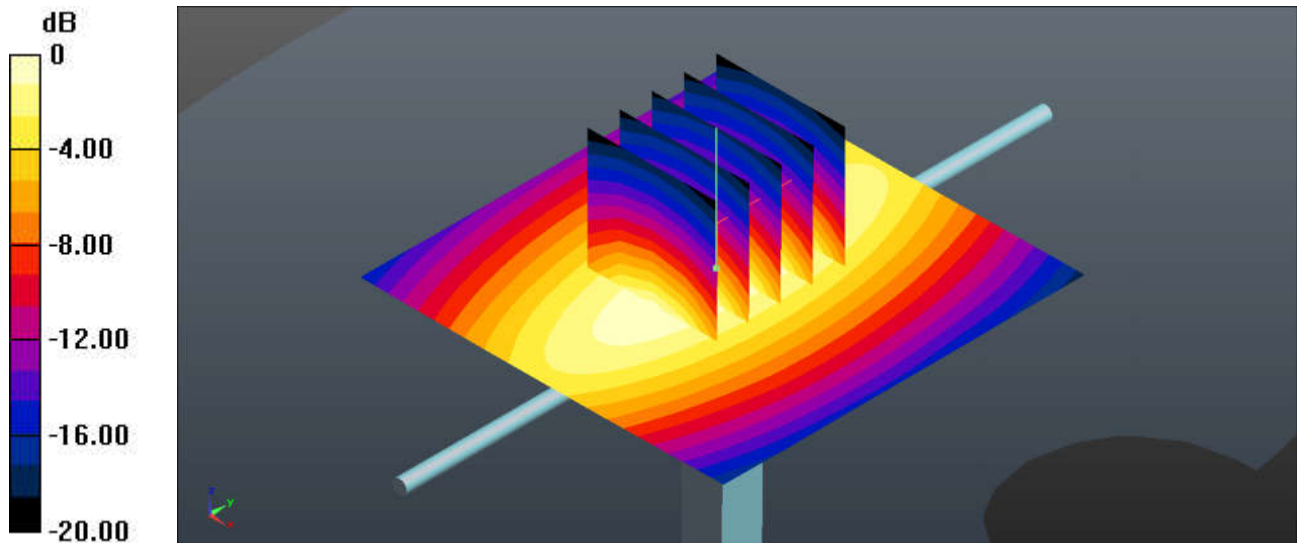

0 dB = $3.26 \text{ W/kg} = 5.13 \text{ dBW/kg}$

System Check_Head_1750MHz

DUT: D1750V2 - SN:1090

Communication System: UID 0, CW (0); Frequency: 1750 MHz; Duty Cycle: 1:1

Medium: HSL_1750 Medium parameters used: $f = 1750$ MHz; $\sigma = 1.326$ S/m; $\epsilon_r = 41.821$; $\rho = 1000$ kg/m³

Ambient Temperature : 23.3 °C ; Liquid Temperature : 22.6 °C

DASY5 Configuration:

- Probe: ES3DV3 - SN3279; ConvF(5.59, 5.59, 5.59); Calibrated: 2019.3.4
- Sensor-Surface: 3mm (Mechanical Surface Detection)
- Electronics: DAE4 Sn1279; Calibrated: 2018.10.22
- Phantom: SAM1; Type: SAM; Serial: TP-1697
- Measurement SW: DASY52, Version 52.10 (1); SEMCAD X Version 14.6.11 (7439)

Pin=250mW/Area Scan (61x61x1): Interpolated grid: dx=1.500 mm, dy=1.500 mm

Maximum value of SAR (interpolated) = 12.6 W/kg

Pin=250mW/Zoom Scan (5x5x7)/Cube 0: Measurement grid: dx=8mm, dy=8mm, dz=5mm

Reference Value = 83.89 V/m; Power Drift = 0.05 dB

Peak SAR (extrapolated) = 15.9 W/kg

SAR(1 g) = 8.77 W/kg; SAR(10 g) = 4.66 W/kg

Maximum value of SAR (measured) = 12.6 W/kg

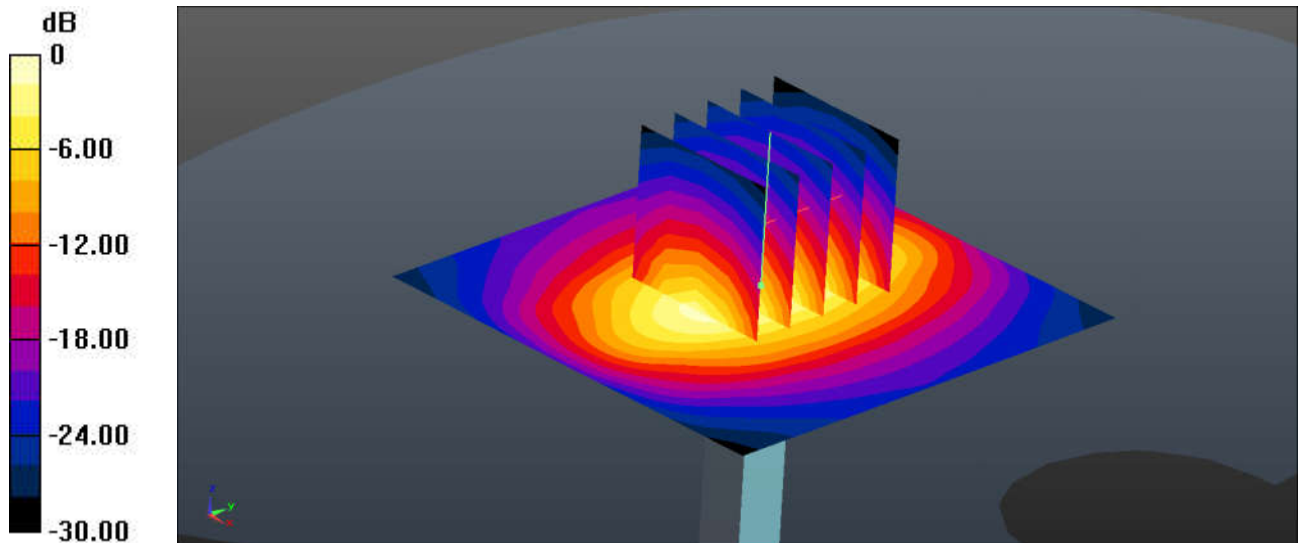

0 dB = 12.6 W/kg = 11.00 dBW/kg

System Check_Head_1900MHz

DUT: D1900V2 - SN:5d170

Communication System: UID 0, CW (0); Frequency: 1900 MHz;Duty Cycle: 1:1
Medium: HSL_1900 Medium parameters used: $f = 1900$ MHz; $\sigma = 1.423$ S/m; $\epsilon_r = 38.836$; $\rho = 1000$ kg/m³
Ambient Temperature : 23.5 °C; Liquid Temperature : 22.8 °C

DASY5 Configuration:

- Probe: ES3DV3 - SN3279; ConvF(5.35, 5.35, 5.35); Calibrated: 2019.3.4
- Sensor-Surface: 3mm (Mechanical Surface Detection)
- Electronics: DAE4 Sn1279; Calibrated: 2018.10.22
- Phantom: SAM1; Type: SAM; Serial: TP-1697
- Measurement SW: DASY52, Version 52.10 (1); SEMCAD X Version 14.6.11 (7439)

Pin=250mW/Area Scan (61x61x1): Interpolated grid: dx=1.500 mm, dy=1.500 mm
Maximum value of SAR (interpolated) = 14.5 W/kg

Pin=250mW/Zoom Scan (5x5x7)/Cube 0: Measurement grid: dx=8mm, dy=8mm, dz=5mm
Reference Value = 88.77 V/m; Power Drift = -0.05 dB
Peak SAR (extrapolated) = 18.3 W/kg
SAR(1 g) = 9.7 W/kg; SAR(10 g) = 4.96 W/kg
Maximum value of SAR (measured) = 14.1 W/kg

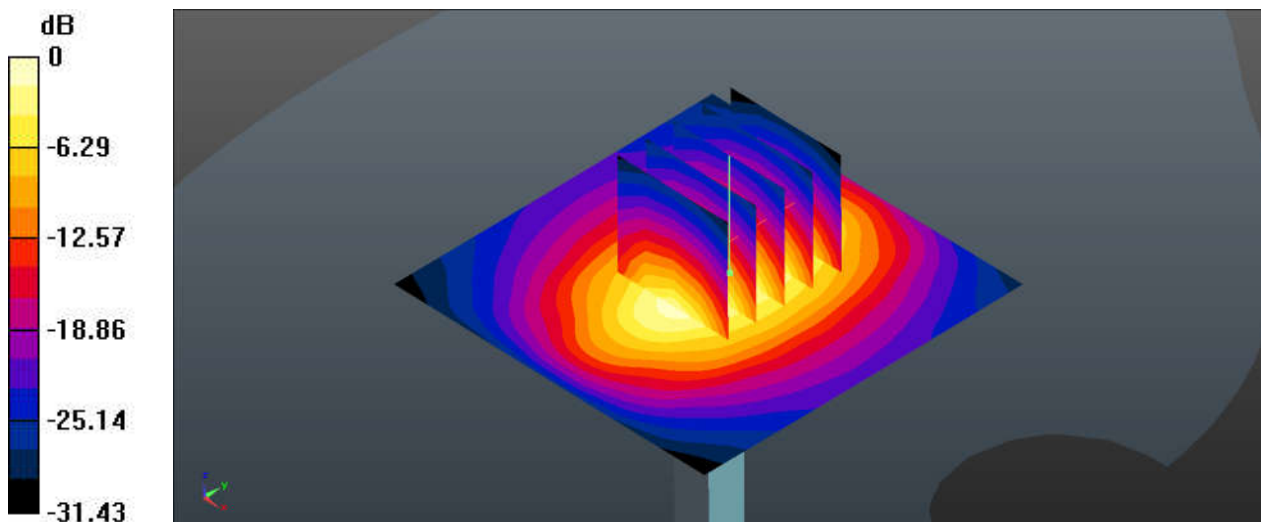

0 dB = 14.5 W/kg = 11.61 dBW/kg

System Check_Head_2450MHz

DUT: D2450V2 - SN:908

Communication System: UID 0, CW (0); Frequency: 2450 MHz; Duty Cycle: 1:1
Medium: HSL_2450 Medium parameters used: $f = 2450$ MHz; $\sigma = 1.869$ S/m; $\epsilon_r = 38.891$; $\rho = 1000$ kg/m³
Ambient Temperature : 23.3 °C ; Liquid Temperature : 22.7 °C

DASY5 Configuration:

- Probe: ES3DV3 - SN3279; ConvF(4.77, 4.77, 4.77); Calibrated: 2019.3.4
- Sensor-Surface: 3mm (Mechanical Surface Detection)
- Electronics: DAE4 Sn1279; Calibrated: 2018.10.22
- Phantom: SAM1; Type: SAM; Serial: TP-1697
- Measurement SW: DASY52, Version 52.10 (1); SEMCAD X Version 14.6.11 (7439)

Pin=250mW/Area Scan (71x71x1): Interpolated grid: dx=1.200 mm, dy=1.200 mm
Maximum value of SAR (interpolated) = 20.2 W/kg

Pin=250mW/Zoom Scan (7x7x7)/Cube 0: Measurement grid: dx=5mm, dy=5mm, dz=5mm
Reference Value = 84.94 V/m; Power Drift = 0.11 dB
Peak SAR (extrapolated) = 26.4 W/kg
SAR(1 g) = 13.4 W/kg; SAR(10 g) = 6.41 W/kg
Maximum value of SAR (measured) = 20.1 W/kg

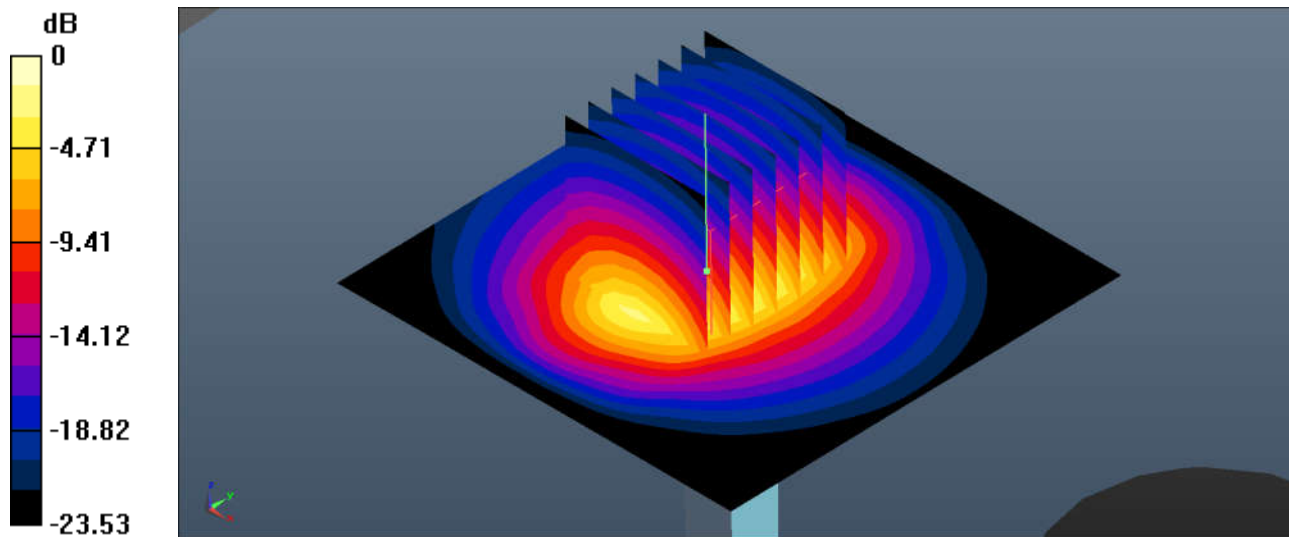

System Check_Head_2600MHz

DUT: D2600V2 - SN:1061

Communication System: UID 0, CW (0); Frequency: 2600 MHz;Duty Cycle: 1:1
Medium: HSL_2600 Medium parameters used: $f = 2600$ MHz; $\sigma = 2.049$ S/m; $\epsilon_r = 38.257$; $\rho = 1000$ kg/m³
Ambient Temperature : 23.4 °C; Liquid Temperature : 22.7 °C

DASY5 Configuration:

- Probe: ES3DV3 - SN3279; ConvF(4.58, 4.58, 4.58); Calibrated: 2019.3.4
- Sensor-Surface: 3mm (Mechanical Surface Detection)
- Electronics: DAE4 Sn1279; Calibrated: 2018.10.22
- Phantom: SAM1; Type: SAM; Serial: TP-1697
- Measurement SW: DASY52, Version 52.10 (1); SEMCAD X Version 14.6.11 (7439)

Pin=250mW/Area Scan (71x71x1): Interpolated grid: dx=1.200 mm, dy=1.200 mm

Maximum value of SAR (interpolated) = 23.0 W/kg

Pin=250mW/Zoom Scan (7x7x7)/Cube 0: Measurement grid: dx=5mm, dy=5mm, dz=5mm

Reference Value = 83.21 V/m; Power Drift = 0.17 dB

Peak SAR (extrapolated) = 32.0 W/kg

SAR(1 g) = 14.1 W/kg; SAR(10 g) = 6.06 W/kg

Maximum value of SAR (measured) = 22.6 W/kg

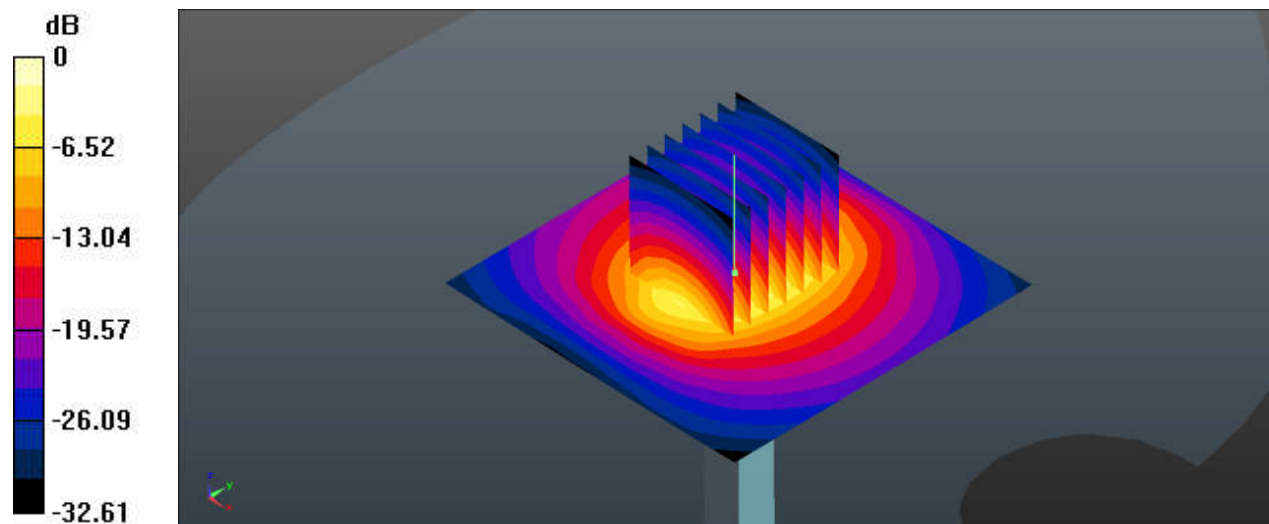

0 dB = 23.0 W/kg = 13.62 dBW/kg



Appendix B. Plots of High SAR Measurement

The plots are shown as follows.

01_LTE Band_13_10M_QPSK_1RB_25Offset_Next to Mouth_10mm_Ch23230

Communication System: UID 0, LTE-FDD (0); Frequency: 782 MHz; Duty Cycle: 1:1
 Medium: HSL_750 Medium parameters used: $f = 782 \text{ MHz}$; $\sigma = 0.909 \text{ S/m}$; $\epsilon_r = 42.788$; $\rho = 1000 \text{ kg/m}^3$
 Ambient Temperature : $23.3 \text{ }^\circ\text{C}$; Liquid Temperature : $22.7 \text{ }^\circ\text{C}$

DASY5 Configuration:

- Probe: ES3DV3 - SN3279; ConvF(6.58, 6.58, 6.58); Calibrated: 2019.3.4
- Sensor-Surface: 3mm (Mechanical Surface Detection)
- Electronics: DAE4 Sn1279; Calibrated: 2018.10.22
- Phantom: SAM1; Type: SAM; Serial: TP-1697
- Measurement SW: DASY52, Version 52.10 (1); SEMCAD X Version 14.6.11 (7439)

Ch23230/Area Scan (51x51x1): Interpolated grid: $dx=1.500 \text{ mm}$, $dy=1.500 \text{ mm}$
 Maximum value of SAR (interpolated) = 0.0485 W/kg

Ch23230/Zoom Scan (5x5x7)/Cube 0: Measurement grid: $dx=8\text{mm}$, $dy=8\text{mm}$, $dz=5\text{mm}$
 Reference Value = 8.365 V/m ; Power Drift = 0.07 dB
 Peak SAR (extrapolated) = 0.0840 W/kg
SAR(1 g) = 0.037 W/kg ; SAR(10 g) = 0.017 W/kg
 Maximum value of SAR (measured) = 0.0504 W/kg

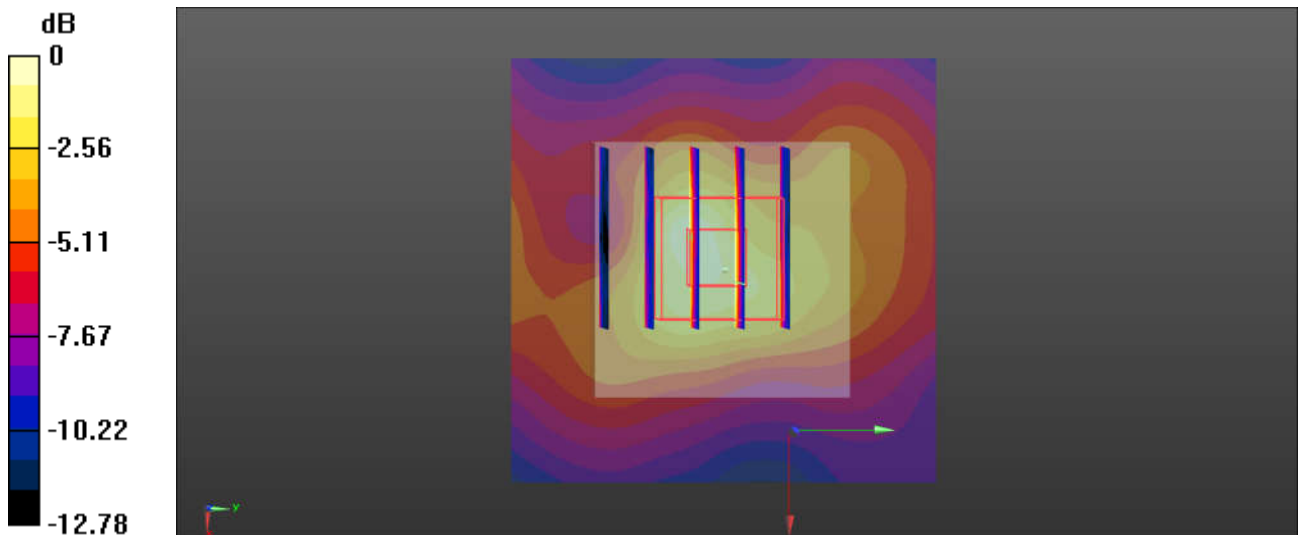

0 dB = 0.0504 W/kg = -12.98 dBW/kg

02_LTE Band 5_10M_QPSK_1RB_25Offset_Next to Mouth_10mm_Ch20525

Communication System: UID 0, LTE-FDD (0); Frequency: 836.5 MHz; Duty Cycle: 1:1
Medium: HSL_835 Medium parameters used: $f = 836.5$ MHz; $\sigma = 0.915$ S/m; $\epsilon_r = 41.619$; $\rho = 1000$ kg/m³
Ambient Temperature : 23.3 °C ; Liquid Temperature : 22.7 °C

DASY5 Configuration:

- Probe: ES3DV3 - SN3279; ConvF(6.38, 6.38, 6.38); Calibrated: 2019.3.4
- Sensor-Surface: 3mm (Mechanical Surface Detection)
- Electronics: DAE4 Sn1279; Calibrated: 2018.10.22
- Phantom: SAM1; Type: SAM; Serial: TP-1697
- Measurement SW: DASY52, Version 52.10 (1); SEMCAD X Version 14.6.11 (7439)

Ch20525/Area Scan (51x51x1): Interpolated grid: dx=1.500 mm, dy=1.500 mm
Maximum value of SAR (interpolated) = 0.0434 W/kg

Ch20525/Zoom Scan (5x5x7)/Cube 0: Measurement grid: dx=8mm, dy=8mm, dz=5mm
Reference Value = 8.246 V/m; Power Drift = -0.18 dB
Peak SAR (extrapolated) = 0.108 W/kg
SAR(1 g) = 0.051 W/kg; SAR(10 g) = 0.023 W/kg
Maximum value of SAR (measured) = 0.0586 W/kg

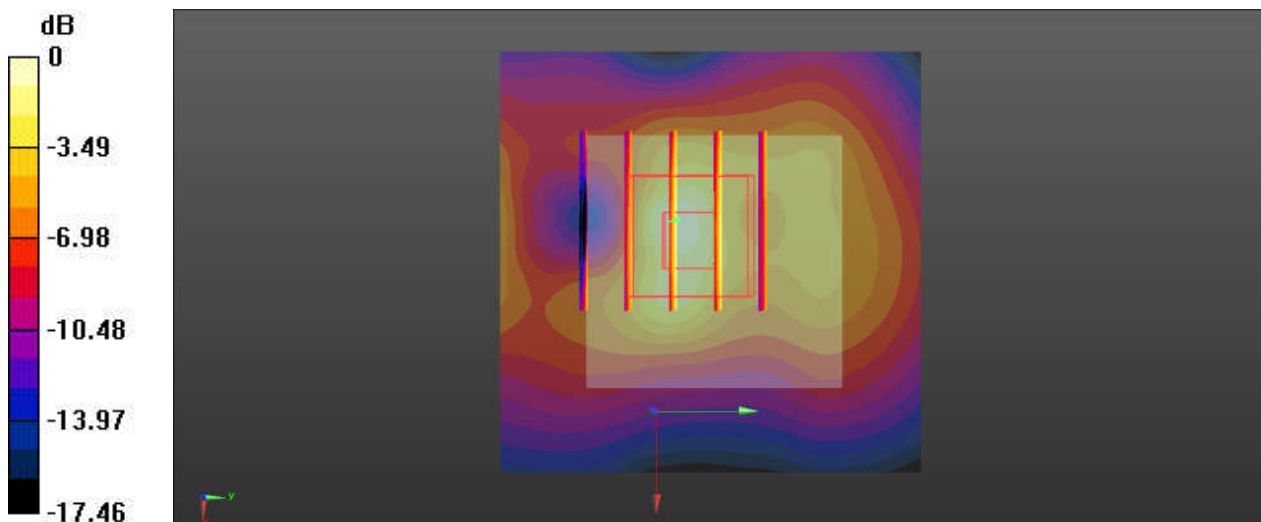

0 dB = 0.0586 W/kg = -12.32 dBW/kg

03_LTE Band 4_20M_QPSK_1RB_49Offset_Next to Mouth_10mm_Ch20175

Communication System: UID 0, LTE-FDD (0); Frequency: 1732.5 MHz; Duty Cycle: 1:1
Medium: HSL_1750 Medium parameters used: $f = 1732.5$ MHz; $\sigma = 1.308$ S/m; $\epsilon_r = 41.893$; $\rho = 1000$ kg/m³
Ambient Temperature : 23.3 °C; Liquid Temperature : 22.6 °C

DASY5 Configuration:

- Probe: ES3DV3 - SN3279; ConvF(5.59, 5.59, 5.59); Calibrated: 2019.3.4
- Sensor-Surface: 3mm (Mechanical Surface Detection)
- Electronics: DAE4 Sn1279; Calibrated: 2018.10.22
- Phantom: SAM1; Type: SAM; Serial: TP-1697
- Measurement SW: DASY52, Version 52.10 (1); SEMCAD X Version 14.6.11 (7439)

Ch20175/Area Scan (51x51x1): Interpolated grid: dx=1.500 mm, dy=1.500 mm
Maximum value of SAR (interpolated) = 0.553 W/kg

Ch20175/Zoom Scan (5x5x7)/Cube 0: Measurement grid: dx=8mm, dy=8mm, dz=5mm
Reference Value = 21.77 V/m; Power Drift = -0.03 dB
Peak SAR (extrapolated) = 0.759 W/kg
SAR(1 g) = 0.564 W/kg; SAR(10 g) = 0.334 W/kg
Maximum value of SAR (measured) = 0.658 W/kg

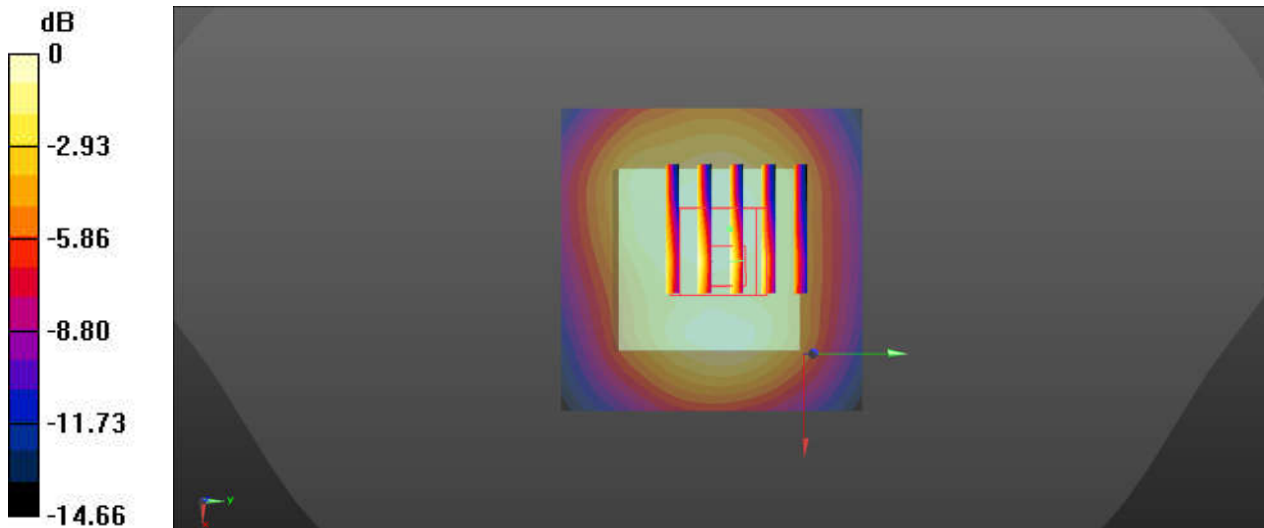

0 dB = 0.553 W/kg = -2.57 dBW/kg

04_LTE Band 2_20M_QPSK_1RB_0Offset_Next to Mouth_10mm_Ch19100

Communication System: UID 0, LTE-FDD (0); Frequency: 1900 MHz; Duty Cycle: 1:1
Medium: HSL_1900 Medium parameters used: $f = 1900$ MHz; $\sigma = 1.423$ S/m; $\epsilon_r = 38.836$; $\rho = 1000$ kg/m³
Ambient Temperature : 23.5 °C ; Liquid Temperature : 22.8 °C

DASY5 Configuration:

- Probe: ES3DV3 - SN3279; ConvF(5.35, 5.35, 5.35); Calibrated: 2019.3.4
- Sensor-Surface: 3mm (Mechanical Surface Detection)
- Electronics: DAE4 Sn1279; Calibrated: 2018.10.22
- Phantom: SAM1; Type: SAM; Serial: TP-1697
- Measurement SW: DASY52, Version 52.10 (1); SEMCAD X Version 14.6.11 (7439)

Ch19100/Area Scan (51x51x1): Interpolated grid: dx=1.500 mm, dy=1.500 mm
Maximum value of SAR (interpolated) = 0.477 W/kg

Ch19100/Zoom Scan (5x5x7)/Cube 0: Measurement grid: dx=8mm, dy=8mm, dz=5mm
Reference Value = 20.72 V/m; Power Drift = -0.08 dB
Peak SAR (extrapolated) = 0.960 W/kg
SAR(1 g) = 0.644 W/kg; SAR(10 g) = 0.366 W/kg
Maximum value of SAR (measured) = 0.777 W/kg

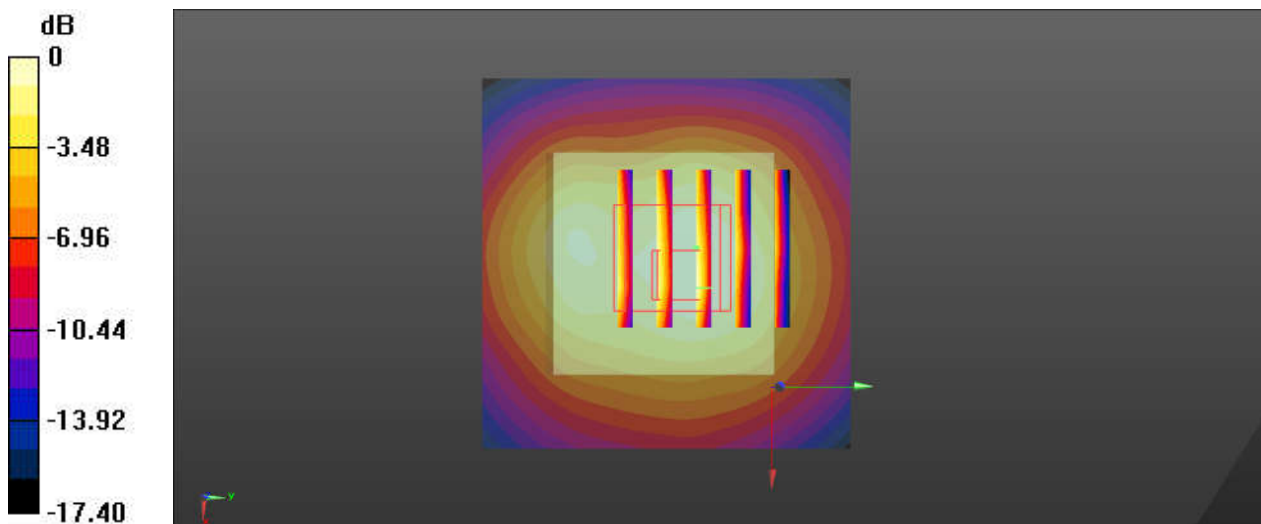

0 dB = 0.777 W/kg = -1.10 dBW/kg

05_LTE Band 7_20M_QPSK_1RB_49Offset_Next to Mouth_10mm_Ch21100

Communication System: UID 0, LTE-FDD (0); Frequency: 2535 MHz; Duty Cycle: 1:1
 Medium: HSL_2600 Medium parameters used: $f = 2535$ MHz; $\sigma = 1.969$ S/m; $\epsilon_r = 38.504$; $\rho = 1000$ kg/m³
 Ambient Temperature : 23.4 °C ; Liquid Temperature : 22.7 °C

DASY5 Configuration:

- Probe: ES3DV3 - SN3279; ConvF(4.58, 4.58, 4.58); Calibrated: 2019.3.4
- Sensor-Surface: 3mm (Mechanical Surface Detection)
- Electronics: DAE4 Sn1279; Calibrated: 2018.10.22
- Phantom: SAM1; Type: SAM; Serial: TP-1697
- Measurement SW: DASY52, Version 52.10 (1); SEMCAD X Version 14.6.11 (7439)

Ch21100/Area Scan (61x61x1): Interpolated grid: dx=1.200 mm, dy=1.200 mm
 Maximum value of SAR (interpolated) = 0.886 W/kg

Ch21100/Zoom Scan (7x7x7)/Cube 0: Measurement grid: dx=5mm, dy=5mm, dz=5mm
 Reference Value = 18.82 V/m; Power Drift = 0.01 dB
 Peak SAR (extrapolated) = 1.28 W/kg
SAR(1 g) = 0.763 W/kg; SAR(10 g) = 0.390 W/kg
 Maximum value of SAR (measured) = 0.939 W/kg

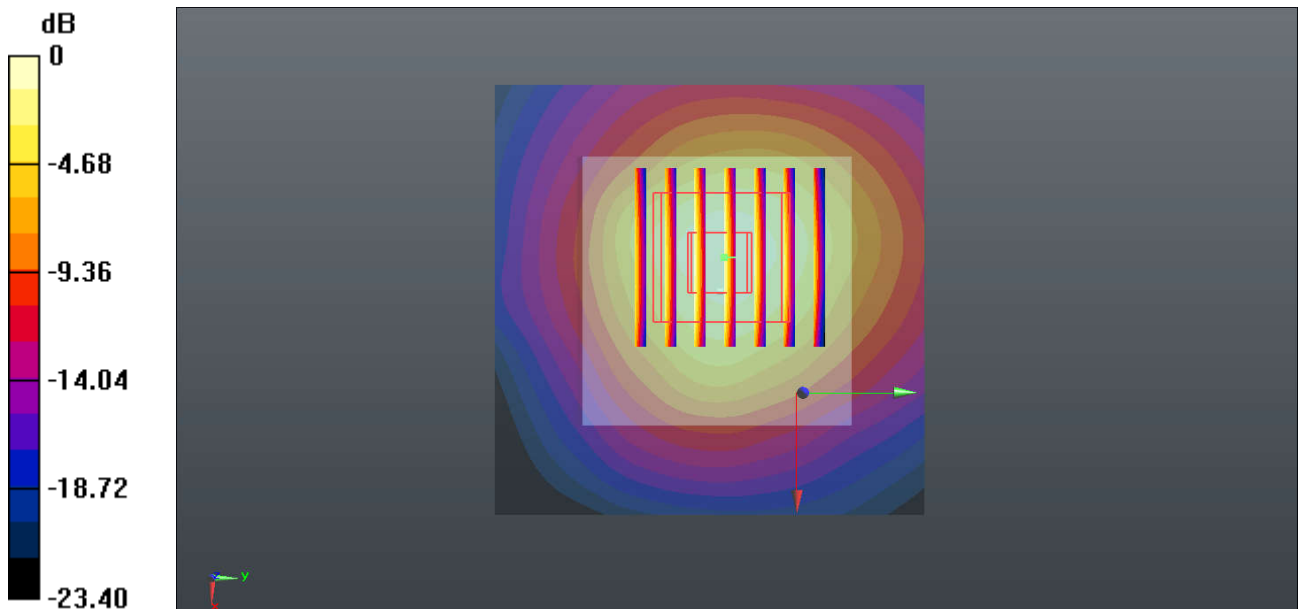

0 dB = 0.939 W/kg = -0.27 dBW/kg

06_WLAN2.4GHz_802.11b 1Mbps_Next to Mouth_10mm_Ch6

Communication System: UID 0, 802.11b (0); Frequency: 2437 MHz; Duty Cycle: 1:1.025
Medium: HSL_2450 Medium parameters used: $f = 2437$ MHz; $\sigma = 1.853$ S/m; $\epsilon_r = 38.948$; $\rho = 1000$ kg/m³
Ambient Temperature : 23.3 °C ; Liquid Temperature : 22.7 °C

DASY5 Configuration:

- Probe: ES3DV3 - SN3279; ConvF(4.77, 4.77, 4.77); Calibrated: 2019.3.4
- Sensor-Surface: 3mm (Mechanical Surface Detection)
- Electronics: DAE4 Sn1279; Calibrated: 2018.10.22
- Phantom: SAM1; Type: SAM; Serial: TP-1697
- Measurement SW: DASY52, Version 52.10 (1); SEMCAD X Version 14.6.11 (7439)

Ch6/Area Scan (61x61x1): Interpolated grid: dx=1.200 mm, dy=1.200 mm
Maximum value of SAR (interpolated) = 0.165 W/kg

Ch6/Zoom Scan (7x7x7)/Cube 0: Measurement grid: dx=5mm, dy=5mm, dz=5mm
Reference Value = 8.811 V/m; Power Drift = 0.04 dB
Peak SAR (extrapolated) = 0.295 W/kg
SAR(1 g) = 0.154 W/kg; SAR(10 g) = 0.071 W/kg
Maximum value of SAR (measured) = 0.215 W/kg

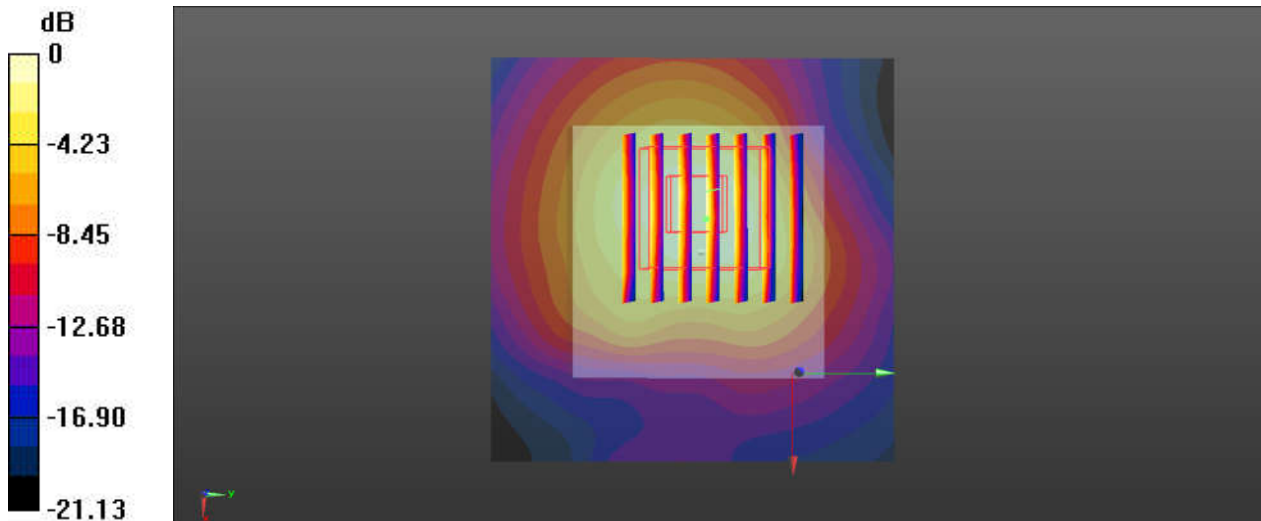

0 dB = 0.215 W/kg = -6.68 dBW/kg

07_LTE Band_13_10M_QPSK_1RB_25Offset_Back_0mm_Ch23230

Communication System: UID 0, LTE-FDD (0); Frequency: 782 MHz; Duty Cycle: 1:1
Medium: HSL_750 Medium parameters used: $f = 782 \text{ MHz}$; $\sigma = 0.909 \text{ S/m}$; $\epsilon_r = 42.788$; $\rho = 1000 \text{ kg/m}^3$
Ambient Temperature : $23.3 \text{ }^\circ\text{C}$; Liquid Temperature : $22.7 \text{ }^\circ\text{C}$

DASY5 Configuration:

- Probe: ES3DV3 - SN3279; ConvF(6.58, 6.58, 6.58); Calibrated: 2019.3.4
- Sensor-Surface: 3mm (Mechanical Surface Detection)
- Electronics: DAE4 Sn1279; Calibrated: 2018.10.22
- Phantom: SAM1; Type: SAM; Serial: TP-1697
- Measurement SW: DASY52, Version 52.10 (1); SEMCAD X Version 14.6.11 (7439)

Ch23230/Area Scan (51x51x1): Interpolated grid: $dx=1.500 \text{ mm}$, $dy=1.500 \text{ mm}$
Maximum value of SAR (interpolated) = 0.423 W/kg

Ch23230/Zoom Scan (5x5x7)/Cube 0: Measurement grid: $dx=8\text{mm}$, $dy=8\text{mm}$, $dz=5\text{mm}$
Reference Value = 22.79 V/m ; Power Drift = 0.06 dB
Peak SAR (extrapolated) = 0.919 W/kg
SAR(1 g) = 0.455 W/kg ; SAR(10 g) = 0.215 W/kg
Maximum value of SAR (measured) = 0.530 W/kg

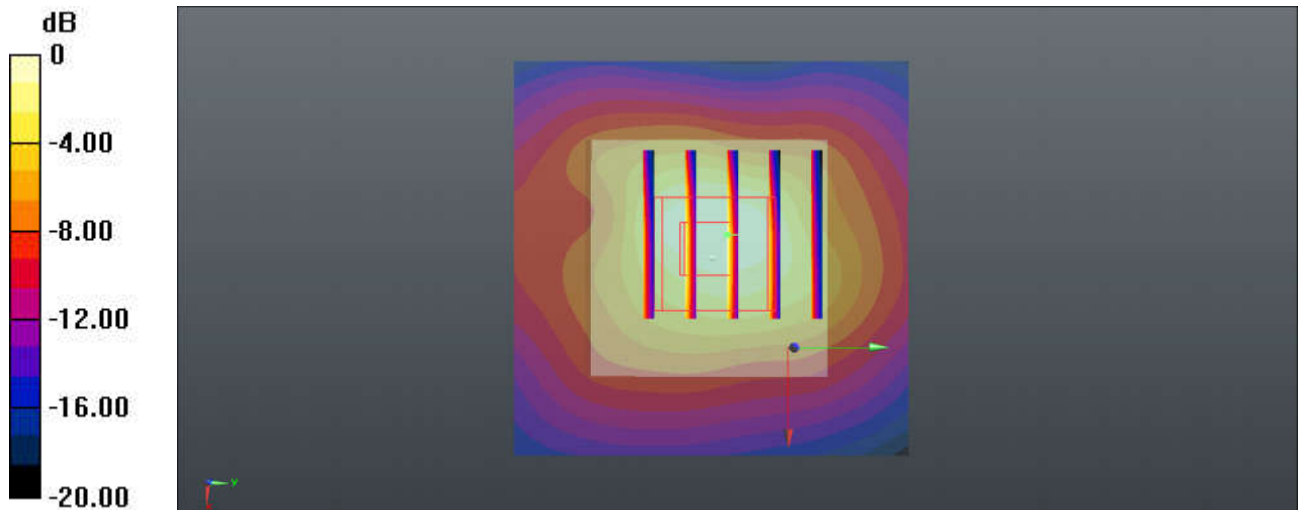

0 dB = $0.530 \text{ W/kg} = -2.76 \text{ dBW/kg}$

08_LTE Band 5_10M_QPSK_1RB_25Offset_Back_0mm_Ch20525

Communication System: UID 0, LTE-FDD (0); Frequency: 836.5 MHz; Duty Cycle: 1:1
Medium: HSL_ 835 Medium parameters used: $f = 836.5$ MHz; $\sigma = 0.915$ S/m; $\epsilon_r = 41.619$; $\rho = 1000$ kg/m³
Ambient Temperature : 23.3 °C; Liquid Temperature : 22.7 °C

DASY5 Configuration:

- Probe: ES3DV3 - SN3279; ConvF(6.38, 6.38, 6.38); Calibrated: 2019.3.4
- Sensor-Surface: 3mm (Mechanical Surface Detection)
- Electronics: DAE4 Sn1279; Calibrated: 2018.10.22
- Phantom: SAM1; Type: SAM; Serial: TP-1697
- Measurement SW: DASY52, Version 52.10 (1); SEMCAD X Version 14.6.11 (7439)

Ch20525/Area Scan (51x51x1): Interpolated grid: dx=1.500 mm, dy=1.500 mm
Maximum value of SAR (interpolated) = 0.431 W/kg

Ch20525/Zoom Scan (5x5x7)/Cube 0: Measurement grid: dx=8mm, dy=8mm, dz=5mm
Reference Value = 22.63 V/m; Power Drift = -0.07 dB
Peak SAR (extrapolated) = 0.735 W/kg
SAR(1 g) = 0.378 W/kg; SAR(10 g) = 0.177 W/kg
Maximum value of SAR (measured) = 0.433 W/kg

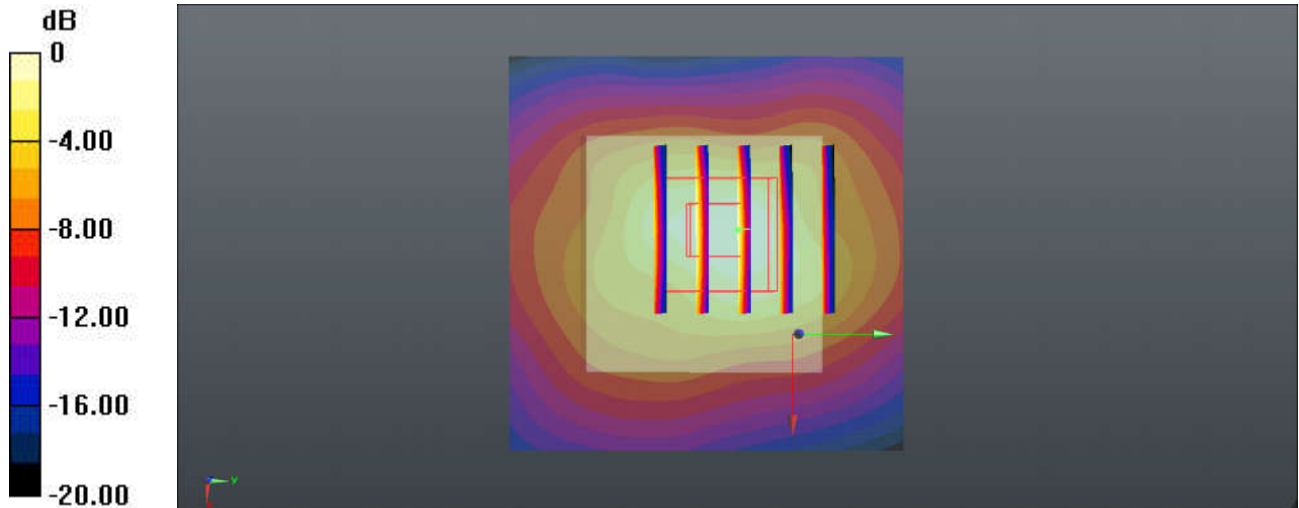

0 dB = 0.433 W/kg = -3.64 dBW/kg

09_LTE Band 4_20M_QPSK_1RB_49Offset_Back_0mm_Ch20175

Communication System: UID 0, LTE-FDD (0); Frequency: 1732.5 MHz; Duty Cycle: 1:1
Medium: HSL_1750 Medium parameters used: $f = 1732.5$ MHz; $\sigma = 1.308$ S/m; $\epsilon_r = 41.893$; $\rho = 1000$ kg/m³
Ambient Temperature : 23.3 °C ; Liquid Temperature : 22.6 °C

DASY5 Configuration:

- Probe: ES3DV3 - SN3279; ConvF(5.59, 5.59, 5.59); Calibrated: 2019.3.4
- Sensor-Surface: 3mm (Mechanical Surface Detection)
- Electronics: DAE4 Sn1279; Calibrated: 2018.10.22
- Phantom: SAM1; Type: SAM; Serial: TP-1697
- Measurement SW: DASY52, Version 52.10 (1); SEMCAD X Version 14.6.11 (7439)

Ch20175/Area Scan (51x51x1): Interpolated grid: dx=1.500 mm, dy=1.500 mm
Maximum value of SAR (interpolated) = 1.41 W/kg

Ch20175/Zoom Scan (5x5x7)/Cube 0: Measurement grid: dx=8mm, dy=8mm, dz=5mm
Reference Value = 55.93 V/m; Power Drift = -0.13 dB
Peak SAR (extrapolated) = 4.89 W/kg
SAR(1 g) = 3.4 W/kg; SAR(10 g) = 1.66 W/kg
Maximum value of SAR (measured) = 3.97 W/kg

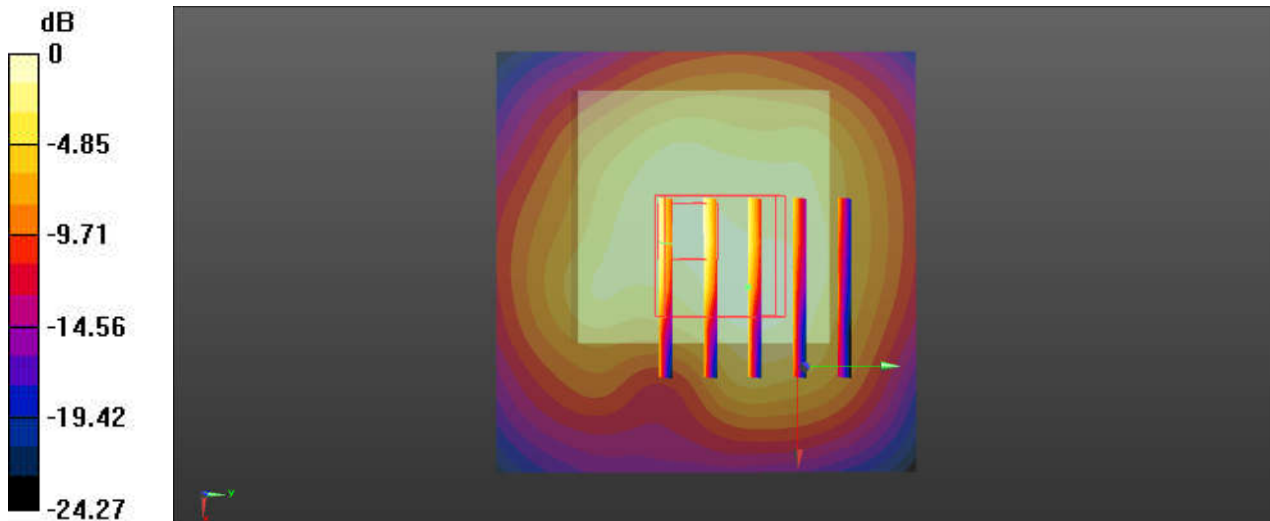

0 dB = 3.97 W/kg = 5.99 dBW/kg

10_LTE Band 2_20M_QPSK_1RB_0Offset_Back_0mm_Ch19100

Communication System: UID 0, LTE-FDD (0); Frequency: 1900 MHz; Duty Cycle: 1:1
Medium: HSL_1900 Medium parameters used: $f = 1900$ MHz; $\sigma = 1.423$ S/m; $\epsilon_r = 38.836$; $\rho = 1000$ kg/m³
Ambient Temperature : 23.5 °C ; Liquid Temperature : 22.8 °C

DASY5 Configuration:

- Probe: ES3DV3 - SN3279; ConvF(5.35, 5.35, 5.35); Calibrated: 2019.3.4
- Sensor-Surface: 3mm (Mechanical Surface Detection)
- Electronics: DAE4 Sn1279; Calibrated: 2018.10.22
- Phantom: SAM1; Type: SAM; Serial: TP-1697
- Measurement SW: DASY52, Version 52.10 (1); SEMCAD X Version 14.6.11 (7439)

Ch19100/Area Scan (51x51x1): Interpolated grid: dx=1.500 mm, dy=1.500 mm
Maximum value of SAR (interpolated) = 2.10 W/kg

Ch19100/Zoom Scan (6x6x7)/Cube 0: Measurement grid: dx=8mm, dy=8mm, dz=5mm
Reference Value = 51.39 V/m; Power Drift = -0.02 dB
Peak SAR (extrapolated) = 2.97 W/kg
SAR(1 g) = 1.74 W/kg; SAR(10 g) = 0.881 W/kg
Maximum value of SAR (measured) = 2.26 W/kg

Ch19100/Zoom Scan (6x6x7)/Cube 1: Measurement grid: dx=8mm, dy=8mm, dz=5mm
Reference Value = 51.39 V/m; Power Drift = -0.02 dB
Peak SAR (extrapolated) = 3.46 W/kg
SAR(1 g) = 1.41 W/kg; SAR(10 g) = 0.649 W/kg
Maximum value of SAR (measured) = 2.66 W/kg

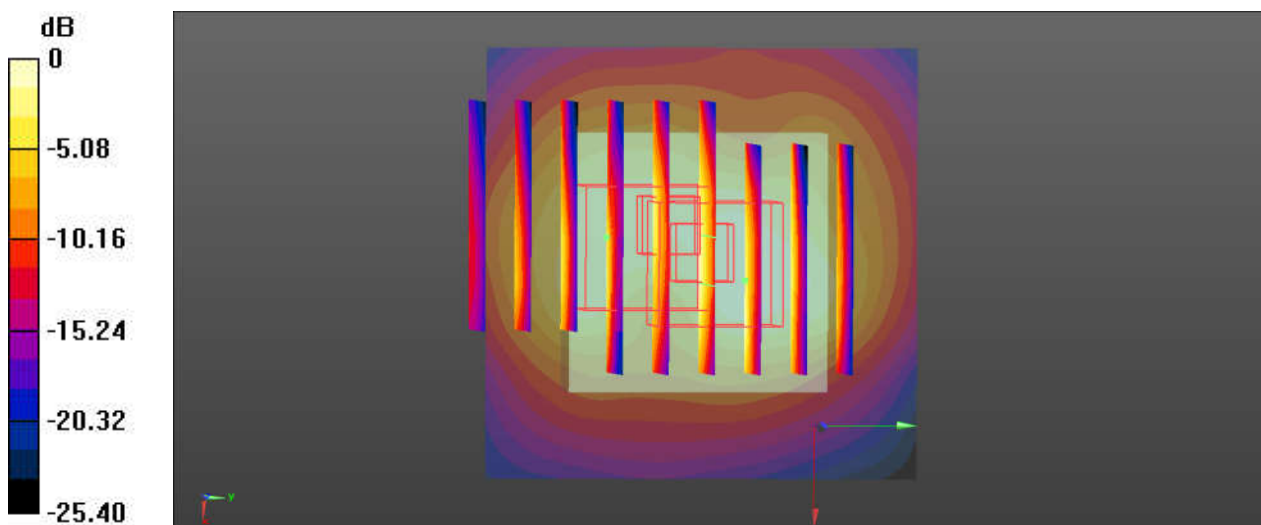

0 dB = 2.66 W/kg = 4.25 dBW/kg

11_LTE Band 7_20M_QPSK_1RB_49Offset_Back_0mm_Ch21100

Communication System: UID 0, LTE-FDD (0); Frequency: 2535 MHz; Duty Cycle: 1:1
Medium: HSL_2600 Medium parameters used: $f = 2535$ MHz; $\sigma = 1.969$ S/m; $\epsilon_r = 38.504$; $\rho = 1000$ kg/m³
Ambient Temperature : 23.4 °C ; Liquid Temperature : 22.7 °C

DASY5 Configuration:

- Probe: ES3DV3 - SN3279; ConvF(4.58, 4.58, 4.58); Calibrated: 2019.3.4
- Sensor-Surface: 3mm (Mechanical Surface Detection)
- Electronics: DAE4 Sn1279; Calibrated: 2018.10.22
- Phantom: SAM1; Type: SAM; Serial: TP-1697
- Measurement SW: DASY52, Version 52.10 (1); SEMCAD X Version 14.6.11 (7439)

Ch21100/Area Scan (61x61x1): Interpolated grid: dx=1.200 mm, dy=1.200 mm
Maximum value of SAR (interpolated) = 2.99 W/kg

Ch21100/Zoom Scan (7x7x7)/Cube 0: Measurement grid: dx=5mm, dy=5mm, dz=5mm
Reference Value = 26.76 V/m; Power Drift = 0.01 dB
Peak SAR (extrapolated) = 3.35 W/kg
SAR(1 g) = 1.83 W/kg; SAR(10 g) = 0.951 W/kg
Maximum value of SAR (measured) = 2.36 W/kg

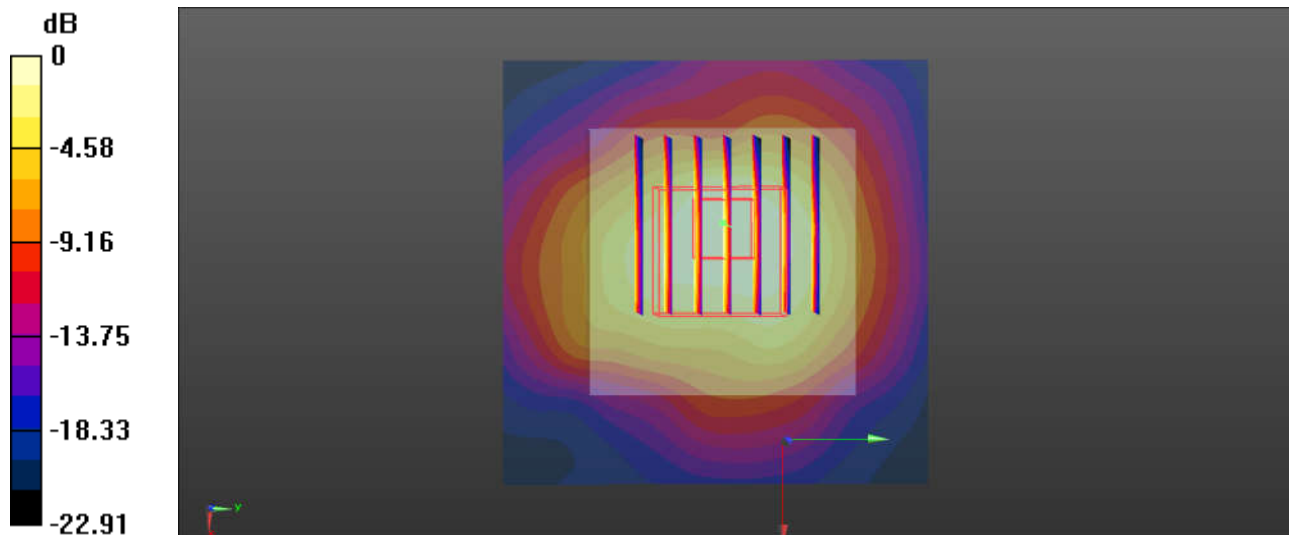

0 dB = 2.36 W/kg = 3.73 dBW/kg

12_WLAN2.4GHz_802.11b 1Mbps_Back_0mm_Ch6

Communication System: UID 0, 802.11b (0); Frequency: 2437 MHz; Duty Cycle: 1:1.025
Medium: HSL_2450 Medium parameters used: $f = 2437$ MHz; $\sigma = 1.853$ S/m; $\epsilon_r = 38.948$; $\rho = 1000$ kg/m³
Ambient Temperature : 23.3 °C ; Liquid Temperature : 22.7 °C

DASY5 Configuration:

- Probe: ES3DV3 - SN3279; ConvF(4.77, 4.77, 4.77); Calibrated: 2019.3.4
- Sensor-Surface: 3mm (Mechanical Surface Detection)
- Electronics: DAE4 Sn1279; Calibrated: 2018.10.22
- Phantom: SAM1; Type: SAM; Serial: TP-1697
- Measurement SW: DASY52, Version 52.10 (1); SEMCAD X Version 14.6.11 (7439)

Ch6/Area Scan (61x61x1): Interpolated grid: dx=1.200 mm, dy=1.200 mm
Maximum value of SAR (interpolated) = 0.652 W/kg

Ch6/Zoom Scan (7x7x7)/Cube 0: Measurement grid: dx=5mm, dy=5mm, dz=5mm
Reference Value = 16.16 V/m; Power Drift = -0.02 dB
Peak SAR (extrapolated) = 1.31 W/kg
SAR(1 g) = 0.405 W/kg; SAR(10 g) = 0.172 W/kg
Maximum value of SAR (measured) = 0.856 W/kg

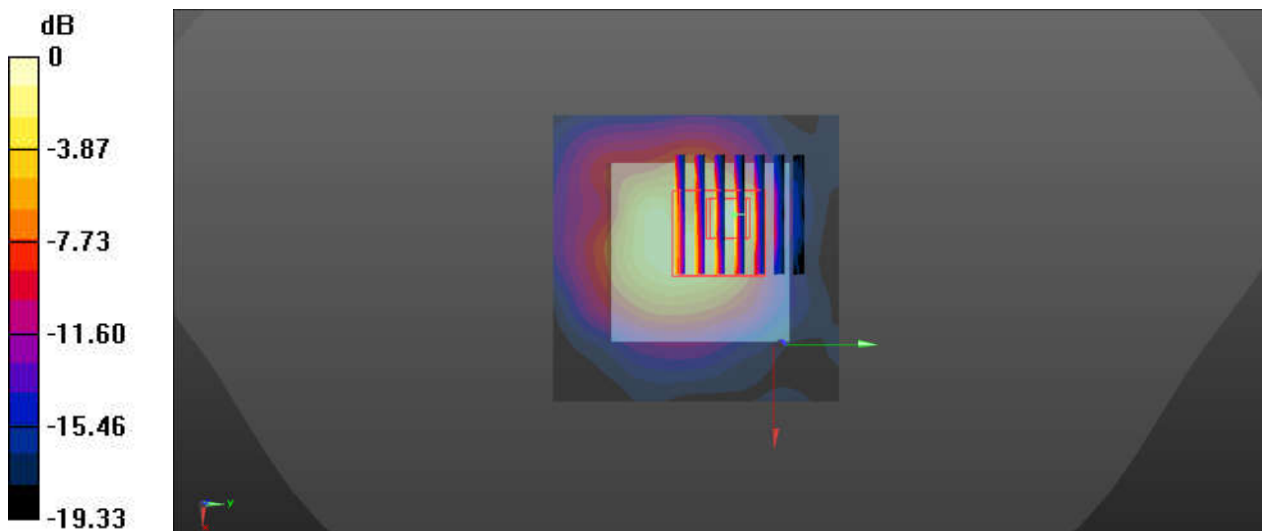

0 dB = 0.856 W/kg = -0.68 dBW/kg



Appendix C. DAS Y Calibration Certificate

The DAS Y calibration certificates are shown as follows.



In Collaboration with
s p e a g
CALIBRATION LABORATORY



中国认可
国际互认
校准
CALIBRATION
CNAS L0570

Add: No.51 Xueyuan Road, Haidian District, Beijing, 100191, China
Tel: +86-10-62304633-2079 Fax: +86-10-62304633-2504
E-mail: cttl@chinattl.com http://www.chinattl.cn

Client **Sporton**

Certificate No: **Z19-60081**

CALIBRATION CERTIFICATE

Object: **D750V3 - SN: 1087**

Calibration Procedure(s): **FF-Z11-003-01**
Calibration Procedures for dipole validation kits

Calibration date: **March 27, 2019**

This calibration Certificate documents the traceability to national standards, which realize the physical units of measurements(SI). The measurements and the uncertainties with confidence probability are given on the following pages and are part of the certificate.

All calibrations have been conducted in the closed laboratory facility: environment temperature(22±3)°C and humidity<70%.

Calibration Equipment used (M&TE critical for calibration)

Primary Standards	ID #	Cal Date(Calibrated by, Certificate No.)	Scheduled Calibration
Power Meter NRP2	106277	20-Aug-18 (CTTL, No.J18X06862)	Aug-19
Power sensor NRP8S	104291	20-Aug-18 (CTTL, No.J18X06862)	Aug-19
Reference Probe EX3DV4	SN 3617	31-Jan-19(SPEAG,No.EX3-3617_Jan19)	Jan-20
DAE4	SN 1331	06-Feb-19(SPEAG,No.DAE4-1331_Feb19)	Feb-20
Secondary Standards	ID #	Cal Date(Calibrated by, Certificate No.)	Scheduled Calibration
Signal Generator E4438C	MY49071430	23-Jan-19 (CTTL, No.J19X00336)	Jan-20
NetworkAnalyzer E5071C	MY46110673	24-Jan-19 (CTTL, No.J19X00547)	Jan-20

	Name	Function	Signature
Calibrated by:	Zhao Jing	SAR Test Engineer	
Reviewed by:	Lin Hao	SAR Test Engineer	
Approved by:	Qi Dianyuan	SAR Project Leader	

Issued: March 29, 2019

This calibration certificate shall not be reproduced except in full without written approval of the laboratory.



In Collaboration with

s p e a g
CALIBRATION LABORATORY

Add: No.51 Xueyuan Road, Haidian District, Beijing, 100191, China
Tel: +86-10-62304633-2079 Fax: +86-10-62304633-2504
E-mail: cttl@chinattl.com http://www.chinattl.cn

Glossary:

TSL	tissue simulating liquid
ConvF	sensitivity in TSL / NORM _{x,y,z}
N/A	not applicable or not measured

Calibration is Performed According to the Following Standards:

- IEEE Std 1528-2013, "IEEE Recommended Practice for Determining the Peak Spatial-Averaged Specific Absorption Rate (SAR) in the Human Head from Wireless Communications Devices: Measurement Techniques", June 2013
- IEC 62209-1, "Measurement procedure for assessment of specific absorption rate of human exposure to radio frequency fields from hand-held and body-mounted wireless communication devices- Part 1: Device used next to the ear (Frequency range of 300MHz to 6GHz)", July 2016
- IEC 62209-2, "Procedure to measure the Specific Absorption Rate (SAR) For wireless communication devices used in close proximity to the human body (frequency range of 30MHz to 6GHz)", March 2010
- KDB865664, SAR Measurement Requirements for 100 MHz to 6 GHz

Additional Documentation:

- DASY4/5 System Handbook

Methods Applied and Interpretation of Parameters:

- Measurement Conditions:** Further details are available from the Validation Report at the end of the certificate. All figures stated in the certificate are valid at the frequency indicated.
- Antenna Parameters with TSL:** The dipole is mounted with the spacer to position its feed point exactly below the center marking of the flat phantom section, with the arms oriented parallel to the body axis.
- Feed Point Impedance and Return Loss:** These parameters are measured with the dipole positioned under the liquid filled phantom. The impedance stated is transformed from the measurement at the SMA connector to the feed point. The Return Loss ensures low reflected power. No uncertainty required.
- Electrical Delay:** One-way delay between the SMA connector and the antenna feed point. No uncertainty required.
- SAR measured:** SAR measured at the stated antenna input power.
- SAR normalized:** SAR as measured, normalized to an input power of 1 W at the antenna connector.
- SAR for nominal TSL parameters:** The measured TSL parameters are used to calculate the nominal SAR result.

The reported uncertainty of measurement is stated as the standard uncertainty of Measurement multiplied by the coverage factor $k=2$, which for a normal distribution Corresponds to a coverage probability of approximately 95%.



Add: No.51 Xueyuan Road, Haidian District, Beijing, 100191, China
Tel: +86-10-62304633-2079 Fax: +86-10-62304633-2504
E-mail: cttl@chinattl.com http://www.chinattl.cn

Measurement Conditions

DASY system configuration, as far as not given on page 1.

DASY Version	DASY52	52.10.2.1495
Extrapolation	Advanced Extrapolation	
Phantom	Triple Flat Phantom 5.1C	
Distance Dipole Center - TSL	15 mm	with Spacer
Zoom Scan Resolution	dx, dy, dz = 5 mm	
Frequency	750 MHz ± 1 MHz	

Head TSL parameters

The following parameters and calculations were applied.

	Temperature	Permittivity	Conductivity
Nominal Head TSL parameters	22.0 °C	41.9	0.89 mho/m
Measured Head TSL parameters	(22.0 ± 0.2) °C	43.0 ± 6 %	0.90 mho/m ± 6 %
Head TSL temperature change during test	<1.0 °C	----	----

SAR result with Head TSL

SAR averaged over 1 cm ³ (1 g) of Head TSL	Condition	
SAR measured	250 mW input power	2.10 W/kg
SAR for nominal Head TSL parameters	normalized to 1W	8.36 W/kg ± 18.8 % (k=2)
SAR averaged over 10 cm ³ (10 g) of Head TSL	Condition	
SAR measured	250 mW input power	1.42 W/kg
SAR for nominal Head TSL parameters	normalized to 1W	5.65 W/kg ± 18.7 % (k=2)

Body TSL parameters

The following parameters and calculations were applied.

	Temperature	Permittivity	Conductivity
Nominal Body TSL parameters	22.0 °C	55.5	0.96 mho/m
Measured Body TSL parameters	(22.0 ± 0.2) °C	56.9 ± 6 %	0.94 mho/m ± 6 %
Body TSL temperature change during test	<1.0 °C	----	----

SAR result with Body TSL

SAR averaged over 1 cm ³ (1 g) of Body TSL	Condition	
SAR measured	250 mW input power	2.09 W/kg
SAR for nominal Body TSL parameters	normalized to 1W	8.58 W/kg ± 18.8 % (k=2)
SAR averaged over 10 cm ³ (10 g) of Body TSL	Condition	
SAR measured	250 mW input power	1.41 W/kg
SAR for nominal Body TSL parameters	normalized to 1W	5.75 W/kg ± 18.7 % (k=2)



Add: No.51 Xueyuan Road, Haidian District, Beijing, 100191, China
Tel: +86-10-62304633-2079 Fax: +86-10-62304633-2504
E-mail: cttl@chinattl.com http://www.chinattl.cn

Appendix (Additional assessments outside the scope of CNAS L0570)

Antenna Parameters with Head TSL

Impedance, transformed to feed point	52.4Ω- 2.59jΩ
Return Loss	- 29.3dB

Antenna Parameters with Body TSL

Impedance, transformed to feed point	51.6Ω- 3.86jΩ
Return Loss	- 27.7dB

General Antenna Parameters and Design

Electrical Delay (one direction)	0.898 ns
----------------------------------	----------

After long term use with 100W radiated power, only a slight warming of the dipole near the feedpoint can be measured.

The dipole is made of standard semirigid coaxial cable. The center conductor of the feeding line is directly connected to the second arm of the dipole. The antenna is therefore short-circuited for DC-signals. On some of the dipoles, small end caps are added to the dipole arms in order to improve matching when loaded according to the position as explained in the "Measurement Conditions" paragraph. The SAR data are not affected by this change. The overall dipole length is still according to the Standard.

No excessive force must be applied to the dipole arms, because they might bend or the soldered connections near the feedpoint may be damaged.

Additional EUT Data

Manufactured by	SPEAG
-----------------	-------



Add: No.51 Xueyuan Road, Haidian District, Beijing, 100191, China
Tel: +86-10-62304633-2079 Fax: +86-10-62304633-2504
E-mail: cttl@chinattl.com http://www.chinattl.cn

DASY5 Validation Report for Head TSL

Date: 03.26.2019

Test Laboratory: CTTL, Beijing, China

DUT: Dipole 750 MHz; Type: D750V3; Serial: D750V3 - SN: 1087

Communication System: UID 0, CW; Frequency: 750 MHz; Duty Cycle: 1:1

Medium parameters used: $f = 750$ MHz; $\sigma = 0.903$ S/m; $\epsilon_r = 43.01$; $\rho = 1000$ kg/m³

Phantom section: Right Section

DASY5 Configuration:

- Probe: EX3DV4 - SN3617; ConvF(10.03, 10.03, 10.03) @ 750 MHz; Calibrated: 1/31/2019
- Sensor-Surface: 1.4mm (Mechanical Surface Detection)
- Electronics: DAE4 Sn1331; Calibrated: 2/6/2019
- Phantom: MFP_V5.1C ; Type: QD 000 P51CA; Serial: 1062
- Measurement SW: DASY52, Version 52.10 (2); SEMCAD X Version 14.6.12 (7450)

Dipole Calibration/Zoom Scan (7x7x7) (7x7x7)/Cube 0: Measurement grid: dx=5mm, dy=5mm, dz=5mm

Reference Value = 55.05 V/m; Power Drift = 0.01 dB

Peak SAR (extrapolated) = 3.00 W/kg

SAR(1 g) = 2.1 W/kg; SAR(10 g) = 1.42 W/kg

Maximum value of SAR (measured) = 2.72 W/kg

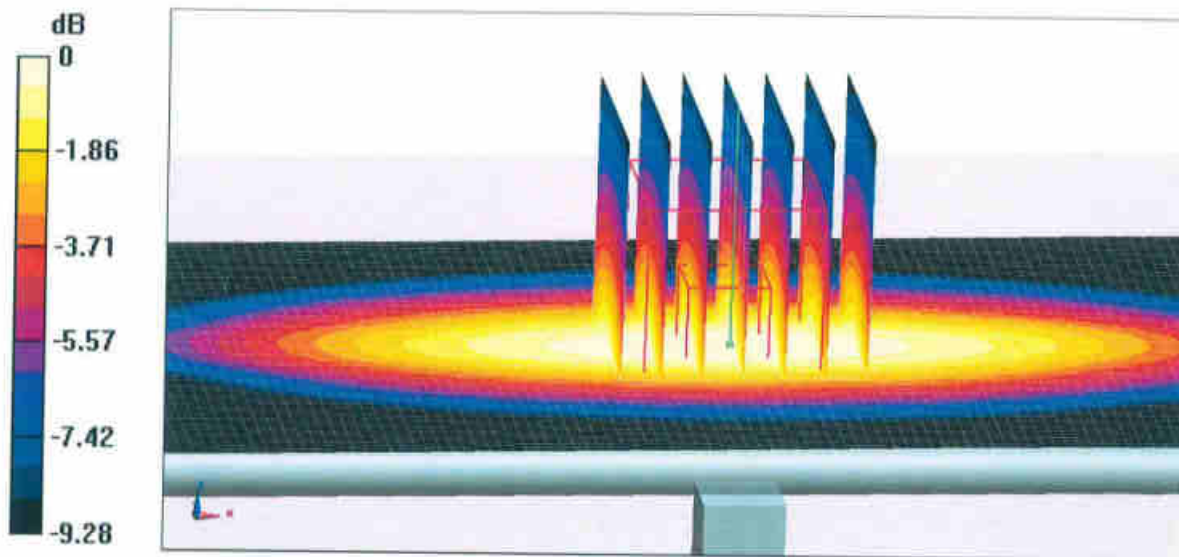

0 dB = 2.72 W/kg = 4.35 dBW/kg



Add: No.51 Xueyuan Road, Haidian District, Beijing, 100191, China
Tel: +86-10-62304633-2079 Fax: +86-10-62304633-2504
E-mail: cttl@chinattl.com http://www.chinattl.cn

Impedance Measurement Plot for Head TSL

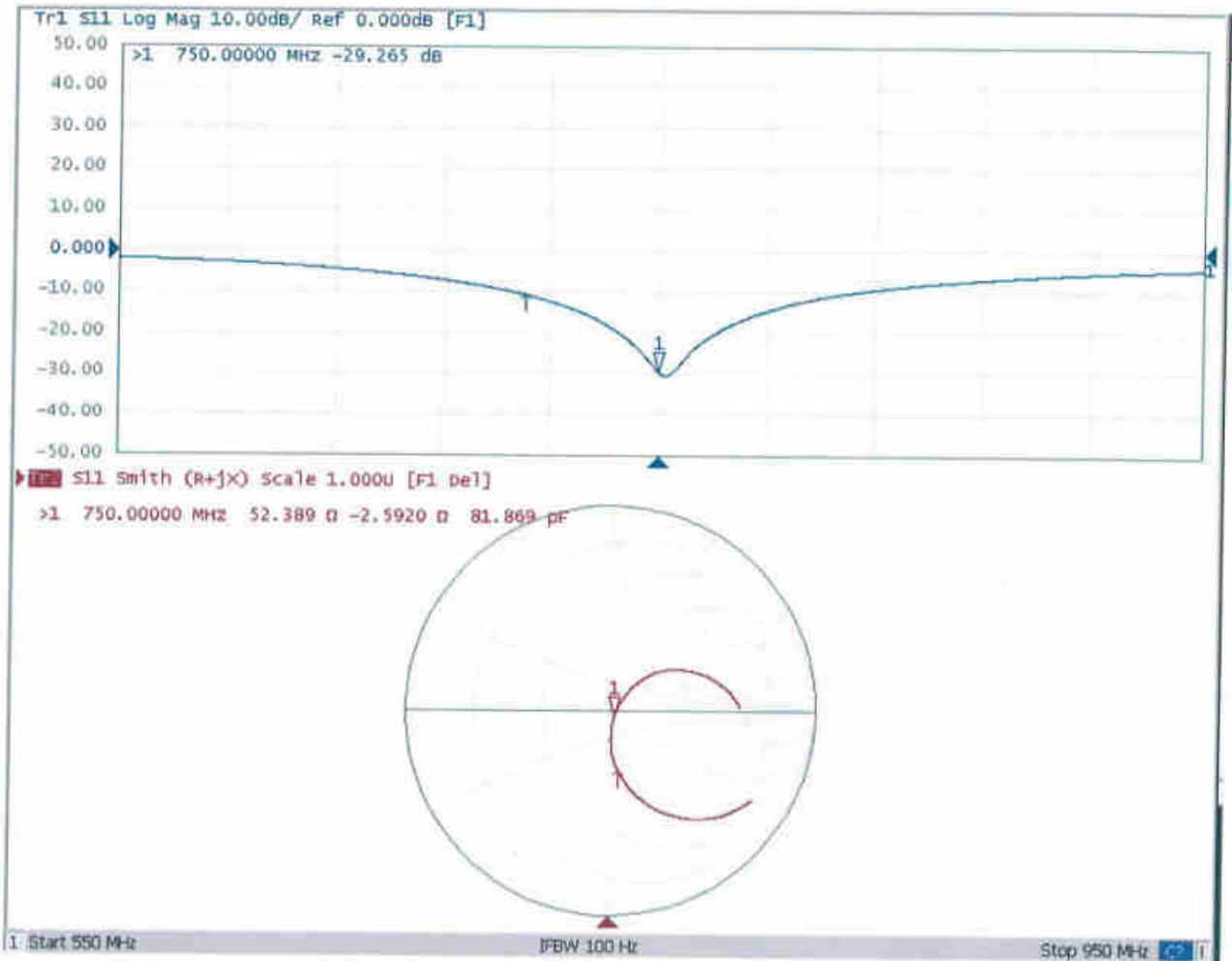



Add: No.51 Xueyuan Road, Haidian District, Beijing, 100191, China
Tel: +86-10-62304633-2079 Fax: +86-10-62304633-2504
E-mail: cttl@chinattl.com http://www.chinattl.cn

DASY5 Validation Report for Body TSL

Date: 03.26.2019

Test Laboratory: CTTL, Beijing, China

DUT: Dipole 750 MHz; Type: D750V3; Serial: D750V3 - SN: 1087

Communication System: UID 0, CW; Frequency: 750 MHz; Duty Cycle: 1:1

Medium parameters used: $f = 750$ MHz; $\sigma = 0.935$ S/m; $\epsilon_r = 56.85$; $\rho = 1000$ kg/m³

Phantom section: Center Section

DASY5 Configuration:

- Probe: EX3DV4 - SN3617; ConvF(9.85, 9.85, 9.85) @ 750 MHz; Calibrated: 1/31/2019
- Sensor-Surface: 1.4mm (Mechanical Surface Detection)
- Electronics: DAE4 Sn1331; Calibrated: 2/6/2019
- Phantom: MFP_V5.1C ; Type: QD 000 P51CA; Serial: 1062
- Measurement SW: DASY52, Version 52.10 (2); SEMCAD X Version 14.6.12 (7450)

Dipole Calibration/Zoom Scan (7x7x7) (7x7x7)/Cube 0: Measurement grid: dx=5mm, dy=5mm, dz=5mm

Reference Value = 53.71 V/m; Power Drift = 0.01 dB

Peak SAR (extrapolated) = 3.08 W/kg

SAR(1 g) = 2.09 W/kg; SAR(10 g) = 1.41 W/kg

Maximum value of SAR (measured) = 2.75 W/kg

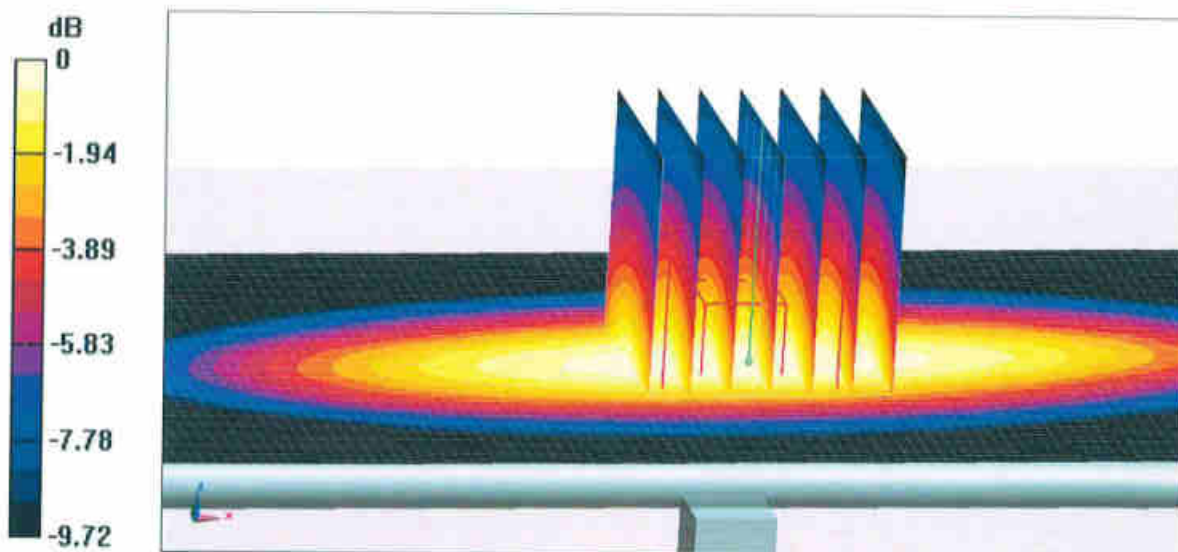

0 dB = 2.75 W/kg = 4.39 dBW/kg



Add: No.51 Xueyuan Road, Haidian District, Beijing, 100191, China
Tel: +86-10-62304633-2079 Fax: +86-10-62304633-2504
E-mail: ettl@chinattl.com http://www.chinattl.cn

Impedance Measurement Plot for Body TSL

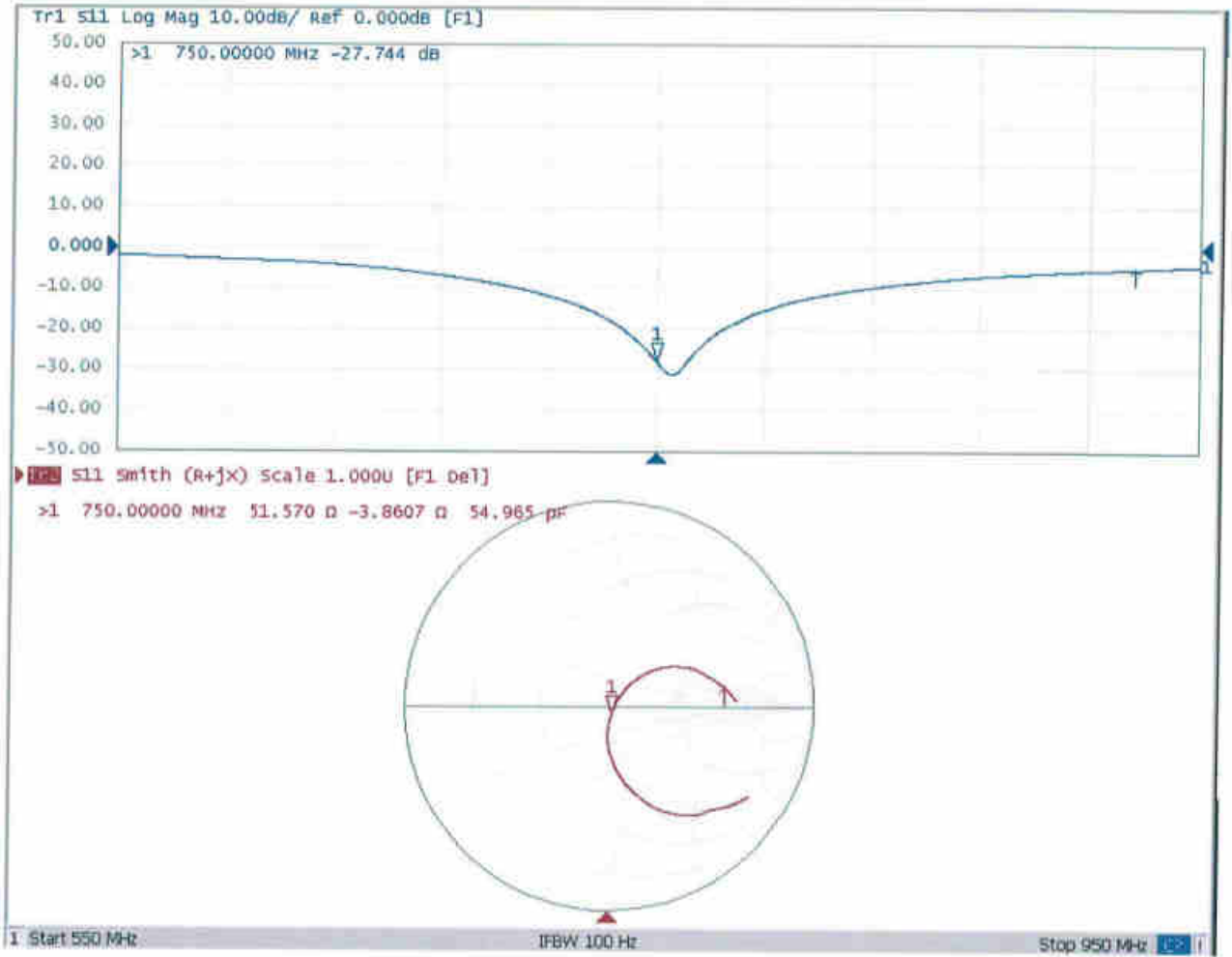



In Collaboration with
s p e a g
 CALIBRATION LABORATORY



中国认可
 国际互认
 校准
 CALIBRATION
 CNAS L0570

Add: No.51 Xueyuan Road, Haidian District, Beijing, 100191, China
 Tel: +86-10-62304633-2079 Fax: +86-10-62304633-2504
 E-mail: cttl@chinattl.com http://www.chinattl.cn

Client

Sporton

Certificate No:

Z19-60082

CALIBRATION CERTIFICATE

Object **D835V2 - SN: 4d151**

Calibration Procedure(s) **FF-Z11-003-01**
Calibration Procedures for dipole validation kits

Calibration date: **March 27, 2019**

This calibration Certificate documents the traceability to national standards, which realize the physical units of measurements(SI). The measurements and the uncertainties with confidence probability are given on the following pages and are part of the certificate.

All calibrations have been conducted in the closed laboratory facility: environment temperature(22±3)°C and humidity<70%.

Calibration Equipment used (M&TE critical for calibration)

Primary Standards	ID #	Cal Date(Calibrated by, Certificate No.)	Scheduled Calibration
Power Meter NRP2	106277	20-Aug-18 (CTTL, No.J18X06862)	Aug-19
Power sensor NRP8S	104291	20-Aug-18 (CTTL, No.J18X06862)	Aug-19
Reference Probe EX3DV4	SN 3617	31-Jan-19(SPEAG,No.EX3-3617_Jan19)	Jan-20
DAE4	SN 1331	06-Feb-19(SPEAG,No.DAE4-1331_Feb19)	Feb-20
Secondary Standards	ID #	Cal Date(Calibrated by, Certificate No.)	Scheduled Calibration
Signal Generator E4438C	MY49071430	23-Jan-19 (CTTL, No.J19X00336)	Jan-20
NetworkAnalyzer E5071C	MY46110673	24-Jan-19 (CTTL, No.J19X00547)	Jan-20

	Name	Function	Signature
Calibrated by:	Zhao Jing	SAR Test Engineer	
Reviewed by:	Lin Hao	SAR Test Engineer	
Approved by:	Qi Dianyuan	SAR Project Leader	

Issued: March 30, 2019

This calibration certificate shall not be reproduced except in full without written approval of the laboratory.



In Collaboration with

s p e a g
CALIBRATION LABORATORY

Add: No.51 Xueyuan Road, Haidian District, Beijing, 100191, China
Tel: +86-10-62304633-2079 Fax: +86-10-62304633-2504
E-mail: cttl@chinattl.com http://www.chinattl.cn

Glossary:

TSL	tissue simulating liquid
ConvF	sensitivity in TSL / NORM _{x,y,z}
N/A	not applicable or not measured

Calibration is Performed According to the Following Standards:

- IEEE Std 1528-2013, "IEEE Recommended Practice for Determining the Peak Spatial-Averaged Specific Absorption Rate (SAR) in the Human Head from Wireless Communications Devices: Measurement Techniques", June 2013
- IEC 62209-1, "Measurement procedure for assessment of specific absorption rate of human exposure to radio frequency fields from hand-held and body-mounted wireless communication devices- Part 1: Device used next to the ear (Frequency range of 300MHz to 6GHz)", July 2016
- IEC 62209-2, "Procedure to measure the Specific Absorption Rate (SAR) For wireless communication devices used in close proximity to the human body (frequency range of 30MHz to 6GHz)", March 2010
- KDB865664, SAR Measurement Requirements for 100 MHz to 6 GHz

Additional Documentation:

- DASY4/5 System Handbook

Methods Applied and Interpretation of Parameters:

- Measurement Conditions:** Further details are available from the Validation Report at the end of the certificate. All figures stated in the certificate are valid at the frequency indicated.
- Antenna Parameters with TSL:** The dipole is mounted with the spacer to position its feed point exactly below the center marking of the flat phantom section, with the arms oriented parallel to the body axis.
- Feed Point Impedance and Return Loss:** These parameters are measured with the dipole positioned under the liquid filled phantom. The impedance stated is transformed from the measurement at the SMA connector to the feed point. The Return Loss ensures low reflected power. No uncertainty required.
- Electrical Delay:** One-way delay between the SMA connector and the antenna feed point. No uncertainty required.
- SAR measured:** SAR measured at the stated antenna input power.
- SAR normalized:** SAR as measured, normalized to an input power of 1 W at the antenna connector.
- SAR for nominal TSL parameters:** The measured TSL parameters are used to calculate the nominal SAR result.

The reported uncertainty of measurement is stated as the standard uncertainty of Measurement multiplied by the coverage factor $k=2$, which for a normal distribution Corresponds to a coverage probability of approximately 95%.



Add: No.51 Xueyuan Road, Haidian District, Beijing, 100191, China
 Tel: +86-10-62304633-2079 Fax: +86-10-62304633-2504
 E-mail: cttl@chinattl.com http://www.chinattl.cn

Measurement Conditions

DASY system configuration, as far as not given on page 1.

DASY Version	DASY52	52.10.2.1495
Extrapolation	Advanced Extrapolation	
Phantom	Triple Flat Phantom 5.1C	
Distance Dipole Center - TSL	15 mm	with Spacer
Zoom Scan Resolution	dx, dy, dz = 5 mm	
Frequency	835 MHz \pm 1 MHz	

Head TSL parameters

The following parameters and calculations were applied.

	Temperature	Permittivity	Conductivity
Nominal Head TSL parameters	22.0 °C	41.5	0.90 mho/m
Measured Head TSL parameters	(22.0 \pm 0.2) °C	42.7 \pm 6 %	0.93 mho/m \pm 6 %
Head TSL temperature change during test	<1.0 °C	----	----

SAR result with Head TSL

SAR averaged over 1 cm^3 (1 g) of Head TSL	Condition	
SAR measured	250 mW input power	2.36 W/kg
SAR for nominal Head TSL parameters	normalized to 1W	9.30 W/kg \pm 18.8 % (k=2)
SAR averaged over 10 cm^3 (10 g) of Head TSL	Condition	
SAR measured	250 mW input power	1.56 W/kg
SAR for nominal Head TSL parameters	normalized to 1W	6.16 W/kg \pm 18.7 % (k=2)

Body TSL parameters

The following parameters and calculations were applied.

	Temperature	Permittivity	Conductivity
Nominal Body TSL parameters	22.0 °C	55.2	0.97 mho/m
Measured Body TSL parameters	(22.0 \pm 0.2) °C	56.7 \pm 6 %	0.94 mho/m \pm 6 %
Body TSL temperature change during test	<1.0 °C	----	----

SAR result with Body TSL

SAR averaged over 1 cm^3 (1 g) of Body TSL	Condition	
SAR measured	250 mW input power	2.32 W/kg
SAR for nominal Body TSL parameters	normalized to 1W	9.53 W /kg \pm 18.8 % (k=2)
SAR averaged over 10 cm^3 (10 g) of Body TSL	Condition	
SAR measured	250 mW input power	1.52 W/kg
SAR for nominal Body TSL parameters	normalized to 1W	6.20 W/kg \pm 18.7 % (k=2)



Add: No.51 Xueyuan Road, Haidian District, Beijing, 100191, China
Tel: +86-10-62304633-2079 Fax: +86-10-62304633-2504
E-mail: cttl@chinattl.com http://www.chinattl.cn

Appendix (Additional assessments outside the scope of CNAS L0570)

Antenna Parameters with Head TSL

Impedance, transformed to feed point	50.8Ω- 3.28jΩ
Return Loss	- 29.5dB

Antenna Parameters with Body TSL

Impedance, transformed to feed point	46.7Ω- 3.98jΩ
Return Loss	- 25.5dB

General Antenna Parameters and Design

Electrical Delay (one direction)	1.253 ns
----------------------------------	----------

After long term use with 100W radiated power, only a slight warming of the dipole near the feedpoint can be measured.

The dipole is made of standard semirigid coaxial cable. The center conductor of the feeding line is directly connected to the second arm of the dipole. The antenna is therefore short-circuited for DC-signals. On some of the dipoles, small end caps are added to the dipole arms in order to improve matching when loaded according to the position as explained in the "Measurement Conditions" paragraph. The SAR data are not affected by this change. The overall dipole length is still according to the Standard.

No excessive force must be applied to the dipole arms, because they might bend or the soldered connections near the feedpoint may be damaged.

Additional EUT Data

Manufactured by	SPEAG
-----------------	-------



Add: No.51 Xueyuan Road, Haidian District, Beijing, 100191, China
Tel: +86-10-62304633-2079 Fax: +86-10-62304633-2504
E-mail: cttl@chinattl.com http://www.chinattl.cn

DASY5 Validation Report for Head TSL

Date: 03.26.2019

Test Laboratory: CTTL, Beijing, China

DUT: Dipole 835 MHz; Type: D835V2; Serial: D835V2 - SN: 4d151

Communication System: UID 0, CW; Frequency: 835 MHz; Duty Cycle: 1:1

Medium parameters used: $f = 835$ MHz; $\sigma = 0.925$ S/m; $\epsilon_r = 42.68$; $\rho = 1000$ kg/m³

Phantom section: Right Section

DASY5 Configuration:

- Probe: EX3DV4 - SN3617; ConvF(9.75, 9.75, 9.75) @ 835 MHz; Calibrated: 1/31/2019
- Sensor-Surface: 1.4mm (Mechanical Surface Detection)
- Electronics: DAE4 Sn1331; Calibrated: 2/6/2019
- Phantom: MFP_V5.1C ; Type: QD 000 P51CA; Serial: 1062
- Measurement SW: DASY52, Version 52.10 (2); SEMCAD X Version 14.6.12 (7450)

Dipole Calibration/Zoom Scan (7x7x7) (7x7x7)/Cube 0: Measurement grid: dx=5mm, dy=5mm, dz=5mm

Reference Value = 57.34 V/m; Power Drift = 0.00 dB

Peak SAR (extrapolated) = 3.55 W/kg

SAR(1 g) = 2.36 W/kg; SAR(10 g) = 1.56 W/kg

Maximum value of SAR (measured) = 3.14 W/kg

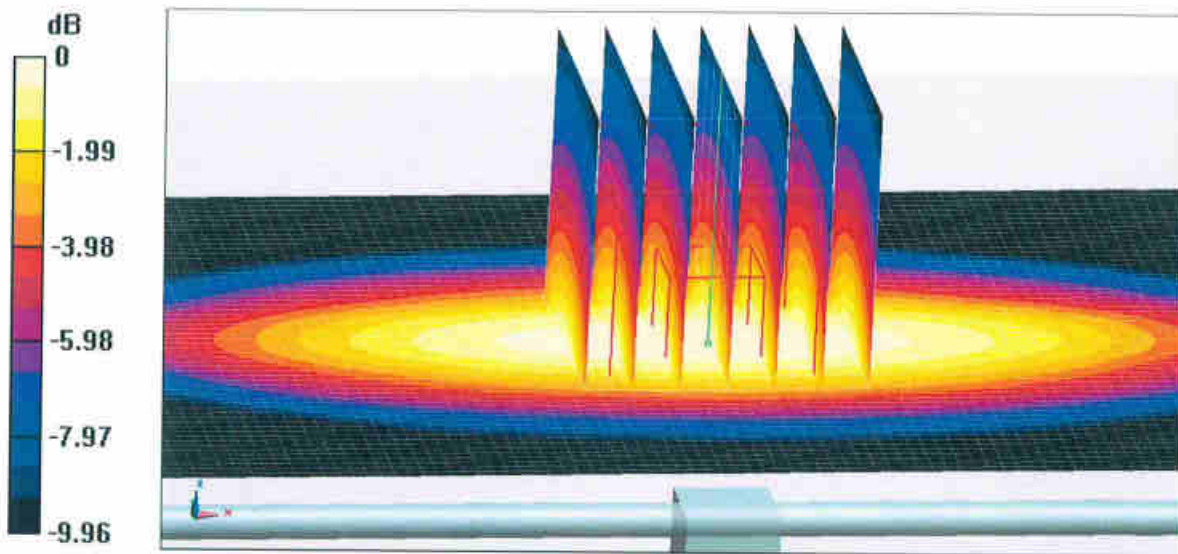

0 dB = 3.14 W/kg = 4.97 dBW/kg



Add: No.51 Xueyuan Road, Haidian District, Beijing, 100191, China.
Tel: +86-10-62304633-2079 Fax: +86-10-62304633-2504
E-mail: cttl@chinattl.com http://www.chinattl.cn

Impedance Measurement Plot for Head TSL

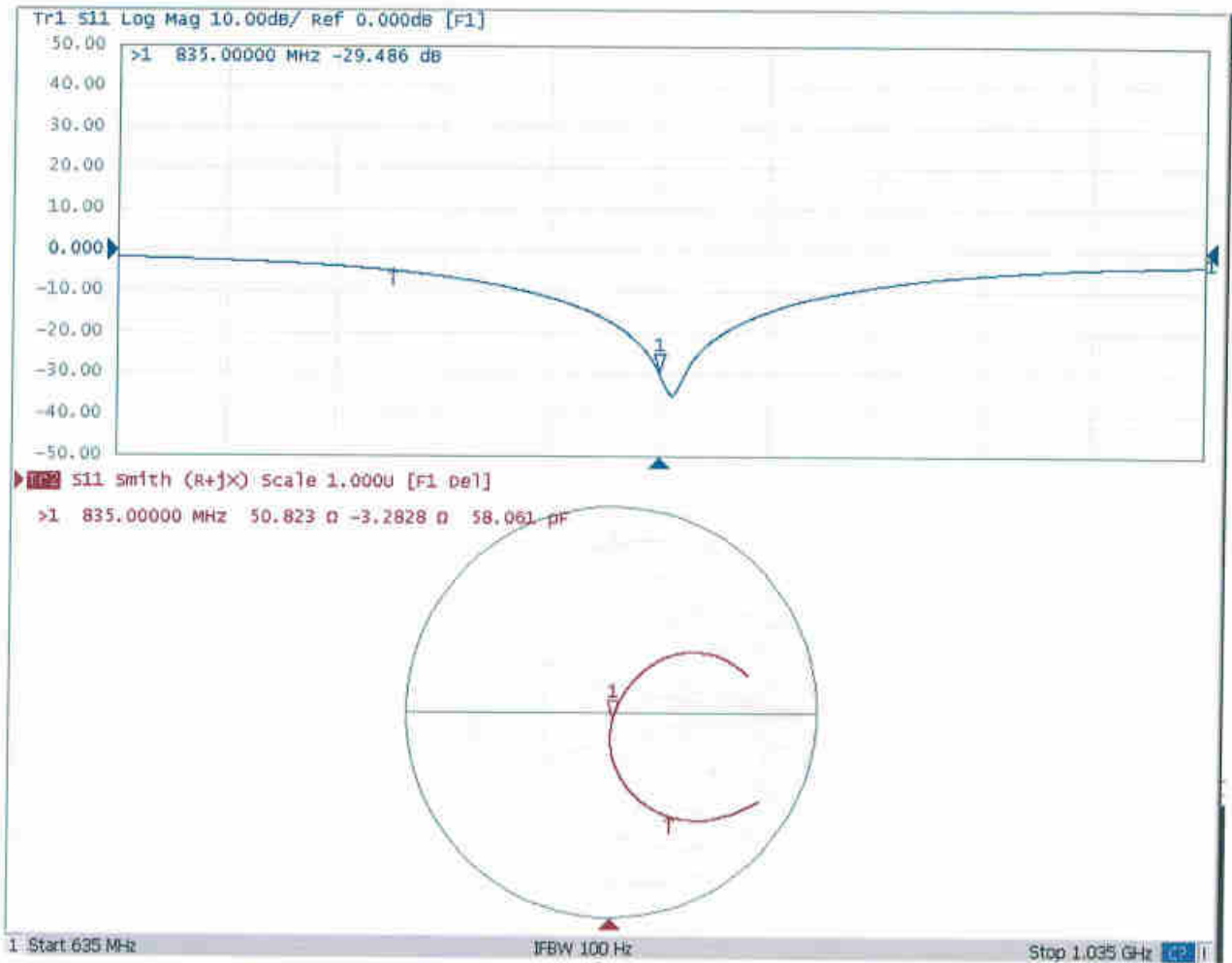



Add: No.51 Xueyuan Road, Haidian District, Beijing, 100191, China
Tel: +86-10-62304633-2079 Fax: +86-10-62304633-2504
E-mail: cttl@chinattl.com http://www.chinattl.cn

DASY5 Validation Report for Body TSL

Date: 03.26.2019

Test Laboratory: CTTL, Beijing, China

DUT: Dipole 835 MHz; Type: D835V2; Serial: D835V2 - SN: 4d151

Communication System: UID 0, CW; Frequency: 835 MHz; Duty Cycle: 1:1

Medium parameters used: $f = 835$ MHz; $\sigma = 0.944$ S/m; $\epsilon_r = 56.66$; $\rho = 1000$ kg/m³

Phantom section: Center Section

DASY5 Configuration:

- Probe: EX3DV4 - SN3617; ConvF(9.61, 9.61, 9.61) @ 835 MHz; Calibrated: 1/31/2019
- Sensor-Surface: 1.4mm (Mechanical Surface Detection)
- Electronics: DAE4 Sn1331; Calibrated: 2/6/2019
- Phantom: MFP_V5.1C ; Type: QD 000 P51CA; Serial: 1062
- Measurement SW: DASY52, Version 52.10 (2); SEMCAD X Version 14.6.12 (7450)

Dipole Calibration/Zoom Scan (7x7x7) (7x7x7)/Cube 0: Measurement grid: dx=5mm, dy=5mm, dz=5mm

Reference Value = 56.03 V/m; Power Drift = 0.04 dB

Peak SAR (extrapolated) = 3.53 W/kg

SAR(1 g) = 2.32 W/kg; SAR(10 g) = 1.52 W/kg

Maximum value of SAR (measured) = 3.12 W/kg

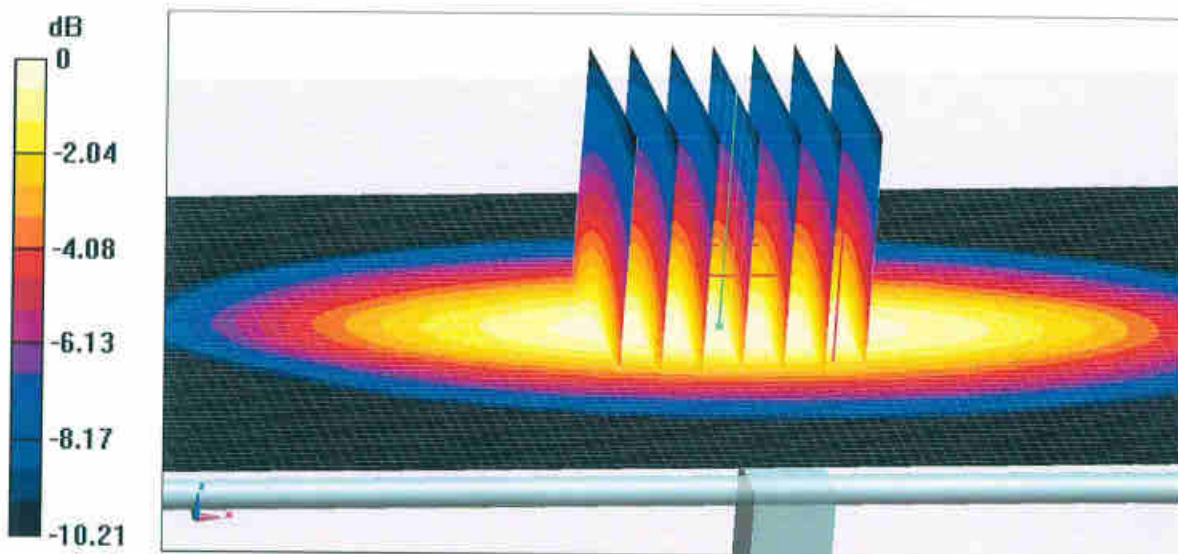

0 dB = 3.12 W/kg = 4.94 dBW/kg



Add: No.51 Xueyuan Road, Haidian District, Beijing, 100191, China
Tel: +86-10-62304633-2079 Fax: +86-10-62304633-2504
E-mail: cttl@chinattl.com http://www.chinattl.cn

Impedance Measurement Plot for Body TSL

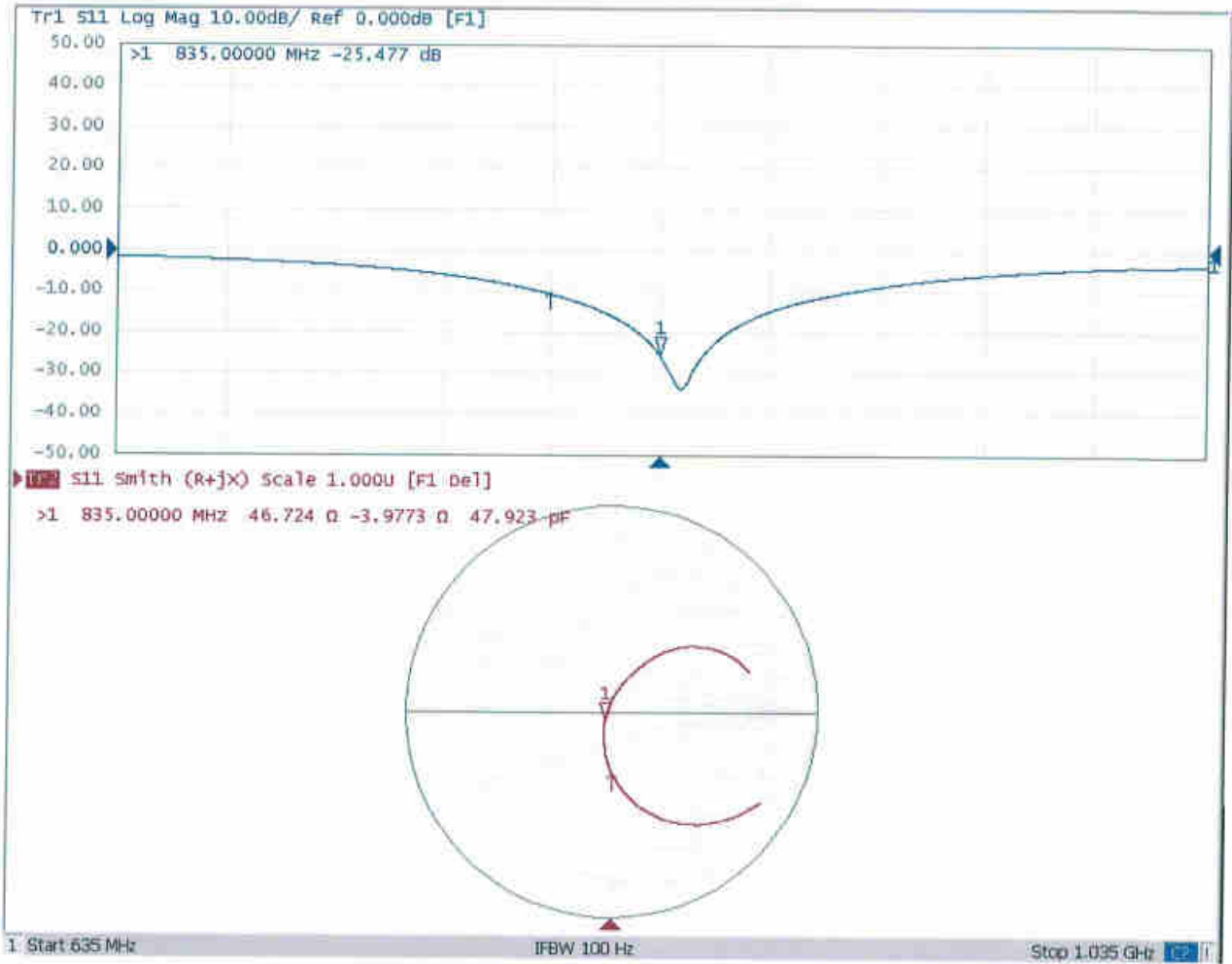



In Collaboration with
s p e a g
CALIBRATION LABORATORY



中国认可
国际互认
校准
CALIBRATION
CNAS L0570

Add: No.51 Xueyuan Road, Haidian District, Beijing, 100191, China
Tel: +86-10-62304633-2079 Fax: +86-10-62304633-2504
E-mail: cttl@chinattl.com http://www.chinattl.cn

Client **Sporton**

Certificate No: **Z19-60084**

CALIBRATION CERTIFICATE

Object **D1750V2 - SN: 1090**

Calibration Procedure(s) **FF-Z11-003-01**
Calibration Procedures for dipole validation kits

Calibration date: **March 27, 2019**

This calibration Certificate documents the traceability to national standards, which realize the physical units of measurements(SI). The measurements and the uncertainties with confidence probability are given on the following pages and are part of the certificate.

All calibrations have been conducted in the closed laboratory facility: environment temperature(22±3)℃ and humidity<70%.

Calibration Equipment used (M&TE critical for calibration)

Primary Standards	ID #	Cal Date(Calibrated by, Certificate No.)	Scheduled Calibration
Power Meter NRP2	106277	20-Aug-18 (CTTL, No.J18X06862)	Aug-19
Power sensor NRP8S	104291	20-Aug-18 (CTTL, No.J18X06862)	Aug-19
Reference Probe EX3DV4	SN 3617	31-Jan-19(SPEAG,No.EX3-3617_Jan19)	Jan-20
DAE4	SN 1331	06-Feb-19(SPEAG,No.DAE4-1331_Feb19)	Feb-20
Secondary Standards	ID #	Cal Date(Calibrated by, Certificate No.)	Scheduled Calibration
Signal Generator E4438C	MY49071430	23-Jan-19 (CTTL, No.J19X00336)	Jan-20
NetworkAnalyzer E5071C	MY46110673	24-Jan-19 (CTTL, No.J19X00547)	Jan-20

	Name	Function	Signature
Calibrated by:	Zhao Jing	SAR Test Engineer	
Reviewed by:	Lin Hao	SAR Test Engineer	
Approved by:	Qi Dianyuan	SAR Project Leader	

Issued: March 29, 2019

This calibration certificate shall not be reproduced except in full without written approval of the laboratory.



In Collaboration with

s p e a g
CALIBRATION LABORATORY

Add: No.51 Xueyuan Road, Haidian District, Beijing, 100191, China
Tel: +86-10-62304633-2079 Fax: +86-10-62304633-2504
E-mail: cttl@chinattl.com http://www.chinattl.cn

Glossary:

TSL	tissue simulating liquid
ConvF	sensitivity in TSL / NORM _{x,y,z}
N/A	not applicable or not measured

Calibration is Performed According to the Following Standards:

- IEEE Std 1528-2013, "IEEE Recommended Practice for Determining the Peak Spatial-Averaged Specific Absorption Rate (SAR) in the Human Head from Wireless Communications Devices: Measurement Techniques", June 2013
- IEC 62209-1, "Measurement procedure for assessment of specific absorption rate of human exposure to radio frequency fields from hand-held and body-mounted wireless communication devices- Part 1: Device used next to the ear (Frequency range of 300MHz to 6GHz)", July 2016
- IEC 62209-2, "Procedure to measure the Specific Absorption Rate (SAR) For wireless communication devices used in close proximity to the human body (frequency range of 30MHz to 6GHz)", March 2010
- KDB865664, SAR Measurement Requirements for 100 MHz to 6 GHz

Additional Documentation:

- DASY4/5 System Handbook

Methods Applied and Interpretation of Parameters:

- Measurement Conditions:** Further details are available from the Validation Report at the end of the certificate. All figures stated in the certificate are valid at the frequency indicated.
- Antenna Parameters with TSL:** The dipole is mounted with the spacer to position its feed point exactly below the center marking of the flat phantom section, with the arms oriented parallel to the body axis.
- Feed Point Impedance and Return Loss:** These parameters are measured with the dipole positioned under the liquid filled phantom. The impedance stated is transformed from the measurement at the SMA connector to the feed point. The Return Loss ensures low reflected power. No uncertainty required.
- Electrical Delay:** One-way delay between the SMA connector and the antenna feed point. No uncertainty required.
- SAR measured:** SAR measured at the stated antenna input power.
- SAR normalized:** SAR as measured, normalized to an input power of 1 W at the antenna connector.
- SAR for nominal TSL parameters:** The measured TSL parameters are used to calculate the nominal SAR result.

The reported uncertainty of measurement is stated as the standard uncertainty of Measurement multiplied by the coverage factor $k=2$, which for a normal distribution Corresponds to a coverage probability of approximately 95%.



Measurement Conditions

DASY system configuration, as far as not given on page 1.

DASY Version	DASY52	52.10.2.1495
Extrapolation	Advanced Extrapolation	
Phantom	Triple Flat Phantom 5.1C	
Distance Dipole Center - TSL	10 mm	with Spacer
Zoom Scan Resolution	dx, dy, dz = 5 mm	
Frequency	1750 MHz \pm 1 MHz	

Head TSL parameters

The following parameters and calculations were applied.

	Temperature	Permittivity	Conductivity
Nominal Head TSL parameters	22.0 °C	40.1	1.37 mho/m
Measured Head TSL parameters	(22.0 \pm 0.2) °C	41.3 \pm 6 %	1.37 mho/m \pm 6 %
Head TSL temperature change during test	<1.0 °C	---	---

SAR result with Head TSL

SAR averaged over 1 cm^3 (1 g) of Head TSL	Condition	
SAR measured	250 mW input power	9.04 W/kg
SAR for nominal Head TSL parameters	normalized to 1W	36.4 W/kg \pm 18.8 % (k=2)
SAR averaged over 10 cm^3 (10 g) of Head TSL	Condition	
SAR measured	250 mW input power	4.79 W/kg
SAR for nominal Head TSL parameters	normalized to 1W	19.2 W/kg \pm 18.7 % (k=2)

Body TSL parameters

The following parameters and calculations were applied.

	Temperature	Permittivity	Conductivity
Nominal Body TSL parameters	22.0 °C	53.4	1.49 mho/m
Measured Body TSL parameters	(22.0 \pm 0.2) °C	55.0 \pm 6 %	1.45 mho/m \pm 6 %
Body TSL temperature change during test	<1.0 °C	---	---

SAR result with Body TSL

SAR averaged over 1 cm^3 (1 g) of Body TSL	Condition	
SAR measured	250 mW input power	9.21 W/kg
SAR for nominal Body TSL parameters	normalized to 1W	37.7 W/kg \pm 18.8 % (k=2)
SAR averaged over 10 cm^3 (10 g) of Body TSL	Condition	
SAR measured	250 mW input power	4.89 W/kg
SAR for nominal Body TSL parameters	normalized to 1W	19.9 W/kg \pm 18.7 % (k=2)



In Collaboration with

s p e a g

CALIBRATION LABORATORY

Add: No.51 Xueyuan Road, Haidian District, Beijing, 100191, China

Tel: +86-10-62304633-2079

Fax: +86-10-62304633-2504

E-mail: cttl@chinattl.com

http://www.chinattl.cn

Appendix (Additional assessments outside the scope of CNAS L0570)

Antenna Parameters with Head TSL

Impedance, transformed to feed point	47.5Ω- 2.34 jΩ
Return Loss	- 29.2 dB

Antenna Parameters with Body TSL

Impedance, transformed to feed point	43.9Ω- 2.19 jΩ
Return Loss	- 23.2 dB

General Antenna Parameters and Design

Electrical Delay (one direction)	1.085 ns
----------------------------------	----------

After long term use with 100W radiated power, only a slight warming of the dipole near the feedpoint can be measured.

The dipole is made of standard semirigid coaxial cable. The center conductor of the feeding line is directly connected to the second arm of the dipole. The antenna is therefore short-circuited for DC-signals. On some of the dipoles, small end caps are added to the dipole arms in order to improve matching when loaded according to the position as explained in the "Measurement Conditions" paragraph. The SAR data are not affected by this change. The overall dipole length is still according to the Standard.

No excessive force must be applied to the dipole arms, because they might bend or the soldered connections near the feedpoint may be damaged.

Additional EUT Data

Manufactured by	SPEAG
-----------------	-------



In Collaboration with

s p e a g

CALIBRATION LABORATORY

Add: No.51 Xueyuan Road, Haidian District, Beijing, 100191, China
Tel: +86-10-62304633-2079 Fax: +86-10-62304633-2504
E-mail: cttl@chinattl.com http://www.chinattl.cn

DASY5 Validation Report for Head TSL

Date: 03.26.2019

Test Laboratory: CTTL, Beijing, China

DUT: Dipole 1750 MHz; Type: D1750V2; Serial: D1750V2 - SN: 1090

Communication System: UID 0, CW; Frequency: 1750 MHz; Duty Cycle: 1:1

Medium parameters used: $f = 1750$ MHz; $\sigma = 1.37$ S/m; $\epsilon_r = 41.27$; $\rho = 1000$ kg/m³

Phantom section: Right Section

DASY5 Configuration:

- Probe: EX3DV4 - SN3617; ConvF(8.38, 8.38, 8.38) @ 1750 MHz; Calibrated: 1/31/2019
- Sensor-Surface: 1.4mm (Mechanical Surface Detection)
- Electronics: DAE4 Sn1331; Calibrated: 2/6/2019
- Phantom: MFP_V5.1C ; Type: QD 000 P51CA; Serial: 1062
- Measurement SW: DASY52, Version 52.10 (2); SEMCAD X Version 14.6.12 (7450)

System Performance Check/Zoom Scan (7x7x7) (7x7x7)/Cube 0: Measurement grid:

$dx=5$ mm, $dy=5$ mm, $dz=5$ mm

Reference Value = 89.03 V/m; Power Drift = 0.03 dB

Peak SAR (extrapolated) = 17.1 W/kg

SAR(1 g) = 9.04 W/kg; SAR(10 g) = 4.79 W/kg

Maximum value of SAR (measured) = 14.2 W/kg

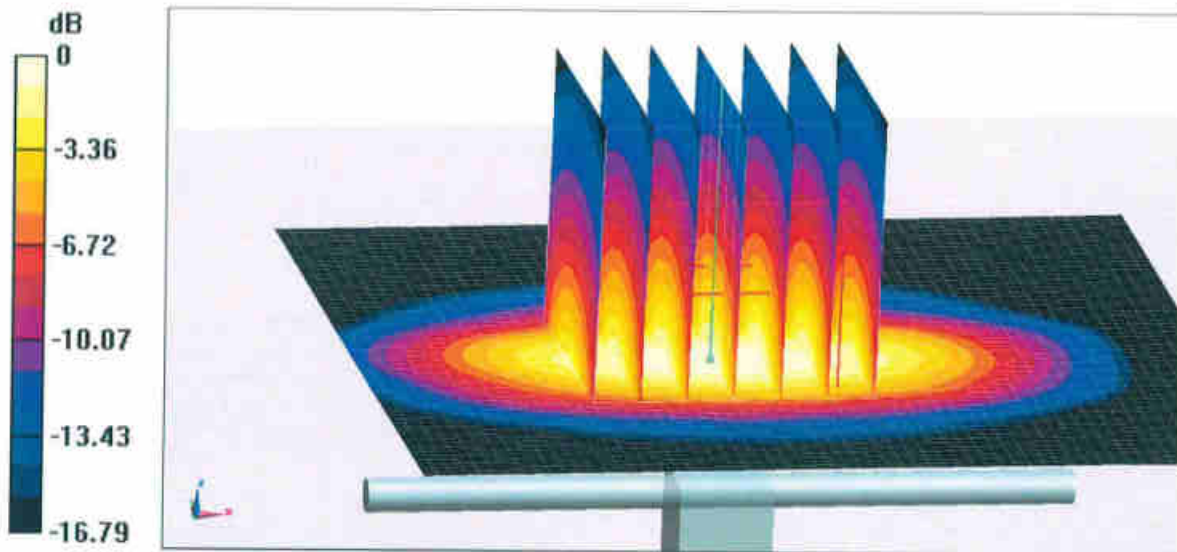

0 dB = 14.2 W/kg = 11.52 dBW/kg



Add: No.51 Xueyuan Road, Haidian District, Beijing, 100191, China
Tel: +86-10-62304633-2079 Fax: +86-10-62304633-2504
E-mail: cttl@chinattl.com http://www.chinattl.cn

Impedance Measurement Plot for Head TSL

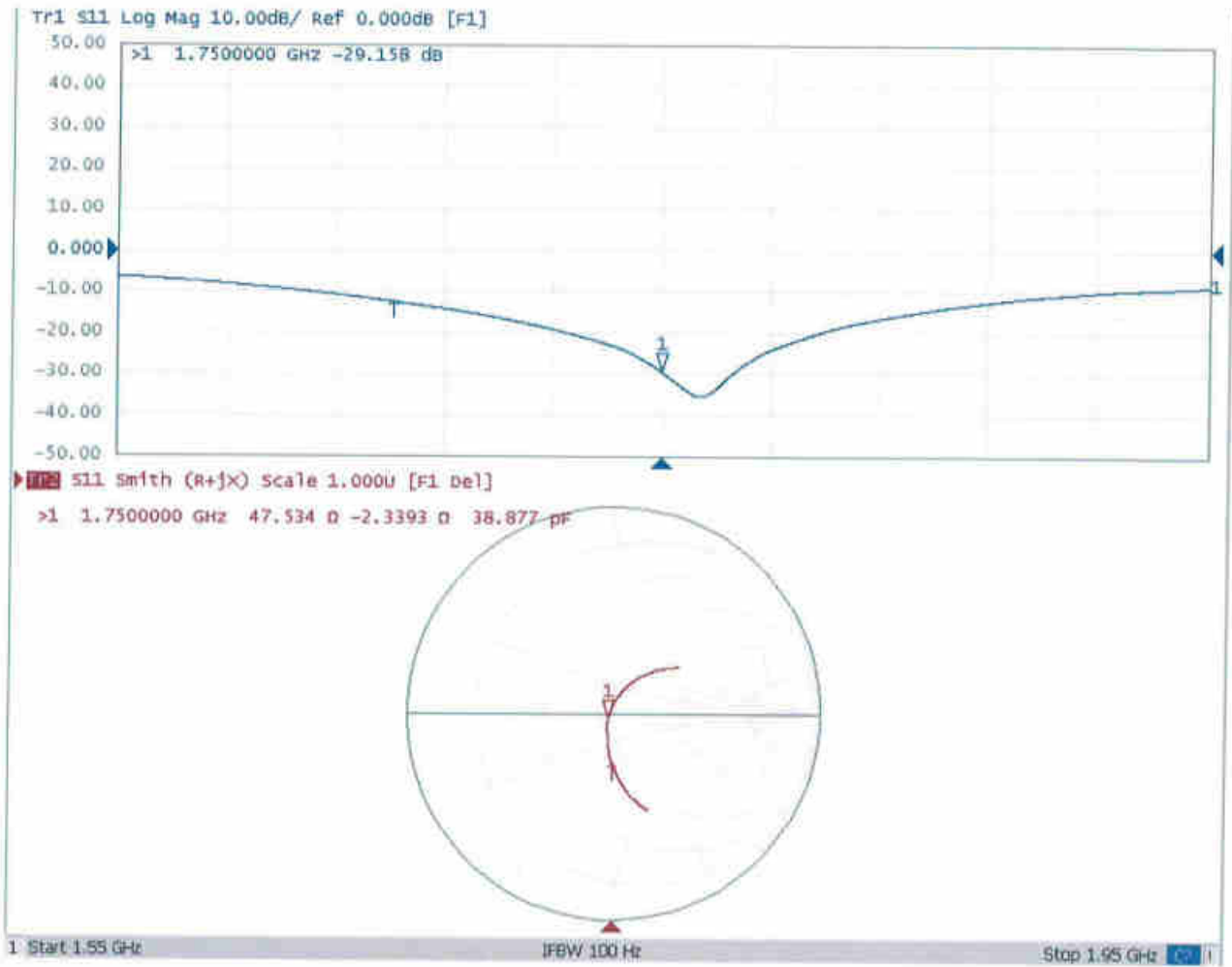



Add: No.51 Xueyuan Road, Haidian District, Beijing, 100191, China
Tel: +86-10-62304633-2079 Fax: +86-10-62304633-2504
E-mail: cttl@chinattl.com http://www.chinattl.cn

DASY5 Validation Report for Body TSL

Date: 03.26.2019

Test Laboratory: CTTL, Beijing, China

DUT: Dipole 1750 MHz; Type: D1750V2; Serial: D1750V2 - SN: 1090

Communication System: UID 0, CW; Frequency: 1750 MHz; Duty Cycle: 1:1

Medium parameters used: $f = 1750$ MHz; $\sigma = 1.449$ S/m; $\epsilon_r = 54.97$; $\rho = 1000$ kg/m³

Phantom section: Center Section

DASY5 Configuration:

- Probe: EX3DV4 - SN3617; ConvF(8.03, 8.03, 8.03) @ 1750 MHz; Calibrated: 1/31/2019
- Sensor-Surface: 1.4mm (Mechanical Surface Detection)
- Electronics: DAE4 Sn1331; Calibrated: 2/6/2019
- Phantom: MFP_V5.1C ; Type: QD 000 P51CA; Serial: 1062
- Measurement SW: DASY52, Version 52.10 (2); SEMCAD X Version 14.6.12 (7450)

System Performance Check/Zoom Scan (7x7x7) (7x7x7)/Cube 0: Measurement grid:

$dx=5$ mm, $dy=5$ mm, $dz=5$ mm

Reference Value = 93.13 V/m; Power Drift = -0.04 dB

Peak SAR (extrapolated) = 16.8 W/kg

SAR(1 g) = 9.21 W/kg; SAR(10 g) = 4.89 W/kg

Maximum value of SAR (measured) = 14.2 W/kg

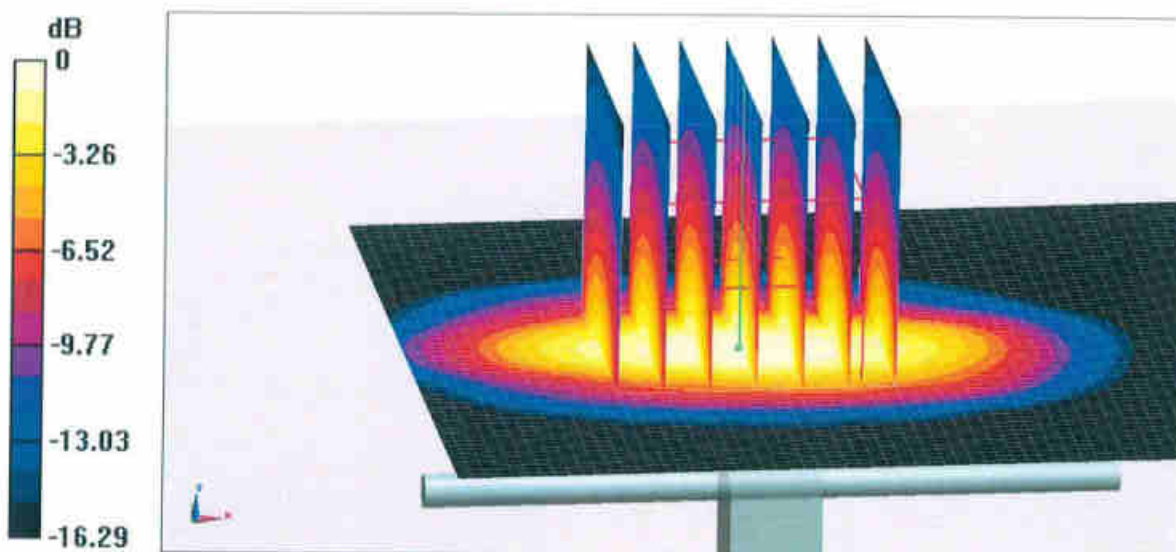

0 dB = 14.2 W/kg = 11.52 dBW/kg



Add: No.51 Xueyuan Road, Haidian District, Beijing, 100191, China
Tel: +86-10-62304633-2079 Fax: +86-10-62304633-2504
E-mail: cttl@chinattl.com http://www.chinattl.cn

Impedance Measurement Plot for Body TSL

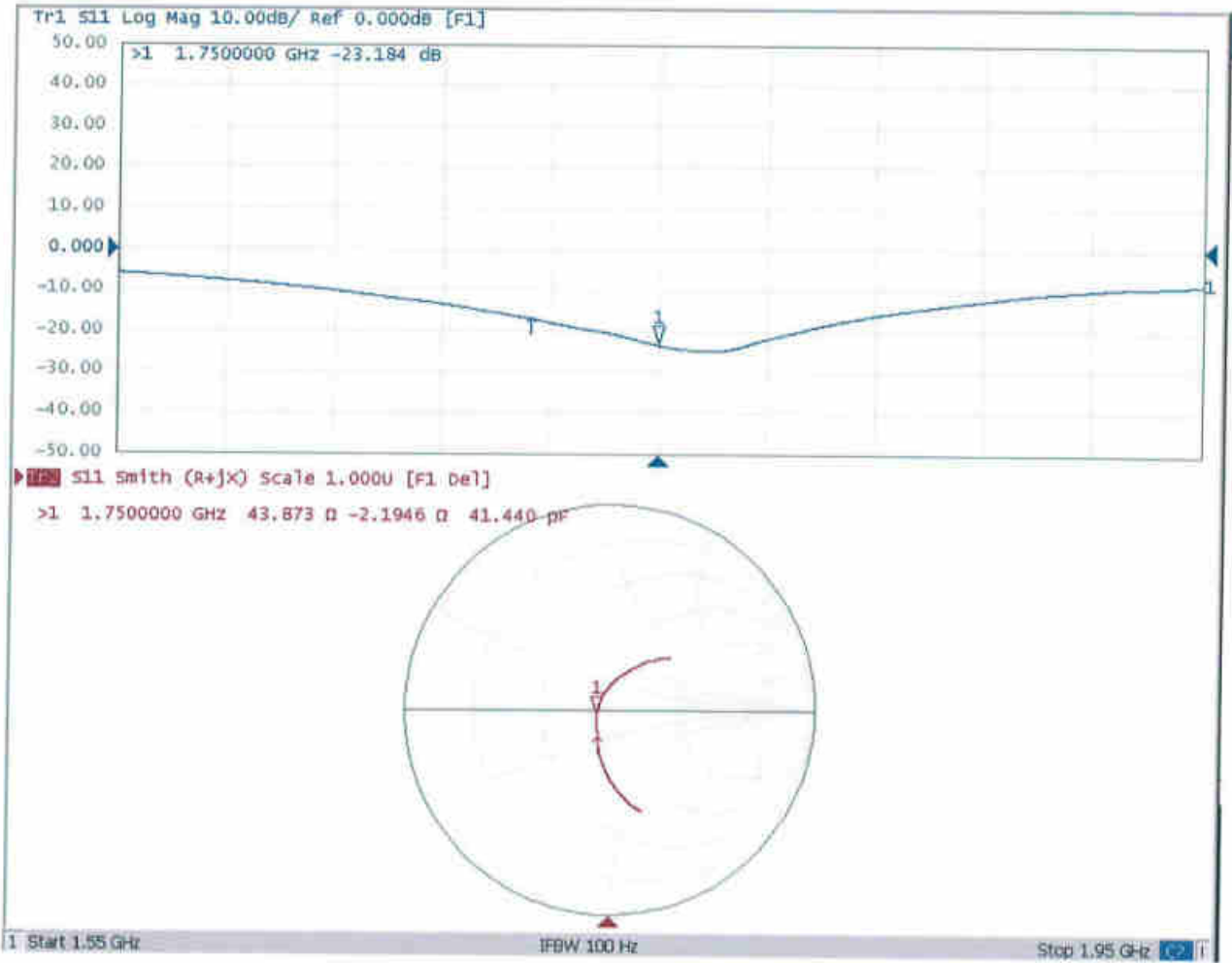



In Collaboration with
s p e a g
CALIBRATION LABORATORY



中国认可
国际互认
校准
CALIBRATION
CNAS L0570

Add: No.51 Xueyuan Road, Haidian District, Beijing, 100191, China
Tel: +86-10-62304633-2079 Fax: +86-10-62304633-2504
E-mail: cttl@chinattl.com http://www.chinattl.cn

Client **Sporton**

Certificate No: **Z19-60085**

CALIBRATION CERTIFICATE

Object **D1900V2 - SN: 5d170**

Calibration Procedure(s) **FF-Z11-003-01**
Calibration Procedures for dipole validation kits

Calibration date: **March 26, 2019**

This calibration Certificate documents the traceability to national standards, which realize the physical units of measurements(SI). The measurements and the uncertainties with confidence probability are given on the following pages and are part of the certificate.

All calibrations have been conducted in the closed laboratory facility: environment temperature(22±3)°C and humidity<70%.

Calibration Equipment used (M&TE critical for calibration)

Primary Standards	ID #	Cal Date(Calibrated by, Certificate No.)	Scheduled Calibration
Power Meter NRP2	106277	20-Aug-18 (CTTL, No.J18X06862)	Aug-19
Power sensor NRP8S	104291	20-Aug-18 (CTTL, No.J18X06862)	Aug-19
Reference Probe EX3DV4	SN 3617	31-Jan-19(SPEAG,No.EX3-3617_Jan19)	Jan-20
DAE4	SN 1331	06-Feb-19(SPEAG,No.DAE4-1331_Feb19)	Feb-20
Secondary Standards	ID #	Cal Date(Calibrated by, Certificate No.)	Scheduled Calibration
Signal Generator E4438C	MY49071430	23-Jan-19 (CTTL, No.J19X00336)	Jan-20
NetworkAnalyzer E5071C	MY46110673	24-Jan-19 (CTTL, No.J19X00547)	Jan-20

	Name	Function	Signature
Calibrated by:	Zhao Jing	SAR Test Engineer	
Reviewed by:	Lin Hao	SAR Test Engineer	
Approved by:	Qi Dianyuan	SAR Project Leader	

Issued: March 29, 2019

This calibration certificate shall not be reproduced except in full without written approval of the laboratory.



Glossary:

TSL	tissue simulating liquid
ConvF	sensitivity in TSL / NORM _{x,y,z}
N/A	not applicable or not measured

Calibration is Performed According to the Following Standards:

- IEEE Std 1528-2013, "IEEE Recommended Practice for Determining the Peak Spatial-Averaged Specific Absorption Rate (SAR) in the Human Head from Wireless Communications Devices: Measurement Techniques", June 2013
- IEC 62209-1, "Measurement procedure for assessment of specific absorption rate of human exposure to radio frequency fields from hand-held and body-mounted wireless communication devices- Part 1: Device used next to the ear (Frequency range of 300MHz to 6GHz)", July 2016
- IEC 62209-2, "Procedure to measure the Specific Absorption Rate (SAR) For wireless communication devices used in close proximity to the human body (frequency range of 30MHz to 6GHz)", March 2010
- KDB865664, SAR Measurement Requirements for 100 MHz to 6 GHz

Additional Documentation:

- DASY4/5 System Handbook

Methods Applied and Interpretation of Parameters:

- Measurement Conditions:** Further details are available from the Validation Report at the end of the certificate. All figures stated in the certificate are valid at the frequency indicated.
- Antenna Parameters with TSL:** The dipole is mounted with the spacer to position its feed point exactly below the center marking of the flat phantom section, with the arms oriented parallel to the body axis.
- Feed Point Impedance and Return Loss:** These parameters are measured with the dipole positioned under the liquid filled phantom. The impedance stated is transformed from the measurement at the SMA connector to the feed point. The Return Loss ensures low reflected power. No uncertainty required.
- Electrical Delay:** One-way delay between the SMA connector and the antenna feed point. No uncertainty required.
- SAR measured:** SAR measured at the stated antenna input power.
- SAR normalized:** SAR as measured, normalized to an input power of 1 W at the antenna connector.
- SAR for nominal TSL parameters:** The measured TSL parameters are used to calculate the nominal SAR result.

The reported uncertainty of measurement is stated as the standard uncertainty of Measurement multiplied by the coverage factor $k=2$, which for a normal distribution Corresponds to a coverage probability of approximately 95%.



Add: No.51 Xueyuan Road, Haidian District, Beijing, 100191, China
Tel: +86-10-62304633-2079 Fax: +86-10-62304633-2504
E-mail: cttl@chinattl.com http://www.chinattl.cn

Measurement Conditions

DASY system configuration, as far as not given on page 1.

DASY Version	DASY52	52.10.2.1495
Extrapolation	Advanced Extrapolation	
Phantom	Triple Flat Phantom 5.1C	
Distance Dipole Center - TSL	10 mm	with Spacer
Zoom Scan Resolution	dx, dy, dz = 5 mm	
Frequency	1900 MHz \pm 1 MHz	

Head TSL parameters

The following parameters and calculations were applied.

	Temperature	Permittivity	Conductivity
Nominal Head TSL parameters	22.0 °C	40.0	1.40 mho/m
Measured Head TSL parameters	(22.0 \pm 0.2) °C	40.5 \pm 6 %	1.44 mho/m \pm 6 %
Head TSL temperature change during test	<1.0 °C	---	---

SAR result with Head TSL

SAR averaged over 1 cm^3 (1 g) of Head TSL	Condition	
SAR measured	250 mW input power	9.90 W/kg
SAR for nominal Head TSL parameters	normalized to 1W	39.0 W/kg \pm 18.8 % (k=2)
SAR averaged over 10 cm^3 (10 g) of Head TSL	Condition	
SAR measured	250 mW input power	5.12 W/kg
SAR for nominal Head TSL parameters	normalized to 1W	20.3 W/kg \pm 18.7 % (k=2)

Body TSL parameters

The following parameters and calculations were applied.

	Temperature	Permittivity	Conductivity
Nominal Body TSL parameters	22.0 °C	53.3	1.52 mho/m
Measured Body TSL parameters	(22.0 \pm 0.2) °C	54.5 \pm 6 %	1.56 mho/m \pm 6 %
Body TSL temperature change during test	<1.0 °C	---	---

SAR result with Body TSL

SAR averaged over 1 cm^3 (1 g) of Body TSL	Condition	
SAR measured	250 mW input power	10.1 W/kg
SAR for nominal Body TSL parameters	normalized to 1W	40.0 W/kg \pm 18.8 % (k=2)
SAR averaged over 10 cm^3 (10 g) of Body TSL	Condition	
SAR measured	250 mW input power	5.28 W/kg
SAR for nominal Body TSL parameters	normalized to 1W	21.0 W/kg \pm 18.7 % (k=2)



Add: No.51 Xueyuan Road, Haidian District, Beijing, 100191, China
Tel: +86-10-62304633-2079 Fax: +86-10-62304633-2504
E-mail: cttl@chinattl.com http://www.chinattl.cn

Appendix (Additional assessments outside the scope of CNAS L0570)

Antenna Parameters with Head TSL

Impedance, transformed to feed point	51.7Ω+ 6.73jΩ
Return Loss	- 23.3dB

Antenna Parameters with Body TSL

Impedance, transformed to feed point	47.8Ω+ 6.72jΩ
Return Loss	- 22.8dB

General Antenna Parameters and Design

Electrical Delay (one direction)	1.066 ns
----------------------------------	----------

After long term use with 100W radiated power, only a slight warming of the dipole near the feedpoint can be measured.

The dipole is made of standard semirigid coaxial cable. The center conductor of the feeding line is directly connected to the second arm of the dipole. The antenna is therefore short-circuited for DC-signals. On some of the dipoles, small end caps are added to the dipole arms in order to improve matching when loaded according to the position as explained in the "Measurement Conditions" paragraph. The SAR data are not affected by this change. The overall dipole length is still according to the Standard. No excessive force must be applied to the dipole arms, because they might bend or the soldered connections near the feedpoint may be damaged.

Additional EUT Data

Manufactured by	SPEAG
-----------------	-------



Add: No.51 Xueyuan Road, Haidian District, Beijing, 100191, China
Tel: +86-10-62304633-2079 Fax: +86-10-62304633-2504
E-mail: cttl@chinattl.com http://www.chinattl.cn

DASY5 Validation Report for Head TSL

Date: 03.26.2019

Test Laboratory: CTTL, Beijing, China

DUT: Dipole 1900 MHz; Type: D1900V2; Serial: D1900V2 - SN: 5d170

Communication System: UID 0, CW; Frequency: 1900 MHz; Duty Cycle: 1:1

Medium parameters used: $f = 1900$ MHz; $\sigma = 1.441$ S/m; $\epsilon_r = 40.48$; $\rho = 1000$ kg/m³

Phantom section: Center Section

DASY5 Configuration:

- Probe: EX3DV4 - SN3617; ConvF(8.14, 8.14, 8.14) @ 1900 MHz; Calibrated: 1/31/2019
- Sensor-Surface: 1.4mm (Mechanical Surface Detection)
- Electronics: DAE4 Sn1331; Calibrated: 2/6/2019
- Phantom: MFP_V5.1C ; Type: QD 000 P51CA; Serial: 1062
- Measurement SW: DASY52, Version 52.10 (2); SEMCAD X Version 14.6.12 (7450)

System Performance Check/Zoom Scan (7x7x7) (7x7x7)/Cube 0: Measurement grid:
dx=5mm, dy=5mm, dz=5mm

Reference Value = 97.54 V/m; Power Drift = 0.08 dB

Peak SAR (extrapolated) = 18.9 W/kg

SAR(1 g) = 9.9 W/kg; SAR(10 g) = 5.12 W/kg

Maximum value of SAR (measured) = 15.6 W/kg

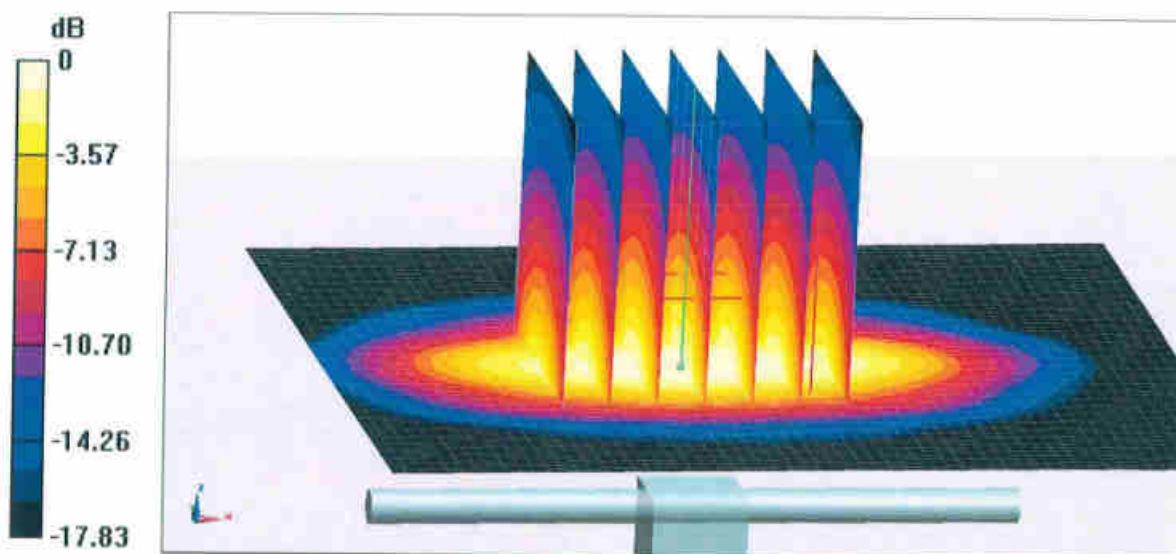

0 dB = 15.6 W/kg = 11.93 dBW/kg