

FCC Test Report

Report No.: RF161128C08-2

FCC ID: 2AENP-MS744517

Test Model: MS744517

Received Date: Nov. 30, 2016

Test Date: Dec. 30, 2016 ~ Feb. 15, 2017

Issued Date: Mar. 01, 2017

Applicant: Montblanc-Simplo GmbH

Address: Hellgrundweg 100 22525 Hamburg Germany

Issued By: Bureau Veritas Consumer Products Services (H.K.) Ltd., Taoyuan Branch

Lab Address: No. 47-2, 14th Ling, Chia Pau Vil., Lin Kou Dist., New Taipei City, Taiwan (R.O.C)

Test Location: No. 19, Hwa Ya 2nd Rd, Wen Hwa Tsuen, Kwei Shan Hsiang, Taoyuan Hsien 333, Taiwan, R.O.C.



This report is for your exclusive use. Any copying or replication of this report to or for any other person or entity, or use of our name or trademark, is permitted only with our prior written permission. This report sets forth our findings solely with respect to the test samples identified herein. The results set forth in this report are not indicative or representative of the quality or characteristics of the lot from which a test sample was taken or any similar or identical product unless specifically and expressly noted. Our report includes all of the tests requested by you and the results thereof based upon the information that you provided to us. You have 60 days from date of issuance of this report to notify us of any material error or omission caused by our negligence, provided, however, that such notice shall be in writing and shall specifically address the issue you wish to raise. A failure to raise such issue within the prescribed time shall constitute your unqualified acceptance of the completeness of this report, the tests conducted and the correctness of the report contents. Unless specific mention, the uncertainty of measurement has been explicitly taken into account to declare the compliance or non-compliance to the specification.

Table of Contents

Release Control Record	4
1 Certificate of Conformity	5
2 Summary of Test Results	6
2.1 Measurement Uncertainty.....	6
2.2 Modification Record	6
3 General Information	7
3.1 General Description of EUT	7
3.2 Construction of EUT.....	8
3.3 Description of Test Modes.....	9
3.3.1 Test Mode Applicability and Tested Channel Detail.....	9
3.4 Duty Cycle of Test Signal	11
3.5 Description of Support Units	12
3.5.1 Configuration of System under Test	12
3.6 General Description of Applied Standards.....	12
4 Test Types and Results	13
4.1 Radiated Emission and Bandedge Measurement	13
4.1.1 Limits of Radiated Emission and Bandedge Measurement	13
4.1.2 Test Instruments	14
4.1.3 Test Procedures.....	15
4.1.4 Deviation from Test Standard	15
4.1.5 Test Set Up	16
4.1.6 EUT Operating Conditions.....	16
4.1.7 Test Results	17
4.2 Conducted Emission Measurement.....	39
4.2.1 Limits of Conducted Emission Measurement	39
4.2.2 Test Instruments	39
4.2.3 Test Procedures.....	40
4.2.4 Deviation from Test Standard	40
4.2.5 Test Setup.....	40
4.2.6 EUT Operating Conditions.....	40
4.2.7 Test Results	41
4.3 6 dB Bandwidth Measurement.....	43
4.3.1 Limits of 6 dB Bandwidth Measurement.....	43
4.3.2 Test Setup.....	43
4.3.3 Test Instruments	43
4.3.4 Test Procedure	43
4.3.5 Deviation from Test Standard	43
4.3.6 EUT Operating Conditions.....	43
4.3.7 Test Result	44
4.4 Conducted Output Power Measurement	46
4.4.1 Limits of Conducted Output Power Measurement.....	46
4.4.2 Test Setup.....	46
4.4.3 Test Instruments	46
4.4.4 Test Procedures.....	46
4.4.5 Deviation from Test Standard	46
4.4.6 EUT Operating Conditions.....	46
4.4.7 Test Results	47
4.5 Power Spectral Density Measurement	48
4.5.1 Limits of Power Spectral Density Measurement.....	48
4.5.2 Test Setup.....	48
4.5.3 Test Instruments	48
4.5.4 Test Procedure	48
4.5.5 Deviation from Test Standard	48

4.5.6 EUT Operating Condition	48
4.5.7 Test Results	49
4.6 Conducted Out of Band Emission Measurement	51
4.6.1 Limits of Conducted Out of Band Emission Measurement.....	51
4.6.2 Test Setup.....	51
4.6.3 Test Instruments	51
4.6.4 Test Procedure	51
4.6.5 Deviation from Test Standard	51
4.6.6 EUT Operating Condition	51
4.6.7 Test Results	52
5 Pictures of Test Arrangements.....	58
Appendix – Information on the Testing Laboratories	59

Release Control Record

Issue No.	Description	Date Issued
RF161128C08-2	Original Release	Mar. 01, 2017

1 Certificate of Conformity

Product: Montblanc SUMMIT

Brand: Montblanc

Test Model: MS744517

Sample Status: Production Unit

Applicant: Montblanc-Simplo GmbH

Test Date: Dec. 30, 2016 ~ Feb. 15, 2017

Standards: 47 CFR FCC Part 15, Subpart C (Section 15.247)
ANSI C63.10:2013

The above equipment has been tested by **Bureau Veritas Consumer Products Services (H.K.) Ltd., Taoyuan Branch**, and found compliance with the requirement of the above standards. The test record, data evaluation & Equipment Under Test (EUT) configurations represented herein are true and accurate accounts of the measurements of the sample's EMC characteristics under the conditions specified in this report.

Prepared by : Gina Liu , **Date:** Mar. 01, 2017
Gina Liu / Specialist

Approved by : David Huang , **Date:** Mar. 01, 2017
David Huang / Project Engineer

2 Summary of Test Results

47 CFR FCC Part 15, Subpart C (Section 15.247)			
FCC Clause	Test Item	Result	Remarks
15.207	AC Power Conducted Emission	Pass	Meet the requirement of limit. Minimum passing margin is -15.72 dB at 0.78250 MHz.
15.205 / 15.209 / 15.247(d)	Radiated Emissions and Band Edge Measurement	Pass	Meet the requirement of limit. Minimum passing margin is -0.3 dB at 2483.52 MHz.
15.247(d)	Antenna Port Emission	Pass	Meet the requirement of limit.
15.247(a)(2)	6 dB Bandwidth	Pass	Meet the requirement of limit.
15.247(b)	Conducted power	Pass	Meet the requirement of limit.
15.247(e)	Power Spectral Density	Pass	Meet the requirement of limit.
15.203	Antenna Requirement	Pass	No antenna connector is used.

2.1 Measurement Uncertainty

Where relevant, the following measurement uncertainty levels have been estimated for tests performed on the EUT:

The listed uncertainties are the worst case uncertainty for the entire range of measurement. Please note that the uncertainty values are provided for informational purposes only and are not used in determining the PASS/FAIL results.

Measurement	Frequency	Expanded Uncertainty (k=2) (\pm)
Conducted Emissions at mains ports	150 kHz ~ 30 MHz	2.44 dB
Radiated Emissions up to 1 GHz	30 MHz ~ 200 MHz	2.93 dB
	200 MHz ~ 1000 MHz	2.95 dB
Radiated Emissions above 1 GHz	1 GHz ~ 18 GHz	2.26 dB
	18 GHz ~ 40 GHz	1.94 dB

2.2 Modification Record

There were no modifications required for compliance.

3 General Information

3.1 General Description of EUT

Product	Montblanc SUMMIT
Brand	Montblanc
Test Model	MS744517
Status of EUT	Production Unit
Power Supply Rating	5.0 Vdc (host equipment) 3.8 Vdc (Li-ion battery)
Modulation Type	CCK, DQPSK, DBPSK for DSSS 64QAM, 16QAM, QPSK, BPSK for OFDM
Modulation Technology	DSSS, OFDM
Transfer Rate	802.11b: 11.0 / 5.5 / 2.0 / 1.0 Mbps 802.11g: 54.0 / 48.0 / 36.0 / 24.0 / 18.0 / 12.0 / 9.0 / 6.0 Mbps 802.11n: up to MCS7
Operating Frequency	2412 ~ 2472 MHz
Number of Channel	13 for 802.11b, 802.11g, 802.11n (HT20)
Output Power	84.333 mW
Antenna Type	Loop antenna with -8.05 dBi gain
Antenna Connector	N/A
Accessory Device	Refer to Note as below
Data Cable Supplied	Refer to Note as below

Note:

- The EUT contains following accessory devices.

Product	Brand	Model	Description
Battery	APACK	APP-12F-B2727I-XCX-11A	3.8 Vdc, 300 mAh
USB Cable	Montblanc	LQ032028-1 LIQI	0.8m shielded cable w/o core
Cradle	Montblanc	AC101CDPA001	Voltage rating: 30V, Temperature rating: 80 °C, Insulation resistance:DC-500V 100MΩ
LCD Panel	GIS	AW0140002001	1.39"
CPU	Qualcomm	APQ8009W	575 Pin
eMMC (=ROM)	-	-	CMP=512MB RAM/ 4GB Flash (ePOP)
Main Board	UNITECH	DBW1 GA-500, UL94-V0	
BT/WLAN Module	Qualcomm	WCN3620	

- The above EUT information is declared by manufacturer and for more detailed features description, please refer to the manufacturer's specifications or user's manual.

3.2 Construction of EUT

Component	Vendor	Model/Spec.	Configuration			
			SKU 1	SKU 2	SKU 3	SKU 4
CPU	Qualcomm	APQ8009W / 575 Pin	v	v	v	v
Main Board	UNITECH	DBW1 GA-500, UL94-V0	v	v	v	v
eMMC 1 (=ROM 1)	KSI	04EPOP04-EL3BM627-B02 / CMP=512MB RAM/ 4GB Flash (ePOP)	v	v	v	v
LCD Panel	GIS	AW0140002001 / 1.39"	v	v	v	v
BT/WLAN Module	Qualcomm	WCN3620	v	v	v	v
Battery	APACK	APP-12F-B2727I-XCX-11A / 3.8 Vdc, 300 mAh	v	v	v	v
Bezel	N/A	Stainless steel with primary color	v	v		
		Stainless steel + paint black color			v	
		Stainless steel + paint black + number				v
Case	N/A	Stainless steel with primary color	v			v
		Titanium with silver color		v		
		Stainless steel + paint black color			v	
Caseback	N/A	Stainless steel with primary color	v	v		v
		Stainless steel + paint black color			v	
Strap		Rubber/ leather	v	v	v	v

Note: SKU1~SKU4 have the same layout, circuit, and components, but different appearance.

3.3 Description of Test Modes

13 channels are provided for 802.11b, 802.11g and 802.11n (HT20):

Channel	Frequency (MHz)	Channel	Frequency (MHz)
1	2412	8	2447
2	2417	9	2452
3	2422	10	2457
4	2427	11	2462
5	2432	12	2467
6	2437	13	2472
7	2442		

3.3.1 Test Mode Applicability and Tested Channel Detail

EUT Configure Mode	Applicable To				Description
	RE \geq 1G	RE<1G	PLC	APCM	
1	√	√	√	√	SKU 1
2	√	√	-	-	SKU 2
3	√	√	-	-	SKU 3
4	√	√	-	-	SKU 4

Where **RE \geq 1G**: Radiated Emission above 1 GHz **RE<1G**: Radiated Emission below 1 GHz
PLC: Power Line Conducted Emission **APCM**: Antenna Port Conducted Measurement

NOTE: The EUT had been pre-tested on the positioned of each 3 axis. The worst case was found when positioned on **Z-plane**.

NOTE: "-" means no effect.

Radiated Emission Test (Above 1 GHz):

- Pre-Scan has been conducted to determine the worst-case mode from all possible combinations between available modulations, data rates and antenna ports (if EUT with antenna diversity architecture).
- Following channel(s) was (were) selected for the final test as listed below.

EUT Configure Mode	Mode	Available Channel	Tested Channel	Modulation Technology	Modulation Type	Data Rate (Mbps)
1	802.11b	1 to 13	1, 6, 11, 12, 13	DSSS	DBPSK	1.0
1	802.11g	1 to 13	1, 6, 11, 12, 13	OFDM	BPSK	6.0
1	802.11n (HT20)	1 to 13	1, 6, 11, 12, 13	OFDM	BPSK	MCS0
2~4	802.11g	1 to 13	13	OFDM	BPSK	6.0

Radiated Emission Test (Below 1 GHz):

- Pre-Scan has been conducted to determine the worst-case mode from all possible combinations between available modulations, data rates and antenna ports (if EUT with antenna diversity architecture).
- Following channel(s) was (were) selected for the final test as listed below.

EUT Configure Mode	Mode	Available Channel	Tested Channel	Modulation Technology	Modulation Type	Data Rate (Mbps)
1~4	802.11g	1 to 13	13	OFDM	BPSK	6.0

Power Line Conducted Emission Test:

- Pre-Scan has been conducted to determine the worst-case mode from all possible combinations between available modulations, data rates and antenna ports (if EUT with antenna diversity architecture).
- Following channel(s) was (were) selected for the final test as listed below.

EUT Configure Mode	Mode	Available Channel	Tested Channel	Modulation Technology	Modulation Type	Data Rate (Mbps)
1	802.11g	1 to 13	13	OFDM	BPSK	6.0

Bandedge Measurement:

- Pre-Scan has been conducted to determine the worst-case mode from all possible combinations between available modulations, data rates and antenna ports (if EUT with antenna diversity architecture).
- Following channel(s) was (were) selected for the final test as listed below.

EUT Configure Mode	Mode	Available Channel	Tested Channel	Modulation Technology	Modulation Type	Data Rate (Mbps)
1	802.11b	1 to 13	1, 13	DSSS	DBPSK	1.0
1	802.11g	1 to 13	1, 13	OFDM	BPSK	6.0
1	802.11n (HT20)	1 to 13	1, 13	OFDM	BPSK	MCS0

Antenna Port Conducted Measurement:

- This item includes all test value of each mode, but only includes spectrum plot of worst value of each mode.
- Pre-Scan has been conducted to determine the worst-case mode from all possible combinations between available modulations, data rates and antenna ports (if EUT with antenna diversity architecture).
- Following channel(s) was (were) selected for the final test as listed below.

EUT Configure Mode	Mode	Available Channel	Tested Channel	Modulation Technology	Modulation Type	Data Rate (Mbps)
1	802.11b	1 to 13	1, 6, 11, 12, 13	DSSS	DBPSK	1.0
1	802.11g	1 to 13	1, 6, 11, 12, 13	OFDM	BPSK	6.0
1	802.11n (HT20)	1 to 13	1, 6, 11, 12, 13	OFDM	BPSK	MCS0

Test Condition:

Applicable To	Environmental Conditions	Input Power	Tested by
RE≥1G	25 deg. C, 65 % RH	120 Vac, 60 Hz	Gavin Wu
RE<1G	25 deg. C, 65 % RH	120 Vac, 60 Hz	Gavin Wu
PLC	25 deg. C, 65 % RH	120 Vac, 60 Hz	Toby Tian
APCM	25 deg. C, 65 % RH	3.8 Vdc	Taylor Liu

3.4 Duty Cycle of Test Signal

802.11b: Duty cycle of test signal is 100 %, duty factor is not required.

802.11g: Duty cycle = $1.363/1.563 = 0.872$, Duty factor = $10 * \log(1/0.872) = 0.60$

802.11n (HT20): Duty cycle = $1.277/1.477 = 0.864$, Duty factor = $10 * \log(1/0.864) = 0.63$

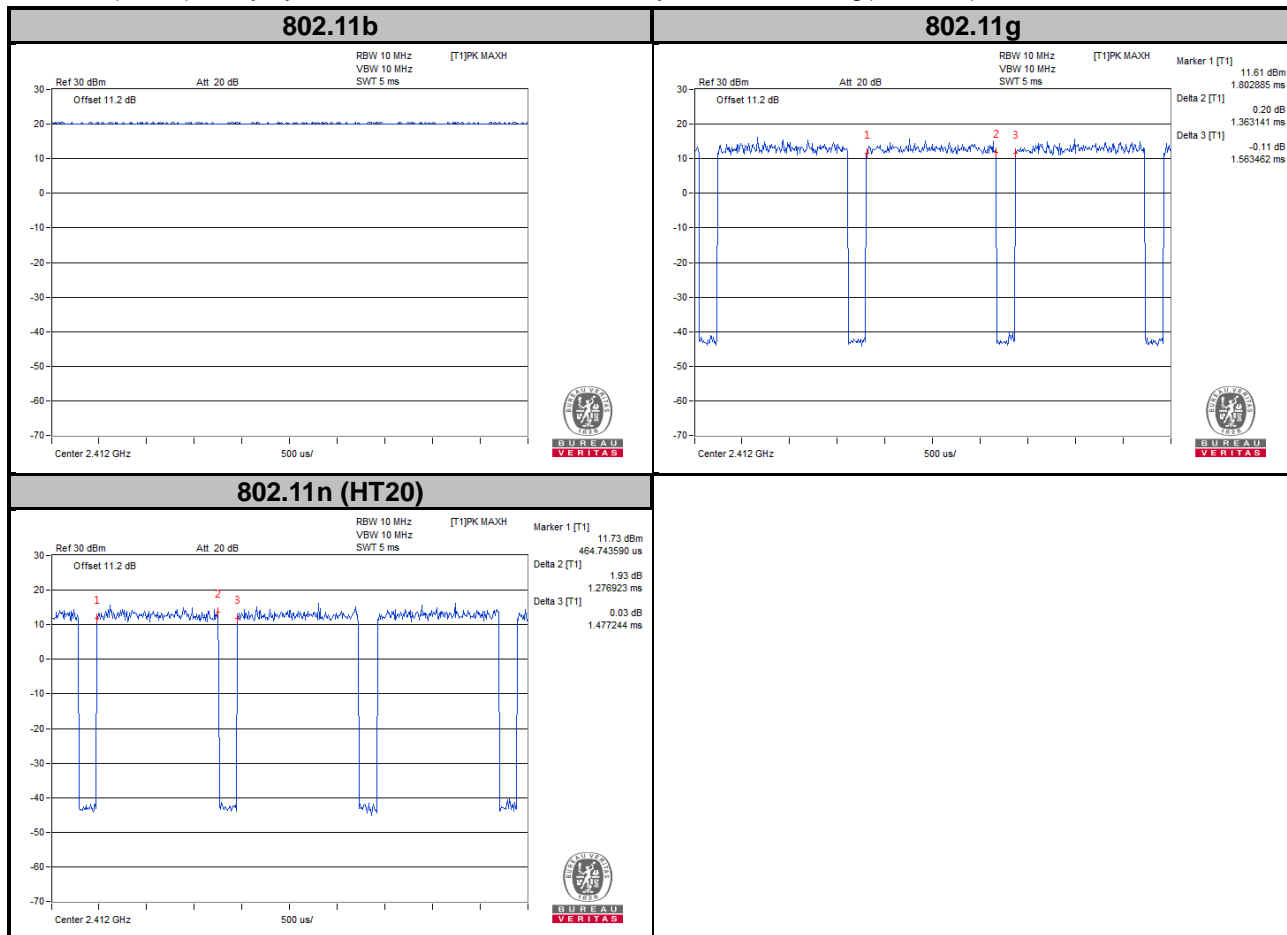

3.5 Description of Support Units

The EUT has been tested as an independent unit together with other necessary accessories or support units.

3.5.1 Configuration of System under Test

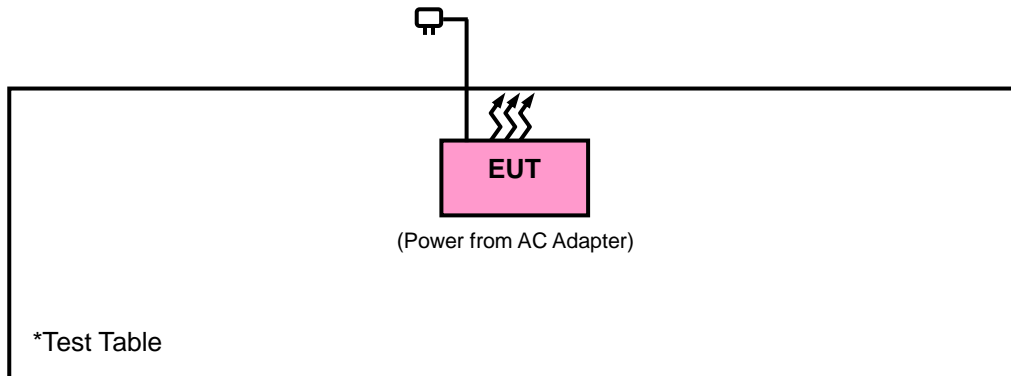

3.6 General Description of Applied Standards

The EUT is a RF Product. According to the specifications of the manufacturer, it must comply with the requirements of the following standards:

FCC Part 15, Subpart C (15.247)

558074 D01 DTS Meas Guidance v03r05

ANSI C63.10-2013

All test items have been performed and recorded as per the above standards.

NOTE: The EUT has been verified to comply with the requirements of FCC Part 15, Subpart B, Class B (DoC).
The test report has been issued separately.

4 Test Types and Results

4.1 Radiated Emission and Bandedge Measurement

4.1.1 Limits of Radiated Emission and Bandedge Measurement

Radiated emissions which fall in the restricted bands must comply with the radiated emission limits specified as below table. Other emissions shall be at least 20 dB below the highest level of the desired power:

Frequencies (MHz)	Field Strength (microvolts/meter)	Measurement Distance (meters)
0.009 ~ 0.490	2400/F (kHz)	300
0.490 ~ 1.705	24000/F (kHz)	30
1.705 ~ 30.0	30	30
30 ~ 88	100	3
88 ~ 216	150	3
216 ~ 960	200	3
Above 960	500	3

NOTE:

1. The lower limit shall apply at the transition frequencies.
2. Emission level (dBuV/m) = 20 log Emission level (uV/m).
3. For frequencies above 1000 MHz, the field strength limits are based on average detector, however, the peak field strength of any emission shall not exceed the maximum permitted average limits, specified above by more than 20 dB under any condition of modulation.

4.1.2 Test Instruments

Description & Manufacturer	Model No.	Serial No.	Date of Calibration	Due Date of Calibration
Test Receiver Agilent Technologies	N9038A	MY52260177	Jun. 21, 2016	Jun. 20, 2017
Spectrum Analyzer Agilent	N9010A	MY52220314	Dec. 16, 2016	Dec. 15, 2017
BILOG Antenna SCHWARZBECK	VULB9168	9168-472	Dec. 26, 2016	Dec. 27, 2017
HORN Antenna SCHWARZBECK	BBHA 9120 D	9120D-969	Dec. 12, 2016	Dec. 13, 2017
HORN Antenna SCHWARZBECK	BBHA 9170	9170-480	Dec. 14, 2016	Dec. 13, 2017
Loop Antenna	EM-6879	269	Aug. 11, 2016	Aug. 10, 2017
Bluetooth Tester	CBT	100980	Apr. 27, 2015	Apr. 26, 2017
Preamplifier EMCI	EMC 012645	980115	Oct. 21, 2016	Oct. 20, 2017
Preamplifier EMCI	EMC 184045	980116	Oct. 21, 2016	Oct. 20, 2017
Preamplifier EMCI	EMC 330H	980112	Oct. 21, 2016	Oct. 20, 2017
RF signal cable HUBER+SUHNNER	SUCOFLEX 104	309219/4 2950114	Oct. 21, 2016	Oct. 20, 2017
RF signal cable HUBER+SUHNNER	SUCOFLEX 104	250130/4	Oct. 21, 2016	Oct. 20, 2017
RF Coaxial Cable Worken	8D-FB	Cable-Ch10-01	Oct. 21, 2016	Oct. 20, 2017
Software BV ADT	E3 6.120103	NA	NA	NA
Antenna Tower MF	MFA-440H	NA	NA	NA
Turn Table MF	MFT-201SS	NA	NA	NA
Antenna Tower & Turn Table Controller MF	MF-7802	NA	NA	NA
Test Receiver Agilent Technologies	N9038A	MY52260177	Jun. 21, 2016	Jun. 20, 2017
Spectrum Analyzer Agilent	N9010A	MY52220314	Dec. 16, 2016	Dec. 15, 2017

- Note: 1. The calibration interval of the above test instruments is 12 months and the calibrations are traceable to NML/ROC and NIST/USA.
2. The test was performed in HwaYa Chamber 10.
3. The horn antenna and preamplifier (model: EMC 184045) are used only for the measurement of emission frequency above 1 GHz if tested.
4. The FCC Site Registration No. is 690701.
5. The IC Site Registration No. is IC7450F-10.

4.1.3 Test Procedures

- a. The EUT was placed on the top of a rotating table 0.8 meters (for below 1 GHz) / 1.5 meters (for above 1 GHz) above the ground at 3 meter chamber room for test. The table was rotated 360 degrees to determine the position of the highest radiation.
- b. The EUT was set 3 meters away from the interference-receiving antenna, which was mounted on the top of a variable-height antenna tower.
- c. The height of antenna is varied from one meter to four meters above the ground to determine the maximum value of the field strength. Both horizontal and vertical polarizations of the antenna are set to make the measurement.
- d. For each suspected emission, the EUT was arranged to its worst case and then the antenna was tuned to heights from 1 meter to 4 meters and the rotatable table was turned from 0 degrees to 360 degrees to find the maximum reading.
- e. The test-receiver system was set to quasi-peak detect function and specified bandwidth with maximum hold mode when the test frequency is below 1 GHz.
- f. The test-receiver system was set to peak and average detected function and specified bandwidth with maximum hold mode when the test frequency is above 1 GHz. If the peak reading value also meets average limit, measurement with the average detector is unnecessary.

Note:

1. The resolution bandwidth and video bandwidth of test receiver/spectrum analyzer is 120 kHz & 360 KHz for Quasi-peak detection (QP) at frequency below 1 GHz.
2. The resolution bandwidth of test receiver/spectrum analyzer is 1 MHz and the video bandwidth is 3 MHz for Peak detection (PK) at frequency above 1 GHz.
3. The resolution bandwidth of test receiver/spectrum analyzer is 1 MHz and the video bandwidth is 1/T for RMS Average (Duty cycle < 98 %) for Peak detection at frequency above 1 GHz.
4. The resolution bandwidth of test receiver/spectrum analyzer is 1 MHz and the video bandwidth is 10 Hz (Duty cycle \geq 98 %) for Average detection (AV) at frequency above 1 GHz.
5. All modes of operation were investigated and the worst-case emissions are reported.

4.1.4 Deviation from Test Standard

No deviation.

4.1.5 Test Set Up

<Frequency Range below 1 GHz>

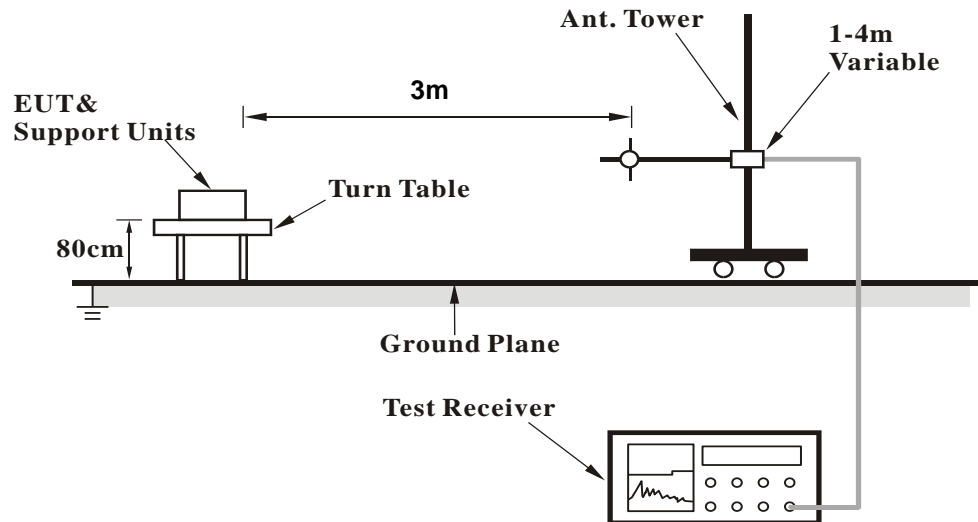

<Frequency Range above 1 GHz>

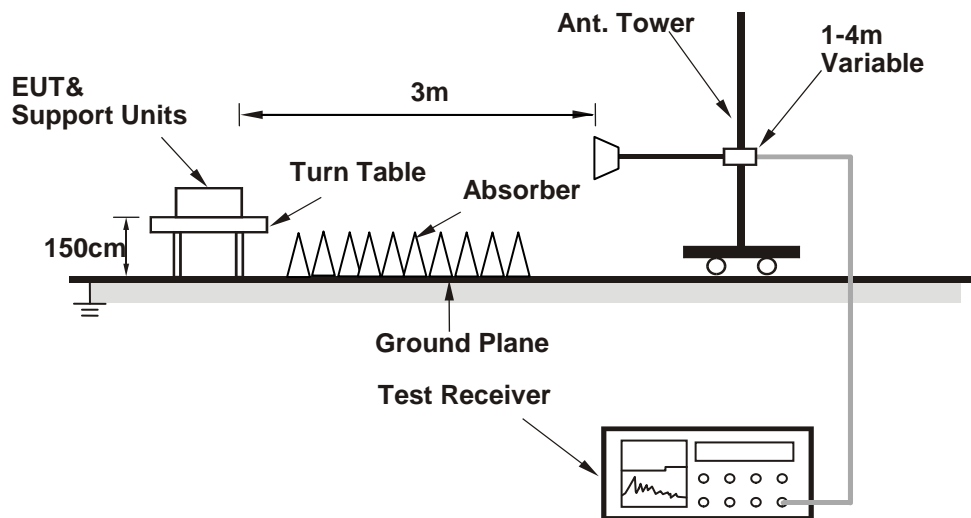

For the actual test configuration, please refer to the attached file (Test Setup Photo).

4.1.6 EUT Operating Conditions

- Placed the EUT on a testing table.
- Use the software to control the EUT under transmission condition continuously at specific channel frequency.

4.1.7 Test Results

Above 1 GHz Data :

Mode 1

802.11b

EUT Test Condition		Measurement Detail	
Channel	Channel 1	Frequency Range	1 GHz ~ 25 GHz
Input Power	120 Vac, 60 Hz	Detector Function	Peak (PK) Average (AV)
Environmental Conditions	25 deg. C, 65 % RH	Tested By	Gavin Wu

Antennal Polarity & Test Distance: Horizontal at 3 m										
Frequency (MHz)	Emission Level (dBuV/m)	Read Level (dBuV)	Limit (dBuV/m)	Margin (dB)	Antenna Factor (dB/m)	Cable Loss (dB)	Preamp Factor (dB)	Antenna Height (cm)	Table Angle (Degree)	Remark
2388.48	56.89	63.4	74	-17.11	26.91	4.08	37.5	110	160	Peak
2389.11	35.93	42.44	54	-18.07	26.91	4.08	37.5	110	160	Average
2412	91.54	98.01			26.96	4.09	37.52	110	160	Average
2412	94.95	101.42			26.96	4.09	37.52	110	160	Peak
4824	35.18	50.48	54	-18.82	30.99	6.79	53.08	106	129	Average
4824	44.55	59.85	74	-29.45	30.99	6.79	53.08	106	129	Peak

Antennal Polarity & Test Distance: Vertical at 3 m										
Frequency (MHz)	Emission Level (dBuV/m)	Read Level (dBuV)	Limit (dBuV/m)	Margin (dB)	Antenna Factor (dB/m)	Cable Loss (dB)	Preamp Factor (dB)	Antenna Height (cm)	Table Angle (Degree)	Remark
2311.26	57.21	63.96	74	-16.79	26.67	4.03	37.45	101	351	Peak
2389.74	35.79	42.3	54	-18.21	26.91	4.08	37.5	101	351	Average
2412	89.49	95.96			26.96	4.09	37.52	101	351	Average
2412	91.57	98.04			26.96	4.09	37.52	101	351	Peak
4824	33.95	49.25	54	-20.05	30.99	6.79	53.08	107	48	Average
4824	44.12	59.42	74	-29.88	30.99	6.79	53.08	107	48	Peak

Remarks:

- Emission Level = Read Level + Antenna Factor + Cable Loss - Preamp Factor
Margin value = Emission level – Limit value
- 2412 MHz: Fundamental frequency.

EUT Test Condition		Measurement Detail	
Channel	Channel 6	Frequency Range	1 GHz ~ 25 GHz
Input Power	120 Vac, 60 Hz	Detector Function	Peak (PK) Average (AV)
Environmental Conditions	25 deg. C, 65 % RH	Tested By	Gavin Wu

Antennal Polarity & Test Distance: Horizontal at 3 m										
Frequency (MHz)	Emission Level (dBuV/m)	Read Level (dBuV)	Limit (dBuV/m)	Margin (dB)	Antenna Factor (dB/m)	Cable Loss (dB)	Preamp Factor (dB)	Antenna Height (cm)	Table Angle (Degree)	Remark
2327.01	57.22	63.94	74	-16.78	26.72	4.03	37.47	108	160	Peak
2380.83	35.93	42.49	54	-18.07	26.86	4.08	37.5	108	160	Average
2437	91.61	97.89			27.06	4.12	37.46	108	160	Average
2437	94.99	101.27			27.06	4.12	37.46	108	160	Peak
2492.96	36.66	42.55	54	-17.34	27.2	4.16	37.25	108	160	Average
2493	57.26	63.15	74	-16.74	27.2	4.16	37.25	108	160	Peak
4874	35.11	50.25	54	-18.89	31.06	6.85	53.05	105	112	Average
4874	44.74	59.88	74	-29.26	31.06	6.85	53.05	105	112	Peak

Antennal Polarity & Test Distance: Vertical at 3 m										
Frequency (MHz)	Emission Level (dBuV/m)	Read Level (dBuV)	Limit (dBuV/m)	Margin (dB)	Antenna Factor (dB/m)	Cable Loss (dB)	Preamp Factor (dB)	Antenna Height (cm)	Table Angle (Degree)	Remark
2380.2	57.21	63.77	74	-16.79	26.86	4.08	37.5	116	348	Peak
2381.01	35.81	42.37	54	-18.19	26.86	4.08	37.5	116	348	Average
2437	87.79	94.07			27.06	4.12	37.46	116	348	Average
2437	91.09	97.37			27.06	4.12	37.46	116	348	Peak
2485.68	57.35	63.37	74	-16.65	27.15	4.15	37.32	116	348	Peak
2492.48	36.49	42.38	54	-17.51	27.2	4.16	37.25	116	348	Average
4874	34.2	49.34	54	-19.8	31.06	6.85	53.05	100	99	Average
4874	43.82	58.96	74	-30.18	31.06	6.85	53.05	100	99	Peak

Remarks:

- Emission Level = Read Level + Antenna Factor + Cable Loss - Preamp Factor
Margin value = Emission level – Limit value
- 2437 MHz: Fundamental frequency.

EUT Test Condition		Measurement Detail	
Channel	Channel 11	Frequency Range	1 GHz ~ 25 GHz
Input Power	120 Vac, 60 Hz	Detector Function	Peak (PK) Average (AV)
Environmental Conditions	25 deg. C, 65 % RH	Tested By	Gavin Wu

Antennal Polarity & Test Distance: Horizontal at 3 m										
Frequency (MHz)	Emission Level (dBuV/m)	Read Level (dBuV)	Limit (dBuV/m)	Margin (dB)	Antenna Factor (dB/m)	Cable Loss (dB)	Preamp Factor (dB)	Antenna Height (cm)	Table Angle (Degree)	Remark
2462	91.21	97.37			27.1	4.13	37.39	107	163	Average
2462	94.56	100.72			27.1	4.13	37.39	107	163	Peak
2483.52	37.38	43.4	54	-16.62	27.15	4.15	37.32	107	163	Average
2499.68	57.77	63.66	74	-16.23	27.2	4.16	37.25	107	163	Peak
4924	35.74	50.77	54	-18.26	31.12	6.88	53.03	101	147	Average
4924	45.14	60.17	74	-28.86	31.12	6.88	53.03	101	147	Peak
Antennal Polarity & Test Distance: Vertical at 3 m										
Frequency (MHz)	Emission Level (dBuV/m)	Read Level (dBuV)	Limit (dBuV/m)	Margin (dB)	Antenna Factor (dB/m)	Cable Loss (dB)	Preamp Factor (dB)	Antenna Height (cm)	Table Angle (Degree)	Remark
2462	87.82	93.98			27.1	4.13	37.39	130	348	Average
2462	91.31	97.47			27.1	4.13	37.39	130	348	Peak
2483.84	36.72	42.74	54	-17.28	27.15	4.15	37.32	130	348	Average
2490.28	57.69	63.65	74	-16.31	27.2	4.16	37.32	130	348	Peak
4924	34.85	49.88	54	-19.15	31.12	6.88	53.03	106	133	Average
4924	44.66	59.69	74	-29.34	31.12	6.88	53.03	106	133	Peak

Remarks:

- Emission Level = Read Level + Antenna Factor + Cable Loss - Preamp Factor
Margin value = Emission level – Limit value
- 2462 MHz: Fundamental frequency.

EUT Test Condition		Measurement Detail	
Channel	Channel 12	Frequency Range	1 GHz ~ 25 GHz
Input Power	120 Vac, 60 Hz	Detector Function	Peak (PK) Average (AV)
Environmental Conditions	25 deg. C, 65 % RH	Tested By	Gavin Wu

Antennal Polarity & Test Distance: Horizontal at 3 m										
Frequency (MHz)	Emission Level (dBuV/m)	Read Level (dBuV)	Limit (dBuV/m)	Margin (dB)	Antenna Factor (dB/m)	Cable Loss (dB)	Preamp Factor (dB)	Antenna Height (cm)	Table Angle (Degree)	Remark
2467	89.87	95.96			27.1	4.13	37.32	169	359	Average
2467	93.34	99.43			27.1	4.13	37.32	169	359	Peak
2483.52	40.56	46.58	54	-13.44	27.15	4.15	37.32	169	359	Average
2483.76	58.86	64.88	74	-15.14	27.15	4.15	37.32	169	359	Peak
4934	36	51.03	54	-18	31.12	6.88	53.03	113	58	Average
4934	46.72	61.75	74	-27.28	31.12	6.88	53.03	113	58	Peak
Antennal Polarity & Test Distance: Vertical at 3 m										
Frequency (MHz)	Emission Level (dBuV/m)	Read Level (dBuV)	Limit (dBuV/m)	Margin (dB)	Antenna Factor (dB/m)	Cable Loss (dB)	Preamp Factor (dB)	Antenna Height (cm)	Table Angle (Degree)	Remark
2467	86.35	92.44			27.1	4.13	37.32	150	195	Average
2467	89.36	95.45			27.1	4.13	37.32	150	195	Peak
2483.52	39.38	45.4	54	-14.62	27.15	4.15	37.32	150	195	Average
2494.56	58.27	64.16	74	-15.73	27.2	4.16	37.25	150	195	Peak
4934	35.18	50.21	54	-18.82	31.12	6.88	53.03	106	241	Average
4934	46.13	61.16	74	-27.87	31.12	6.88	53.03	106	241	Peak

Remarks:

- Emission Level = Read Level + Antenna Factor + Cable Loss - Preamp Factor
Margin value = Emission level – Limit value
- 2467 MHz: Fundamental frequency.

EUT Test Condition		Measurement Detail	
Channel	Channel 13	Frequency Range	1 GHz ~ 25 GHz
Input Power	120 Vac, 60 Hz	Detector Function	Peak (PK) Average (AV)
Environmental Conditions	25 deg. C, 65 % RH	Tested By	Gavin Wu

Antennal Polarity & Test Distance: Horizontal at 3 m										
Frequency (MHz)	Emission Level (dBuV/m)	Read Level (dBuV)	Limit (dBuV/m)	Margin (dB)	Antenna Factor (dB/m)	Cable Loss (dB)	Preamp Factor (dB)	Antenna Height (cm)	Table Angle (Degree)	Remark
2472	89.8	95.82			27.15	4.15	37.32	168	360	Average
2472	92.93	98.95			27.15	4.15	37.32	168	360	Peak
2486.28	49.15	55.17	54	-4.85	27.15	4.15	37.32	168	360	Average
2486.6	59.91	65.93	74	-14.09	27.15	4.15	37.32	168	360	Peak
4944	35.58	50.57	54	-18.42	31.14	6.91	53.04	107	66	Average
4944	45.77	60.76	74	-28.23	31.14	6.91	53.04	107	66	Peak
Antennal Polarity & Test Distance: Vertical at 3 m										
Frequency (MHz)	Emission Level (dBuV/m)	Read Level (dBuV)	Limit (dBuV/m)	Margin (dB)	Antenna Factor (dB/m)	Cable Loss (dB)	Preamp Factor (dB)	Antenna Height (cm)	Table Angle (Degree)	Remark
2472	86.97	92.99			27.15	4.15	37.32	152	197	Average
2472	90.85	96.87			27.15	4.15	37.32	152	197	Peak
2486.32	47.21	53.23	54	-6.79	27.15	4.15	37.32	152	197	Average
2486.64	58.6	64.62	74	-15.4	27.15	4.15	37.32	152	197	Peak
4944	35.2	50.19	54	-18.8	31.14	6.91	53.04	107	241	Average
4944	45.18	60.17	74	-28.82	31.14	6.91	53.04	107	241	Peak

Remarks:

- Emission Level = Read Level + Antenna Factor + Cable Loss - Preamp Factor
Margin value = Emission level – Limit value
- 2472 MHz: Fundamental frequency.

802.11g

EUT Test Condition		Measurement Detail	
Channel	Channel 1	Frequency Range	1 GHz ~ 25 GHz
Input Power	120 Vac, 60 Hz	Detector Function	Peak (PK) Average (AV)
Environmental Conditions	25 deg. C, 65 % RH	Tested By	Gavin Wu

Antennal Polarity & Test Distance: Horizontal at 3 m										
Frequency (MHz)	Emission Level (dBuV/m)	Read Level (dBuV)	Limit (dBuV/m)	Margin (dB)	Antenna Factor (dB/m)	Cable Loss (dB)	Preamp Factor (dB)	Antenna Height (cm)	Table Angle (Degree)	Remark
2389.2	47.21	53.72	74	-26.79	26.91	4.08	37.5	187	9	Peak
2389.74	36.69	43.2	54	-17.31	26.91	4.08	37.5	187	9	Average
2412	84.73	91.2			26.96	4.09	37.52	187	9	Average
2412	92.54	99.01			26.96	4.09	37.52	187	9	Peak
4824	34.78	50.08	54	-19.22	30.99	6.79	53.08	109	111	Average
4824	45.35	60.65	74	-28.65	30.99	6.79	53.08	109	111	Peak
Antennal Polarity & Test Distance: Vertical at 3 m										
Frequency (MHz)	Emission Level (dBuV/m)	Read Level (dBuV)	Limit (dBuV/m)	Margin (dB)	Antenna Factor (dB/m)	Cable Loss (dB)	Preamp Factor (dB)	Antenna Height (cm)	Table Angle (Degree)	Remark
2377.14	47.6	54.17	74	-26.4	26.86	4.07	37.5	202	353	Peak
2389.92	36.85	43.38	54	-17.15	26.91	4.08	37.52	202	353	Average
2412	82.17	88.64			26.96	4.09	37.52	202	353	Average
2412	89.8	96.27			26.96	4.09	37.52	202	353	Peak
4824	33.92	49.22	54	-20.08	30.99	6.79	53.08	100	162	Average
4824	44.66	59.96	74	-29.34	30.99	6.79	53.08	100	162	Peak

Remarks:

- Emission Level = Read Level + Antenna Factor + Cable Loss - Preamp Factor
Margin value = Emission level – Limit value
- 2412 MHz: Fundamental frequency.

EUT Test Condition		Measurement Detail	
Channel	Channel 6	Frequency Range	1 GHz ~ 25 GHz
Input Power	120 Vac, 60 Hz	Detector Function	Peak (PK) Average (AV)
Environmental Conditions	25 deg. C, 65 % RH	Tested By	Gavin Wu

Antennal Polarity & Test Distance: Horizontal at 3 m										
Frequency (MHz)	Emission Level (dBuV/m)	Read Level (dBuV)	Limit (dBuV/m)	Margin (dB)	Antenna Factor (dB/m)	Cable Loss (dB)	Preamp Factor (dB)	Antenna Height (cm)	Table Angle (Degree)	Remark
2361.57	46.81	53.44	74	-27.19	26.81	4.05	37.49	208	2	Peak
2383.71	36.61	43.17	54	-17.39	26.86	4.08	37.5	208	2	Average
2437	83.41	89.69			27.06	4.12	37.46	208	2	Average
2437	92.55	98.83			27.06	4.12	37.46	208	2	Peak
2489.4	38.5	44.46	54	-15.5	27.2	4.16	37.32	208	2	Average
2489.44	48.14	54.1	74	-25.86	27.2	4.16	37.32	208	2	Peak
4874	34.93	50.07	54	-19.07	31.06	6.85	53.05	102	144	Average
4874	44.4	59.54	74	-29.6	31.06	6.85	53.05	102	144	Peak
Antennal Polarity & Test Distance: Vertical at 3 m										
Frequency (MHz)	Emission Level (dBuV/m)	Read Level (dBuV)	Limit (dBuV/m)	Margin (dB)	Antenna Factor (dB/m)	Cable Loss (dB)	Preamp Factor (dB)	Antenna Height (cm)	Table Angle (Degree)	Remark
2329.35	46.68	53.39	74	-27.32	26.72	4.04	37.47	202	348	Peak
2384.97	36.74	43.3	54	-17.26	26.86	4.08	37.5	202	348	Average
2437	82.73	89.01			27.06	4.12	37.46	202	348	Average
2437	89.95	96.23			27.06	4.12	37.46	202	348	Peak
2489.12	37.98	43.94	54	-16.02	27.2	4.16	37.32	202	348	Average
2496.28	47.98	53.87	74	-26.02	27.2	4.16	37.25	202	348	Peak
4874	34.4	49.54	54	-19.6	31.06	6.85	53.05	100	136	Average
4874	43.84	58.98	74	-30.16	31.06	6.85	53.05	100	136	Peak

Remarks:

- Emission Level = Read Level + Antenna Factor + Cable Loss - Preamp Factor
Margin value = Emission level – Limit value
- 2437 MHz: Fundamental frequency.

EUT Test Condition		Measurement Detail	
Channel	Channel 11	Frequency Range	1 GHz ~ 25 GHz
Input Power	120 Vac, 60 Hz	Detector Function	Peak (PK) Average (AV)
Environmental Conditions	25 deg. C, 65 % RH	Tested By	Gavin Wu

Antennal Polarity & Test Distance: Horizontal at 3 m										
Frequency (MHz)	Emission Level (dBuV/m)	Read Level (dBuV)	Limit (dBuV/m)	Margin (dB)	Antenna Factor (dB/m)	Cable Loss (dB)	Preamp Factor (dB)	Antenna Height (cm)	Table Angle (Degree)	Remark
2462	84.38	90.54			27.1	4.13	37.39	205	1	Average
2462	92.03	98.19			27.1	4.13	37.39	205	1	Peak
2483.6	44.53	50.55	54	-9.47	27.15	4.15	37.32	205	1	Average
2483.64	60.87	66.89	74	-13.13	27.15	4.15	37.32	205	1	Peak
4924	35.34	50.37	54	-18.66	31.12	6.88	53.03	112	132	Average
4924	43.01	58.04	74	-30.99	31.12	6.88	53.03	112	132	Peak
Antennal Polarity & Test Distance: Vertical at 3 m										
Frequency (MHz)	Emission Level (dBuV/m)	Read Level (dBuV)	Limit (dBuV/m)	Margin (dB)	Antenna Factor (dB/m)	Cable Loss (dB)	Preamp Factor (dB)	Antenna Height (cm)	Table Angle (Degree)	Remark
2462	82.09	88.25			27.1	4.13	37.39	196	347	Average
2462	89.7	95.86			27.1	4.13	37.39	196	347	Peak
2483.72	41.82	47.84	54	-12.18	27.15	4.15	37.32	196	347	Average
2483.96	56.93	62.95	74	-17.07	27.15	4.15	37.32	196	347	Peak
4924	34.44	49.47	54	-19.56	31.12	6.88	53.03	100	122	Average
4924	44.38	59.41	74	-29.62	31.12	6.88	53.03	100	122	Peak

Remarks:

- Emission Level = Read Level + Antenna Factor + Cable Loss - Preamp Factor
Margin value = Emission level – Limit value
- 2462 MHz: Fundamental frequency.

EUT Test Condition		Measurement Detail	
Channel	Channel 12	Frequency Range	1 GHz ~ 25 GHz
Input Power	120 Vac, 60 Hz	Detector Function	Peak (PK) Average (AV)
Environmental Conditions	25 deg. C, 65 % RH	Tested By	Gavin Wu

Antennal Polarity & Test Distance: Horizontal at 3 m										
Frequency (MHz)	Emission Level (dBuV/m)	Read Level (dBuV)	Limit (dBuV/m)	Margin (dB)	Antenna Factor (dB/m)	Cable Loss (dB)	Preamp Factor (dB)	Antenna Height (cm)	Table Angle (Degree)	Remark
2467	85.16	91.25			27.1	4.13	37.32	168	359	Average
2467	93.08	99.17			27.1	4.13	37.32	168	359	Peak
2483.56	51.56	57.58	54	-2.44	27.15	4.15	37.32	168	359	Average
2485.48	67.12	73.14	74	-6.88	27.15	4.15	37.32	168	359	Peak
4934	35.56	50.59	54	-18.44	31.12	6.88	53.03	107	73	Average
4934	45.64	60.67	74	-28.36	31.12	6.88	53.03	107	73	Peak
Antennal Polarity & Test Distance: Vertical at 3 m										
Frequency (MHz)	Emission Level (dBuV/m)	Read Level (dBuV)	Limit (dBuV/m)	Margin (dB)	Antenna Factor (dB/m)	Cable Loss (dB)	Preamp Factor (dB)	Antenna Height (cm)	Table Angle (Degree)	Remark
2467	82.5	88.59			27.1	4.13	37.32	169	196	Average
2467	90.14	96.23			27.1	4.13	37.32	169	196	Peak
2483.56	49.48	55.5	54	-4.52	27.15	4.15	37.32	169	196	Average
2484.68	66.44	72.46	74	-7.56	27.15	4.15	37.32	169	196	Peak
4934	35.18	50.21	54	-18.82	31.12	6.88	53.03	108	220	Average
4934	45.41	60.44	74	-28.59	31.12	6.88	53.03	108	220	Peak

Remarks:

- Emission Level = Read Level + Antenna Factor + Cable Loss - Preamp Factor
Margin value = Emission level – Limit value
- 2467 MHz: Fundamental frequency.

EUT Test Condition		Measurement Detail	
Channel	Channel 13	Frequency Range	1 GHz ~ 25 GHz
Input Power	120 Vac, 60 Hz	Detector Function	Peak (PK) Average (AV)
Environmental Conditions	25 deg. C, 65 % RH	Tested By	Gavin Wu

Antennal Polarity & Test Distance: Horizontal at 3 m										
Frequency (MHz)	Emission Level (dBuV/m)	Read Level (dBuV)	Limit (dBuV/m)	Margin (dB)	Antenna Factor (dB/m)	Cable Loss (dB)	Preamp Factor (dB)	Antenna Height (cm)	Table Angle (Degree)	Remark
2472	84.15	90.17			27.15	4.15	37.32	204	0	Average
2472	91.54	97.56			27.15	4.15	37.32	204	0	Peak
2483.52	53.7	59.72	54	-0.3	27.15	4.15	37.32	204	0	Average
2483.56	68.29	74.31	74	-5.71	27.15	4.15	37.32	204	0	Peak
4944	35.89	50.88	54	-18.11	31.14	6.91	53.04	104	71	Average
4944	43.83	58.82	74	-30.17	31.14	6.91	53.04	104	71	Peak
Antennal Polarity & Test Distance: Vertical at 3 m										
Frequency (MHz)	Emission Level (dBuV/m)	Read Level (dBuV)	Limit (dBuV/m)	Margin (dB)	Antenna Factor (dB/m)	Cable Loss (dB)	Preamp Factor (dB)	Antenna Height (cm)	Table Angle (Degree)	Remark
2472	78.97	84.99			27.15	4.15	37.32	219	352	Average
2472	86.67	92.69			27.15	4.15	37.32	219	352	Peak
2483.52	48.05	54.07	54	-5.95	27.15	4.15	37.32	219	352	Average
2483.52	63.22	69.24	74	-10.78	27.15	4.15	37.32	219	352	Peak
4944	35.31	50.3	54	-18.69	31.14	6.91	53.04	108	261	Average
4944	42.52	57.51	74	-31.48	31.14	6.91	53.04	108	261	Peak

Remarks:

- Emission Level = Read Level + Antenna Factor + Cable Loss - Preamp Factor
Margin value = Emission level – Limit value
- 2472 MHz: Fundamental frequency.

802.11n (HT20)

EUT Test Condition		Measurement Detail	
Channel	Channel 1	Frequency Range	1 GHz ~ 25 GHz
Input Power	120 Vac, 60 Hz	Detector Function	Peak (PK) Average (AV)
Environmental Conditions	25 deg. C, 65 % RH	Tested By	Gavin Wu

Antennal Polarity & Test Distance: Horizontal at 3 m

Frequency (MHz)	Emission Level (dBuV/m)	Read Level (dBuV)	Limit (dBuV/m)	Margin (dB)	Antenna Factor (dB/m)	Cable Loss (dB)	Preamp Factor (dB)	Antenna Height (cm)	Table Angle (Degree)	Remark
2389.38	51.51	58.02	74	-22.49	26.91	4.08	37.5	108	174	Peak
2389.83	38.52	45.05	54	-15.48	26.91	4.08	37.52	108	174	Average
2412	84.14	90.61			26.96	4.09	37.52	108	174	Average
2412	92.71	99.18			26.96	4.09	37.52	108	174	Peak
4824	35.09	50.39	54	-18.91	30.99	6.79	53.08	104	115	Average
4824	46.06	61.36	74	-27.94	30.99	6.79	53.08	104	115	Peak

Antennal Polarity & Test Distance: Vertical at 3 m

Frequency (MHz)	Emission Level (dBuV/m)	Read Level (dBuV)	Limit (dBuV/m)	Margin (dB)	Antenna Factor (dB/m)	Cable Loss (dB)	Preamp Factor (dB)	Antenna Height (cm)	Table Angle (Degree)	Remark
2388.57	49.72	56.23	74	-24.28	26.91	4.08	37.5	201	356	Peak
2389.92	37.49	44.02	54	-16.51	26.91	4.08	37.52	201	356	Average
2412	82.16	88.63			26.96	4.09	37.52	201	356	Average
2412	89.83	96.3			26.96	4.09	37.52	201	356	Peak
4824	34.11	49.41	54	-19.89	30.99	6.79	53.08	105	118	Average
4824	44.25	59.55	74	-29.75	30.99	6.79	53.08	105	118	Peak

Remarks:

- Emission Level = Read Level + Antenna Factor + Cable Loss - Preamp Factor
Margin value = Emission level – Limit value
- 2412 MHz: Fundamental frequency.

EUT Test Condition		Measurement Detail	
Channel	Channel 6	Frequency Range	1 GHz ~ 25 GHz
Input Power	120 Vac, 60 Hz	Detector Function	Peak (PK) Average (AV)
Environmental Conditions	25 deg. C, 65 % RH	Tested By	Gavin Wu

Antennal Polarity & Test Distance: Horizontal at 3 m										
Frequency (MHz)	Emission Level (dBuV/m)	Read Level (dBuV)	Limit (dBuV/m)	Margin (dB)	Antenna Factor (dB/m)	Cable Loss (dB)	Preamp Factor (dB)	Antenna Height (cm)	Table Angle (Degree)	Remark
2385.15	47.82	54.38	74	-26.18	26.86	4.08	37.5	108	180	Peak
2385.24	37.54	44.1	54	-16.46	26.86	4.08	37.5	108	180	Average
2437	84.73	91.01			27.06	4.12	37.46	108	180	Average
2437	92.35	98.63			27.06	4.12	37.46	108	180	Peak
2488.4	38.89	44.85	54	-15.11	27.2	4.16	37.32	108	180	Average
2489.64	48.14	54.1	74	-25.86	27.2	4.16	37.32	108	180	Peak
4874	35.53	50.67	54	-18.47	31.06	6.85	53.05	103	229	Average
4874	44.68	59.82	74	-29.32	31.06	6.85	53.05	103	229	Peak
Antennal Polarity & Test Distance: Vertical at 3 m										
Frequency (MHz)	Emission Level (dBuV/m)	Read Level (dBuV)	Limit (dBuV/m)	Margin (dB)	Antenna Factor (dB/m)	Cable Loss (dB)	Preamp Factor (dB)	Antenna Height (cm)	Table Angle (Degree)	Remark
2385.33	36.9	43.46	54	-17.1	26.86	4.08	37.5	203	349	Average
2386.5	46.9	53.41	74	-27.1	26.91	4.08	37.5	203	349	Peak
2437	82.12	88.4			27.06	4.12	37.46	203	349	Average
2437	89	95.28			27.06	4.12	37.46	203	349	Peak
2488.64	47.96	53.92	74	-26.04	27.2	4.16	37.32	203	349	Peak
2488.88	38.43	44.39	54	-15.57	27.2	4.16	37.32	203	349	Average
4874	34.36	49.5	54	-19.64	31.06	6.85	53.05	108	205	Average
4874	43.91	59.05	74	-30.09	31.06	6.85	53.05	108	205	Peak

Remarks:

- Emission Level = Read Level + Antenna Factor + Cable Loss - Preamp Factor
Margin value = Emission level – Limit value
- 2437 MHz: Fundamental frequency.

EUT Test Condition		Measurement Detail	
Channel	Channel 11	Frequency Range	1 GHz ~ 25 GHz
Input Power	120 Vac, 60 Hz	Detector Function	Peak (PK) Average (AV)
Environmental Conditions	25 deg. C, 65 % RH	Tested By	Gavin Wu

Antennal Polarity & Test Distance: Horizontal at 3 m										
Frequency (MHz)	Emission Level (dBuV/m)	Read Level (dBuV)	Limit (dBuV/m)	Margin (dB)	Antenna Factor (dB/m)	Cable Loss (dB)	Preamp Factor (dB)	Antenna Height (cm)	Table Angle (Degree)	Remark
2462	84.1	90.26			27.1	4.13	37.39	106	182	Average
2462	92.68	98.84			27.1	4.13	37.39	106	182	Peak
2483.52	48.11	54.13	54	-5.89	27.15	4.15	37.32	106	182	Average
2485.28	63.93	69.95	74	-10.07	27.15	4.15	37.32	106	182	Peak
4924	35.57	50.6	54	-18.43	31.12	6.88	53.03	104	177	Average
4924	45.07	60.1	74	-28.93	31.12	6.88	53.03	104	177	Peak
Antennal Polarity & Test Distance: Vertical at 3 m										
Frequency (MHz)	Emission Level (dBuV/m)	Read Level (dBuV)	Limit (dBuV/m)	Margin (dB)	Antenna Factor (dB/m)	Cable Loss (dB)	Preamp Factor (dB)	Antenna Height (cm)	Table Angle (Degree)	Remark
2462	82.35	88.51			27.1	4.13	37.39	178	352	Average
2462	89.72	95.88			27.1	4.13	37.39	178	352	Peak
2483.52	45.05	51.07	54	-8.95	27.15	4.15	37.32	178	352	Average
2484.44	61.21	67.23	74	-12.79	27.15	4.15	37.32	178	352	Peak
4924	34.43	49.46	54	-19.57	31.12	6.88	53.03	102	168	Average
4924	44.66	59.69	74	-29.34	31.12	6.88	53.03	102	168	Peak

Remarks:

- Emission Level = Read Level + Antenna Factor + Cable Loss - Preamp Factor
Margin value = Emission level – Limit value
- 2462 MHz: Fundamental frequency.

EUT Test Condition		Measurement Detail	
Channel	Channel 12	Frequency Range	1 GHz ~ 25 GHz
Input Power	120 Vac, 60 Hz	Detector Function	Peak (PK) Average (AV)
Environmental Conditions	25 deg. C, 65 % RH	Tested By	Gavin Wu

Antennal Polarity & Test Distance: Horizontal at 3 m										
Frequency (MHz)	Emission Level (dBuV/m)	Read Level (dBuV)	Limit (dBuV/m)	Margin (dB)	Antenna Factor (dB/m)	Cable Loss (dB)	Preamp Factor (dB)	Antenna Height (cm)	Table Angle (Degree)	Remark
2467	84.94	91.03			27.1	4.13	37.32	204	358	Average
2467	92.76	98.85			27.1	4.13	37.32	204	358	Peak
2483.56	52.29	58.31	54	-1.71	27.15	4.15	37.32	204	358	Average
2484.72	67.3	73.32	74	-6.7	27.15	4.15	37.32	204	358	Peak
4934	35.33	50.36	54	-18.67	31.12	6.88	53.03	109	62	Average
4934	44.7	59.73	74	-29.3	31.12	6.88	53.03	109	62	Peak
Antennal Polarity & Test Distance: Vertical at 3 m										
Frequency (MHz)	Emission Level (dBuV/m)	Read Level (dBuV)	Limit (dBuV/m)	Margin (dB)	Antenna Factor (dB/m)	Cable Loss (dB)	Preamp Factor (dB)	Antenna Height (cm)	Table Angle (Degree)	Remark
2467	82.49	51.26			27.1	4.13	0	207	354	Average
2467	89.95	58.72			27.1	4.13	0	207	354	Peak
2483.76	46.15	52.17	54	-7.85	27.15	4.15	37.32	207	354	Average
2484	61.81	67.83	74	-12.19	27.15	4.15	37.32	207	354	Peak
4934	35.2	50.23	54	-18.8	31.12	6.88	53.03	105	223	Average
4934	45.65	60.68	74	-28.35	31.12	6.88	53.03	105	223	Peak

Remarks:

- Emission Level = Read Level + Antenna Factor + Cable Loss - Preamp Factor
Margin value = Emission level – Limit value
- 2467 MHz: Fundamental frequency.

EUT Test Condition		Measurement Detail	
Channel	Channel 13	Frequency Range	1 GHz ~ 25 GHz
Input Power	120 Vac, 60 Hz	Detector Function	Peak (PK) Average (AV)
Environmental Conditions	25 deg. C, 65 % RH	Tested By	Gavin Wu

Antennal Polarity & Test Distance: Horizontal at 3 m										
Frequency (MHz)	Emission Level (dBuV/m)	Read Level (dBuV)	Limit (dBuV/m)	Margin (dB)	Antenna Factor (dB/m)	Cable Loss (dB)	Preamp Factor (dB)	Antenna Height (cm)	Table Angle (Degree)	Remark
2472	82.68	88.7			27.15	4.15	37.32	204	0	Average
2472	90.6	96.62			27.15	4.15	37.32	204	0	Peak
2483.52	53.48	59.5	54	-0.52	27.15	4.15	37.32	204	0	Average
2483.56	68.89	74.91	74	-5.11	27.15	4.15	37.32	204	0	Peak
4944	35.13	50.12	54	-18.87	31.14	6.91	53.04	105	70	Average
4944	44.16	59.15	74	-29.84	31.14	6.91	53.04	105	70	Peak
Antennal Polarity & Test Distance: Vertical at 3 m										
Frequency (MHz)	Emission Level (dBuV/m)	Read Level (dBuV)	Limit (dBuV/m)	Margin (dB)	Antenna Factor (dB/m)	Cable Loss (dB)	Preamp Factor (dB)	Antenna Height (cm)	Table Angle (Degree)	Remark
2472	78.36	84.38			27.15	4.15	37.32	219	358	Average
2472	85.25	91.27			27.15	4.15	37.32	219	358	Peak
2483.52	47.56	53.58	54	-6.44	27.15	4.15	37.32	219	358	Average
2483.6	63.23	69.25	74	-10.77	27.15	4.15	37.32	219	358	Peak
4944	35.11	50.1	54	-18.89	31.14	6.91	53.04	107	245	Average
4944	42.99	57.98	74	-31.01	31.14	6.91	53.04	107	245	Peak

Remarks:

- Emission Level = Read Level + Antenna Factor + Cable Loss - Preamp Factor
Margin value = Emission level – Limit value
- 2472 MHz: Fundamental frequency.

Mode 2
802.11g

EUT Test Condition		Measurement Detail	
Channel	Channel 13	Frequency Range	1 GHz ~ 25 GHz
Input Power	120 Vac, 60 Hz	Detector Function	Peak (PK) Average (AV)
Environmental Conditions	25 deg. C, 65 % RH	Tested By	Gavin Wu

Antennal Polarity & Test Distance: Horizontal at 3 m

Frequency (MHz)	Emission Level (dBuV/m)	Read Level (dBuV)	Limit (dBuV/m)	Margin (dB)	Antenna Factor (dB/m)	Cable Loss (dB)	Preamp Factor (dB)	Antenna Height (cm)	Table Angle (Degree)	Remark
2472	78.58	84.6			27.15	4.15	37.32	105	358	Average
2472	86.29	92.31			27.15	4.15	37.32	105	358	Peak
2483.52	47.06	53.08	54	-6.94	27.15	4.15	37.32	105	358	Average
2483.52	63.59	69.61	74	-10.41	27.15	4.15	37.32	105	358	Peak
4944	34.92	49.91	54	-19.08	31.14	6.91	53.04	104	154	Average
4944	43.98	58.97	74	-30.02	31.14	6.91	53.04	104	154	Peak

Antennal Polarity & Test Distance: Vertical at 3 m

Frequency (MHz)	Emission Level (dBuV/m)	Read Level (dBuV)	Limit (dBuV/m)	Margin (dB)	Antenna Factor (dB/m)	Cable Loss (dB)	Preamp Factor (dB)	Antenna Height (cm)	Table Angle (Degree)	Remark
2472	76.21	82.23			27.15	4.15	37.32	130	199	Average
2472	84.11	90.13			27.15	4.15	37.32	130	199	Peak
2483.52	45.91	51.93	54	-8.09	27.15	4.15	37.32	130	199	Average
2483.56	60.45	66.47	74	-13.55	27.15	4.15	37.32	130	199	Peak
4944	34.84	49.83	54	-19.16	31.14	6.91	53.04	100	157	Average
4944	44.2	59.19	74	-29.8	31.14	6.91	53.04	100	157	Peak

Remarks:

- Emission Level = Read Level + Antenna Factor + Cable Loss - Preamp Factor
Margin value = Emission level – Limit value
- 2472 MHz: Fundamental frequency.

Mode 3
802.11g

EUT Test Condition		Measurement Detail	
Channel	Channel 13	Frequency Range	1 GHz ~ 25 GHz
Input Power	120 Vac, 60 Hz	Detector Function	Peak (PK) Average (AV)
Environmental Conditions	25 deg. C, 65 % RH	Tested By	Gavin Wu

Antennal Polarity & Test Distance: Horizontal at 3 m										
Frequency (MHz)	Emission Level (dBuV/m)	Read Level (dBuV)	Limit (dBuV/m)	Margin (dB)	Antenna Factor (dB/m)	Cable Loss (dB)	Preamp Factor (dB)	Antenna Height (cm)	Table Angle (Degree)	Remark
2472	81.49	87.51			27.15	4.15	37.32	106	325	Average
2472	89	95.02			27.15	4.15	37.32	106	325	Peak
2483.52	51	57.02	54	-3	27.15	4.15	37.32	106	325	Average
2483.64	65.8	71.82	74	-8.2	27.15	4.15	37.32	106	325	Peak
4944	35.25	50.24	54	-18.75	31.14	6.91	53.04	100	126	Average
4944	45.19	60.18	74	-28.81	31.14	6.91	53.04	100	126	Peak
Antennal Polarity & Test Distance: Vertical at 3 m										
Frequency (MHz)	Emission Level (dBuV/m)	Read Level (dBuV)	Limit (dBuV/m)	Margin (dB)	Antenna Factor (dB/m)	Cable Loss (dB)	Preamp Factor (dB)	Antenna Height (cm)	Table Angle (Degree)	Remark
2472	75.25	81.27			27.15	4.15	37.32	100	0	Average
2472	83.18	89.2			27.15	4.15	37.32	100	0	Peak
2483.52	46.06	52.08	54	-7.94	27.15	4.15	37.32	100	0	Average
2483.84	61.19	67.21	74	-12.81	27.15	4.15	37.32	100	0	Peak
4944	35.18	50.17	54	-18.82	31.14	6.91	53.04	105	118	Average
4944	44.84	59.83	74	-29.16	31.14	6.91	53.04	105	118	Peak

Remarks:

- Emission Level = Read Level + Antenna Factor + Cable Loss - Preamp Factor
Margin value = Emission level – Limit value
- 2472 MHz: Fundamental frequency.

Mode 4
802.11g

EUT Test Condition		Measurement Detail	
Channel	Channel 13	Frequency Range	1 GHz ~ 25 GHz
Input Power	120 Vac, 60 Hz	Detector Function	Peak (PK) Average (AV)
Environmental Conditions	25 deg. C, 65 % RH	Tested By	Gavin Wu

Antennal Polarity & Test Distance: Horizontal at 3 m

Frequency (MHz)	Emission Level (dBuV/m)	Read Level (dBuV)	Limit (dBuV/m)	Margin (dB)	Antenna Factor (dB/m)	Cable Loss (dB)	Preamp Factor (dB)	Antenna Height (cm)	Table Angle (Degree)	Remark
2472	77.55	83.57			27.15	4.15	37.32	152	341	Average
2472	85.19	91.21			27.15	4.15	37.32	152	341	Peak
2483.52	46.11	52.13	54	-7.89	27.15	4.15	37.32	152	341	Average
2483.52	61.84	67.86	74	-12.16	27.15	4.15	37.32	152	341	Peak
4944	35.32	50.31	54	-18.68	31.14	6.91	53.04	100	162	Average
4944	44.85	59.84	74	-29.15	31.14	6.91	53.04	100	162	Peak

Antennal Polarity & Test Distance: Vertical at 3 m

Frequency (MHz)	Emission Level (dBuV/m)	Read Level (dBuV)	Limit (dBuV/m)	Margin (dB)	Antenna Factor (dB/m)	Cable Loss (dB)	Preamp Factor (dB)	Antenna Height (cm)	Table Angle (Degree)	Remark
2472	74.99	81.01			27.15	4.15	37.32	100	176	Average
2472	82.82	88.84			27.15	4.15	37.32	100	176	Peak
2483.52	43.42	49.44	54	-10.58	27.15	4.15	37.32	100	176	Average
2483.68	59.57	65.59	74	-14.43	27.15	4.15	37.32	100	176	Peak
4944	35.12	50.11	54	-18.88	31.14	6.91	53.04	108	174	Average
4944	44.54	59.53	74	-29.46	31.14	6.91	53.04	108	174	Peak

Remarks:

- Emission Level = Read Level + Antenna Factor + Cable Loss - Preamp Factor
Margin value = Emission level – Limit value
- 2472 MHz: Fundamental frequency.

9 kHz ~ 30 MHz DATA:

The amplitude of spurious emissions attenuated more than 20 dB below the permissible value is not required to be report.

30 MHz ~ 1 GHz WORST-CASE DATA:

802.11g

Mode 1

EUT Test Condition		Measurement Detail	
Channel	Channel 13	Frequency Range	30 MHz ~ 1 GHz
Input Power	120 Vac, 60 Hz	Detector Function	Peak (PK) Quasi-peak (QP)
Environmental Conditions	25 deg. C, 65 % RH	Tested By	Gavin Wu

Antennal Polarity & Test Distance: Horizontal at 3 m										
Frequency (MHz)	Emission Level (dBuV/m)	Read Level (dBuV)	Limit (dBuV/m)	Margin (dB)	Antenna Factor (dB/m)	Cable Loss (dB)	Preamp Factor (dB)	Antenna Height (cm)	Table Angle (Degree)	Remark
94.99	23.92	46.18	43.5	-19.58	8.68	1.02	31.96	121	301	Peak
159.98	27.64	45.64	43.5	-15.86	12.73	1.15	31.88	140	145	Peak
192.96	24.55	45.14	43.5	-18.95	9.84	1.27	31.7	128	243	Peak
353.01	25.5	41.39	46	-20.5	14.22	1.77	31.88	139	37	Peak
417.03	26.22	40.63	46	-19.78	15.68	1.94	32.03	131	107	Peak
481.05	29.17	42.01	46	-16.83	16.95	2.05	31.84	137	269	Peak
Antennal Polarity & Test Distance: Vertical at 3 m										
Frequency (MHz)	Emission Level (dBuV/m)	Read Level (dBuV)	Limit (dBuV/m)	Margin (dB)	Antenna Factor (dB/m)	Cable Loss (dB)	Preamp Factor (dB)	Antenna Height (cm)	Table Angle (Degree)	Remark
30.97	28.67	47.06	40	-11.33	12.14	0.59	31.12	116	180	Peak
93.05	23.64	46.08	43.5	-19.86	8.53	0.99	31.96	102	81	Peak
418	23.44	37.84	46	-22.56	15.7	1.94	32.04	129	320	Peak
481.05	28.71	41.55	46	-17.29	16.95	2.05	31.84	128	121	Peak
545.07	25.8	37.12	46	-20.2	18.35	2.17	31.84	127	96	Peak
577.08	26.13	36.94	46	-19.87	19.08	2.22	32.11	112	300	Peak

Remarks:

- Emission Level = Read Level + Antenna Factor + Cable Loss - Preamp Factor
Margin value = Emission level – Limit value

Mode 2

EUT Test Condition		Measurement Detail	
Channel	Channel 13	Frequency Range	30 MHz ~ 1 GHz
Input Power	120 Vac, 60 Hz	Detector Function	Peak (PK) Quasi-peak (QP)
Environmental Conditions	25 deg. C, 65 % RH	Tested By	Gavin Wu

Antennal Polarity & Test Distance: Horizontal at 3 m										
Frequency (MHz)	Emission Level (dBuV/m)	Read Level (dBuV)	Limit (dBuV/m)	Margin (dB)	Antenna Factor (dB/m)	Cable Loss (dB)	Preamp Factor (dB)	Antenna Height (cm)	Table Angle (Degree)	Remark
121.18	32.72	52.37	43.5	-10.78	11.09	1.16	31.9	110	136	Peak
140.58	22.2	40.31	43.5	-21.3	12.37	1.16	31.64	107	198	Peak
233.7	23.77	43.38	46	-22.23	10.79	1.43	31.83	124	131	Peak
434.49	24.36	38.39	46	-21.64	16.02	1.96	32.01	121	238	Peak
600.36	21.84	32.22	46	-24.16	19.61	2.26	32.25	137	175	Peak
653.71	22.91	32.28	46	-23.09	20.26	2.36	31.99	124	320	Peak

Antennal Polarity & Test Distance: Vertical at 3 m										
Frequency (MHz)	Emission Level (dBuV/m)	Read Level (dBuV)	Limit (dBuV/m)	Margin (dB)	Antenna Factor (dB/m)	Cable Loss (dB)	Preamp Factor (dB)	Antenna Height (cm)	Table Angle (Degree)	Remark
30	31.47	50.05	40	-8.53	11.98	0.58	31.14	111	123	Peak
40.67	31.43	48.25	40	-8.57	13.55	0.65	31.02	139	210	Peak
67.83	28.51	48.39	40	-11.49	11	0.85	31.73	126	186	Peak
574.17	31.31	42.18	46	-14.69	19.01	2.22	32.1	126	18	Peak
628.49	22.73	32.62	46	-23.27	19.95	2.31	32.15	116	142	Peak
701.24	23.57	32.07	46	-22.43	20.83	2.45	31.78	131	41	Peak

Remarks:

- Emission Level = Read Level + Antenna Factor + Cable Loss - Preamp Factor
Margin value = Emission level – Limit value

Mode 3

EUT Test Condition		Measurement Detail	
Channel	Channel 13	Frequency Range	30 MHz ~ 1 GHz
Input Power	120 Vac, 60 Hz	Detector Function	Peak (PK) Quasi-peak (QP)
Environmental Conditions	25 deg. C, 65 % RH	Tested By	Gavin Wu

Antennal Polarity & Test Distance: Horizontal at 3 m

Frequency (MHz)	Emission Level (dBuV/m)	Read Level (dBuV)	Limit (dBuV/m)	Margin (dB)	Antenna Factor (dB/m)	Cable Loss (dB)	Preamp Factor (dB)	Antenna Height (cm)	Table Angle (Degree)	Remark
119.24	28.08	47.89	43.5	-15.42	10.93	1.15	31.89	111	107	Peak
155.13	24.64	42.55	43.5	-18.86	12.72	1.11	31.74	134	303	Peak
224.97	26.53	46.49	46	-19.47	10.42	1.4	31.78	123	85	Peak
320.03	25.4	42.17	46	-20.6	13.43	1.69	31.89	130	220	Peak
534.4	29.06	40.52	46	-16.94	18.1	2.15	31.71	111	286	Peak
603.27	27.3	37.59	46	-18.7	19.65	2.26	32.2	115	162	Peak

Antennal Polarity & Test Distance: Vertical at 3 m

Frequency (MHz)	Emission Level (dBuV/m)	Read Level (dBuV)	Limit (dBuV/m)	Margin (dB)	Antenna Factor (dB/m)	Cable Loss (dB)	Preamp Factor (dB)	Antenna Height (cm)	Table Angle (Degree)	Remark
30.97	26.52	44.91	40	-13.48	12.14	0.59	31.12	101	272	Peak
43.58	26.54	43.39	40	-13.46	13.59	0.67	31.11	110	293	Peak
62.98	26.98	46.06	40	-13.02	11.59	0.83	31.5	118	39	Peak
118.27	28.32	48.23	43.5	-15.18	10.83	1.15	31.89	119	168	Peak
507.24	22.52	34.53	46	-23.48	17.48	2.11	31.6	126	355	Peak
638.19	27.16	36.86	46	-18.84	20.07	2.33	32.1	136	312	Peak

Remarks:

- Emission Level = Read Level + Antenna Factor + Cable Loss - Preamp Factor
Margin value = Emission level – Limit value

Mode 4

EUT Test Condition		Measurement Detail	
Channel	Channel 13	Frequency Range	30 MHz ~ 1 GHz
Input Power	120 Vac, 60 Hz	Detector Function	Peak (PK) Quasi-peak (QP)
Environmental Conditions	25 deg. C, 65 % RH	Tested By	Gavin Wu

Antennal Polarity & Test Distance: Horizontal at 3 m

Frequency (MHz)	Emission Level (dBuV/m)	Read Level (dBuV)	Limit (dBuV/m)	Margin (dB)	Antenna Factor (dB/m)	Cable Loss (dB)	Preamp Factor (dB)	Antenna Height (cm)	Table Angle (Degree)	Remark
120.21	30.75	50.47	43.5	-12.75	11.02	1.16	31.9	112	34	Peak
230.79	24.89	44.66	46	-21.11	10.66	1.42	31.85	105	89	Peak
317.12	26.29	43.16	46	-19.71	13.36	1.68	31.91	118	56	Peak
459.71	26.5	39.96	46	-19.5	16.52	2.01	31.99	135	68	Peak
530.52	30.14	41.67	46	-15.86	18.02	2.14	31.69	133	41	Peak
605.21	26.77	37	46	-19.23	19.67	2.27	32.17	112	80	Peak

Antennal Polarity & Test Distance: Vertical at 3 m

Frequency (MHz)	Emission Level (dBuV/m)	Read Level (dBuV)	Limit (dBuV/m)	Margin (dB)	Antenna Factor (dB/m)	Cable Loss (dB)	Preamp Factor (dB)	Antenna Height (cm)	Table Angle (Degree)	Remark
42.61	31.1	47.94	40	-8.9	13.58	0.66	31.08	128	257	Peak
62.98	28.64	47.72	40	-11.36	11.59	0.83	31.5	135	116	Peak
118.27	28.11	48.02	43.5	-15.39	10.83	1.15	31.89	123	324	Peak
424.79	22.63	36.88	46	-23.37	15.83	1.95	32.03	100	263	Peak
459.71	27.76	41.22	46	-18.24	16.52	2.01	31.99	115	101	Peak
579.02	24.29	35.07	46	-21.71	19.12	2.22	32.12	132	8	Peak

Remarks:

- Emission Level = Read Level + Antenna Factor + Cable Loss - Preamp Factor
Margin value = Emission level – Limit value

4.2 Conducted Emission Measurement

4.2.1 Limits of Conducted Emission Measurement

Frequency (MHz)	Conducted Limit (dBuV)	
	Quasi-peak	Average
0.15 - 0.5	66 - 56	56 - 46
0.50 - 5.0	56	46
5.0 - 30.0	60	50

Note: 1. The lower limit shall apply at the transition frequencies.

2. The limit decreases in line with the logarithm of the frequency in the range of 0.15 to 0.50 MHz.

4.2.2 Test Instruments

Description & Manufacturer	Model No.	Serial No.	Date of Calibration	Due Date of Calibration
Test Receiver ROHDE & SCHWARZ	ESCI	100613	Nov. 21, 2016	Nov. 20, 2017
RF signal cable (with 10dB PAD) Woken	5D-FB	Cable-cond1-01	Dec. 22, 2016	Dec. 21, 2017
LISN ROHDE & SCHWARZ (EUT)	ESH3-Z5	835239/001	Feb. 26, 2016	Feb. 25, 2017
LISN ROHDE & SCHWARZ (Peripheral)	ESH3-Z5	100311	Jul. 28, 2016	Jul. 27, 2017
Software ADT	BV ADT_Cond_ V7.3.7.3	NA	NA	NA

Note: 1. The calibration interval of the above test instruments is 12 months and the calibrations are traceable to NML/ROC and NIST/USA.

2. The test was performed in HwaYa Shielded Room 1.

3. The VCCI Site Registration No. is C-2040.

4.2.3 Test Procedures

- a. The EUT was placed 0.4 meters from the conducting wall of the shielded room with EUT being connected to the power mains through a line impedance stabilization network (LISN). Other support units were connected to the power mains through another LISN. The two LISNs provide 50 ohm/50 uH of coupling impedance for the measuring instrument.
- b. Both lines of the power mains connected to the EUT were checked for maximum conducted interference.
- c. The frequency range from 150 kHz to 30 MHz was searched. Emission levels under (Limit – 20 dB) was not recorded.

NOTE: All modes of operation were investigated and the worst-case emissions are reported.

4.2.4 Deviation from Test Standard

No deviation.

4.2.5 Test Setup

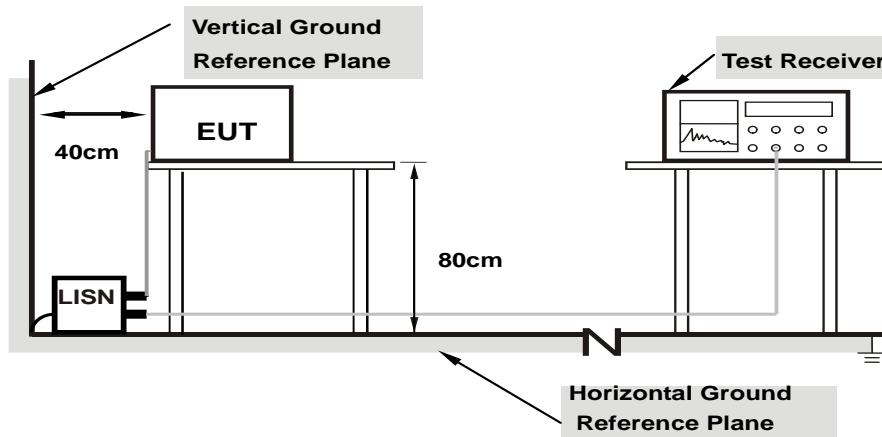

Note: 1. Support units were connected to second LISN.

For the actual test configuration, please refer to the attached file (Test Setup Photo).

4.2.6 EUT Operating Conditions

- a. Placed the EUT on a testing table.
- b. Use the software to control the EUT under transmission condition continuously at specific channel frequency.

4.2.7 Test Results

Frequency Range	150kHz ~ 30MHz	Detector Function & Resolution Bandwidth	Quasi-Peak (QP) / Average (AV), 9kHz
Input Power	120Vac, 60Hz	Environmental Conditions	25°C, 65%RH
Tested by	Toby Tian	Test Date	2016/12/31

Phase Of Power : Line (L)										
No	Frequency (MHz)	Correction Factor (dB)	Reading Value (dBuV)		Emission Level (dBuV)		Limit (dBuV)		Margin (dB)	
			Q.P.	AV.	Q.P.	AV.	Q.P.	AV.	Q.P.	AV.
1	0.15400	10.12	37.52	20.12	47.64	30.24	65.78	55.78	-18.14	-25.54
2	0.20201	10.14	34.46	18.27	44.60	28.41	63.53	53.53	-18.93	-25.12
3	0.24200	10.15	31.53	14.34	41.68	24.49	62.03	52.03	-20.35	-27.54
4	0.28982	10.15	29.33	13.65	39.48	23.80	60.53	50.53	-21.05	-26.73
5	0.38200	10.17	26.22	14.54	36.39	24.71	58.24	48.24	-21.85	-23.53
6	18.20600	11.31	23.02	14.31	34.33	25.62	60.00	50.00	-25.67	-24.38

Remarks:

1. Q.P. and AV. are abbreviations of quasi-peak and average individually.
2. The emission levels of other frequencies were very low against the limit.
3. Margin value = Emission level – Limit value
4. Correction factor = Insertion loss + Cable loss
5. Emission Level = Correction Factor + Reading Value

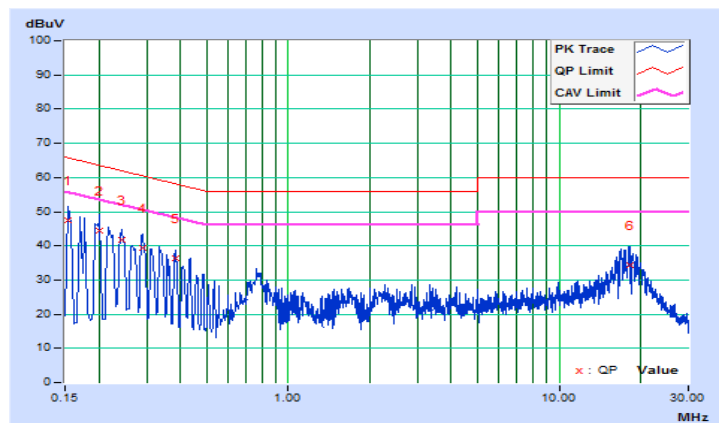

Frequency Range	150kHz ~ 30MHz	Detector Function & Resolution Bandwidth	Quasi-Peak (QP) / Average (AV), 9kHz
Input Power	120Vac, 60Hz	Environmental Conditions	25°C, 65%RH
Tested by	Toby Tian	Test Date	2016/12/31

Phase Of Power : Neutral (N)										
No	Frequency (MHz)	Correction Factor (dB)	Reading Value (dBuV)		Emission Level (dBuV)		Limit (dBuV)		Margin (dB)	
			Q.P.	AV.	Q.P.	AV.	Q.P.	AV.	Q.P.	AV.
1	0.15400	10.13	31.31	12.74	41.44	22.87	65.78	55.78	-24.34	-32.91
2	0.17754	10.14	30.10	11.99	40.24	22.13	64.60	54.60	-24.36	-32.47
3	0.20148	10.15	30.69	14.41	40.84	24.56	63.55	53.55	-22.71	-28.99
4	0.26600	10.16	25.51	10.94	35.67	21.10	61.24	51.24	-25.57	-30.14
5	0.78250	10.19	27.30	20.09	37.49	30.28	56.00	46.00	-18.51	-15.72
6	17.69400	11.38	22.81	10.56	34.19	21.94	60.00	50.00	-25.81	-28.06

Remarks:

1. Q.P. and AV. are abbreviations of quasi-peak and average individually.
2. The emission levels of other frequencies were very low against the limit.
3. Margin value = Emission level – Limit value
4. Correction factor = Insertion loss + Cable loss
5. Emission Level = Correction Factor + Reading Value

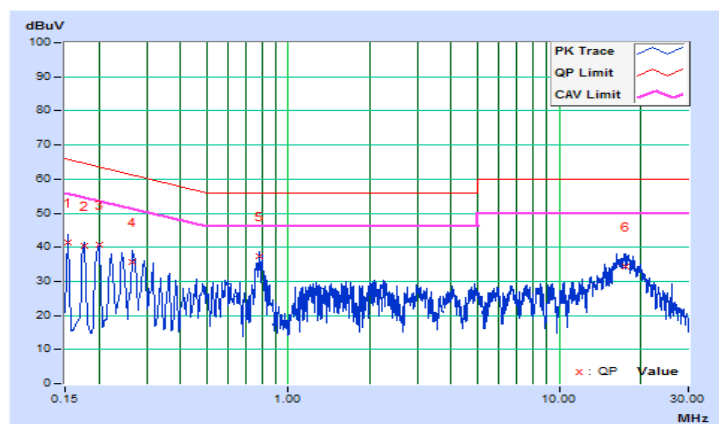

4.3 6 dB Bandwidth Measurement

4.3.1 Limits of 6 dB Bandwidth Measurement

The minimum of 6 dB Bandwidth Measurement is 0.5 MHz.

4.3.2 Test Setup

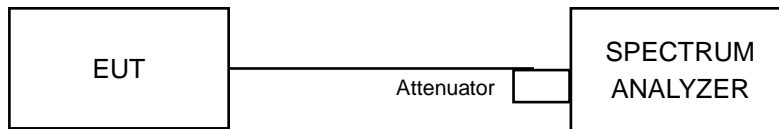

4.3.3 Test Instruments

Refer to section 4.1.2 to get information of above instrument.

4.3.4 Test Procedure

- Set resolution bandwidth (RBW) = 100 kHz
- Set the video bandwidth (VBW) $\geq 3 \times$ RBW, Detector = Peak.
- Trace mode = max hold.
- Sweep = auto couple.
- Measure the maximum width of the emission that is constrained by the frequencies associated with the two amplitude points (upper and lower) that are attenuated by 6 dB relative to the maximum level measured in the fundamental emission

4.3.5 Deviation from Test Standard

No deviation.

4.3.6 EUT Operating Conditions

The software provided by client to enable the EUT under transmission condition continuously at lowest, middle and highest channel frequencies individually.

4.3.7 Test Result

802.11b

Channel	Frequency (MHz)	6 dB Bandwidth (MHz)	Minimum Limit (MHz)	Pass / Fail
1	2412	7.12	0.5	Pass
6	2437	7.12	0.5	Pass
11	2462	7.13	0.5	Pass
12	2467	7.13	0.5	Pass
13	2472	7.14	0.5	Pass

802.11g

Channel	Frequency (MHz)	6 dB Bandwidth (MHz)	Minimum Limit (MHz)	Pass / Fail
1	2412	16.42	0.5	Pass
6	2437	16.41	0.5	Pass
11	2462	16.41	0.5	Pass
12	2467	16.43	0.5	Pass
13	2472	16.38	0.5	Pass

802.11n (HT20)

Channel	Frequency (MHz)	6 dB Bandwidth (MHz)	Minimum Limit (MHz)	Pass / Fail
1	2412	17.63	0.5	Pass
6	2437	17.65	0.5	Pass
11	2462	17.66	0.5	Pass
12	2467	17.64	0.5	Pass
13	2472	17.64	0.5	Pass

Spectrum Plot of Worst Value

802.11b

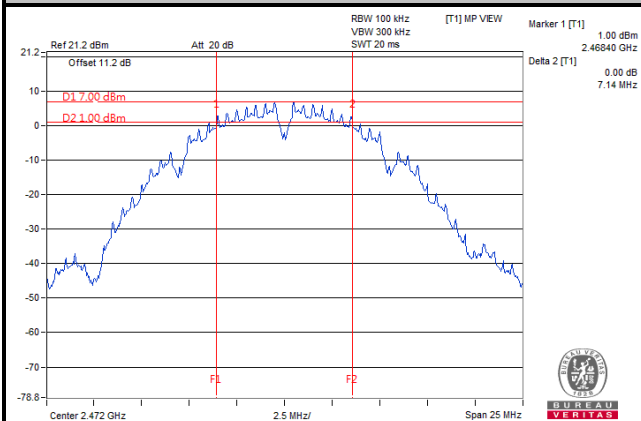

802.11g

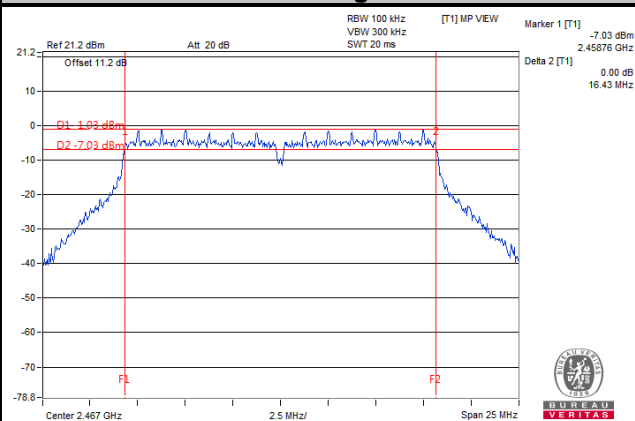

802.11n (HT20)

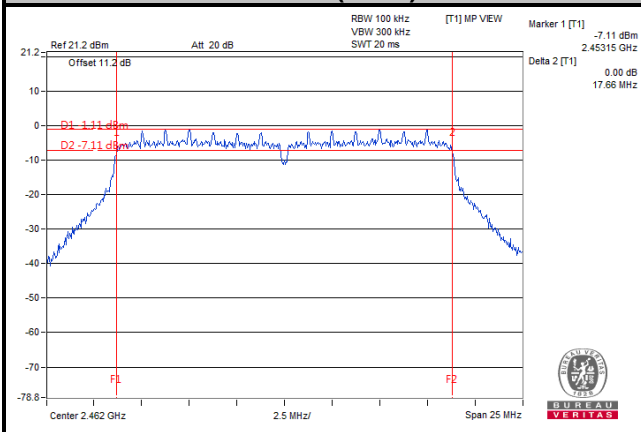

4.4 Conducted Output Power Measurement

4.4.1 Limits of Conducted Output Power Measurement

For systems using digital modulation in the 2400–2483.5 MHz bands: 1 Watt (30 dBm)

4.4.2 Test Setup

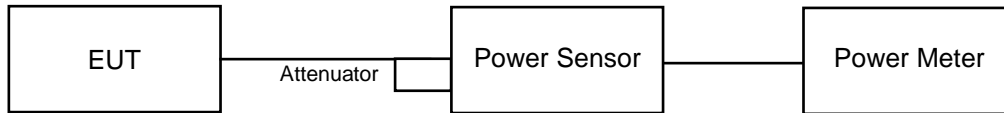

4.4.3 Test Instruments

Refer to section 4.1.2 to get information of above instrument.

4.4.4 Test Procedures

A peak power sensor was used on the output port of the EUT. A power meter was used to read the response of the peak power sensor. Record the power level.

4.4.5 Deviation from Test Standard

No deviation.

4.4.6 EUT Operating Conditions

The software provided by client to enable the EUT under transmission condition continuously at lowest, middle and highest channel frequencies individually.

4.4.7 Test Results

802.11b

Channel	Frequency (MHz)	Peak Power (mW)	Peak Power (dBm)	Limit (dBm)	Pass / Fail
1	2412	70.958	18.51	30	Pass
6	2437	68.865	18.38	30	Pass
11	2462	61.802	17.91	30	Pass
12	2467	61.944	17.92	30	Pass
13	2472	62.661	17.97	30	Pass

802.11g

Channel	Frequency (MHz)	Peak Power (mW)	Peak Power (dBm)	Limit (dBm)	Pass / Fail
1	2412	78.524	18.95	30	Pass
6	2437	81.47	19.11	30	Pass
11	2462	79.983	19.03	30	Pass
12	2467	77.446	18.89	30	Pass
13	2472	51.05	17.08	30	Pass

802.11n (HT20)

Channel	Frequency (MHz)	Peak Power (mW)	Peak Power (dBm)	Limit (dBm)	Pass / Fail
1	2412	77.625	18.90	30	Pass
6	2437	84.333	19.26	30	Pass
11	2462	82.794	19.18	30	Pass
12	2467	65.313	18.15	30	Pass
13	2472	46.989	16.72	30	Pass

4.5 Power Spectral Density Measurement

4.5.1 Limits of Power Spectral Density Measurement

The Maximum of Power Spectral Density Measurement is 8 dBm.

4.5.2 Test Setup

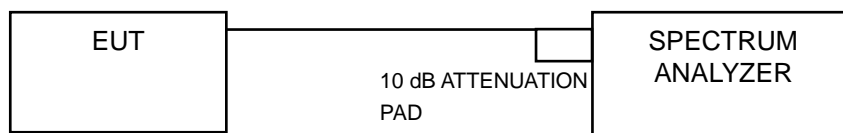

4.5.3 Test Instruments

Refer to section 4.1.2 to get information of above instrument.

4.5.4 Test Procedure

- Set analyzer center frequency to DTS channel center frequency.
- Set the span to 1.5 times the DTS bandwidth.
- Set the RBW to: $3 \text{ kHz} \leq \text{RBW} \leq 100 \text{ kHz}$.
- Set the VBW $\geq 3 \times \text{RBW}$.
- Detector = peak.
- Sweep time = auto couple.
- Trace mode = max hold.
- Allow trace to fully stabilize.
- Use the peak marker function to determine the maximum amplitude level within the RBW.

4.5.5 Deviation from Test Standard

No deviation.

4.5.6 EUT Operating Condition

The software provided by client to enable the EUT under transmission condition continuously at lowest, middle and highest channel frequencies individually.

4.5.7 Test Results

802.11b

Channel	Frequency (MHz)	PSD (dBm)	Limit (dBm)	Pass / Fail
1	2412	-6.45	8	Pass
6	2437	-6.70	8	Pass
11	2462	-7.04	8	Pass
12	2467	-6.99	8	Pass
13	2472	-6.95	8	Pass

802.11g

Channel	Frequency (MHz)	PSD (dBm)	Limit (dBm)	Pass / Fail
1	2412	-16.08	8	Pass
6	2437	-15.18	8	Pass
11	2462	-15.78	8	Pass
12	2467	-15.56	8	Pass
13	2472	-18.42	8	Pass

802.11n (HT20)

Channel	Frequency (MHz)	PSD (dBm)	Limit (dBm)	Pass / Fail
1	2412	-16.09	8	Pass
6	2437	-15.48	8	Pass
11	2462	-15.62	8	Pass
12	2467	-17.97	8	Pass
13	2472	-19.26	8	Pass

Spectrum Plot of Worst Value

802.11b

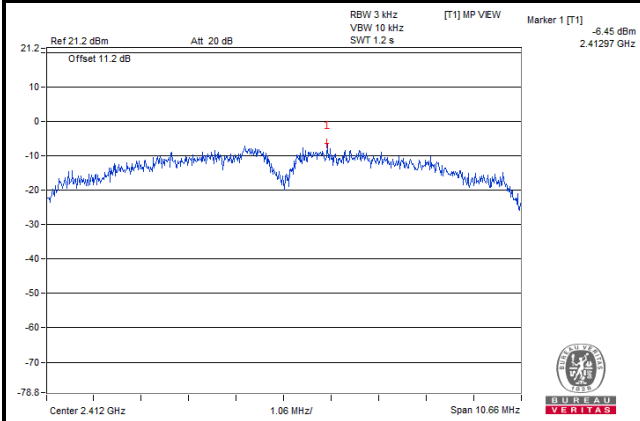

802.11g

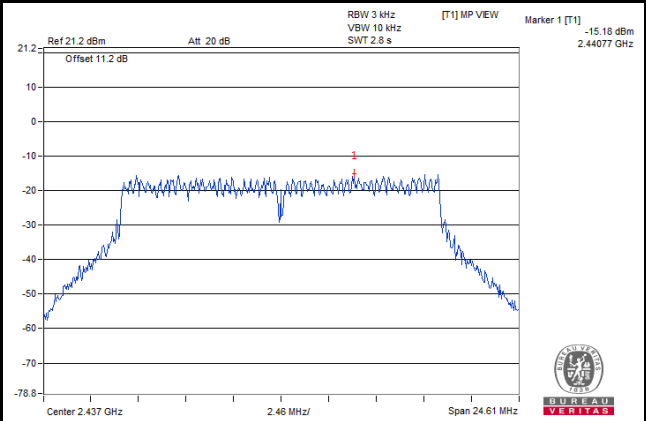

802.11n (HT20)

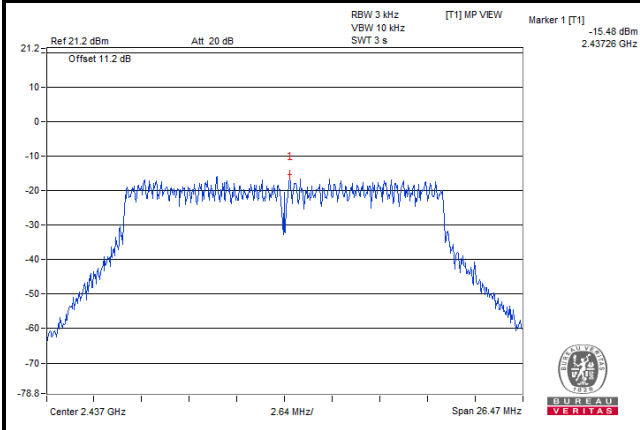

4.6 Conducted Out of Band Emission Measurement

4.6.1 Limits of Conducted Out of Band Emission Measurement

Below 20 dB of the highest emission level of operating band (in 100 kHz Resolution Bandwidth).

4.6.2 Test Setup

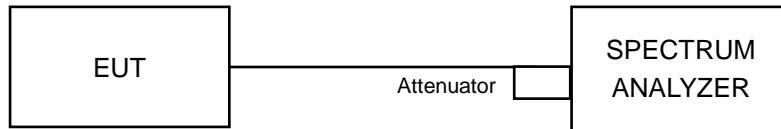

4.6.3 Test Instruments

Refer to section 4.1.2 to get information of above instrument.

4.6.4 Test Procedure

MEASUREMENT PROCEDURE REF

1. Set the RBW = 100 kHz.
2. Set the VBW \geq 300 kHz.
3. Detector = peak.
4. Sweep time = auto couple.
5. Trace mode = max hold.
6. Allow trace to fully stabilize.
7. Use the peak marker function to determine the maximum power level in any 100 kHz band segment within the fundamental EBW.

MEASUREMENT PROCEDURE OOB

1. Set RBW = 100 kHz.
2. Set VBW \geq 300 kHz.
3. Detector = peak.
4. Sweep = auto couple.
5. Trace Mode = max hold.
6. Allow trace to fully stabilize.
7. Use the peak marker function to determine the maximum amplitude level.

4.6.5 Deviation from Test Standard

No deviation.

4.6.6 EUT Operating Condition

The software provided by client to enable the EUT under transmission condition continuously at lowest, middle and highest channel frequencies individually.

4.6.7 Test Results

The spectrum plots are attached on the following images. D1 line indicates the highest level, and D2 line indicates the 20 dB offset below D1. It shows compliance with the requirement.

802.11b

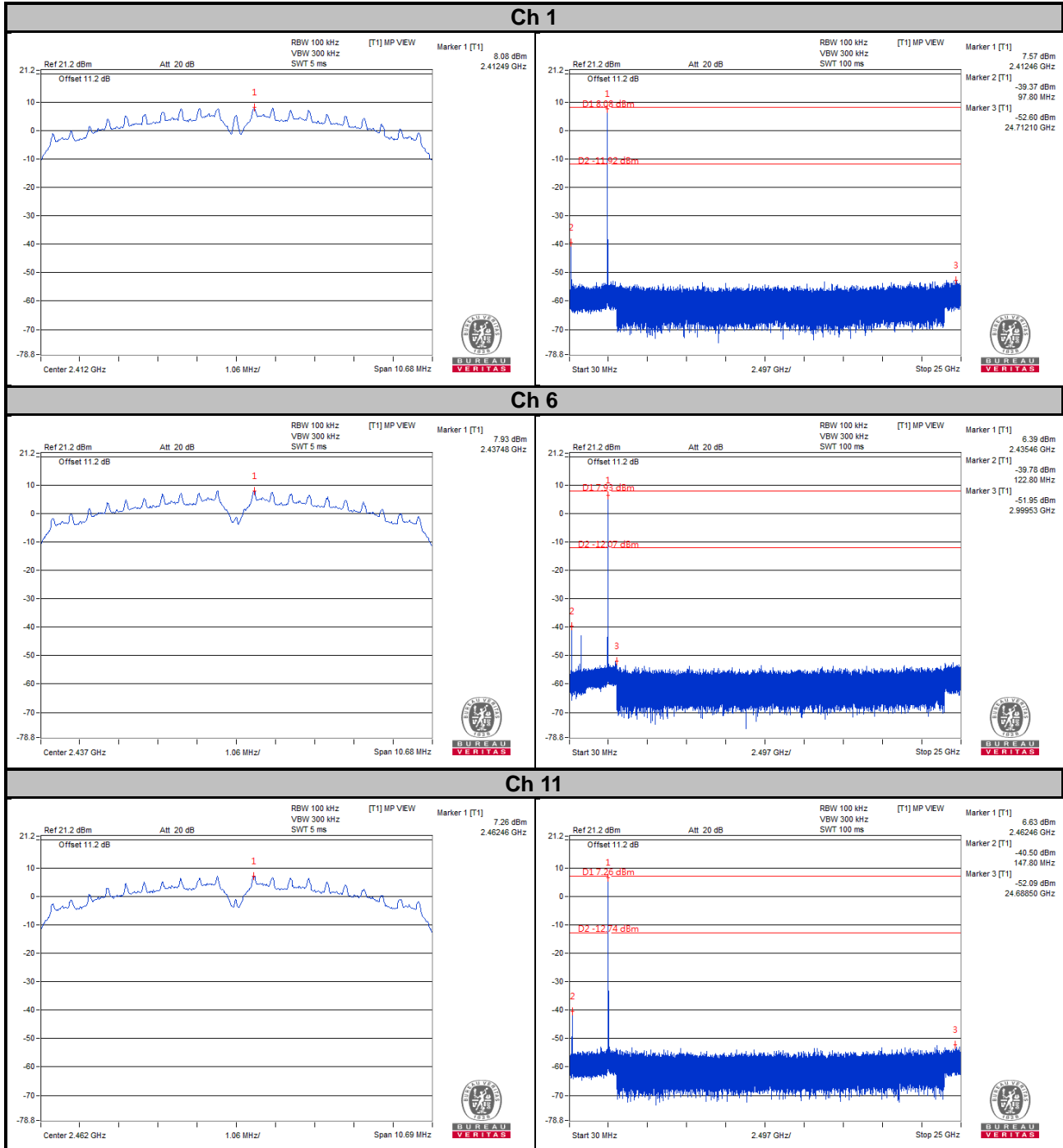

Ch 12

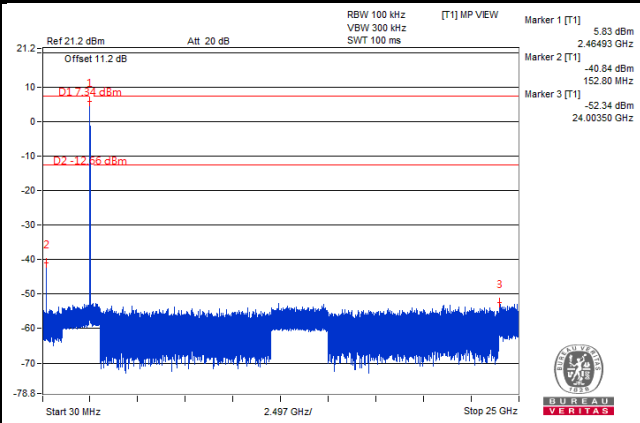
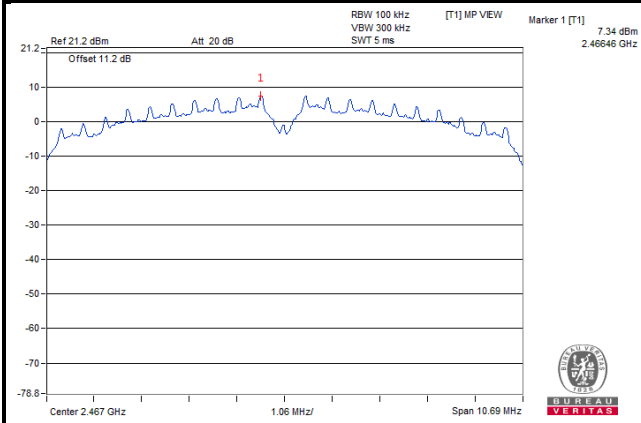

Ch 13

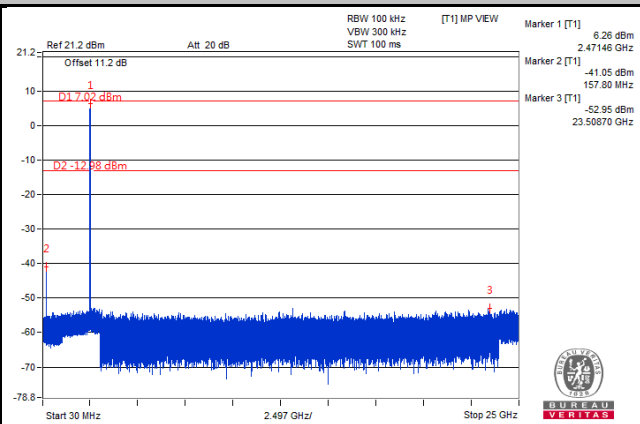
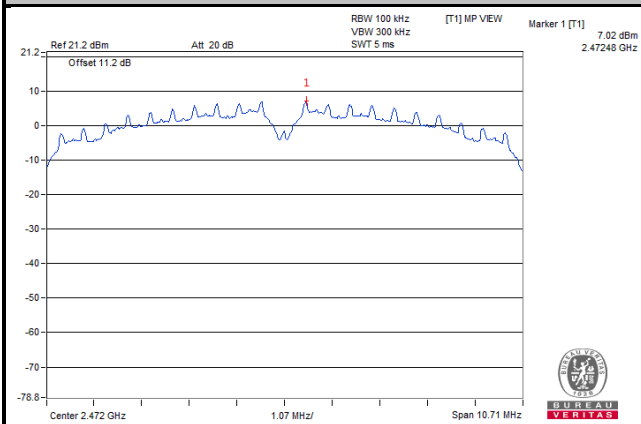

Ch 1 Band Edge

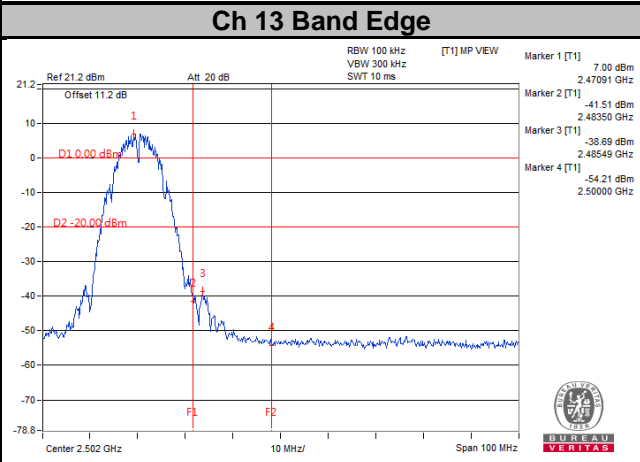
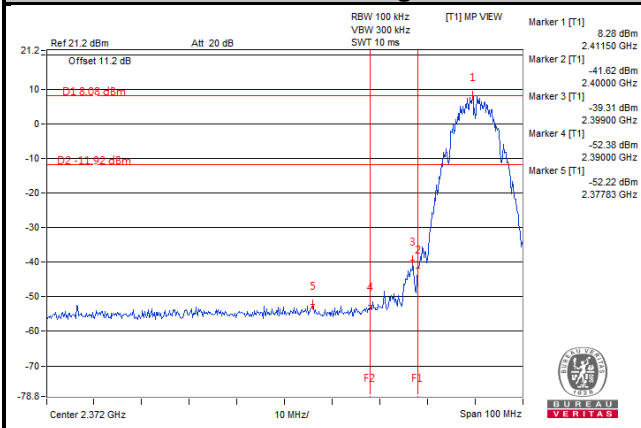

802.11g

Ch 1

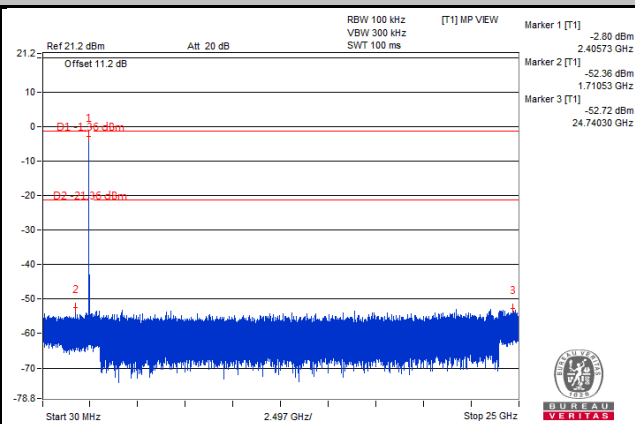
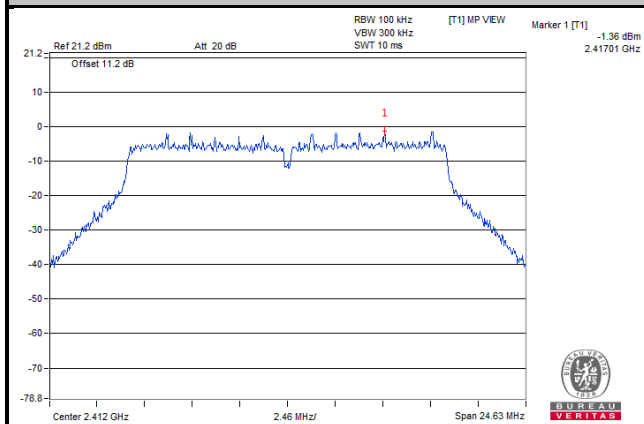

Ch 6

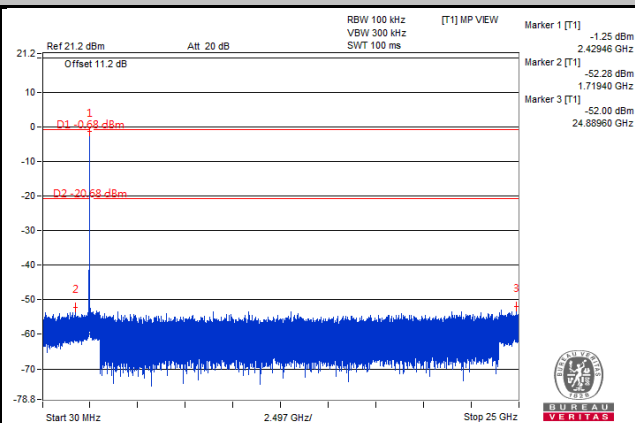
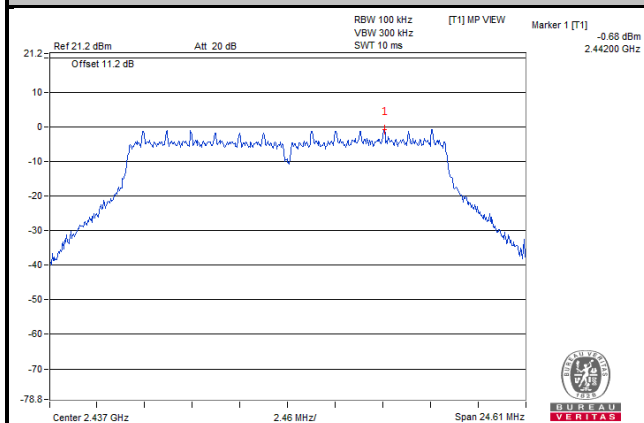

Ch 11

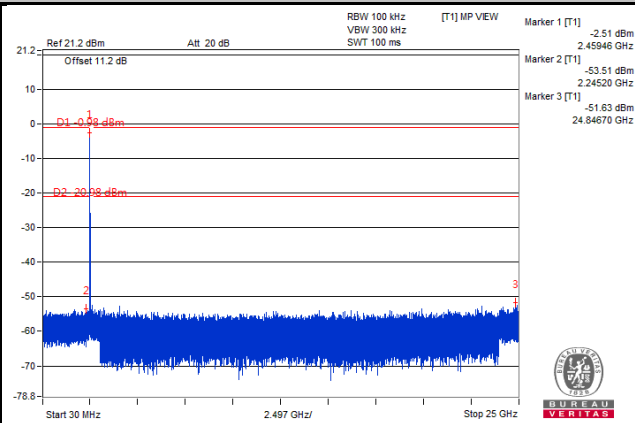
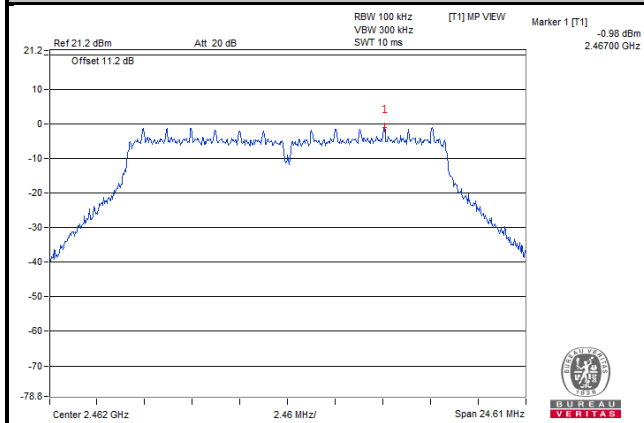

Ch 12

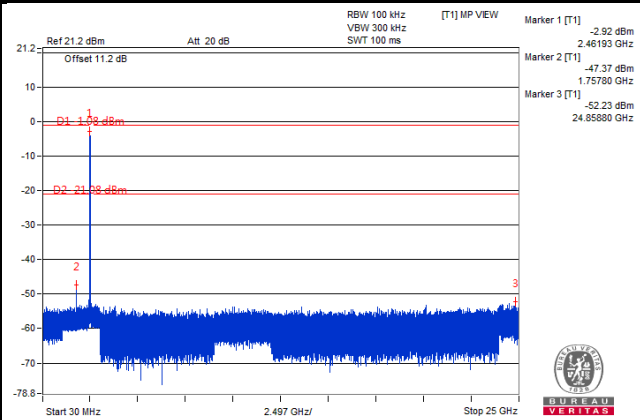
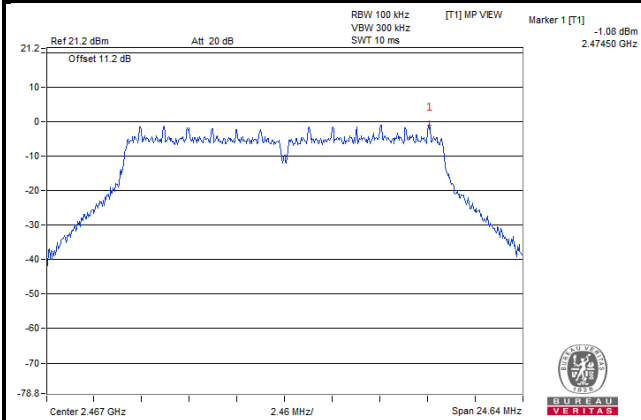

Ch 13

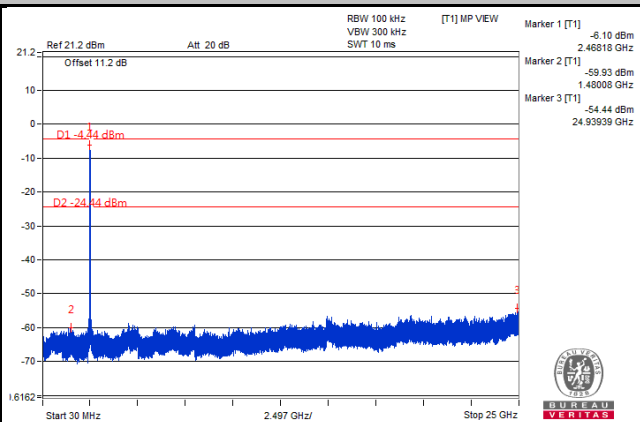
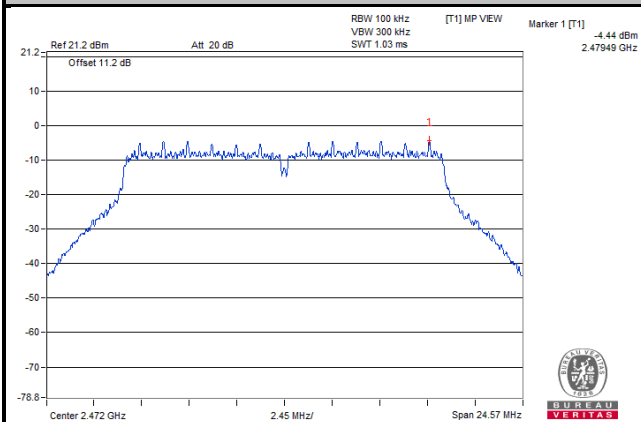

Ch 1 Band Edge

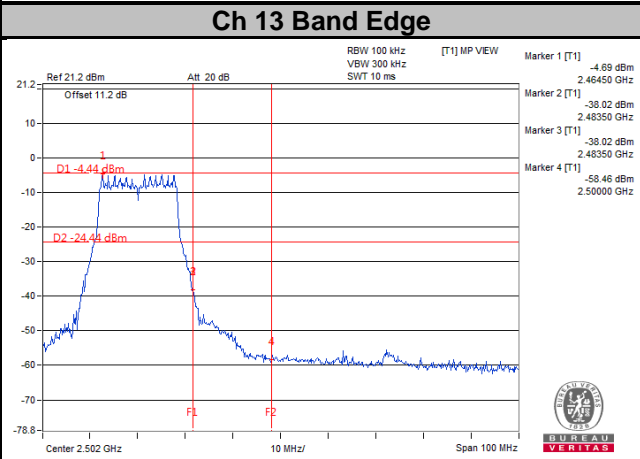
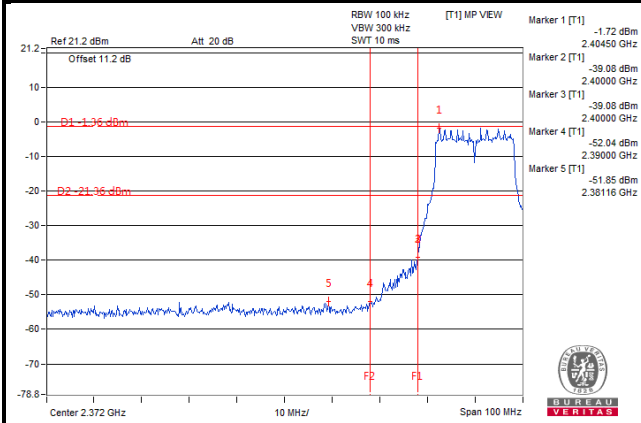

802.11n (HT20)

Ch 1

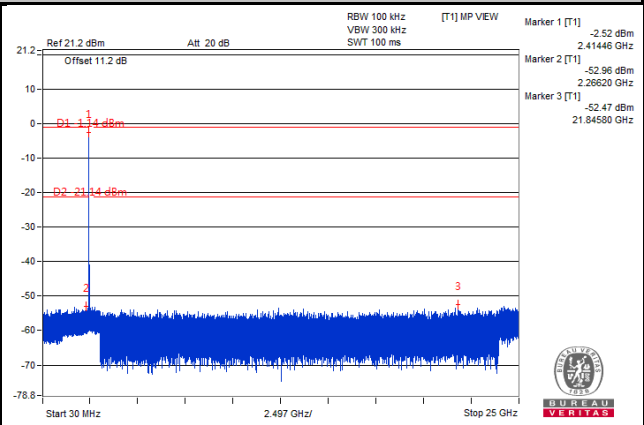
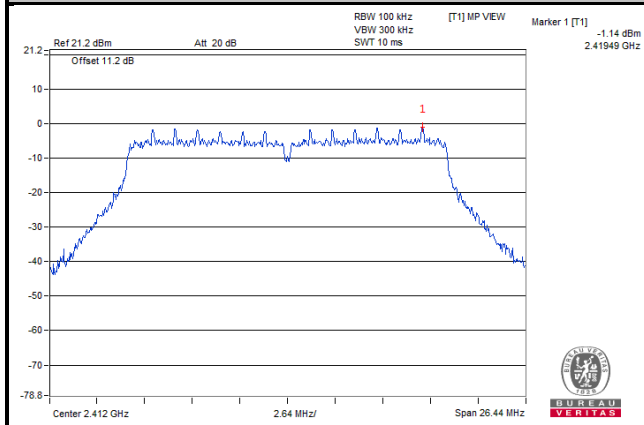

Ch 6

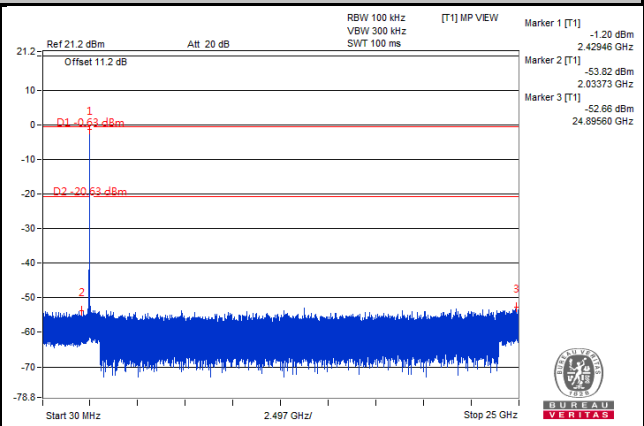
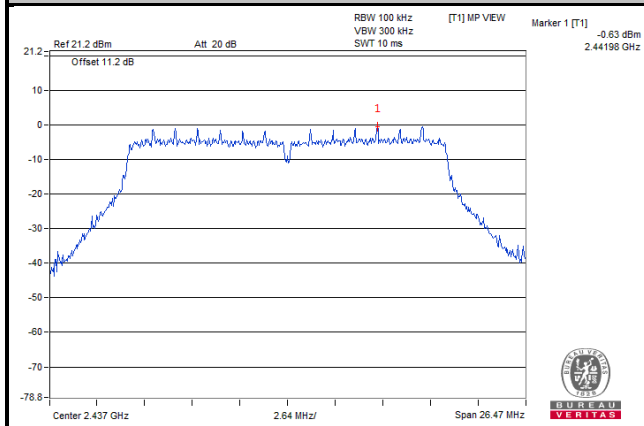

Ch 11

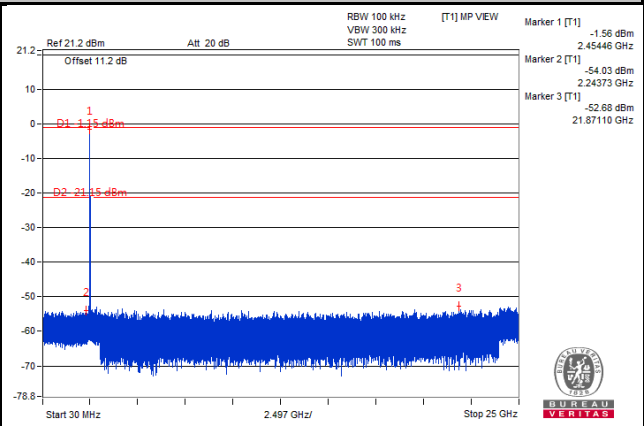
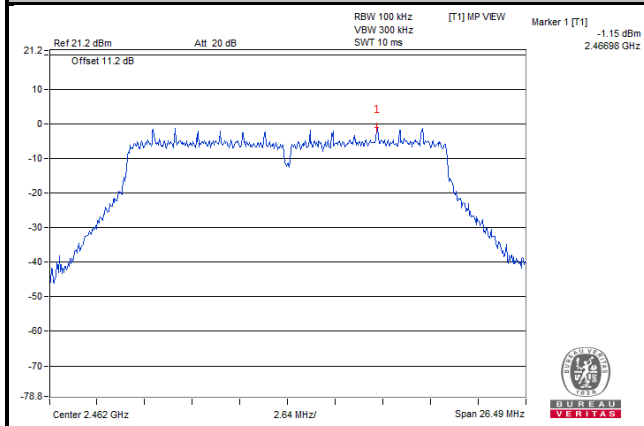

Ch 12

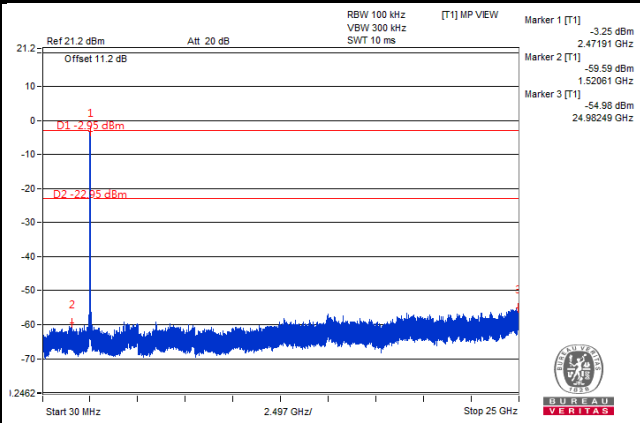
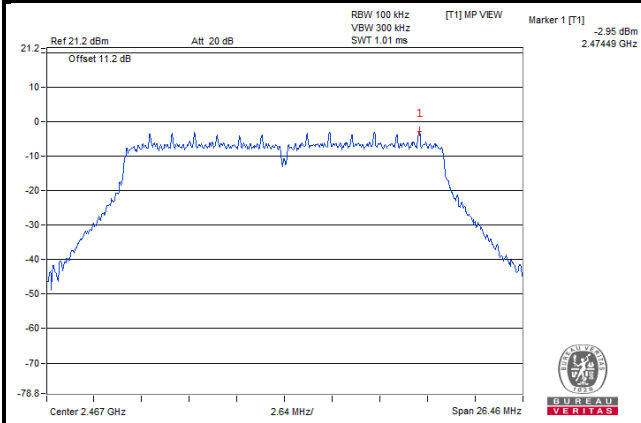

Ch 13

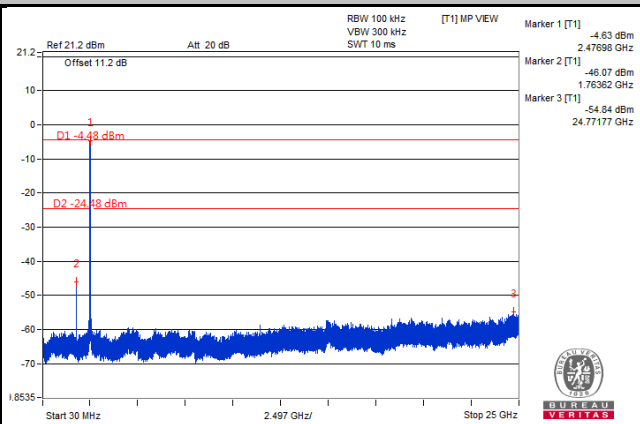
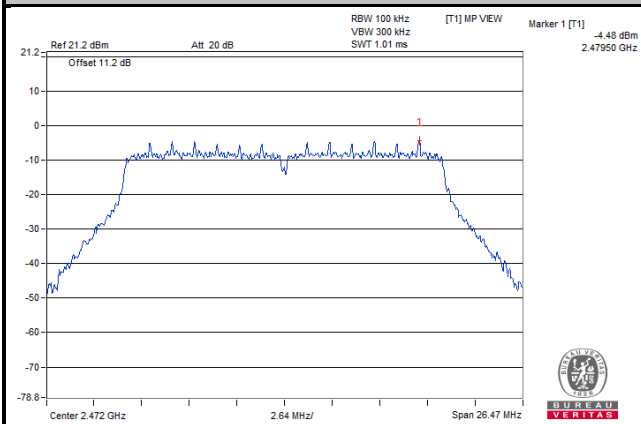

Ch 1 Band Edge

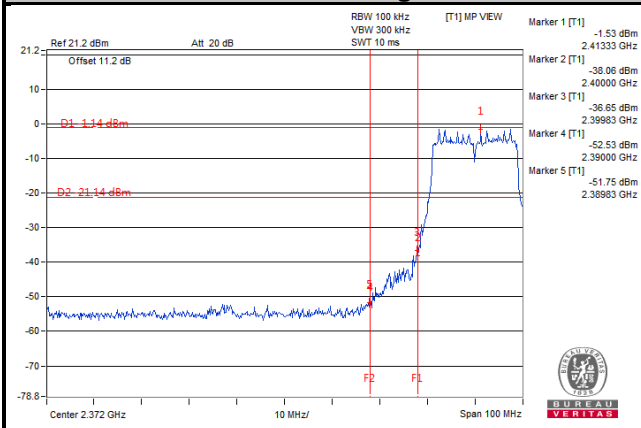

Ch 13 Band Edge

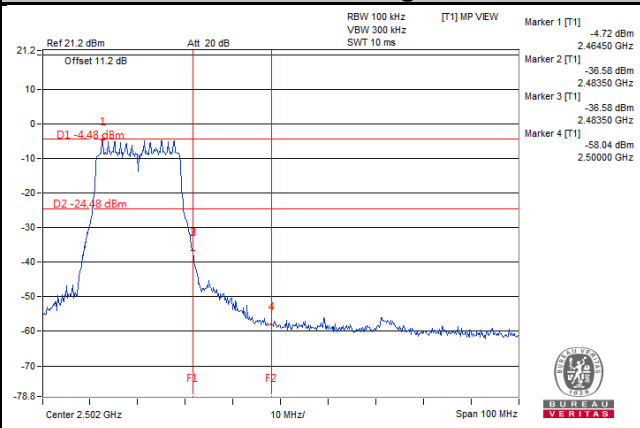

5 Pictures of Test Arrangements

Please refer to the attached file (Test Setup Photo).

Appendix – Information on the Testing Laboratories

We, Bureau Veritas Consumer Products Services (H.K.) Ltd., Taoyuan Branch, were founded in 1988 to provide our best service in EMC, Radio, Telecom and Safety consultation. Our laboratories are accredited and approved according to ISO/IEC 17025.

If you have any comments, please feel free to contact us at the following:

Linko EMC/RF Lab

Tel: 886-2-26052180

Fax: 886-2-26051924

Hsin Chu EMC/RF/Telecom Lab

Tel: 886-3-6668565

Fax: 886-3-6668323

Hwa Ya EMC/RF/Safety Lab

Tel: 886-3-3183232

Fax: 886-3-3270892

Email: service.adt@tw.bureauveritas.com

Web Site: www.bureauveritas-adt.com

The address and road map of all our labs can be found in our web site also.

--- END ---