

FCC Test Report

FCC ID : 2AENP-MB01
Equipment : Wireless Headphones
Brand Name : Montblanc
Model Name : MB 01
**Applicant/
Manufacturer** : Montblanc-Simplo GmbH
Hellgrundweg 100, 22525 Hamburg, Germany
Standard : 47 CFR FCC Part 15.247

The product was received on Sep. 06, 2019, and testing was started from Sep. 25, 2019 and completed on Oct. 15, 2019. We, SPORTON INTERNATIONAL INC. EMC & Wireless Communications Laboratory, would like to declare that the tested sample has been evaluated in accordance with the procedures given in ANSI C63.10-2013 and shown compliance with the applicable technical standards.

The report must not be used by the client to claim product certification, approval, or endorsement by TAF or any agency of government.

The test results in this report apply exclusively to the tested model / sample. Without written approval of SPORTON INTERNATIONAL INC. EMC & Wireless Communications Laboratory, the test report shall not be reproduced except in full.



Approved by: Allen Lin

SPORTON INTERNATIONAL INC. EMC & Wireless Communications Laboratory

No. 52, Huaya 1st Rd., Guishan Dist., Taoyuan City, Taiwan (R.O.C.)



Table of Contents

HISTORY OF THIS TEST REPORT3

SUMMARY OF TEST RESULT4

1 GENERAL DESCRIPTION5

1.1 Information5

1.2 Testing Applied Standards7

1.3 Testing Location Information7

1.4 Measurement Uncertainty7

2 TEST CONFIGURATION OF EUT.....8

2.1 Test Condition.....8

2.2 Test Channel Mode8

2.3 The Worst Case Measurement Configuration9

2.4 Accessories and Support Equipment10

2.5 Test Setup Diagram.....11

3 TRANSMITTER TEST RESULT13

3.1 AC Power-line Conducted Emissions.....13

3.2 DTS Bandwidth.....15

3.3 Maximum Conducted Output Power.....16

3.4 Power Spectral Density18

3.5 Emissions in Non-restricted Frequency Bands19

3.6 Emissions in Restricted Frequency Bands20

4 TEST EQUIPMENT AND CALIBRATION DATA.....24

APPENDIX A. TEST RESULTS OF AC POWER-LINE CONDUCTED EMISSIONS

APPENDIX B. TEST RESULTS OF DTS BANDWIDTH

APPENDIX C. TEST RESULTS OF MAXIMUM CONDUCTED OUTPUT POWER

APPENDIX D. TEST RESULTS OF POWER SPECTRAL DENSITY

APPENDIX E. TEST RESULTS OF EMISSIONS IN NON-RESTRICTED FREQUENCY BANDS

APPENDIX F. TEST RESULTS OF EMISSIONS IN RESTRICTED FREQUENCY BANDS

APPENDIX G. TEST PHOTOS

PHOTOGRAPHS OF EUT V01



History of this test report

Report No.	Version	Description	Issued Date
FR990601AL	01	Initial issue of report	Oct. 16, 2019



Summary of Test Result

Report Clause	Ref.Std. Clause	Test Items	Result (PASS/FAIL)	Remark
1.1.2	15.203	Antenna Requirement	PASS	-
3.1	15.207	AC Power-line Conducted Emissions	PASS	-
3.2	15.247(a)	DTS Bandwidth	PASS	-
3.3	15.247(b)	Maximum Conducted Output Power	PASS	-
3.4	15.247(e)	Power Spectral Density	PASS	-
3.5	15.247(d)	Emissions in Non-restricted Frequency Bands	PASS	-
3.6	15.247(d)	Emissions in Restricted Frequency Bands	PASS	-

Declaration of Conformity:
The test results with all measurement uncertainty excluded are presented in accordance with the regulation limits or requirements declared by manufacturers.
Comments and explanations:
None

Reviewed by: Sam Tsai

Report Producer: Kate Lo

1 General Description

1.1 Information

1.1.1 RF General Information

Frequency Range (MHz)	Bluetooth Mode	Ch. Frequency (MHz)	Channel Number
2400-2483.5	LE	2402-2480	0-39 [40]

Band	Mode	BWch (MHz)	Nant
2.4-2.4835GHz	BT-LE(1Mbps)	1.0	1TX
2.4-2.4835GHz	BT-LE(2Mbps)	2.0	1TX

Note:

- ♦ Bluetooth LE uses a GFSK (1Mbps/2Mbps) modulation for DSSS.
- ♦ BWch is the nominal channel bandwidth.

1.1.2 Antenna Information

Ant.	Brand	Model Name	Antenna Type	Connector	Gain (dBi)
1	SAGE ELEPHANT	S306300001000-A	Couple Chip Antenna	N/A	1.82

For BT function:

For IEEE 802.15.1 Bluetooth mode (1TX/1RX)

Ant. 1 could transmit/receive.

1.1.3 EUT Information

Operational Condition	
EUT Power Type	From host system (NB) / Adapter
EUT Function	<input checked="" type="checkbox"/> Point-to-multipoint <input type="checkbox"/> Point-to-point
Type of EUT	
<input checked="" type="checkbox"/>	Stand-alone
<input type="checkbox"/>	Combined (EUT where the radio part is fully integrated within another device)
	Combined Equipment - Brand Name / Model No.: ...
<input type="checkbox"/>	Plug-in radio (EUT intended for a variety of host systems)
	Host System - Brand Name / Model No.: ...
<input type="checkbox"/>	Other:

1.1.4 Mode Test Duty Cycle

Mode	DC	DCF(dB)	T(s)	VBW(Hz) $\geq 1/T$
BT-LE(1Mbps)	0.64	1.94	400u	3k
BT-LE(2Mbps)	0.344	4.63	215u	10k

Note. If DC < 0.98, the DCF was added while measuring Output power and PSD.

1.1.5 Table for Multiple Listing

The model names in the following table are all refer to the identical product.

Model Name	Sample	Description
MB 01	1	The EUT have three Samples. There are three appearance colors.
	2	
	3	

Note:Sample 1 configuration was measured during the test.

1.2 Testing Applied Standards

According to the specifications of the manufacturer, the EUT must comply with the requirements of the following standards:

- ◆ 47 CFR FCC Part 15
- ◆ ANSI C63.10-2013
- ◆ KDB 558074 D01 v05r02
- ◆ KDB 414788 D01 v01r01

1.3 Testing Location Information

Testing Location				
<input checked="" type="checkbox"/>	HWA YA	ADD : No. 52, Huaya 1st Rd., Guishan Dist., Taoyuan City, Taiwan (R.O.C.)		
		TEL : 886-3-327-3456	FAX : 886-3-327-0973	
Test site Designation No. TW1190 with FCC.				
<input type="checkbox"/>	JHUBEI	ADD : No.8, Ln. 724, Bo'ai St., Zhubei City, Hsinchu County, Taiwan (R.O.C.)		
		TEL : 886-3-656-9065	FAX : 886-3-656-9085	
Test site Designation No. TW0006 with FCC.				

Test Condition	Test Site No.	Test Engineer	Test Environment	Test Date
AC Conduction	CO04-HY	Edward	24.2~25.3°C / 63.1~67.2%	26/Sep/2019
RF Conducted	TH07-HY	Andy	25.4~25.9°C / 55~56%	25/Sep/2019
Radiated	03CH03-HY	Justin	18.6~24.8°C / 50.1~56.7%	26/Sep/2019~ 15/Oct/2019

1.4 Measurement Uncertainty

ISO/IEC 17025 requires that an estimate of the measurement uncertainties associated with the emissions test results be included in the report. The measurement uncertainties given below are based on a 95% confidence level (based on a coverage factor (k=2))

Test Items	Uncertainty	Remark
Conducted Emission (150kHz ~ 30MHz)	3.54 dB	Confidence levels of 95%
Radiated Emission (9kHz ~ 30MHz)	1.6 dB	Confidence levels of 95%
Radiated Emission (30MHz ~ 1,000MHz)	4.3 dB	Confidence levels of 95%
Radiated Emission (1GHz ~ 18GHz)	3.9 dB	Confidence levels of 95%
Radiated Emission (18GHz ~ 40GHz)	3.5 dB	Confidence levels of 95%
Conducted Emission	1.3 dB	Confidence levels of 95%
Temperature	0.7 °C	Confidence levels of 95%
Humidity	4 %	Confidence levels of 95%



2 Test Configuration of EUT

2.1 Test Condition

RF Conducted	Abbreviation	Remark
TnomVnom	Tnom	20°C
-	Vnom	5V

2.2 Test Channel Mode



Test Software Version	Blue Test3 V3.2.1
-----------------------	-------------------

Mode	Power Setting
BT-LE(1Mbps)	-
2402MHz	default
2440MHz	default
2480MHz	default
BT-LE(2Mbps)	-
2402MHz	default
2440MHz	default
2480MHz	default

2.3 The Worst Case Measurement Configuration

The Worst Case Mode for Following Conformance Tests	
Tests Item	AC power-line conducted emissions
Condition	AC power-line conducted measurement for line and neutral
Operating Mode	CTX
1	USB mode
2	Adapter mode

The Worst Case Mode for Following Conformance Tests	
Tests Item	DTS Bandwidth Maximum Conducted Output Power Power Spectral Density Emissions in Non-restricted Frequency Bands
Test Condition	Conducted measurement at transmit chains

The Worst Case Mode for Following Conformance Tests			
Tests Item	Emissions in Restricted Frequency Bands		
Test Condition	Radiated measurement If EUT consist of multiple antenna assembly (multiple antenna are used in EUT regardless of spatial multiplexing MIMO configuration), the radiated test should be performed with highest antenna gain of each antenna type.		
Operating Mode < 1GHz	CTX		
1	USB mode		
2	Adapter mode		
Operating Mode > 1GHz	CTX		
Orthogonal Planes of EUT	X Plane	Y Plane	Z Plane
			
Worst Planes of EUT		V	

2.4 Accessories and Support Equipment

Accessories				
Battery	Brand Name	SYNergy	Model Name	AHB553436TPJT-01
	Power Rating	3.7Vdc, 730mAh	Type	Lithium-ion Polymer Battery Pack
USB Cable	Brand Name	DONG GUAN IN YUAN	Model Name	4021XW01864ZAU
	Signal Line	1.2 meter, D-shielded cable, w/o ferrite core		
Audio Cable	Brand Name	DONG GUAN IN YUAN	Model Name	4021XW01865ZAG
	Signal Line	1.5 meter, non-shielded cable, w/o ferrite core		

Reminder: Regarding to more detail and other information, please refer to user manual.

Support Equipment – AC Conduction and Radiated Emission				
No.	Equipment	Brand Name	Model Name	FCC ID
1	Power Cable	Power sync	PW-GPC180-3	-
2	Notebook	DELL	E5570	-
3	Adapter for NB	DELL	AA90PM111	-
4	iPod	APPLE	YM719D8YVQ5	-
5	Earphone	APPLE	MD827FE/A	-
6	Adapter for EUT	SHLHY	SYS1448-1005-W2	-
7	USB Cable	DONG GUAN IN YUAN	4021XW01864ZAU	-

Note: Support equipment No.7 was provided by customer.

Support Equipment – RF Conducted				
No.	Equipment	Brand Name	Model Name	FCC ID
1	Notebook	DELL	E5410	DoC
2	Adapter for NB	DELL	HA65NM130	DoC
3	DC Power Supply	GW	GPS-3030DD	-

2.5 Test Setup Diagram

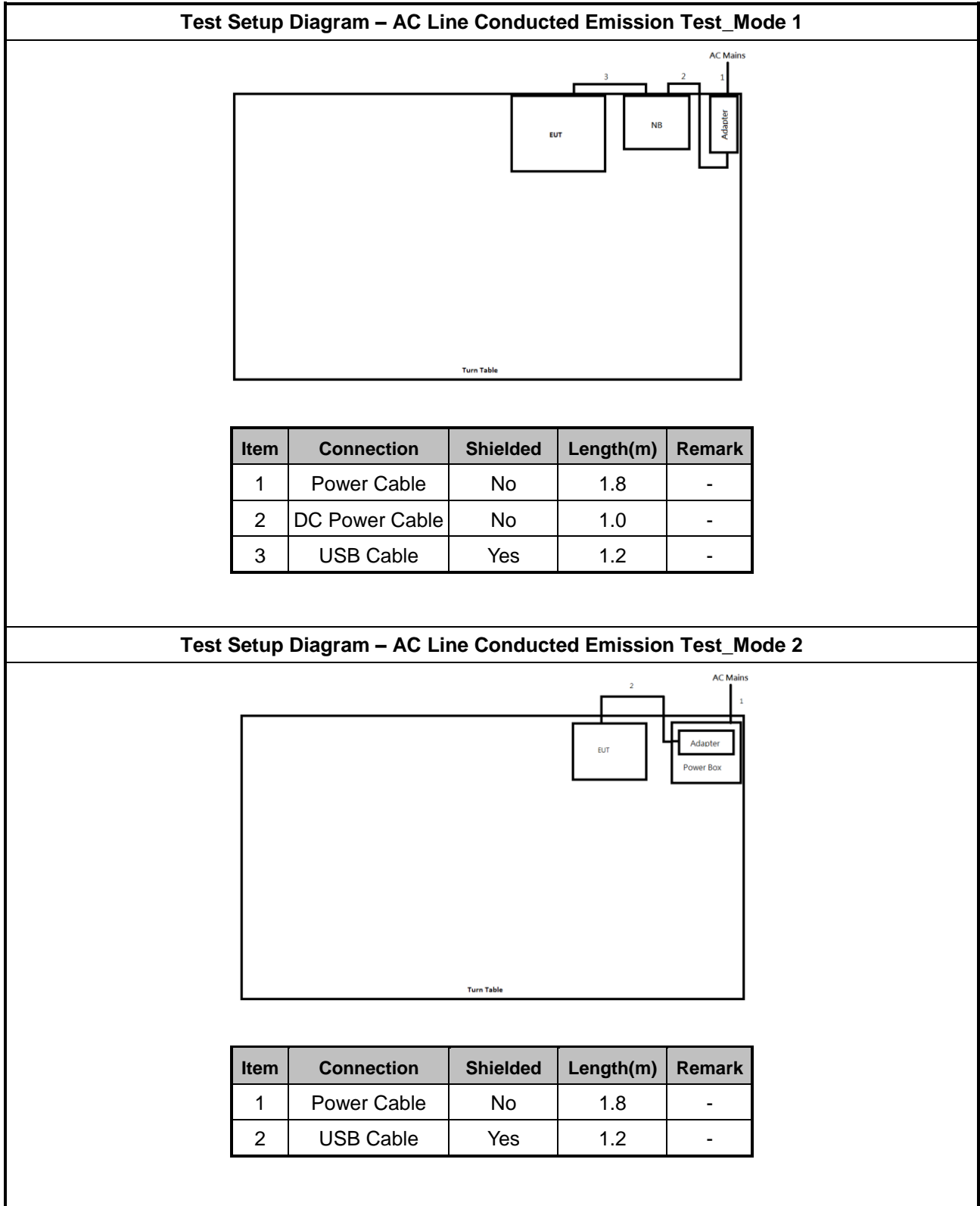

Test Setup Diagram - Radiated Test_Mode 1

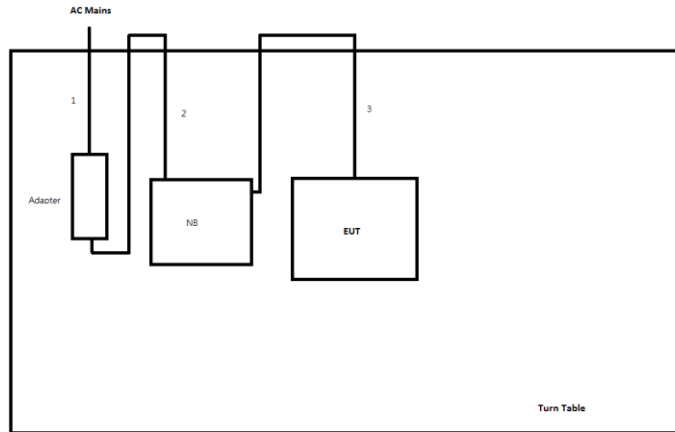

Item	Connection	Shielded	Length(m)	Remark
1	AC Power Cable	No	1.8	-
2	DC Power Cable	No	1.8	-
3	USB cable	No	1.2	-

Test Setup Diagram - Radiated Test_Mode 2

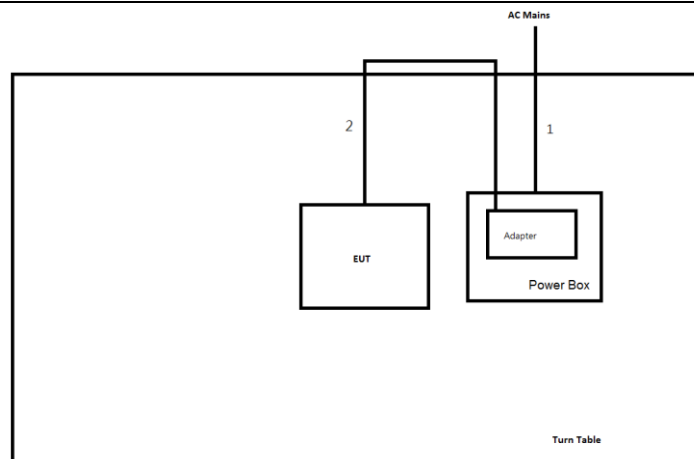

Item	Connection	Shielded	Length(m)	Remark
1	AC Power cable	No	1.8	-
2	USB cable	No	1.2	-

3 Transmitter Test Result

3.1 AC Power-line Conducted Emissions

3.1.1 AC Power-line Conducted Emissions Limit

AC Power-line Conducted Emissions Limit		
Frequency Emission (MHz)	Quasi-Peak	Average
0.15-0.5	66 - 56 *	56 - 46 *
0.5-5	56	46
5-30	60	50

Note 1: * Decreases with the logarithm of the frequency.

3.1.2 Measuring Instruments

Refer a test equipment and calibration data table in this test report.

3.1.3 Test Procedures

Test Method
▪ Refer as ANSI C63.10-2013, clause 6.2 foray power-line conducted emissions.

3.1.4 Test Setup

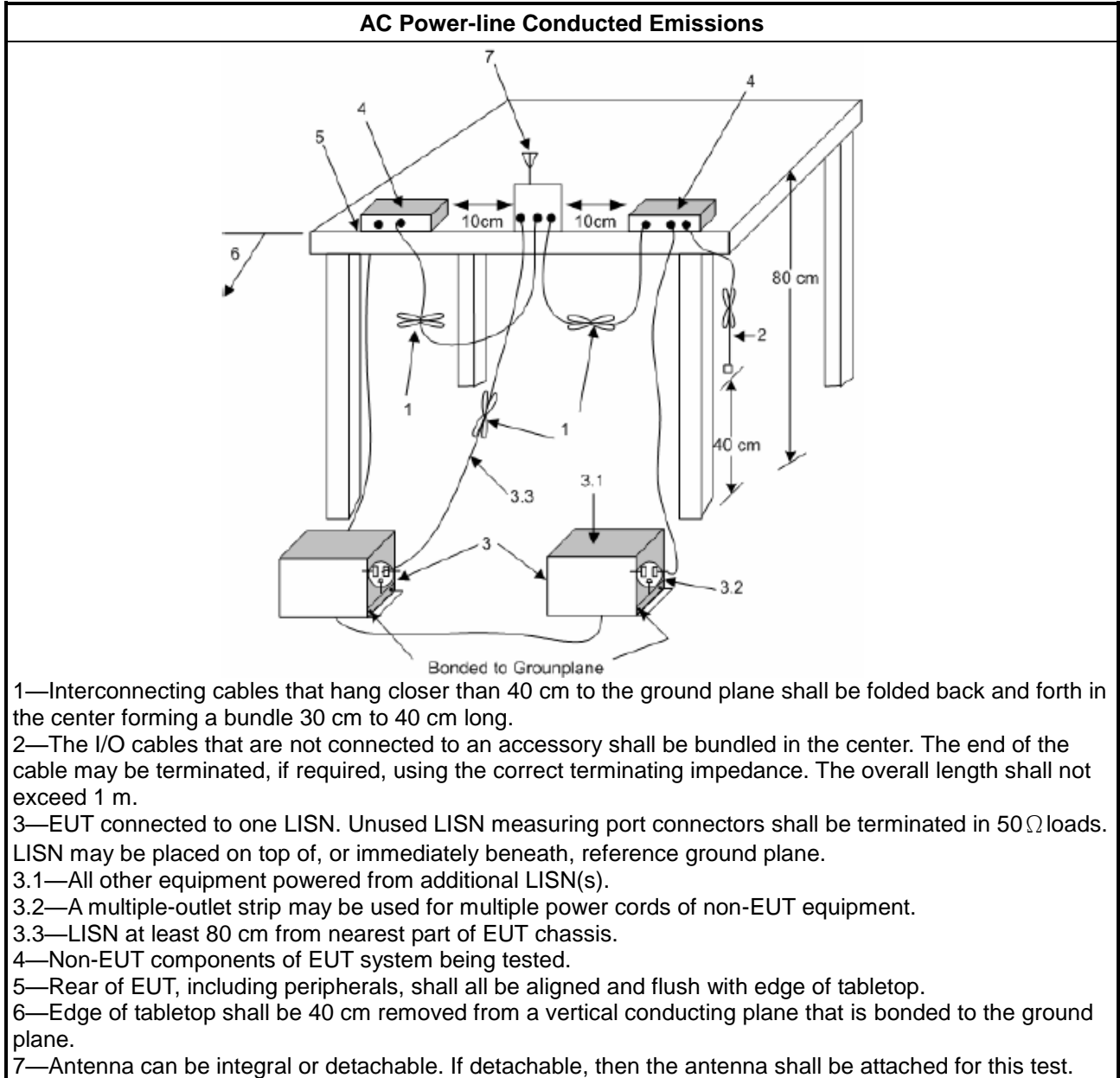

3.1.5 Test Result of AC Power-line Conducted Emissions

Refer as Appendix A

3.2 DTS Bandwidth

3.2.1 6dB Bandwidth Limit

6dB Bandwidth Limit
Systems using digital modulation techniques:
<ul style="list-style-type: none"> ▪ 6 dB bandwidth \geq 500 kHz.

3.2.2 Measuring Instruments

Refer a test equipment and calibration data table in this test report.

3.2.3 Test Procedures

Test Method
<ul style="list-style-type: none"> ▪ For the emission bandwidth shall be measured using one of the options below:
<input checked="" type="checkbox"/> Refer as KDB 558074, clause 8.2 (11.8 of ANSI C63.10) DTS bandwidth measurement.
<input type="checkbox"/> Refer as RSS-Gen, clause 6.7 for occupied bandwidth testing.
<input type="checkbox"/> Refer as ANSI C63.10, clause 6.9.3 for occupied bandwidth testing.

3.2.4 Test Setup

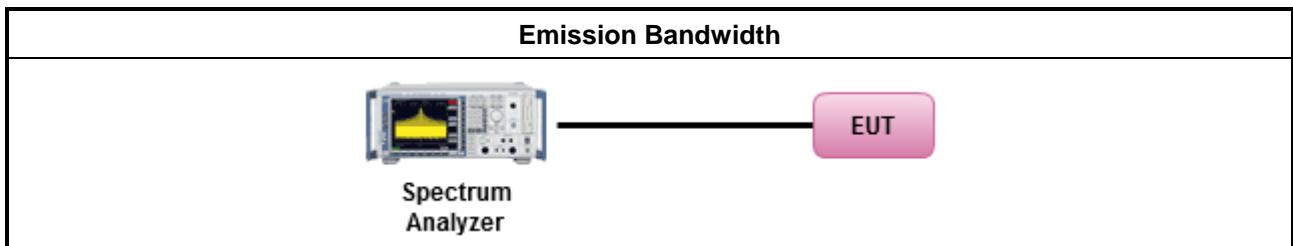

3.2.5 Test Result of Emission Bandwidth

Refer as Appendix B

3.3 Maximum Conducted Output Power

3.3.1 Maximum Conducted Output Power Limit

Maximum Conducted Output Power Limit	
	<ul style="list-style-type: none"> ▪ If $G_{TX} \leq 6$ dBi, then $P_{Out} \leq 30$ dBm (1 W)
	<ul style="list-style-type: none"> ▪ Point-to-multipoint systems (P2M): If $G_{TX} > 6$ dBi, then $P_{Out} = 30 - (G_{TX} - 6)$ dBm
	<ul style="list-style-type: none"> ▪ Point-to-point systems (P2P): If $G_{TX} > 6$ dBi, then $P_{Out} = 30 - (G_{TX} - 6)/3$ dBm
	<ul style="list-style-type: none"> ▪ Smart antenna system (SAS):
	<ul style="list-style-type: none"> - Single beam: If $G_{TX} > 6$ dBi, then $P_{Out} = 30 - (G_{TX} - 6)/3$ dBm
	<ul style="list-style-type: none"> - Overlap beam: If $G_{TX} > 6$ dBi, then $P_{Out} = 30 - (G_{TX} - 6)/3$ dBm
	<ul style="list-style-type: none"> - Aggregate power on all beams: If $G_{TX} > 6$ dBi, then $P_{Out} = 30 - (G_{TX} - 6)/3 + 8$ dB dBm
e.i.r.p. Power Limit:	
	<ul style="list-style-type: none"> ▪ 2400-2483.5 MHz Band
	<ul style="list-style-type: none"> ▪ Point-to-multipoint systems (P2M): $P_{eirp} \leq 36$ dBm (4 W)
	<ul style="list-style-type: none"> ▪ Point-to-point systems (P2P): $P_{eirp} \leq \text{MAX}(36, [P_{Out} + G_{TX}])$ dBm
	<ul style="list-style-type: none"> ▪ Smart antenna system (SAS)
	<ul style="list-style-type: none"> - Single beam: $P_{eirp} \leq \text{MAX}(36, P_{Out} + G_{TX})$ dBm
	<ul style="list-style-type: none"> - Overlap beam: $P_{eirp} \leq \text{MAX}(36, P_{Out} + G_{TX})$ dBm
	<ul style="list-style-type: none"> - Aggregate power on all beams: $P_{eirp} \leq \text{MAX}(36, [P_{Out} + G_{TX} + 8])$ dBm
P_{Out} = maximum peak conducted output power or maximum conducted output power in dBm, G_{TX} = the maximum transmitting antenna directional gain in dBi.	

3.3.2 Measuring Instruments

Refer a test equipment and calibration data table in this test report.

3.3.3 Test Procedures

Test Method	
<ul style="list-style-type: none"> ▪ Maximum Peak Conducted Output Power 	
<input type="checkbox"/>	Refer as KDB 558074, clause 8.3.1.1 (11.9.1.1 of ANSI C63.10) RBW ≥ EBW method.
<input type="checkbox"/>	Refer as KDB 558074, clause 8.3.1.2 (11.9.1.2 of ANSI C63.10) integrated band power method.
<input type="checkbox"/>	Refer as KDB 558074, clause 8.3.1.3 (11.9.1.3 of ANSI C63.10) peak power meter.
<ul style="list-style-type: none"> ▪ Maximum Average Conducted Output Power 	
<input type="checkbox"/>	Refer as KDB 558074, clause 8.3.2.2 (11.9.2.2 of ANSI C63.10) using a spectrum analyzer.
<input checked="" type="checkbox"/>	Refer as KDB 558074, clause 8.3.2.3 (11.9.2.3 of ANSI C63.10) using a power meter.
<ul style="list-style-type: none"> ▪ For conducted measurement. 	
<ul style="list-style-type: none"> ▪ If the EUT supports multiple transmit chains using options given below: Refer as KDB 662911, In-band power measurements. Using the measure-and-sum approach, measured all transmit ports individually. Sum the power (in linear power units e.g., mW) of all ports for each individual sample and save them. 	
<ul style="list-style-type: none"> ▪ If multiple transmit chains, EIRP calculation could be following as methods: $P_{total} = P_1 + P_2 + \dots + P_n$ (calculated in linear unit [mW] and transfer to log unit [dBm]) $EIRP_{total} = P_{total} + DG$ 	

3.3.4 Test Setup

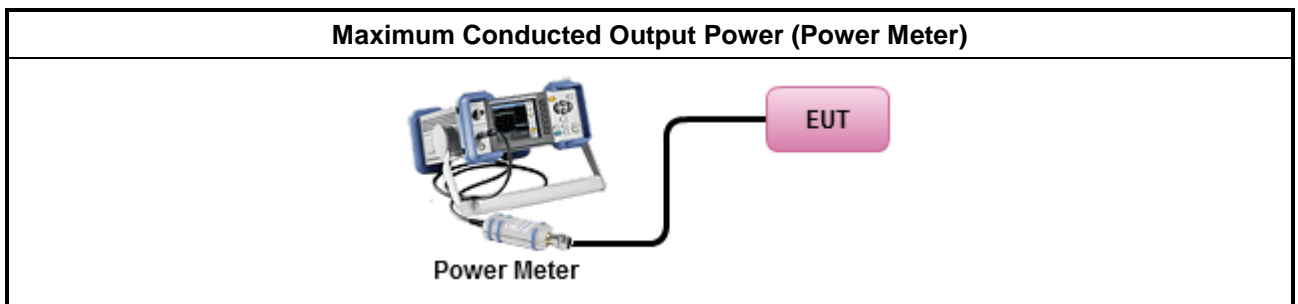

3.3.5 Test Result of Maximum Conducted Output Power

Refer as Appendix C

3.4 Power Spectral Density

3.4.1 Power Spectral Density Limit

Power Spectral Density Limit
<ul style="list-style-type: none"> Power Spectral Density (PSD) ≤ 8 dBm/3kHz

3.4.2 Measuring Instruments

Refer a test equipment and calibration data table in this test report.

3.4.3 Test Procedures

Test Method
<ul style="list-style-type: none"> Peak power spectral density procedures that the same method as used to determine the conducted output power. If maximum peak conducted output power was measured to demonstrate compliance to the output power limit, then the peak PSD procedure below (Method PKPSD) shall be used. If maximum conducted output power was measured to demonstrate compliance to the output power limit, then one of the average PSD procedures shall be used, as applicable based on the following criteria (the peak PSD procedure is also an acceptable option).
<input checked="" type="checkbox"/> Refer as KDB 558074, clause 8.4 (11.10 of ANSI C63.10) Method PKPSD.
<ul style="list-style-type: none"> For conducted measurement. <ul style="list-style-type: none"> If The EUT supports multiple transmit chains using options given below: <ul style="list-style-type: none"> Measure and sum the spectra across the outputs. Refer as KDB 662911, In-band power spectral density (PSD). Sample all transmit ports simultaneously using a spectrum analyzer for each transmit port. Where the trace bin-by-bin of each transmit port summing can be performed. (i.e., in the first spectral bin of output 1 is summed with that in the first spectral bin of output 2 and that from the first spectral bin of output 3, and so on up to the NTX output to obtain the value for the first frequency bin of the summed spectrum.). Add up the amplitude (power) values for the different transmit chains and use this as the new data trace.

3.4.4 Test Setup

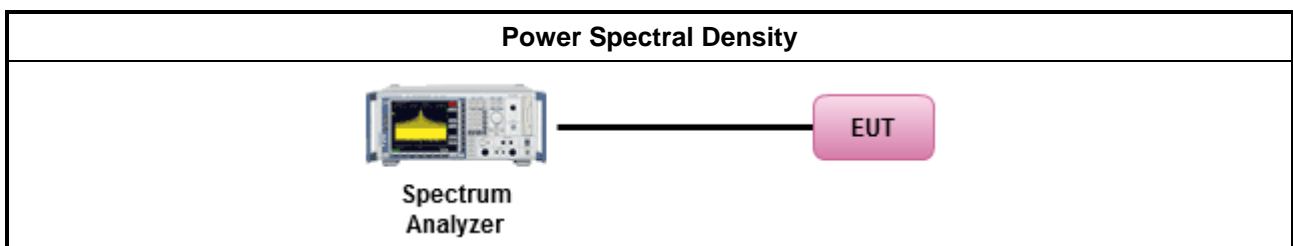

3.4.5 Test Result of Power Spectral Density

Refer as Appendix D

3.5 Emissions in Non-restricted Frequency Bands

3.5.1 Emissions in Non-restricted Frequency Bands Limit

Un-restricted Band Emissions Limit	
RF output power procedure	Limit (dB)
Peak output power procedure	20
Average output power procedure	30

Note 1: If the peak output power procedure is used to measure the fundamental emission power to demonstrate compliance to requirements, then the peak conducted output power measured within any 100 kHz outside the authorized frequency band shall be attenuated by at least 20 dB relative to the maximum measured in-band peak level.

Note 2: If the average output power procedure is used to measure the fundamental emission power to demonstrate compliance to requirements, then the power in any 100 kHz outside of the authorized frequency band shall be attenuated by at least 30 dB relative to the maximum measured in-band average level.

3.5.2 Measuring Instruments

Refer a test equipment and calibration data table in this test report.

3.5.3 Test Procedures

Test Method
<ul style="list-style-type: none"> Refer as KDB 558074, clause 8.5 (11.11 of ANSI C63.10) for non-restricted frequency bands.

3.5.4 Test Setup

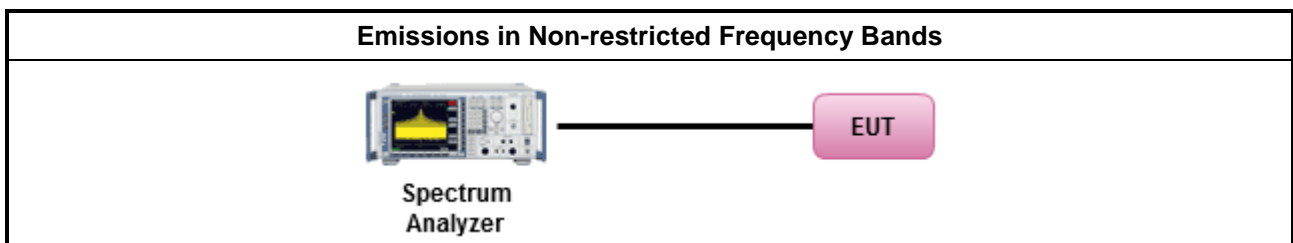

3.5.5 Test Result of Emissions in Non-restricted Frequency Bands

Refer as Appendix E

3.6 Emissions in Restricted Frequency Bands

3.6.1 Emissions in Restricted Frequency Bands Limit

Restricted Band Emissions Limit			
Frequency Range (MHz)	Field Strength (uV/m)	Field Strength (dBuV/m)	Measure Distance (m)
0.009~0.490	2400/F(kHz)	48.5 - 13.8	300
0.490~1.705	24000/F(kHz)	33.8 - 23	30
1.705~30.0	30	29	30
30~88	100	40	3
88~216	150	43.5	3
216~960	200	46	3
Above 960	500	54	3

Note 1: Test distance for frequencies at or above 30 MHz, measurements may be performed at a distance other than the limit distance provided they are not performed in the near field and the emissions to be measured can be detected by the measurement equipment. When performing measurements at a distance other than that specified, the results shall be extrapolated to the specified distance using an extrapolation factor of 20 dB/decade (inverse of linear distance for field-strength measurements, inverse of linear distance-squared for power-density measurements).

Note 2: Test distance for frequencies at below 30 MHz, measurements may be performed at a distance closer than the EUT limit distance; however, an attempt should be made to avoid making measurements in the near field. When performing measurements below 30 MHz at a closer distance than the limit distance, the results shall be extrapolated to the specified distance by either making measurements at a minimum of two or more distances on at least one radial to determine the proper extrapolation factor or by using the square of an inverse linear distance extrapolation factor (40 dB / decade). The test report shall specify the extrapolation method used to determine compliance of the EUT.

Note 3: Using the distance of 1m during the test for above 18 GHz, and the test value to correct for the distance factor at 3m.

3.6.2 Measuring Instruments

Refer a test equipment and calibration data table in this test report.

3.6.3 Test Procedures

Test Method	
	<ul style="list-style-type: none"> ▪ The average emission levels shall be measured in [duty cycle \geq 98 or duty factor].
	<ul style="list-style-type: none"> ▪ Refer as ANSI C63.10, clause 6.10.3 band-edge testing shall be performed at the lowest frequency channel and highest frequency channel within the allowed operating band.
	<ul style="list-style-type: none"> ▪ For the transmitter unwanted emissions shall be measured using following options below: <ul style="list-style-type: none"> ▪ Refer as KDB 558074, clause 8.6 (11.12 of ANSI C63.10) for restricted frequency bands.
	<ul style="list-style-type: none"> ▪ For the transmitter band-edge emissions shall be measured using following options below: <ul style="list-style-type: none"> ▪ Refer as KDB 558074 clause 8.7.1, When the performing peak or average radiated measurements, emissions within 2 MHz of the authorized band edge may be measured using the marker-delta method described below. ▪ Refer as KDB 558074, clause 8.7.2 (6.10.6 of ANSI C63.10) for marker-delta method for band-edge measurements. ▪ Refer as KDB 558074, clause 8.7.3 for narrower resolution bandwidth (100kHz) using the band power and summing the spectral levels.
	<ul style="list-style-type: none"> ▪ Use the following spectrum analyzer settings: <ul style="list-style-type: none"> ▪ Set RBW=100 kHz for $f < 1$ GHz; VBW=3 * RBW; Sweep = auto; Detector function = peak; Trace = max hold. ▪ Set RBW = 1 MHz, VBW= 3MHz for $f \geq 1$ GHz for peak measurement. For average measurement, refer as 1.1.4.
	<ul style="list-style-type: none"> ▪ KDB 414788 Open-Field Test Sites and Chamber Correlation Justification. <ul style="list-style-type: none"> ▪ Based on FCC 15.31 (f) (2): measurements may be performed at a distance closer than that specified in regulations; however, an attempt should be made to avoid making measurements in the near field. ▪ Open-field site and chamber correlation testing had been performed and chamber measured test result is the worst case test result.

3.6.4 Test Setup

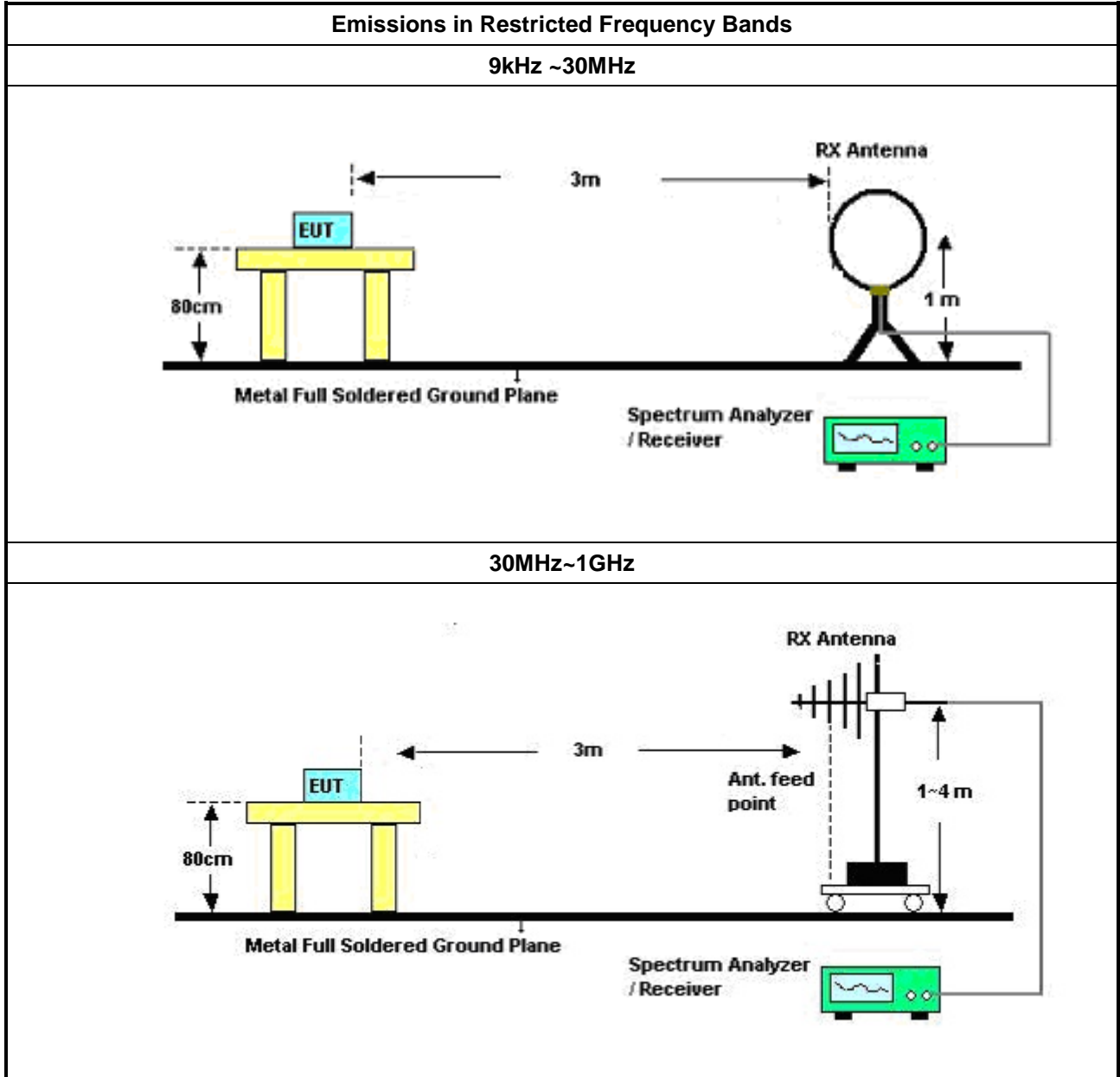

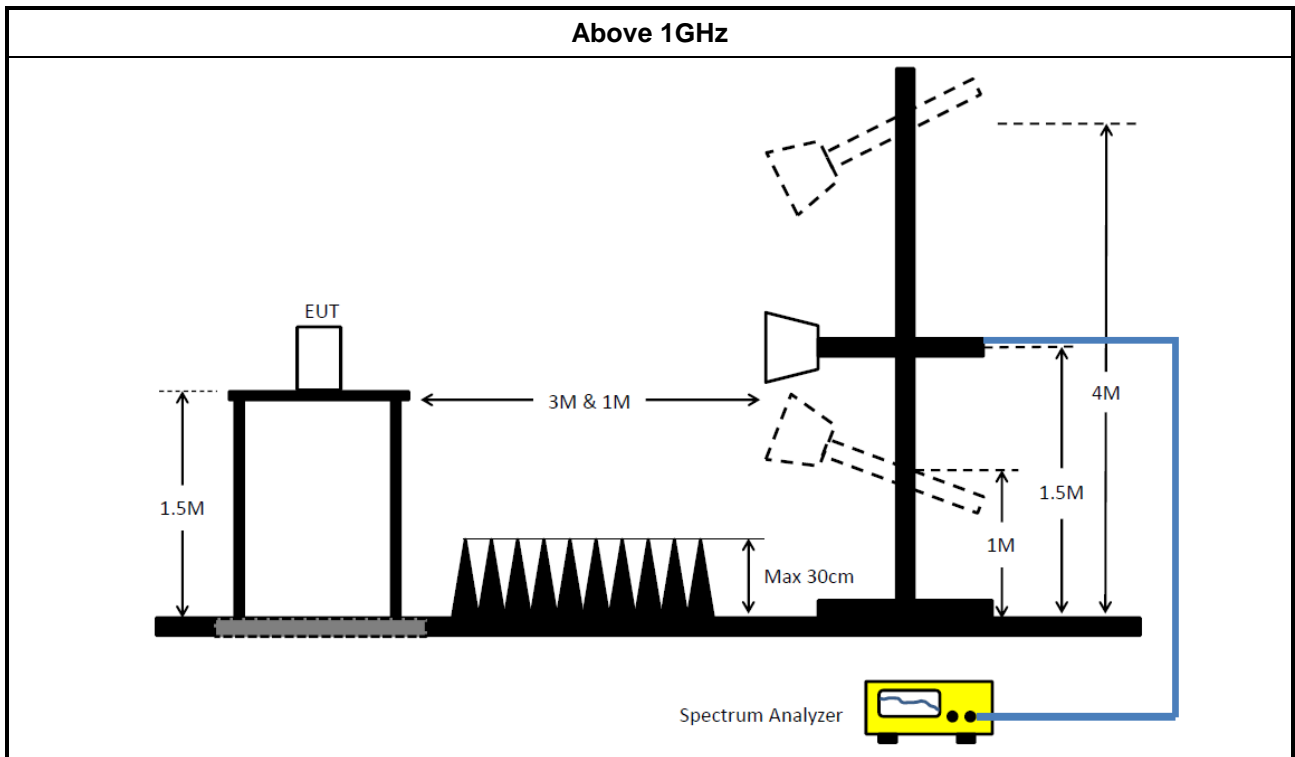

3.6.5 Test Result of Emissions in Restricted Frequency Bands (Below 30MHz)

The amplitude of spurious emissions which are attenuated by more than 20dB below the permissible value has no need to be reported.

3.6.6 Test Result of Emissions in Restricted Frequency Bands

Refer as Appendix F

4 Test Equipment and Calibration Data

Instrument for AC Conduction

Instrument	Manufacturer	Model No.	Serial No.	Spec.	Calibration Date	Calibration Due Date
EMC Receiver	R&S	ESR3	102052	9kHz~3.6GHz	09/Apr/2019	08/Apr/2020
LISN	R&S	ENV216	101295	9kHz~30MHz	08/Nov/2018	07/Nov/2019
RF Cable-CON	MTJ	RG142	CB002-CO	9kHz~200MHz	12/Sep/2019	11/Sep/2020
AC POWER	APC	AFC-11005G	F310050055	47Hz~63Hz 5~300V	NCR	NCR
Impuls Begrenzer Pulse Limiter	SCHWARZBECK	VTSD 9561-F	9561-F041	9kHz~30MHz	12/Oct/2018	11/Oct/2019

NCR : Non-Calibration Require

Instrument for Conducted Test

Instrument	Manufacturer	Model No.	Serial No.	Spec.	Calibration Date	Calibration Due Date
Spectrum Analyzer	R&S	FSV 40	101013	10Hz~40GHz	13/Mar/2019	12/Mar/2020
SMB100A Signal Generator	R&S	SMB100A03	181147	100kHz~40GHz	12/Nov/2018	10/Nov/2020
Power Sensor	Anritsu	MA2411B	0917017	300MHz~40GHz	19/Feb/2019	18/Feb/2020
Power Meter	Anritsu	ML2495A	0949003	300MHz~40GHz	19/Feb/2019	18/Feb/2020
Cable 0.2m	HUBER	MY10710/4	RF Cable - 01	30MHz~18G	11/Jan/2019	10/Jan/2020
Cable 0.2m	HUBER	MY10711/4	RF Cable - 02	30MHz~18G	11/Jan/2019	10/Jan/2020
Cable 0.5m	HUBER	MY10714/4	RF Cable - 05	30MHz~18G	11/Jan/2019	10/Jan/2020

**Instrument for Radiated Test**

Instrument	Manufacturer	Model No.	Serial No.	Spec.	Calibration Date	Calibration Due Date
3m Semi Anechoic Chamber	SIDT FRANKONIA	SAC-3M	03CH03-HY	30MHz~1GHz 3m	30/Oct/2018	29/Oct/2019
3m Semi Anechoic Chamber	SIDT FRANKONIA	SAC-3M	03CH03-HY	1GHz~18GHz 3m	30/Oct/2018	29/Oct/2019
Amplifier	HP	8447D	2944A08033	10kHz~1.3GHz	22/Apr/2019	21/Apr/2020
EMI Test Receiver	R&S	ESR3	102052	9kHz~3.6GHz	09/Apr/2019	08/Apr/2020
Bilog Antenna with 5dB Pad	ETS	3142B & MTJ6102-05	00022055	26MHz~3GHz	19/Nov/2018	18/Nov/2019
Microwave System Preamplifier	KEYSIGHT	83017A	MY53270196	1GHz~26.5GHz	09/Sep/2019	08/Sep/2020
Signal Analyzer	R&S	FSV40	101500	10Hz~40GHz	15/Aug/2019	14/Aug/2020
RF Cable-R03m	Jye Bao	RG142	CB021	9kHz~1GHz	22/Mar/2019	21/Mar/2020
RF CABLE 6m	HUBER+SUHNER	SUOFLEX 104	SN 805801/4	1GHz~40GHz	21/Mar/2019	20/Mar/2020
RF CABLE	HUBER+SUHNER	SUOFLEX 104	802378/4	1GHz~18GHz	04/Jul/2019	03/Jul/2020
Broadband Horn Antenna	SCHWARZBECK	BBHA 9170	BBHA9170339	18GHz~40GHz	19/Apr/ 2019	18/Apr/2020
Double Ridged Guide Horn Antenna	SCHWARZBECK	BBHA 9120 D	BBHA 9120 D 1531	1GHz~18GHz	09/Mar/ 2019	08/Mar/2020
Preamplifier	MITEQ	TTA1840-35-HG	1864481	18GHz~40GHz	05/Aug/2019	04/Aug/2020

AC Power-line Conducted Emissions Result

Operating Mode	1	Power Phase	Neutral
Operating Function	USB Mode		

26/09/2019

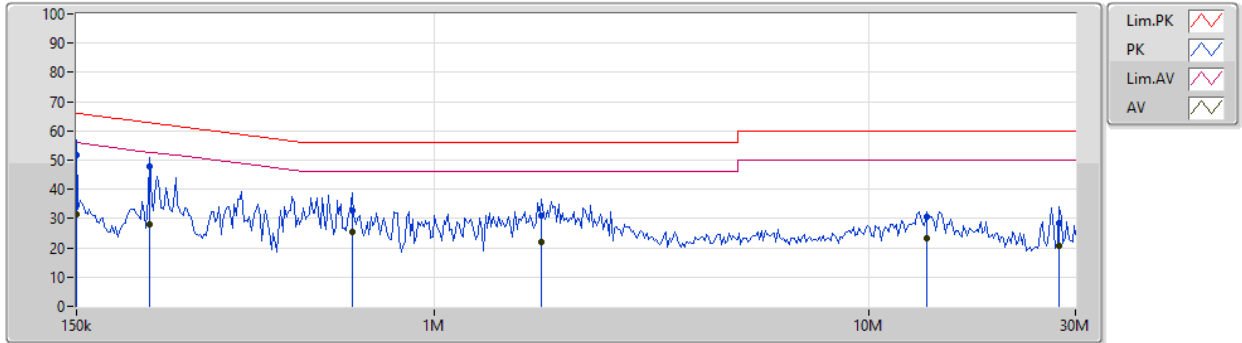

Type	Freq (Hz)	Level (dBuV)	Limit (dBuV)	Margin (dB)	Factor (dB)	Condition	Comment	Raw (dBuV)	LISN (dB)	CL (dB)	AT (dB)
QP	150k	51.83	66.00	-14.17	19.48	Neutral	"Worst"	32.35	9.60	0.01	9.87
AV	150k	31.56	56.00	-24.44	19.48	Neutral	-	12.08	9.60	0.01	9.87
QP	221.118k	47.78	62.77	-14.99	19.47	Neutral	-	28.31	9.59	0.01	9.87
AV	221.118k	28.20	52.77	-24.57	19.47	Neutral	-	8.73	9.59	0.01	9.87
QP	647.639k	32.69	56.00	-23.31	19.48	Neutral	-	13.21	9.59	0.01	9.88
AV	647.639k	25.47	46.00	-20.53	19.48	Neutral	-	5.99	9.59	0.01	9.88
QP	1.769M	30.90	56.00	-25.10	19.53	Neutral	-	11.37	9.61	0.03	9.89
AV	1.769M	21.80	46.00	-24.20	19.53	Neutral	-	2.27	9.61	0.03	9.89
QP	13.604M	30.48	60.00	-29.52	19.66	Neutral	-	10.82	9.67	0.09	9.90
AV	13.604M	23.30	50.00	-26.70	19.66	Neutral	-	3.64	9.67	0.09	9.90
QP	27.573M	28.40	60.00	-31.60	19.70	Neutral	-	8.70	9.67	0.13	9.90
AV	27.573M	20.61	50.00	-29.39	19.70	Neutral	-	0.91	9.67	0.13	9.90



AC Power-line Conducted Emissions Result

Operating Mode	1	Power Phase	Line
Operating Function	USB Mode		

26/09/2019



Type	Freq (Hz)	Level (dBuV)	Limit (dBuV)	Margin (dB)	Factor (dB)	Condition	Comment	Raw (dBuV)	LISN (dB)	CL (dB)	AT (dB)
QP	221.118k	44.66	62.77	-18.11	19.48	Line	"Worst"	25.18	9.60	0.01	9.87
AV	221.118k	28.17	52.77	-24.60	19.48	Line	-	8.69	9.60	0.01	9.87
QP	480.498k	34.76	56.33	-21.57	19.48	Line	-	15.28	9.59	0.01	9.88
AV	480.498k	19.92	46.33	-26.41	19.48	Line	-	0.44	9.59	0.01	9.88
QP	782.419k	30.96	56.00	-25.04	19.50	Line	-	11.46	9.60	0.02	9.88
AV	782.419k	20.60	46.00	-25.40	19.50	Line	-	1.10	9.60	0.02	9.88
QP	1.897M	32.26	56.00	-23.74	19.54	Line	-	12.72	9.62	0.03	9.89
AV	1.897M	25.90	46.00	-20.10	19.54	Line	-	6.36	9.62	0.03	9.89
QP	6.198M	29.84	60.00	-30.16	19.60	Line	-	10.24	9.65	0.06	9.89
AV	6.198M	23.33	50.00	-26.67	19.60	Line	-	3.73	9.65	0.06	9.89
QP	25.212M	29.39	60.00	-30.61	19.59	Line	-	9.80	9.57	0.12	9.90
AV	25.212M	20.54	50.00	-29.46	19.59	Line	-	0.95	9.57	0.12	9.90



AC Power-line Conducted Emissions Result

Operating Mode	2	Power Phase	Neutral
Operating Function	Adapter mode		

26/09/2019

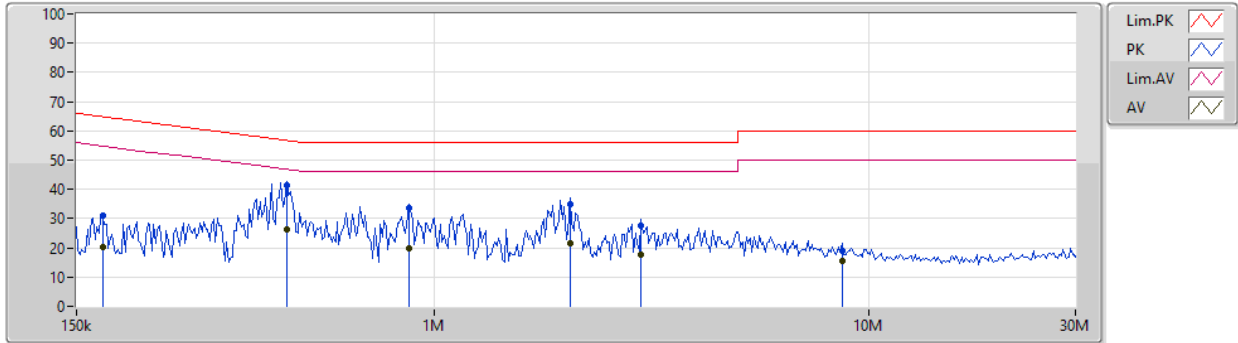

Type	Freq (Hz)	Level (dBuV)	Limit (dBuV)	Margin (dB)	Factor (dB)	Condition	Comment	Raw (dBuV)	LISN (dB)	CL (dB)	AT (dB)
QP	172.421k	31.19	64.83	-33.64	19.48	Neutral	-	11.71	9.60	0.01	9.87
AV	172.421k	20.29	54.83	-34.54	19.48	Neutral	-	0.81	9.60	0.01	9.87
QP	457.178k	41.23	56.75	-15.52	19.48	Neutral	"Worst"	21.75	9.59	0.01	9.88
AV	457.178k	26.45	46.75	-20.30	19.48	Neutral	-	6.97	9.59	0.01	9.88
QP	872.92k	33.69	56.00	-22.31	19.49	Neutral	-	14.20	9.59	0.02	9.88
AV	872.92k	19.75	46.00	-26.25	19.49	Neutral	-	0.26	9.59	0.02	9.88
QP	2.054M	34.81	56.00	-21.19	19.53	Neutral	-	15.28	9.61	0.03	9.89
AV	2.054M	21.68	46.00	-24.32	19.53	Neutral	-	2.15	9.61	0.03	9.89
QP	2.998M	27.50	56.00	-28.50	19.54	Neutral	-	7.96	9.61	0.04	9.89
AV	2.998M	17.52	46.00	-28.48	19.54	Neutral	-	-2.02	9.61	0.04	9.89
QP	8.694M	18.87	60.00	-41.13	19.62	Neutral	-	-0.75	9.66	0.07	9.89
AV	8.694M	15.33	50.00	-34.67	19.62	Neutral	-	-4.29	9.66	0.07	9.89



AC Power-line Conducted Emissions Result

Operating Mode	2	Power Phase	Line
Operating Function	Adapter mode		

26/09/2019

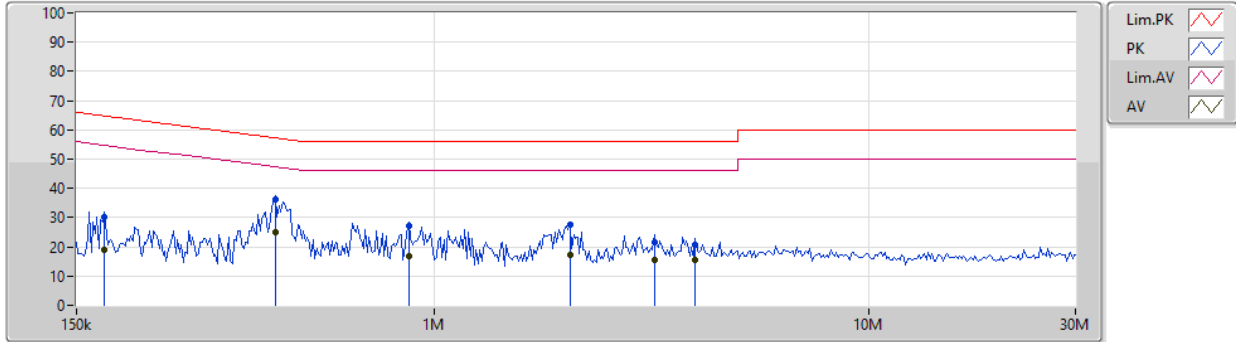

Type	Freq (Hz)	Level (dBuV)	Limit (dBuV)	Margin (dB)	Factor (dB)	Condition	Comment	Raw (dBuV)	LISN (dB)	CL (dB)	AT (dB)
QP	174.145k	30.25	64.76	-34.51	19.48	Line	-	10.77	9.60	0.01	9.87
AV	174.145k	18.79	54.76	-35.97	19.48	Line	-	-0.69	9.60	0.01	9.87
QP	430.682k	36.02	57.24	-21.22	19.48	Line	"Worst"	16.54	9.59	0.01	9.88
AV	430.682k	24.81	47.24	-22.43	19.48	Line	-	5.33	9.59	0.01	9.88
QP	872.92k	27.19	56.00	-28.81	19.50	Line	-	7.69	9.60	0.02	9.88
AV	872.92k	16.68	46.00	-29.32	19.50	Line	-	-2.82	9.60	0.02	9.88
QP	2.054M	27.71	56.00	-28.29	19.54	Line	-	8.17	9.62	0.03	9.89
AV	2.054M	17.37	46.00	-28.63	19.54	Line	-	-2.17	9.62	0.03	9.89
QP	3.214M	21.62	56.00	-34.38	19.56	Line	-	2.06	9.63	0.04	9.89
AV	3.214M	15.66	46.00	-30.34	19.56	Line	-	-3.90	9.63	0.04	9.89
QP	4.001M	20.52	56.00	-35.48	19.57	Line	-	0.95	9.63	0.05	9.89
AV	4.001M	15.44	46.00	-30.56	19.57	Line	-	-4.13	9.63	0.05	9.89



Summary

Mode	Max-N dB (Hz)	Max-OBW (Hz)	ITU-Code	Min-N dB (Hz)	Min-OBW (Hz)
2.4-2.4835GHz	-	-	-	-	-
BT-LE(1Mbps)	720k	1.036M	1M04F1D	717.5k	1.029M
BT-LE(2Mbps)	1.255M	2.051M	2M05F1D	1.253M	2.039M

Max-N dB = Maximum 6dB down bandwidth; **Max-OBW** = Maximum 99% occupied bandwidth;
Min-N dB = Minimum 6dB down bandwidth; **Min-OBW** = Minimum 99% occupied bandwidth;



Result

Mode	Result	Limit (Hz)	Port 1-N dB (Hz)	Port 1-OBW (Hz)
BT-LE(1Mbps)	-	-	-	-
2402MHz_TnomVnom	Pass	500k	720k	1.036M
2440MHz_TnomVnom	Pass	500k	717.5k	1.029M
2480MHz_TnomVnom	Pass	500k	720k	1.031M
BT-LE(2Mbps)	-	-	-	-
2402MHz_TnomVnom	Pass	500k	1.255M	2.051M
2440MHz_TnomVnom	Pass	500k	1.255M	2.039M
2480MHz_TnomVnom	Pass	500k	1.253M	2.039M

Port X-N dB = Port X 6dB down bandwidth; Port X-OBW = Port X 99% occupied bandwidth;

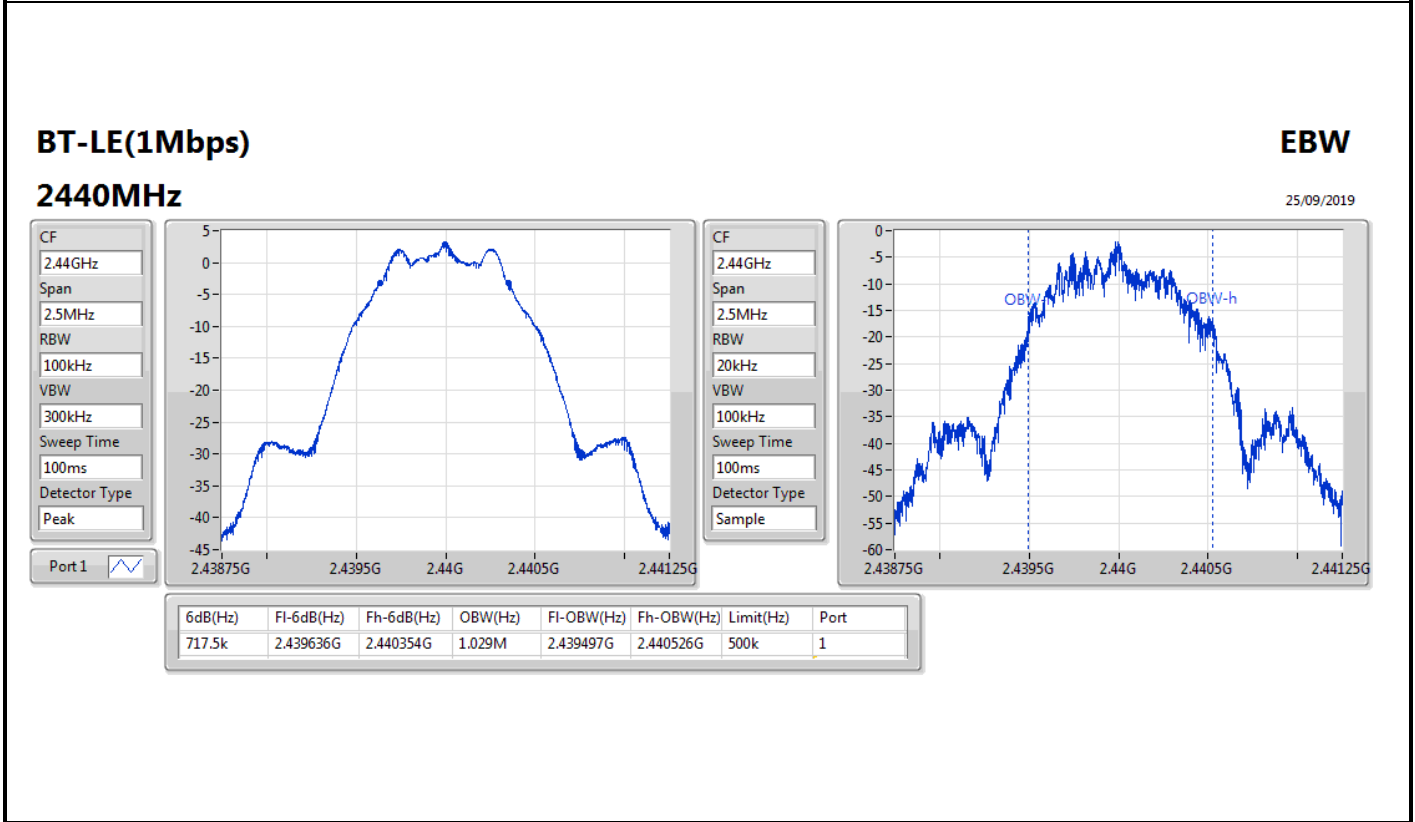
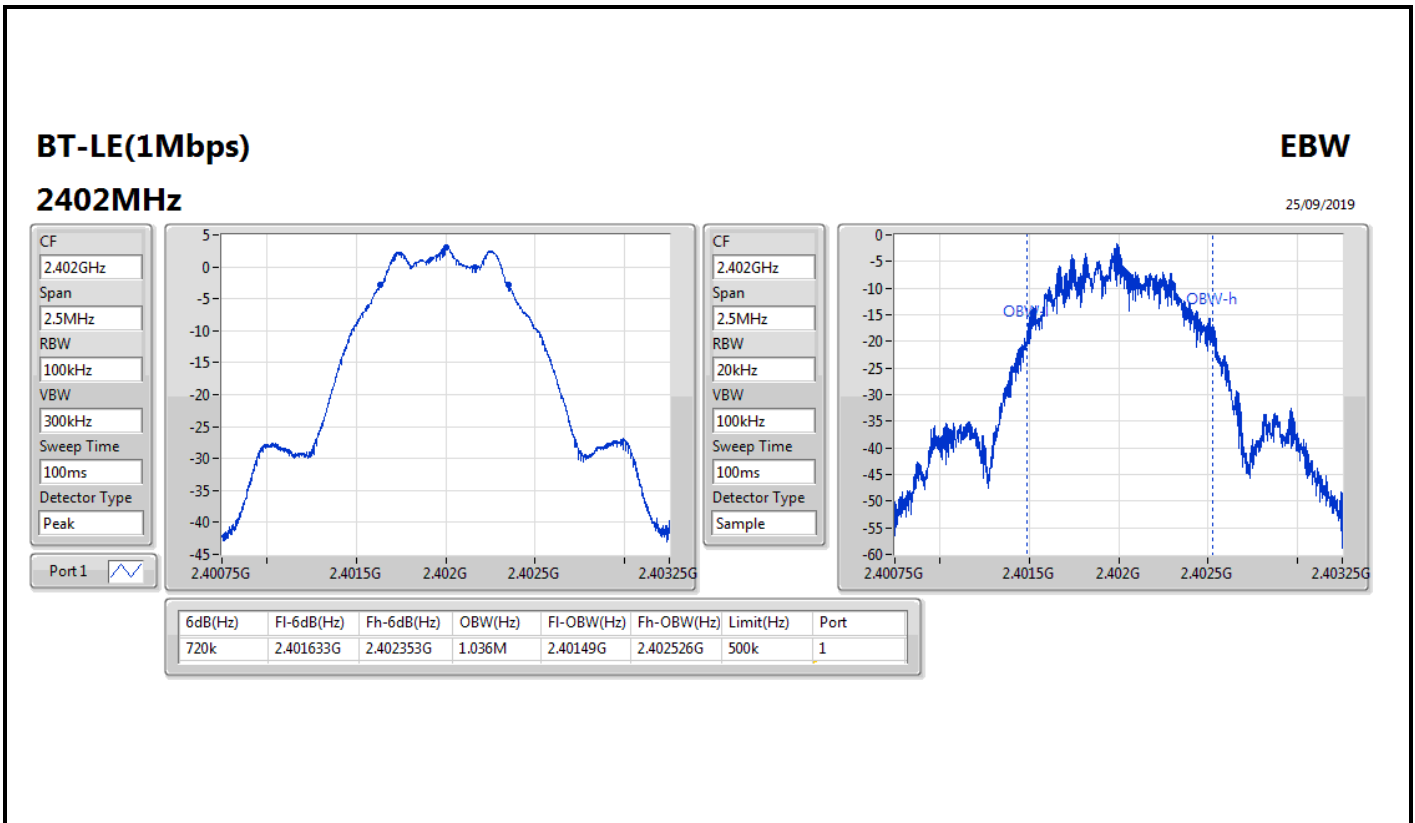

BT-LE(1Mbps)

EBW

2480MHz

25/09/2019

CF
2.48GHz
Span
2.5MHz
RBW
100kHz
VBW
300kHz
Sweep Time
100ms
Detector Type
Peak
Port 1

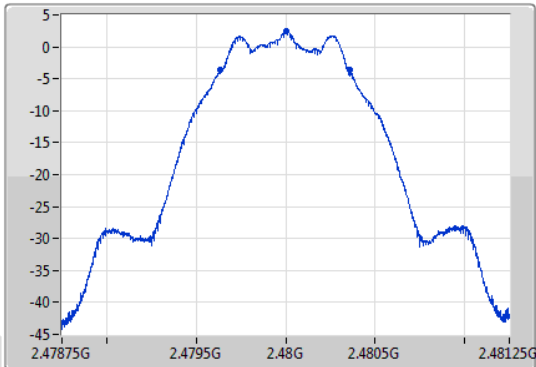

CF
2.48GHz
Span
2.5MHz
RBW
20kHz
VBW
100kHz
Sweep Time
100ms
Detector Type
Sample

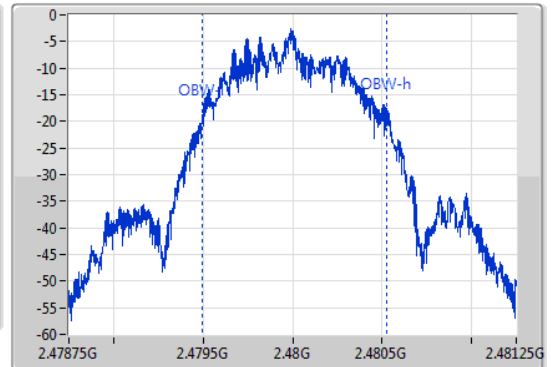

6dB(Hz)	Fl-6dB(Hz)	Fh-6dB(Hz)	OBW(Hz)	Fl-OBW(Hz)	Fh-OBW(Hz)	Limit(Hz)	Port
720k	2.479636G	2.480356G	1.031M	2.479498G	2.480528G	500k	1

BT-LE(2Mbps)

EBW

2402MHz

25/09/2019

CF
2.402GHz
Span
5MHz
RBW
100kHz
VBW
300kHz
Sweep Time
100ms
Detector Type
Peak
Port 1

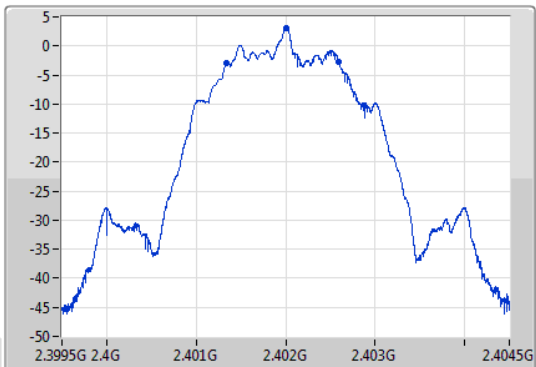

CF
2.402GHz
Span
5MHz
RBW
30kHz
VBW
100kHz
Sweep Time
100ms
Detector Type
Sample

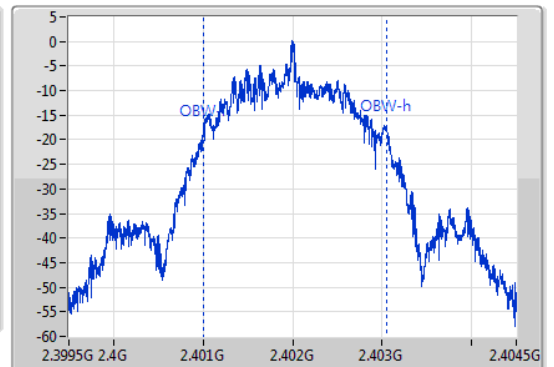

6dB(Hz)	Fl-6dB(Hz)	Fh-6dB(Hz)	OBW(Hz)	Fl-OBW(Hz)	Fh-OBW(Hz)	Limit(Hz)	Port
1.255M	2.401343G	2.402598G	2.051M	2.400998G	2.403049G	500k	1

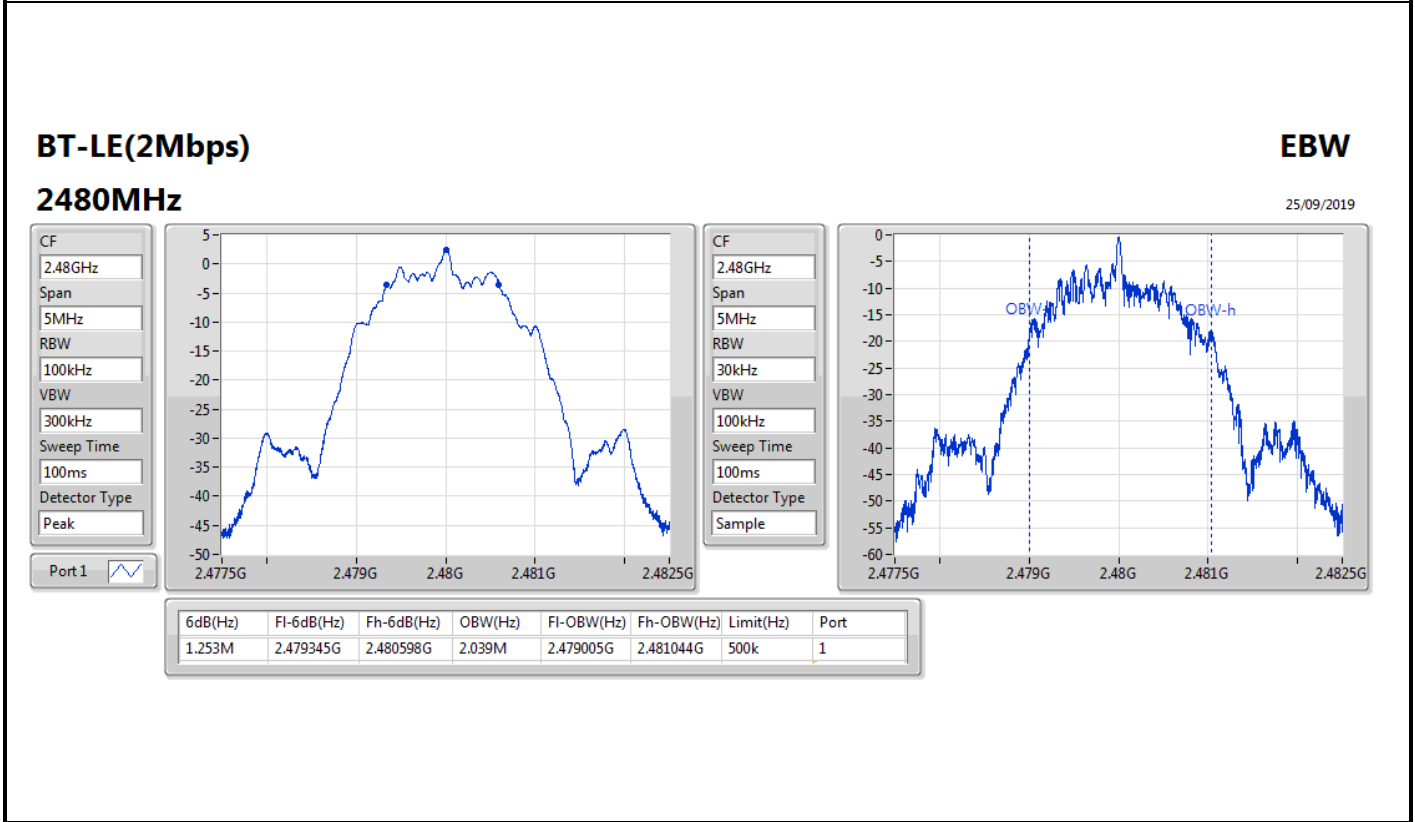
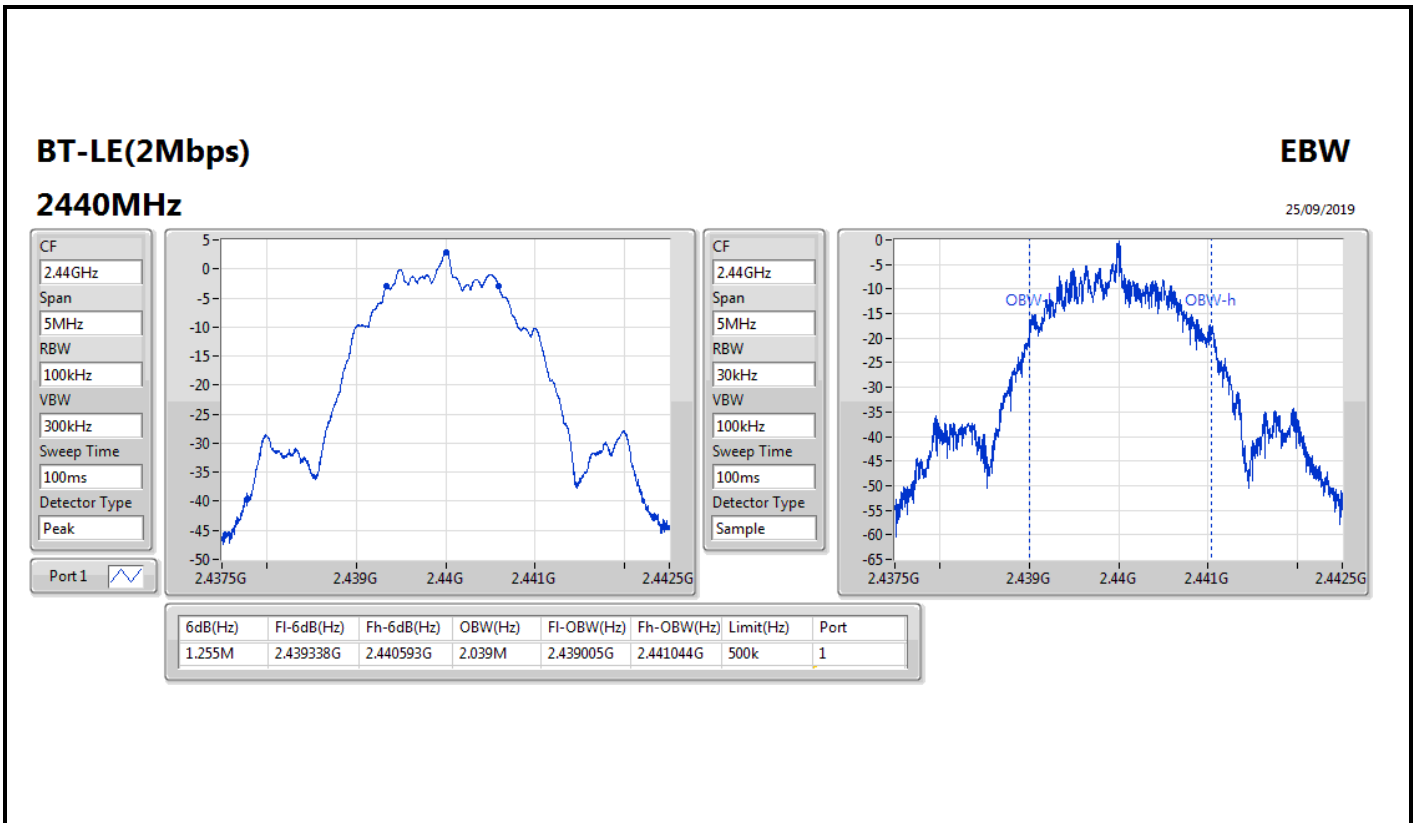



Summary

Mode	Power (dBm)	Power (W)
2.4-2.4835GHz	-	-
BT-LE(1Mbps)	3.06	0.00202
BT-LE(2Mbps)	2.97	0.00198



Result

Mode	Result	Gain (dBi)	Power (dBm)	Power Limit (dBm)
BT-LE(1Mbps)	-	-	-	-
2402MHz_TnomVnom	Pass	1.82	3.06	30.00
2440MHz_TnomVnom	Pass	1.82	2.81	30.00
2480MHz_TnomVnom	Pass	1.82	2.37	30.00
BT-LE(2Mbps)	-	-	-	-
2402MHz_TnomVnom	Pass	1.82	2.97	30.00
2440MHz_TnomVnom	Pass	1.82	2.81	30.00
2480MHz_TnomVnom	Pass	1.82	2.35	30.00

DG = Directional Gain; Port X = Port X output power



Summary

Mode	PD (dBm/RBW)
2.4-2.4835GHz	-
BT-LE(1Mbps)	-11.72
BT-LE(2Mbps)	-15.09

RBW=3 kHz.



Result

Mode	Result	Gain (dBi)	PD (dBm/RBW)	PD Limit (dBm/RBW)
BT-LE(1Mbps)	-	-	-	-
2402MHz_TnomVnom	Pass	1.82	-11.72	8.00
2440MHz_TnomVnom	Pass	1.82	-14.18	8.00
2480MHz_TnomVnom	Pass	1.82	-14.67	8.00
BT-LE(2Mbps)	-	-	-	-
2402MHz_TnomVnom	Pass	1.82	-15.39	8.00
2440MHz_TnomVnom	Pass	1.82	-15.09	8.00
2480MHz_TnomVnom	Pass	1.82	-15.50	8.00

DG = Directional Gain; RBW=3 kHz;

PD = trace bin-by-bin of each transmits port summing can be performed maximum power density; Port X = Port X power density;

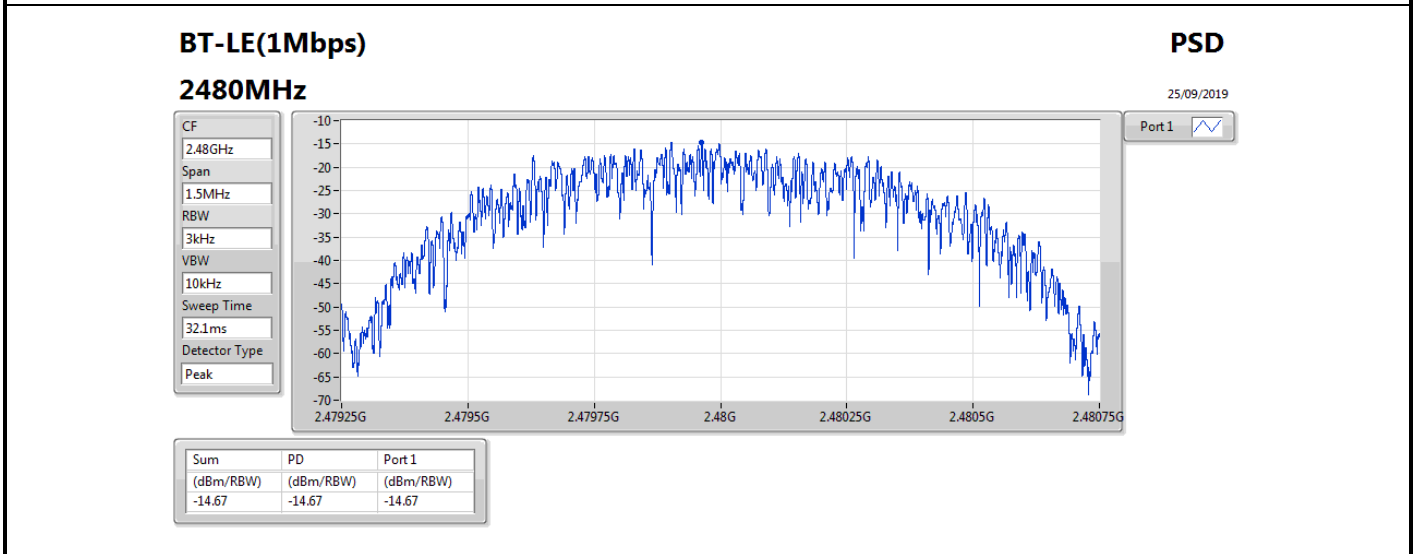
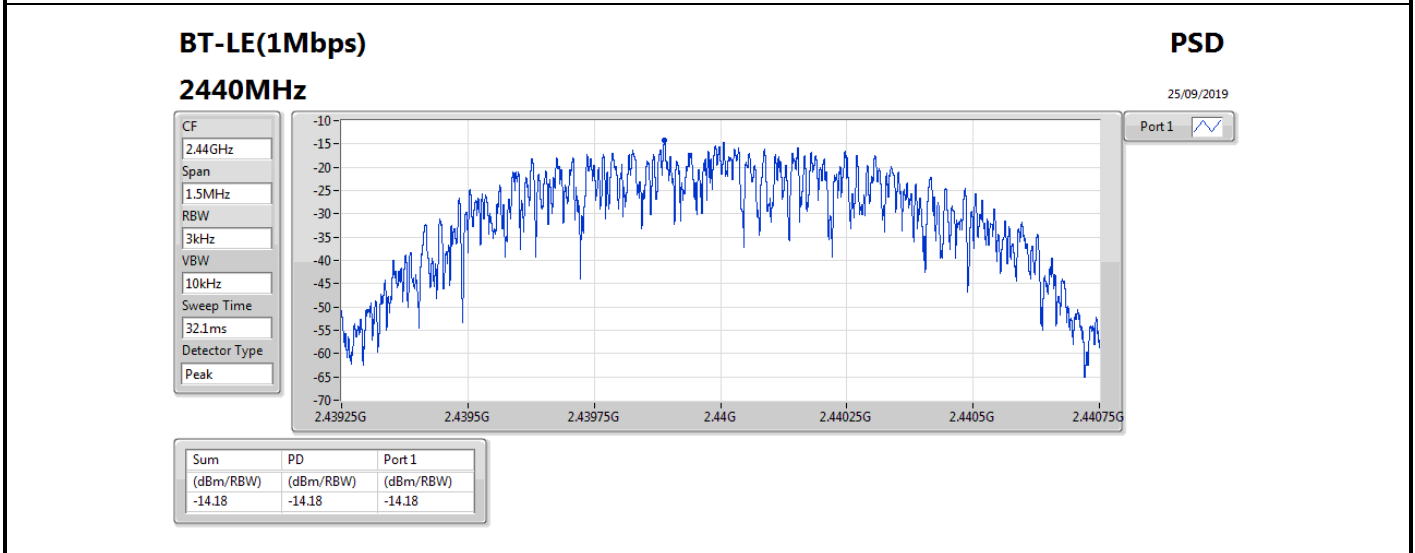
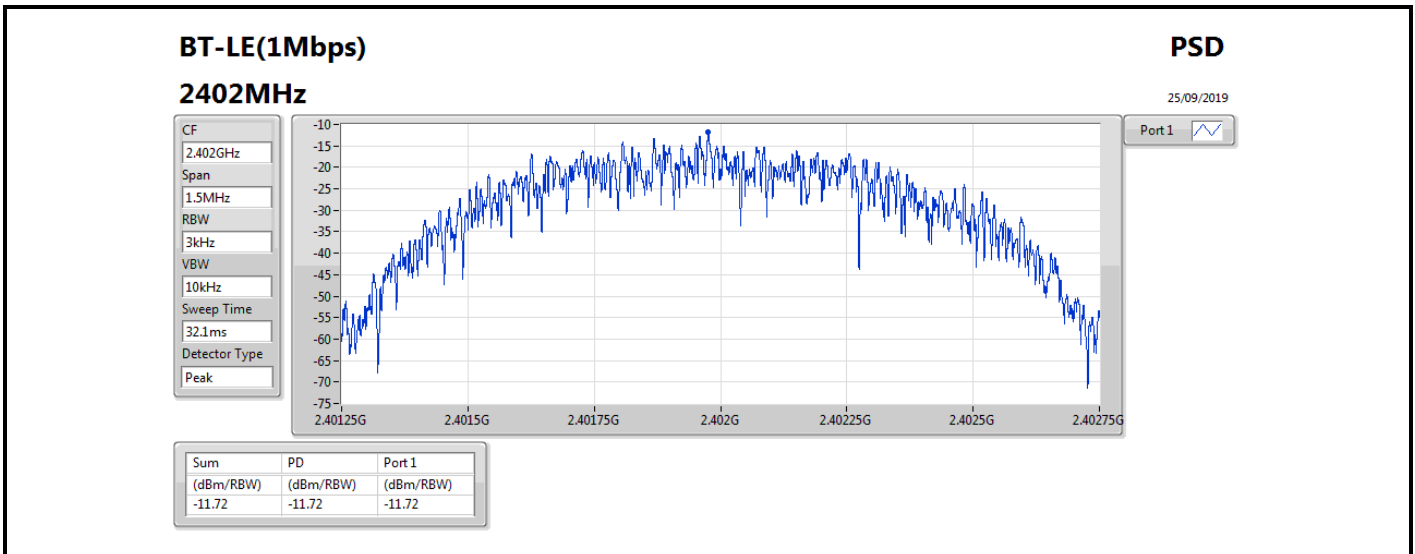

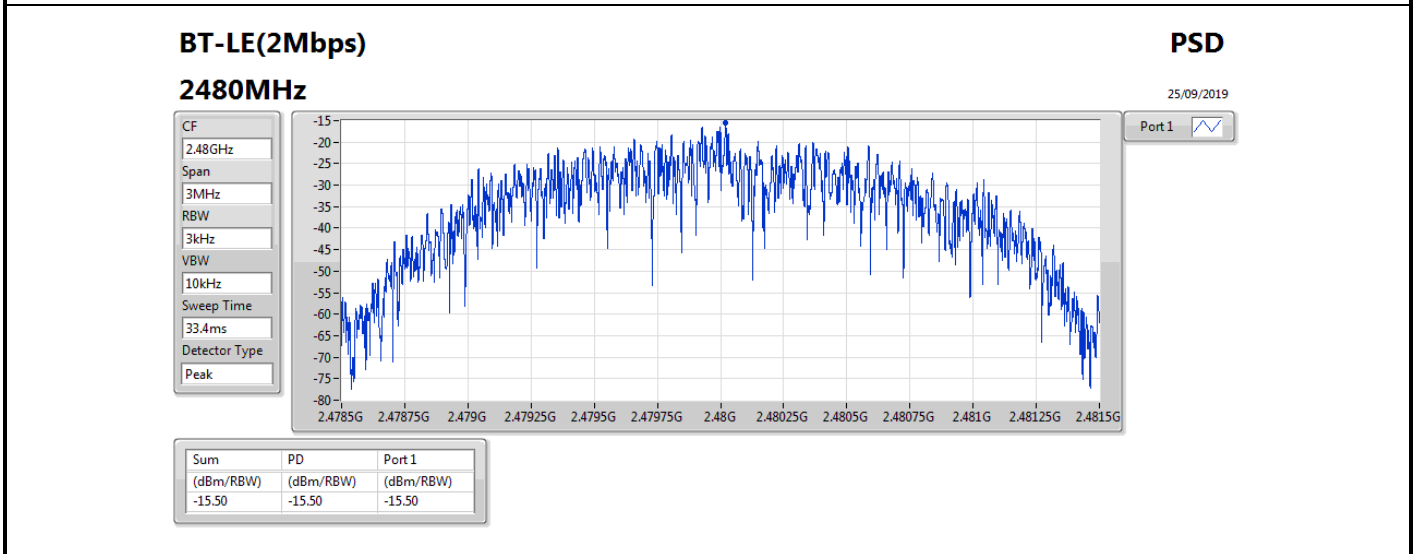
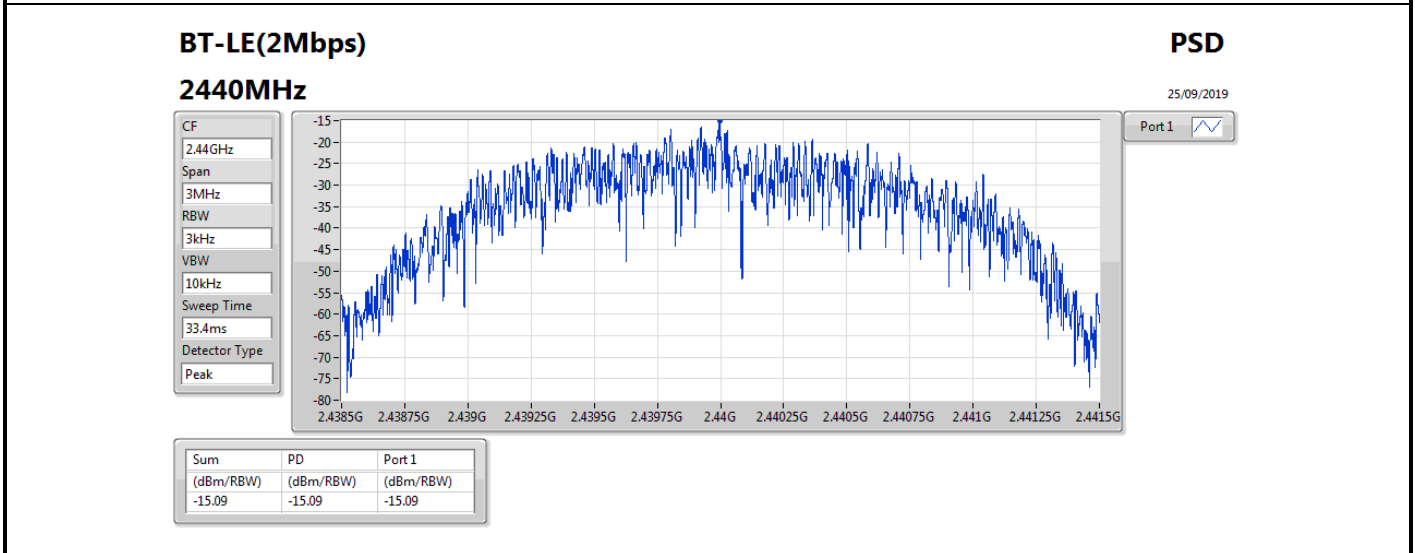
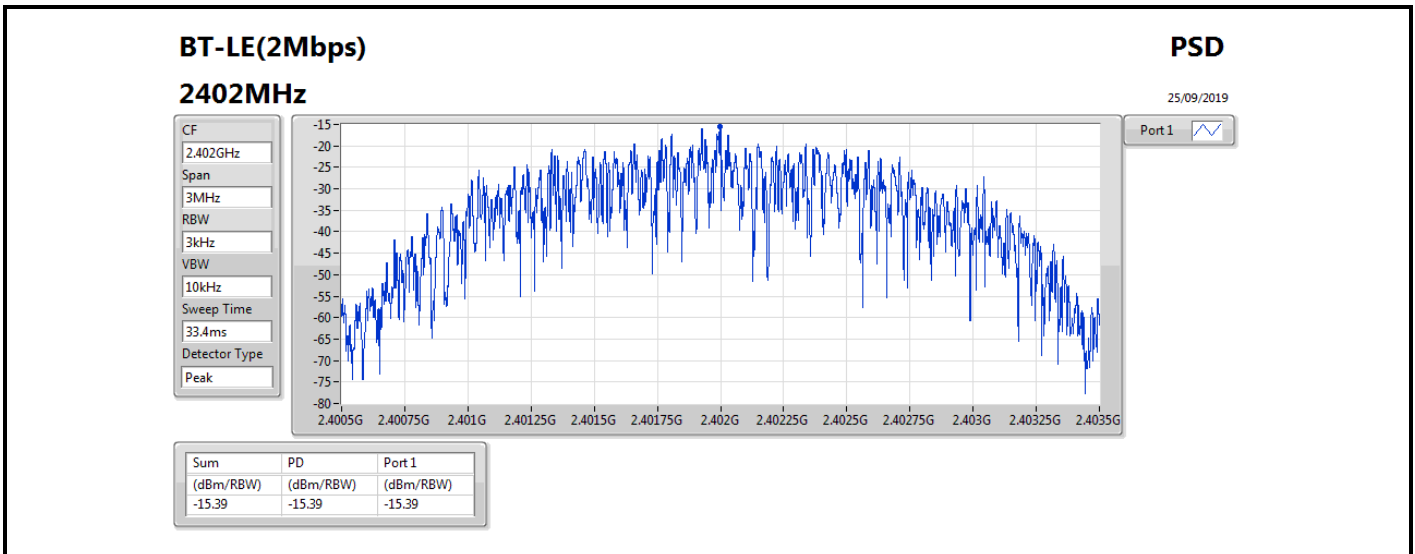



Summary

Mode	Result	Ref (Hz)	Ref (dBm)	Limit (dBm)	Freq (Hz)	Level (dBm)	Freq (Hz)	Level (dBm)	Freq (Hz)	Level (dBm)	Freq (Hz)	Level (dBm)	Port
2.4-2.4835GHz	-	-	-	-	-	-	-	-	-	-	-	-	-
BT-LE(1Mbps)	Pass	2.40196G	2.99	-27.01	2.19406G	-55.46	2.39882G	-53.37	2.48403G	-52.56	24.46809G	-35.52	1
BT-LE(2Mbps)	Pass	2.402G	3.23	-26.77	2.30668G	-54.38	2.39999G	-27.92	2.48466G	-52.03	23.12865G	-36.93	1



Result

Mode	Result	Ref (Hz)	Ref (dBm)	Limit (dBm)	Freq (Hz)	Level (dBm)	Freq (Hz)	Level (dBm)	Freq (Hz)	Level (dBm)	Freq (Hz)	Level (dBm)	Port
BT-LE(1Mbps)	-	-	-	-	-	-	-	-	-	-	-	-	-
2402MHz_TnomVnom	Pass	2.40196G	2.99	-27.01	1.9389G	-54.95	2.39998G	-50.17	2.48521G	-52.67	24.07128G	-36.87	1
2440MHz_TnomVnom	Pass	2.40196G	2.99	-27.01	1.8951G	-54.31	2.39922G	-53.04	2.48371G	-52.32	24.38929G	-36.36	1
2480MHz_TnomVnom	Pass	2.40196G	2.99	-27.01	2.19406G	-55.46	2.39882G	-53.37	2.48403G	-52.56	24.46809G	-35.52	1
BT-LE(2Mbps)	-	-	-	-	-	-	-	-	-	-	-	-	-
2402MHz_TnomVnom	Pass	2.402G	3.23	-26.77	2.30668G	-54.38	2.39999G	-27.92	2.48466G	-52.03	23.12865G	-36.93	1
2440MHz_TnomVnom	Pass	2.402G	3.23	-26.77	2.39363G	-55.02	2.39718G	-52.63	2.48695G	-52.86	24.35558G	-35.72	1
2480MHz_TnomVnom	Pass	2.402G	3.23	-26.77	2.11829G	-54.14	2.39904G	-52.67	2.48619G	-50.56	24.39498G	-36.63	1

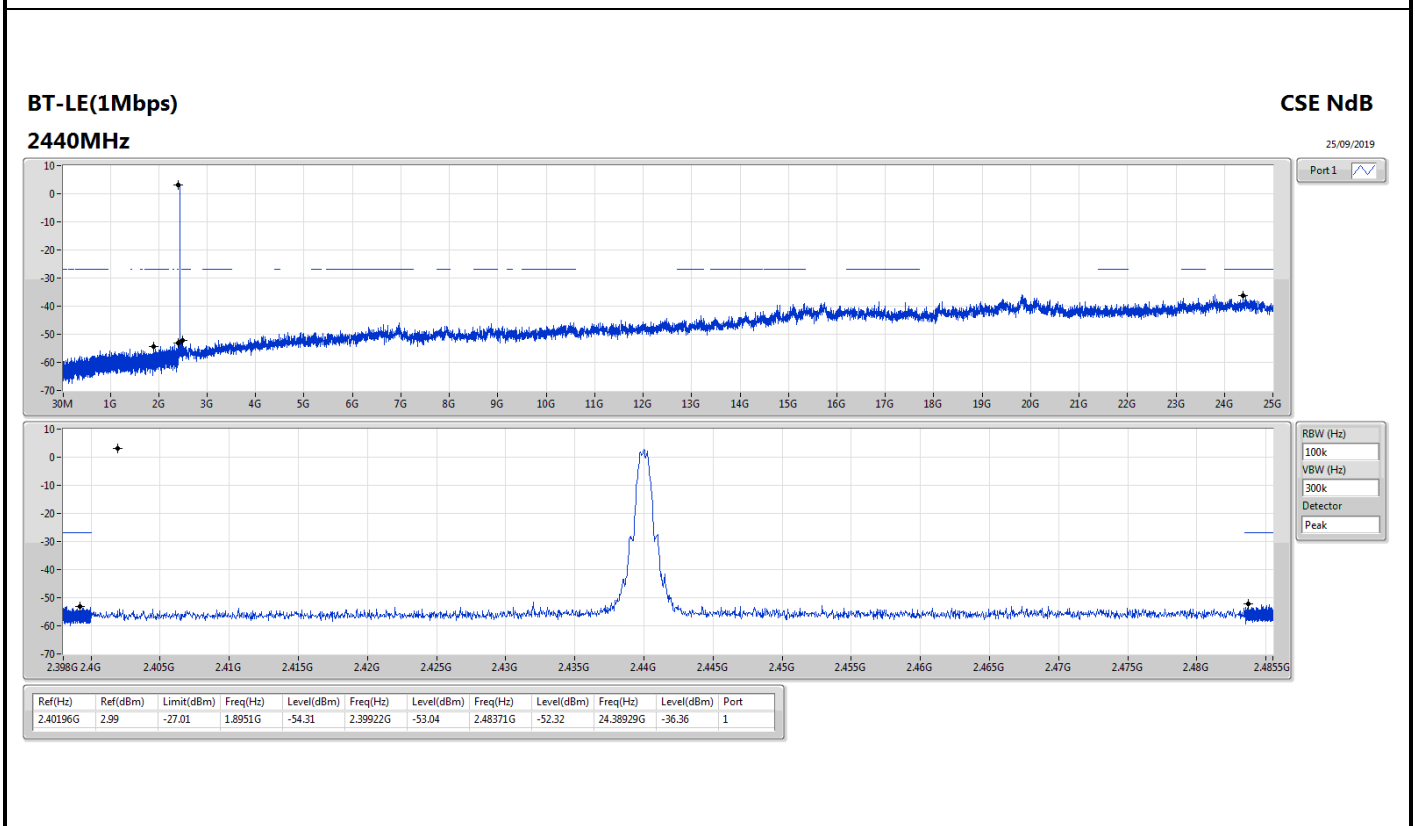
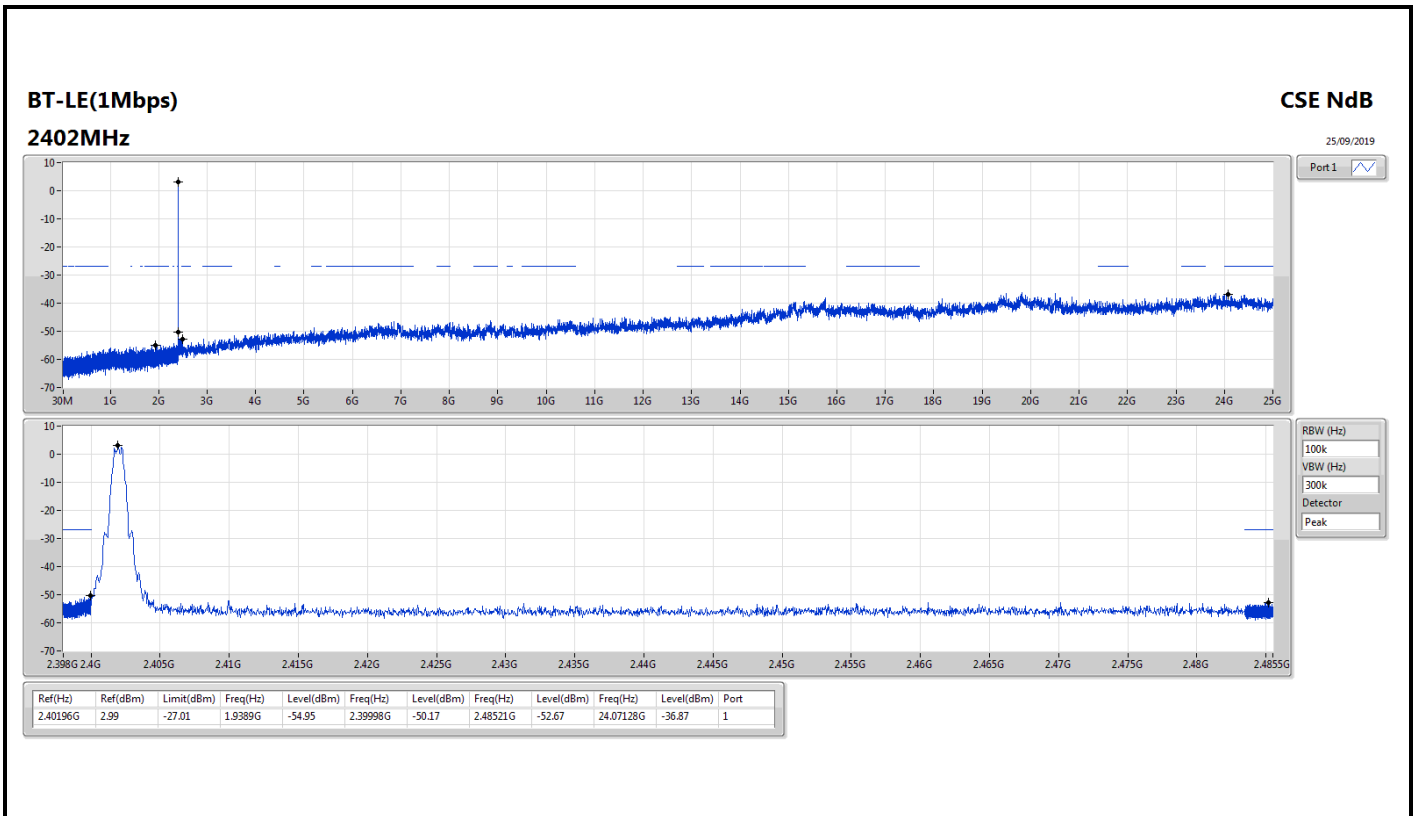

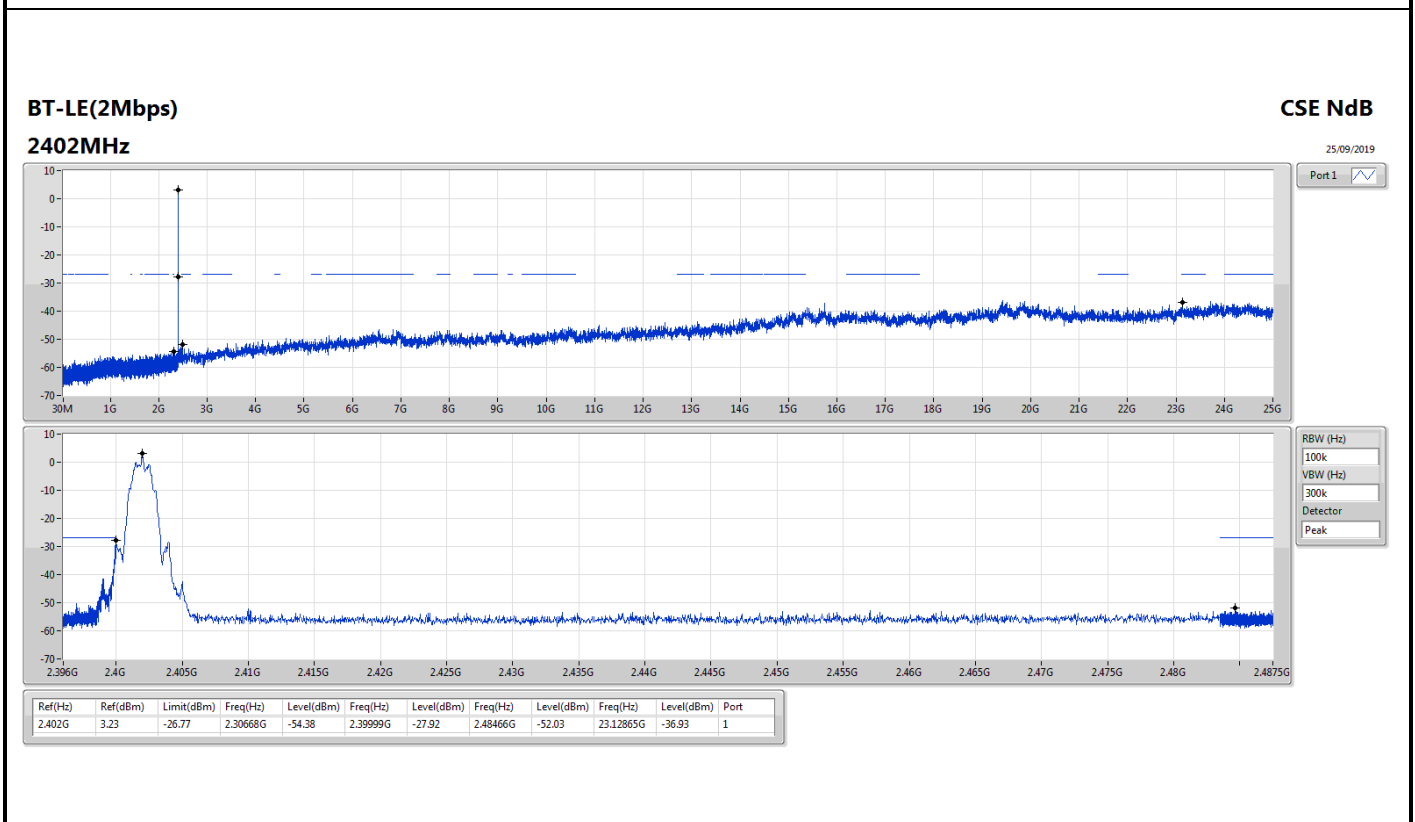
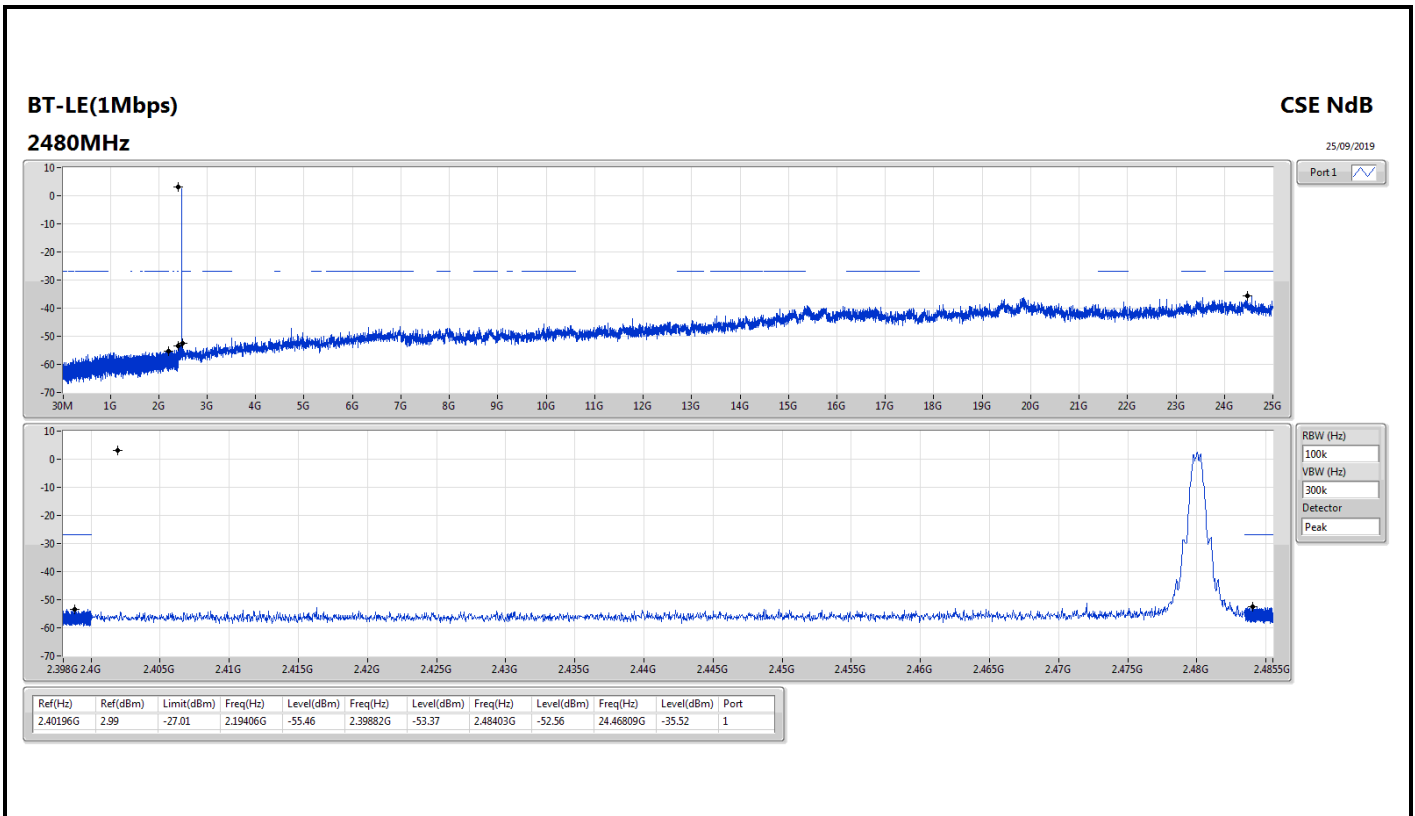

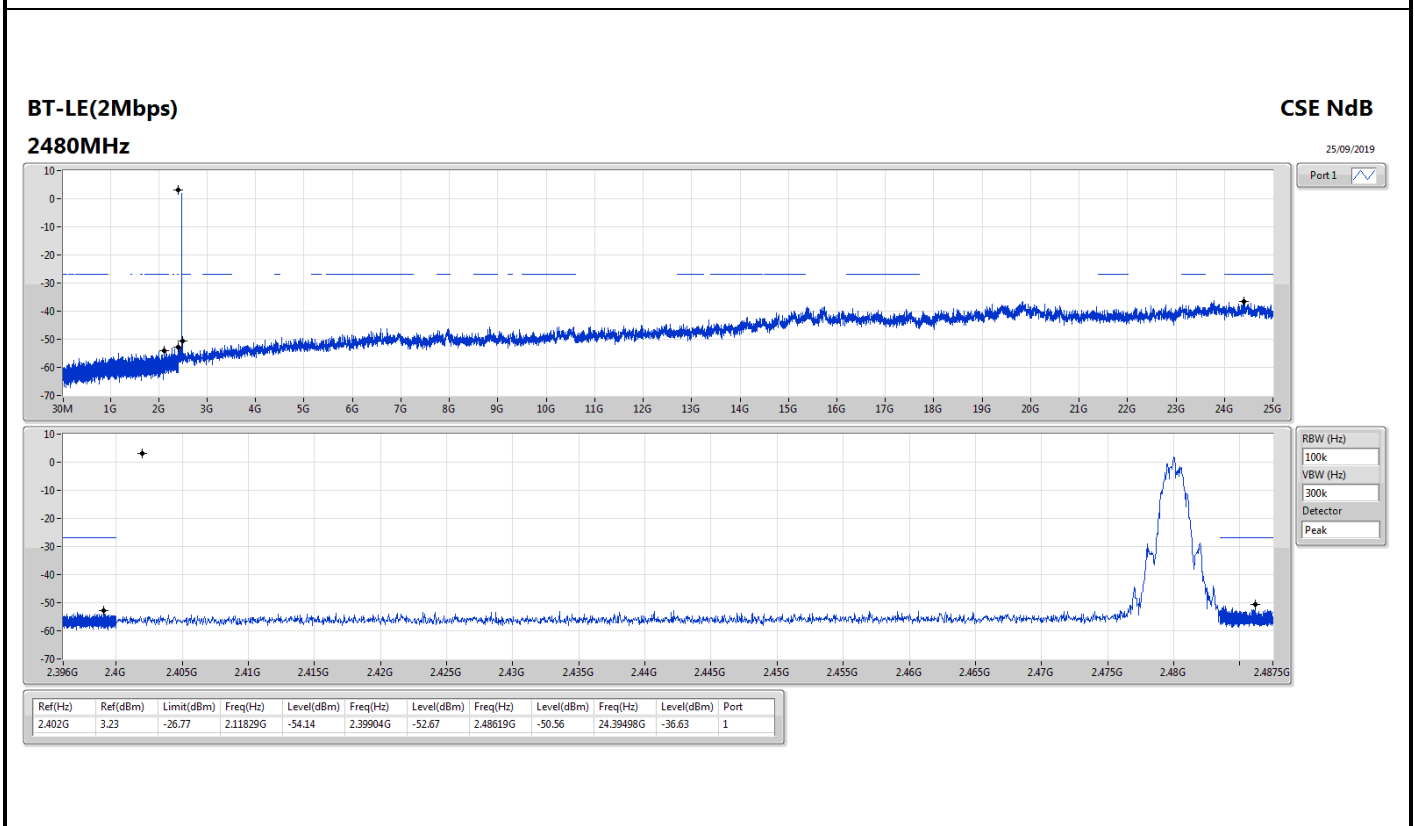
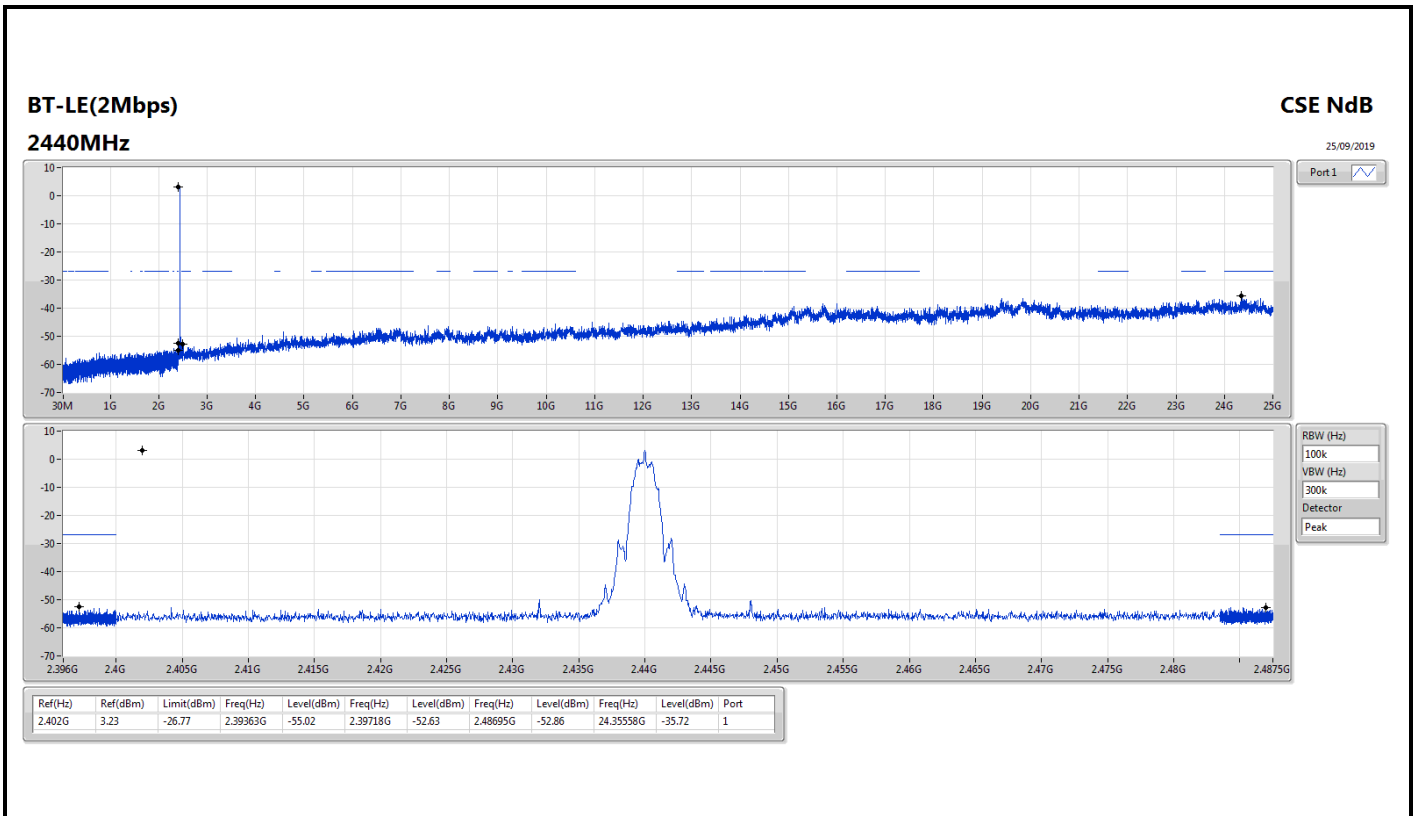



Summary

Mode	Result	Type	Freq (Hz)	Level (dBuV/m)	Limit (dBuV/m)	Margin (dB)	Dist (m)	Condition	Azimuth (°)	Height (m)	Comments
2.4-2.4835GHz	-	-	-	-	-	-	-	-	-	-	-
BT-LE(2Mbps)	Pass	PK	115.36M	36.73	43.50	-6.77	3	Horizontal	0	1.00	-



Result

Mode	Result	Type	Freq (Hz)	Level (dBuV/m)	Limit (dBuV/m)	Margin (dB)	Dist (m)	Condition	Azimuth (°)	Height (m)	Comments
BT-LE(2Mbps)	-	-	-	-	-	-	-	-	-	-	-
2440MHz	Pass	PK	169.68M	26.96	43.50	-16.54	3	Vertical	360	1.00	-
2440MHz	Pass	PK	206.54M	27.91	43.50	-15.59	3	Vertical	360	1.00	-
2440MHz	Pass	PK	348.16M	29.72	46.00	-16.28	3	Vertical	360	1.00	-
2440MHz	Pass	PK	456.8M	28.87	46.00	-17.13	3	Vertical	360	1.00	-
2440MHz	Pass	PK	503.36M	29.92	46.00	-16.08	3	Vertical	360	1.00	-
2440MHz	Pass	QP	49.4M	29.88	40.00	-10.12	3	Vertical	342	1.00	-
2440MHz	Pass	PK	49.4M	29.53	40.00	-10.47	3	Horizontal	0	1.00	-
2440MHz	Pass	PK	115.36M	36.73	43.50	-6.77	3	Horizontal	0	1.00	-
2440MHz	Pass	PK	194.9M	31.52	43.50	-11.98	3	Horizontal	0	1.00	-
2440MHz	Pass	PK	311.3M	36.91	46.00	-9.09	3	Horizontal	0	1.00	-
2440MHz	Pass	PK	353.98M	37.30	46.00	-8.70	3	Horizontal	0	1.00	-
2440MHz	Pass	PK	503.36M	30.27	46.00	-15.73	3	Horizontal	0	1.00	-
2440MHz	Pass	PK	35.82M	31.07	40.00	-8.93	3	Vertical	0	1.00	-
2440MHz	Pass	PK	62.98M	26.23	40.00	-13.77	3	Vertical	0	1.00	-
2440MHz	Pass	PK	159.98M	21.80	43.50	-21.70	3	Vertical	0	1.00	-
2440MHz	Pass	PK	524.7M	26.10	46.00	-19.90	3	Vertical	0	1.00	-
2440MHz	Pass	PK	658.56M	29.02	46.00	-16.98	3	Vertical	0	1.00	-
2440MHz	Pass	PK	967.02M	31.88	54.00	-22.12	3	Vertical	0	1.00	-
2440MHz	Pass	PK	39.7M	30.42	40.00	-9.58	3	Horizontal	360	1.00	-
2440MHz	Pass	PK	62.98M	27.35	40.00	-12.65	3	Horizontal	360	1.00	-
2440MHz	Pass	PK	348.16M	22.42	46.00	-23.58	3	Horizontal	360	1.00	-
2440MHz	Pass	PK	643.04M	28.28	46.00	-17.72	3	Horizontal	360	1.00	-
2440MHz	Pass	PK	771.08M	28.78	46.00	-17.22	3	Horizontal	360	1.00	-
2440MHz	Pass	PK	918.52M	30.93	46.00	-15.07	3	Horizontal	360	1.00	-

BT-LE(2Mbps)

27/09/2019

2440MHz_USB

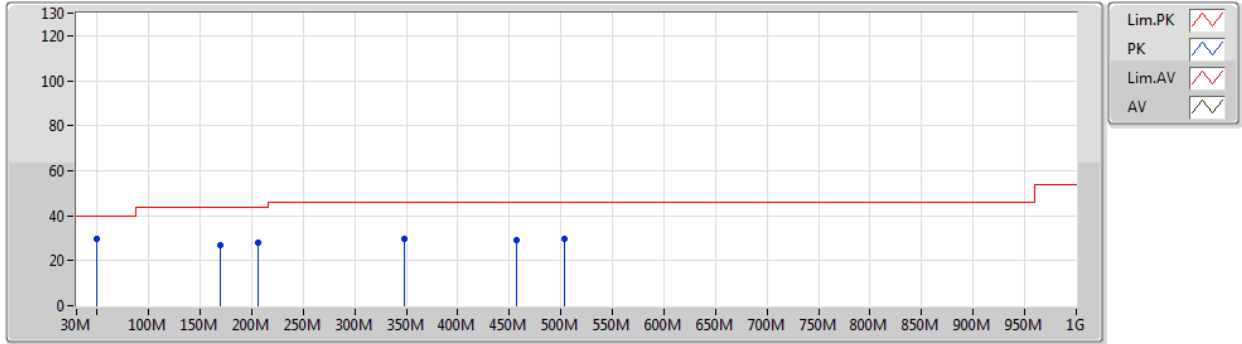

Type	Freq (Hz)	Level (dBuV/m)	Limit (dBuV/m)	Margin (dB)	Factor (dB)	Dist (m)	Condition	Azimuth (°)	Height (m)	Comment	Raw (dBuV)	AF (dB)	CL (dB)	PA (dB)
PK	169.68M	26.96	43.50	-16.54	-10.35	3	Vertical	360	1.00	-	37.31	14.72	2.02	27.09
PK	206.54M	27.91	43.50	-15.59	-10.26	3	Vertical	360	1.00	-	38.17	14.40	2.24	26.90
PK	348.16M	29.72	46.00	-16.28	-4.69	3	Vertical	360	1.00	-	34.41	19.32	2.96	26.97
PK	456.8M	28.87	46.00	-17.13	-2.20	3	Vertical	360	1.00	-	31.07	22.09	3.42	27.71
PK	503.36M	29.92	46.00	-16.08	-1.54	3	Vertical	360	1.00	-	31.46	22.68	3.62	27.84
QP	49.4M	29.88	40.00	-10.12	-13.23	3	Vertical	342	1.00	-	43.11	13.25	1.04	27.52

BT-LE(2Mbps)

27/09/2019

2440MHz_USB

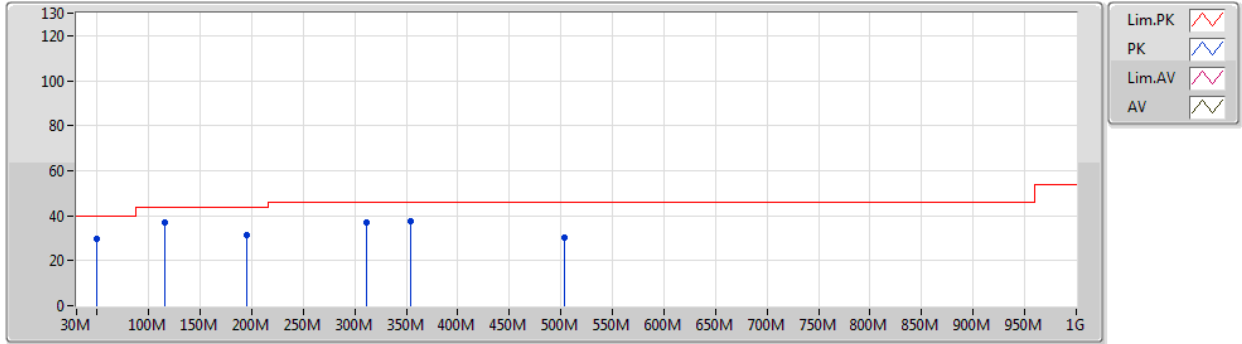

Type	Freq (Hz)	Level (dBuV/m)	Limit (dBuV/m)	Margin (dB)	Factor (dB)	Dist (m)	Condition	Azimuth (°)	Height (m)	Comment	Raw (dBuV)	AF (dB)	CL (dB)	PA (dB)
PK	49.4M	29.53	40.00	-10.47	-13.23	3	Horizontal	0	1.00	-	42.76	13.25	1.04	27.52
PK	115.36M	36.73	43.50	-6.77	-8.60	3	Horizontal	0	1.00	-	45.33	17.08	1.64	27.32
PK	194.9M	31.52	43.50	-11.98	-10.51	3	Horizontal	0	1.00	-	42.03	14.27	2.18	26.96
PK	311.3M	36.91	46.00	-9.09	-5.45	3	Horizontal	0	1.00	-	42.36	18.52	2.80	26.77
PK	353.98M	37.30	46.00	-8.70	-4.43	3	Horizontal	0	1.00	-	41.73	19.58	2.99	27.00
PK	503.36M	30.27	46.00	-15.73	-1.54	3	Horizontal	0	1.00	-	31.81	22.68	3.62	27.84

BT-LE(2Mbps)

15/10/2019

2440MHz_Adapter

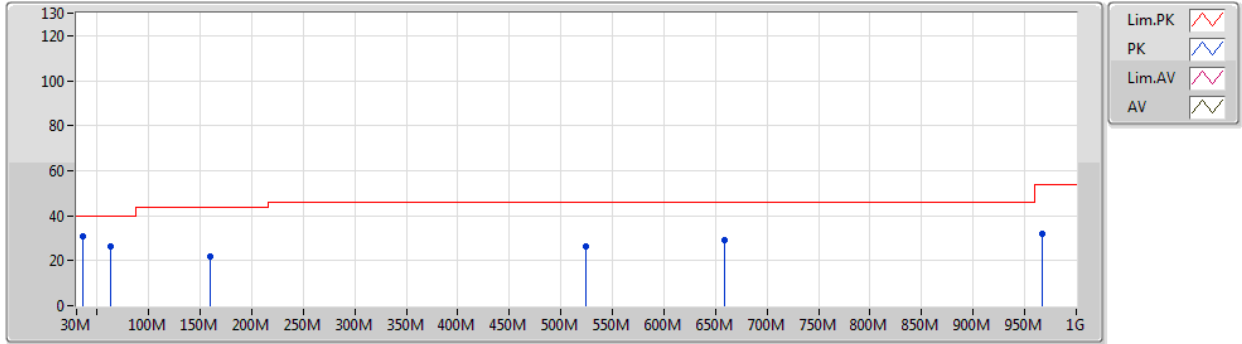

Type	Freq (Hz)	Level (dBuV/m)	Limit (dBuV/m)	Margin (dB)	Factor (dB)	Dist (m)	Condition	Azimuth (°)	Height (m)	Comment	Raw (dBuV)	AF (dB)	CL (dB)	PA (dB)
PK	35.82M	31.07	40.00	-8.93	-6.96	3	Vertical	0	1.00	-	38.03	19.71	0.89	27.56
PK	62.98M	26.23	40.00	-13.77	-15.02	3	Vertical	0	1.00	-	41.25	11.27	1.19	27.48
PK	159.98M	21.80	43.50	-21.70	-10.16	3	Vertical	0	1.00	-	31.96	15.03	1.95	27.14
PK	524.7M	26.10	46.00	-19.90	-1.41	3	Vertical	0	1.00	-	27.51	22.83	3.69	27.93
PK	658.56M	29.02	46.00	-16.98	0.33	3	Vertical	0	1.00	-	28.69	24.22	4.21	28.10
PK	967.02M	31.88	54.00	-22.12	4.14	3	Vertical	0	1.00	-	27.74	26.18	5.31	27.35



BT-LE(2Mbps)

15/10/2019

2440MHz_Adapter

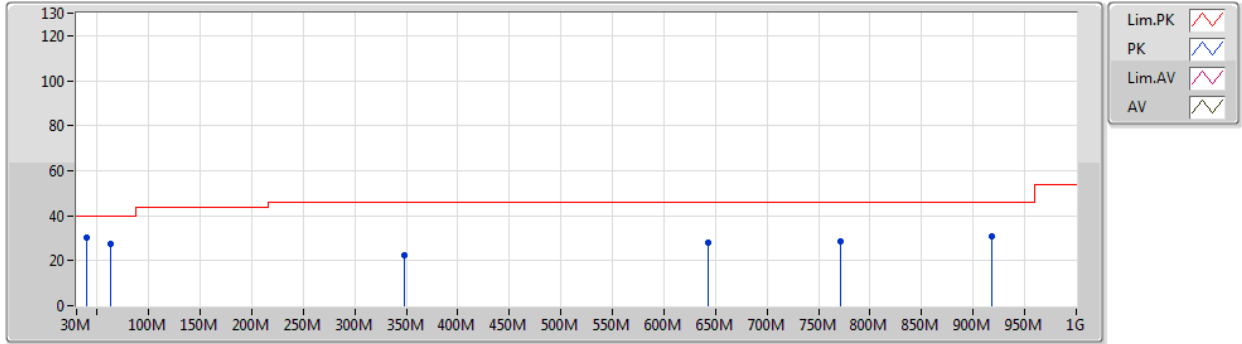

Type	Freq (Hz)	Level (dBuV/m)	Limit (dBuV/m)	Margin (dB)	Factor (dB)	Dist (m)	Condition	Azimuth (°)	Height (m)	Comment	Raw (dBuV)	AF (dB)	CL (dB)	PA (dB)
PK	39.7M	30.42	40.00	-9.58	-8.99	3	Horizontal	360	1.00	-	39.41	17.62	0.93	27.54
PK	62.98M	27.35	40.00	-12.65	-15.02	3	Horizontal	360	1.00	-	42.37	11.27	1.19	27.48
PK	348.16M	22.42	46.00	-23.58	-4.69	3	Horizontal	360	1.00	-	27.11	19.32	2.96	26.97
PK	643.04M	28.28	46.00	-17.72	0.31	3	Horizontal	360	1.00	-	27.97	24.25	4.17	28.11
PK	771.08M	28.78	46.00	-17.22	1.69	3	Horizontal	360	1.00	-	27.09	25.05	4.61	27.97
PK	918.52M	30.93	46.00	-15.07	3.42	3	Horizontal	360	1.00	-	27.51	25.79	5.09	27.46



Summary

Mode	Result	Type	Freq (Hz)	Level (dBuV/m)	Limit (dBuV/m)	Margin (dB)	Dist (m)	Condition	Azimuth (°)	Height (m)	Comments
2.4-2.4835GHz	-	-	-	-	-	-	-	-	-	-	-
BT-LE(1Mbps)	Pass	AV	2.3792G	50.93	54.00	-3.07	3	Horizontal	267	1.96	-
BT-LE(2Mbps)	Pass	AV	2.3682G	50.23	54.00	-3.77	3	Vertical	208	1.51	-



Result

Mode	Result	Type	Freq (Hz)	Level (dBuV/m)	Limit (dBuV/m)	Margin (dB)	Dist (m)	Condition	Azimuth (°)	Height (m)	Comments
BT-LE(1Mbps)	-	-	-	-	-	-	-	-	-	-	-
2402MHz	Pass	AV	2.3626G	48.33	54.00	-5.67	3	Vertical	208	1.50	-
2402MHz	Pass	AV	2.402G	88.15	Inf	-Inf	3	Vertical	208	1.50	-
2402MHz	Pass	PK	2.3554G	60.49	74.00	-13.51	3	Vertical	208	1.50	-
2402MHz	Pass	PK	2.4018G	89.23	Inf	-Inf	3	Vertical	208	1.50	-
2402MHz	Pass	AV	2.3736G	48.26	54.00	-5.74	3	Horizontal	288	1.54	-
2402MHz	Pass	AV	2.402G	88.30	Inf	-Inf	3	Horizontal	288	1.54	-
2402MHz	Pass	PK	2.3846G	60.24	74.00	-13.76	3	Horizontal	288	1.54	-
2402MHz	Pass	PK	2.4018G	89.33	Inf	-Inf	3	Horizontal	288	1.54	-
2402MHz	Pass	AV	4.80398G	45.63	54.00	-8.37	3	Vertical	286	2.06	-
2402MHz	Pass	PK	4.80454G	53.43	74.00	-20.57	3	Vertical	286	2.06	-
2402MHz	Pass	AV	4.80402G	47.25	54.00	-6.75	3	Horizontal	287	2.02	-
2402MHz	Pass	PK	4.80342G	54.61	74.00	-19.39	3	Horizontal	287	2.02	-
2440MHz	Pass	AV	2.3648G	50.69	54.00	-3.31	3	Vertical	219	1.00	-
2440MHz	Pass	AV	2.44G	89.99	Inf	-Inf	3	Vertical	219	1.00	-
2440MHz	Pass	AV	2.4872G	50.87	54.00	-3.13	3	Vertical	219	1.00	-
2440MHz	Pass	PK	2.356G	60.44	74.00	-13.56	3	Vertical	219	1.00	-
2440MHz	Pass	PK	2.4396G	90.69	Inf	-Inf	3	Vertical	219	1.00	-
2440MHz	Pass	PK	2.4892G	60.50	74.00	-13.50	3	Vertical	219	1.00	-
2440MHz	Pass	AV	2.3792G	50.93	54.00	-3.07	3	Horizontal	267	1.96	-
2440MHz	Pass	AV	2.44G	91.69	Inf	-Inf	3	Horizontal	267	1.96	-
2440MHz	Pass	AV	2.4835G	50.63	54.00	-3.37	3	Horizontal	267	1.96	-
2440MHz	Pass	PK	2.3548G	60.01	74.00	-13.99	3	Horizontal	267	1.96	-
2440MHz	Pass	PK	2.44G	92.31	Inf	-Inf	3	Horizontal	267	1.96	-
2440MHz	Pass	PK	2.4924G	60.04	74.00	-13.96	3	Horizontal	267	1.96	-
2440MHz	Pass	AV	4.88008G	49.48	54.00	-4.52	3	Vertical	287	1.99	-
2440MHz	Pass	AV	7.31928G	46.08	54.00	-7.92	3	Vertical	268	2.42	-
2440MHz	Pass	PK	4.88052G	56.15	74.00	-17.85	3	Vertical	287	1.99	-
2440MHz	Pass	PK	7.31939G	57.14	74.00	-16.86	3	Vertical	268	2.42	-
2440MHz	Pass	AV	4.88006G	49.01	54.00	-4.99	3	Horizontal	273	1.50	-
2440MHz	Pass	AV	7.32068G	44.10	54.00	-9.90	3	Horizontal	323	1.50	-
2440MHz	Pass	PK	4.87951G	56.28	74.00	-17.72	3	Horizontal	273	1.50	-
2440MHz	Pass	PK	7.31901G	55.80	74.00	-18.20	3	Horizontal	323	1.50	-
2480MHz	Pass	AV	2.48G	91.44	Inf	-Inf	3	Vertical	207	1.16	-
2480MHz	Pass	AV	2.4884G	50.73	54.00	-3.27	3	Vertical	207	1.16	-
2480MHz	Pass	PK	2.4802G	92.22	Inf	-Inf	3	Vertical	207	1.16	-
2480MHz	Pass	PK	2.499G	60.62	74.00	-13.38	3	Vertical	207	1.16	-
2480MHz	Pass	AV	2.48G	93.46	Inf	-Inf	3	Horizontal	273	1.68	-
2480MHz	Pass	AV	2.486G	50.90	54.00	-3.10	3	Horizontal	273	1.68	-
2480MHz	Pass	PK	2.4802G	94.10	Inf	-Inf	3	Horizontal	273	1.68	-
2480MHz	Pass	PK	2.4972G	60.78	74.00	-13.22	3	Horizontal	273	1.68	-
2480MHz	Pass	AV	4.95999G	49.58	54.00	-4.42	3	Vertical	278	2.75	-
2480MHz	Pass	AV	7.43934G	48.01	54.00	-5.99	3	Vertical	264	2.71	-
2480MHz	Pass	PK	4.95954G	56.44	74.00	-17.56	3	Vertical	278	2.75	-
2480MHz	Pass	PK	7.44039G	57.77	74.00	-16.23	3	Vertical	264	2.71	-
2480MHz	Pass	AV	4.96008G	45.82	54.00	-8.18	3	Horizontal	273	1.50	-
2480MHz	Pass	AV	7.43926G	48.74	54.00	-5.26	3	Horizontal	231	1.92	-
2480MHz	Pass	PK	4.95946G	54.06	74.00	-19.94	3	Horizontal	273	1.50	-



Mode	Result	Type	Freq (Hz)	Level (dBuV/m)	Limit (dBuV/m)	Margin (dB)	Dist (m)	Condition	Azimuth (°)	Height (m)	Comments
2480MHz	Pass	PK	7.43918G	58.41	74.00	-15.59	3	Horizontal	231	1.92	-
BT-LE(2Mbps)	-	-	-	-	-	-	-	-	-	-	-
2402MHz	Pass	AV	2.3682G	50.23	54.00	-3.77	3	Vertical	208	1.51	-
2402MHz	Pass	AV	2.402G	87.57	Inf	-Inf	3	Vertical	208	1.51	-
2402MHz	Pass	PK	2.3818G	61.22	74.00	-12.78	3	Vertical	208	1.51	-
2402MHz	Pass	PK	2.4014G	89.94	Inf	-Inf	3	Vertical	208	1.51	-
2402MHz	Pass	AV	2.3718G	50.07	54.00	-3.93	3	Horizontal	286	1.55	-
2402MHz	Pass	AV	2.4022G	88.13	Inf	-Inf	3	Horizontal	286	1.55	-
2402MHz	Pass	PK	2.3782G	60.20	74.00	-13.80	3	Horizontal	286	1.55	-
2402MHz	Pass	PK	2.4014G	90.59	Inf	-Inf	3	Horizontal	286	1.55	-
2402MHz	Pass	AV	4.80294G	44.97	54.00	-9.03	3	Vertical	291	2.07	-
2402MHz	Pass	PK	4.80301G	53.23	74.00	-20.77	3	Vertical	291	2.07	-
2402MHz	Pass	AV	4.80307G	45.81	54.00	-8.19	3	Horizontal	271	3.00	-
2402MHz	Pass	PK	4.80402G	53.58	74.00	-20.42	3	Horizontal	271	3.00	-
2440MHz	Pass	AV	2.3476G	50.04	54.00	-3.96	3	Vertical	214	1.00	-
2440MHz	Pass	AV	2.44G	88.52	Inf	-Inf	3	Vertical	214	1.00	-
2440MHz	Pass	AV	2.492G	50.12	54.00	-3.88	3	Vertical	214	1.00	-
2440MHz	Pass	PK	2.3592G	59.62	74.00	-14.38	3	Vertical	214	1.00	-
2440MHz	Pass	PK	2.4404G	90.93	Inf	-Inf	3	Vertical	214	1.00	-
2440MHz	Pass	PK	2.4988G	59.28	74.00	-14.72	3	Vertical	214	1.00	-
2440MHz	Pass	AV	2.3484G	50.19	54.00	-3.81	3	Horizontal	214	1.00	-
2440MHz	Pass	AV	2.44G	88.77	Inf	-Inf	3	Horizontal	214	1.00	-
2440MHz	Pass	AV	2.4952G	49.82	54.00	-4.18	3	Horizontal	214	1.00	-
2440MHz	Pass	PK	2.3736G	60.61	74.00	-13.39	3	Horizontal	214	1.00	-
2440MHz	Pass	PK	2.4404G	91.19	Inf	-Inf	3	Horizontal	214	1.00	-
2440MHz	Pass	PK	2.494G	60.15	74.00	-13.85	3	Horizontal	214	1.00	-
2440MHz	Pass	AV	4.87901G	48.90	54.00	-5.10	3	Vertical	287	2.01	-
2440MHz	Pass	AV	7.31825G	46.52	54.00	-7.48	3	Vertical	264	2.89	-
2440MHz	Pass	PK	4.88099G	56.31	74.00	-17.69	3	Vertical	287	2.01	-
2440MHz	Pass	PK	7.31988G	56.77	74.00	-17.23	3	Vertical	264	2.89	-
2440MHz	Pass	AV	4.87902G	48.11	54.00	-5.89	3	Horizontal	274	1.53	-
2440MHz	Pass	AV	7.3214G	44.95	54.00	-9.05	3	Horizontal	213	2.46	-
2440MHz	Pass	PK	4.87887G	55.01	74.00	-18.99	3	Horizontal	274	1.53	-
2440MHz	Pass	PK	7.31997G	55.47	74.00	-18.53	3	Horizontal	213	2.46	-
2480MHz	Pass	AV	2.48G	89.98	Inf	-Inf	3	Vertical	206	1.15	-
2480MHz	Pass	AV	2.4922G	49.98	54.00	-4.02	3	Vertical	206	1.15	-
2480MHz	Pass	PK	2.4804G	92.41	Inf	-Inf	3	Vertical	206	1.15	-
2480MHz	Pass	PK	2.4952G	59.87	74.00	-14.13	3	Vertical	206	1.15	-
2480MHz	Pass	AV	2.48G	91.76	Inf	-Inf	3	Horizontal	271	1.67	-
2480MHz	Pass	AV	2.4994G	49.92	54.00	-4.08	3	Horizontal	271	1.67	-
2480MHz	Pass	PK	2.4806G	94.14	Inf	-Inf	3	Horizontal	271	1.67	-
2480MHz	Pass	PK	2.4942G	60.73	74.00	-13.27	3	Horizontal	271	1.67	-
2480MHz	Pass	AV	4.95901G	48.78	54.00	-5.22	3	Vertical	289	1.99	-
2480MHz	Pass	AV	7.43867G	47.68	54.00	-6.32	3	Vertical	261	1.99	-
2480MHz	Pass	PK	4.959G	55.99	74.00	-18.01	3	Vertical	289	1.99	-
2480MHz	Pass	PK	7.43847G	57.08	74.00	-16.92	3	Vertical	261	1.99	-
2480MHz	Pass	AV	4.95914G	46.54	54.00	-7.46	3	Horizontal	274	1.54	-
2480MHz	Pass	AV	7.43877G	47.70	54.00	-6.30	3	Horizontal	214	1.98	-
2480MHz	Pass	PK	4.96003G	54.06	74.00	-19.94	3	Horizontal	274	1.54	-



RSE TX above 1GHz

Appendix F.2





Mode	Result	Type	Freq (Hz)	Level (dBuV/m)	Limit (dBuV/m)	Margin (dB)	Dist (m)	Condition	Azimuth (°)	Height (m)	Comments
2480MHz	Pass	PK	7.44169G	57.48	74.00	-16.52	3	Horizontal	214	1.98	-

BT-LE(1Mbps)

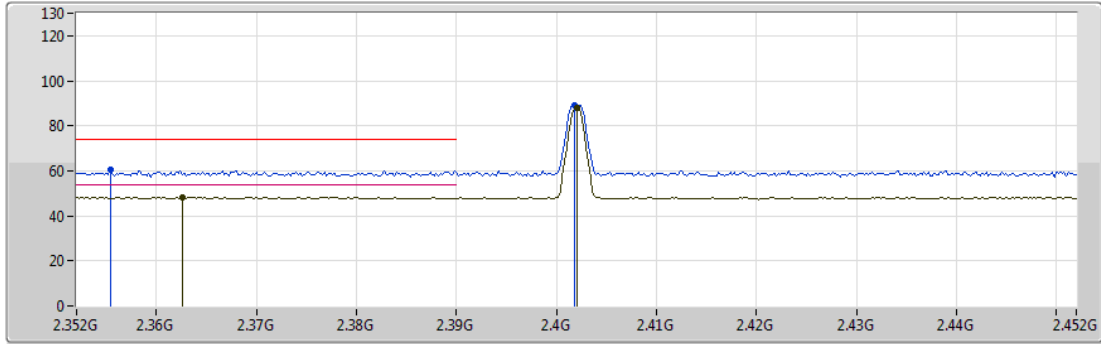
26/09/2019

2402MHz_TX



Lim.PK 
 PK 
 Lim.AV 
 AV 

Type	Freq (Hz)	Level (dBuV/m)	Limit (dBuV/m)	Margin (dB)	Factor (dB)	Dist (m)	Condition	Azimuth (°)	Height (m)	Comment	Raw (dBuV)	AF (dB)	CL (dB)	PA (dB)
AV	2.3626G	48.33	54.00	-5.67	35.09	3	Vertical	208	1.50	-	13.24	27.75	7.34	-
AV	2.402G	88.15	Inf	-Inf	34.93	3	Vertical	208	1.50	-	53.22	27.60	7.33	-
PK	2.3554G	60.49	74.00	-13.51	35.12	3	Vertical	208	1.50	-	25.37	27.78	7.34	-
PK	2.4018G	89.23	Inf	-Inf	34.93	3	Vertical	208	1.50	-	54.30	27.60	7.33	-

BT-LE(1Mbps)

26/09/2019

2402MHz_TX

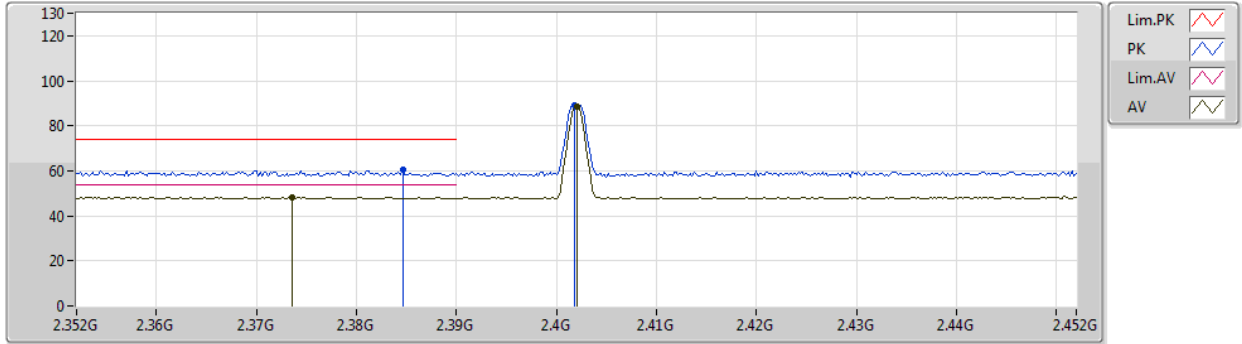

Type	Freq (Hz)	Level (dBuV/m)	Limit (dBuV/m)	Margin (dB)	Factor (dB)	Dist (m)	Condition	Azimuth (°)	Height (m)	Comment	Raw (dBuV)	AF (dB)	CL (dB)	PA (dB)
AV	2.3736G	48.26	54.00	-5.74	35.05	3	Horizontal	288	1.54	-	13.21	27.71	7.34	-
AV	2.402G	88.30	Inf	-Inf	34.93	3	Horizontal	288	1.54	-	53.37	27.60	7.33	-
PK	2.3846G	60.24	74.00	-13.76	34.99	3	Horizontal	288	1.54	-	25.25	27.66	7.33	-
PK	2.4018G	89.33	Inf	-Inf	34.93	3	Horizontal	288	1.54	-	54.40	27.60	7.33	-



BT-LE(1Mbps)

26/09/2019

2402MHz_TX

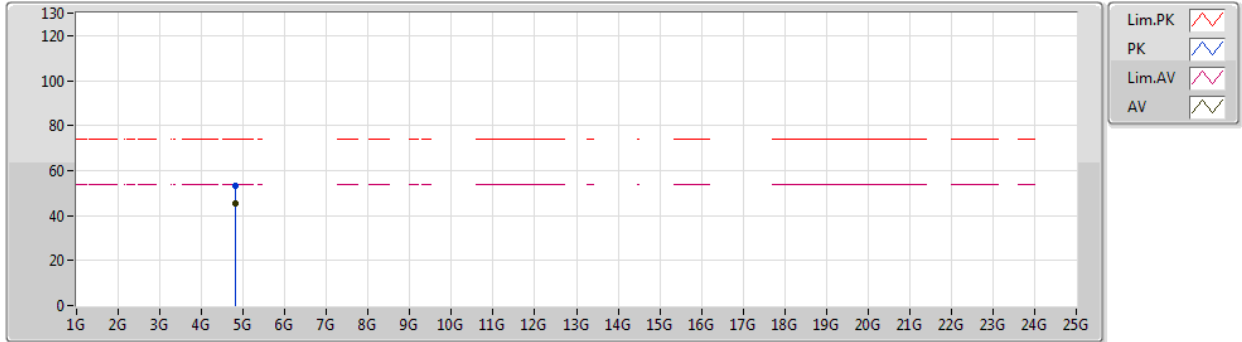

Type	Freq (Hz)	Level (dBuV/m)	Limit (dBuV/m)	Margin (dB)	Factor (dB)	Dist (m)	Condition	Azimuth (°)	Height (m)	Comment	Raw (dBuV)	AF (dB)	CL (dB)	PA (dB)
AV	4.80398G	45.63	54.00	-8.37	6.72	3	Vertical	286	2.06	-	38.91	31.10	9.92	34.30
PK	4.80454G	53.43	74.00	-20.57	6.72	3	Vertical	286	2.06	-	46.71	31.10	9.92	34.30



BT-LE(1Mbps)

26/09/2019

2402MHz_TX

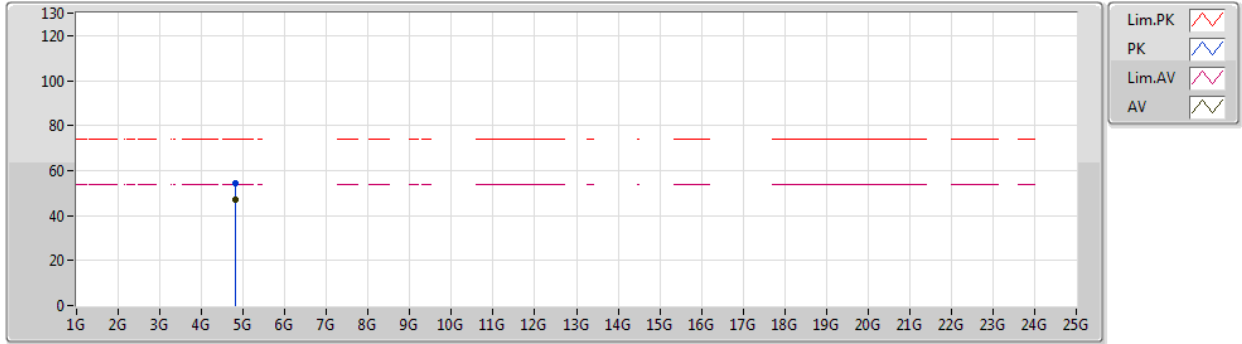

Type	Freq (Hz)	Level (dBuV/m)	Limit (dBuV/m)	Margin (dB)	Factor (dB)	Dist (m)	Condition	Azimuth (°)	Height (m)	Comment	Raw (dBuV)	AF (dB)	CL (dB)	PA (dB)
AV	4.80402G	47.25	54.00	-6.75	6.72	3	Horizontal	287	2.02	-	40.53	31.10	9.92	34.30
PK	4.80342G	54.61	74.00	-19.39	6.72	3	Horizontal	287	2.02	-	47.89	31.10	9.92	34.30

BT-LE(1Mbps)

26/09/2019

2440MHz_TX

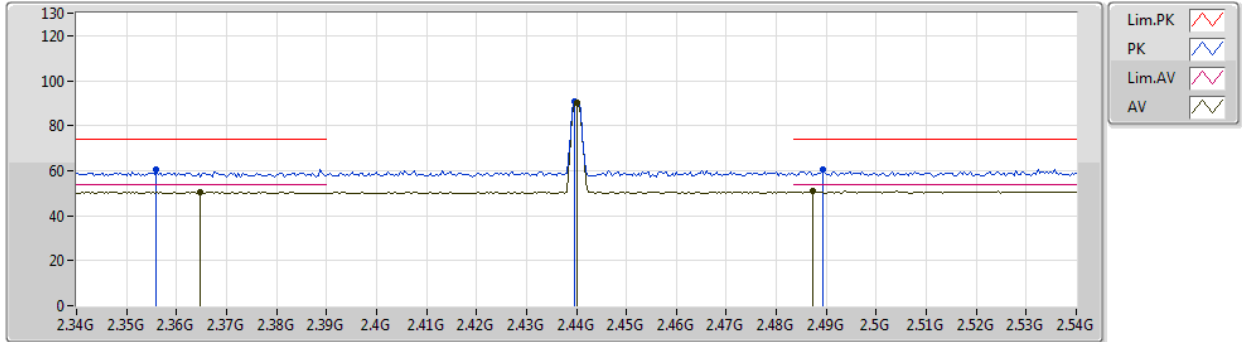

Type	Freq (Hz)	Level (dBuV/m)	Limit (dBuV/m)	Margin (dB)	Factor (dB)	Dist (m)	Condition	Azimuth (°)	Height (m)	Comment	Raw (dBuV)	AF (dB)	CL (dB)	PA (dB)
AV	2.3648G	50.69	54.00	-3.31	35.08	3	Vertical	219	1.00	-	15.61	27.74	7.34	-
AV	2.44G	89.99	Inf	-Inf	34.91	3	Vertical	219	1.00	-	55.08	27.56	7.35	-
AV	2.4872G	50.87	54.00	-3.13	34.88	3	Vertical	219	1.00	-	15.99	27.51	7.37	-
PK	2.356G	60.44	74.00	-13.56	35.12	3	Vertical	219	1.00	-	25.32	27.78	7.34	-
PK	2.4396G	90.69	Inf	-Inf	34.91	3	Vertical	219	1.00	-	55.78	27.56	7.35	-
PK	2.4892G	60.50	74.00	-13.50	34.88	3	Vertical	219	1.00	-	25.62	27.51	7.37	-

BT-LE(1Mbps)

26/09/2019

2440MHz_TX

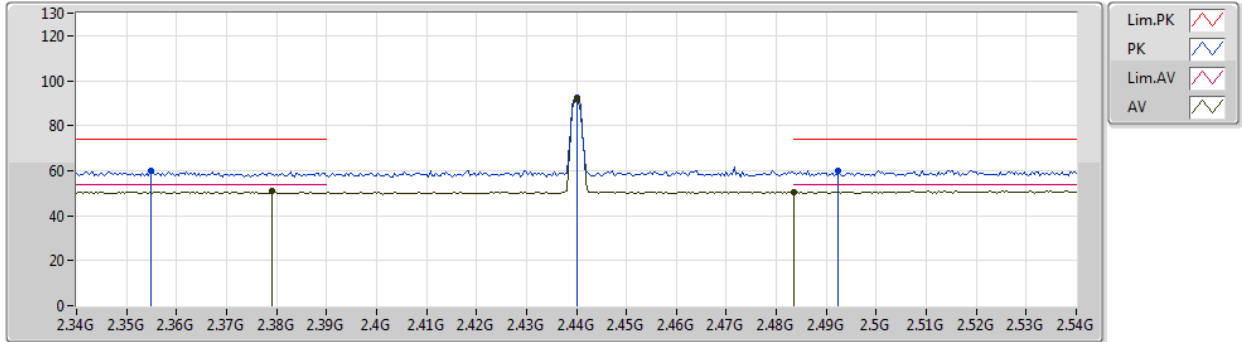

Type	Freq (Hz)	Level (dBuV/m)	Limit (dBuV/m)	Margin (dB)	Factor (dB)	Dist (m)	Condition	Azimuth (°)	Height (m)	Comment	Raw (dBuV)	AF (dB)	CL (dB)	PA (dB)
AV	2.3792G	50.93	54.00	-3.07	35.01	3	Horizontal	267	1.96	-	15.92	27.68	7.33	-
AV	2.44G	91.69	Inf	-Inf	34.91	3	Horizontal	267	1.96	-	56.78	27.56	7.35	-
AV	2.4835G	50.63	54.00	-3.37	34.89	3	Horizontal	267	1.96	-	15.74	27.52	7.37	-
PK	2.3548G	60.01	74.00	-13.99	35.12	3	Horizontal	267	1.96	-	24.89	27.78	7.34	-
PK	2.44G	92.31	Inf	-Inf	34.91	3	Horizontal	267	1.96	-	57.40	27.56	7.35	-
PK	2.4924G	60.04	74.00	-13.96	34.88	3	Horizontal	267	1.96	-	25.16	27.51	7.37	-

BT-LE(1Mbps)

26/09/2019

2440MHz_TX

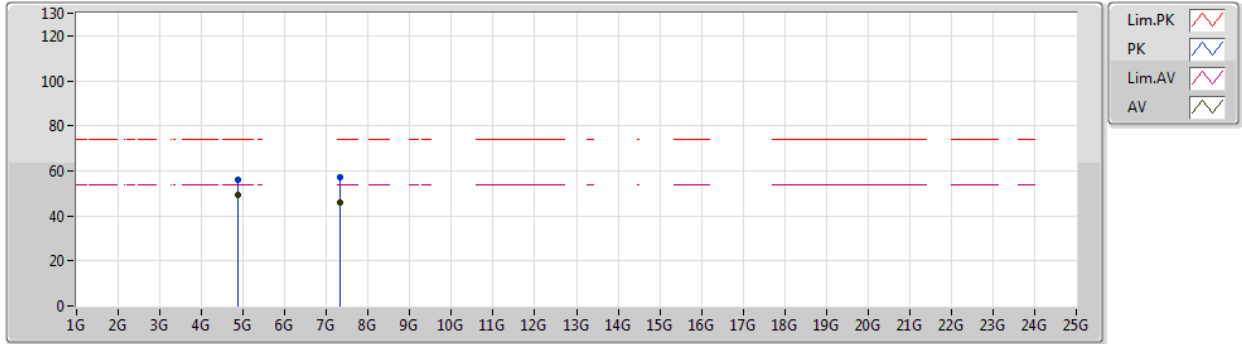

Type	Freq (Hz)	Level (dBuV/m)	Limit (dBuV/m)	Margin (dB)	Factor (dB)	Dist (m)	Condition	Azimuth (°)	Height (m)	Comment	Raw (dBuV)	AF (dB)	CL (dB)	PA (dB)
AV	4.88008G	49.48	54.00	-4.52	6.80	3	Vertical	287	1.99	-	42.68	31.10	9.98	34.28
AV	7.31928G	46.08	54.00	-7.92	12.99	3	Vertical	268	2.42	-	33.09	36.28	11.30	34.59
PK	4.88052G	56.15	74.00	-17.85	6.80	3	Vertical	287	1.99	-	49.35	31.10	9.98	34.28
PK	7.31939G	57.14	74.00	-16.86	12.99	3	Vertical	268	2.42	-	44.15	36.28	11.30	34.59

BT-LE(1Mbps)

26/09/2019

2440MHz_TX

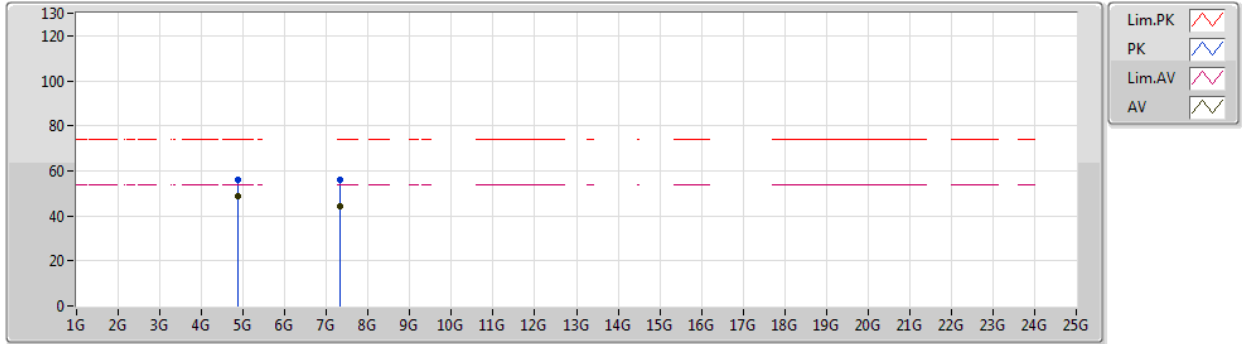

Type	Freq (Hz)	Level (dBuV/m)	Limit (dBuV/m)	Margin (dB)	Factor (dB)	Dist (m)	Condition	Azimuth (°)	Height (m)	Comment	Raw (dBuV)	AF (dB)	CL (dB)	PA (dB)
AV	4.88006G	49.01	54.00	-4.99	6.80	3	Horizontal	273	1.50	-	42.21	31.10	9.98	34.28
AV	7.32068G	44.10	54.00	-9.90	12.99	3	Horizontal	323	1.50	-	31.11	36.28	11.30	34.59
PK	4.87951G	56.28	74.00	-17.72	6.80	3	Horizontal	273	1.50	-	49.48	31.10	9.98	34.28
PK	7.31901G	55.80	74.00	-18.20	12.99	3	Horizontal	323	1.50	-	42.81	36.28	11.30	34.59

BT-LE(1Mbps)

26/09/2019

2480MHz_TX

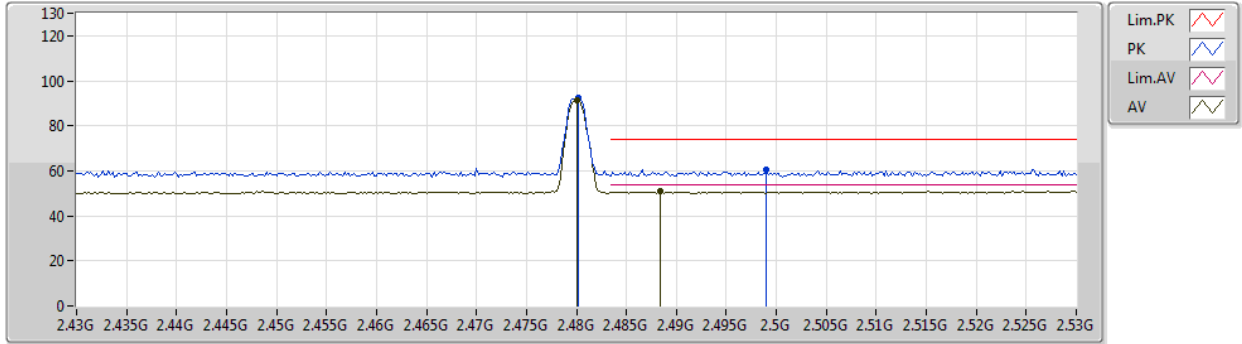

Type	Freq (Hz)	Level (dBuV/m)	Limit (dBuV/m)	Margin (dB)	Factor (dB)	Dist (m)	Condition	Azimuth (°)	Height (m)	Comment	Raw (dBuV)	AF (dB)	CL (dB)	PA (dB)
AV	2.48G	91.44	Inf	-Inf	34.89	3	Vertical	207	1.16	-	56.55	27.52	7.37	-
AV	2.4884G	50.73	54.00	-3.27	34.88	3	Vertical	207	1.16	-	15.85	27.51	7.37	-
PK	2.4802G	92.22	Inf	-Inf	34.89	3	Vertical	207	1.16	-	57.33	27.52	7.37	-
PK	2.499G	60.62	74.00	-13.38	34.87	3	Vertical	207	1.16	-	25.75	27.50	7.37	-

BT-LE(1Mbps)

26/09/2019

2480MHz_TX

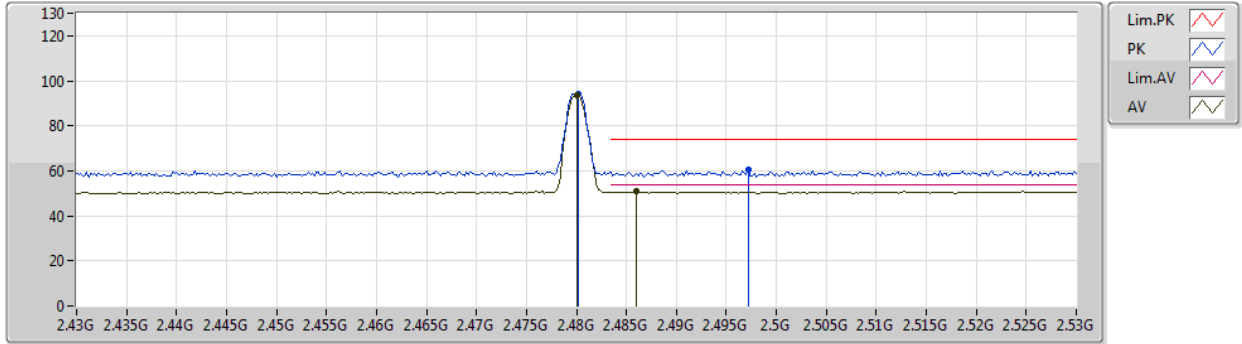

Type	Freq (Hz)	Level (dBuV/m)	Limit (dBuV/m)	Margin (dB)	Factor (dB)	Dist (m)	Condition	Azimuth (°)	Height (m)	Comment	Raw (dBuV)	AF (dB)	CL (dB)	PA (dB)
AV	2.48G	93.46	Inf	-Inf	34.89	3	Horizontal	273	1.68	-	58.57	27.52	7.37	-
AV	2.486G	50.90	54.00	-3.10	34.88	3	Horizontal	273	1.68	-	16.02	27.51	7.37	-
PK	2.4802G	94.10	Inf	-Inf	34.89	3	Horizontal	273	1.68	-	59.21	27.52	7.37	-
PK	2.4972G	60.78	74.00	-13.22	34.87	3	Horizontal	273	1.68	-	25.91	27.50	7.37	-

BT-LE(1Mbps)

26/09/2019

2480MHz_TX

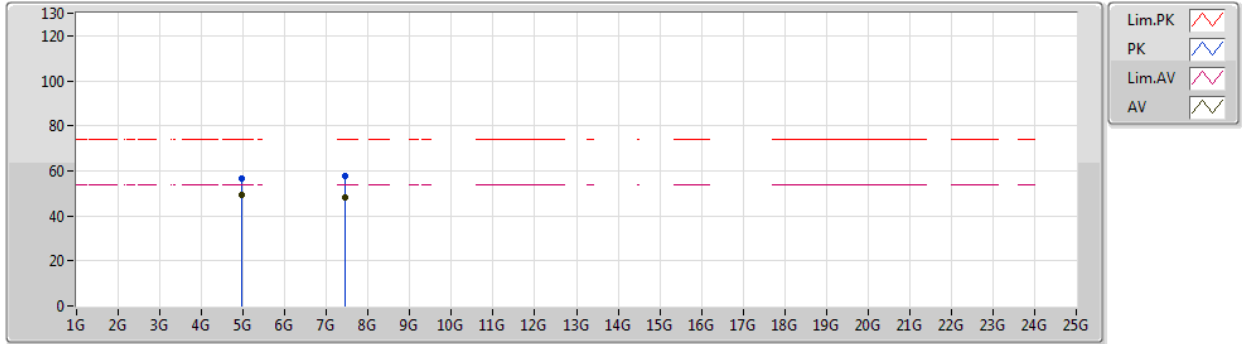

Type	Freq (Hz)	Level (dBuV/m)	Limit (dBuV/m)	Margin (dB)	Factor (dB)	Dist (m)	Condition	Azimuth (°)	Height (m)	Comment	Raw (dBuV)	AF (dB)	CL (dB)	PA (dB)
AV	4.95999G	49.58	54.00	-4.42	7.23	3	Vertical	278	2.75	-	42.35	31.34	10.05	34.16
AV	7.43934G	48.01	54.00	-5.99	13.10	3	Vertical	264	2.71	-	34.91	36.32	11.38	34.60
PK	4.95954G	56.44	74.00	-17.56	7.23	3	Vertical	278	2.75	-	49.21	31.34	10.05	34.16
PK	7.44039G	57.77	74.00	-16.23	13.10	3	Vertical	264	2.71	-	44.67	36.32	11.38	34.60

BT-LE(1Mbps)

26/09/2019

2480MHz_TX

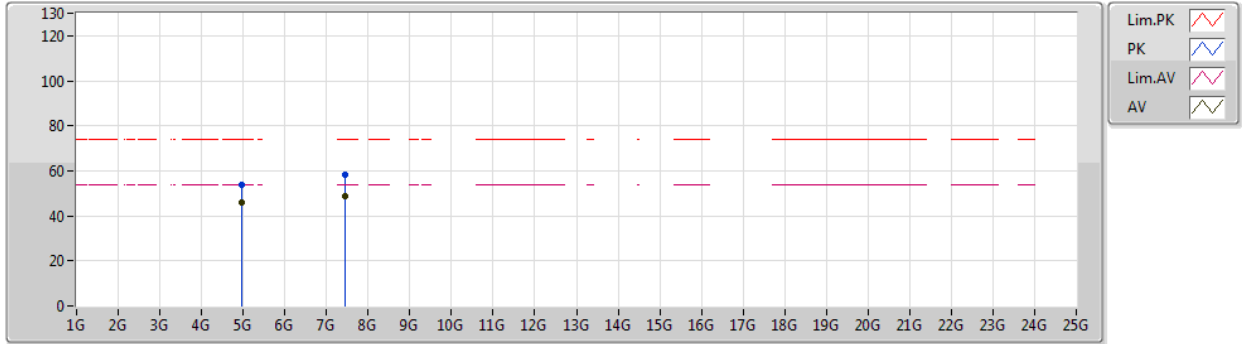





Type	Freq (Hz)	Level (dBuV/m)	Limit (dBuV/m)	Margin (dB)	Factor (dB)	Dist (m)	Condition	Azimuth (°)	Height (m)	Comment	Raw (dBuV)	AF (dB)	CL (dB)	PA (dB)
AV	4.96008G	45.82	54.00	-8.18	7.23	3	Horizontal	273	1.50	-	38.59	31.34	10.05	34.16
AV	7.43926G	48.74	54.00	-5.26	13.10	3	Horizontal	231	1.92	-	35.64	36.32	11.38	34.60
PK	4.95946G	54.06	74.00	-19.94	7.23	3	Horizontal	273	1.50	-	46.83	31.34	10.05	34.16
PK	7.43918G	58.41	74.00	-15.59	13.10	3	Horizontal	231	1.92	-	45.31	36.32	11.38	34.60

BT-LE(2Mbps)

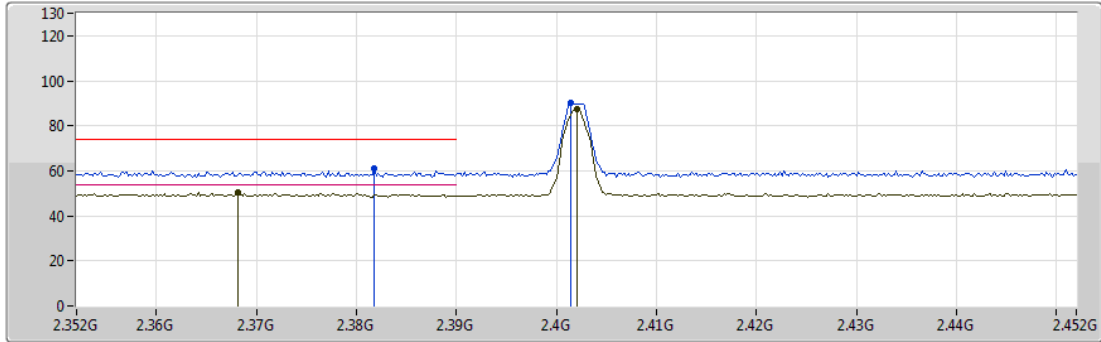
26/09/2019

2402MHz_TX



Lim.PK 
 PK 
 Lim.AV 
 AV 

Type	Freq (Hz)	Level (dBuV/m)	Limit (dBuV/m)	Margin (dB)	Factor (dB)	Dist (m)	Condition	Azimuth (°)	Height (m)	Comment	Raw (dBuV)	AF (dB)	CL (dB)	PA (dB)
AV	2.3682G	50.23	54.00	-3.77	35.07	3	Vertical	208	1.51	-	15.16	27.73	7.34	-
AV	2.402G	87.57	Inf	-Inf	34.93	3	Vertical	208	1.51	-	52.64	27.60	7.33	-
PK	2.3818G	61.22	74.00	-12.78	35.00	3	Vertical	208	1.51	-	26.22	27.67	7.33	-
PK	2.4014G	89.94	Inf	-Inf	34.93	3	Vertical	208	1.51	-	55.01	27.60	7.33	-



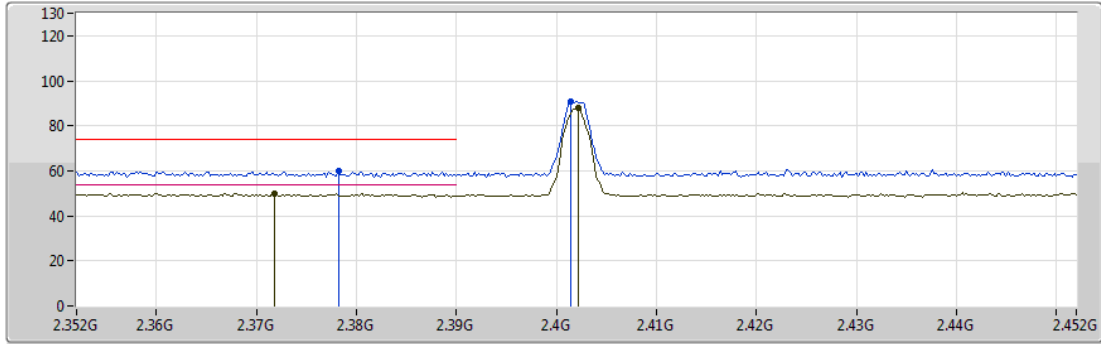

BT-LE(2Mbps)

26/09/2019

2402MHz_TX



Legend for the spectrum plot:

- Lim.PK 
- PK 
- Lim.AV 
- AV 

Type	Freq (Hz)	Level (dBuV/m)	Limit (dBuV/m)	Margin (dB)	Factor (dB)	Dist (m)	Condition	Azimuth (°)	Height (m)	Comment	Raw (dBuV)	AF (dB)	CL (dB)	PA (dB)
AV	2.3718G	50.07	54.00	-3.93	35.05	3	Horizontal	286	1.55	-	15.02	27.71	7.34	-
AV	2.4022G	88.13	Inf	-Inf	34.93	3	Horizontal	286	1.55	-	53.20	27.60	7.33	-
PK	2.3782G	60.20	74.00	-13.80	35.02	3	Horizontal	286	1.55	-	25.18	27.69	7.33	-
PK	2.4014G	90.59	Inf	-Inf	34.93	3	Horizontal	286	1.55	-	55.66	27.60	7.33	-



BT-LE(2Mbps)

26/09/2019

2402MHz_TX

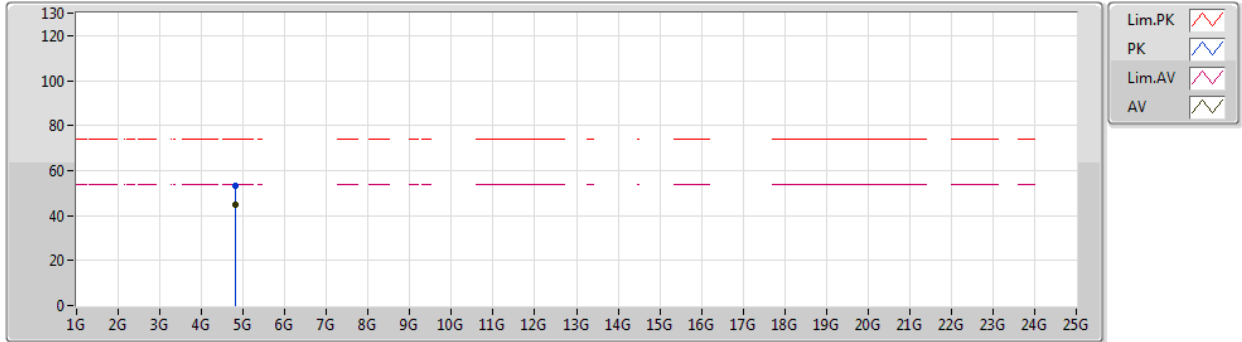

Type	Freq (Hz)	Level (dBuV/m)	Limit (dBuV/m)	Margin (dB)	Factor (dB)	Dist (m)	Condition	Azimuth (°)	Height (m)	Comment	Raw (dBuV)	AF (dB)	CL (dB)	PA (dB)
AV	4.80294G	44.97	54.00	-9.03	6.72	3	Vertical	291	2.07	-	38.25	31.10	9.92	34.30
PK	4.80301G	53.23	74.00	-20.77	6.72	3	Vertical	291	2.07	-	46.51	31.10	9.92	34.30



BT-LE(2Mbps)

26/09/2019

2402MHz_TX

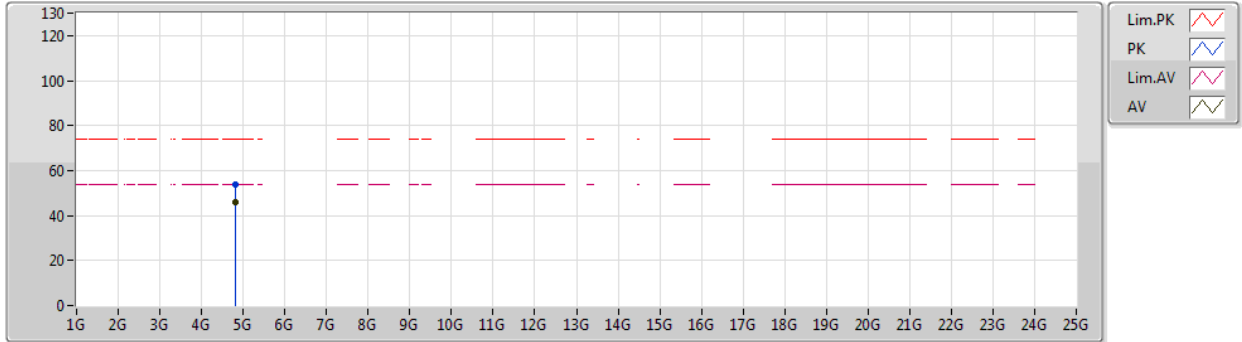

Type	Freq (Hz)	Level (dBuV/m)	Limit (dBuV/m)	Margin (dB)	Factor (dB)	Dist (m)	Condition	Azimuth (°)	Height (m)	Comment	Raw (dBuV)	AF (dB)	CL (dB)	PA (dB)
AV	4.80307G	45.81	54.00	-8.19	6.72	3	Horizontal	271	3.00	-	39.09	31.10	9.92	34.30
PK	4.80402G	53.58	74.00	-20.42	6.72	3	Horizontal	271	3.00	-	46.86	31.10	9.92	34.30

BT-LE(2Mbps)

26/09/2019

2440MHz_TX

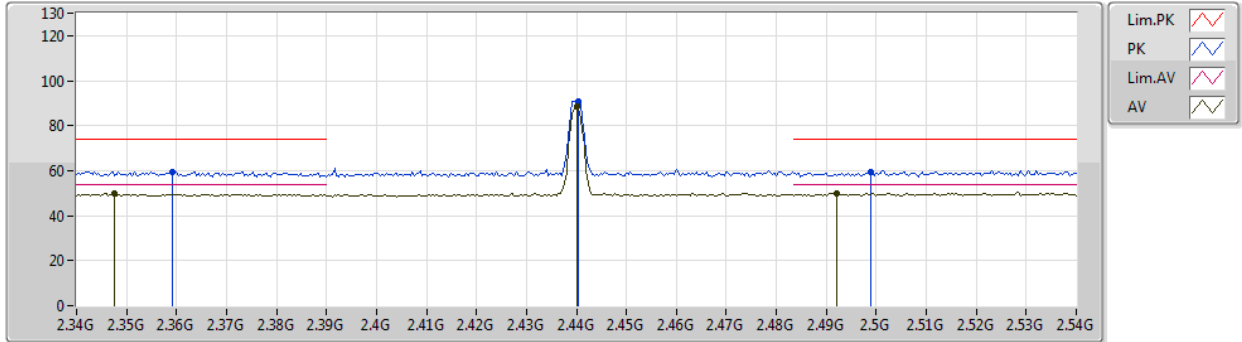

Type	Freq (Hz)	Level (dBuV/m)	Limit (dBuV/m)	Margin (dB)	Factor (dB)	Dist (m)	Condition	Azimuth (°)	Height (m)	Comment	Raw (dBuV)	AF (dB)	CL (dB)	PA (dB)
AV	2.3476G	50.04	54.00	-3.96	35.15	3	Vertical	214	1.00	-	14.89	27.81	7.34	-
AV	2.44G	88.52	Inf	-Inf	34.91	3	Vertical	214	1.00	-	53.61	27.56	7.35	-
AV	2.492G	50.12	54.00	-3.88	34.88	3	Vertical	214	1.00	-	15.24	27.51	7.37	-
PK	2.3592G	59.62	74.00	-14.38	35.10	3	Vertical	214	1.00	-	24.52	27.76	7.34	-
PK	2.4404G	90.93	Inf	-Inf	34.91	3	Vertical	214	1.00	-	56.02	27.56	7.35	-
PK	2.4988G	59.28	74.00	-14.72	34.87	3	Vertical	214	1.00	-	24.41	27.50	7.37	-

BT-LE(2Mbps)

26/09/2019

2440MHz_TX

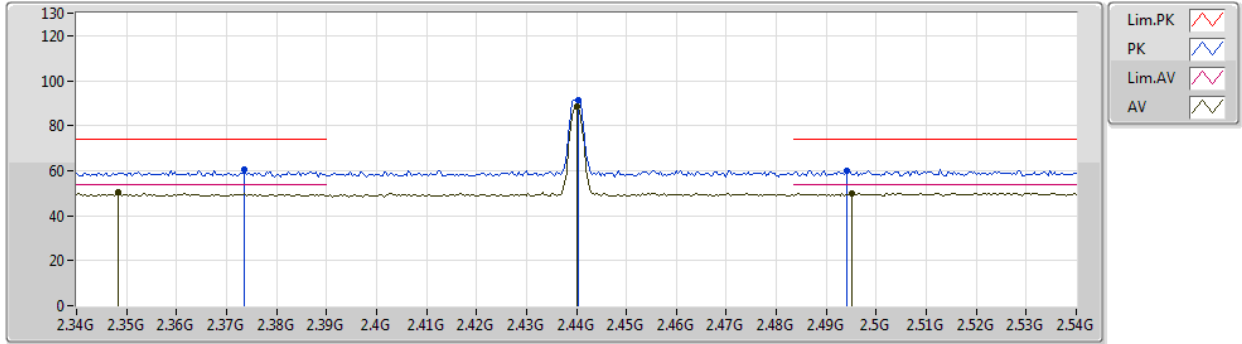

Type	Freq (Hz)	Level (dBuV/m)	Limit (dBuV/m)	Margin (dB)	Factor (dB)	Dist (m)	Condition	Azimuth (°)	Height (m)	Comment	Raw (dBuV)	AF (dB)	CL (dB)	PA (dB)
AV	2.3484G	50.19	54.00	-3.81	35.15	3	Horizontal	214	1.00	-	15.04	27.81	7.34	-
AV	2.44G	88.77	Inf	-Inf	34.91	3	Horizontal	214	1.00	-	53.86	27.56	7.35	-
AV	2.4952G	49.82	54.00	-4.18	34.87	3	Horizontal	214	1.00	-	14.95	27.50	7.37	-
PK	2.3736G	60.61	74.00	-13.39	35.05	3	Horizontal	214	1.00	-	25.56	27.71	7.34	-
PK	2.4404G	91.19	Inf	-Inf	34.91	3	Horizontal	214	1.00	-	56.28	27.56	7.35	-
PK	2.494G	60.15	74.00	-13.85	34.88	3	Horizontal	214	1.00	-	25.27	27.51	7.37	-

BT-LE(2Mbps)

26/09/2019

2440MHz_TX

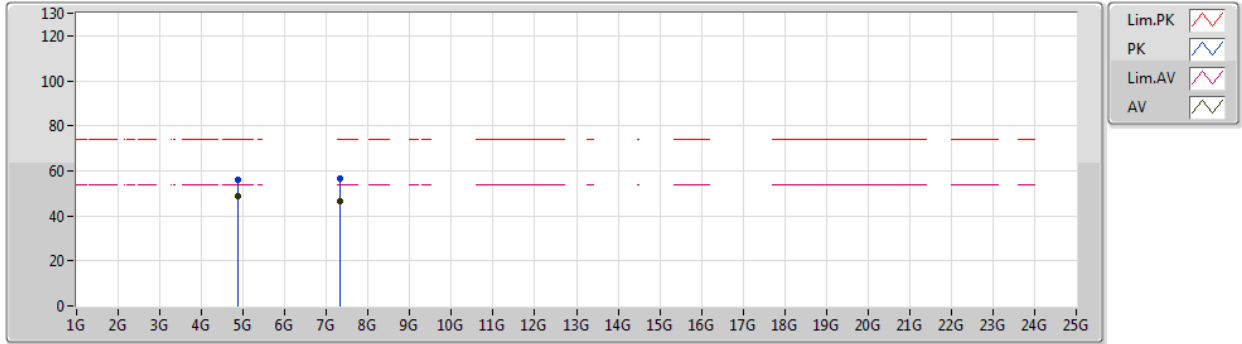

Type	Freq (Hz)	Level (dBuV/m)	Limit (dBuV/m)	Margin (dB)	Factor (dB)	Dist (m)	Condition	Azimuth (°)	Height (m)	Comment	Raw (dBuV)	AF (dB)	CL (dB)	PA (dB)
AV	4.87901G	48.90	54.00	-5.10	6.80	3	Vertical	287	2.01	-	42.10	31.10	9.98	34.28
AV	7.31825G	46.52	54.00	-7.48	12.99	3	Vertical	264	2.89	-	33.53	36.28	11.30	34.59
PK	4.88099G	56.31	74.00	-17.69	6.80	3	Vertical	287	2.01	-	49.51	31.10	9.98	34.28
PK	7.31988G	56.77	74.00	-17.23	12.99	3	Vertical	264	2.89	-	43.78	36.28	11.30	34.59

BT-LE(2Mbps)

26/09/2019

2440MHz_TX

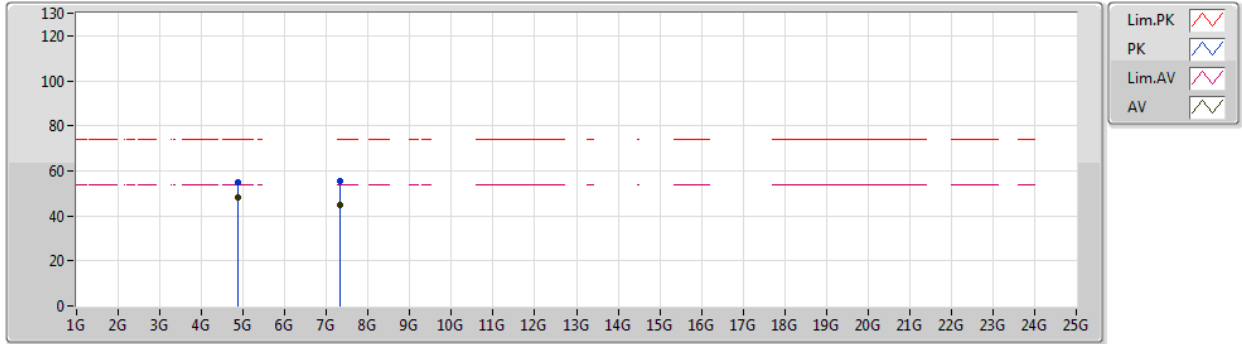

Type	Freq (Hz)	Level (dBuV/m)	Limit (dBuV/m)	Margin (dB)	Factor (dB)	Dist (m)	Condition	Azimuth (°)	Height (m)	Comment	Raw (dBuV)	AF (dB)	CL (dB)	PA (dB)
AV	4.87902G	48.11	54.00	-5.89	6.80	3	Horizontal	274	1.53	-	41.31	31.10	9.98	34.28
AV	7.3214G	44.95	54.00	-9.05	13.00	3	Horizontal	213	2.46	-	31.95	36.28	11.31	34.59
PK	4.87887G	55.01	74.00	-18.99	6.80	3	Horizontal	274	1.53	-	48.21	31.10	9.98	34.28
PK	7.31997G	55.47	74.00	-18.53	12.99	3	Horizontal	213	2.46	-	42.48	36.28	11.30	34.59

BT-LE(2Mbps)

26/09/2019

2480MHz_TX

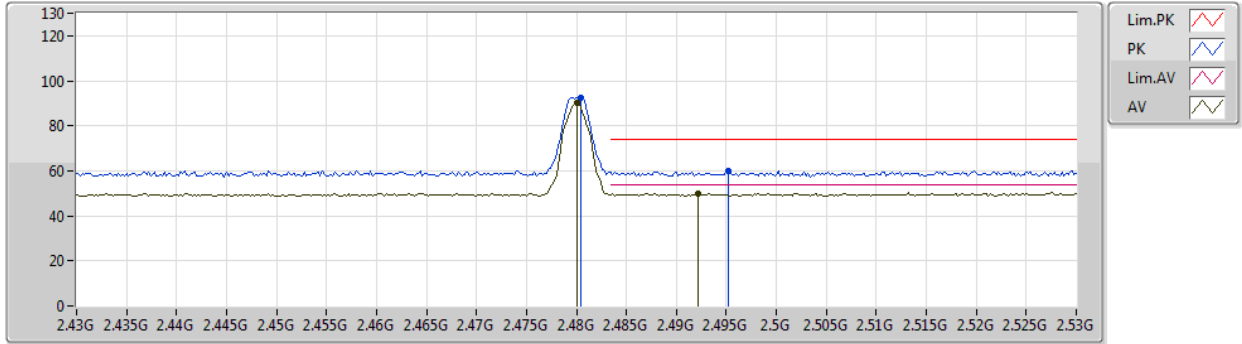

Type	Freq (Hz)	Level (dBuV/m)	Limit (dBuV/m)	Margin (dB)	Factor (dB)	Dist (m)	Condition	Azimuth (°)	Height (m)	Comment	Raw (dBuV)	AF (dB)	CL (dB)	PA (dB)
AV	2.48G	89.98	Inf	-Inf	34.89	3	Vertical	206	1.15	-	55.09	27.52	7.37	-
AV	2.4922G	49.98	54.00	-4.02	34.88	3	Vertical	206	1.15	-	15.10	27.51	7.37	-
PK	2.4804G	92.41	Inf	-Inf	34.89	3	Vertical	206	1.15	-	57.52	27.52	7.37	-
PK	2.4952G	59.87	74.00	-14.13	34.87	3	Vertical	206	1.15	-	25.00	27.50	7.37	-

BT-LE(2Mbps)

26/09/2019

2480MHz_TX

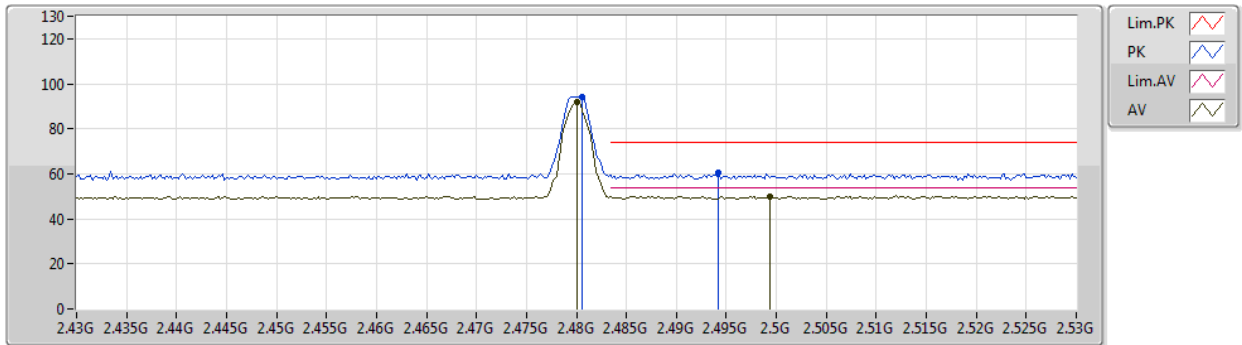

Type	Freq (Hz)	Level (dBuV/m)	Limit (dBuV/m)	Margin (dB)	Factor (dB)	Dist (m)	Condition	Azimuth (°)	Height (m)	Comment	Raw (dBuV)	AF (dB)	CL (dB)	PA (dB)
AV	2.48G	91.76	Inf	-Inf	34.89	3	Horizontal	271	1.67	-	56.87	27.52	7.37	-
AV	2.4994G	49.92	54.00	-4.08	34.87	3	Horizontal	271	1.67	-	15.05	27.50	7.37	-
PK	2.4806G	94.14	Inf	-Inf	34.89	3	Horizontal	271	1.67	-	59.25	27.52	7.37	-
PK	2.4942G	60.73	74.00	-13.27	34.88	3	Horizontal	271	1.67	-	25.85	27.51	7.37	-

BT-LE(2Mbps)

26/09/2019

2480MHz_TX

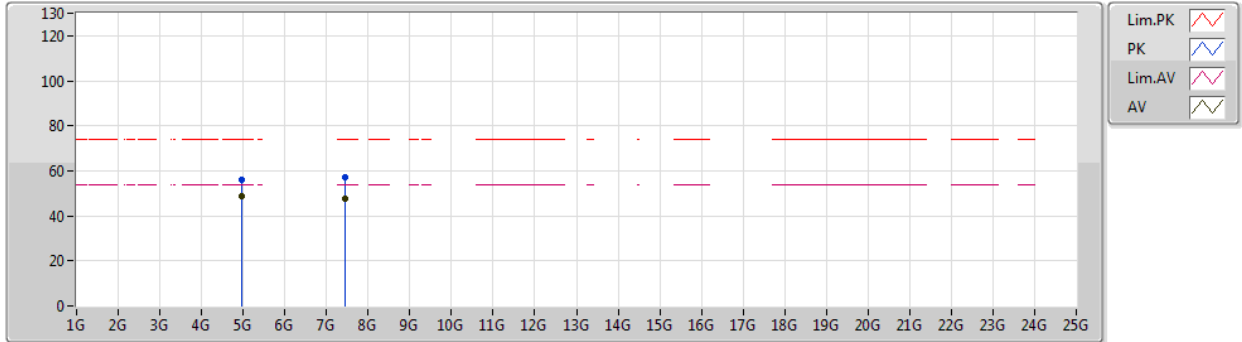

Type	Freq (Hz)	Level (dBuV/m)	Limit (dBuV/m)	Margin (dB)	Factor (dB)	Dist (m)	Condition	Azimuth (°)	Height (m)	Comment	Raw (dBuV)	AF (dB)	CL (dB)	PA (dB)
AV	4.95901G	48.78	54.00	-5.22	7.23	3	Vertical	289	1.99	-	41.55	31.34	10.05	34.16
AV	7.43867G	47.68	54.00	-6.32	13.10	3	Vertical	261	1.99	-	34.58	36.32	11.38	34.60
PK	4.959G	55.99	74.00	-18.01	7.22	3	Vertical	289	1.99	-	48.77	31.34	10.04	34.16
PK	7.43847G	57.08	74.00	-16.92	13.10	3	Vertical	261	1.99	-	43.98	36.32	11.38	34.60

BT-LE(2Mbps)

26/09/2019

2480MHz_TX

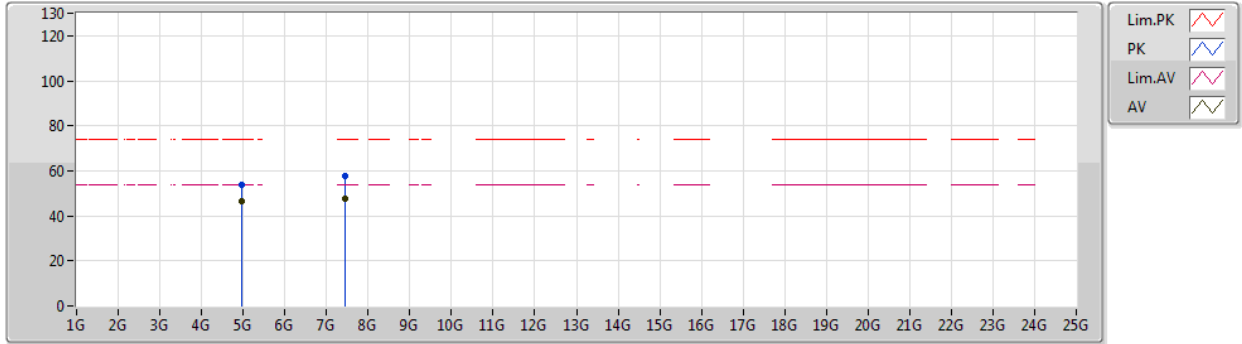

Type	Freq (Hz)	Level (dBuV/m)	Limit (dBuV/m)	Margin (dB)	Factor (dB)	Dist (m)	Condition	Azimuth (°)	Height (m)	Comment	Raw (dBuV)	AF (dB)	CL (dB)	PA (dB)
AV	4.95914G	46.54	54.00	-7.46	7.23	3	Horizontal	274	1.54	-	39.31	31.34	10.05	34.16
AV	7.43877G	47.70	54.00	-6.30	13.10	3	Horizontal	214	1.98	-	34.60	36.32	11.38	34.60
PK	4.96003G	54.06	74.00	-19.94	7.23	3	Horizontal	274	1.54	-	46.83	31.34	10.05	34.16
PK	7.44169G	57.48	74.00	-16.52	13.12	3	Horizontal	214	1.98	-	44.36	36.33	11.39	34.60