



**FCC 47 CFR PART 15 SUBPART C AND ANSI C63.10:2009
TEST REPORT**

For

wrist watch

Model : Modern

Data Applies To : Classic ; Radar

Trade Name : WHAT?

Issued for

What Watch HK Limited

19 Floor, Silver Fortune Plaza, 1 Wellington Street, Central, Hong Kong

Issued by

Compliance Certification Services Inc.

Hsinchu Lab.

**No.989-1, Wenshan Rd., Shangshan Village,
Qionglin Township, Hsinchu County 30741, Taiwan (R.O.C.)**

TEL: +886-3-5921698

FAX: +886-3-5921108

<http://www.ccsrf.com>

E-Mail : service@ccsrf.com

Issued Date: April 28, 2015



Note: This report shall not be reproduced except in full, without the written approval of Compliance Certification Services Inc. This document may be altered or revised by Compliance Certification Services Inc. personnel only, and shall be noted in the revision section of the document. The client should not use it to claim product endorsement by TAF or any government agencies. The test results of this report relate only to the tested sample identified in this report.



Revision History

Rev.	Issue Date	Revisions	Effect Page	Revised By
00	04/28/2015	Initial Issue	All Page 42	Michelle Chiu



TABLE OF CONTENTS

TITLE	PAGE NO.
1. TEST REPORT CERTIFICATION	4
2. EUT DESCRIPTION	5
3. DESCRIPTION OF TEST MODES	6
4. TEST METHODOLOGY	7
5. FACILITIES AND ACCREDITATION	7
5.1 FACILITIES	7
5.2 ACCREDITATIONS.....	7
5.3 MEASUREMENT UNCERTAINTY	8
6. SETUP OF EQUIPMENT UNDER TEST.....	9
7. FCC PART 15.247 REQUIREMENTS	10
7.1 6dB BANDWIDTH	10
7.2 MAXIMUM PEAK OUTPUT POWER	14
7.3 AVERAGE POWER	16
7.4 POWER SPECTRAL DENSITY	18
7.5 CONDUCTED SPURIOUS EMISSION	22
7.6 RADIATED EMISSION.....	26
7.7 CONDUCTED EMISSION.....	38
APPENDIX SETUP PHOTOS	41



1. TEST REPORT CERTIFICATION

Applicant : What Watch HK Limited
Address : 19 Floor, Silver Fortune Plaza, 1 Wellington Street, Central, Hong Kong
Equipment Under Test : wrist watch
Model : Modern
Data Applies To : Classic ; Radar
Trade Name : **WHAT?**
Tested Date : April 09 ~ 16, 2015

APPLICABLE STANDARD	
Standard	Test Result
FCC Part 15 Subpart C AND ANSI C63.10:2009	PASS

WE HEREBY CERTIFY THAT: The above equipment has been tested by Compliance Certification Services Inc., and found compliance with the requirements set forth in the technical standards mentioned above. The results of testing in this report apply only to the product/system, which was tested. Other similar equipment will not necessarily produce the same results due to production tolerance and measurement uncertainties.

Approved by:

Rex Liao
Deputy Manager

Reviewed by:

Jacky Chen
Section Manager



2. EUT DESCRIPTION

Product Name	wrist watch
Model Number	Modern
Data Applies To	Classic ; Radar
Identify Number	T150409D07
Received Date	April 09, 2015
Frequency Range	2402 MHz ~ 2480 MHz
Transmit Power	0.36 dBm (0.0011W)
Channel Spacing	2 MHz
Channel Number	40 Channels
Transmit Data Rate	1 Mbps
Type of Modulation	GFSK
Antenna Type	PCB Antenna , Antenna Gain 1.72 dBi
Power Rating	3Vdc
Test Voltage	120Vac, 60Hz

The difference of the series model

Model Number	Difference
Modern	For the marketing purpose.
Classic	
Radar	

Remark :

1. The sample selected for test was engineering sample that approximated to production product and was provided by manufacturer.
2. For more details, please refer to the User's manual of the EUT.
3. This submittal(s) (test report) is intended for FCC ID: 2AENG000DSW010 filing to comply with Section 15.207, 15.209 and 15.247 of the FCC Part 15, Subpart C Rules.
4. The model Modern was considered the main model for testing.



3. DESCRIPTION OF TEST MODES

The EUT (wrist watch) had been tested under operating condition.

Conducted Emission / Radiated Emission Test (Below 1 GHz)

1. The following test modes were scanned during the preliminary test:

No.	Pre-Test Mode
1	TX Mode

2. After the preliminary scan, the following test mode was found to produce the highest emission level.

Final Test Mode		
Emission	Radiated Emission	Mode 1
	Conducted Emission	N/A

Remark : Then, the above highest emission mode of the configuration of the EUT and cable was chosen for all final test items.

Conducted / Radiated Emission Test (Above 1 GHz)

The EUT had been tested under operating condition.

There are three channels have been tested as following :

Channel	Frequency (MHz)
Low	2402
Middle	2440
High	2480

Remark : The field strength of spurious emission was measured in the following position: EUT stand-up position(Z axis), lie-down position(X, Y axis). The worst emission was found in lie-down position(X axis) and the worst case was recorded.



4. TEST METHODOLOGY

The tests documented in this report were performed in accordance with ANSI C63.10: 2009 and FCC CFR 47, 15.207, 15.209 and 15.247.

5. FACILITIES AND ACCREDITATION

5.1 FACILITIES

All measurement facilities used to collect the measurement data are located at

No.989-1, Wenshan Rd., Shangshan Village,
Qionglin Township, Hsinchu County 30741, Taiwan (R.O.C.)

The sites are constructed in conformance with the requirements of ANSI C63.10:2009 and CISPR 22. All receiving equipment conforms to CISPR 16-1-1, CISPR 16-1-2, CISPR 16-1-3, CISPR 16-1-4, CISPR 16-1-5.

5.2 ACCREDITATIONS

Our laboratories are accredited and approved by the following approval agencies according to ISO/IEC 17025.

Taiwan	TAF
---------------	-----

The measuring facility of laboratories has been authorized or registered by the following approval agencies.

Canada	INDUSTRY CANADA
Japan	VCCI
Taiwan	BSMI
USA	FCC MRA

Copies of granted accreditation certificates are available for downloading from our web site, <http://www.ccsrf.com>

Remark: FCC Designation Number TW1027.



5.3 MEASUREMENT UNCERTAINTY

The following table is for the measurement uncertainty, which is calculated as per the document CISPR 16-4-2.

PARAMETER	UNCERTAINTY
Semi Anechoic Chamber (966 Chamber_B) / Radiated Emission, 30 to 1000 MHz	+/- 3.97
Semi Anechoic Chamber (966 Chamber_B) / Radiated Emission, 1 to 18GHz	+/- 3.58
Semi Anechoic Chamber (966 Chamber_B) / Radiated Emission, 18 to 26 GHz	+/- 3.59
Semi Anechoic Chamber (966 Chamber_B) / Radiated Emission, 26 to 40 GHz	+/- 3.81
Conducted Emission (Mains Terminals), 9kHz to 30MHz	+/- 2.48

This uncertainty represents an expanded uncertainty expressed at approximately the 95% confidence level using a coverage factor of $k=2$.

Consistent with industry standard (e.g. CISPR 22, clause 11, Measurement Uncertainty) determining compliance with the limits shall be base on the results of the compliance measurement. Consequently the measure emissions being less than the maximum allowed emission result in this be a compliant test or passing test.

The acceptable measurement uncertainty value without requiring revision of the compliance statement is base on conducted and radiated emissions being less than U_{CISPR} which is 3.6dB and 5.2dB respectively. CCS values (called U_{Lab} in CISPR 16-4-2) is less than U_{CISPR} as shown in the table above. Therefore, MU need not be considered for compliance.



6. SETUP OF EQUIPMENT UNDER TEST

SUPPORT EQUIPMENT

No.	Product	Manufacturer	Model No.	Serial No.
1	Notebook PC	HP	ProBook 4421s	CNF03242PJ

No.	Power & Signal Cable Description
1	Shielded USB cable , 2m × 1

SETUP DIAGRAM FOR TESTS

EUT & peripherals setup diagram is shown in appendix setup photos.

EUT OPERATING CONDITION

1. EUT & peripherals setup diagram is shown in appendix setup photos.
2. TX mode
 Freq: 2402, 2440, 2480
3. All of the functions are under run.
4. Start test.



7. FCC PART 15.247 REQUIREMENTS

7.1 6dB BANDWIDTH

LIMITS

§ 15.247(a) (2) For direct sequence systems, the minimum 6dB bandwidth shall be at least 500kHz.

TEST EQUIPMENT

Name of Equipment	Manufacturer	Model	Serial Number	Calibration Due
Spectrum Analyzer	Agilent	E4446A	MY43360132	06/10/2015

Remark: Each piece of equipment is scheduled for calibration once a year.

TEST SETUP



TEST PROCEDURE

1. The transmitter output was connected to a spectrum analyzer.
2. Set RBW = 100 kHz.
3. Set the video bandwidth (VBW) $\geq 3 \times$ RBW.
4. Detector = Peak.
5. Trace mode = max hold.
6. Sweep = auto couple.
7. Allow the trace to stabilize.
8. Measure the maximum width of the emission that is constrained by the frequencies associated with the two outermost amplitude points (upper and lower frequencies) that are attenuated by 6 dB relative to the maximum level measured in the fundamental emission.



TEST RESULTS

Channel	Channel Frequency (MHz)	6dB Bandwidth (kHz)	Minimum Limit (kHz)	Pass / Fail
Low	2402	668.7	500	PASS
Middle	2440	658.5	500	PASS
High	2480	673.8	500	PASS



6dB BANDWIDTH

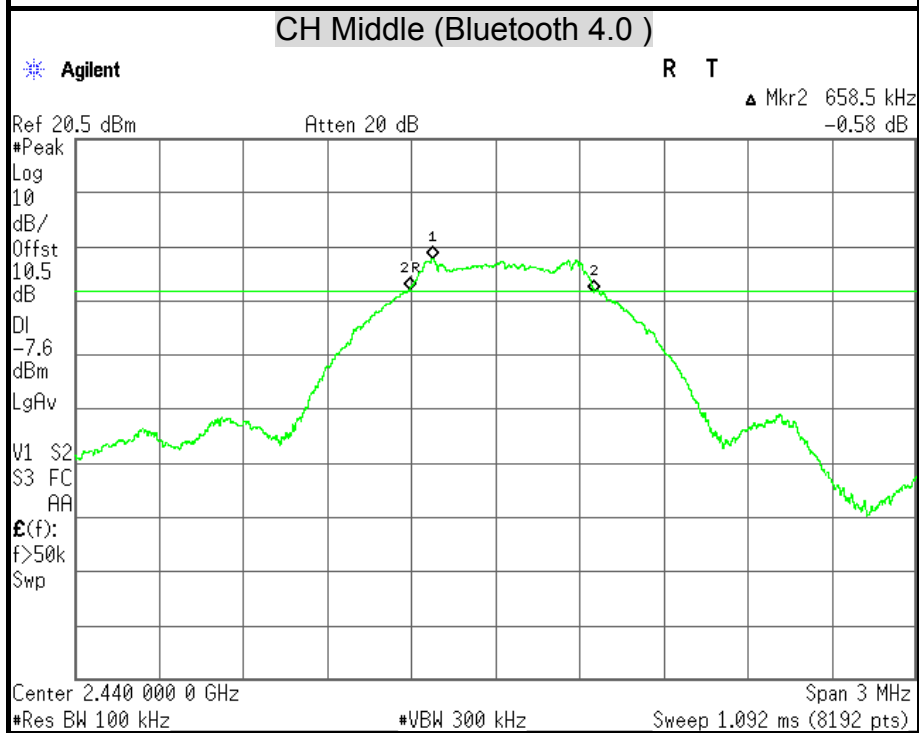
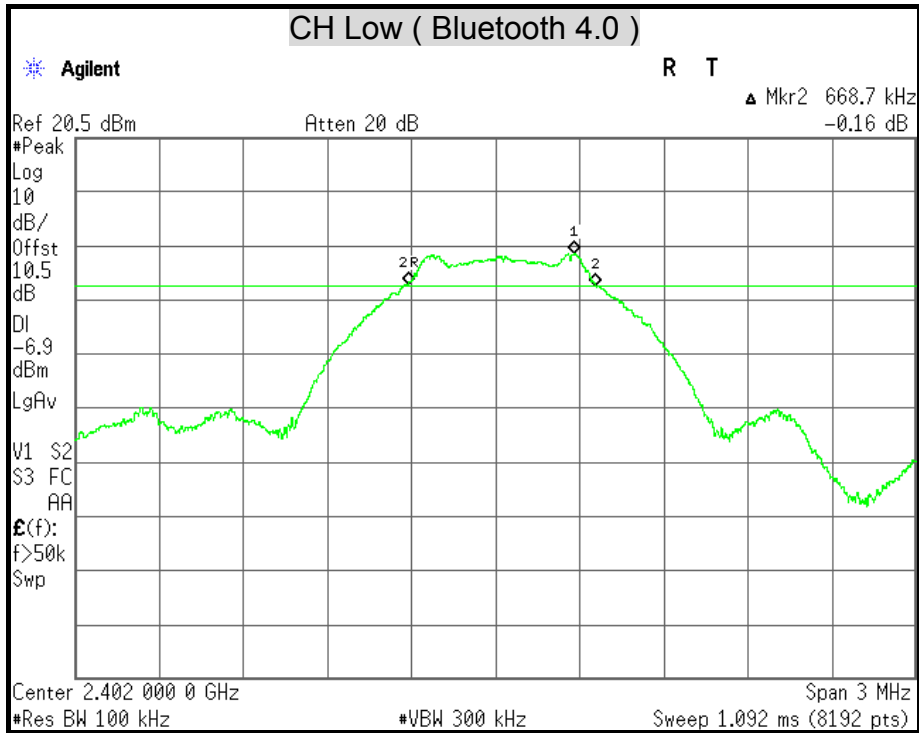

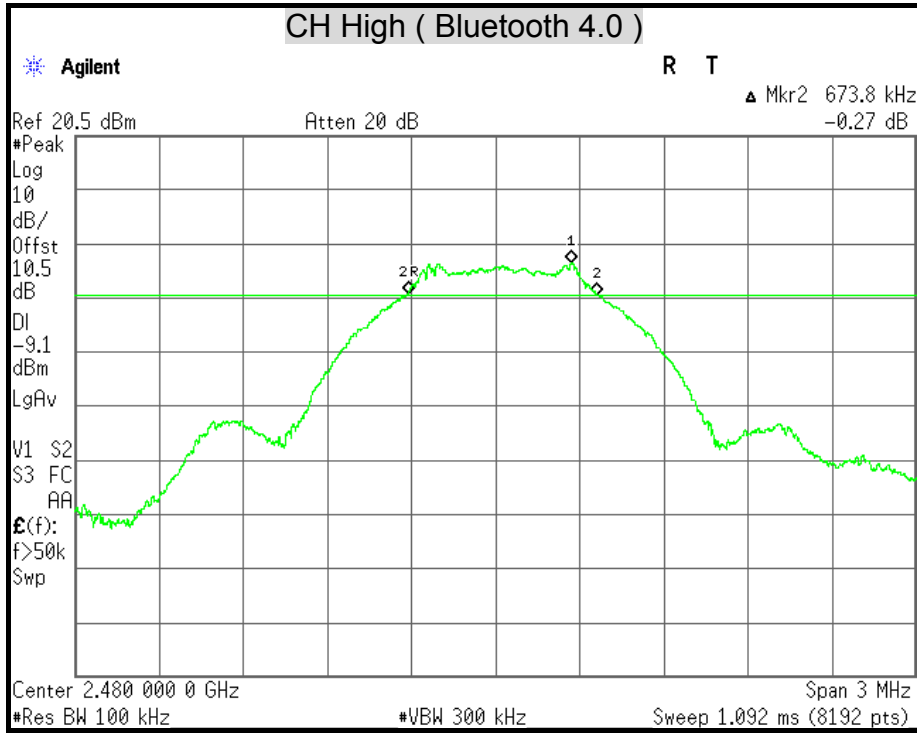



7.2 MAXIMUM PEAK OUTPUT POWER

LIMITS

§ 15.247(b) The maximum peak output power of the intentional radiator shall not exceed the following :

§ 15.247(b) (3) For systems using digital modulation in the 902-928 MHz, 2400-2483.5 MHz, and 5725-5850 MHz bands : 1 watt.

§ 15.247(b) (4) Except as shown in paragraphs (c) of this section, if transmitting antennas of directional gain greater than 6 dBi are used the peak output power from the intentional radiator shall be reduced below the stated values in paragraphs (b)(1) or (b)(2), and (b)(3) of this section, as appropriate, by the amount in dB that the directional gain of the antenna exceeds 6 dBi.

§ KDB 662911 : For power measurements on IEEE 802.11 devices

Array Gain = 0 dB (i.e., no array gain) for $N_{ANT} \leq 4$;

Array Gain = 0 dB (i.e., no array gain) for channel widths ≥ 40 MHz for any N_{ANT} ;

Array Gain = $5 \log(N_{ANT}/N_{SS})$ dB or 3 dB, whichever is less for 20-MHz channel widths with $N_{ANT} \geq 5$.

TEST EQUIPMENT

Name of Equipment	Manufacturer	Model	Serial Number	Calibration Due
Power Meter	Anritsu	ML2495A	1149001	12/11/2015
Power Sensor	Anritsu	MA2411B	1126148	12/11/2015

Remark: Each piece of equipment is scheduled for calibration once a year.

TEST SETUP



TEST PROCEDURE

The transmitter output is connected to the power meter. The power meter is set to the peak power detection.



TEST RESULTS

Channel	Channel Frequency (MHz)	Peak Power		Peak Power Limit		Pass / Fail
		(dBm)	(W)	(dBm)	(W)	
Low	2402	0.36	0.0011	30	1	PASS
Middle	2440	-0.41	0.0009	30	1	PASS
High	2480	-1.79	0.0007	30	1	PASS

Remark: The cable assembly insertion loss of 10.5 dB (including 10 dB pad and 0.5 dB cable) was Entered as an offset in the power meter to allow for direct reading of power.



7.3 AVERAGE POWER

LIMITS

None; for reporting purposes only.

TEST EQUIPMENT

Name of Equipment	Manufacturer	Model	Serial Number	Calibration Due
Power Meter	ANRITSU	ML2495A	1149001	12/11/2015
Power Sensor	ANRITSU	MA2411B	1126148	12/11/2015

Remark: Each piece of equipment is scheduled for calibration once a year.

TEST SETUP



TEST PROCEDURE

The transmitter output is connected to the power meter. The power meter is set to the average power detection.



TEST RESULTS

Channel	Channel Frequency (MHz)	Average Power (dBm)
Low	2402	-1.13
Middle	2440	-1.89
High	2480	-3.30

Remark: The cable assembly insertion loss of 10.5 dB (including 10 dB pad and 0.5 dB cable) was Entered as an offset in the power meter to allow for direct reading of power.



7.4 POWER SPECTRAL DENSITY

LIMITS

§ 15.247(e) For digitally modulated systems, the power spectral density conducted from the intentional radiator to the antenna shall not greater than 8 dBm in any 3 kHz band during any time interval of continuous transmission.

TEST EQUIPMENT

Name of Equipment	Manufacturer	Model	Serial Number	Calibration Due
Spectrum Analyzer	Agilent	E4446A	MY43360132	06/10/2015

Remark: Each piece of equipment is scheduled for calibration once a year.

TEST SETUP



TEST PROCEDURE

1. The transmitter output was connected to the spectrum analyzer.
2. Set analyzer center frequency to DTS channel center frequency.
3. Set the span to 1.5 times the DTS channel bandwidth.
4. Set the RBW to: $3 \text{ kHz} \leq \text{RBW} \leq 100 \text{ kHz}$.
5. Set the VBW $\geq 3 \times \text{RBW}$.
6. Detector = peak.
7. Sweep time = auto couple.
8. Trace mode = max hold.
9. Allow trace to fully stabilize.
10. Use the peak marker function to determine the maximum amplitude level within the RBW.
11. If measured value exceeds limit, reduce RBW (no less than 3 kHz) and repeat.



TEST RESULTS

Channel	Channel Frequency (MHz)	Final RF Power Level in 3KHz BW (dBm)	Minimum Limit (dBm)	Pass / Fail
Low	2402	-12.10	8	PASS
Middle	2440	-14.07	8	PASS
High	2480	-15.28	8	PASS

Remark: The cable assembly insertion loss of 10.5 dB (including 10 dB pad and 0.5 dB cable) was Entered as an offset in the spectrum analyzer to allow for direct reading of power.



POWER SPECTRAL DENSITY

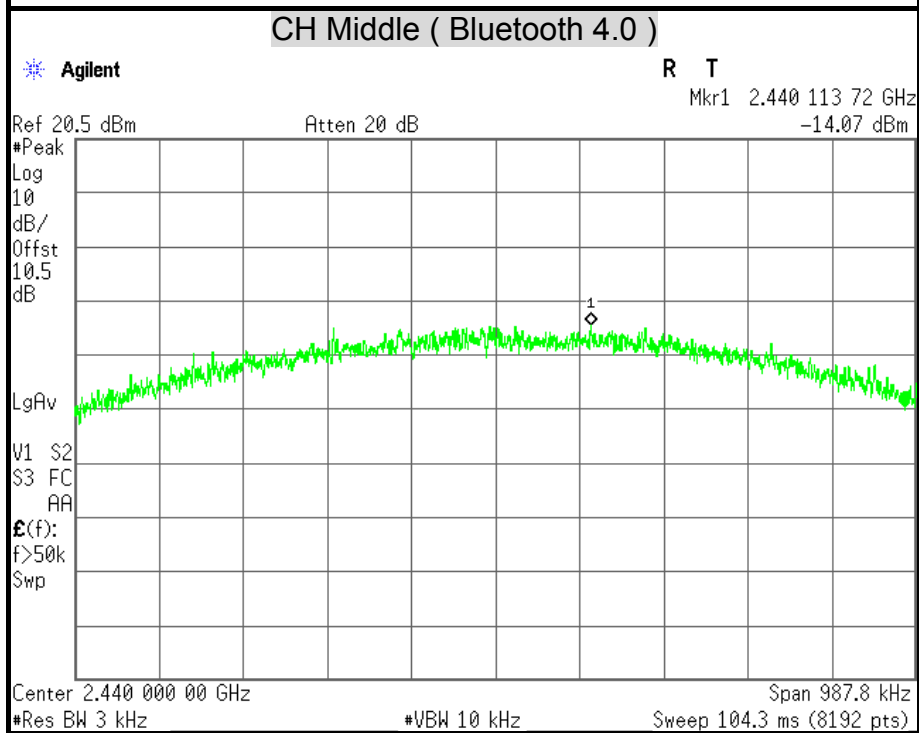
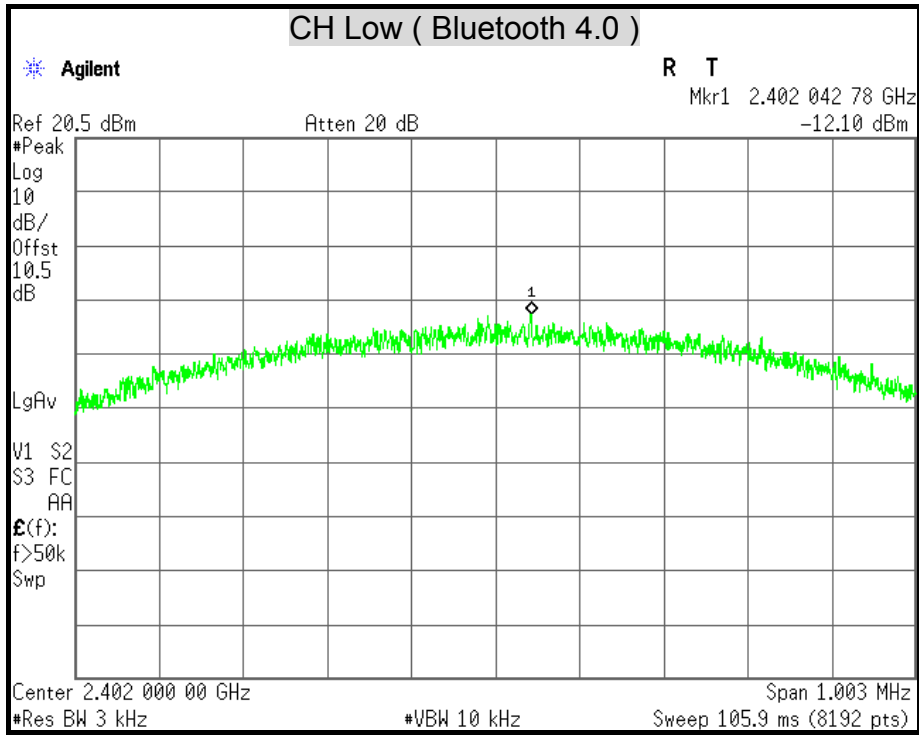

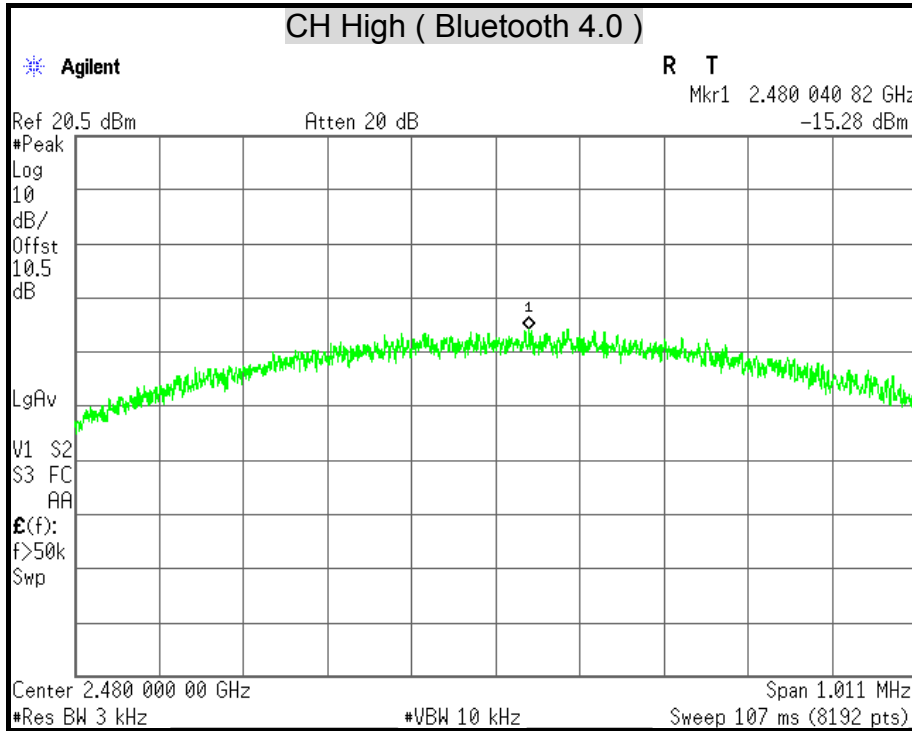



7.5 CONDUCTED SPURIOUS EMISSION

LIMITS

§ 15.247(d) In any 100 kHz bandwidth outside the frequency band in which the spread spectrum intentional radiator is operating, the radio frequency power that is produced by the intentional radiator shall be at least 20 dB below that in the 100 kHz bandwidth within the band that contains the highest level of the desired power, based on either an RF conducted or a radiated measurement. Attenuation below the general limits specified in § 15.209(a) is not required. In addition, radiated emissions which fall in the restricted bands, as defined in § 15.205(a), must also comply with the radiated emission limits specified in § 15.209(a) (see § 15.205(c)).

TEST EQUIPMENT

Name of Equipment	Manufacturer	Model	Serial Number	Calibration Due
Spectrum Analyzer	Agilent	E4446A	MY43360132	06/10/2015

Remark: Each piece of equipment is scheduled for calibration once a year.

TEST SETUP



TEST PROCEDURE

The transmitter output is connected to a spectrum analyzer. The resolution bandwidth is set to 100 kHz. The video bandwidth is set to 300 kHz.

The spectrum from 30 MHz to 26.5 GHz is investigated with the transmitter set to the lowest, middle, and highest channels in the 2.4 GHz band.



TEST RESULTS

OUT-OF-BAND SPURIOUS EMISSIONS-CONDUCTED MEASUREMENT

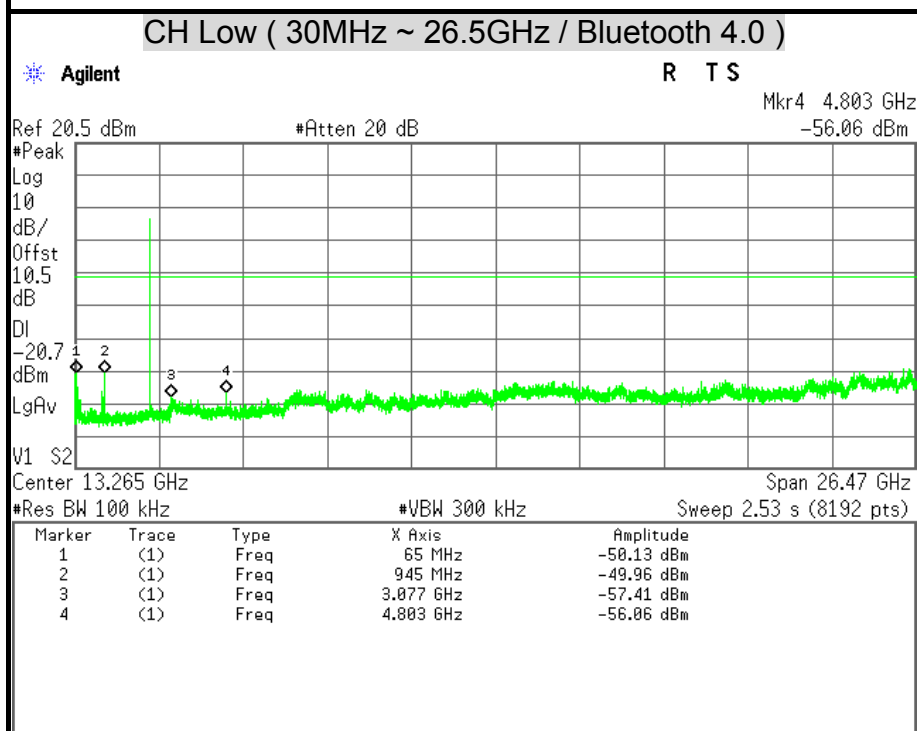
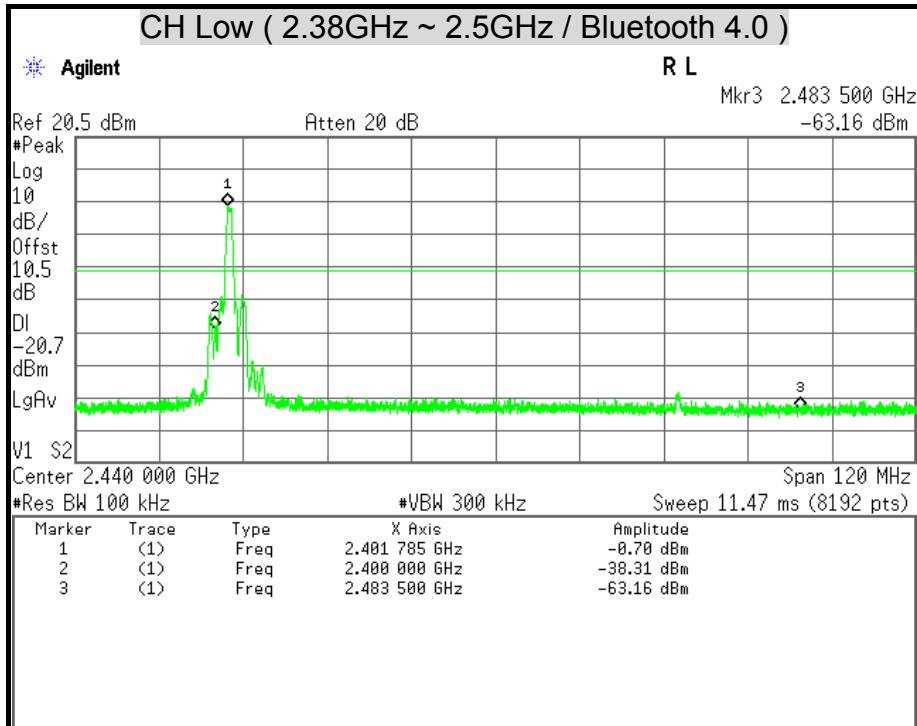

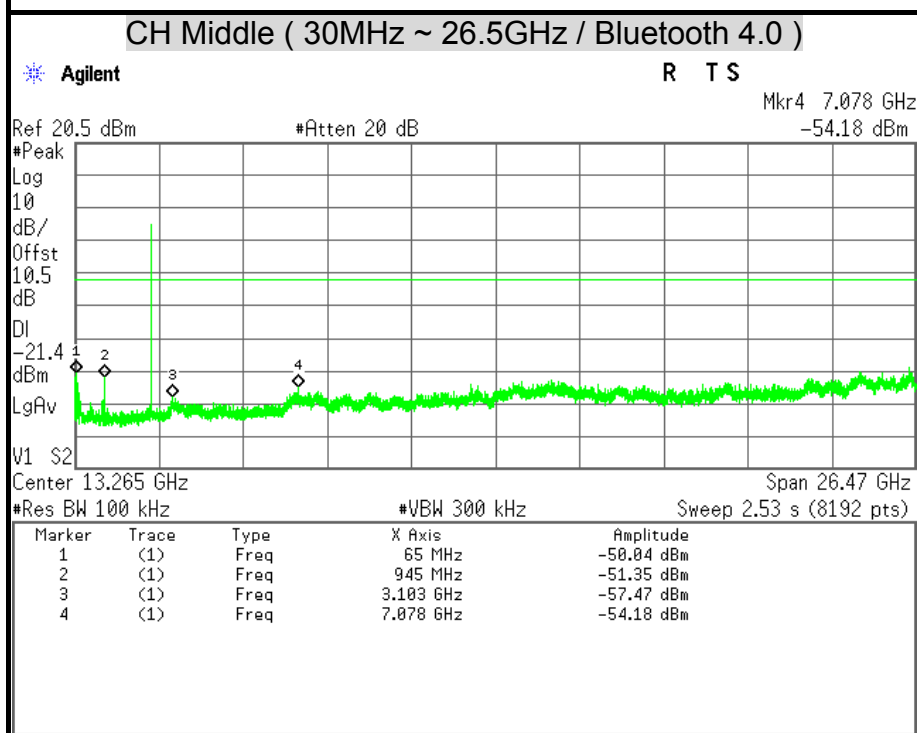
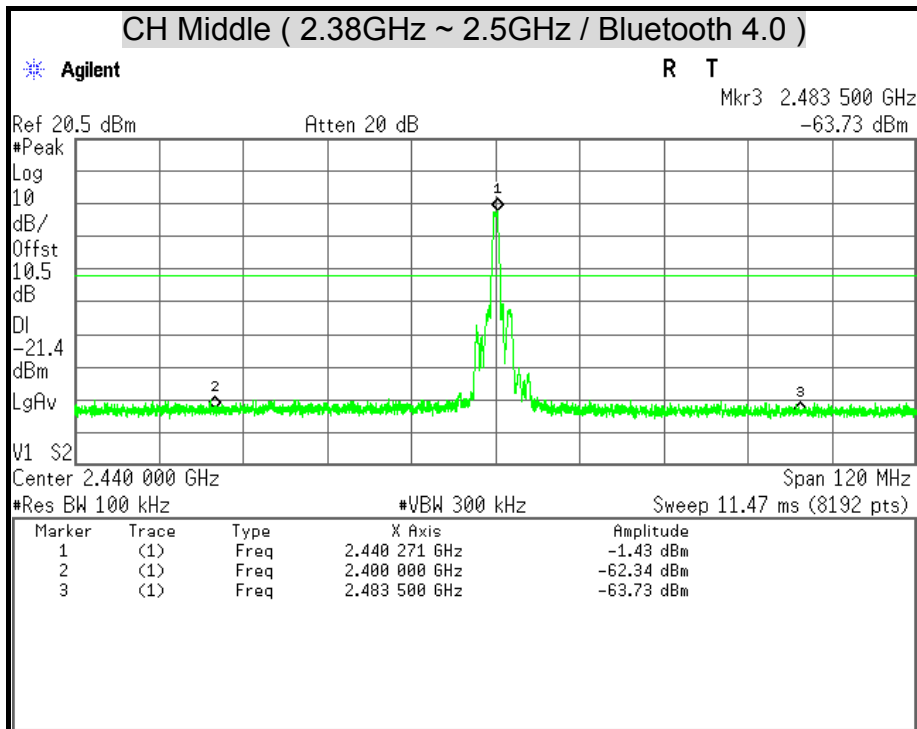

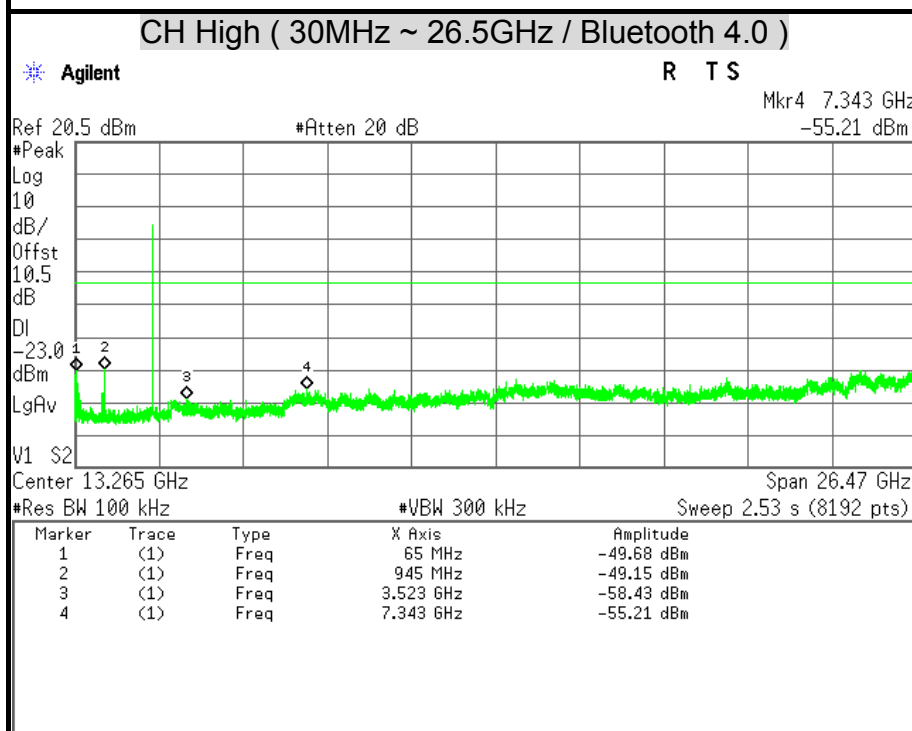
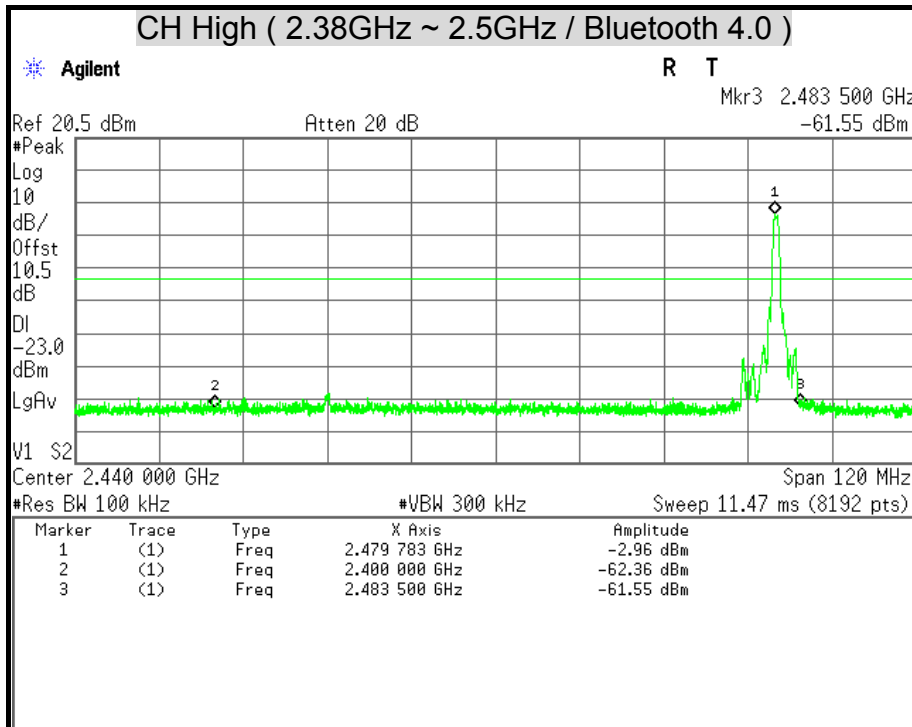



7.6 RADIATED EMISSION

LIMITS

(1) According to § 15.205 (a) Except as shown in paragraph (d) of this section, only spurious emissions are permitted in any of the frequency bands listed below:

MHz	MHz	MHz	GHz
0.090 - 0.110	16.42 - 16.423	399.9 - 410	4.5 - 5.15
¹ 0.495 - 0.505	16.69475 - 16.69525	608 - 614	5.35 - 5.46
2.1735 - 2.1905	16.80425 - 16.80475	960 - 1240	7.25 - 7.75
4.125 - 4.128	25.5 - 25.67	1300 - 1427	8.025 - 8.5
4.17725 - 4.17775	37.5 - 38.25	1435 - 1626.5	9.0 - 9.2
4.20725 - 4.20775	73 - 74.6	1645.5 - 1646.5	9.3 - 9.5
6.215 - 6.218	74.8 - 75.2	1660 - 1710	10.6 - 12.7
6.26775 - 6.26825	108 - 121.94	1718.8 - 1722.2	13.25 - 13.4
6.31175 - 6.31225	123 - 138	2200 - 2300	14.47 - 14.5
8.291 - 8.294	149.9 - 150.05	2310 - 2390	15.35 - 16.2
8.362 - 8.366	156.52475 - 156.52525	2483.5 - 2500	17.7 - 21.4
8.37625 - 8.38675	156.7 - 156.9	2655 - 2900	22.01 - 23.12
8.41425 - 8.41475	162.0125 - 167.17	3260 - 3267	23.6 - 24.0
12.29 - 12.293	167.72 - 173.2	3332 - 3339	31.2 - 31.8
12.51975 - 12.52025	240 - 285	3345.8 - 3338	36.43 - 36.5
12.57675 - 12.57725	322 - 335.4	3600 - 4400	(²)
13.36 - 13.41			

Remark:

- 1. ¹ Until February 1, 1999, this restricted band shall be 0.490-0.510 MHz.
- 2. ² Above 38.6

(2) According to § 15.205 (b) Except as provided in paragraphs (d) and (e), the field strength of emissions appearing within these frequency bands shall not exceed the limits shown in Section 15.209. At frequencies equal to or less than 1000 MHz, compliance with the limits in Section 15.209 shall be demonstrated using measurement instrumentation employing a CISPR quasi-peak detector. Above 1000 MHz, compliance with the emission limits in Section 15.209 shall be demonstrated based on the average value of the measured emissions. The provisions in Section 15.35 apply to these measurements.



(3) According to § 15.209 (a) Except as provided elsewhere in this Subpart, the emissions from an intentional radiator shall not exceed the field strength levels specified in the following table :

Frequency (MHz)	Field Strength (microvolts/meter)	Measurement Distance (meters)
0.009 – 0.490	2400/F(KHz)	300
0.490 – 1.705	24000/F(KHz)	30
1.705 – 30.0	30	30
30 - 88	100 **	3
88 - 216	150 **	3
216 - 960	200 **	3
Above 960	500	3

Remark: **Except as provided in paragraph (g), fundamental emissions from intentional radiators operating under this Section shall not be located in the frequency bands 54-72 MHz, 76-88 MHz, 174-216 MHz or 470-806 MHz. However, operation within these frequency bands is permitted under other sections of this Part, e.g., Sections 15.231 and 15.241.

(4) According to § 15.209 (b) In the emission table above, the tighter limit applies at the band edges.

TEST EQUIPMENT

Radiated Emission / 966Chamber_B

Name of Equipment	Manufacturer	Model	Serial Number	Calibration Due
Spectrum Analyzer	Agilent	E4446A	MY46180323	04/14/2016
EMI Test Receiver	ROHDE & SCHWARZ	ESCS 30	835418/008	10/14/2015
Bi-log Antenna	SCHWARZBECK	VULB 9168	9168-250	08/21/2015
Double-Ridged Waveguide Horn	ETS-LINDGREN	3117	00078733	12/02/2015
Horn Antenna	COM-POWER	AH-840	03077	12/17/2015
Pre-Amplifier	Agilent	8447D	2944A10052	07/15/2015
Pre-Amplifier	Agilent	8449B	3008A01916	07/15/2015
LOOP Antenna	EMCO	6502	8905-2356	09/23/2015
Notch Filters Band Reject	Micro-Tronics	BRM05702-01	026	N.C.R

Remark: 1. Each piece of equipment is scheduled for calibration once a year.
2. N.C.R = No Calibration Request.



TEST SETUP

The diagram below shows the test setup that is utilized to make the measurements for emission below 1GHz.

9kHz ~ 30MHz

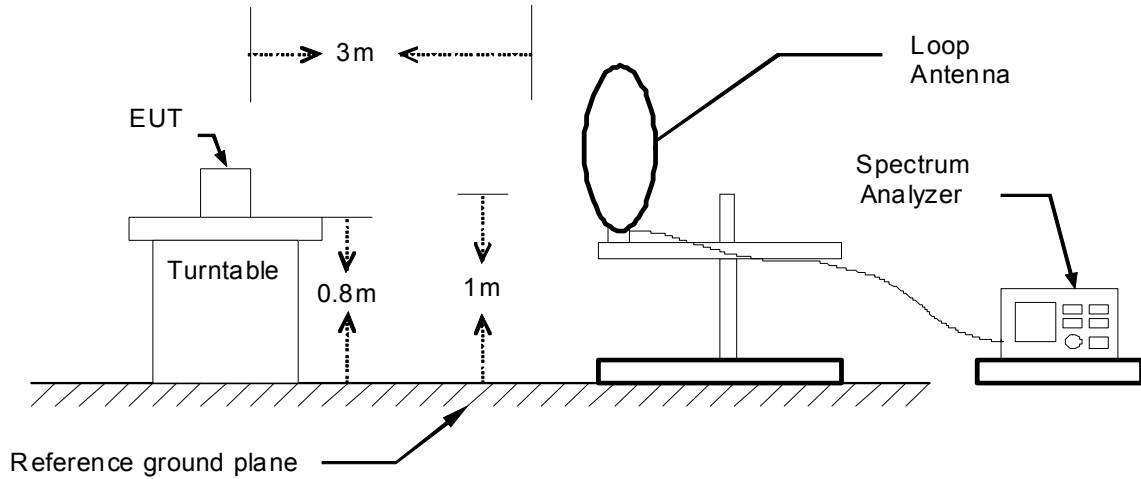

30MHz ~ 1GHz

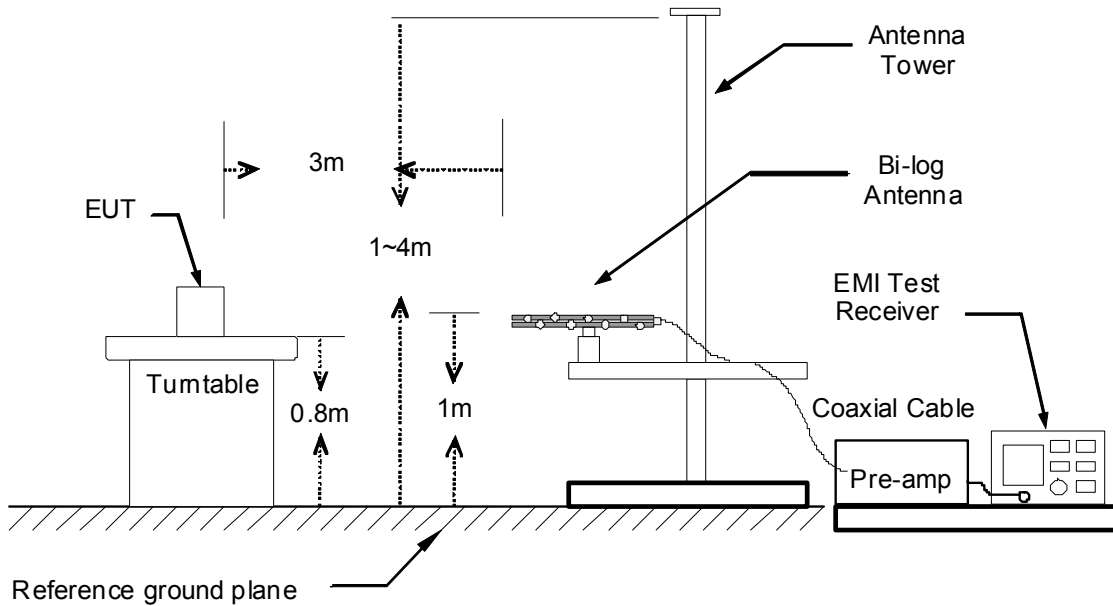



The diagram below shows the test setup that is utilized to make the measurements for emission above 1GHz.

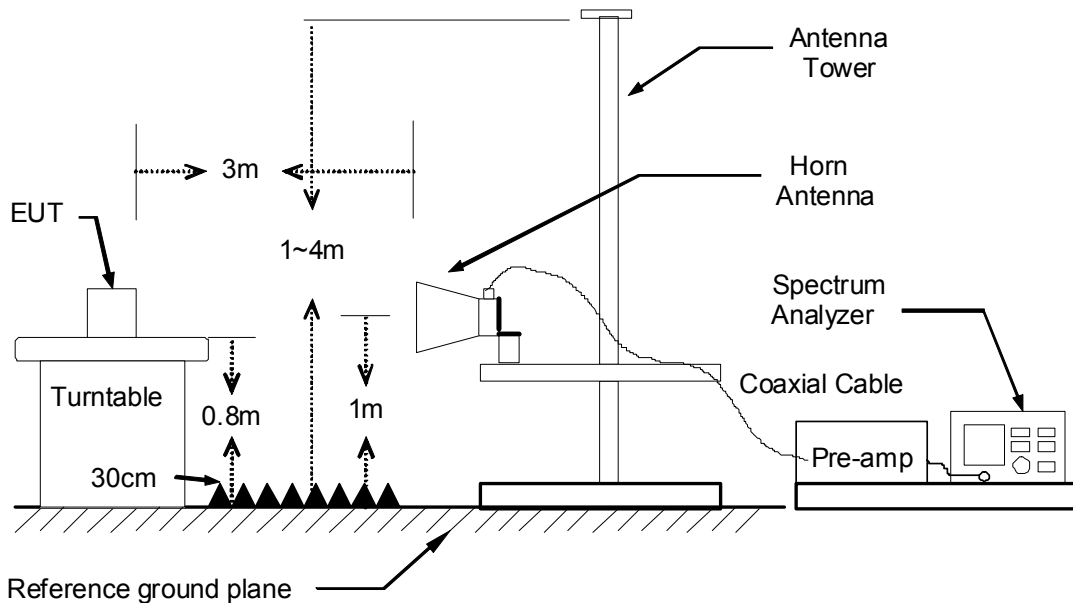

TEST PROCEDURE

1. The EUT was placed on the top of a rotating table 0.8 meters above the ground. The table was rotated 360 degrees to determine the position of the highest radiation.
2. While measuring the radiated emission below 1GHz, the EUT was set 3 meters away from the interference-receiving antenna, which was mounted on the top of a variable-height antenna tower. While measuring the radiated emission above 1GHz, the EUT was set 3 meters away from the interference-receiving antenna.
3. The antenna is a broadband antenna, and its height is varied from one meter to four meters above the ground to determine the maximum value of the field strength. Both horizontal and vertical polarization of the antenna are set to make the measurement.
4. For each suspected emission, the EUT was arranged to its worst case and then the antenna was tuned to heights from 1 meter to 4 meters and the table was turned from 0 degrees to 360 degrees to find the maximum reading.
5. The test-receiver system was set to Peak Detect Function and Specified Bandwidth with Maximum Hold Mode.
6. If the emission level of the EUT in peak mode was 10 dB lower than the limit specified, then testing could be stopped and the peak values of the EUT would be reported. Otherwise the emissions that did not have 10 dB margin would be re-tested one by one using peak, quasi-peak or average method as specified and then reported in a data sheet.

Remark :

1. The resolution bandwidth and video bandwidth of test receiver/spectrum analyzer is 120 KHz for Peak detection (PK) and Quasi-peak detection (QP) at frequency below 1GHz.
2. The resolution bandwidth and video bandwidth of test receiver/spectrum analyzer is 1 MHz for Peak detection and frequency above 1GHz.
3. The resolution bandwidth of test receiver/spectrum analyzer is 1 MHz and the video bandwidth is 10 Hz for Average detection (AV) at frequency above 1GHz.



TEST RESULTS

Below 1 GHz (9kHz ~ 30MHz)

No emission found between lowest internal used/generated frequency to 30MHz.

Below 1 GHz (30MHz ~ 1GHz)

Product Name	wrist watch	Test By	Audi Chang
Test Model	Modern	Test Date	2015/04/14
Test Mode	Mode 1	Temp. & Humidity	30°C, 52%

966 Chamber_B at 3Meter / Horizontal						
Frequency (MHz)	Reading (dBµV)	Correction Factor (dB/m)	Result (dBµV/m)	Limit (dBµV/m)	Margin (dB)	Remark
287.05	44.27	-12.18	32.09	46.00	-13.91	Peak
455.83	41.57	-8.77	32.79	46.00	-13.21	Peak
480.08	47.99	-8.46	39.53	46.00	-6.47	Peak
503.36	41.87	-8.15	33.73	46.00	-12.27	Peak
575.14	44.95	-6.65	38.30	46.00	-7.70	Peak
992.24	36.89	0.22	37.11	54.00	-16.89	Peak

966 Chamber_B at 3Meter / Vertical						
Frequency (MHz)	Reading (dBµV)	Correction Factor (dB/m)	Result (dBµV/m)	Limit (dBµV/m)	Margin (dB)	Remark
32.91	50.91	-15.23	35.68	40.00	-4.32	Peak
59.10	50.84	-14.00	36.84	40.00	-3.16	Peak
134.76	46.21	-14.50	31.71	43.50	-11.79	Peak
479.11	41.62	-8.47	33.15	46.00	-12.85	Peak
578.05	39.32	-6.56	32.76	46.00	-13.24	Peak
992.24	32.81	0.22	33.03	54.00	-20.97	Peak

Remark:

1. Quasi-peak test would be performed if the peak result were greater than the quasi-peak limit.
2. Data of measurement within this frequency range shown " --- " in the table above means the reading of emissions are attenuated more than 20dB below the permissible limits or the field strength is too small to be measured.
3. Correction Factor (dB/m) = Antenna Factor (dB/m) + Cable Loss (dB) – PreAmp.Gain (dB)
4. Result (dBµV/m) = Reading (dBµV) + Correction Factor (dB/m)
5. Margin (dB) = Remark result (dBµV/m) - Quasi-peak limit (dBµV/m).



Above 1 GHz

Product Name	wrist watch	Test By	Audi Chang
Test Model	Modern	Test Date	2015/04/14
Test Mode	Bluetooth 4.0 / TX Mode / CH Low	Temp. & Humidity	30°C, 52%

966 Chamber_B at 3Meter / Horizontal									
Frequency (MHz)	Reading-PK (dBuV)	Reading-AV (dBuV)	Correction Factor (dB/m)	Result-PK (dBuV/m)	Result-AV (dBuV/m)	Limit-PK (dBuV/m)	Limit-AV (dBuV/m)	Margin (dB)	Remark
1188.00	49.10	---	-2.89	46.22	---	74.00	54.00	-7.78	Peak
1570.00	48.46	---	-2.24	46.22	---	74.00	54.00	-7.78	Peak
2886.00	42.65	---	3.79	46.44	---	74.00	54.00	-7.56	Peak
3975.00	40.83	---	5.79	46.62	---	74.00	54.00	-7.38	Peak
4800.00	40.44	---	8.03	48.47	---	74.00	54.00	-5.53	Peak
6420.00	39.27	---	12.03	51.31	---	74.00	54.00	-2.69	Peak

966 Chamber_B at 3Meter / Vertical									
Frequency (MHz)	Reading-PK (dBuV)	Reading-AV (dBuV)	Correction Factor (dB/m)	Result-PK (dBuV/m)	Result-AV (dBuV/m)	Limit-PK (dBuV/m)	Limit-AV (dBuV/m)	Margin (dB)	Remark
1570.00	47.40	---	-2.24	45.16	---	74.00	54.00	-8.84	Peak
2000.00	45.19	---	1.82	47.01	---	74.00	54.00	-6.99	Peak
2660.00	44.24	---	3.22	47.45	---	74.00	54.00	-6.55	Peak
4230.00	41.53	---	6.57	48.10	---	74.00	54.00	-5.90	Peak
4800.00	40.67	---	8.03	48.70	---	74.00	54.00	-5.30	Peak
6300.00	39.58	---	11.68	51.26	---	74.00	54.00	-2.74	Peak

Remark:

1. Measuring frequencies from 1 GHz to the 10th harmonic of highest fundamental frequency.
2. Average test would be performed if the peak result were greater than the average limit.
3. Data of measurement within this frequency range shown " --- " in the table above means the reading of emissions are attenuated more than 20dB below the permissible limits or the field strength is too small to be measured.
4. Measurements above show only up to 6 maximum emissions noted, or would be lesser, with " N/A " remark, if no specific emissions from the EUT are recorded (ie: margin>20dB from the applicable limit) and considered that's already beyond the background noise floor.
5. Result = Reading + Correction Factor
Margin = Result - Limit
Remark Peak = Result(PK) - Limit(PK)
Remark AVG = Result(AV) - Limit(AV)



Product Name	wrist watch	Test By	Audi Chang
Test Model	Modern	Test Date	2015/04/14
Test Mode	Bluetooth 4.0 / TX Mode / CH Middle	Temp. & Humidity	30°C, 52%

966 Chamber_B at 3Meter / Horizontal									
Frequency (MHz)	Reading-PK (dBuV)	Reading-AV (dBuV)	Correction Factor (dB/m)	Result-PK (dBuV/m)	Result-AV (dBuV/m)	Limit-PK (dBuV/m)	Limit-AV (dBuV/m)	Margin (dB)	Remark
1180.00	49.13	---	-2.89	46.24	---	74.00	54.00	-7.76	Peak
1570.00	48.52	---	-2.24	46.28	---	74.00	54.00	-7.72	Peak
2934.00	42.86	---	3.91	46.78	---	74.00	54.00	-7.22	Peak
3705.00	41.56	---	5.05	46.61	---	74.00	54.00	-7.39	Peak
4875.00	38.09	---	8.18	46.27	---	74.00	54.00	-7.73	Peak
6015.00	38.71	---	10.84	49.56	---	74.00	54.00	-4.44	Peak

966 Chamber_B at 3Meter / Vertical									
Frequency (MHz)	Reading-PK (dBuV)	Reading-AV (dBuV)	Correction Factor (dB/m)	Result-PK (dBuV/m)	Result-AV (dBuV/m)	Limit-PK (dBuV/m)	Limit-AV (dBuV/m)	Margin (dB)	Remark
1574.00	47.62	---	-2.20	45.41	---	74.00	54.00	-8.59	Peak
2000.00	45.96	---	1.82	47.78	---	74.00	54.00	-6.22	Peak
2662.00	43.95	---	3.22	47.17	---	74.00	54.00	-6.83	Peak
3960.00	41.24	---	5.75	46.99	---	74.00	54.00	-7.01	Peak
4875.00	39.81	---	8.18	47.99	---	74.00	54.00	-6.01	Peak
6420.00	38.89	---	12.03	50.92	---	74.00	54.00	-3.08	Peak

Remark:

1. Measuring frequencies from 1 GHz to the 10th harmonic of highest fundamental frequency.
2. Average test would be performed if the peak result were greater than the average limit.
3. Data of measurement within this frequency range shown " --- " in the table above means the reading of emissions are attenuated more than 20dB below the permissible limits or the field strength is too small to be measured.
4. Measurements above show only up to 6 maximum emissions noted, or would be lesser, with " N/A " remark, if no specific emissions from the EUT are recorded (ie: margin>20dB from the applicable limit) and considered that's already beyond the background noise floor.
5. Result = Reading + Correction Factor
 Margin = Result - Limit
 Remark Peak = Result(PK) - Limit(PK)
 Remark AVG = Result(AV) - Limit(AV)



Product Name	wrist watch	Test By	Audi Chang
Test Model	Modern	Test Date	2015/04/14
Test Mode	Bluetooth 4.0 / TX Mode / CH High	Temp. & Humidity	30°C, 52%

966 Chamber_B at 3Meter / Horizontal

Frequency (MHz)	Reading-PK (dBuV)	Reading-AV (dBuV)	Correction Factor (dB/m)	Result-PK (dBuV/m)	Result-AV (dBuV/m)	Limit-PK (dBuV/m)	Limit-AV (dBuV/m)	Margin (dB)	Remark
1186.00	48.65	---	-2.89	45.76	---	74.00	54.00	-8.24	Peak
2054.00	45.23	---	1.93	47.15	---	74.00	54.00	-6.85	Peak
2876.00	42.35	---	3.77	46.12	---	74.00	54.00	-7.88	Peak
4965.00	39.85	---	8.37	48.21	---	74.00	54.00	-5.79	Peak
5550.00	39.44	---	9.46	48.90	---	74.00	54.00	-5.10	Peak
6390.00	39.28	---	11.95	51.23	---	74.00	54.00	-2.77	Peak

966 Chamber_B at 3Meter / Vertical

Frequency (MHz)	Reading-PK (dBuV)	Reading-AV (dBuV)	Correction Factor (dB/m)	Result-PK (dBuV/m)	Result-AV (dBuV/m)	Limit-PK (dBuV/m)	Limit-AV (dBuV/m)	Margin (dB)	Remark
1570.00	48.31	---	-2.24	46.07	---	74.00	54.00	-7.93	Peak
2000.00	45.59	---	1.82	47.41	---	74.00	54.00	-6.59	Peak
2668.00	43.89	---	3.24	47.13	---	74.00	54.00	-6.87	Peak
4485.00	41.02	---	7.36	48.39	---	74.00	54.00	-5.61	Peak
4965.00	40.14	---	8.37	48.51	---	74.00	54.00	-5.49	Peak
7440.00	37.68	---	13.49	51.17	---	74.00	54.00	-2.83	Peak

Remark:

1. Measuring frequencies from 1 GHz to the 10th harmonic of highest fundamental frequency.
2. Average test would be performed if the peak result were greater than the average limit.
3. Data of measurement within this frequency range shown " --- " in the table above means the reading of emissions are attenuated more than 20dB below the permissible limits or the field strength is too small to be measured.
4. Measurements above show only up to 6 maximum emissions noted, or would be lesser, with " N/A " remark, if no specific emissions from the EUT are recorded (ie: margin>20dB from the applicable limit) and considered that's already beyond the background noise floor.
5. Result = Reading + Correction Factor
Margin = Result - Limit
Remark Peak = Result(PK) - Limit(PK)
Remark AVG = Result(AV) - Limit(AV)



Restricted Band Edges

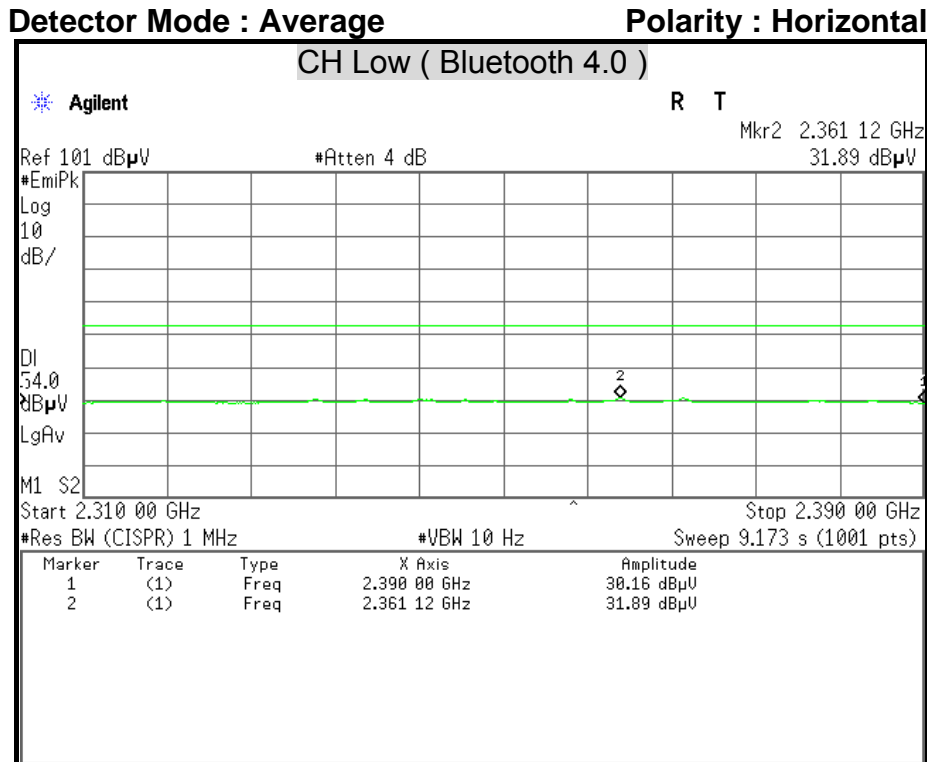
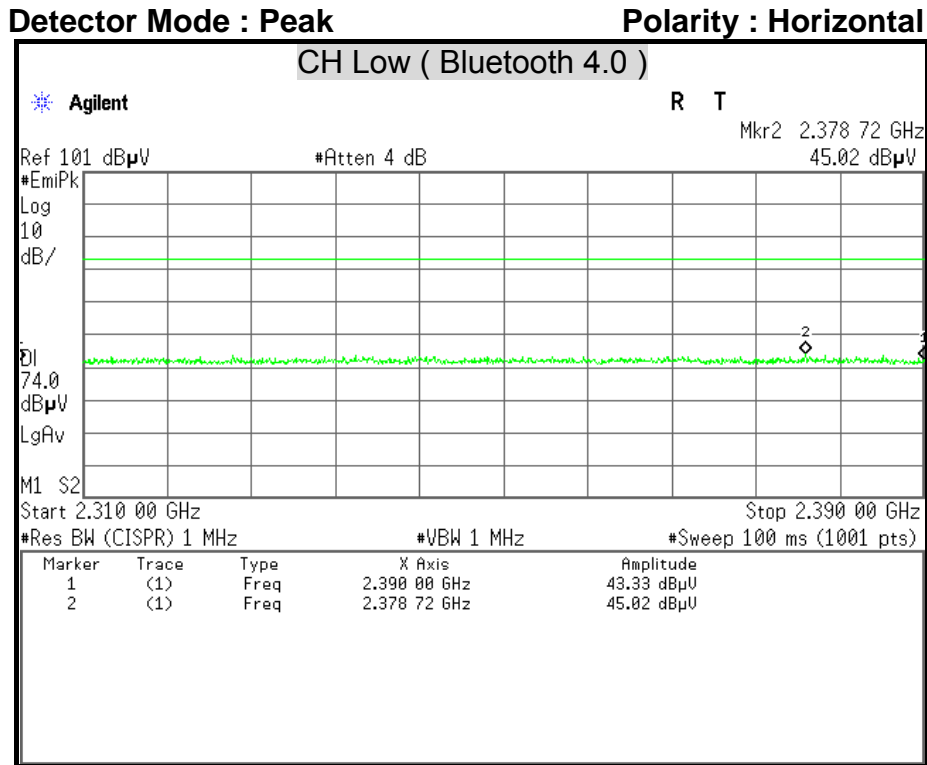



Detector Mode : Peak

Polarity : Vertical

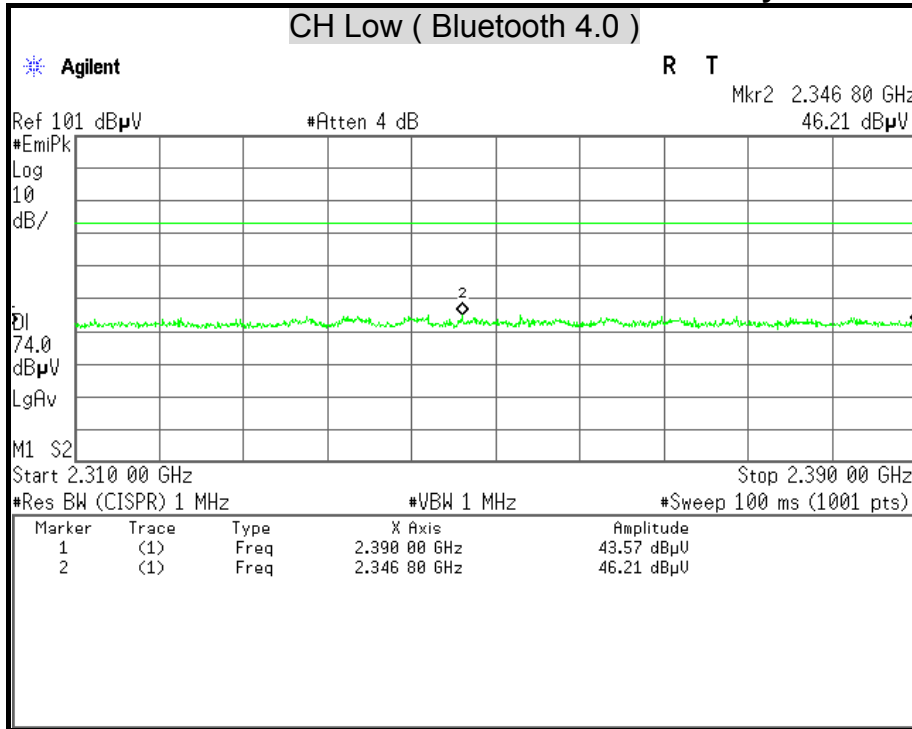

Detector Mode : Average

Polarity : Vertical

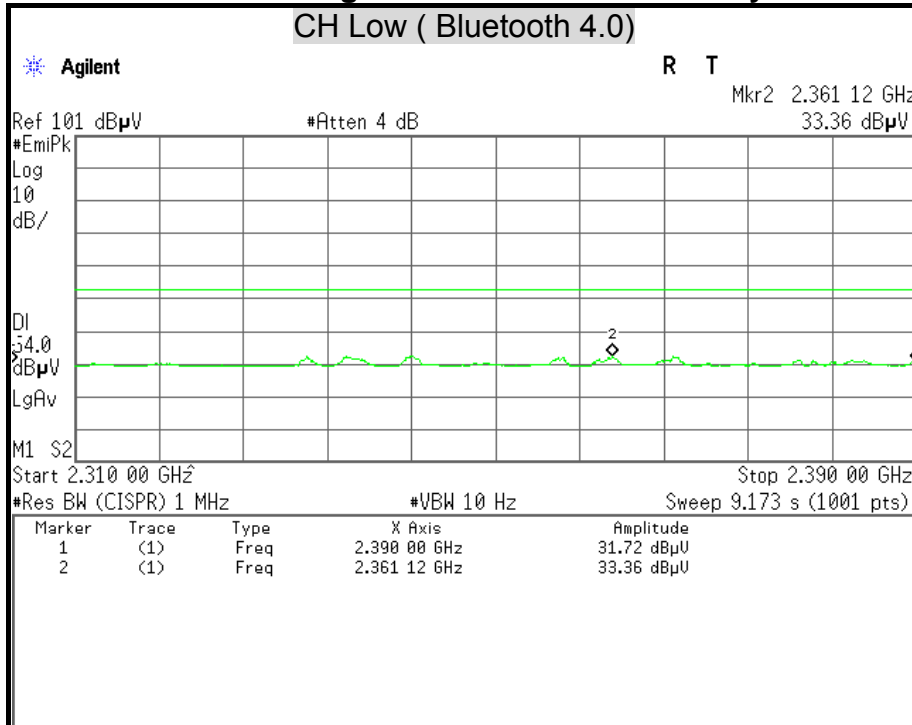



Detector Mode : Peak

Polarity : Horizontal

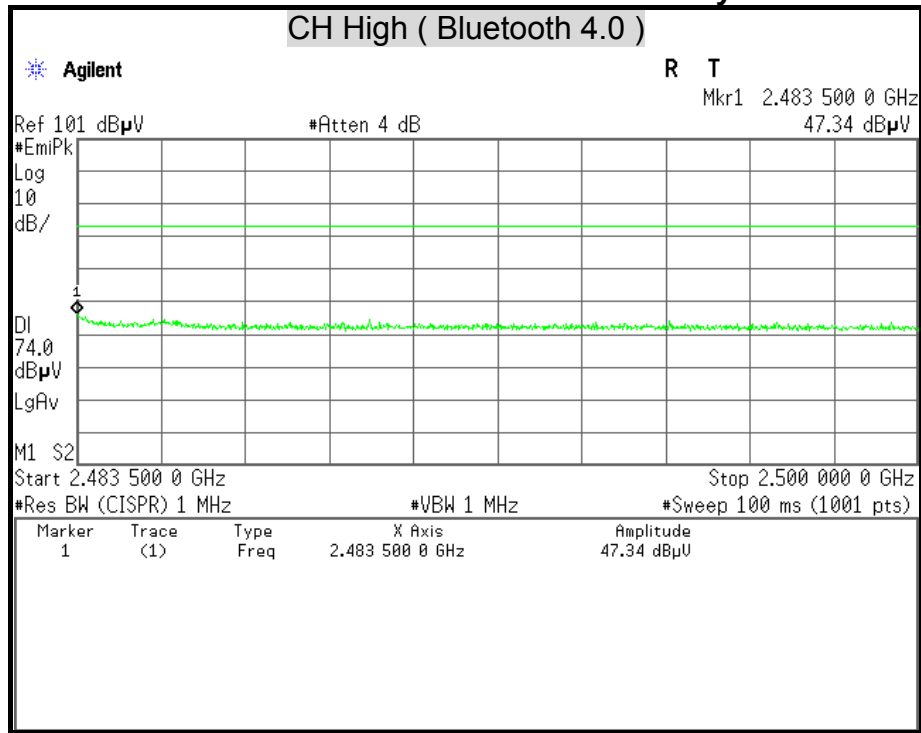

Detector Mode : Average

Polarity : Horizontal

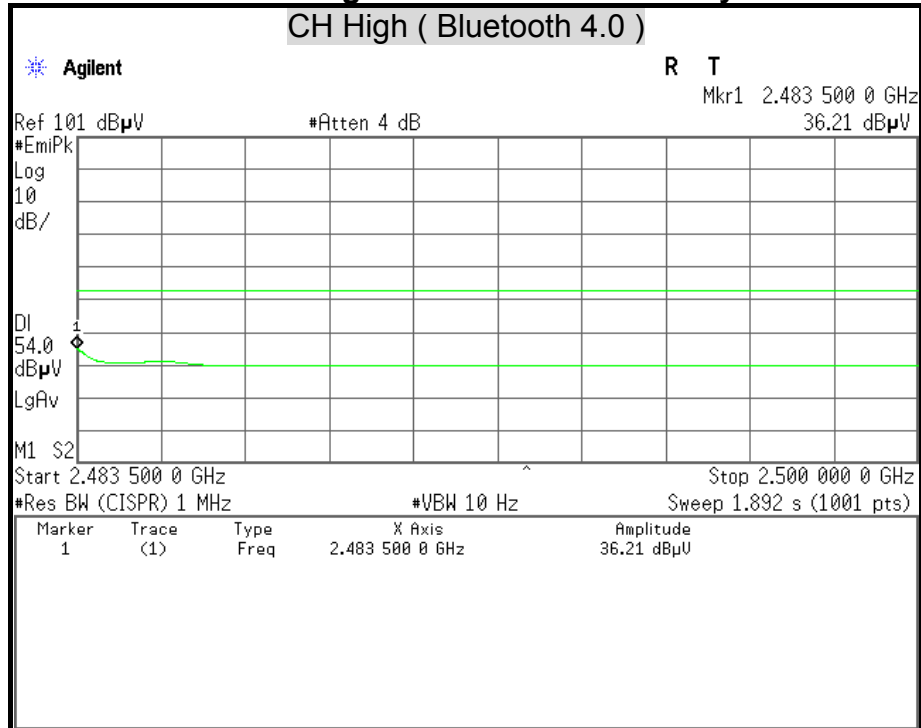



Detector Mode : Peak

Polarity : Vertical

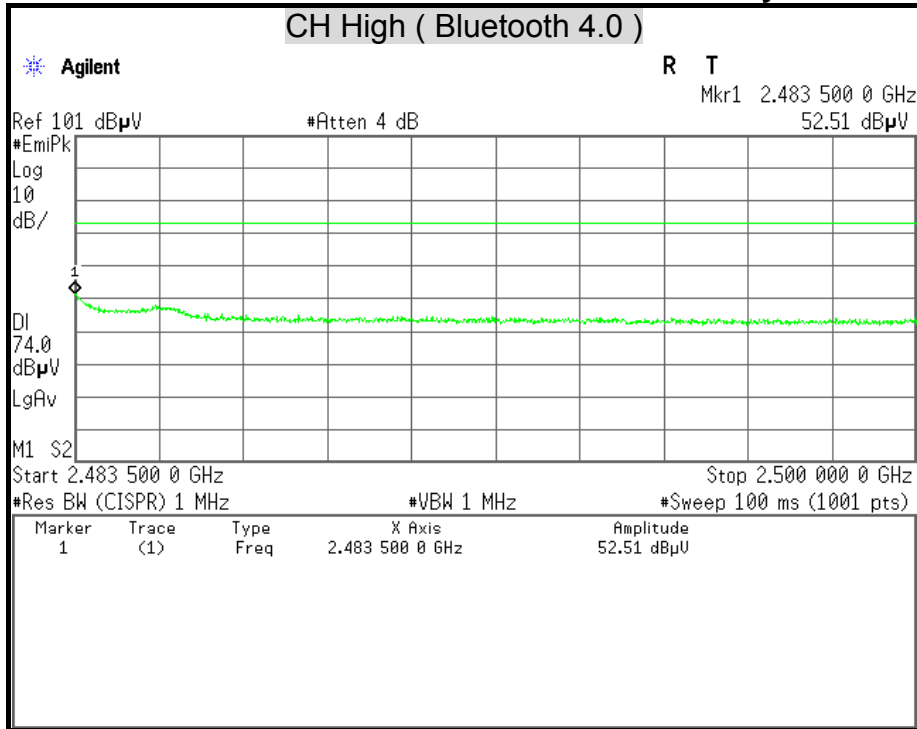

Detector Mode : Average

Polarity : Vertical

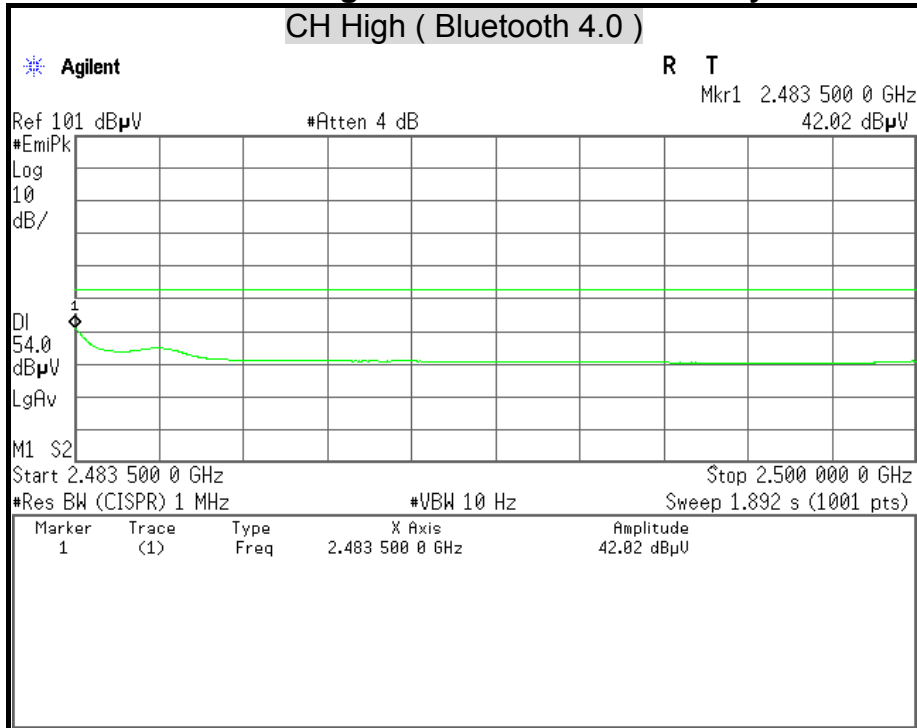



7.7 CONDUCTED EMISSION

LIMITS

§ 15.207 (a) Except as shown in paragraph (b) and (c) this section, for an intentional radiator that is designed to be connected to the public utility (AC) power line, the radio frequency voltage that is conducted back onto the AC power line on any frequency or frequencies within the band 150 kHz to 30 MHz shall not exceed the limits in the following table, as measured using a 50 μ H/50 ohms line impedance stabilization network (LISN). Compliance with the provisions of this paragraph shall be based on the measurement of the radio frequency voltage between each power line and ground at the power terminal. The lower limit applies at the boundary between the frequency ranges.

Frequency Range (MHz)	Conducted Limit (dB μ v)	
	Quasi-peak	Average
0.15 - 0.50	66 to 56	56 to 46
0.50 - 5.00	56	46
5.00 - 30.0	60	50

TEST EQUIPMENT

Name of Equipment	Manufacturer	Model	Serial Number	Calibration Due
L.I.S.N	SCHWARZBECK	NSLK 8127	8127465	08/06/2015
L.I.S.N	SCHWARZBECK	NSLK 8127	8127473	03/09/2016
EMI Test Receiver	ROHDE & SCHWARZ	ESHS 30	838550/003	11/02/2015
Pulse Limiter	ROHDE & SCHWARZ	ESH3-Z2	100111	06/30/2015

Remark: Each piece of equipment is scheduled for calibration once a year.



TEST SETUP

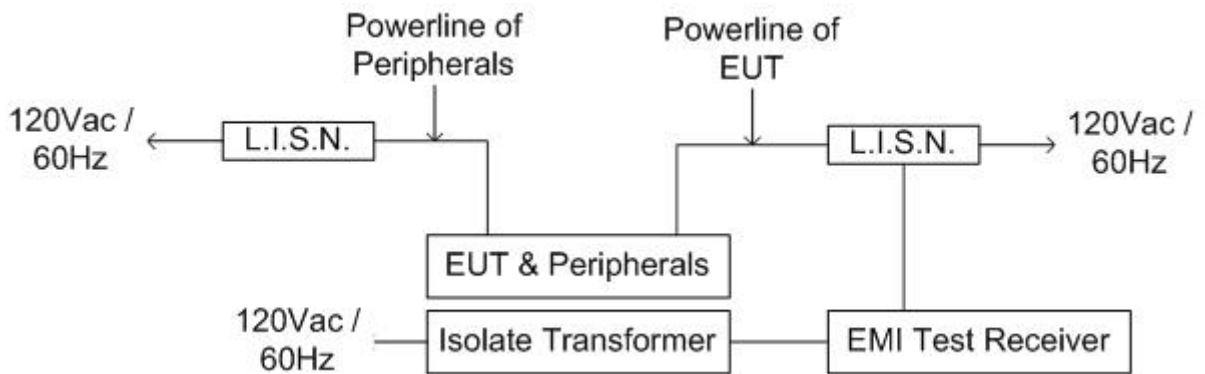
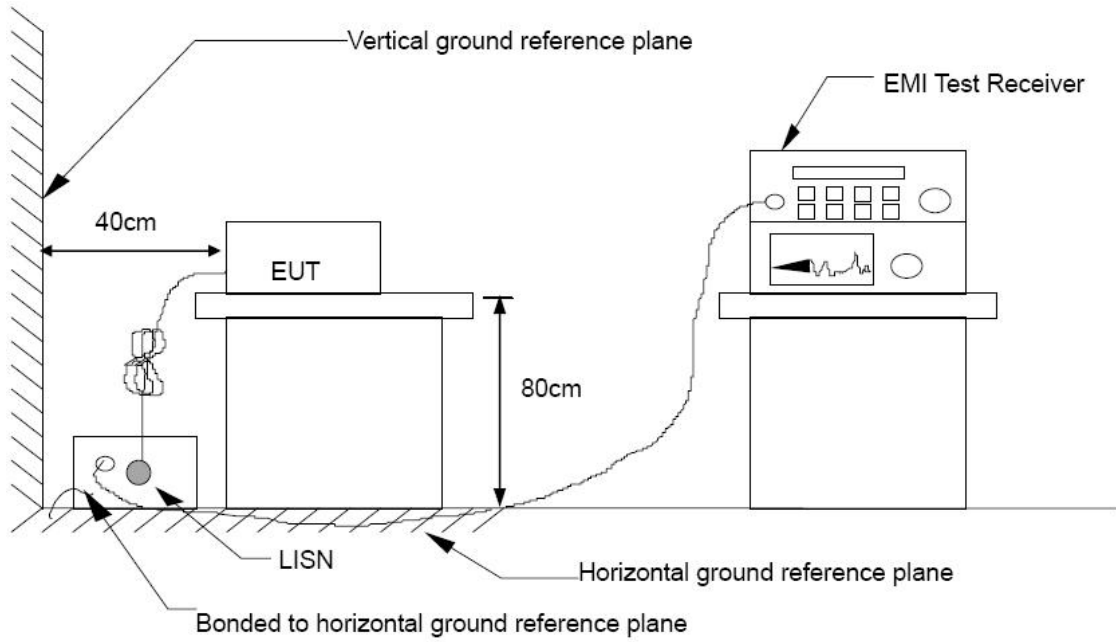



TEST PROCEDURE

The basic test procedure was in accordance with ANSI C63.10:2009.

The test procedure is performed in a 4m × 3m × 2.4m (L×W×H) shielded room.

The EUT along with its peripherals were placed on a 1.0m (W) × 1.5m (L) and 0.8m in height wooden table and the EUT was adjusted to maintain a 0.4 meter space from a vertical reference plane.

The EUT was connected to power mains through a line impedance stabilization network (LISN) which provides 50 ohm coupling impedance for measuring instrument and the chassis ground was bounded to the horizontal ground plane of shielded room. All peripherals were connected to the second LISN and the chassis ground also bounded to the horizontal ground plane of shielded room.

The EUT was located so that the distance between the boundary of the EUT and the closest surface of the LISN is 0.8 m. Where a mains flexible cord was provided by the manufacturer shall be 1 m long, or if in excess of 1 m, the excess cable was folded back and forth as far as possible so as to form a bundle not exceeding 0.4 m in length.

TEST RESULTS

Since the EUT is powered by Battery Powered, this test item is not applicable.