

---

# FCC Test Report

---

Report No.: AGC04411150401FE03

**FCC ID** : 2AEN52033202  
**APPLICATION PURPOSE** : Original Equipment  
**PRODUCT DESIGNATION** : Boston  
**BRAND NAME** : URBANISTA  
**MODEL NAME** : 2033202  
**CLIENT** : Urbanista AB  
**DATE OF ISSUE** : Apr.29,2015  
**STANDARD(S)** : FCC Part 15 Rules  
**TEST PROCEDURE(S)**  
**REPORT VERSION** : V1.0

Attestation of Global Compliance (Shenzhen) Co., Ltd



**CAUTION:**

This report shall not be reproduced except in full without the written permission of the test laboratory and shall not be quoted out of context.



### Report Revise Record

Report Version	Revise Time	Issued Date	Valid Version	Notes
V1.0	/	Apr.29,2015	Valid	Original Report

## TABLE OF CONTENTS

<b>1. VERIFICATION OF CONFORMITY .....</b>	<b>4</b>
<b>2. GENERAL INFORMATION .....</b>	<b>5</b>
2.1. PRODUCT DESCRIPTION .....	5
2.2. TABLE OF CARRIER FREQUENCYS .....	5
<b>3. MEASUREMENT UNCERTAINTY.....</b>	<b>7</b>
<b>4. DESCRIPTION OF TEST MODES.....</b>	<b>7</b>
<b>5. SYSTEM TEST CONFIGURATION .....</b>	<b>8</b>
5.1. CONFIGURATION OF EUT SYSTEM.....	8
5.2. EQUIPMENT USED IN EUT SYSTEM.....	8
5.3. SUMMARY OF TEST RESULTS.....	8
<b>6. TEST FACILITY .....</b>	<b>9</b>
<b>7 ALL TEST EQUIPMENT LIST .....</b>	<b>9</b>
<b>8. RADIATED EMISSION .....</b>	<b>10</b>
8.1TEST LIMIT.....	10
8.2. MEASUREMENT PROCEDURE.....	11
8.3. TEST SETUP.....	13
8.4. TEST RESULT(Worst modulation:GFSK).....	15
<b>9. BAND EDGE EMISSION .....</b>	<b>41</b>
9.1. MEASUREMENT PROCEDURE.....	41
9.2 TEST SETUP.....	41
9.3 RADIATED TEST RESULT(Worst modulation:GFSK) .....	42
<b>10. 20DB BANDWIDTH.....</b>	<b>50</b>
10.1. MEASUREMENT PROCEDURE.....	50
10.2. TEST SET-UP (BLOCK DIAGRAM OF CONFIGURATION) .....	50
10.3. LIMITS AND MEASUREMENT RESULTS.....	50
<b>11. FCC LINE CONDUCTED EMISSION TEST .....</b>	<b>59</b>
11.1. LIMITS OF LINE CONDUCTED EMISSION TEST .....	59
11.2. BLOCK DIAGRAM OF LINE CONDUCTED EMISSION TEST .....	59
11.3. PRELIMINARY PROCEDURE OF LINE CONDUCTED EMISSION TEST .....	60
11.4. FINAL PROCEDURE OF LINE CONDUCTED EMISSION TEST .....	60
11.5. TEST RESULT OF LINE CONDUCTED EMISSION TEST .....	61
<b>APPENDIX A: PHOTOGRAPHS OF TEST SETUP .....</b>	<b>65</b>
<b>APPENDIX B: PHOTOGRAPHS OF EUT .....</b>	<b>66</b>

## 1. VERIFICATION OF CONFORMITY

<b>Applicant</b>	Urbanista AB
<b>Address</b>	Runebergsgatan 6, SE-114 29 Stockholm, Sweden
<b>Manufacturer</b>	Dongguan Excellent Electronic Technologies CO., LTD.
<b>Address</b>	No. 1 Zhenxing Dong RD., Liujia Industrial Park, Hengli Town, Dongguan, China
<b>Product Designation</b>	Boston
<b>Brand Name</b>	URBANISTA
<b>Test Model</b>	2033202
<b>Date of test</b>	Apr.27,2015 to Apr.28,2015
<b>Deviation</b>	None
<b>Condition of Test Sample</b>	Normal
<b>Report Template</b>	AGCRT-US-BR/RF

We hereby certify that:

The above equipment was tested by Compliance Certification Service(Shenzhen) Inc. The test data, data evaluation, test procedures, and equipment configurations shown in this report were made in accordance with the procedures given in ANSI C63.4 (2009) and the energy emitted by the sample EUT tested as described in this report is in compliance with radiated emission limits of FCC Rules Part 15.249.

Prepared By

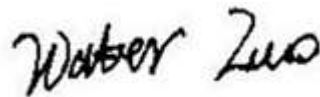

Water Zuo      Apr.29,2015

Checked By



Forrest Lei      Apr.29,2015

Authorized By



Solger Zhang      Apr.29,2015

## 2. GENERAL INFORMATION

### 2.1. PRODUCT DESCRIPTION

A major technical description of EUT is described as following

<b>Operation Frequency</b>	2.402 GHz to 2.480GHz
<b>RF Output Power</b>	4.03dBm(Max)
<b>Bluetooth Version</b>	V4.0
<b>Modulation</b>	GFSK, $\pi$ /4-DQPSK, 8DPSK
<b>Number of channels</b>	79 for traditional BT 40 for BLE
<b>Hardware Version</b>	V3.0
<b>Software Version</b>	V3.0
<b>Antenna Designation</b>	Ceramic Antenna (Met 15.203 Antenna requirement)
<b>Antenna Gain</b>	1dBi
<b>Power Supply</b>	DC 3.7V by battery
Note: The USB port only used for charging and can't be used to transfer data with PC.	

### 2.2. TABLE OF CARRIER FREQUENCIES

Traditional Bluetooth channel List

Frequency Band	Channel Number	Frequency
2400~2483.5MHZ	0	2402MHZ
	1	2403MHZ
	:	:
	38	2440 MHZ
	39	2441 MHZ
	40	2442 MHZ
	:	:
	77	2479 MHZ
	78	2480 MHZ

BLE Channel List

Frequency Band	Channel Number	Frequency
2400~2483.5MHZ	0	2402MHZ
	1	2404MHZ
	:	:
	38	2478 MHZ
	39	2480 MHZ

### 3. MEASUREMENT UNCERTAINTY

The reported uncertainty of measurement  $y \pm U$ , where expanded uncertainty  $U$  is based on a standard uncertainty multiplied by a coverage factor of  $k=2$ , providing a level of confidence of approximately 95 %.

No.	Item	Uncertainty
1	Conducted Emission Test	$\pm 3.18$ dB
2	All emissions, radiated	$\pm 3.91$ dB
3	Temperature	$\pm 0.5$ °C
4	Humidity	$\pm 2$ %

### 4. DESCRIPTION OF TEST MODES

NO.	TEST MODE DESCRIPTION
1	Low channel GFSK
2	Middle channel GFSK
3	High channel GFSK
4	Low channel $\pi/4$ -DQPSK
5	Middle channel $\pi/4$ -DQPSK
6	High channel $\pi/4$ -DQPSK
7	Low channel 8DPSK
8	Middle channel 8DPSK
9	High channel 8DPSK
10	Normal operation (BT)

Note:

1. All the test modes can be supply by battery, only the result of the worst case was recorded in the report, if no other cases.
2. For Radiated Emission, 3axis were chosen for testing for each applicable mode.

## 5. SYSTEM TEST CONFIGURATION

### 5.1. CONFIGURATION OF EUT SYSTEM

Configure 1: (Normal hopping)

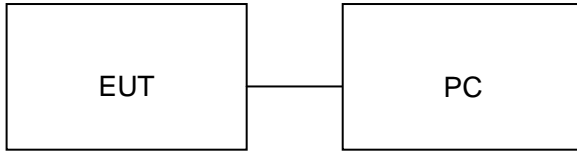

Configure 2: (Control continuous TX)

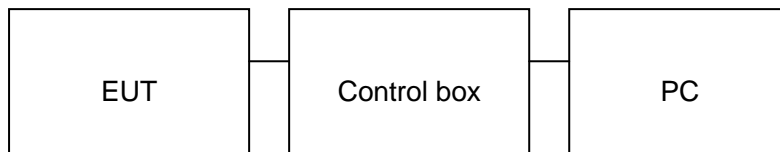

### 5.2. EQUIPMENT USED IN EUT SYSTEM

Item	Equipment	Model No.	ID or Specification	Remark
1	Boston	URBANISTA	2AEN52033202	EUT
2	PC	Dell	INSPIRON	A.E
3	Control box	N/A	N/A	A.E

### 5.3. SUMMARY OF TEST RESULTS

FCC RULES	DESCRIPTION OF TEST	RESULT
§15.249	Radiated Emission	Compliant
§15.249	Band Edges	Compliant
§15.207	Conduction Emission	Compliant



## 6. TEST FACILITY

<b>Site</b>	Compliance Certification Service(Shenzhen) Inc.
<b>Location</b>	No.10-1 Mingkeda Logistics Park, No.18 Huanguan South RD. Guan lan Town,Baoan Distr
<b>FCC Registration No.</b>	441872
<b>Description</b>	The test site is constructed and calibrated to meet the FCC requirements in documents ANSI C63.4:2009.

## 7 ALL TEST EQUIPMENT LIST

### Radiation Test equipment

Kind of Equipment	Manufacturer	Type No.	Serial No.	Last calibration	Calibrated until
Spectrum Analyzer	Agilent	E4407B	MY50140340	2014.10.25	2015.10.24
Test Receiver	R&S	ESCI	101427	2014.10.25	2015.10.24
Bilog Antenna	TESEQ	CBL6111D	34678	2014.10.27	2015.10.26
50Ω Coaxial Switch	Anritsu	MP59B	6200264416	2014.06.06	2015.06.06
Horn Antenna	R&S	9120D	152265	2014.10.27	2015.10.26
Horn Ant	Schwarzbeck	BBHA 9170	9170-181	2014.07.06	2015.07.05
Amplifier	EM	EM-30180	060538	2014.12.22	2015.12.21
Loop Antenna	ARA	PLA-1030/B	1029	2014.06.08	2015.06.07
Power Meter	Anritsu	ML2495A	1204003	2014.10.25	2015.10.24
Power Sensor	Anritsu	MA2411B	100309	2014.10.25	2015.10.24

### Conduction Test equipment

Kind of Equipment	Manufacturer	Type No.	Serial No.	Last calibration	Calibrated until
Test Receiver	R&S	102086	102086	2014.10.25	2015.10.24
LISN	R&S	ENV216	101242	2014.10.25	2015.10.24
LISN	EMCO	3810/2NM	000-23625	2014.10.25	2015.10.24
50Ω Coaxial Switch	Anritsu	MP59B	6200264417	2014.06.06	2015.06.06
Passive Voltage Probe	R&S	ESH2-Z3	100196	2014.06.06	2015.06.06
Absorbing clamp	R&S	MDS-21	100668	2014.10.27	2015.10.26

## 8. RADIATED EMISSION

### 8.1 TEST LIMIT

#### Standard FCC15.249

Fundamental Frequency	Field Strength of Fundamental (millivolts/meter)	Field Strength of Harmonics (microvolts/meter)
900-928MHz	50	500
2400-2483.5MHz	50	500
5725-5875MHz	50	500
24.0-24.25GHz	250	2500

#### Standard FCC 15.209

Frequency (MHz)	Distance Meters	Field Strengths Limit	
		$\mu$ V/m	dB( $\mu$ V)/m
0.009 ~ 0.490	300	2400/F(kHz)	---
0.490 ~ 1.705	30	24000/F(kHz)	---
1.705 ~ 30	30	30	---
30 ~ 88	3	100	40.0
88 ~ 216	3	150	43.5
216 ~ 960	3	200	46.0
960 ~ 1000	3	500	54.0
Above 1000	3	Other:74.0 dB( $\mu$ V)/m (Peak) 54.0 dB( $\mu$ V)/m (Average)	

Remark: (1) Emission level  $\text{dB}\mu\text{V} = 20 \log \text{Emission level } \mu\text{V/m}$   
(2) The smaller limit shall apply at the cross point between two frequency bands.  
(3) Distance is the distance in meters between the measuring instrument, antenna and the closest point of any part of the device or system.

## 8.2. MEASUREMENT PROCEDURE

1. Configure the EUT according to ANSI C63.4. The EUT was placed on the top of the turntable 0.8 meter above ground. The phase center of the receiving antenna mounted on the top of a height-variable antenna tower was placed 3 meters far away from the turntable.
2. Power on the EUT and all the supporting units. The turntable was rotated by 360 degrees to determine the position of the highest radiation.
3. The height of the broadband receiving antenna was varied between one meter and four meters above ground to find the maximum emissions field strength of both horizontal and vertical polarization.
4. For each suspected emissions, the antenna tower was scan (from 1 M to 4 M) and then the turntable was rotated (from 0 degree to 360 degrees) to find the maximum reading.
5. Set the test-receiver system to Peak or CISPR quasi-peak Detect Function with specified bandwidth under Maximum Hold Mode.
6. For emissions above 1GHz, use 1MHz VBW and RBW for peak reading. Then 1MHz RBW and 10Hz VBW for average reading in spectrum analyzer.
7. When the radiated emissions limits are expressed in terms of the average value of the emissions, and pulsed operation is employed, the measurement field strength shall be determined by averaging over one complete pulse train, including blanking intervals, as long as the pulse train does not exceed 0.1 seconds. As an alternative (provided the transmitter operates for longer than 0.1 seconds) or in cases where the pulse train exceeds 0.1 seconds, the measured field strength shall be determined from the average absolute voltage during a 0.1 second interval during which the field strength is at its maximum values.
8. If the emissions level of the EUT in peak mode was 3 dB lower than the average limit specified, then testing will be stopped and peak values of EUT will be reported, otherwise, the emissions which do not have 3 dB margin will be repeated one by one using the quasi-peak method for below 1GHz.
9. For testing above 1GHz, the emissions level of the EUT in peak mode was lower than average limit (that means the emissions level in peak mode also complies with the limit in average mode), then testing will be stopped and peak values of EUT will be reported, otherwise, the emissions will be measured in average mode again and reported.
10. In case the emission is lower than 30MHz, loop antenna has to be used for measurement and the recorded data should be QP measured by receiver. High - Low scan is not required in this case.

The following table is the setting of spectrum analyzer and receiver.

<b>Spectrum Parameter</b>	<b>Setting</b>
Start ~Stop Frequency	9KHz~150KHz/RB 200Hz for QP
Start ~Stop Frequency	150KHz~30MHz/RB 9KHz for QP
Start ~Stop Frequency	30MHz~1000MHz/RB 120KHz for QP
Start ~Stop Frequency	1GHz~26.5GHz 1MHz/1MHz for Peak, 1MHz/10Hz for Average

<b>Receiver Parameter</b>	<b>Setting</b>
Start ~Stop Frequency	9KHz~150KHz/RB 200Hz for QP
Start ~Stop Frequency	150KHz~30MHz/RB 9KHz for QP
Start ~Stop Frequency	30MHz~1000MHz/RB 120KHz for QP

### 8.3. TEST SETUP

#### Radiated Emission Test-Setup Frequency Below 30MHz

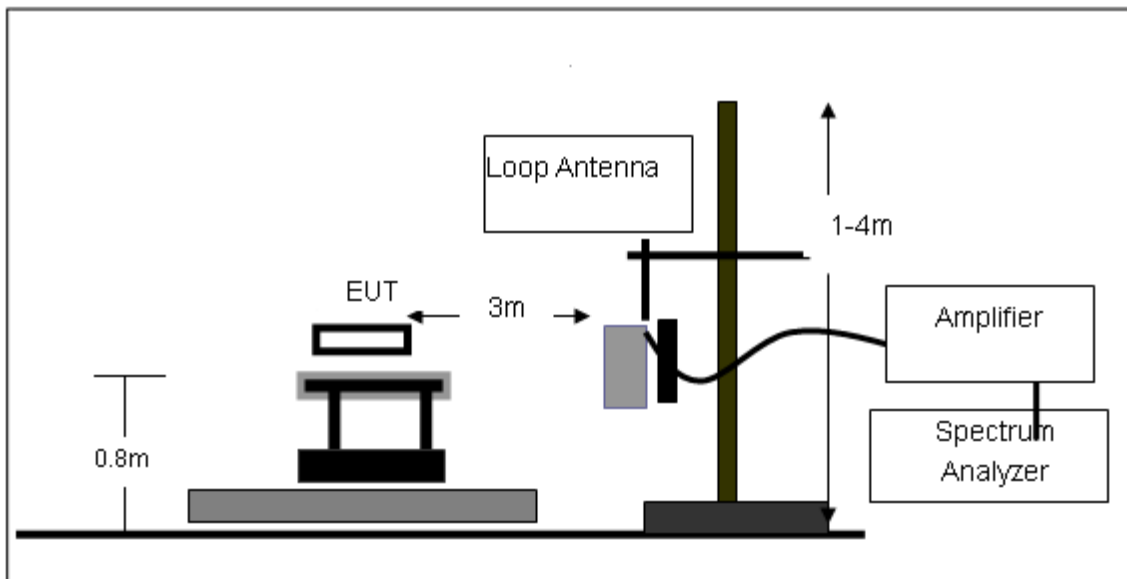

#### RADIATED EMISSION TEST SETUP 30MHz-1000MHz

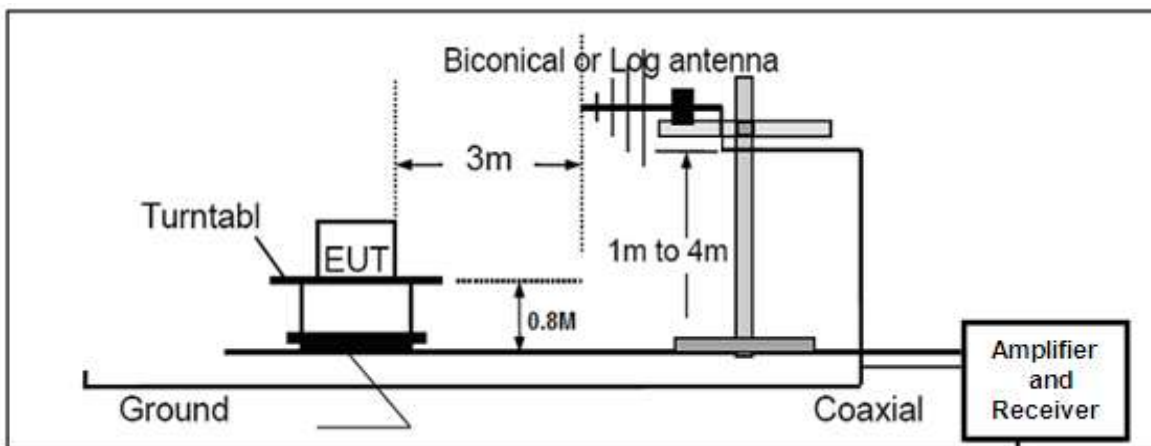

RADIATED EMISSION TEST SETUP ABOVE 1000MHz

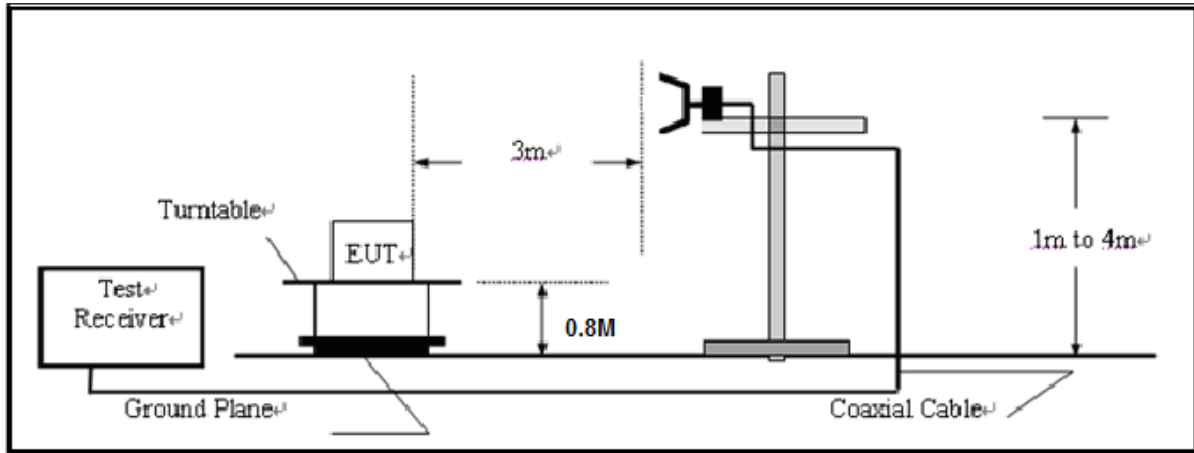

**8.4. TEST RESULT(Worst modulation:GFSK)  
FOR TRADITIONAL BLUETOOTH**

**RADIATED EMISSION BELOW 30MHZ**

No emission found between lowest internal used/generated frequencies to 30MHz.

**RADIATED EMISSION BELOW 1GHZ**

**RADIATED EMISSION TEST- (30MHZ-1GHZ)-LOW CHANNEL-HORIZONTAL**

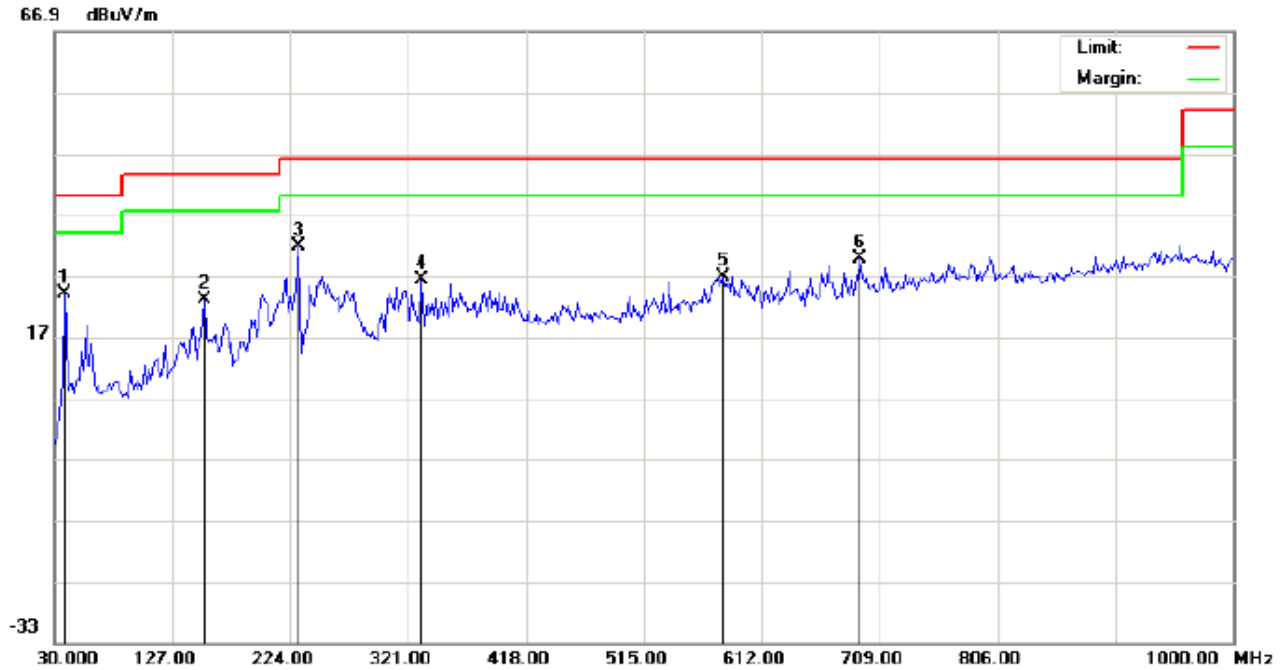

Site: site #1  
Limit: FCC Class B 3M Radiation  
EUT: Boston  
M/N: 2033202  
Mode: Low Channel TX  
Note:

Polarization: *Horizontal*  
Power:  
Distance: 3m

Temperature: 26  
Humidity: 60 %

No.	Mk	Freq.	Reading	Factor	Measurement	Limit	Over	Detector	Antenna	Table	Comment
		MHz	dBuV	dB/m	dBuV/m	dBuV/m	dB		Height	Degree	
									cm	degree	
1		38.0833	14.68	9.43	24.11	40.00	-15.89	peak			
2		152.8667	7.69	15.28	22.97	43.50	-20.53	peak			
3	*	230.4667	18.72	13.16	31.88	46.00	-14.12	peak			
4		332.3167	8.77	17.56	26.33	46.00	-19.67	peak			
5		579.6667	3.62	23.22	26.84	46.00	-19.16	peak			
6		692.8333	4.75	25.00	29.75	46.00	-16.25	peak			

**RESULT: PASS**

RADIATED EMISSION TEST- (30MHZ-1GHZ)-LOW CHANNEL -VERTICAL

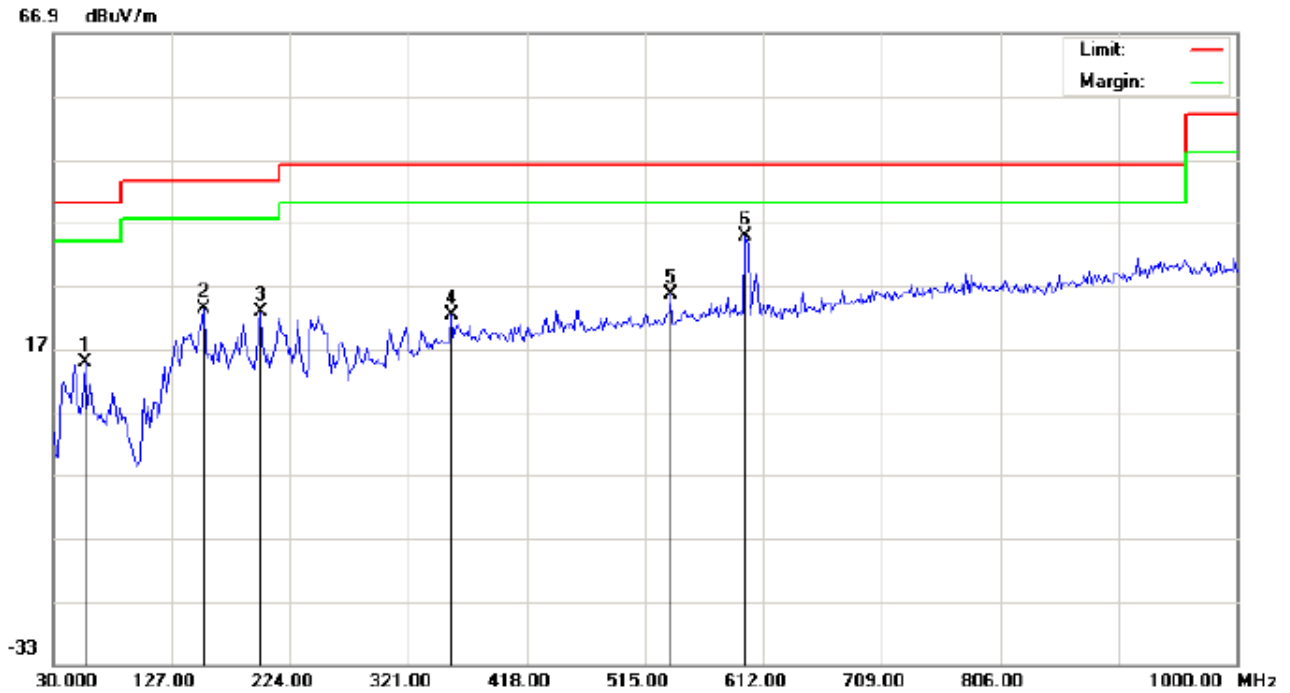

Site: site #1  
Limit: FCC Class B 3M Radiation  
EUT: Boston  
M/N: 2033202  
Mode: Low Channel TX  
Note:

Polarization: *Vertical*  
Power:  
Distance: 3m

Temperature: 26  
Humidity: 60 %

No.	Mk	Freq.	Reading	Factor	Measurement	Limit	Over	Detector	Antenna	Table	Comment
		MHz	dBuV	dB/m	dBuV/m	dBuV/m	dB		Height	Degree	
									cm	degree	
1		55.8667	6.58	8.19	14.77	40.00	-25.23	peak			
2		152.8667	8.00	15.28	23.28	43.50	-20.22	peak			
3		199.7500	13.71	9.06	22.77	43.50	-20.73	peak			
4		356.5667	3.47	18.78	22.25	46.00	-23.75	peak			
5		536.0167	3.39	22.10	25.49	46.00	-20.51	peak			
6	*	597.4500	12.04	22.72	34.76	46.00	-11.24	peak			

**RESULT: PASS**

**Note:** 1. Factor=Antenna Factor + Cable loss, Margin=Measurement-Limit.

2. The "Factor" value can be calculated automatically by software of measurement system.



RADIATED EMISSION TEST- (30MHZ-1GHZ)-MIDDLE CHANNEL-HORIZONTAL

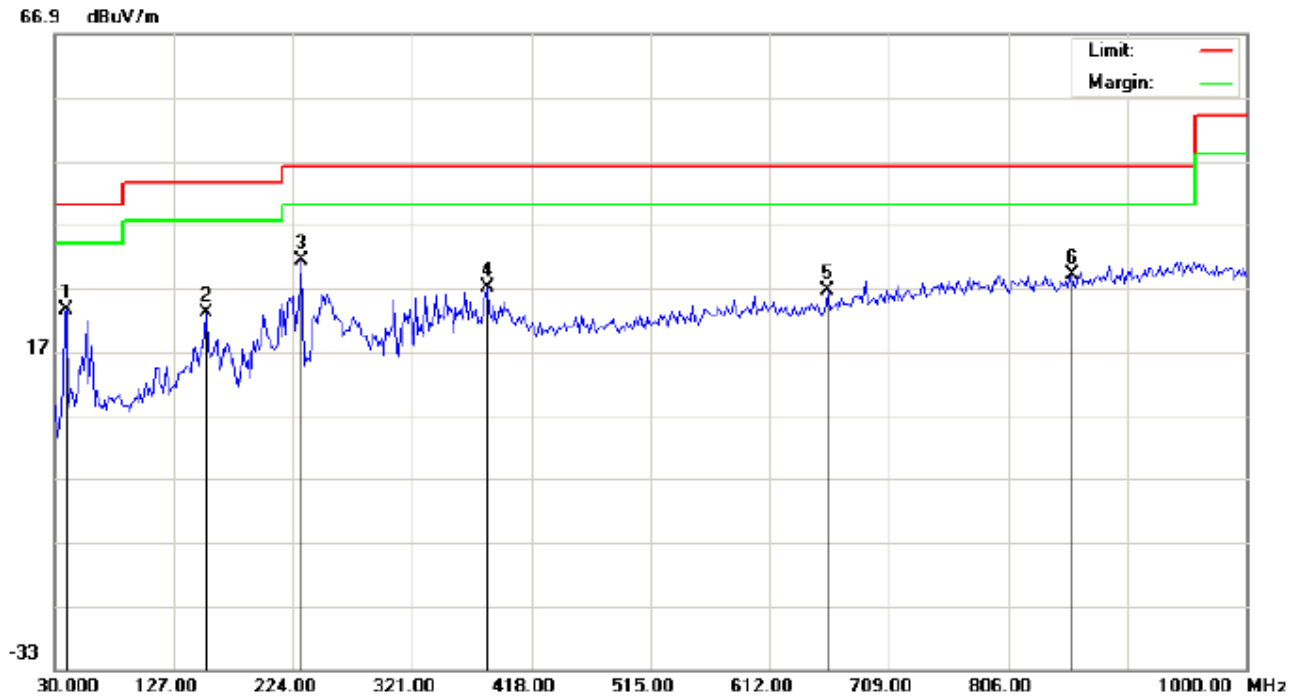

Site: site #1  
Limit: FCC Class B 3M Radiation  
EUT: Boston  
M/N: 2033202  
Mode: Middle Channel TX  
Note:

Polarization: *Horizontal*  
Power:  
Distance: 3m

Temperature: 26  
Humidity: 60 %

No.	Mk	Freq.	Reading	Factor	Measurement	Limit	Over	Detector	Antenna	Table	Comment
		MHz	dBuV	dB/m	dBuV/m	dBuV/m	dB		Height	Degree	
									cm	degree	
1		39.7000	11.92	11.51	23.43	40.00	-16.57	peak			
2		152.8667	7.86	15.28	23.14	43.50	-20.36	peak			
3	*	230.4667	18.13	13.16	31.29	46.00	-14.71	peak			
4		382.4333	8.02	18.95	26.97	46.00	-19.03	peak			
5		658.8833	2.40	24.09	26.49	46.00	-19.51	peak			
6		857.7333	1.58	27.51	29.09	46.00	-16.91	peak			

**RESULT: PASS**

RADIATED EMISSION TEST- (30MHZ-1GHZ)- MIDDLE CHANNEL -VERTICAL

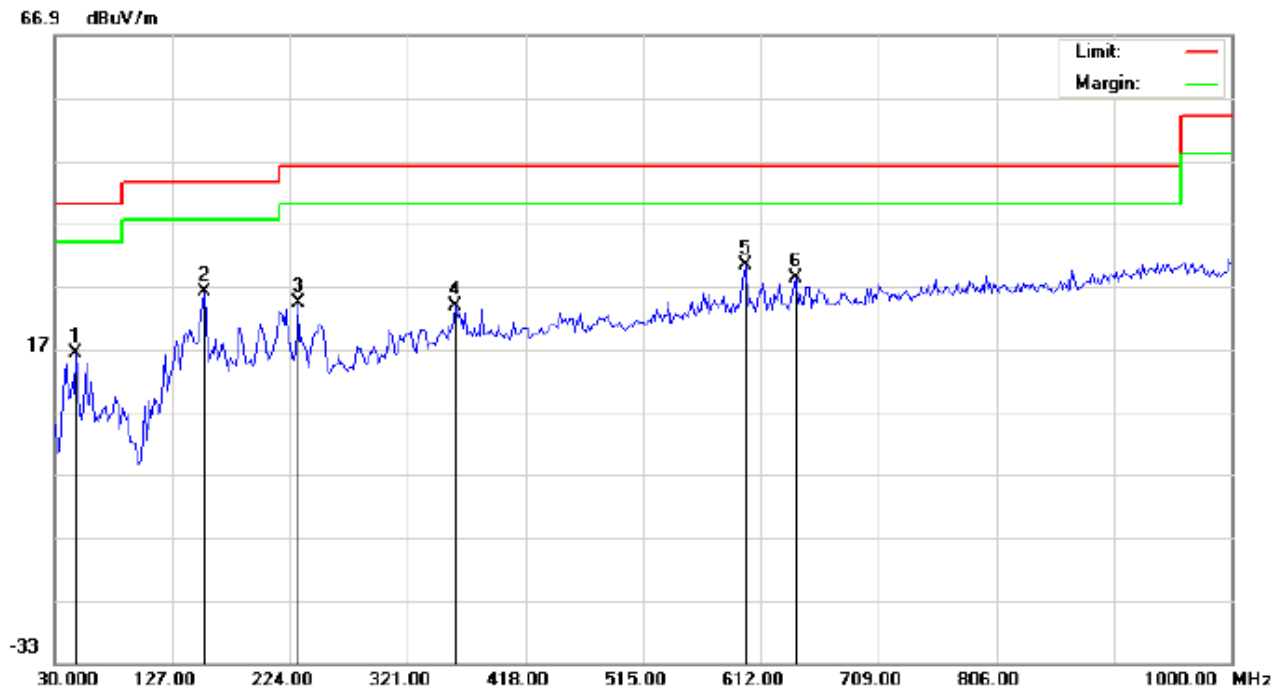

Site: site #1  
Limit: FCC Class B 3M Radiation  
EUT: Boston  
M/N: 2033202  
Mode: Middle Channel TX  
Note:

Polarization: *Vertical*  
Power:  
Distance: 3m

Temperature: 26  
Humidity: 60 %

No.	Mk	Freq.	Reading	Factor	Measurement	Limit	Over	Detector	Antenna Height	Table Degree	Comment
		MHz	dBuV	dB/m	dBuV/m	dBuV/m	dB		cm	degree	
1		47.7833	7.96	8.39	16.35	40.00	-23.65	peak			
2		152.8667	10.78	15.28	26.06	43.50	-17.44	peak			
3		230.4667	12.21	11.99	24.20	46.00	-21.80	peak			
4		359.8000	4.98	18.80	23.78	46.00	-22.22	peak			
5	*	599.0667	7.56	22.73	30.29	46.00	-15.71	peak			
6		641.1000	4.72	23.65	28.37	46.00	-17.63	peak			

**RESULT: PASS**

**Note:** 1. Factor=Antenna Factor + Cable loss, Margin=Measurement-Limit.

2. The "Factor" value can be calculated automatically by software of measurement system.

RADIATED EMISSION TEST- (30MHZ-1GHZ)-HIGH CHANNEL-HORIZONTAL

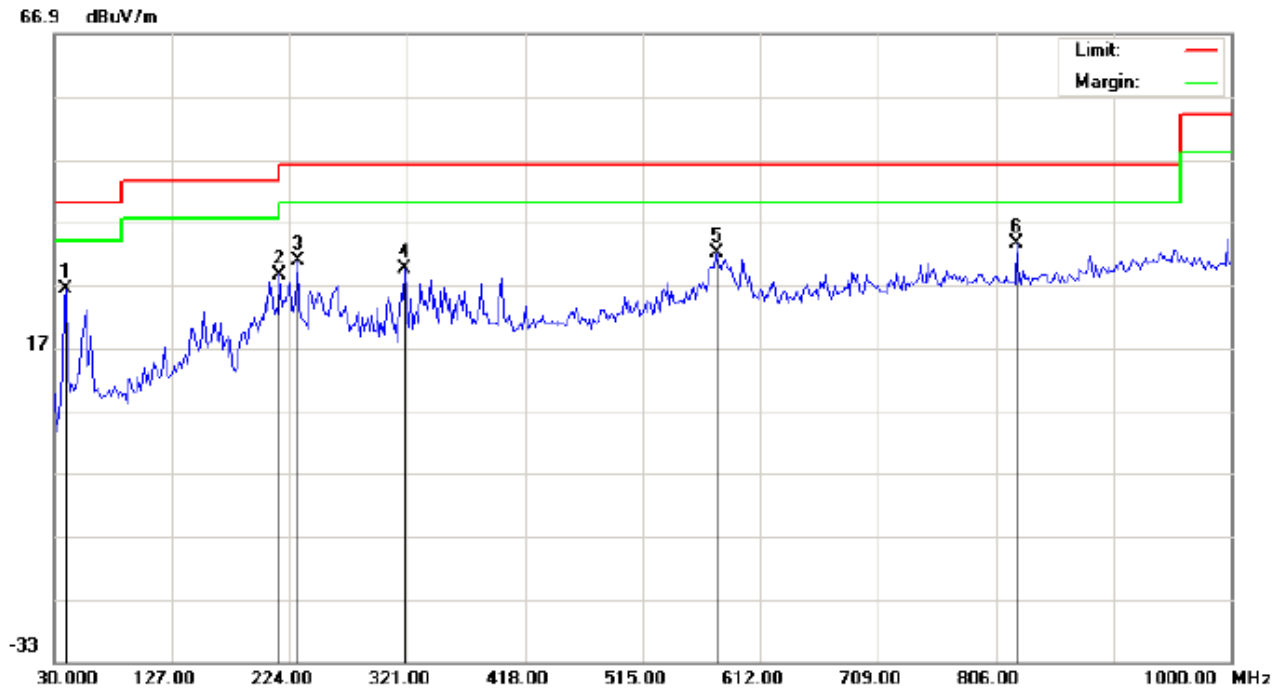

Site: site #1  
Limit: FCC Class B 3M Radiation  
EUT: Boston  
M/N: 2033202  
Mode: High Channel TX  
Note:

Polarization: *Horizontal*  
Power:  
Distance: 3m

Temperature: 26  
Humidity: 60 %

No.	Mk	Freq.	Reading	Factor	Measurement	Limit	Over	Detector	Antenna Height	Table Degree	Comment
		MHz	dBuV	dB/m	dBuV/m	dBuV/m	dB		cm	degree	
1		39.7000	14.80	11.51	26.31	40.00	-13.69	peak			
2		215.9167	15.86	12.60	28.46	43.50	-15.04	peak			
3		230.4667	17.74	13.16	30.90	46.00	-15.10	peak			
4		319.3833	12.72	16.70	29.42	46.00	-16.58	peak			
5		576.4333	8.81	23.14	31.95	46.00	-14.05	peak			
6	*	823.7833	6.27	27.32	33.59	46.00	-12.41	peak			

**RESULT: PASS**

RADIATED EMISSION TEST- (30MHZ-1GHZ)-HIGH CHANNEL -VERTICAL

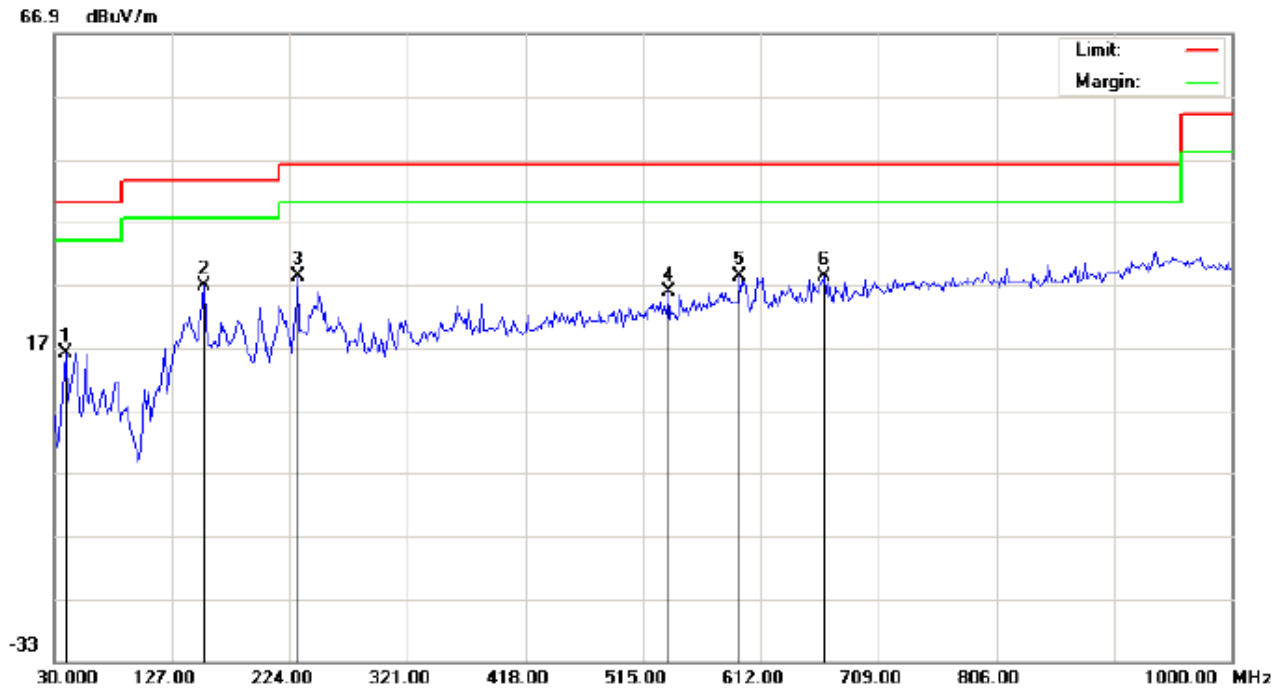

Site: site #1  
Limit: FCC Class B 3M Radiation  
EUT: Boston  
M/N: 2033202  
Mode: High Channel TX  
Note:

Polarization: *Vertical*  
Power:  
Distance: 3m

Temperature: 26  
Humidity: 60 %

No.	Mk	Freq.	Reading	Factor	Measurement	Limit	Over	Detector	Antenna Height	Table Degree	Comment
		MHz	dBuV	dB/m	dBuV/m	dBuV/m	dB		cm	degree	
1		39.7000	7.63	8.51	16.14	40.00	-23.86	peak			
2	*	152.8667	11.45	15.28	26.73	43.50	-16.77	peak			
3		230.4667	16.24	11.99	28.23	46.00	-17.77	peak			
4		536.0167	3.79	22.10	25.89	46.00	-20.11	peak			
5		594.2167	5.58	22.70	28.28	46.00	-17.72	peak			
6		663.7333	4.11	24.22	28.33	46.00	-17.67	peak			

**RESULT: PASS**

**Note:** 1. Factor=Antenna Factor + Cable loss, Margin=Measurement-Limit.

2. The "Factor" value can be calculated automatically by software of measurement system.

FOR BLE

**RADIATED EMISSION BELOW 30MHZ**

No emission found between lowest internal used/generated frequencies to 30MHz.

**RADIATED EMISSION BELOW 1GHZ**

**RADIATED EMISSION TEST- (30MHZ-1GHZ)-LOW CHANNEL-HORIZONTAL**

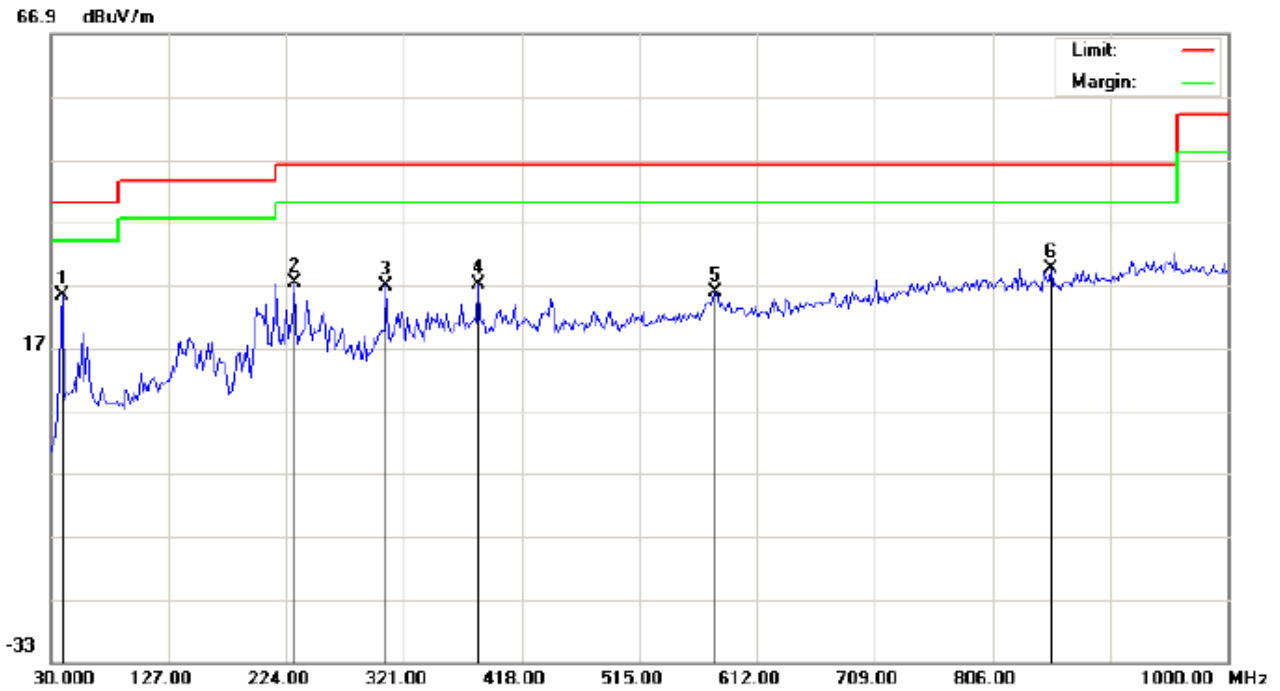

Site: site #1  
 Limit: FCC Class B 3M Radiation  
 EUT: Boston  
 M/N: 2033202  
 Mode: Low Channel TX  
 Note:

Polarization: *Horizontal*  
 Power:  
 Distance: 3m

Temperature: 26  
 Humidity: 60 %

No.	Mk	Freq.	Reading	Factor	Measurement	Limit	Over	Detector	Antenna Height	Table Degree	Comment
		MHz	dBuV	dB/m	dBuV/m	dBuV/m	dB		cm	degree	
1	*	39.7000	13.72	11.51	25.23	40.00	-14.77	peak			
2		230.4667	14.08	13.16	27.24	46.00	-18.76	peak			
3		306.4500	11.06	15.84	26.90	46.00	-19.10	peak			
4		382.4333	8.08	18.95	27.03	46.00	-18.97	peak			
5		578.0500	2.53	23.18	25.71	46.00	-20.29	peak			
6		854.5000	2.09	27.43	29.52	46.00	-16.48	peak			

**RESULT: PASS**

RADIATED EMISSION TEST- (30MHZ-1GHZ)-LOW CHANNEL -VERTICAL

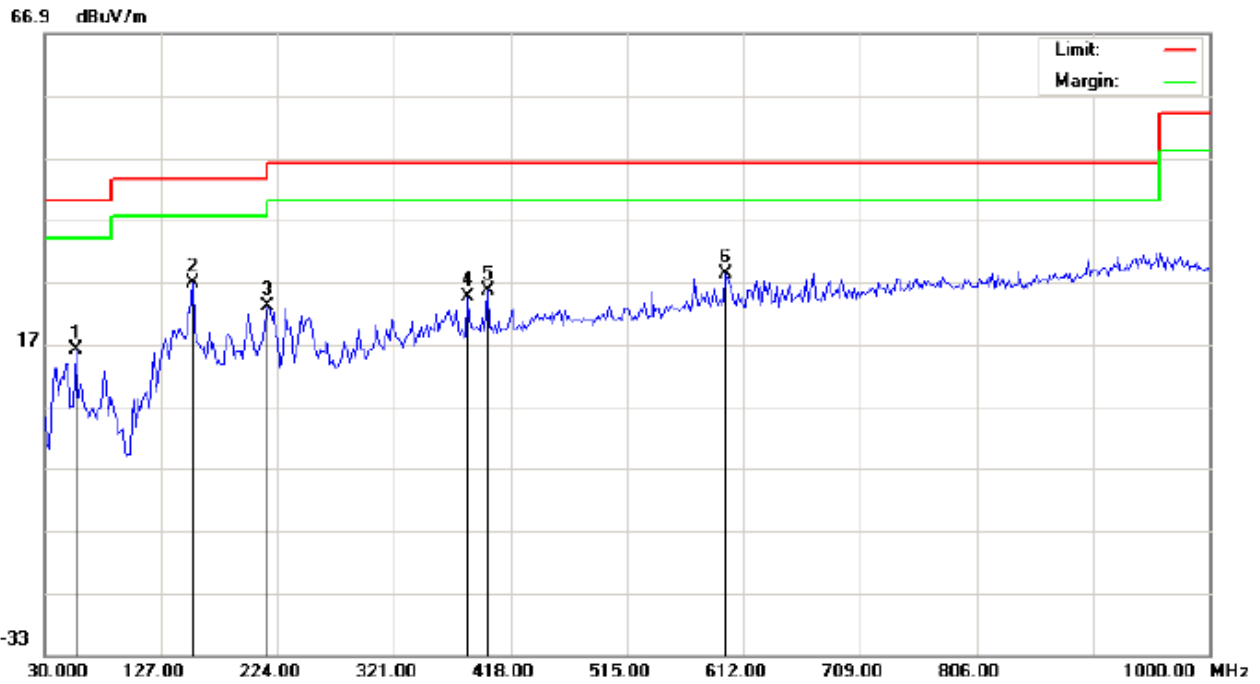

Site: site #1  
Limit: FCC Class B 3M Radiation  
EUT: Boston  
M/N: 2033202  
Mode: Low Channel TX  
Note:

Polarization: **Vertical**  
Power:  
Distance: 3m

Temperature: 26  
Humidity: 60 %

No.	Mk	Freq.	Reading	Factor	Measurement	Limit	Over	Detector	Antenna	Table	Comment
		MHz	dBuV	dB/m	dBuV/m	dBuV/m	dB		Height	Degree	
1		55.8667	7.83	8.19	16.02	40.00	-23.98	peak	cm	degree	
2	*	152.8667	11.60	15.28	26.88	43.50	-16.62	peak			
3		215.9167	12.37	10.56	22.93	43.50	-20.57	peak			
4		382.4333	5.48	18.95	24.43	46.00	-21.57	peak			
5		398.6000	6.52	19.06	25.58	46.00	-20.42	peak			
6		597.4500	5.59	22.72	28.31	46.00	-17.69	peak			

**RESULT: PASS**

**Note:** 1. Factor=Antenna Factor + Cable loss, Margin=Measurement-Limit.

2. The "Factor" value can be calculated automatically by software of measurement system.

RADIATED EMISSION TEST- (30MHZ-1GHZ)-MIDDLE CHANNEL-HORIZONTAL

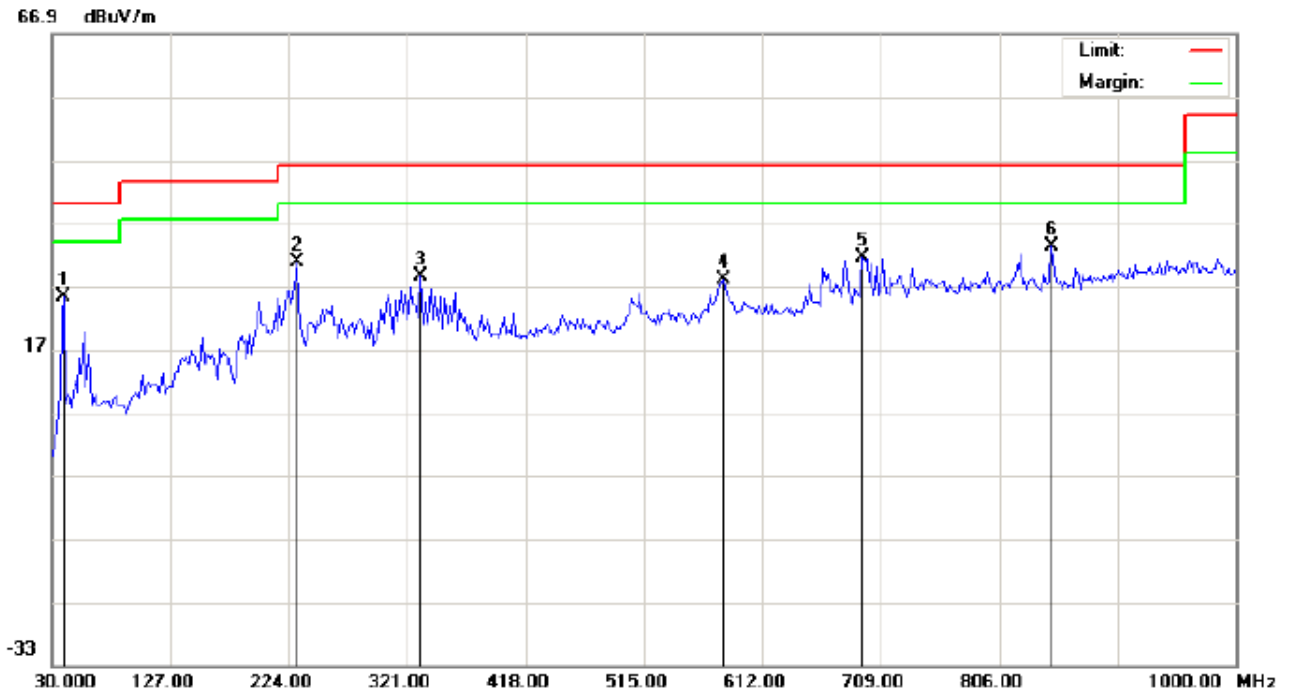

Site: site #1  
Limit: FCC Class B 3M Radiation  
EUT: Boston  
M/N: 2033202  
Mode: Middle Channel TX  
Note:

Polarization: *Horizontal*  
Power:  
Distance: 3m

Temperature: 26  
Humidity: 60 %

No.	Mk	Freq.	Reading	Factor	Measurement	Limit	Over	Detector	Antenna Height	Table Degree	Comment
		MHz	dBuV	dB/m	dBuV/m	dBuV/m	dB		cm	degree	
1		39.7000	13.89	11.51	25.40	40.00	-14.60	peak			
2		230.4667	17.51	13.16	30.67	46.00	-15.33	peak			
3		332.3167	10.97	17.56	28.53	46.00	-17.47	peak			
4		579.6667	4.78	23.22	28.00	46.00	-18.00	peak			
5		694.4500	6.48	25.04	31.52	46.00	-14.48	peak			
6	*	849.6500	5.88	27.31	33.19	46.00	-12.81	peak			

**RESULT: PASS**

RADIATED EMISSION TEST- (30MHZ-1GHZ)- MIDDLE CHANNEL -VERTICAL

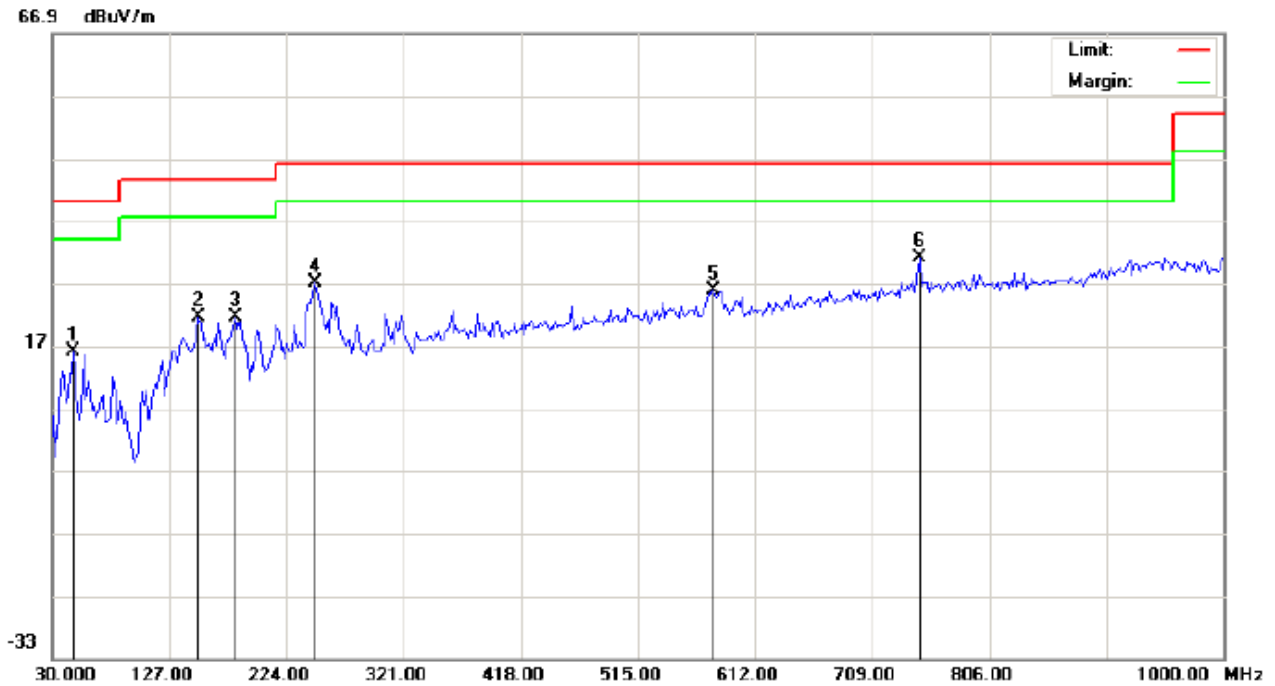

Site: site #1  
Limit: FCC Class B 3M Radiation  
EUT: Boston  
M/N: 2033202  
Mode: Middle Channel TX  
Note:

Polarization: *Vertical*  
Power:  
Distance: 3m

Temperature: 26  
Humidity: 60 %

No.	Mk	Freq.	Reading	Factor	Measurement	Limit	Over	Detector	Antenna Height	Table Degree	Comment
		MHz	dBuV	dB/m	dBuV/m	dBuV/m	dB		cm	degree	
1		47.7833	7.70	8.39	16.09	40.00	-23.91	peak			
2		151.2500	6.26	15.27	21.53	43.50	-21.97	peak			
3		181.9667	8.08	13.57	21.65	43.50	-21.85	peak			
4		248.2500	13.31	13.73	27.04	46.00	-18.96	peak			
5		578.0500	3.09	22.62	25.71	46.00	-20.29	peak			
6	*	747.8000	4.48	26.57	31.05	46.00	-14.95	peak			

**RESULT: PASS**

**Note:** 1. Factor=Antenna Factor + Cable loss, Margin=Measurement-Limit.

2. The "Factor" value can be calculated automatically by software of measurement system.



RADIATED EMISSION TEST- (30MHZ-1GHZ)-HIGH CHANNEL-HORIZONTAL

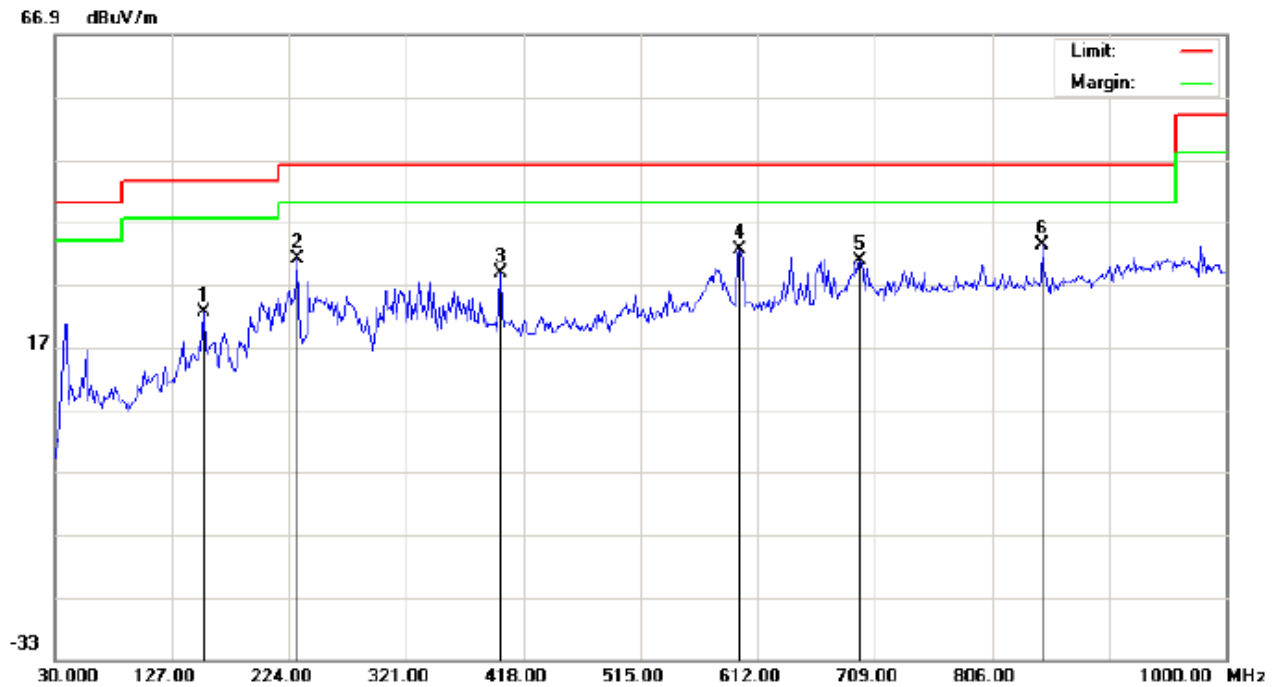

Site: site #1  
 Limit: FCC Class B 3M Radiation  
 EUT: Boston  
 M/N: 2033202  
 Mode: High Channel TX  
 Note:

Polarization: *Horizontal*  
 Power:  
 Distance: 3m

Temperature: 26  
 Humidity: 60 %

No.	Mk	Freq.	Reading	Factor	Measurement	Limit	Over	Detector	Antenna Height	Table Degree	Comment
		MHz	dBuV	dB/m	dBuV/m	dBuV/m	dB		cm	degree	
1		152.8667	7.22	15.28	22.50	43.50	-21.00	peak			
2		230.4667	17.78	13.16	30.94	46.00	-15.06	peak			
3		398.6000	9.66	19.06	28.72	46.00	-17.28	peak			
4		597.4500	8.83	23.67	32.50	46.00	-13.50	peak			
5		696.0667	5.68	25.08	30.76	46.00	-15.24	peak			
6	*	848.0333	6.06	27.31	33.37	46.00	-12.63	peak			

**RESULT: PASS**

RADIATED EMISSION TEST- (30MHZ-1GHZ)-HIGH CHANNEL -VERTICAL

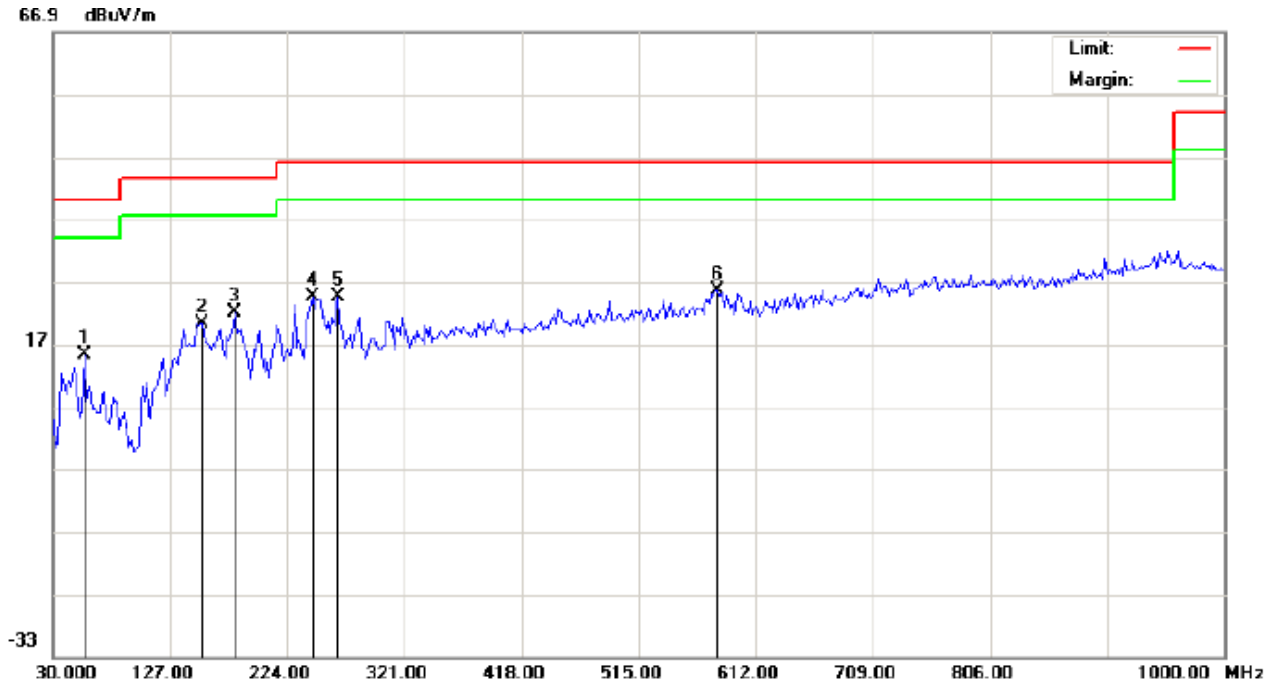

Site: site #1  
Limit: FCC Class B 3M Radiation  
EUT: Boston  
M/N: 2033202  
Mode: High Channel TX  
Note:

Polarization: **Vertical**  
Power:  
Distance: 3m

Temperature: 26  
Humidity: 60 %

No.	Mk	Freq.	Reading	Factor	Measurement	Limit	Over	Detector	Antenna Height	Table Degree	Comment
		MHz	dBuV	dB/m	dBuV/m	dBuV/m	dB		cm	degree	
1		55.8667	7.07	8.19	15.26	40.00	-24.74	peak			
2		152.8667	4.93	15.28	20.21	43.50	-23.29	peak			
3		180.3500	8.10	13.98	22.08	43.50	-21.42	peak			
4		245.0167	11.06	13.41	24.47	46.00	-21.53	peak			
5		266.0333	10.09	14.38	24.47	46.00	-21.53	peak			
6	*	579.6667	2.93	22.63	25.56	46.00	-20.44	peak			

**RESULT: PASS**

**Note:** 1. Factor=Antenna Factor + Cable loss, Margin=Measurement-Limit.

2. The "Factor" value can be calculated automatically by software of measurement system.





RADIATED EMISSION TEST- (ABOVE 1GHZ)-MIDDLE CHANNEL-HORIZONTAL

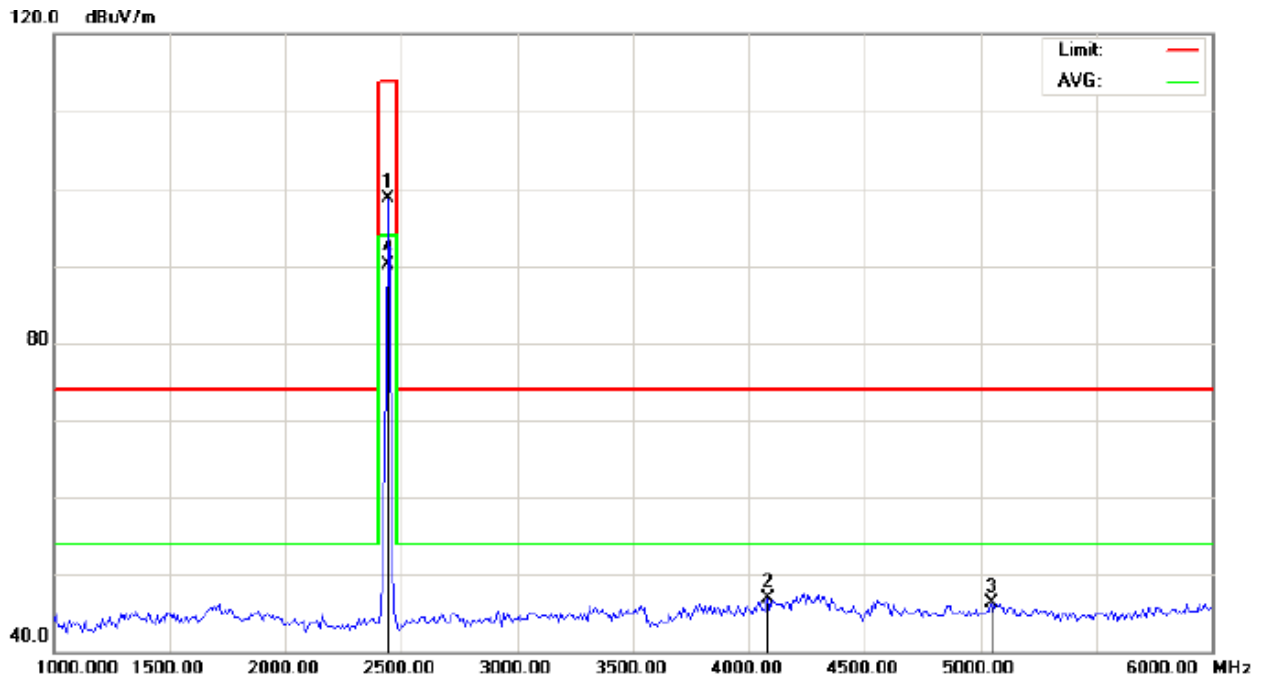

Site: site #1 Polarization: *Horizontal* Temperature: 26  
Limit: FCC Class B 3M Radiation above 1GHZ(PK)- Power: Humidity: 60 %  
EUT:Boston Distance: 3m  
M/N:2033202  
Mode: Middle Channel TX  
Note:

No.	Mk	Freq.	Reading	Factor	Measurement	Limit	Over	Detector	Antenna	Table	Comment
		MHz	dBuV	dB/m	dBuV/m	dBuV/m	dB		Height	Degree	
1		2441.000	108.29	-9.63	98.66	114.00	-15.34	peak			
2		4083.333	51.50	-4.53	46.97	74.00	-27.03	peak			
3		5050.000	48.03	-1.80	46.23	74.00	-27.77	peak			
4	*	2441.000	99.66	-9.63	90.03	94.00	-3.97	AVG	150	360	

**RESULT: PASS**

RADIATED EMISSION TEST- (ABOVE 1GHZ)-MIDDLE CHANNEL- VERTICAL

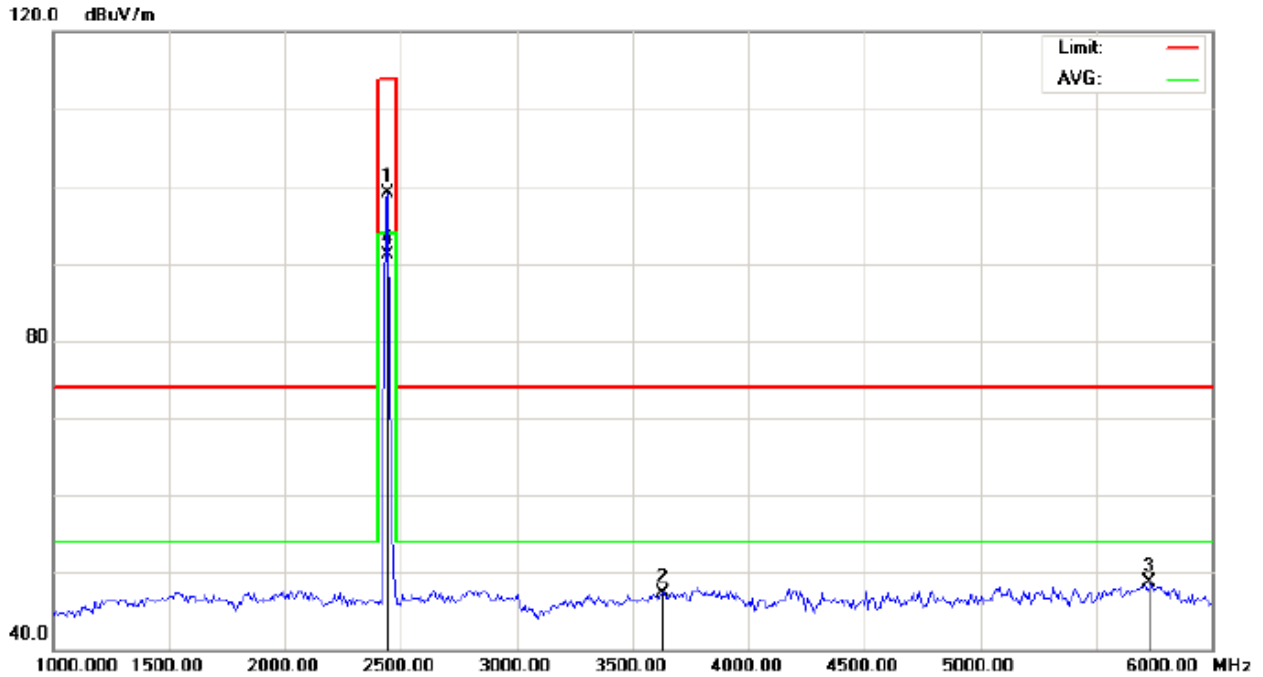

Site: site #1  
Limit: FCC Class B 3M Radiation above 1GHZ(PK)-  
EUT:Boston  
M/N:2033202  
Mode: Middle Channel TX  
Note:

Polarization: *Vertical*  
Power:  
Distance: 3m

Temperature: 26  
Humidity: 60 %

No.	Mk	Freq.	Reading	Factor	Measurement	Limit	Over	Detector	Antenna Height	Table Degree	Comment
		MHz	dBuV	dB/m	dBuV/m	dBuV/m	dB		cm	degree	
1		2441.000	108.73	-9.63	99.10	114.00	-14.90	peak			
2		3633.333	54.43	-7.07	47.36	74.00	-26.64	peak			
3		5733.333	50.33	-1.70	48.63	74.00	-25.37	peak			
4	*	2441.000	100.69	-9.63	91.06	94.00	-2.94	AVG	150	360	

**RESULT: PASS**

RADIATED EMISSION TEST- (ABOVE 1GHZ)-HIGH CHANNEL-HORIZONTAL

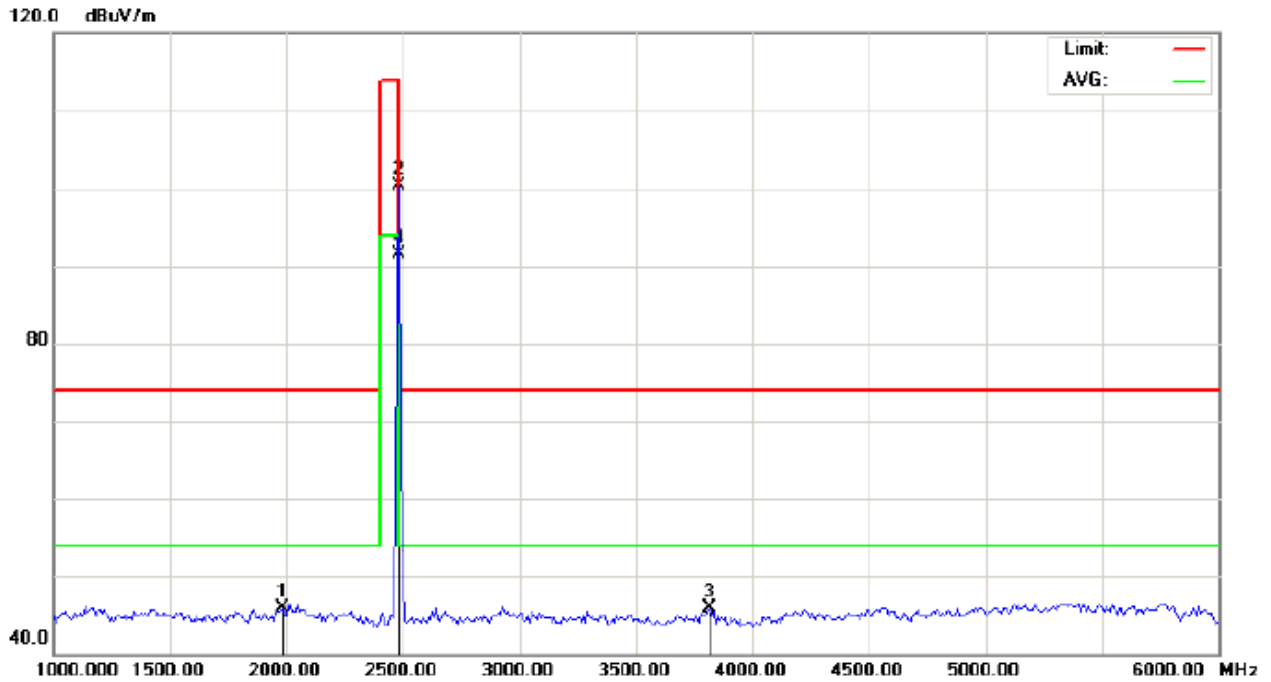

Site: site #1  
Limit: FCC Class B 3M Radiation above 1GHZ(PK)-  
EUT:Boston  
M/N:2033202  
Mode: High Channel TX  
Note:

Polarization: *Horizontal*  
Power:  
Distance: 3m

Temperature: 26  
Humidity: 60 %

No.	Mk	Freq.	Reading	Factor	Measurement	Limit	Over	Detector	Antenna Height	Table Degree	Comment
		MHz	dBuV	dB/m	dBuV/m	dBuV/m	dB		cm	degree	
1		1983.333	56.17	-10.29	45.88	74.00	-28.12	peak			
2		2480.000	109.87	-9.59	100.28	114.00	-13.72	peak			
3		3816.667	51.88	-5.94	45.94	74.00	-28.06	peak			
4	*	2480.000	101.05	-9.59	91.46	94.00	-2.54	AVG	100	360	

**RESULT: PASS**

RADIATED EMISSION TEST- (ABOVE 1GHZ)-HIGH CHANNEL- VERTICAL

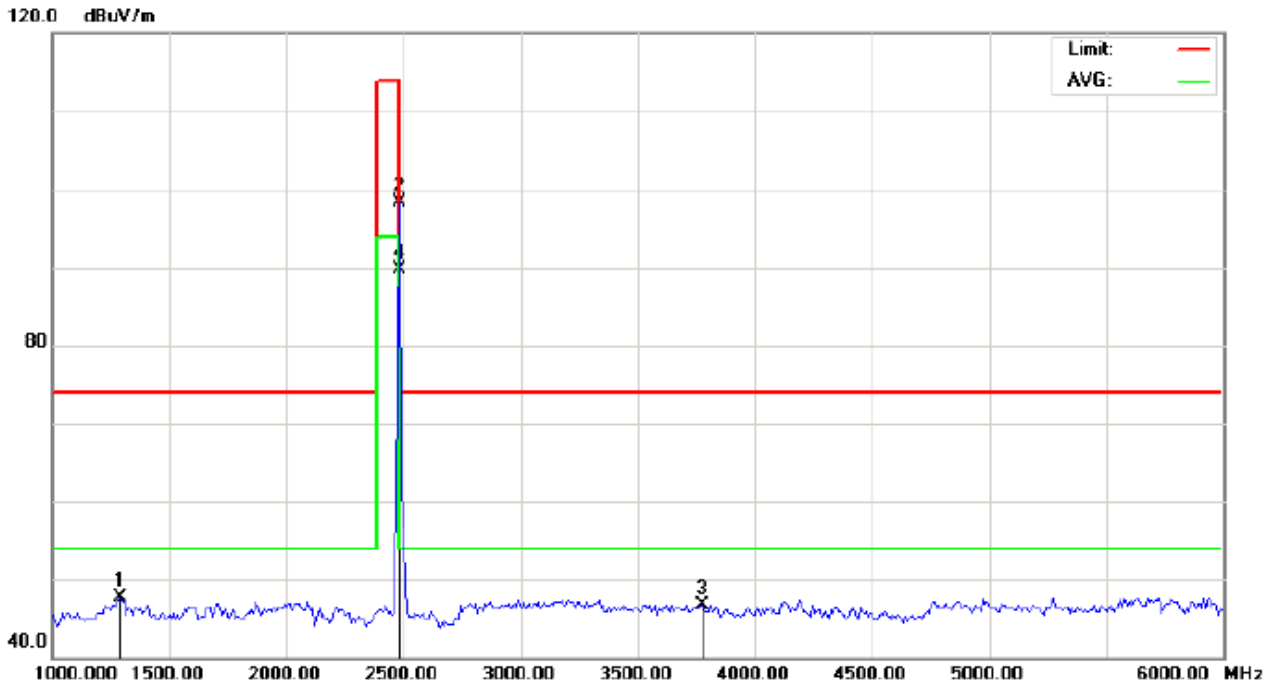

Site: site #1 Polarization: *Vertical* Temperature: 26  
Limit: FCC Class B 3M Radiation above 1GHZ(PK)- Power: Humidity: 60 %  
EUT:Boston Distance: 3m  
M/N:2033202  
Mode: High Channel TX  
Note:

No.	Mk	Freq.	Reading	Factor	Measurement	Limit	Over	Detector	Antenna Height	Table Degree	Comment
		MHz	dBuV	dB/m	dBuV/m	dBuV/m	dB		cm	degree	
1		1291.667	63.12	-15.47	47.65	74.00	-26.35	peak			
2		2480.000	107.87	-9.59	98.28	114.00	-15.72	peak			
3		3775.000	52.99	-6.20	46.79	74.00	-27.21	peak			
4	*	2480.000	99.24	-9.59	89.65	94.00	-4.35	AVG	100	360	

**RESULT: PASS**

**Note:** 6~25GHz at least have 20dB margin. No recording in the test report.

Factor=Antenna Factor + Cable loss - Amplifier gain, Margin=Measurement-Limit.

The "Factor" value can be calculated automatically by software of measurement system.



**Field strength of the fundamental signal**

**Peak value**

Frequency	Reading Level	Factor	Measurement	Limit	Over	Antenna
(MHz)	(dBuv)	(dB/m)	(dBuv/m)	(dBuv/m)	(dB)	Polarization
2402	109.23	-9.68	99.55	114	-14.45	Horizontal
2402	108.73	-9.68	99.05	114	-14.95	Vertical
2441	108.29	-9.63	98.66	114	-15.34	Horizontal
2441	108.73	-9.63	99.10	114	-14.90	Vertical
2480	109.87	-9.59	100.28	114	-13.72	Horizontal
2480	107.87	-9.59	98.28	114	-15.72	Vertical

**Average value**

Frequency	Reading Level	Factor	Measurement	Limit	Over	Antenna
(MHz)	(dBuv)	(dB/m)	(dBuv/m)	(dBuv/m)	(dB)	Polarization
2402	101.44	-9.68	91.76	94	-2.24	Horizontal
2402	101.30	-9.68	91.62	94	-2.38	Vertical
2441	99.66	-9.63	90.03	94	-3.97	Horizontal
2441	100.69	-9.63	91.06	94	-2.94	Vertical
2480	101.05	-9.59	91.46	94	-2.54	Horizontal
2480	99.24	-9.59	89.65	94	-4.35	Vertical









RADIATED EMISSION TEST- (ABOVE 1GHZ)-HIGH CHANNEL-HORIZONTAL

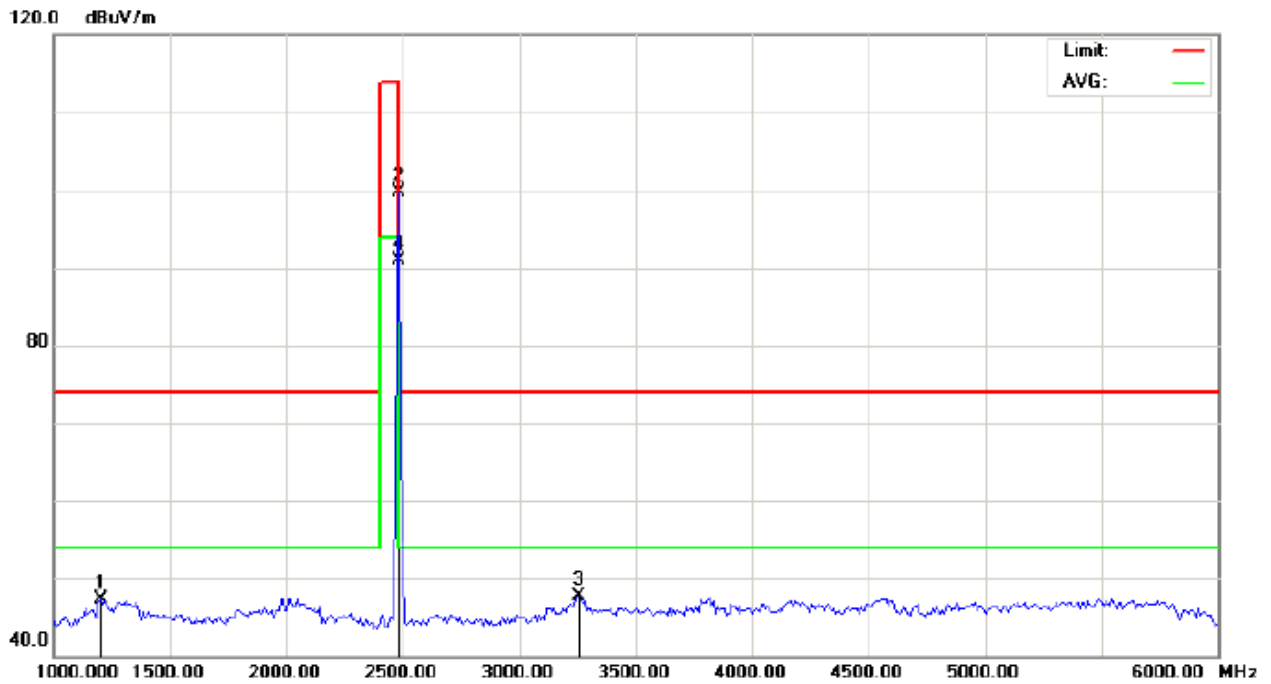

Site: site #1  
Limit: FCC Class B 3M Radiation above 1GHZ(PK)-  
EUT:Boston  
M/N:2033202  
Mode: High Channel TX  
Note:

Polarization: *Horizontal*  
Power:  
Distance: 3m

Temperature: 26  
Humidity: 60 %

No.	Mk	Freq.	Reading	Factor	Measurement	Limit	Over	Detector	Antenna Height	Table Degree	Comment
		MHz	dBuV	dB/m	dBuV/m	dBuV/m	dB		cm	degree	
1		1200.000	62.74	-15.51	47.23	74.00	-26.77	peak			
2		2480.000	109.37	-9.59	99.78	114.00	-14.22	peak			
3		3258.333	55.90	-8.12	47.78	74.00	-26.22	peak			
4	*	2480.000	100.43	-9.59	90.84	94.00	-3.16	AVG	150	326	

**RESULT: PASS**

RADIATED EMISSION TEST- (ABOVE 1GHZ)-HIGH CHANNEL- VERTICAL

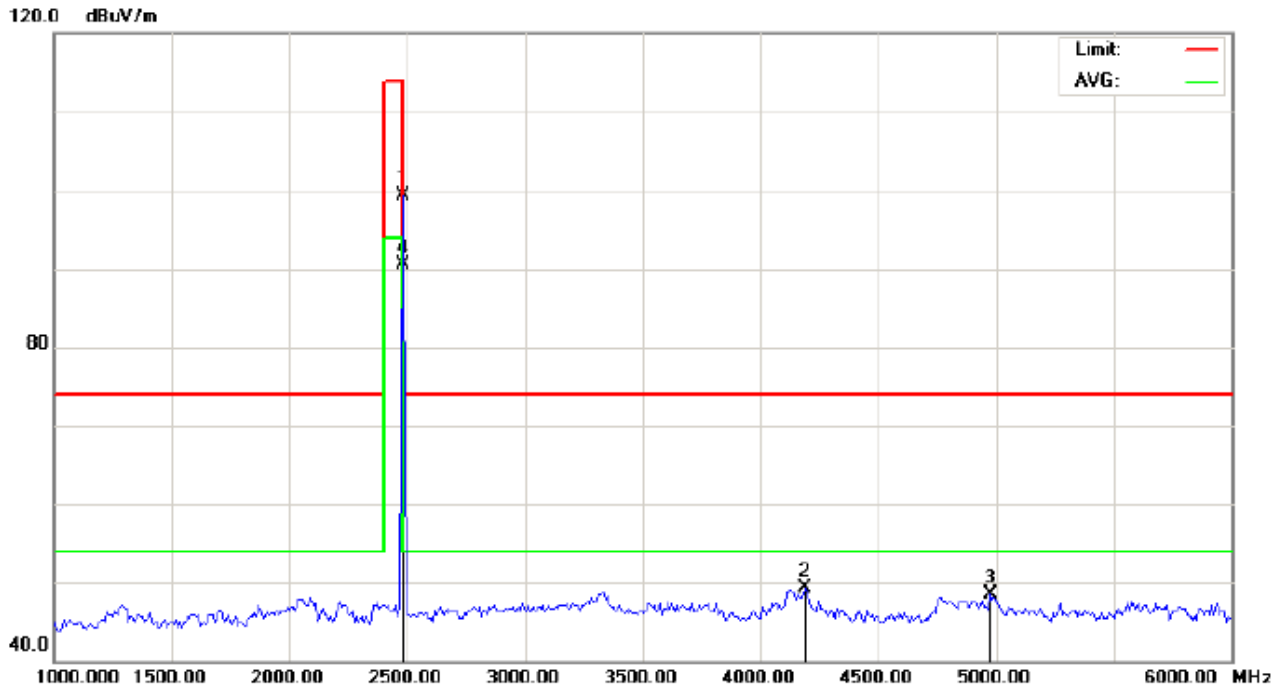

Site: site #1 Polarization: *Vertical* Temperature: 26  
Limit: FCC Class B 3M Radiation above 1GHZ(PK)- Power: Humidity: 60 %  
EUT:Boston Distance: 3m  
M/N:2033202  
Mode: High Channel TX  
Note:

No.	Mk	Freq.	Reading	Factor	Measurement	Limit	Over	Detector	Antenna Height	Table Degree	Comment
		MHz	dBuV	dB/m	dBuV/m	dBuV/m	dB		cm	degree	
1		2480.000	108.87	-9.59	99.28	114.00	-14.72	peak			
2		4191.667	53.49	-4.16	49.33	74.00	-24.67	peak			
3		4975.000	50.36	-1.87	48.49	74.00	-25.51	peak			
4	*	2480.000	100.15	-9.59	90.56	94.00	-3.44	AVG	150	146	

**RESULT: PASS**

**Note:** 6~25GHz at least have 20dB margin. No recording in the test report.

Factor=Antenna Factor + Cable loss - Amplifier gain, Margin=Measurement-Limit.

The "Factor" value can be calculated automatically by software of measurement system.

**Field strength of the fundamental signal**

**Peak value**

Frequency	Reading Level	Factor	Measurement	Limit	Over	Antenna
(MHz)	(dBuv)	(dB/m)	(dBuv/m)	(dBuv/m)	(dB)	Polarization
2402	106.73	-9.68	97.05	114	-16.95	Horizontal
2402	106.73	-9.68	97.05	114	-16.95	Vertical
2440	107.29	-9.63	97.66	114	-16.34	Horizontal
2440	109.23	-9.63	99.60	114	-14.40	Vertical
2480	109.37	-9.59	99.78	114	-14.22	Horizontal
2480	108.87	-9.59	99.28	114	-14.72	Vertical

**Average value**

Frequency	Reading Level	Factor	Measurement	Limit	Over	Antenna
(MHz)	(dBuv)	(dB/m)	(dBuv/m)	(dBuv/m)	(dB)	Polarization
2402	98.63	-9.68	88.95	94	-5.05	Horizontal
2402	98.70	-9.68	89.02	94	-4.98	Vertical
2440	98.75	-9.63	89.12	94	-4.88	Horizontal
2440	101.28	-9.63	91.65	94	-2.35	Vertical
2480	100.43	-9.59	90.84	94	-3.16	Horizontal
2480	100.15	-9.59	90.56	94	-3.44	Vertical



## 9. BAND EDGE EMISSION

### 9.1. MEASUREMENT PROCEDURE

1The EUT operates at hopping-off test mode. The lowest or highest channels are tested to verify the largest transmission and spurious emissions power at the continuous transmission mode.

2Max hold the trace of the setp 1,and the EUT operates at hopping-on test mode to verify the largest spurious emissions power.

3Set the spectrum analyzer in the following setting in order to capture the lower and upper band-edges of the emission: (a) PEAK: RBW=VBW=1MHz / Sweep=AUTO

(b) AVERAGE: RBW=1MHz ; VBW=1/on time(1KHz) / Sweep=AUTO

### 9.2 TEST SETUP

RADIATED EMISSION TEST SETUP

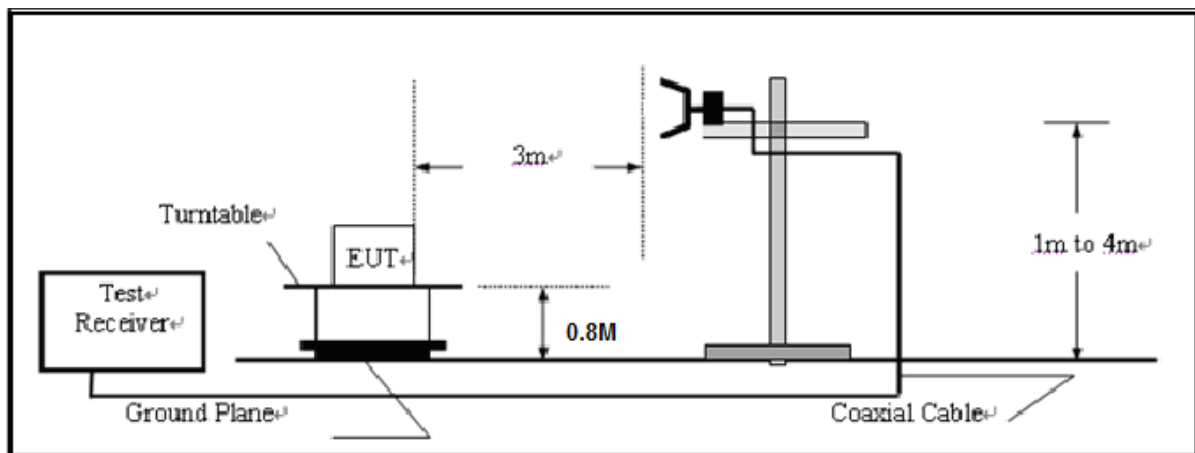

CONDUCTED TEST SETUP

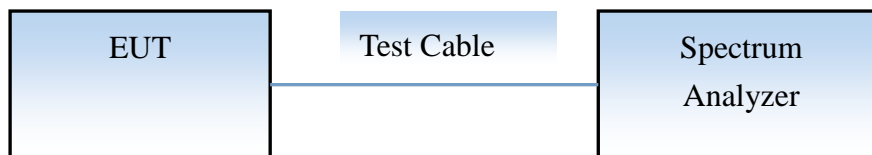



TEST PLOT OF BAND EDGE FOR LOW CHANNEL -Vertical

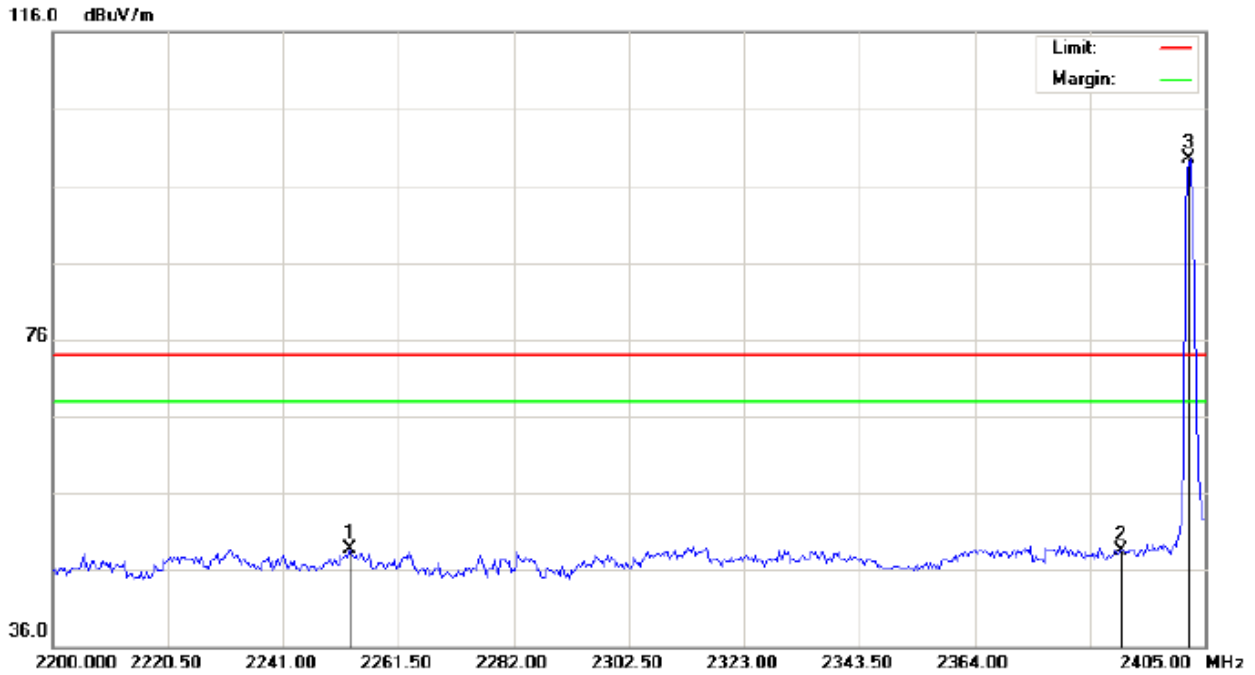

Site: site #1  
Limit: FCC Class B 3M Radiation above 1GHZ(PK)  
EUT:Boston  
M/N:2033202  
Mode: Low Channel TX  
Note:

Polarization: *Vertical*  
Power:  
Distance:

Temperature: 26  
Humidity: 60 %

No.	Mk	Freq.	Reading	Factor	Measurement	Limit	Over	Detector	Antenna Height	Table Degree	Comment
		MHz	dBuV	dB/m	dBuV/m	dBuV/m	dB		cm	degree	
1		2252.958	38.51	10.16	48.67	74.00	-25.33	peak			
2		2390.000	38.21	10.31	48.52	74.00	-25.48	peak			
3	*	2402.000	89.09	10.32	99.41	74.00	25.41	peak			

TEST PLOT OF BAND EDGE FOR HIGH CHANNEL -Horizontal

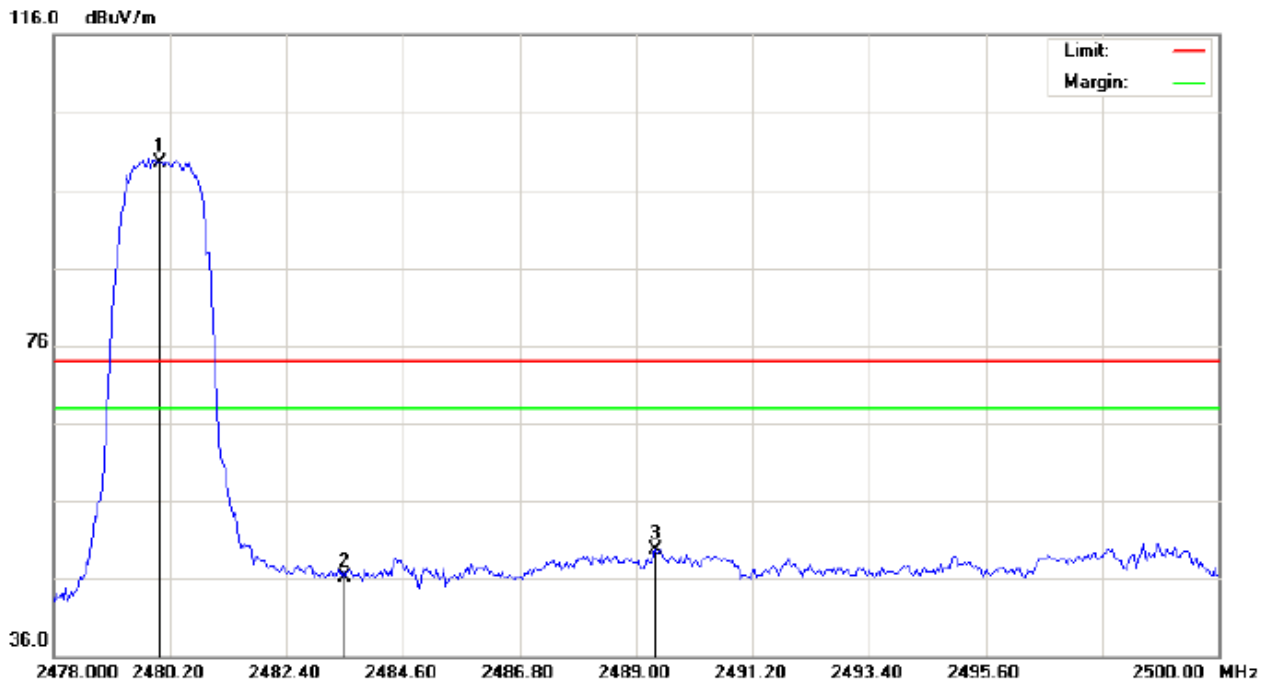

Site: site #1      Polarization: *Horizontal*      Temperature: 26  
 Limit: FCC Class B 3M Radiation above 1GHZ(PK)      Power:      Humidity: 60 %  
 EUT: Boston      Distance:  
 M/N: 2033202  
 Mode: High Channel TX  
 Note:

No.	Mk	Freq.	Reading	Factor	Measurement	Limit	Over	Detector	Antenna Height	Table Degree	Comment
		MHz	dBuV	dB/m	dBuV/m	dBuV/m	dB		cm	degree	
1	*	2480.000	89.05	10.41	99.46	74.00	25.46	peak			
2		2483.500	35.69	10.41	46.10	74.00	-27.90	peak			
3		2489.367	39.36	10.42	49.78	74.00	-24.22	peak			

TEST PLOT OF BAND EDGE FOR HIGH CHANNEL-Vertical

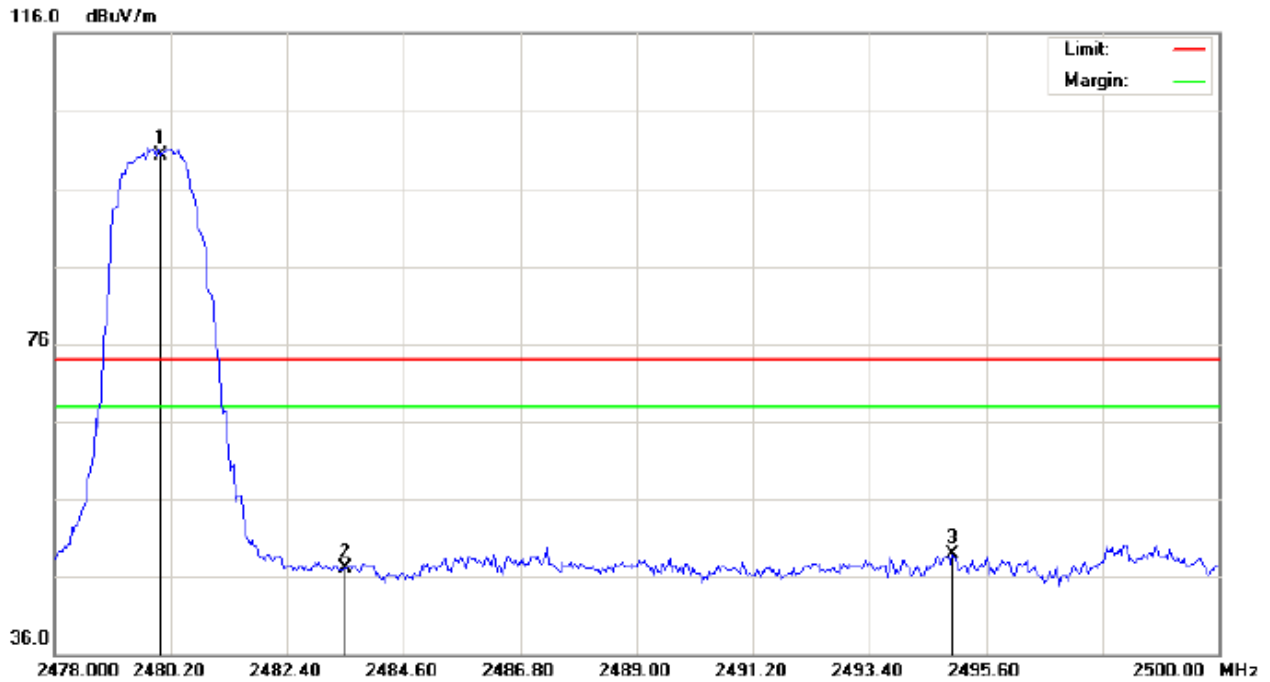

Site: site #1      Polarization: *Vertical*      Temperature: 26  
 Limit: FCC Class B 3M Radiation above 1GHZ(PK)      Power:      Humidity: 60 %  
 EUT:Boston      Distance:  
 M/N:2033202  
 Mode: High Channel TX  
 Note:

No.	Mk	Freq.	Reading	Factor	Measurement	Limit	Over	Detector	Antenna Height	Table Degree	Comment
		MHz	dBuV	dB/m	dBuV/m	dBuV/m	dB		cm	degree	
1	*	2480.000	89.82	10.41	100.23	74.00	26.23	peak			
2		2483.500	36.76	10.41	47.17	74.00	-26.83	peak			
3		2494.977	38.52	10.42	48.94	74.00	-25.06	peak			

**RESULT: PASS**

**Note:** The other modes radiation emission have enough 20dB margin.

Factor=Antenna Factor + Cable loss - Amplifier gain, Over=Measure-Limit.

The "Factor" value can be calculated automatically by software of measurement system.

FOR BLE

TEST PLOT OF BAND EDGE FOR LOW CHANNEL-Horizontal

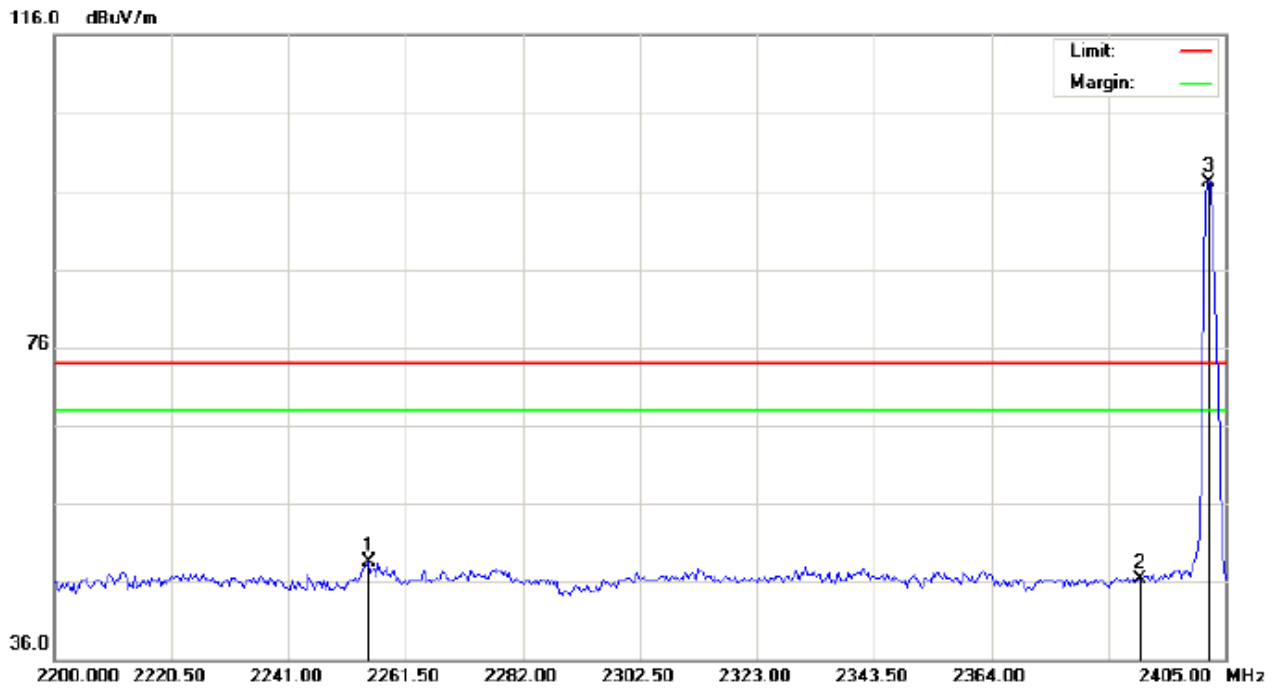

Site: site #1	Polarization: <i>Horizontal</i>	Temperature: 26
Limit: FCC Class B 3M Radiation above 1GHZ(PK)	Power:	Humidity: 60 %
EUT:Boston	Distance:	
M/N:2033202		
Mode: Low Channel TX		
Note:		

No.	Mk	Freq.	Reading	Factor	Measurement	Limit	Over	Detector	Antenna	Table	Comment
		MHz	dBuV	dB/m	dBuV/m	dBuV/m	dB		Height	Degree	
									cm	degree	
1		2255.008	38.29	10.16	48.45	74.00	-25.55	peak			
2		2390.000	36.00	10.31	46.31	74.00	-27.69	peak			
3	*	2402.000	86.72	10.32	97.04	74.00	23.04	peak			

TEST PLOT OF BAND EDGE FOR LOW CHANNEL -Vertical

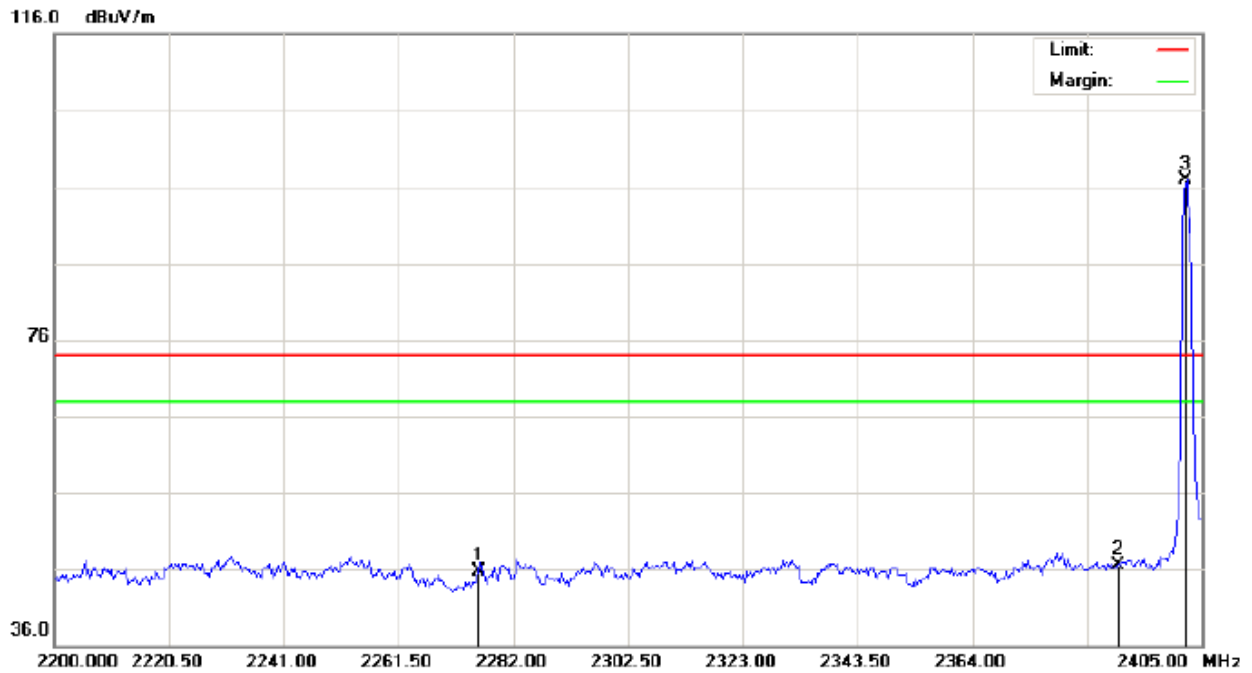

Site: site #1  
 Limit: FCC Class B 3M Radiation above 1GHZ(PK)  
 EUT:Boston  
 M/N:2033202  
 Mode: Low Channel TX  
 Note:

Polarization: *Vertical*  
 Power:  
 Distance:

Temperature: 26  
 Humidity: 60 %

No.	Mk	Freq.	Reading	Factor	Measurement	Limit	Over	Detector	Antenna Height	Table Degree	Comment
		MHz	dBuV	dB/m	dBuV/m	dBuV/m	dB		cm	degree	
1		2275.850	35.52	10.18	45.70	74.00	-28.30	peak			
2		2390.000	36.21	10.31	46.52	74.00	-27.48	peak			
3	*	2402.000	86.59	10.32	96.91	74.00	22.91	peak			

TEST PLOT OF BAND EDGE FOR HIGH CHANNEL -Horizontal

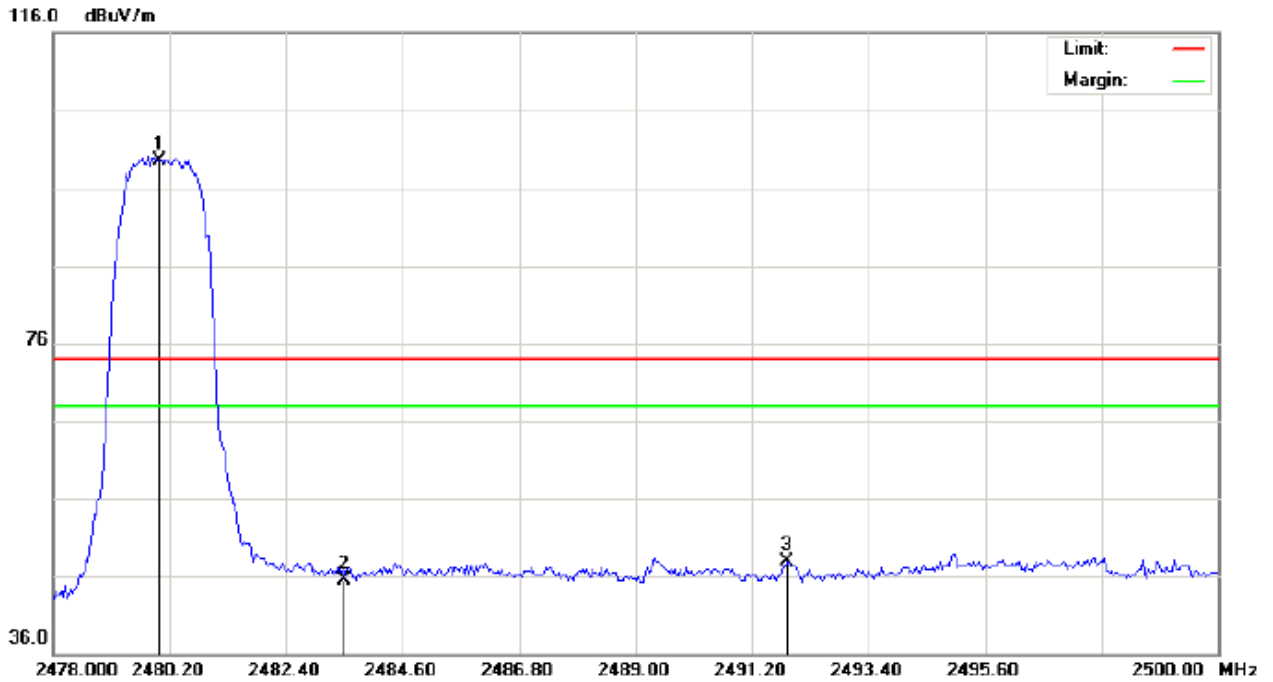

Site: site #1      Polarization: *Horizontal*      Temperature: 26  
 Limit: FCC Class B 3M Radiation above 1GHZ(PK)      Power:      Humidity: 60 %  
 EUT:Boston      Distance:  
 M/N:2033202  
 Mode: High Channel TX  
 Note:

No.	Mk	Freq.	Reading	Factor	Measurement	Limit	Over	Detector	Antenna Height	Table Degree	Comment
		MHz	dBuV	dB/m	dBuV/m	dBuV/m	dB		cm	degree	
1	*	2480.000	89.05	10.41	99.46	74.00	25.46	peak			
2		2483.500	35.19	10.41	45.60	74.00	-28.40	peak			
3		2491.860	37.56	10.42	47.98	74.00	-26.02	peak			



TEST PLOT OF BAND EDGE FOR HIGH CHANNEL-Vertical

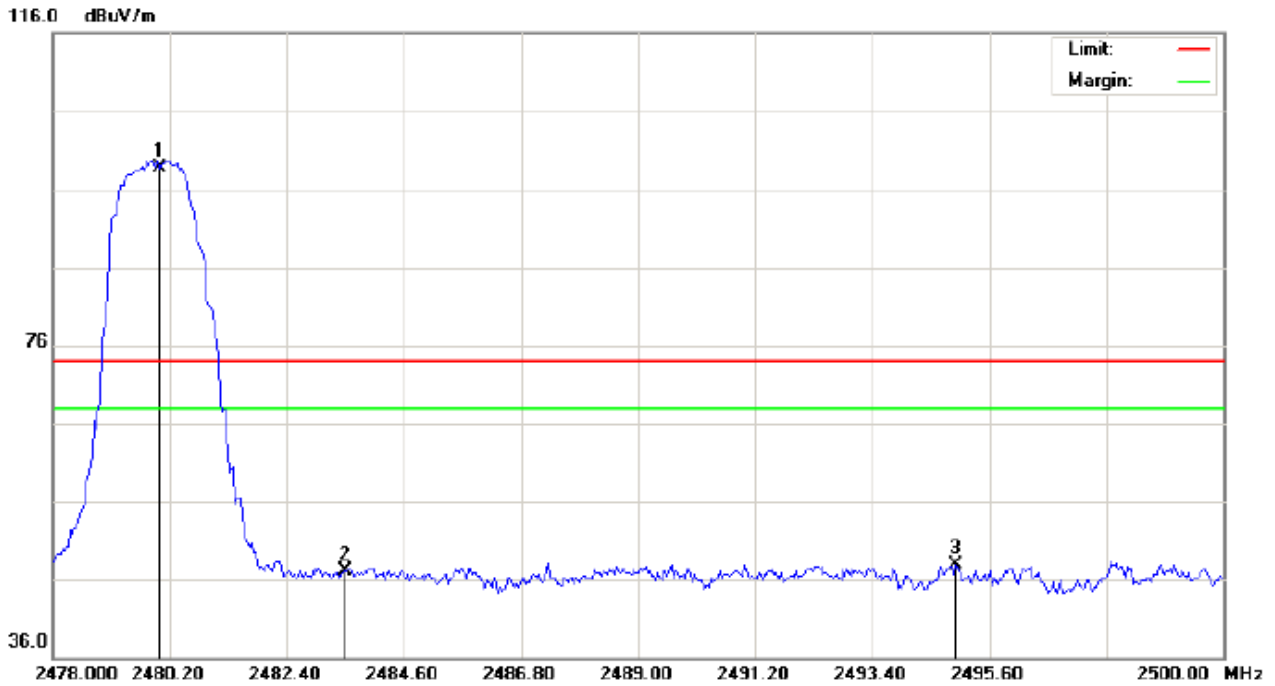

Site: site #1 Polarization: *Vertical* Temperature: 26  
Limit: FCC Class B 3M Radiation above 1GHZ(PK) Power: Humidity: 60 %  
EUT:Boston Distance:  
M/N:2033202  
Mode: High Channel TX  
Note:

No.	Mk	Freq.	Reading	Factor	Measurement	Limit	Over	Detector	Antenna Height	Table Degree	Comment
		MHz	dBuV	dB/m	dBuV/m	dBuV/m	dB		cm	degree	
1	*	2480.000	88.32	10.41	98.73	74.00	24.73	peak			
2		2483.500	36.76	10.41	47.17	74.00	-26.83	peak			
3		2494.977	37.52	10.42	47.94	74.00	-26.06	peak			

**RESULT: PASS**

**Note:** The other modes radiation emission have enough 20dB margin.

Factor=Antenna Factor + Cable loss - Amplifier gain, Over=Measure-Limit.

The "Factor" value can be calculated automatically by software of measurement system.

## 10. 20DB BANDWIDTH

### 10.1. MEASUREMENT PROCEDURE

1. Connect EUT RF output port to the Spectrum Analyzer through an RF attenuator
2. Set the EUT Work on the top, the middle and the bottom operation frequency individually.
3. Set Span = approximately 2 to 3 times the 20 dB bandwidth, centered on a hopping channel  
RBW  $\geq$  1% of the 20 dB bandwidth, VBW  $\geq$  RBW; Sweep = auto; Detector function = peak
4. Set SPA Trace 1 Max hold, then View.

### 10.2. TEST SET-UP (BLOCK DIAGRAM OF CONFIGURATION)

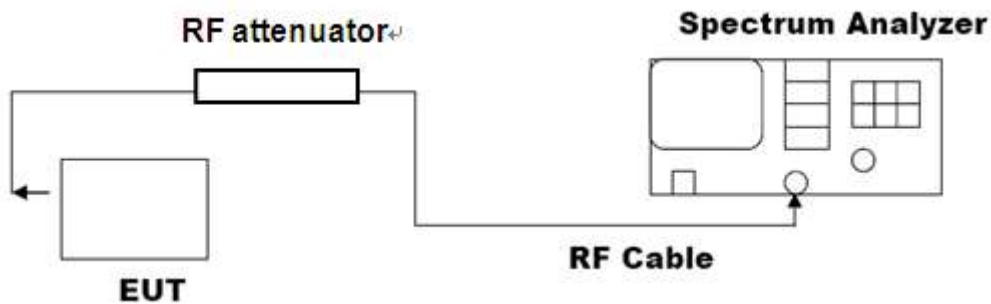

### 10.3. LIMITS AND MEASUREMENT RESULTS

#### FOR TRADITIONAL BLUETOOTH

BLUETOOTH 1MBPS LIMITS AND MEASUREMENT RESULT			
Applicable Limits	Measurement Result		
	Test Data (MHz)		Criteria
N/A	Low Channel	0.929	PASS
	Middle Channel	0.932	PASS
	High Channel	0.934	PASS

TEST PLOT OF BANDWIDTH FOR LOW CHANNEL



TEST PLOT OF BANDWIDTH FOR MIDDLE CHANNEL

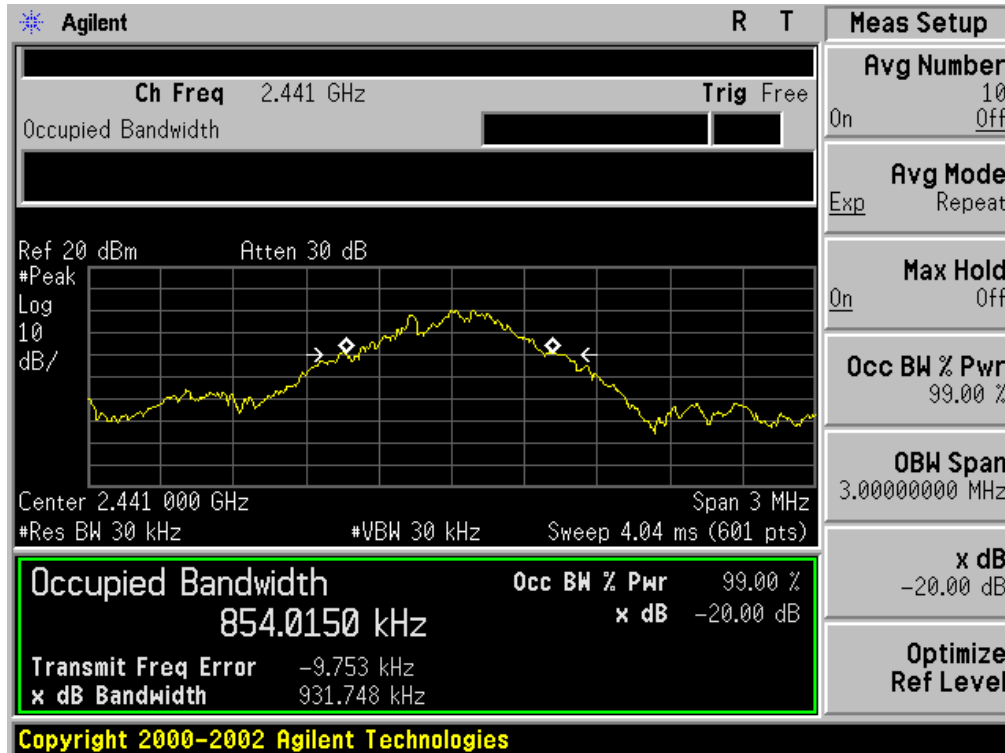

TEST PLOT OF BANDWIDTH FOR HIGH CHANNEL

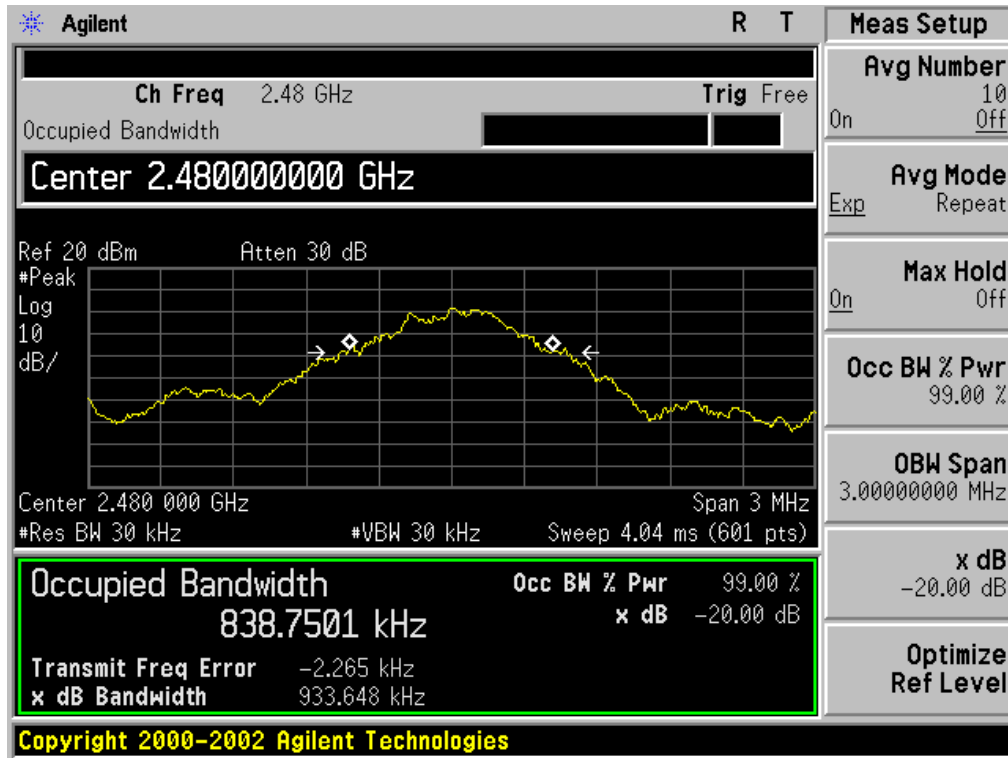

BLUETOOTH 2Mbps LIMITS AND MEASUREMENT RESULT			
Applicable Limits	Measurement Result		
	Test Data (MHz)		Criteria
N/A	Low Channel	1.236	PASS
	Middle Channel	1.235	PASS
	High Channel	1.232	PASS

TEST PLOT OF BANDWIDTH FOR LOW CHANNEL

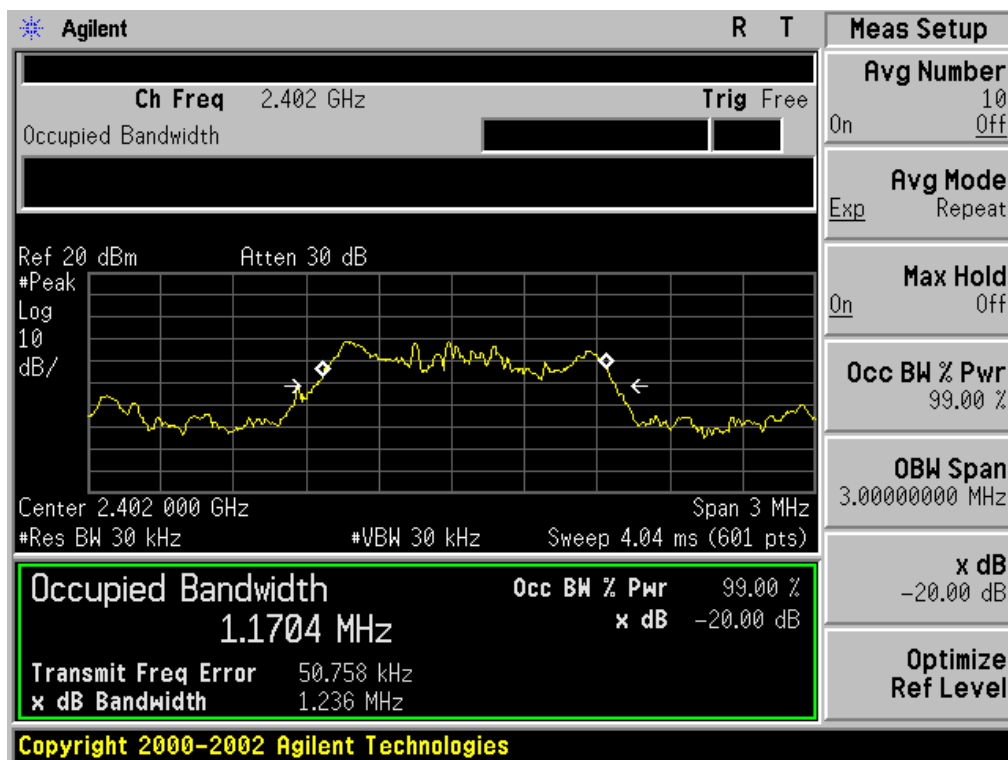

TEST PLOT OF BANDWIDTH FOR MIDDLE CHANNEL

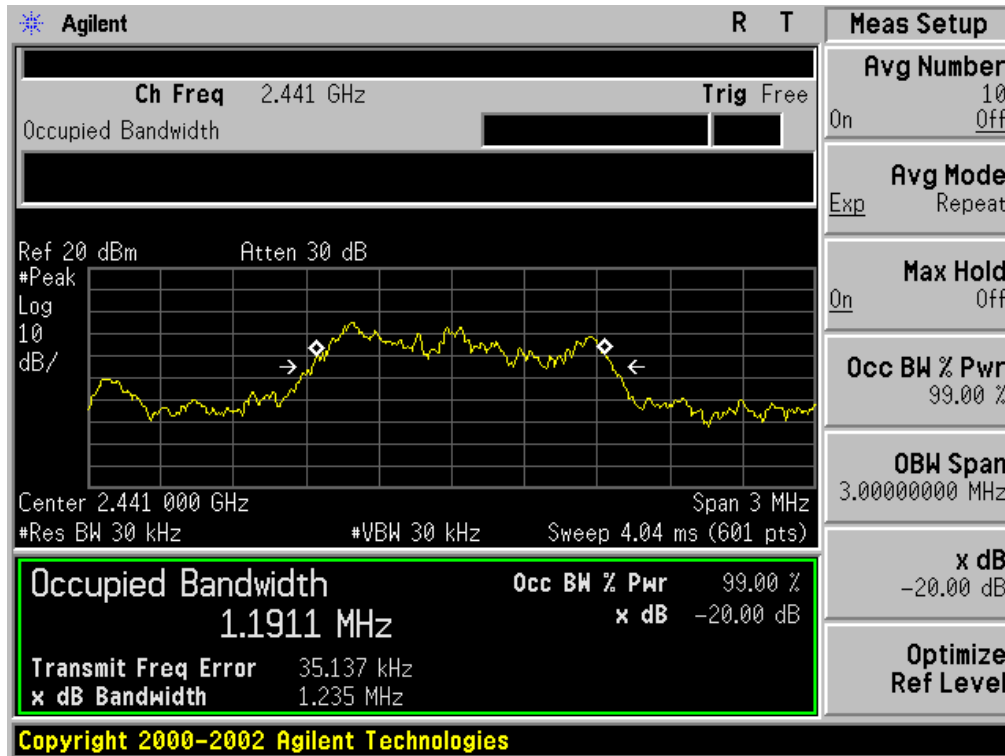

TEST PLOT OF BANDWIDTH FOR HIGH CHANNEL

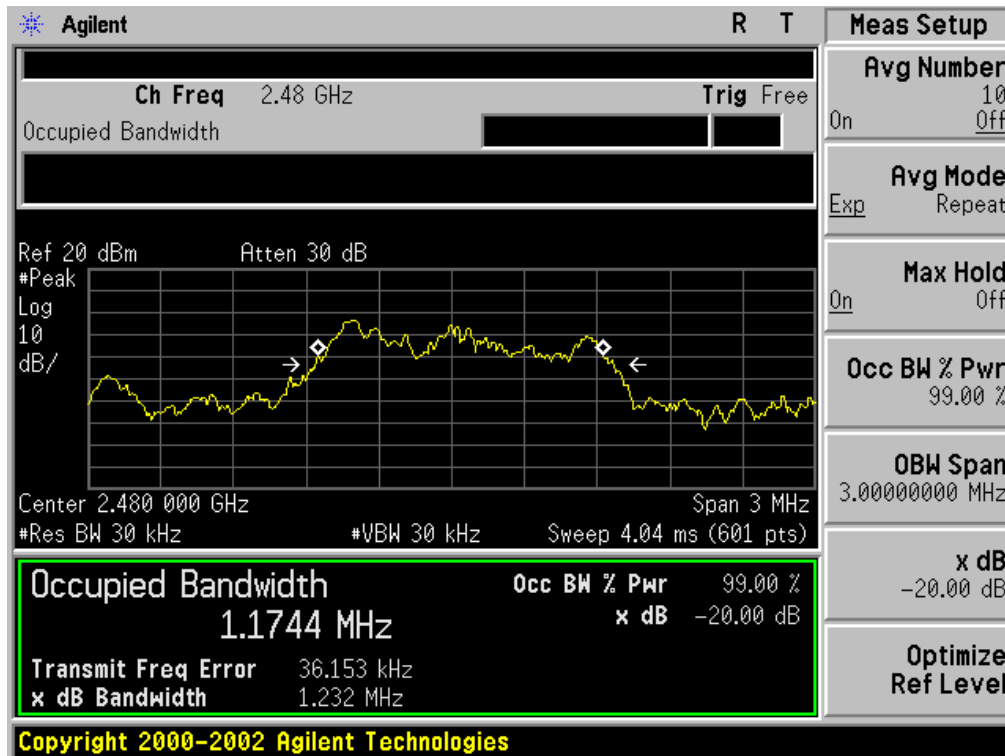

BLUETOOTH 3MBPS LIMITS AND MEASUREMENT RESULT			
Applicable Limits	Measurement Result		
	Test Data (MHz)		Criteria
N/A	Low Channel	1.227	PASS
	Middle Channel	1.253	PASS
	High Channel	1.253	PASS

TEST PLOT OF BANDWIDTH FOR LOW CHANNEL

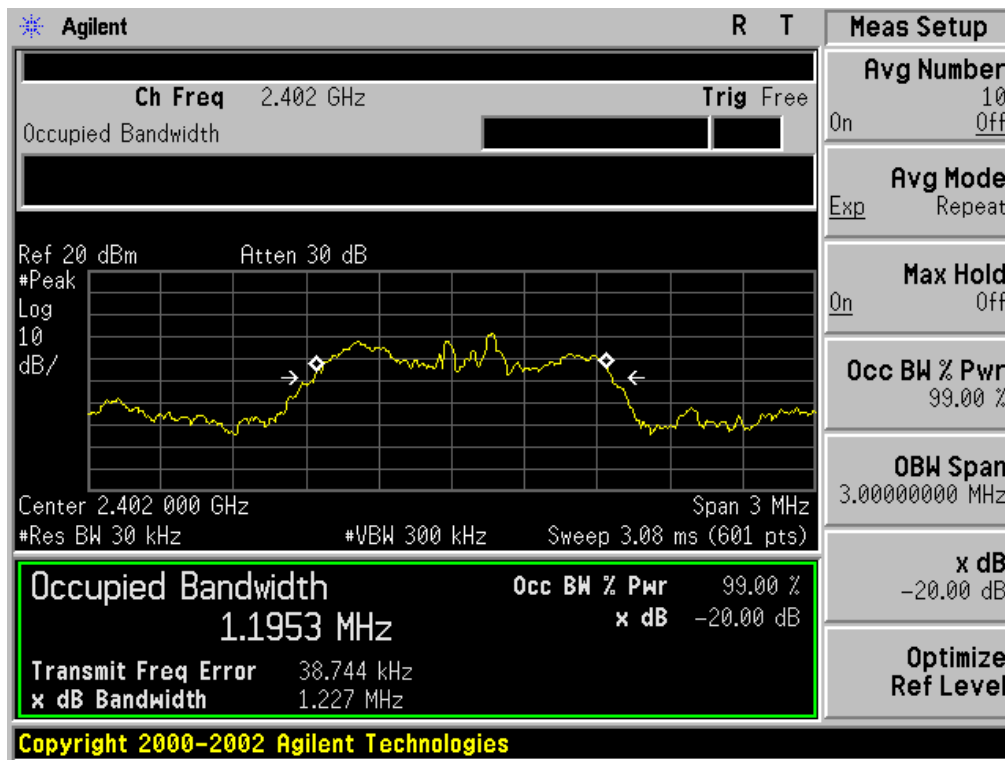

TEST PLOT OF BANDWIDTH FOR MIDDLE CHANNEL

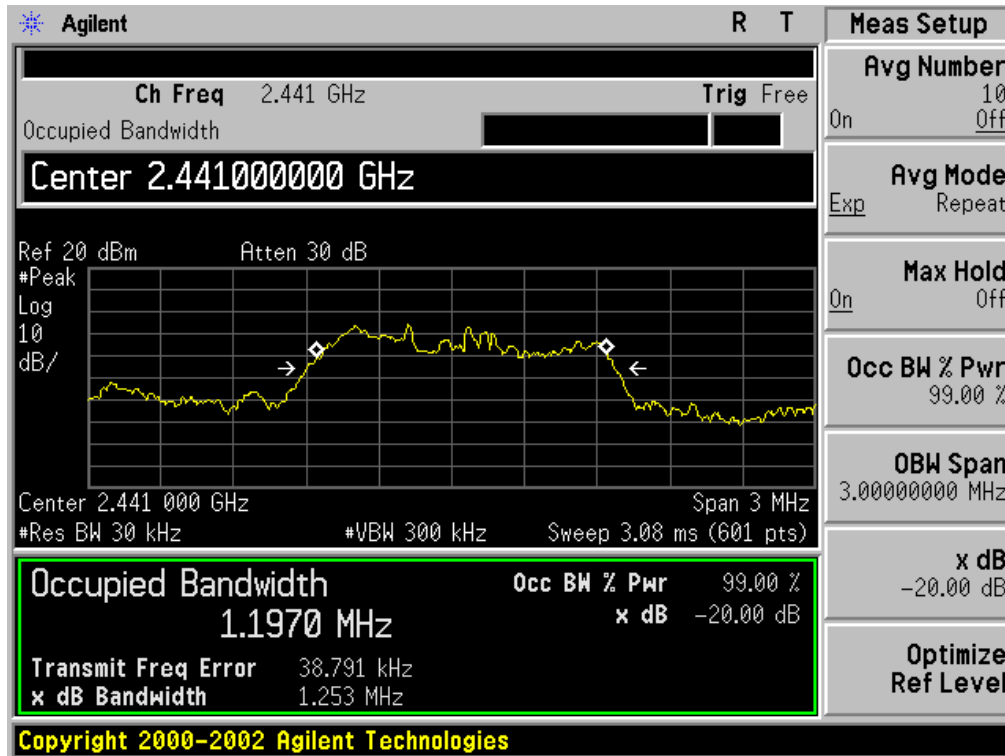

TEST PLOT OF BANDWIDTH FOR HIGH CHANNEL

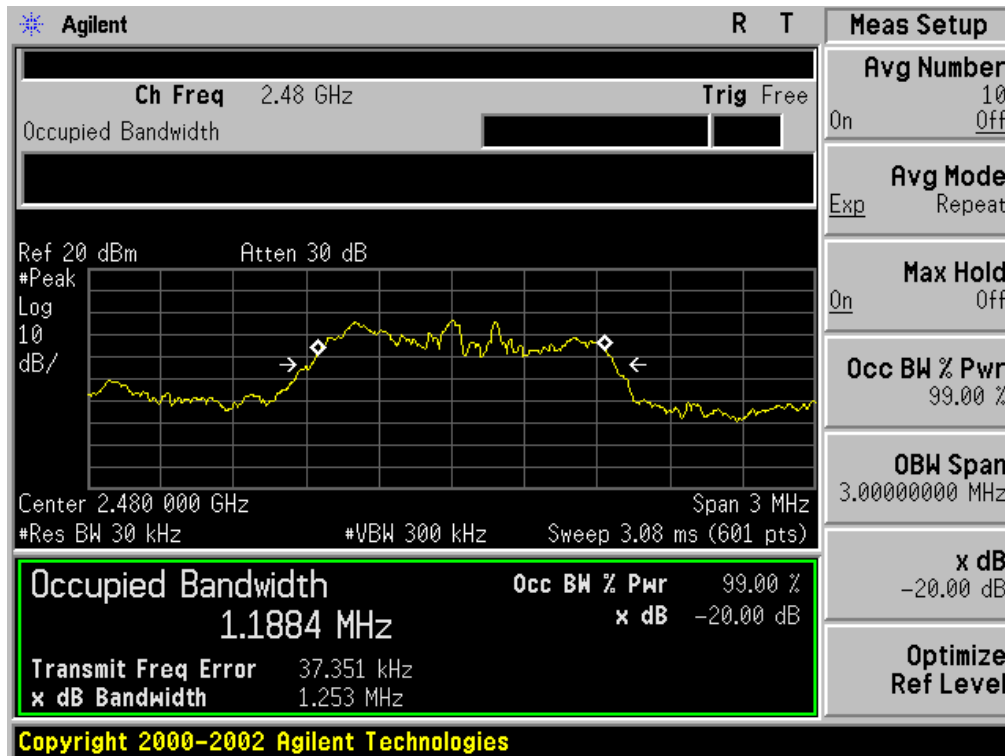



FOR BLE

BLUETOOTH 1Mbps LIMITS AND MEASUREMENT RESULT			
Applicable Limits	Measurement Result		
	Test Data (MHz)		Criteria
N/A	Low Channel	1.191	PASS
	Middle Channel	1.211	PASS
	High Channel	1.205	PASS

TEST PLOT OF BANDWIDTH FOR LOW CHANNEL

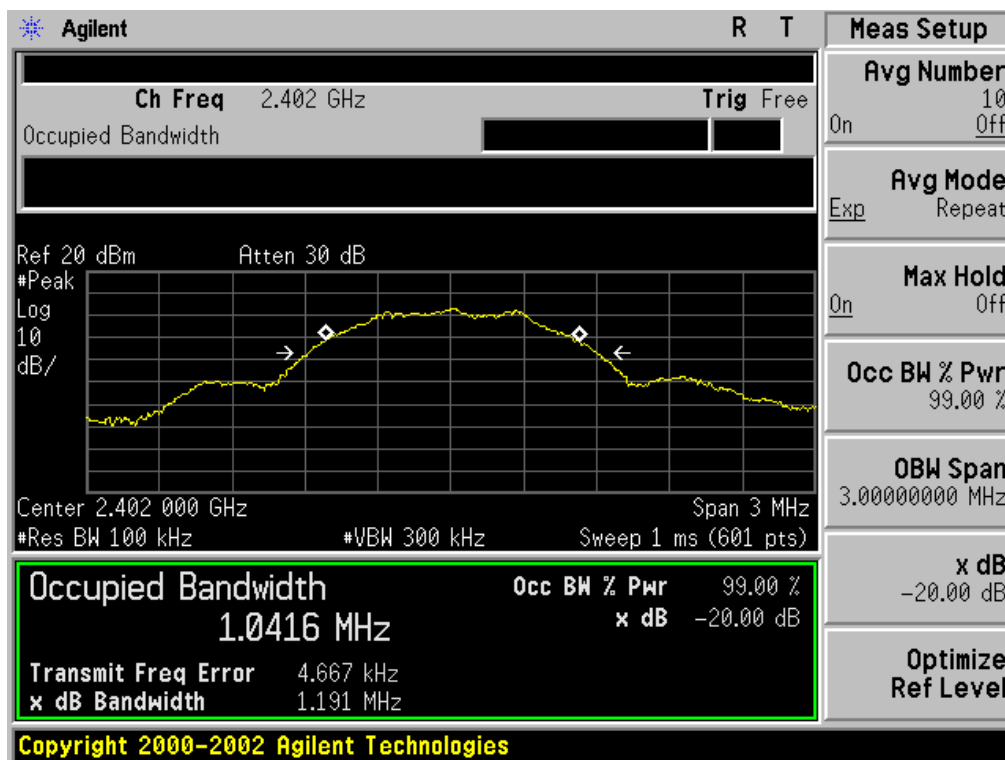

TEST PLOT OF BANDWIDTH FOR MIDDLE CHANNEL

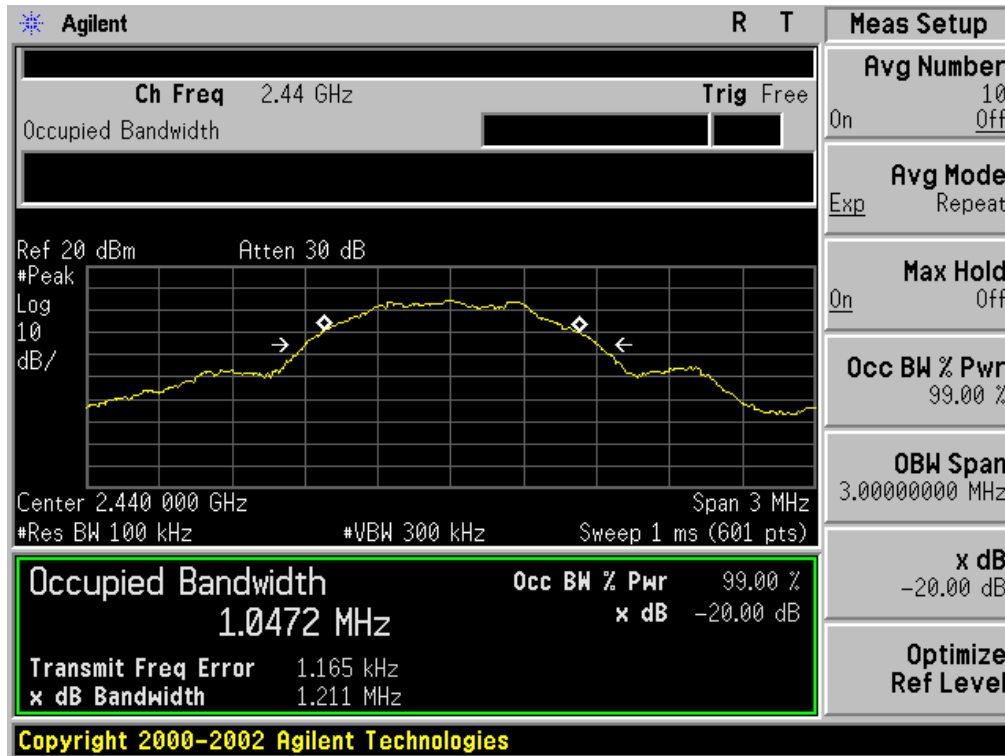

TEST PLOT OF BANDWIDTH FOR HIGH CHANNEL

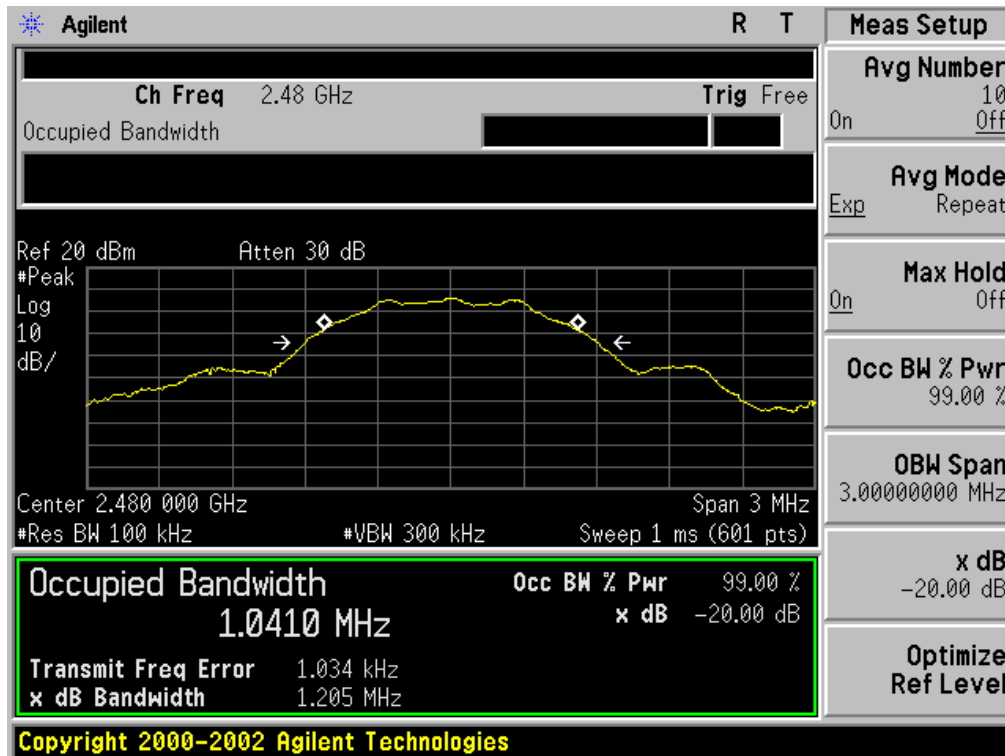

## 11. FCC LINE CONDUCTED EMISSION TEST

### 11.1. LIMITS OF LINE CONDUCTED EMISSION TEST

Frequency	Maximum RF Line Voltage	
	Q.P.( dBuV)	Average( dBuV)
150kHz~500kHz	66-56	56-46
500kHz~5MHz	56	46
5MHz~30MHz	60	50

Note:

1. The lower limit shall apply at the transition frequency.
2. The limit decreases linearly with the logarithm of the frequency in the range 0.15 MHz to 0.50 MHz.

### 11.2. BLOCK DIAGRAM OF LINE CONDUCTED EMISSION TEST

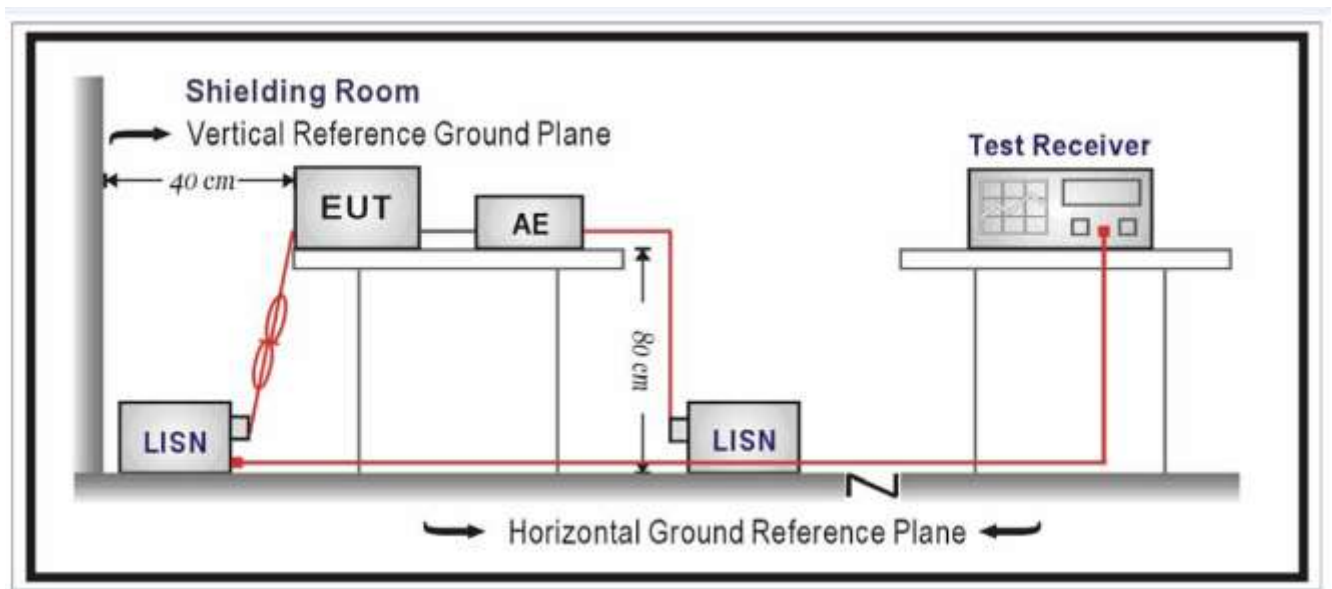

### **11.3. PRELIMINARY PROCEDURE OF LINE CONDUCTED EMISSION TEST**

1. The equipment was set up as per the test configuration to simulate typical actual usage per the user's manual. When the EUT is a tabletop system, a wooden table with a height of 0.8 meters is used and is placed on the ground plane as per ANSI C63.4 (see Test Facility for the dimensions of the ground plane used). When the EUT is a floor-standing equipment, it is placed on the ground plane which has a 3-12 mm non-conductive covering to insulate the EUT from the ground plane.
2. Support equipment, if needed, was placed as per ANSI C63.4.
3. All I/O cables were positioned to simulate typical actual usage as per ANSI C63.4.
4. All support equipments received AC120V/60Hz power from a LISN, if any.
5. The EUT received DC charging voltage by PC which received 120V/60Hz power by a LISN..
6. The test program was started. Emissions were measured on each current carrying line of the EUT using a spectrum Analyzer / Receiver connected to the LISN powering the EUT. The LISN has two monitoring points: Line 1 (Hot Side) and Line 2 (Neutral Side). Two scans were taken: one with Line 1 connected to Analyzer / Receiver and Line 2 connected to a 50 ohm load; the second scan had Line 1 connected to a 50 ohm load and Line 2 connected to the Analyzer / Receiver.
7. Analyzer / Receiver scanned from 150 kHz to 30MHz for emissions in each of the test modes.
8. During the above scans, the emissions were maximized by cable manipulation.
9. The test mode(s) were scanned during the preliminary test.

Then, the EUT configuration and cable configuration of the above highest emission level were recorded for reference of final testing.

### **11.4. FINAL PROCEDURE OF LINE CONDUCTED EMISSION TEST**

- EUT and support equipment was set up on the test bench as per step 2 of the preliminary test.
2. A scan was taken on both power lines, Line 1 and Line 2, recording at least the six highest emissions. Emission frequency and amplitude were recorded into a computer in which correction factors were used to calculate the emission level and compare reading to the applicable limit. If EUT emission level was less -2dB to the A.V. limit in Peak mode, then the emission signal was re-checked using Q.P and Average detector.
3. The test data of the worst case condition(s) was reported on the Summary Data page.

**11.5. TEST RESULT OF LINE CONDUCTED EMISSION TEST  
FOR TRADITIONAL BLUETOOTH**

Line Conducted Emission Test Line 1-L

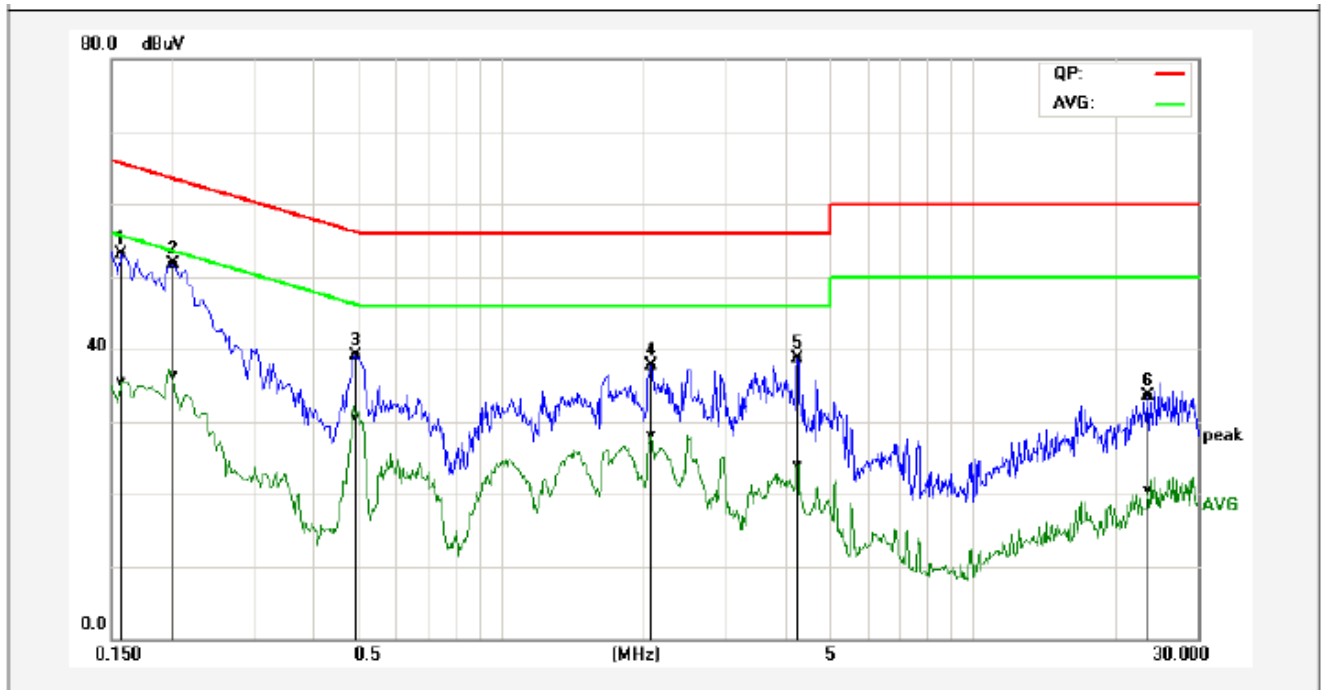

No.	Frequency (MHz)	QuasiPeak reading (dBuV)	Average reading (dBuV)	Correction factor (dB)	QuasiPeak result (dBuV)	Average result (dBuV)	QuasiPeak limit (dBuV)	Average limit (dBuV)	QuasiPeak margin (dB)	Average margin (dB)	Remark
1P	0.1580	43.43	25.87	9.60	53.03	35.47	65.56	55.57	-12.53	-20.10	Pass
2*	0.2020	42.05	26.59	9.69	51.74	36.28	63.52	53.53	-11.78	-17.25	Pass
3P	0.4940	29.51	20.98	9.68	39.19	30.66	56.10	46.10	-16.91	-15.44	Pass
4P	2.0820	27.87	18.37	9.73	37.60	28.10	56.00	46.00	-18.40	-17.90	Pass
5P	4.2580	29.07	14.21	9.69	38.76	23.90	56.00	46.00	-17.24	-22.10	Pass
6P	23.5500	23.67	10.70	9.87	33.54	20.57	60.00	50.00	-26.46	-29.43	Pass

Line Conducted Emission Test Line 2-N

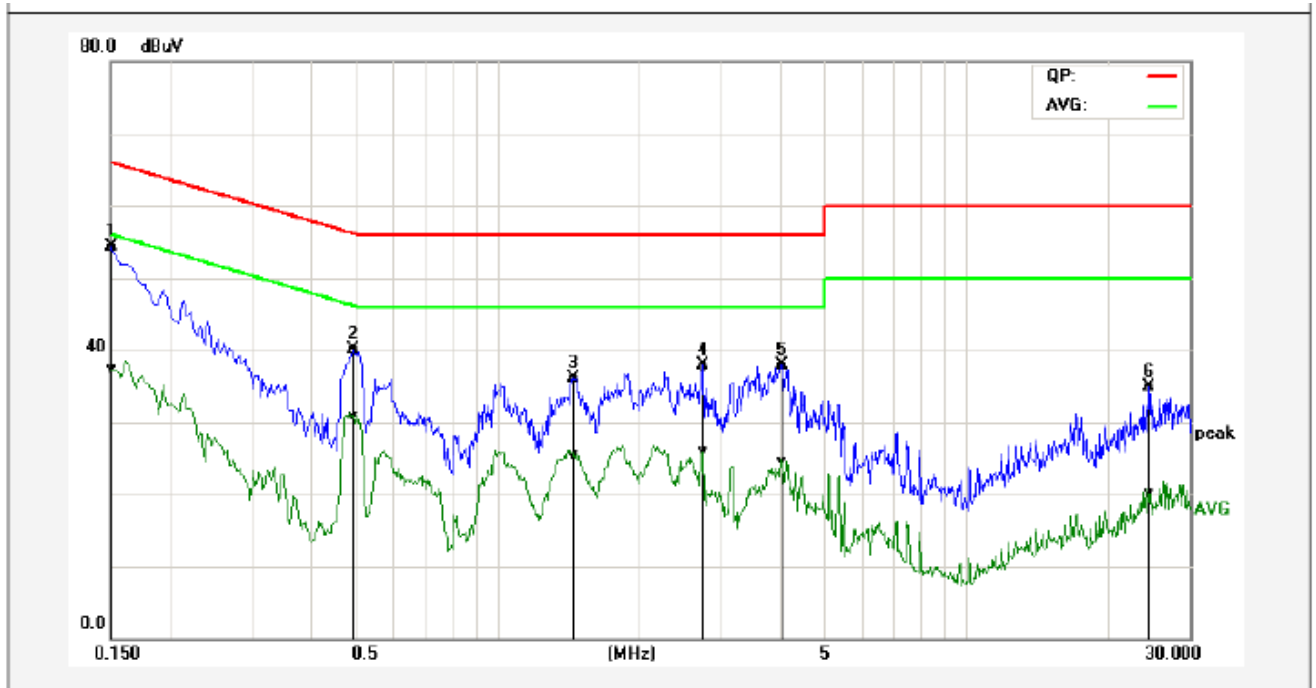

No.	Frequency (MHz)	QuasiPeak reading (dBuV)	Average reading (dBuV)	Correction factor (dB)	QuasiPeak result (dBuV)	Average result (dBuV)	QuasiPeak limit (dBuV)	Average limit (dBuV)	QuasiPeak margin (dB)	Average margin (dB)	Remark
1*	0.1500	44.60	27.55	9.78	54.38	37.33	65.99	56.00	-11.61	-18.67	Pass
2P	0.4940	30.43	21.21	9.68	40.11	30.89	56.10	46.10	-15.99	-15.21	Pass
3P	1.4580	26.33	15.76	9.77	36.10	25.53	56.00	46.00	-19.90	-20.47	Pass
4P	2.7460	28.06	16.23	9.74	37.80	25.97	56.00	46.00	-18.20	-20.03	Pass
5P	4.0500	28.11	14.71	9.76	37.87	24.47	56.00	46.00	-18.13	-21.53	Pass
6P	24.6500	25.09	10.31	9.79	34.88	20.10	60.00	50.00	-25.12	-29.90	Pass

FOR BLE

Line Conducted Emission Test Line 1-L

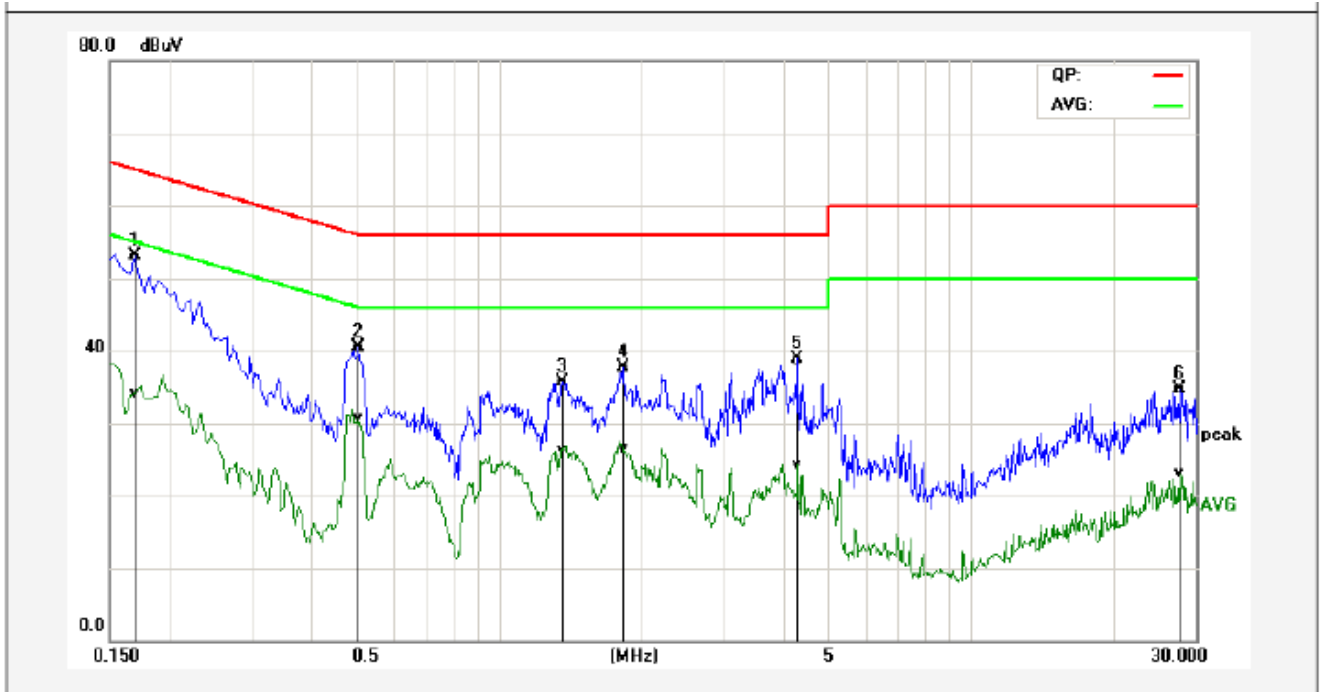

No.	Frequency (MHz)	QuasiPeak reading (dBuV)	Average reading (dBuV)	Correction factor (dB)	QuasiPeak result (dBuV)	Average result (dBuV)	QuasiPeak limit (dBuV)	Average limit (dBuV)	QuasiPeak margin (dB)	Average margin (dB)	Remark
1*	0.1700	43.43	24.55	9.62	53.05	34.17	64.96	54.96	-11.91	-20.79	Pass
2P	0.5060	30.86	21.05	9.68	40.54	30.73	56.00	46.00	-15.46	-15.27	Pass
3P	1.3700	25.95	16.62	9.72	35.67	26.34	56.00	46.00	-20.33	-19.66	Pass
4P	1.8300	27.91	16.81	9.73	37.64	26.54	56.00	46.00	-18.36	-19.46	Pass
5P	4.3020	29.11	14.61	9.69	38.80	24.30	56.00	46.00	-17.20	-21.70	Pass
6P	27.6580	24.75	13.08	9.95	34.70	23.03	60.00	50.00	-25.30	-26.97	Pass

Line Conducted Emission Test Line 2-N

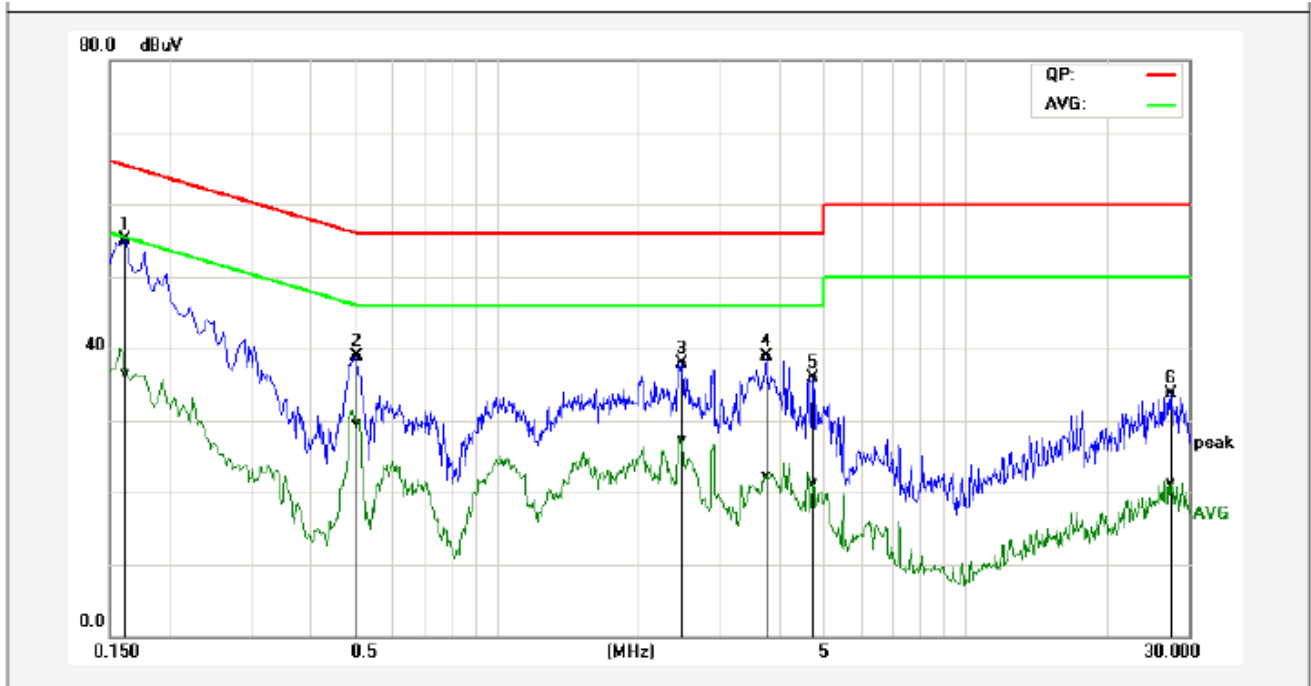

No.	Frequency (MHz)	QuasiPeak reading (dBuV)	Average reading (dBuV)	Correction factor (dB)	QuasiPeak result (dBuV)	Average result (dBuV)	QuasiPeak limit (dBuV)	Average limit (dBuV)	QuasiPeak margin (dB)	Average margin (dB)	Remark
1*	0.1620	45.42	26.64	9.78	55.20	36.42	65.36	55.36	-10.16	-18.94	Pass
2P	0.5020	29.22	19.78	9.68	38.90	29.46	56.00	46.00	-17.10	-16.54	Pass
3P	2.4900	28.10	17.52	9.74	37.84	27.26	56.00	46.00	-18.16	-18.74	Pass
4P	3.7660	29.23	12.58	9.76	38.99	22.34	56.00	46.00	-17.01	-23.66	Pass
5P	4.7380	26.20	11.47	9.78	35.98	21.25	56.00	46.00	-20.02	-24.75	Pass
6P	27.4660	23.93	11.49	9.84	33.77	21.33	60.00	50.00	-26.23	-28.67	Pass



## APPENDIX A: PHOTOGRAPHS OF TEST SETUP

### FCC LINE CONDUCTED EMISSION TEST SETUP



FCC RADIATED EMISSION TEST SETUP



**APPENDIX B: PHOTOGRAPHS OF EUT**  
TOP VIEW OF EUT



BOTTOM VIEW OF EUT



FRONT VIEW OF EUT



BACK VIEW OF EUT



LEFT VIEW OF EUT



RIGHT VIEW OF EUT

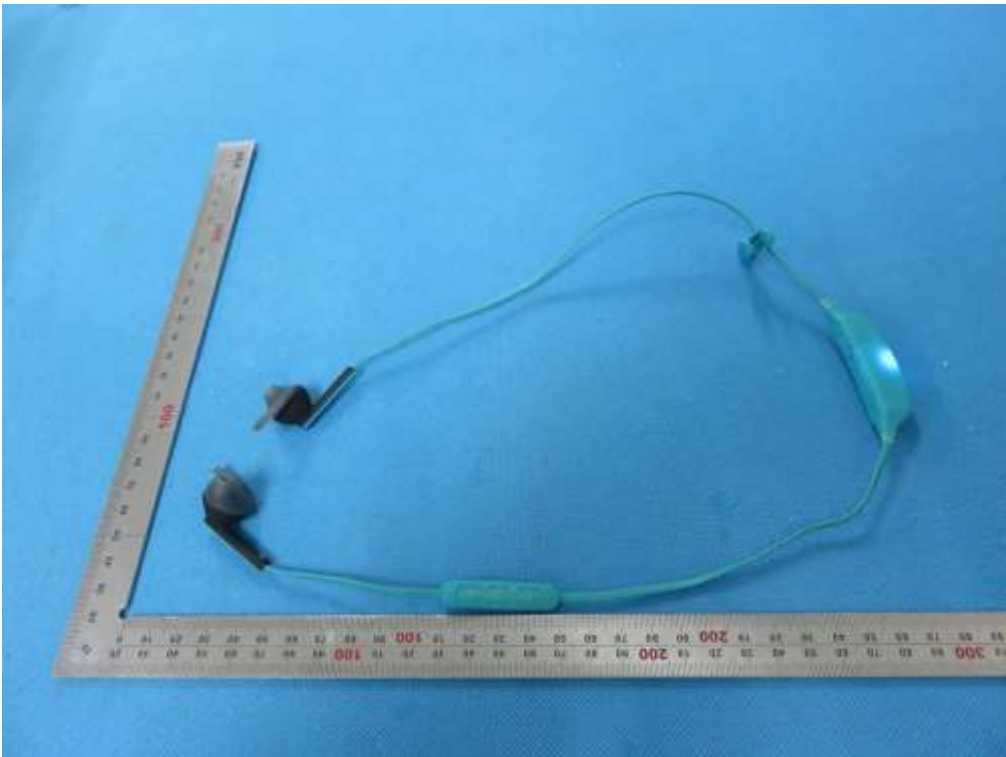



OPEN VIEW OF EUT



INTERNAL VIEW OF EUT-1

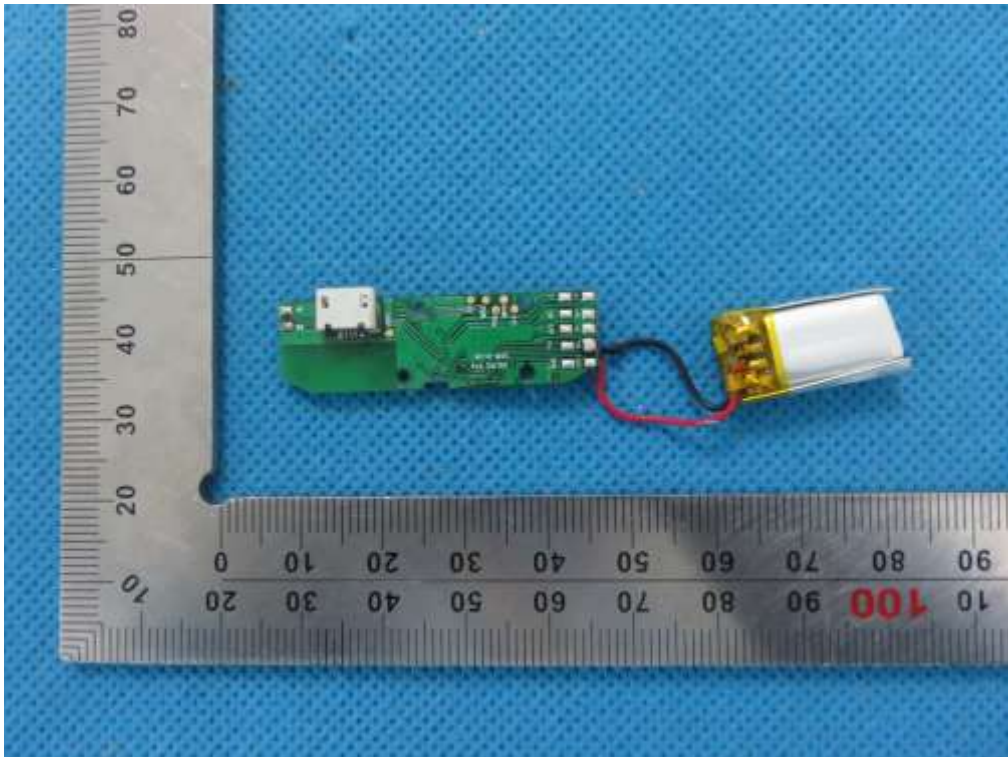

INTERNAL VIEW OF EUT-2

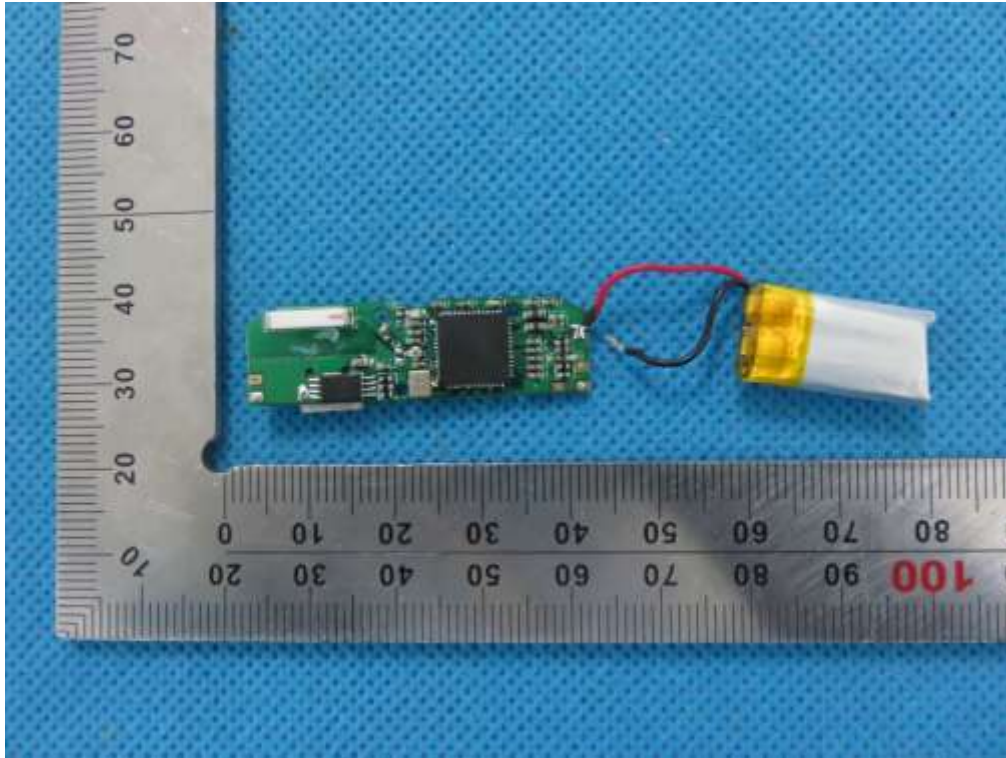

INTERNAL VIEW OF EUT-3

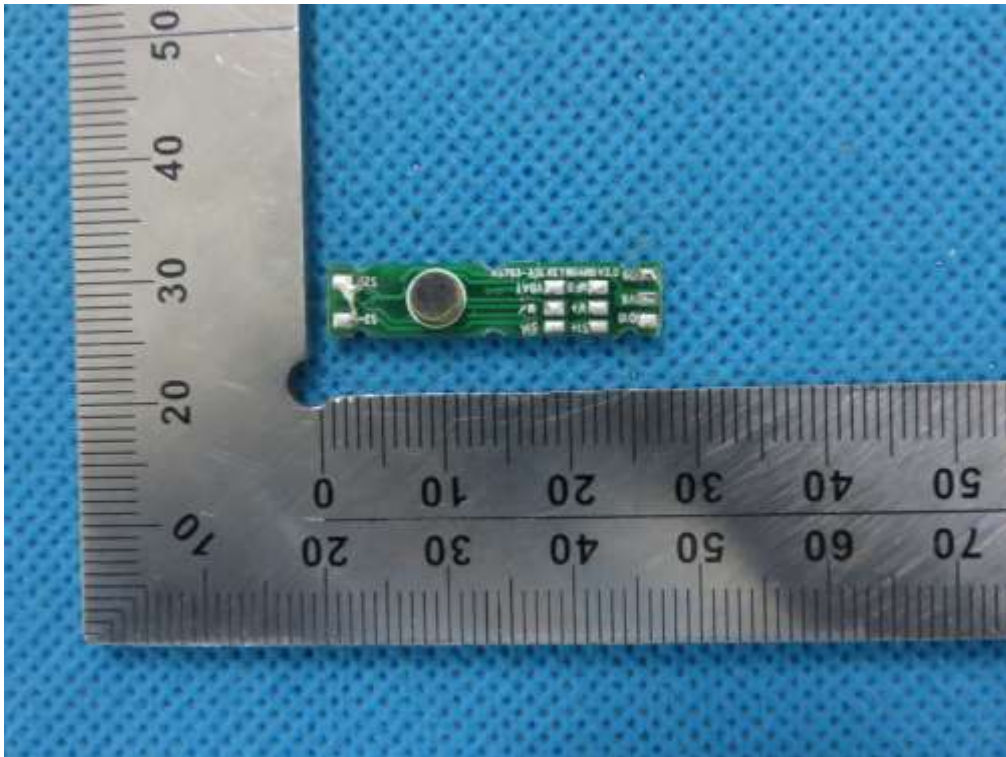

INTERNAL VIEW OF EUT-4

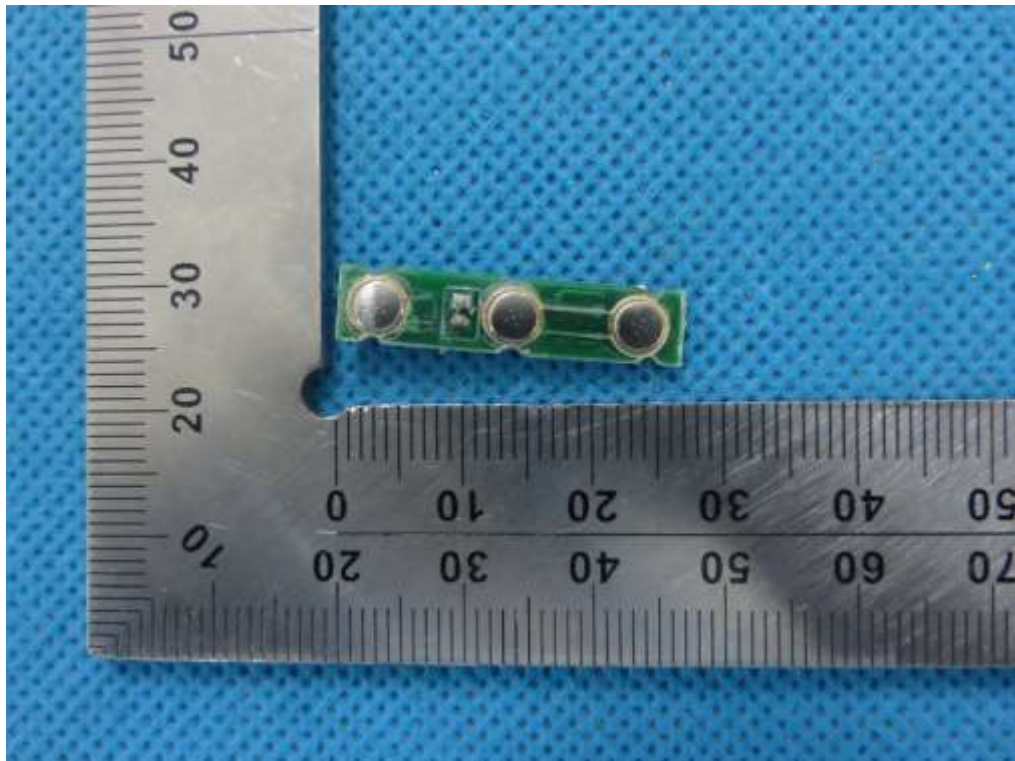

INTERNAL VIEW OF EUT-5

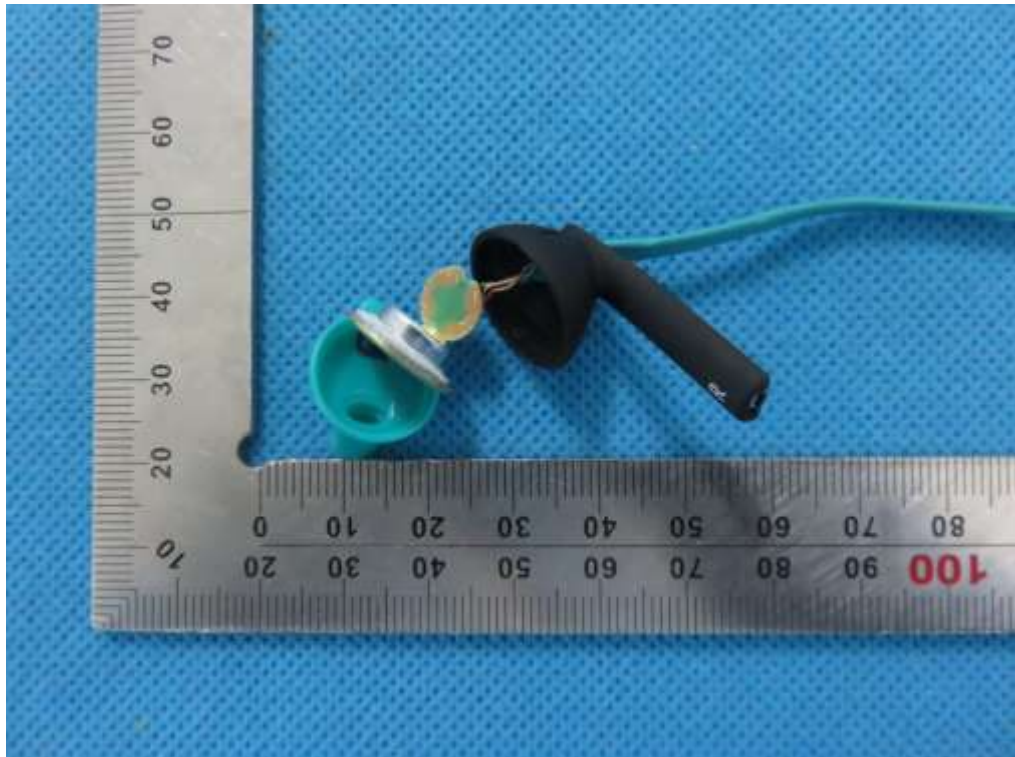



INTERNAL VIEW OF EUT-6

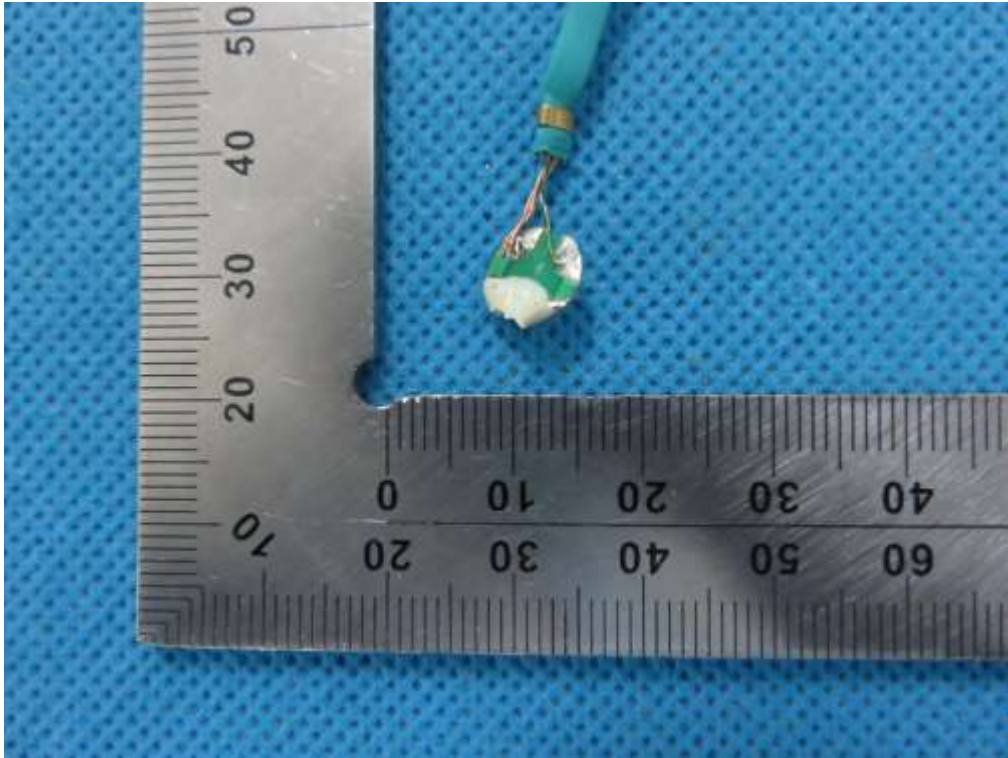

INTERNAL VIEW OF EUT-7

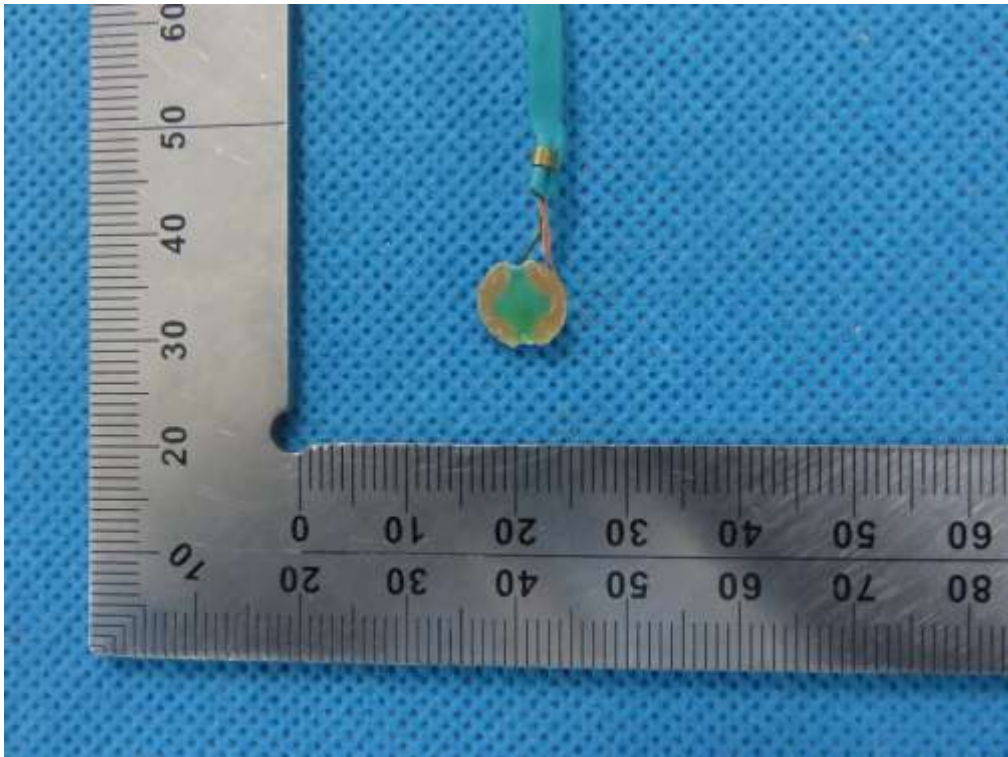



INTERNAL VIEW OF EUT-8

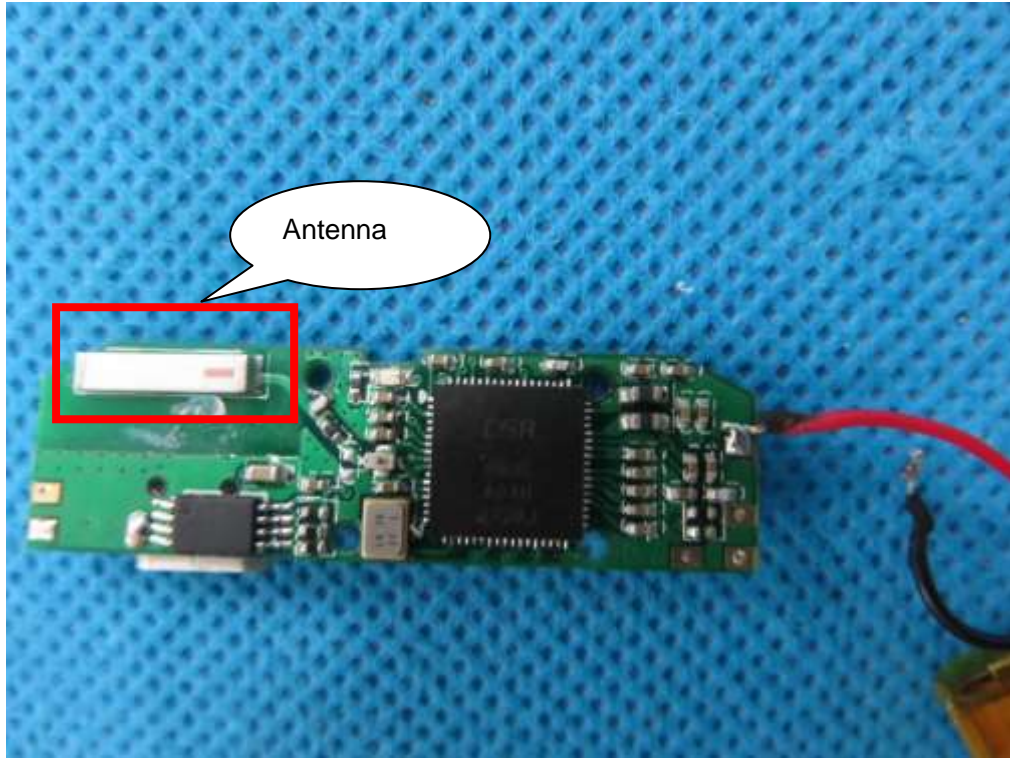

----END OF REPORT----