



# FCC PART 15 B TEST REPORT

For

## MAXWEST INTERNATIONAL LIMITED.

No.1,Longgang Road,Buji,Longgang,ShenzhenCity,Guangdong Province, P.R. China

**FCC ID: 2AEN3RANGERR3**

<b>Report Type:</b> Original Report	<b>Product Name:</b> Mobile Phone
<b>Test Engineer:</b> <i>Kevin Hu</i>	<i>Kevin hu</i>
<b>Report Number:</b> RDG161219003A	
<b>Report Date:</b> 2017-01-15	
<b>Reviewed By:</b> Henry Ding EMC Leader	<i>Henry Ding</i>
<b>Test Laboratory:</b>	Bay Area Compliance Laboratories Corp. (Chengdu) 5040, HuiLongWan Plaza, No. 1, ShaWan Road, JinNiu District, ChengDu, China Tel: 028-65523123, Fax: 028-65525125 <a href="http://www.baclcorp.com">www.baclcorp.com</a>

**Note:** This test report was prepared for the customer shown above and for the device described herein. It may not be duplicated or used in part without prior written consent from Bay Area Compliance Laboratories Corp. (Chengdu). Any unauthorized alteration, forgery or falsification of the content or appearance of this document is unlawful and offenders may be prosecuted to the fullest extent of the law. This report was valid only with a valid digital signature.

## TABLE OF CONTENTS

<b>GENERAL INFORMATION .....</b>	<b>3</b>
PRODUCT DESCRIPTION FOR EQUIPMENT UNDER TEST (EUT) .....	3
OBJECTIVE .....	3
RELATED SUBMITTAL(S)/GRANT(S).....	3
TEST METHODOLOGY .....	4
TEST FACILITY.....	4
<b>SYSTEM TEST CONFIGURATION.....</b>	<b>5</b>
DESCRIPTION OF TEST CONFIGURATION .....	5
EUT EXERCISE SOFTWARE.....	5
EQUIPMENT MODIFICATIONS .....	5
LOCAL SUPPORT EQUIPMENT LIST AND DETAILS .....	5
SUPPORT CABLE LIST AND DETAILS .....	5
CONFIGURATION OF TEST SETUP .....	6
<b>SUMMARY OF TEST RESULTS.....</b>	<b>7</b>
<b>FCC§15.107 - CONDUCTED EMISSIONS .....</b>	<b>8</b>
MEASUREMENT UNCERTAINTY .....	8
EUT SETUP .....	8
EMI TEST RECEIVER SETUP .....	9
TEST EQUIPMENT LIST AND DETAILS .....	9
TEST PROCEDURE.....	9
CORRECTED AMPLITUDE & MARGIN CALCULATION .....	9
TEST DATA.....	10
<b>FCC §15.109 - RADIATED SPURIOUS EMISSIONS.....</b>	<b>13</b>
MEASUREMENT UNCERTAINTY .....	13
EUT SETUP .....	14
EMI TEST RECEIVER SETUP .....	15
TEST PROCEDURE.....	15
TEST EQUIPMENT LIST AND DETAILS .....	16
CORRECTED AMPLITUDE & MARGIN CALCULATION .....	16
TEST DATA.....	17

## **GENERAL INFORMATION**

---

### **Product Description for Equipment Under Test (EUT)**

The **MAXWEST INTERNATIONAL LIMITED.**'s product, model number: **RANGER R3 (FCC ID: 2AEN3RANGERR3)** (the "EUT") in this report was a **Mobile Phone**, which was measured approximately: 13 cm (L) × 5.6 cm (W) × 1.95 cm (H), rated input voltage: DC3.7V rechargeable Li-ion battery or DC5V from adapter. The highest operation frequency is 2480 MHz.

#### Adapter Information:

INPUT: AC 100-240V

OUTPUT: DC 5.0V, 500mA

*\*All measurement and test data in this report was gathered from final production sample, serial number: 161219003 (assigned by the BAACL, Chengdu). It may have deviation from any other sample. The EUT supplied by the applicant was received on 2016-12-19, and EUT conformed to test requirement.*

### **Objective**

This test report is prepared on behalf of **MAXWEST INTERNATIONAL LIMITED.** in accordance with Part 2, Subpart J, and Part 15-Subparts A and B of the Federal Communications Commission's rules.

The objective of the manufacturer is to determine the compliance of EUT with FCC Part 15 B Class B.

### **Related Submittal(s)/Grant(s)**

FCC Part 15C DSS submissions with FCC ID: 2AEN3RANGERR3.

FCC Part 22H, 24E PCE submissions with FCC ID: 2AEN3RANGERR3.

## Test Methodology

All measurements contained in this report were conducted with ANSI C63.4-2014, American National Standard for Methods of Measurement of Radio-Noise Emissions from Low-Voltage Electrical and Electronic Equipment in the range of 9 kHz to 40 GHz.

The uncertainty of any RF tests which use conducted method measurement is  $\pm 3.17$  dB, the uncertainty of any radiation on emissions measurement is:

30M~200MHz:  $\pm 4.7$  dB;  
200M~1GHz:  $\pm 6.0$  dB;  
1G~6GHz:  $\pm 5.13$  dB;  
6G~25GHz:  $\pm 5.47$  dB;

And the uncertainty will not be taken into consideration for all test data recorded in the report.

## Test Facility

The test site used by BACL to collect test data is located in the 5040, HuiLongWan Plaza, No. 1, ShaWan Road, JinNiu District, ChengDu, China.

Test site at BACL has been fully described in reports submitted to the Federal Communication Commission (FCC). The details of these reports have been found to be in compliance with the requirements of Section 2.948 of the FCC Rules on April 24, 2015. The facility also complies with the radiated and AC line conducted test site criteria set forth in ANSI C63.4-2014.

The Federal Communications Commission has the reports on file and is listed under FCC Registration No.: 560332. The test site has been approved by the FCC for public use and is listed in the FCC Public Access Link (PAL) database.

## **SYSTEM TEST CONFIGURATION**

---

### **Description of Test Configuration**

The system was configured for testing in a typical fashion (as normally used by a typical user).

### **EUT Exercise Software**

The software "winthrax.exe" was used during test.

### **Equipment Modifications**

No modification was made to the EUT tested.

### **Local Support Equipment List and Details**

<b>Manufacturer</b>	<b>Description</b>	<b>Model</b>	<b>Serial Number</b>
IBM	PC	8176	99Y7315
DELL	Display	E157FPC	060229-11
ANTER	Modem	EGW802	0508350054-1B
Lenovo	Keyboard	KB-US19EB	IMHYX011071016460
Lenovo	Mouse	MO-5013U	IMJS011041409259

### **Support Cable List and Details**

<b>Cable Description</b>	<b>Shielding Type</b>	<b>Ferrite Core</b>	<b>Length (m)</b>	<b>From Port</b>	<b>To</b>
Serial Cable	yes	No	1.6	Serial Port of PC	Modem
Mouse Cable	yes	No	1.4	Parallel Port of PC	Mouse
Keyboard Cable	yes	No	1.3	USB Port of PC	Keyboard
VGA Cable	yes	yes	1.8	VGA Port of PC	Display
Earphone Cable	no	No	1.22	Audio Port of EUT	Earphone
USB Cable	yes	no	1.01	PC	EUT

### Configuration of Test Setup

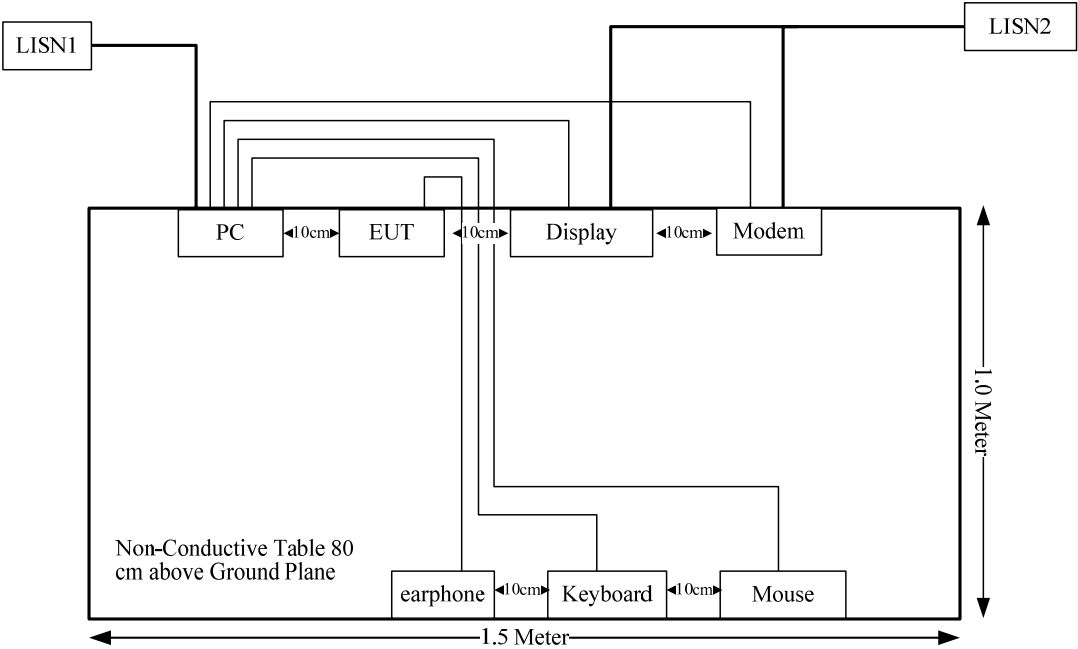

## **SUMMARY OF TEST RESULTS**

---

<b>FCC Rules</b>	<b>Description of Test</b>	<b>Results</b>
§15.107	Conducted Emissions	Compliance
§15.109	Radiated Emissions	Compliance

## FCC§15.107 - CONDUCTED EMISSIONS

### Measurement Uncertainty

All measurements involve certain levels of uncertainties, especially in field of EMC. The factors contributing to uncertainties are Receiver, cable loss, and LISN.

Compliance or non-compliance with a disturbance limit shall be determined in the following manner:

If  $U_{lab}$  is less than or equal to  $U_{cispr}$  of Table 1, then:

- compliance is deemed to occur if no measured disturbance level exceeds the disturbance limit;
- non-compliance is deemed to occur if any measured disturbance level exceeds the disturbance limit.

If  $U_{lab}$  is greater than  $U_{cispr}$  of Table 1, then:

- compliance is deemed to occur if no measured disturbance level, increased by  $(U_{lab} - U_{cispr})$ , exceeds the disturbance limit;
- non-compliance is deemed to occur if any measured disturbance level, increased by  $(U_{lab} - U_{cispr})$ , exceeds the disturbance limit.

Based on CISPR 16-4-2:2011, measurement uncertainty of conducted disturbance at mains port using AMN at Bay Area Compliance Laboratories Corp. (Chengdu) is  $\pm 3.17$  dB (150 kHz to 30 MHz).

Table 1 – Values of  $U_{cispr}$

Measurement	$U_{cispr}$
Conducted disturbance at mains port using AMN (150 kHz to 30 MHz)	3.4 dB

### EUT Setup

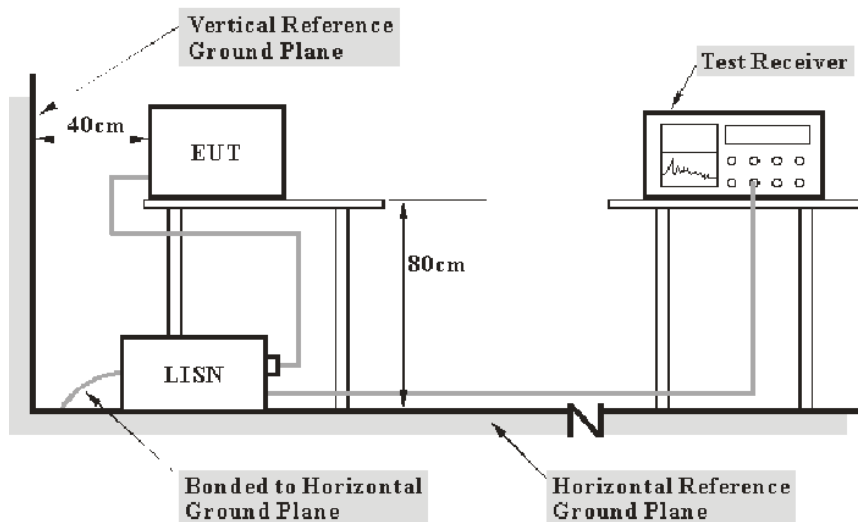

- Note: 1. Support units were connected to second LISN.  
 2. Both of LISNs (AMN) 80 cm from EUT and at the least 80 cm from other units and other metal planes support units.



The setup of EUT is according with per ANSI C63.4-2014 measurement procedure. The specification used was with the FCC Part 15 B Class B limits.

The external I/O cables were draped along the test table and formed a bundle 30 to 40 cm long in the middle.

The PC was connected to a 120V/60Hz AC power source.

### EMI Test Receiver Setup

The EMI test receiver was set to investigate the spectrum from 150 kHz to 30 MHz.

During the conducted emission test, the EMI test receiver was set with the following configurations:

Frequency Range	IF B/W
150 kHz – 30 MHz	9 kHz

### Test Equipment List and Details

Manufacturer	Description	Model	Serial Number	Calibration Date	Calibration Due Date
Rohde & Schwarz	EMI Test Receiver	ESCS 30	836858/0016	2016-12-02	2017-12-01
Rohde & Schwarz	L.I.S.N.	ENV216	3560.6550.06	2016-12-02	2017-12-01
N/A	Conducted Cable	NO.5	N/A	2016-11-10	2017-11-09
Rohde & Schwarz	PULSE LIMITER	ESH3Z2	357.8810.52	2016-10-31	2017-10-30
R&S	Test Software	EMC32	Version8.53.0	N/A	N/A

\* **Statement of Traceability:** BAAC (Chengdu) attested that all calibrations have been performed, traceable to National Primary Standards and International System of Units (SI).

### Test Procedure

During the conducted emission test, the adapter of laptop was connected to the outlet of the first LISN and the other support equipments were connected to the outlet of the second LISN.

Maximizing procedure was performed on the six (6) highest emissions of the EUT.

All data was recorded in the Quasi-peak and average detection mode.

### Corrected Amplitude & Margin Calculation

The basic equation is as follows:

$$V_C = V_R + A_C + VDF$$

Herein,

V<sub>C</sub>: corrected voltage amplitude

V<sub>R</sub>: reading voltage amplitude

A<sub>C</sub>: attenuation caused by cable loss

VDF: voltage division factor of AMN or ISN

The “**Margin**” column of the following data tables indicates the degree of compliance within the applicable limit. For example, a margin of 7dB means the emission is 7dB below the maximum limit. The equation for margin calculation is as follows:

$$\text{Margin} = \text{Limit} - \text{Corrected Amplitude}$$

## Test Data

### Environmental Conditions

<b>Temperature:</b>	22.8 °C
<b>Relative Humidity:</b>	30%
<b>ATM Pressure:</b>	101.8kPa

*The testing was performed by Kevin Hu on 2016-12-29.*

Test Mode: Downloading

**AC120V, 60Hz, Line:**

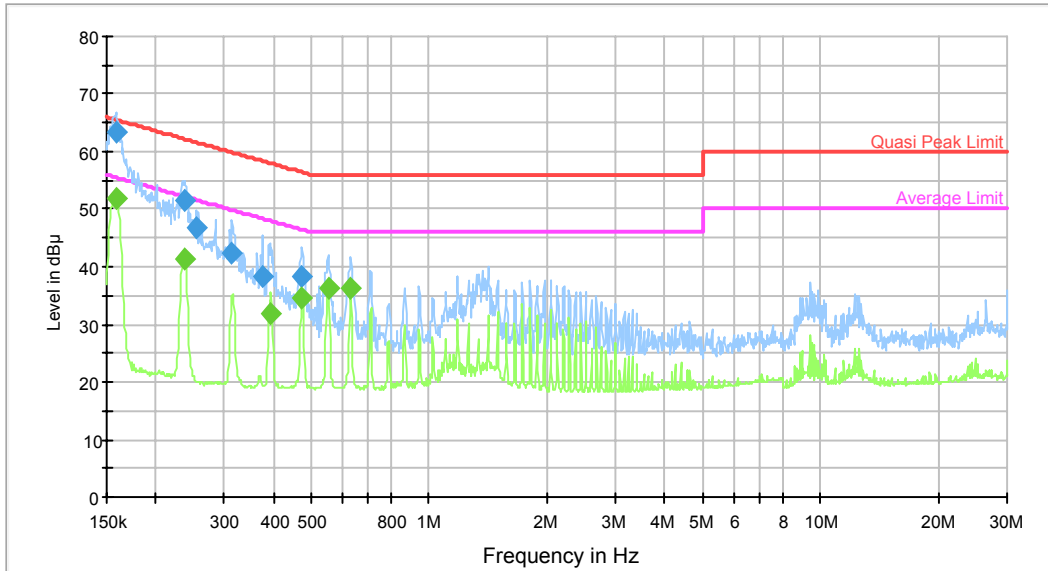

Frequency (MHz)	QuasiPeak (dBµV)	Bandwidth (kHz)	Line	Corr. (dB)	Margin (dB)	Limit (dBµV)	Comment
0.158622	63.3	9.000	L1	19.7	2.2	65.5	Compliance
0.237393	51.4	9.000	L1	19.6	10.8	62.2	Compliance
0.255079	46.7	9.000	L1	19.6	14.9	61.6	Compliance
0.313927	42.5	9.000	L1	19.6	17.4	59.9	Compliance
0.375704	38.2	9.000	L1	19.6	20.2	58.4	Compliance
0.473588	38.2	9.000	L1	19.6	18.3	56.5	Compliance

Frequency (MHz)	Average (dBµV)	Bandwidth (kHz)	Line	Corr. (dB)	Margin (dB)	Limit (dBµV)	Comment
0.158622	51.9	9.000	L1	19.7	3.6	55.5	Compliance
0.237393	41.3	9.000	L1	19.6	10.9	52.2	Compliance
0.394140	31.8	9.000	L1	19.6	16.2	48.0	Compliance
0.473588	34.7	9.000	L1	19.6	11.8	46.5	Compliance
0.553370	36.1	9.000	L1	19.6	9.9	46.0	Compliance
0.631289	36.3	9.000	L1	19.6	9.7	46.0	Compliance

**AC120V, 60Hz, Neutral:**

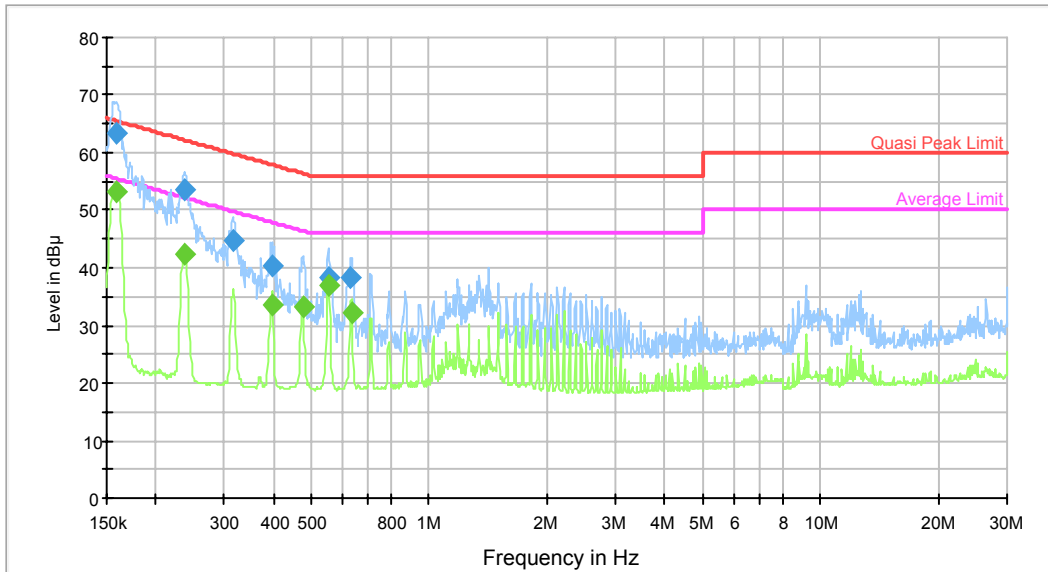

Frequency (MHz)	QuasiPeak (dBµV)	Bandwidth (kHz)	Line	Corr. (dB)	Margin (dB)	Limit (dBµV)	Comment
0.157990	63.4	9.000	N	19.7	2.2	65.6	Compliance
0.237393	53.5	9.000	N	19.7	8.7	62.2	Compliance
0.316443	44.8	9.000	N	19.7	15.0	59.8	Compliance
0.397299	40.4	9.000	N	19.7	17.5	57.9	Compliance
0.553370	38.4	9.000	N	19.7	17.6	56.0	Compliance
0.631289	38.3	9.000	N	19.7	17.7	56.0	Compliance

Frequency (MHz)	Average (dBµV)	Bandwidth (kHz)	Line	Corr. (dB)	Margin (dB)	Limit (dBµV)	Comment
0.158622	53.3	9.000	N	19.7	2.2	55.5	Compliance
0.237393	42.4	9.000	N	19.7	9.8	52.2	Compliance
0.397299	33.4	9.000	N	19.7	14.5	47.9	Compliance
0.475483	33.4	9.000	N	19.7	13.0	46.4	Compliance
0.553370	37.1	9.000	N	19.7	8.9	46.0	Compliance
0.633814	32.2	9.000	N	19.7	13.8	46.0	Compliance

## FCC §15.109 - RADIATED SPURIOUS EMISSIONS

### Measurement Uncertainty

Compliance or non-compliance with a disturbance limit shall be determined in the following manner:

If  $U_{lab}$  is less than or equal to  $U_{cispr}$  of Table 2, then:

- compliance is deemed to occur if no measured disturbance level exceeds the disturbance limit;
- non-compliance is deemed to occur if any measured disturbance level exceeds the disturbance limit.

If  $U_{lab}$  is greater than  $U_{cispr}$  of Table 2, then:

- compliance is deemed to occur if no measured disturbance level, increased by  $(U_{lab} - U_{cispr})$ , exceeds the disturbance limit;
- non-compliance is deemed to occur if any measured disturbance level, increased by  $(U_{lab} - U_{cispr})$ , exceeds the disturbance limit.

Based on CISPR 16-4-2-2011, measurement uncertainty of radiated emission at a distance of 3m at Bay Area Compliance Laboratories Corp. (Chengdu) is:

30M~200MHz:  $\pm 4.7$  dB;

200M~1GHz:  $\pm 6.0$  dB;

1G~6GHz:  $\pm 5.13$  dB;

6G~25GHz:  $\pm 5.47$  dB;

Table 2 – Values of  $U_{cispr}$

Measurement		$U_{cispr}$
Radiated disturbance (electric field strength at an OATS or in a SAC)	(30 MHz to 1000 MHz)	6.3 dB
Radiated disturbance (electric field strength in a FAR)	(1 GHz to 6 GHz)	5.2 dB
Radiated disturbance (electric field strength in a FAR)	(6 GHz to 18 GHz)	5.5 dB

## EUT Setup

Below 1GHz:

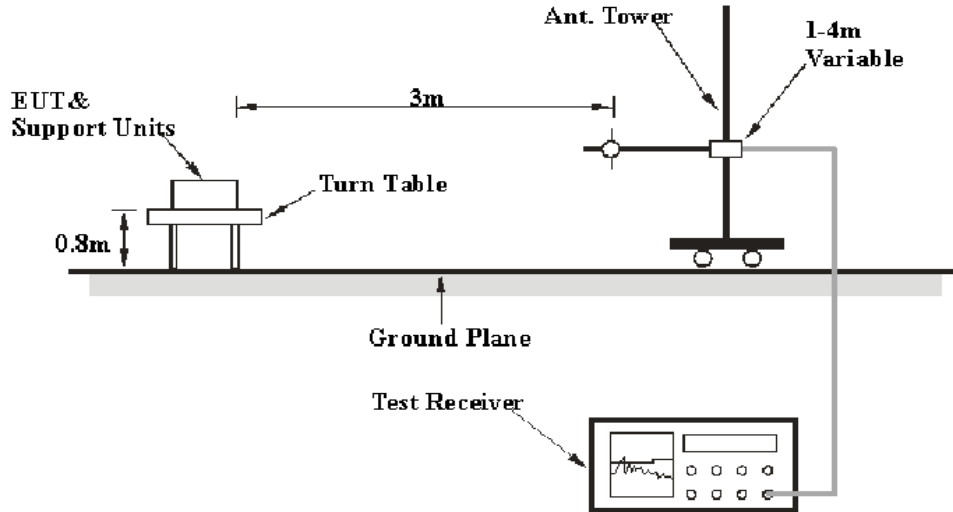

Above 1GHz:

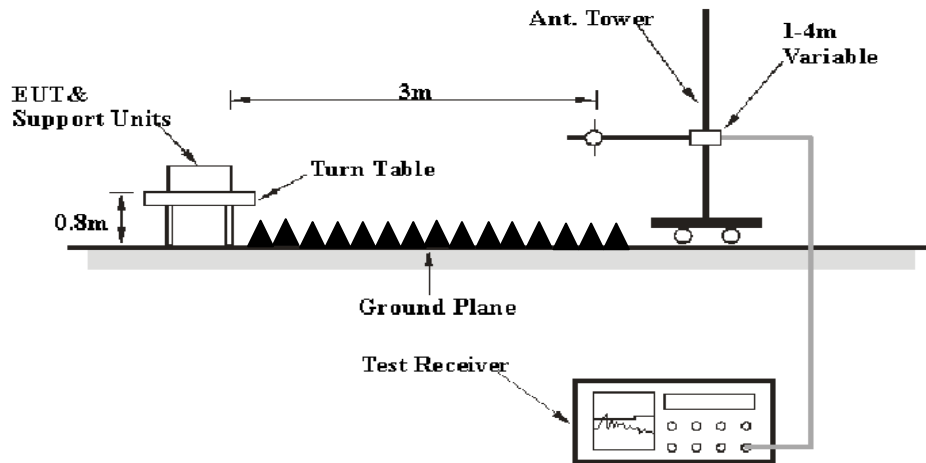

The radiated emission tests were performed at the 3 meters distance in chamber, using the setup accordance with the ANSI C63.4-2014. The specification used was the FCC Part 15.109 Class B limits.

## EMI Test Receiver Setup

The system was investigated from 30 MHz to 13.0 GHz.

During the radiated emission test, the EMI test receiver was set with the following configurations:

Frequency Range	RBW	Video B/W	IF B/W	Detector
30 MHz – 1000 MHz	120 kHz	300 kHz	120 kHz	QP
Above 1 GHz	1 MHz	3 MHz	/	Peak
	1 MHz	10 Hz	/	AVG

## Test Procedure

During the radiated emissions, the adapter of laptop was connected to the first AC floor outlet and the other support equipments were connected to the second AC floor outlet.

Maximizing procedure was performed on the highest emissions to ensure that the EUT complied with all installation combinations.

The data was recorded in the Quasi-peak detection mode for below 1 GHz, peak and average detection mode above 1 GHz.

### Test Equipment List and Details

Manufacturer	Description	Model	Serial Number	Calibration Date	Calibration Due Date
Agilent	Amplifier	8447D	2944A10442	2016-12-02	2017-12-01
Rohde & Schwarz	EMI Test Receiver	ESCI	100028	2016-12-02	2017-12-01
Sunol Sciences	Broadband Antenna	JB3	A101808	2016-04-10	2019-04-09
Rohde & Schwarz	Spectrum Analyzer	FSEM30	100018	2016-12-02	2017-12-01
ETS	Horn Antenna	3115	003-6076	2016-12-02	2017-12-01
Mini-circuits	Amplifier	ZVA-183-S+	771001215	2016-05-20	2017-05-19
EMCT	Semi-Anechoic Chamber	966	N/A	2015-04-24	2018-04-23
N/A	RF Cable (below 1GHz)	NO.1	N/A	2016-11-10	2017-11-09
N/A	RF Cable (below 1GHz)	NO.4	N/A	2016-11-10	2017-11-09
N/A	RF Cable (above 1GHz)	NO.2	N/A	2016-11-10	2017-11-09

\* **Statement of Traceability:** BACL (Chengdu) attested that all calibrations have been performed, traceable to National Primary Standards and International System of Units (SI).

### Corrected Amplitude & Margin Calculation

The Corrected Amplitude is calculated by adding the Antenna Loss and Cable Loss, and subtracting the Amplifier Gain from the Meter Reading. The basic equation is as follows:

$$\text{Corrected Amplitude} = \text{Meter Reading} + \text{Antenna Loss} + \text{Cable Loss} - \text{Amplifier Gain}$$

The “**Margin**” column of the following data tables indicates the degree of compliance with the applicable limit. For example, a margin of 7 dB means the emission is 7 dB below the limit. The equation for margin calculation is as follows:

$$\text{Margin} = \text{Limit} - \text{Corrected Amplitude}$$



## Test Data

### Environmental Conditions

<b>Temperature:</b>	23.3 °C
<b>Relative Humidity:</b>	49%
<b>ATM Pressure:</b>	101.1 kPa

\* The testing was performed by Kevin Hu on 2017-01-05.

Test Result: Compliance

Test Mode: Downloading

### 1) Below 1GHz:

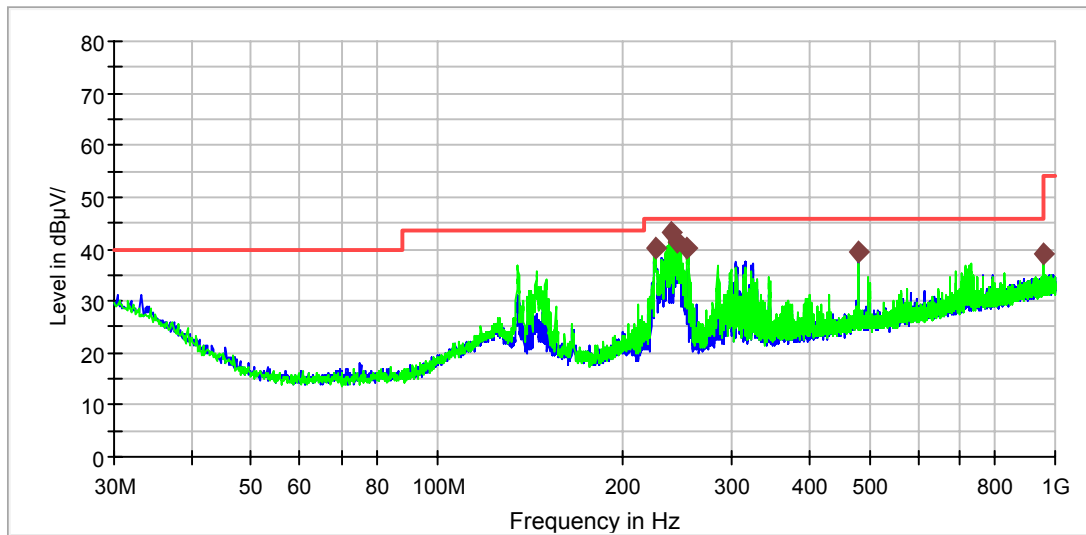

Frequency (MHz)	QuasiPeak (dBµV/m)	Height (cm)	Polarization	Azimuth (deg)	Corr. (dB)	Margin (dB)	Limit (dBµV/m)
226.182500	40.2	200.0	H	88.0	-6.3	5.8	46.0
240.126250	43.3	200.0	V	309.0	-5.7	2.7	46.0
244.006250	41.3	100.0	H	191.0	-5.7	4.7	46.0
254.191250	40.2	100.0	H	96.0	-5.4	5.8	46.0
480.080000	39.5	100.0	V	184.0	-0.4	6.5	46.0
959.987500	38.9	200.0	H	123.0	7.0	7.1	46.0

2) 1GHz-13GHz:

Frequency (MHz)	Receiver		Rx Antenna		Cable loss (dB)	Amplifier Gain (dB)	Corrected Amplitude (dBµV/m)	Limit (dBµV/m)	Margin (dB)
	Reading (dBµV)	Detector	Polar (H/V)	Factor (dB)					
1200.4	44.76	PK	H	23.32	2.26	26.62	43.72	74.00	30.28
1200.4	32.34	AV	H	23.32	2.26	26.62	31.30	54.00	22.70
1611.22	44.61	PK	H	24.28	2.75	26.44	45.20	74.00	28.80
1611.22	32.25	AV	H	24.28	2.75	26.44	32.84	54.00	21.16
1761.52	49.68	PK	H	24.52	2.87	26.59	50.48	74.00	23.52
1761.52	37.19	AV	H	24.52	2.87	26.59	37.99	54.00	16.01
1270.54	47.57	PK	V	23.50	2.35	26.55	46.87	74.00	27.13
1270.54	35.11	AV	V	23.50	2.35	26.55	34.41	54.00	19.59
1601.2	47.69	PK	V	24.26	2.75	26.43	48.27	74.00	25.73
1601.2	35.28	AV	V	24.26	2.75	26.43	35.86	54.00	18.14
1811.62	47.81	PK	V	24.60	2.91	26.64	48.68	74.00	25.32
1811.62	35.29	AV	V	24.60	2.91	26.64	36.16	54.00	17.84

\*\*\*\*\* END OF REPORT \*\*\*\*\*