

FCC&IC Radio Test Report

FCC ID: 2AEMI-PHOTON

IC: 20127-PHOTON

This report concerns (check one): Original Grant Class II Change

Project No. : 1504C213
Equipment : PHOTON
Model Name : PHOTONH
Applicant : Spark Labs, Inc.,
Address : 320 Alabama St #2, San Francisco, CA 94110

Date of Receipt : Apr. 22, 2015
Date of Test : Apr. 22, 2015 ~ May 21, 2015
Issued Date : May 22, 2015
Tested by : BTL Inc.

Testing Engineer : David Mao
(David Mao)

Technical Manager : Leo Hung
(Leo Hung)

Authorized Signatory : Steven Lu
(Steven Lu)

B T L I N C .

No.3, Jinshagang 1st Road, Shixia, Dalang Town, Dongguan,
Guangdong, China.

TEL: +86-769-8318-3000 FAX: +86-769-8319-6000

Declaration

BTL represents to the client that testing is done in accordance with standard procedures as applicable and that test instruments used has been calibrated with the standards traceable to National Measurement Laboratory (**NML**) of **R.O.C**, or National Institute of Standards and Technology (**NIST**) of **U.S.A**.

BTL's reports apply only to the specific samples tested under conditions. It is manufacture's responsibility to ensure that additional production units of this model are manufactured with the identical electrical and mechanical components. **BTL** shall have no liability for any declarations, inferences or generalizations drawn by the client or others from **BTL** issued reports.

BTL's report must not be used by the client to claim product certification, approval, or endorsement by NVLAP, NIST, or any agency of the Federal Government.

This report is the confidential property of the client. As a mutual protection to the clients, the public and **BTL-self**, extracts from the test report shall not be reproduced except in full with **BTL's** authorized written approval.

BTL's laboratory quality assurance procedures are in compliance with the **ISO Guide 17025** requirements, and accredited by the conformity assessment authorities listed in this test report.

Limitation

For the use of the authority's logo is limited unless the Test Standard(s)/Scope(s)/Item(s) mentioned in this test report is (are) included in the conformity assessment authorities acceptance respective.

Table of Contents	Page
1 . CERTIFICATION	6
2 . SUMMARY OF TEST RESULTS	7
2.1 TEST FACILITY	8
2.2 MEASUREMENT UNCERTAINTY	8
3 . GENERAL INFORMATION	9
3.1 GENERAL DESCRIPTION OF EUT	9
3.2 DESCRIPTION OF TEST MODES	11
3.3 TABLE OF PARAMETERS OF TEXT SOFTWARE SETTING	12
3.4 BLOCK DIAGRAM SHOWING THE CONFIGURATION OF SYSTEM TESTED	13
3.5 DESCRIPTION OF SUPPORT UNITS	13
4 . EMC EMISSION TEST	14
4.1 CONDUCTED EMISSION MEASUREMENT	14
4.1.1 POWER LINE CONDUCTED EMISSION LIMITS	14
4.1.2 TEST PROCEDURE	14
4.1.3 DEVIATION FROM TEST STANDARD	14
4.1.4 TEST SETUP	15
4.1.5 EUT OPERATING CONDITIONS	15
4.1.6 EUT TEST CONDITIONS	15
4.1.7 TEST RESULTS	15
4.2 RADIATED EMISSION MEASUREMENT	16
4.2.1 RADIATED EMISSION LIMITS	16
4.2.2 TEST PROCEDURE	17
4.2.3 DEVIATION FROM TEST STANDARD	17
4.2.4 TEST SETUP	17
4.2.5 EUT OPERATING CONDITIONS	18
4.2.6 EUT TEST CONDITIONS	18
4.2.7 TEST RESULTS (9KHZ TO 30MHZ)	19
4.2.8 TEST RESULTS (BETWEEN 30MHZ TO 1000 MHZ)	19
4.2.9 TEST RESULTS (ABOVE 1000 MHZ)	19
5 . BANDWIDTH TEST	20
5.1 APPLIED PROCEDURES	20
5.1.1 TEST PROCEDURE	20
5.1.2 DEVIATION FROM STANDARD	20
5.1.3 TEST SETUP	20
5.1.4 EUT OPERATION CONDITIONS	20
5.1.5 EUT TEST CONDITIONS	20
5.1.6 TEST RESULTS	20

Table of Contents	Page
6 . MAXIMUM PEAK CONDUCTED OUTPUT POWER TEST	21
6.1 APPLIED PROCEDURES / LIMIT	21
6.1.1 TEST PROCEDURE	21
6.1.2 DEVIATION FROM STANDARD	21
6.1.3 TEST SETUP	21
6.1.4 EUT OPERATION CONDITIONS	21
6.1.5 EUT TEST CONDITIONS	21
6.1.6 TEST RESULTS	21
7 . ANTENNA CONDUCTED SPURIOUS EMISSION	22
7.1 APPLIED PROCEDURES / LIMIT	22
7.1.1 TEST PROCEDURE	22
7.1.2 DEVIATION FROM STANDARD	22
7.1.3 TEST SETUP	22
7.1.4 EUT OPERATION CONDITIONS	22
7.1.5 EUT TEST CONDITIONS	22
7.1.6 TEST RESULTS	22
8 . POWER SPECTRAL DENSITY TEST	23
8.1 APPLIED PROCEDURES / LIMIT	23
8.1.1 TEST PROCEDURE	23
8.1.2 DEVIATION FROM STANDARD	23
8.1.3 TEST SETUP	23
8.1.4 EUT OPERATION CONDITIONS	23
8.1.5 EUT TEST CONDITIONS	23
8.1.6 TEST RESULTS	23
9 . MEASUREMENT INSTRUMENTS LIST	24
10 . EUT TEST PHOTO	26
ATTACHMENT A - CONDUCTED EMISSION	33
ATTACHMENT B - RADIATED EMISSION (9KHZ TO 30MHZ)	36
ATTACHMENT C - RADIATED EMISSION (30MHZ TO 1000MHZ)	39
ATTACHMENT D - RADIATED EMISSION (ABOVE 1000MHZ)	52
ATTACHMENT E - BANDWIDTH	125
ATTACHMENT F – MAXIMUM PEAK CONDUCTED OUTPUT POWER	138
ATTACHMENT G - ANTENNA CONDUCTED SPURIOUS EMISSION	141
ATTACHMENT H - POWER SPECTRAL DENSITY	166

REPORT ISSUED HISTORY

Issued No.	Description	Issued Date
BTL-FICP-1-1504C213	Original Issue.	May 22, 2015

1. CERTIFICATION

Equipment : PHOTON
Brand Name : N/A
Model Name : PHOTONH
Applicant : Spark Labs, Inc.,
Date of Test : Apr. 22, 2015 ~ May 21, 2015
Test Sample : ENGINEERING SAMPLE
Standard(s) : FCC Part15, Subpart C: 2014 (15.247) / ANSI C63.4-2009
Canada RSS-210: 2010
RSS-GEN Issue 4, Nov 2014

The above equipment has been tested and found compliance with the requirement of the relative standards by BTL Inc.

The test data, data evaluation, and equipment configuration contained in our test report (Ref No. BTL-FICP-1-1504C213) were obtained utilizing the test procedures, test instruments, test sites that has been accredited by the Authority of TAF according to the ISO-17025 quality assessment standard and technical standard(s).

2. SUMMARY OF TEST RESULTS

Test procedures according to the technical standard(s):

Applied Standard(s): FCC Part15 (15.247) , Subpart C: 2014 Canada RSS-210:2010; RSS-GEN Issue 4, Nov 2014				
Standard(s) Section		Test Item	Judgment	Remark
FCC	IC			
15.207	RSS-GEN 8.8	Conducted Emission	PASS	
15.247(d)	RSS-210 Annex 8 (A8.5)	Antenna conducted Spurious Emission	PASS	
15.247(a)(2)	RSS-210 Annex 8 (A8.2(a))	6dB Bandwidth	PASS	
15.247(b)(3)	RSS-210 Annex 8 (A8.4(4))	Peak Output Power	PASS	
15.247(e)	RSS-210 Annex 8 (A8.2(b))	Power Spectral Density	PASS	
15.203	-	Antenna Requirement	PASS	
15.209/15.205	RSS-210 Annex 8 (A8.5)	Transmitter Radiated Emissions	PASS	

NOTE:

- (1) "N/A" denotes test is not applicable in this test report.
- (2) The test follows FCC KDB Publication No. 558074 D01 DTS Meas Guidance v03r02 (Measurement Guidelines of DTS)

2.1 TEST FACILITY

The test facilities used to collect the test data in this report is at the location of No.3, Jinshagang 1st Road, Shixia, Dalang Town, Dongguan, Guangdong, China.

BTL's test firm number for FCC: 319330

BTL's test firm number for IC: 4428B-1

2.2 MEASUREMENT UNCERTAINTY

Where relevant, the following measurement uncertainty levels have been estimated for tests performed on the EUT as specified in CISPR 16-4-2.

The BTL measurement uncertainty is less than the CISPR 16-4-2 U_{CISPR} requirement.

The reported uncertainty of measurement $y \pm U$, where expanded uncertainty U is based on a standard uncertainty multiplied by a coverage factor of $k=2$, providing a level of confidence of approximately 95 %.

A. Conducted Measurement :

Test Site	Method	Measurement Frequency Range	U, (dB)	NOTE
DG-C02	CISPR	150 KHz ~ 30MHz	1.94	

B. Radiated Measurement :

Test Site	Method	Measurement Frequency Range	Ant. H / V	U, (dB)	NOTE
DG-CB03	CISPR	9KHz~30MHz	V	3.79	
		9KHz~30MHz	H	3.57	
		30MHz ~ 200MHz	V	3.82	
		30MHz ~ 200MHz	H	3.60	
		200MHz ~ 1,000MHz	V	3.86	
		200MHz ~ 1,000MHz	H	3.94	
		1GHz~18GHz	V	3.12	
		1GHz~18GHz	H	3.68	
		18GHz~40GHz	V	4.15	
		18GHz~40GHz	H	4.14	

Note: Unless specifically mentioned, the uncertainty of measurement has not been taken into account to declare the compliance or non-compliance to the specification.

3. GENERAL INFORMATION

3.1 GENERAL DESCRIPTION OF EUT

Equipment	PHOTON	
Brand Name	N/A	
Model Name	PHOTONH	
Model Difference	N/A	
Product Description	Operation Frequency	2412~2462 MHz
	Modulation Technology	802.11b:DSSS 802.11g:OFDM 802.11n:OFDM
	Bit Rate of Transmitter	802.11b: 11/5.5/2/1 Mbps 802.11g: 54/48/36/24/18/12/9/6 Mbps 802.11n up to 65 Mbps
	Output Power (Max.) - Chip antenna	802.11b: 19.74dBm 802.11g: 22.63dBm 802.11n(20MHz): 22.86dBm
	Output Power (Max.) - Dipole antenna	802.11b: 19.91dBm 802.11g: 22.74dBm 802.11n(20MHz): 22.37dBm
Power Source	Supplied from PC USB port.	
Power Rating	DC 5V	

Note:

1. For a more detailed features description, please refer to the manufacturer's specifications or the user's manual.

2. Channel List:

CH01 – CH11 for 802.11b, 802.11g, 802.11n(20MHz)							
Channel	Frequency (MHz)	Channel	Frequency (MHz)	Channel	Frequency (MHz)	Channel	Frequency (MHz)
01	2412	04	2427	07	2442	10	2457
02	2417	05	2432	08	2447	11	2462
03	2422	06	2437	09	2452		

3. Table for Filed Antenna

Ant.	Brand	Model Name	Antenna Type	Connector	Gain (dBi)	Note
1	ACX	AT7020 -E3R0HBA	Chip	N/A	1.30	TX/RX
2	CRMX TM	104-1001	Dipole	RP-TNC	2.15	TX/RX

Note: EUT has two types of antenna, one with chip antenna, another one with dipole antenna.

3.2 DESCRIPTION OF TEST MODES

To investigate the maximum EMI emission characteristics generated from EUT, the test system was pre-scanning tested based on the consideration of following EUT operation mode or test configuration mode which possibly have effect on EMI emission level. Each of these EUT operation mode(s) or test configuration mode(s) mentioned above was evaluated respectively.

Pretest Mode	Description
Mode 1	TX B MODE CHANNEL 01/06/11
Mode 2	TX G MODE CHANNEL 01/06/11
Mode 3	TX N-20MHZ MODE CHANNEL 01/06/11
Mode 4	TX MODE

The EUT system operated these modes were found to be the worst case during the pre-scanning test as following:

For Conducted Test	
Final Test Mode	Description
Mode 4	TX MODE

For Radiated Test	
Final Test Mode	Description
Mode 1	TX B MODE CHANNEL 01/06/11
Mode 2	TX G MODE CHANNEL 01/06/11
Mode 3	TX N-20MHZ MODE CHANNEL 01/06/11

Note:

- (1) The measurements are performed at the high, middle, low available channels.
- (2) 802.11b mode: DBPSK (1Mbps)
 802.11g mode: OFDM (6Mbps)
 802.11n HT20 mode : BPSK (6.5Mbps)
 For radiated emission tests, the highest output powers were set for final test.
- (3) For radiated below 1G test, the 802.11b is found to be the worst case and recorded.
- (4) The EUT was programmed to be in continuously transmitting mode and the transmit duty cycle is not less than 98%.

3.3 TABLE OF PARAMETERS OF TEXT SOFTWARE SETTING

During testing, channel & power controlling software provided by the customer was used to control the operating channel as well as the output power level. The RF output power selection is for the setting of RF output power expected by the customer and is going to be fixed on the firmware of the final end product power parameters of WLAN

For Chip antenna

Test software version	NA		
Frequency (MHz)	2412	2437	2462
802.11b	16	16	16
802.11g	15.5	15.5	15.5
802.11n (20MHz)	14	14	14

For Dipole antenna

Test software version	NA		
Frequency (MHz)	2412	2437	2462
802.11b	16	16	16
802.11g	15.5	15.5	15.5
802.11n (20MHz)	13.5	13.5	13.5

3.4 BLOCK DIAGRAM SHOWING THE CONFIGURATION OF SYSTEM TESTED

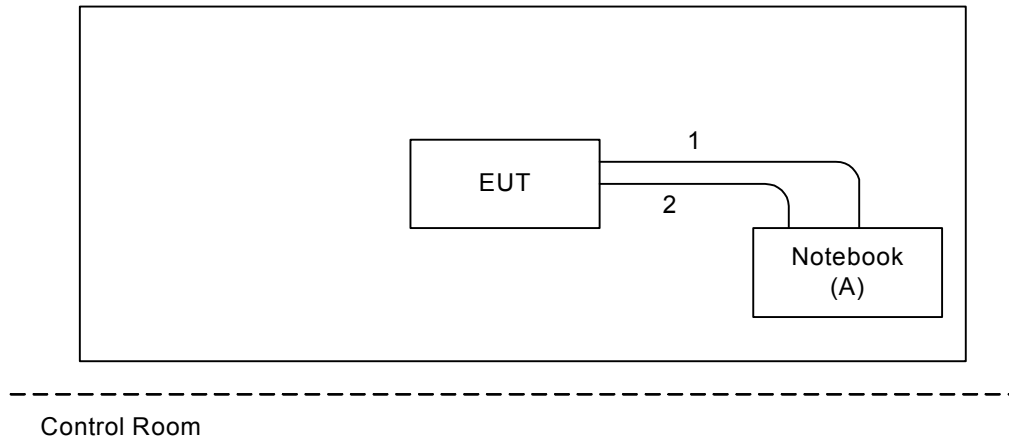

3.5 DESCRIPTION OF SUPPORT UNITS

The EUT has been tested as an independent unit together with other necessary accessories or support units. The following support units or accessories were used to form a representative test configuration during the tests.

Item	Equipment	Mfr/Brand	Model/Type No.	FCC ID	Series No.	Note
A	NOTEBOOK	DELL	INSPIRON 1420	DOC	JX193A01SDC2	

Item	Shielded Type	Ferrite Core	Length	Note
1	NO	NO	0.5m	Fixture Cable
2	NO	NO	0.5m	USB Cable

4. EMC EMISSION TEST

4.1 CONDUCTED EMISSION MEASUREMENT

4.1.1 POWER LINE CONDUCTED EMISSION Limits (Frequency Range 150KHz-30MHz)

Frequency of Emission (MHz)	Conducted Limit (dB μ V)	
	Quasi-peak	Average
0.15 -0.5	66 to 56*	56 to 46*
0.50 -5.0	56	46
5.0 -30.0	60	50

Note:

- (1) The limit of " * " decreases with the logarithm of the frequency
- (2) The test result calculated as following:
 Measurement Value = Reading Level + Correct Factor
 Correct Factor = Insertion Loss + Cable Loss + Attenuator Factor(if use)
 Margin Level = Measurement Value - Limit Value

The following table is the setting of the receiver

Receiver Parameters	Setting
Attenuation	10 dB
Start Frequency	0.15 MHz
Stop Frequency	30 MHz
IF Bandwidth	9 KHz

4.1.2 TEST PROCEDURE

- a. The EUT was placed 0.8 meters from the horizontal ground plane with EUT being connected to the power mains through a line impedance stabilization network (LISN). All other support equipments powered from additional LISN(s). The LISN provide 50 Ohm/ 50uH of coupling impedance for the measuring instrument.
- b. Interconnecting cables that hang closer than 40 cm to the ground plane shall be folded back and forth in the center forming a bundle 30 to 40 cm long.
- c. I/O cables that are not connected to a peripheral shall be bundled in the center. The end of the cable may be terminated, if required, using the correct terminating impedance. The overall length shall not exceed 1 m.
- d. LISN at least 80 cm from nearest part of EUT chassis.
- e. For the actual test configuration, please refer to the related Item –EUT Test Photos.

4.1.3 DEVIATION FROM TEST STANDARD

No deviation

4.1.4 TEST SETUP

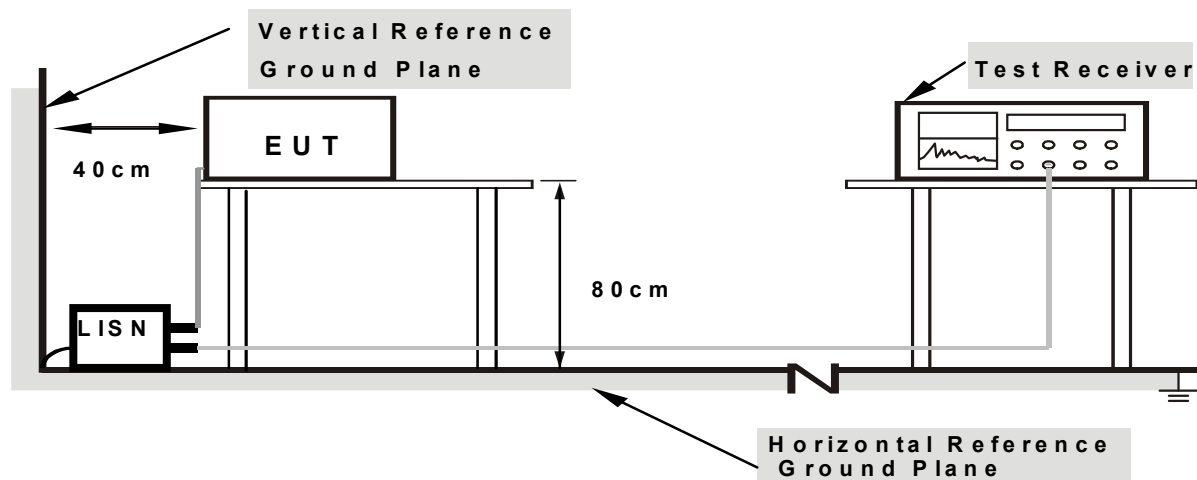

- Note: 1. Support units were connected to second LISN.
 2. Both of LISNs (AMN) are 80 cm from EUT and at least 80 cm from other units and other metal planes

4.1.5 EUT OPERATING CONDITIONS

The EUT was configured for testing in a typical fashion (as a customer would normally use it). The EUT has been programmed to continuously transmit during test. This operating condition was tested and used to collect the included data.

4.1.6 EUT TEST CONDITIONS

Temperature: 21°C Relative Humidity: 51% Test Voltage: AC 120V/60Hz

4.1.7 TEST RESULTS

Please refer to the Attachment A.

4.2 RADIATED EMISSION MEASUREMENT

4.2.1 RADIATED EMISSION LIMITS

20dB in any 100 KHz bandwidth outside the operating frequency band. In case the emission fall within the restricted band specified on 15.205(a) & RSS-210 section 2.2& Annex 8 (A8.5), then the 15.209(a)& RSS-Gen limit in the table below has to be followed.

LIMITS OF RADIATED EMISSION MEASUREMENT (9KHz-1000MHz)

Frequency (MHz)	Field Strength (microvolts/meter)	Measurement Distance (meters)
0.009~0.490	2400/F(KHz)	300
0.490~1.705	24000/F(KHz)	30
1.705~30.0	30	30
30~88	100	3
88~216	150	3
216~960	200	3
960~1000	500	3

LIMITS OF RADIATED EMISSION MEASUREMENT (Above 1000MHz)

Frequency (MHz)	(dBuV/m) (at 3 meters)	
	PEAK	AVERAGE
Above 1000	74	54

Notes:

- (1) The limit for radiated test was performed according to FCC PART 15C.
- (2) The tighter limit applies at the band edges.
- (3) Emission level (dBuV/m)=20log Emission level (uV/m).
- (4) The test result calculated as following:
 Measurement Value = Reading Level + Correct Factor
 Correct Factor = Antenna Factor + Cable Loss - Amplifier Gain(if use)
 Margin Level = Measurement Value - Limit Value

Spectrum Parameter	Setting
Attenuation	Auto
Start Frequency	1000 MHz
Stop Frequency	10th carrier harmonic
RBW / VBW (Emission in restricted band)	RBW 1MHz VBW 3MHz peak detector for Pk value RMS detector for AV value

Receiver Parameter	Setting
Attenuation	Auto
Start ~ Stop Frequency	9KHz~90KHz for PK/AVG detector
Start ~ Stop Frequency	90KHz~110KHz for QP detector
Start ~ Stop Frequency	110KHz~490KHz for PK/AVG detector
Start ~ Stop Frequency	490KHz~30MHz for QP detector
Start ~ Stop Frequency	30MHz~1000MHz for QP detector

4.2.2 TEST PROCEDURE

- The EUT was placed on the top of a rotating table 0.8 meters above the ground at a 3 meter semi-anechoic chamber. The table was rotated 360 degrees to determine the position of the highest radiation.(below 1GHz)
- The EUT was placed on the top of a rotating table 0.8 meters above the ground at a 3 meter fully-anechoic chamber. The table was rotated 360 degrees to determine the position of the highest radiation.(above 1GHz)
- The height of the equipment or of the substitution antenna shall be 0.8 m; the height of the test antenna shall vary between 1 m to 4 m. Both horizontal and vertical polarizations of the antenna are set to make the measurement.
- The initial step in collecting conducted emission data is a spectrum analyzer peak detector mode pre-scanning the measurement frequency range. Significant peaks are then marked and then Quasi Peak detector mode re-measured.
- If the Peak Mode measured value compliance with and lower than Quasi Peak Mode Limit, the EUT shall be deemed to meet QP Limits and then no additional QP Mode measurement performed.
- For the actual test configuration, please refer to the related Item –EUT Test Photos.

4.2.3 DEVIATION FROM TEST STANDARD

No deviation

4.2.4 TEST SETUP

(A) Radiated Emission Test Set-Up Frequency Below 1 GHz

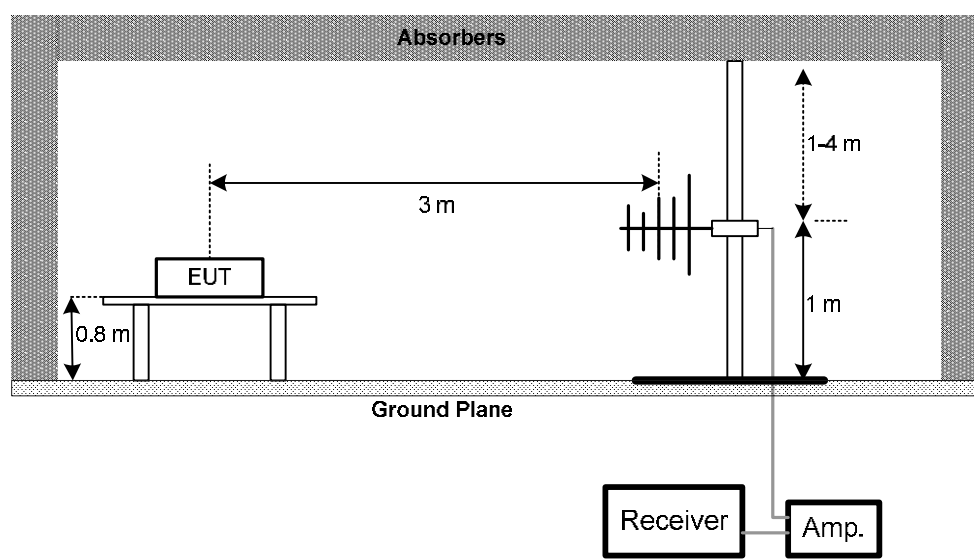

(B) Radiated Emission Test Set-Up Frequency Above 1 GHz

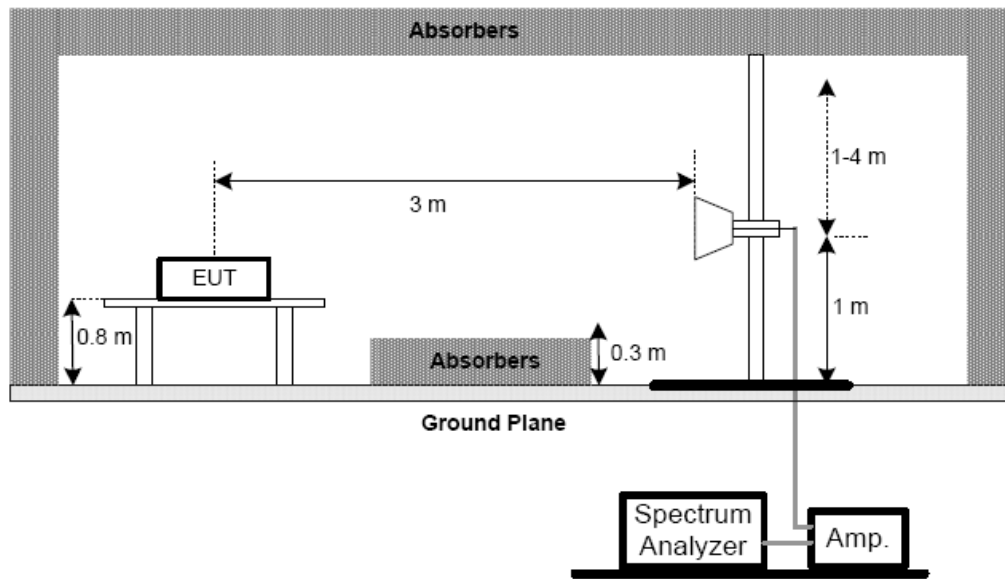

(C) For radiated emissions below 30MHz

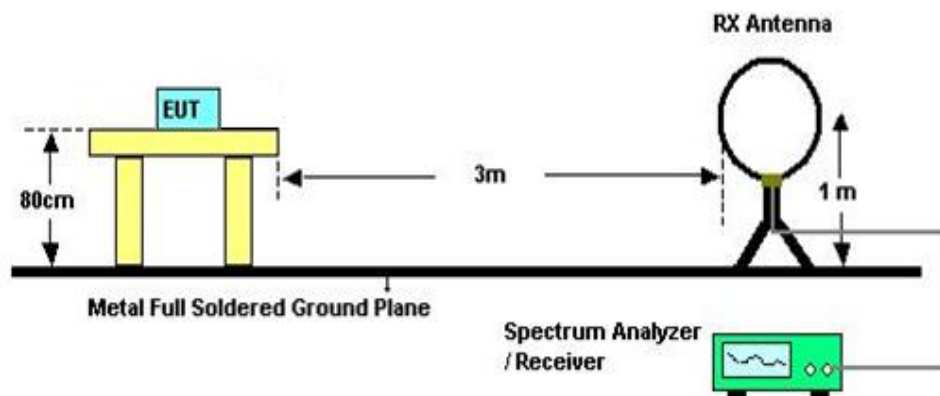

4.2.5 EUT OPERATING CONDITIONS

The EUT tested system was configured as the statements of 4.1.5 **Unless** otherwise a special operating condition is specified in the follows during the testing.

4.2.6 EUT TEST CONDITIONS

Temperature: 25°C Relative Humidity: 55% Test Voltage: DC 5V

4.2.7 TEST RESULTS (9KHZ TO 30MHZ)

Please refer to the Attachment B

Remark:

- (1) The amplitude of spurious emissions which are attenuated by more than 20 dB below the permissible value has no need to be reported.
- (2) Distance extrapolation factor = $40 \log(\text{specific distance} / \text{test distance})$ (dB).
- (3) Limit line = specific limits (dBuV) + distance extrapolation factor.

4.2.8 TEST RESULTS (BETWEEN 30MHZ TO 1000 MHZ)

Please refer to the Attachment C.

4.2.9 TEST RESULTS (ABOVE 1000 MHZ)

Please refer to the Attachment D.

Remark:

- (1) No limit: This is fundamental signal, the judgment is not applicable.
For fundamental signal judgment was referred to Peak output test.

5. BANDWIDTH TEST

5.1 APPLIED PROCEDURES

FCC Part15 (15.247) , Subpart C/ RSS-GEN and RSS-210			
Section	Test Item	Frequency Range (MHz)	Result
15.247(a)(2) RSS-GEN section 6.6 RSS-210 Annex 8 (A8.2(a))	Bandwidth	2400-2483.5	PASS

5.1.1 TEST PROCEDURE

- a. The EUT was directly connected to the spectrum analyzer and antenna output port as show in the block diagram below,
- b. Spectrum Setting: RBW= 100KHz, VBW=300KHz, Sweep time = 2.5 ms.

5.1.2 DEVIATION FROM STANDARD

No deviation.

5.1.3 TEST SETUP



5.1.4 EUT OPERATION CONDITIONS

The EUT tested system was configured as the statements of 4.1.5 Unless otherwise a special operating condition is specified in the follows during the testing.

5.1.5 EUT TEST CONDITIONS

Temperature: 25°C Relative Humidity: 55% Test Voltage: DC 5V

5.1.6 TEST RESULTS

Please refer to the Attachment E.

6. MAXIMUM PEAK CONDUCTED OUTPUT POWER TEST

6.1 APPLIED PROCEDURES / LIMIT

FCC Part15 (15.247) , Subpart C/ RSS-210				
Section	Test Item	Limit	Frequency Range (MHz)	Result
15.247(b)(3) RSS-210 Annex 8.4(4)	Maximum Output Power	1 Watt or 30dBm	2400-2483.5	PASS

6.1.1 TEST PROCEDURE

- a. The EUT was directly connected to the power meter and antenna output port as show in the block diagram below,
- b. The maximum peak conducted output power was performed in accordance with method 9.1.2 of FCC KDB 558074 D01 DTS Meas Guidance v03r02.

6.1.2 DEVIATION FROM STANDARD

No deviation.

6.1.3 TEST SETUP



6.1.4 EUT OPERATION CONDITIONS

The EUT tested system was configured as the statements of 4.1.5 Unless otherwise a special operating condition is specified in the follows during the testing. Transmit output power was measured while the host equipment supply voltage was varied from 85 % to 115 % of the nominal rated supply voltage. No change in transmit output power was observed.

6.1.5 EUT TEST CONDITIONS

Temperature: 25°C Relative Humidity: 55% Test Voltage: DC 5V

6.1.6 TEST RESULTS

Please refer to the Attachment F.

7. ANTENNA CONDUCTED SPURIOUS EMISSION

7.1 APPLIED PROCEDURES / LIMIT

In any 100 kHz bandwidth outside the frequency band in which the spread spectrum or digitally modulated intentional radiator is operating, the radio frequency power that is produced by the intentional radiator shall be at least 20 dB below that in the 100 kHz bandwidth within the band that contains the highest level of the desired power, based on either an RF conducted measurement, provided the transmitter demonstrates compliance with the peak conducted power limits.

7.1.1 TEST PROCEDURE

- a. The EUT was directly connected to the spectrum analyzer and antenna output port as show in the block diagram below,
- b. Spectrum Setting: RBW= 100KHz, VBW=300KHz, Sweep time = Auto.

7.1.2 DEVIATION FROM STANDARD

No deviation.

7.1.3 TEST SETUP

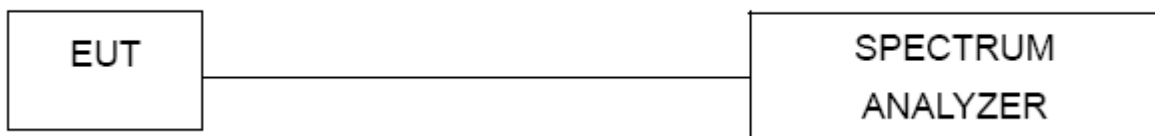

7.1.4 EUT OPERATION CONDITIONS

The EUT tested system was configured as the statements of 4.1.5 Unless otherwise a special operating condition is specified in the follows during the testing.

7.1.5 EUT TEST CONDITIONS

Temperature: 25°C Relative Humidity: 55% Test Voltage: DC 5V

7.1.6 TEST RESULTS

Please refer to the Attachment G.

8. POWER SPECTRAL DENSITY TEST

8.1 APPLIED PROCEDURES / LIMIT

FCC Part15 (15.247) , Subpart C / RSS-210				
Section	Test Item	Limit	Frequency Range (MHz)	Result
15.247(e) RSS-210 Annex 8(A8.2(b))	Power Spectral Density	8 dBm (in any 3KHz)	2400-2483.5	PASS

8.1.1 TEST PROCEDURE

- a. The EUT was directly connected to the spectrum analyzer and antenna output port as show in the block diagram below,
- b. Spectrum Setting: RBW=3KHz, VBW=10KHz, Sweep time = Auto.

8.1.2 DEVIATION FROM STANDARD

No deviation.

8.1.3 TEST SETUP



8.1.4 EUT OPERATION CONDITIONS

The EUT tested system was configured as the statements of 4.1.5 Unless otherwise a special operating condition is specified in the follows during the testing.

8.1.5 EUT TEST CONDITIONS

Temperature: 25°C Relative Humidity: 55% Test Voltage: DC 5V

8.1.6 TEST RESULTS

Please refer to the Attachment H.

9. MEASUREMENT INSTRUMENTS LIST

Conducted Emission Measurement					
Item	Kind of Equipment	Manufacturer	Type No.	Serial No.	Calibrated until
1	LISN	EMCO	3816/2	00052765	Mar. 28, 2016
2	LISN	R&S	ENV216	101447	Mar. 28, 2016
3	Test Cable	N/A	C_17	N/A	Mar. 13, 2016
4	EMI TEST RECEIVER	R&S	ESCS30	833364/017	Mar. 28, 2016
5	50Ω Terminator	SHX	TF2-3G-A	08122902	Mar. 28, 2016
6	Measurement Software	Farad	EZ-EMC Ver.NB-03A1 -01	N/A	N/A

Radiated Emission Measurement					
Item	Kind of Equipment	Manufacturer	Type No.	Serial No.	Calibrated until
1	Antenna	Schwarzbeck	VULB9160	9160-3232	Mar. 28, 2016
2	Amplifier	HP	8447D	2944A09673	Nov. 17, 2015
3	Receiver	AGILENT	N9038A	MY5213003 9	Sep. 30, 2015
4	Test Cable	N/A	C-01_CB03	N/A	Jul. 01, 2015
5	Controller	CT	SC100	N/A	N/A
6	Measurement Software	Farad	EZ-EMC Ver.NB-03A1-01	N/A	N/A
7	Antenna	ETS	3115	00075789	Mar. 28, 2016
8	Amplifier	Agilent	8449B	3008A02274	Nov. 02, 2015
9	Receiver	AGILENT	N9038A	MY5213003 9	Sep. 30, 2015
10	Test Cable	N/A	C-68	N/A	Jul. 01, 2015
11	Controller	CT	SC100	N/A	N/A
12	Broad-Band Horn Antenna	Schwarzbeck	BBHA 9170	9170319	Mar. 28, 2016
13	Microwave Preampifier With Adaptor	EMC INSTRUMENT	EMC2654045	980039 & HA01	Mar. 28, 2016
14	Active Loop Antenna	R&S	HFH2-Z2	830749/020	Aug. 16, 2015

6dB Bandwidth Measurement

Item	Kind of Equipment	Manufacturer	Type No.	Serial No.	Calibrated until
1	Spectrum Analyzer	R&S	FSP 40	100185	Nov. 02, 2015

Peak Output Power Measurement

Item	Kind of Equipment	Manufacturer	Type No.	Serial No.	Calibrated until
1	power Meter	ANRITSU	ML2495A	1128009	Mar. 28, 2016
2	Pulse Power Sensor	ANRITSU	MA 2411B	1027500	Mar. 28, 2016

Antenna Conducted Spurious Emission Measurement

Item	Kind of Equipment	Manufacturer	Type No.	Serial No.	Calibrated until
1	Spectrum Analyzer	R&S	FSP 40	100185	Nov. 02, 2015

Power Spectral Density Measurement

Item	Kind of Equipment	Manufacturer	Type No.	Serial No.	Calibrated until
1	Spectrum Analyzer	R&S	FSP 40	100185	Nov. 02, 2015

Remark: "N/A" denotes no model name, serial no. or calibration specified.
 All calibration period of equipment list is one year.

10. EUT TEST PHOTO

Conducted Measurement Photos



**For Chip antenna
Radiated Measurement Photos**

9KHz to 30MHz



Radiated Measurement Photos

30MHz to 1000MHz



Radiated Measurement Photos

Above 1000MHz



**For Dipole antenna
Radiated Measurement Photos**

9KHz to 30MHz

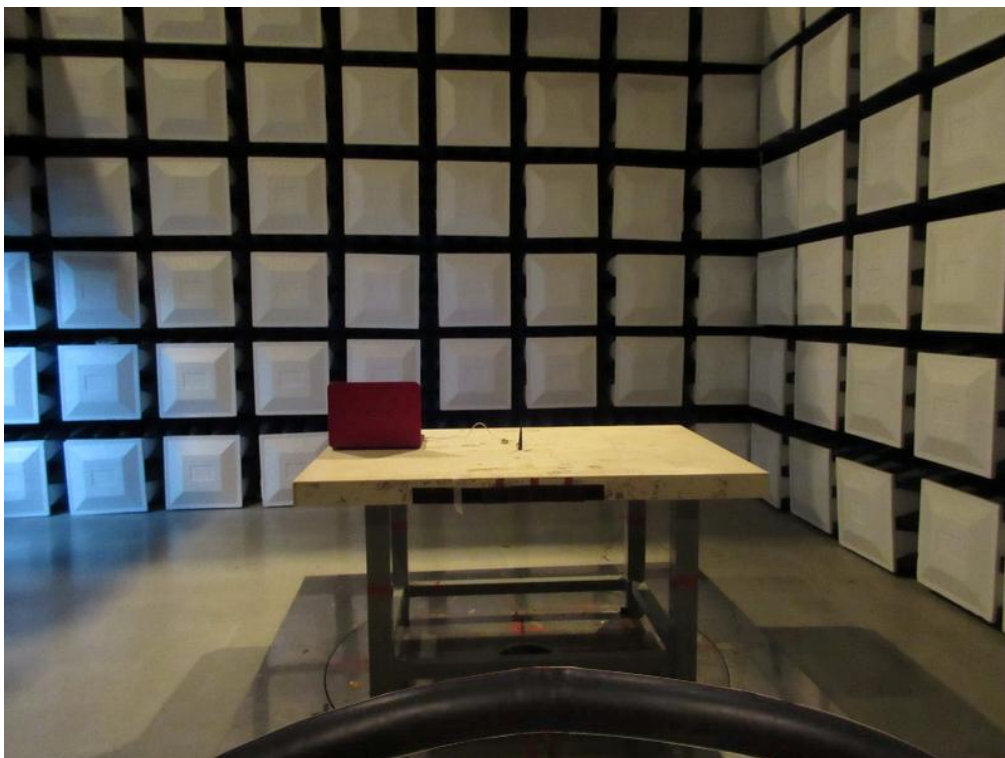
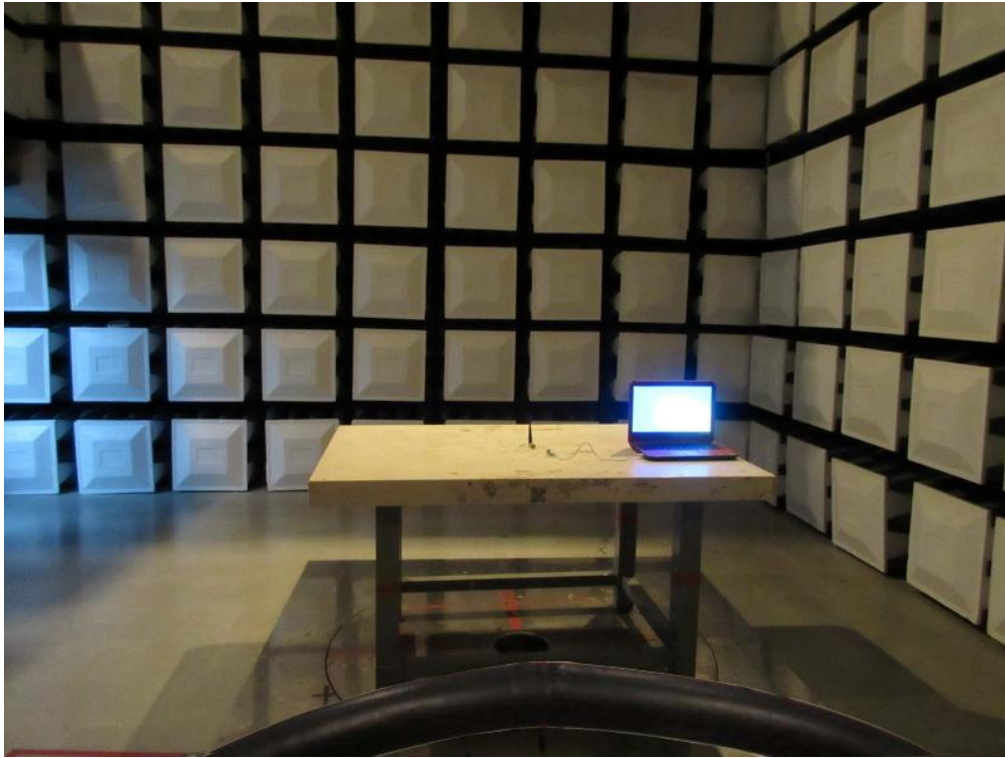

Radiated Measurement Photos

30MHz to 1000MHz

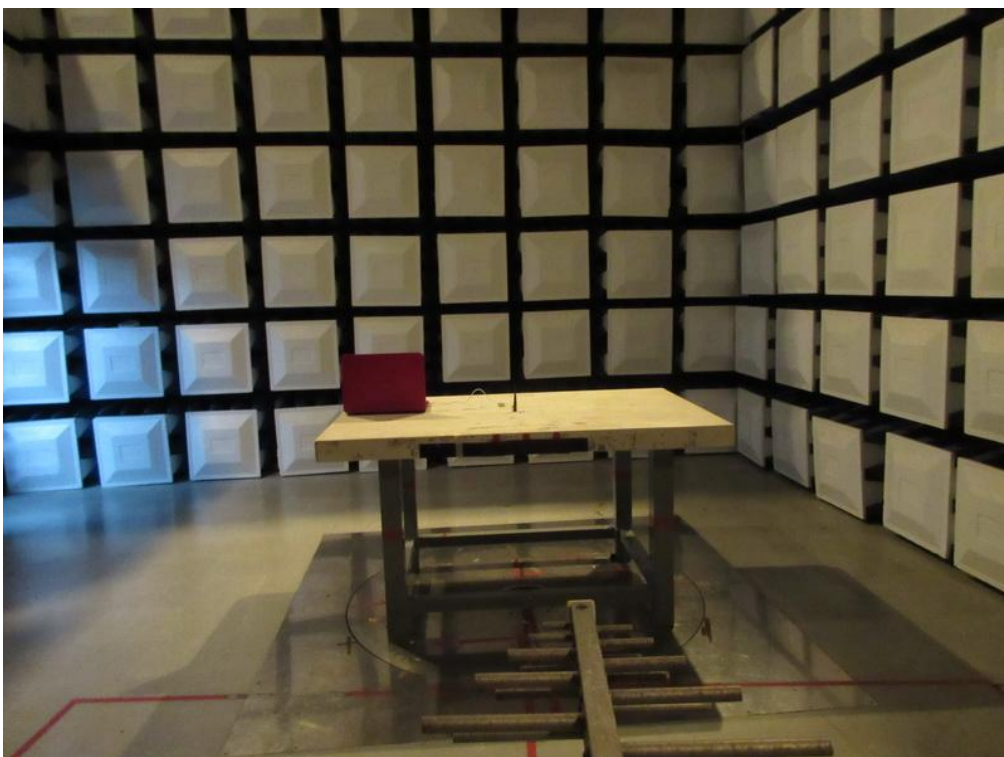

Radiated Measurement Photos

Above 1000MHz

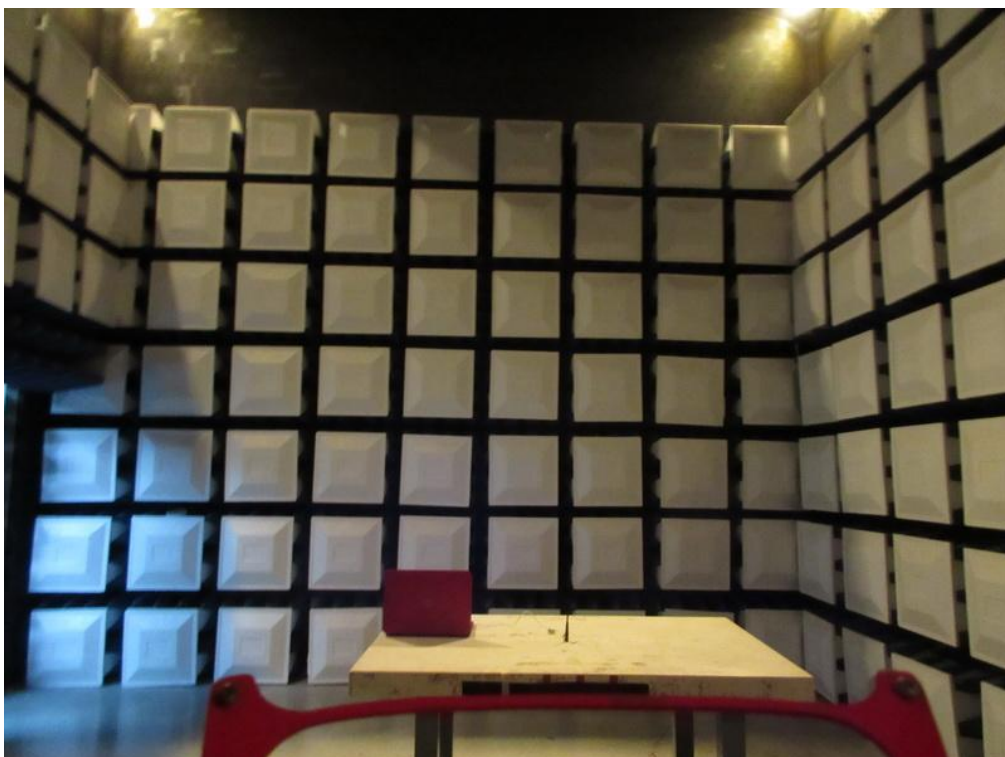
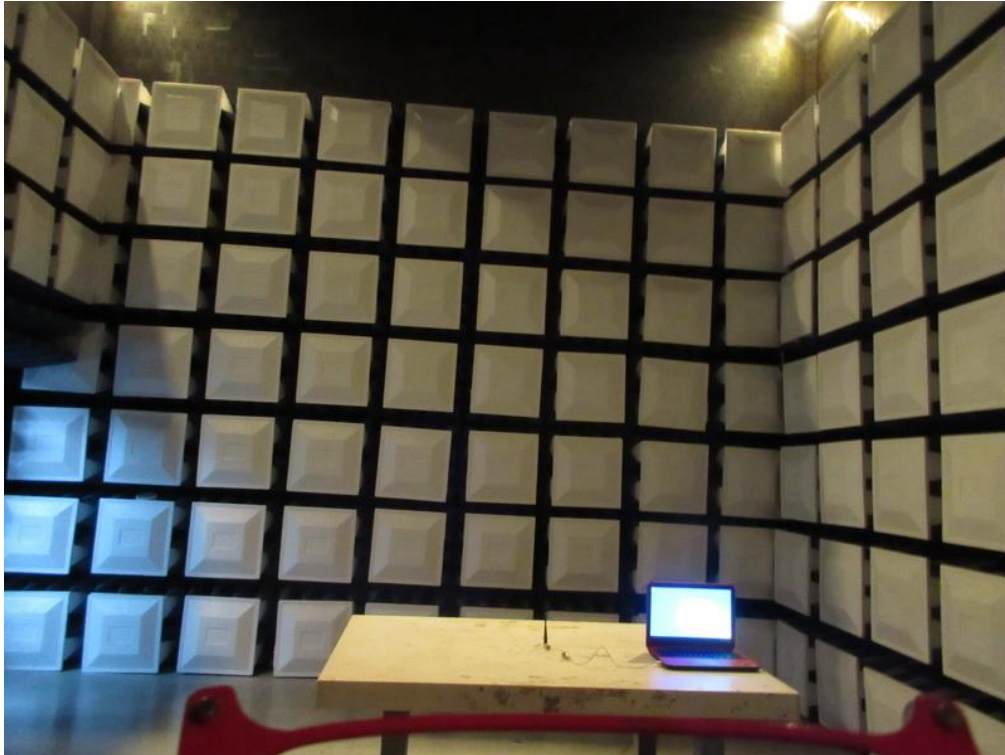

ATTACHMENT A - CONDUCTED EMISSION

Test Mode : TX MODE

Line



No.	Mk.	Freq. MHz	Reading Level dBuV	Correct Factor dB	Measure- ment dBuV	Limit dBuV	Margin dB	Detector	Comment
1		0.2360	36.80	9.54	46.34	62.24	-15.90	peak	
2	*	0.3648	34.52	9.57	44.09	58.62	-14.53	peak	
3		0.5090	30.16	9.59	39.75	56.00	-16.25	peak	
4		0.6851	29.74	9.62	39.36	56.00	-16.64	peak	
5		0.9193	29.58	9.64	39.22	56.00	-16.78	peak	
6		2.5600	26.76	9.76	36.52	56.00	-19.48	peak	

Test Mode : TX MODE

Neutral



No.	Mk.	Freq. MHz	Reading Level dBuV	Correct Factor dB	Measure- ment dBuV	Limit dBuV	Margin dB	Detector	Comment
1	*	0.2360	37.02	9.53	46.55	62.24	-15.69	peak	
2		0.3570	33.28	9.56	42.84	58.80	-15.96	peak	
3		0.7006	27.98	9.60	37.58	56.00	-18.42	peak	
4		0.8801	27.36	9.62	36.98	56.00	-19.02	peak	
5		10.1757	30.56	10.17	40.73	60.00	-19.27	peak	
6		17.3903	31.06	10.55	41.61	60.00	-18.39	peak	

ATTACHMENT B - RADIATED EMISSION (9KHZ TO 30MHZ)

For Chip antenna

Test Mode:	TX Mode 2412MHz
------------	-----------------

Frequency (MHz)	Ant 0°/90°	Read level dBuV/m	Factor (dB)	Measured(FS) (dBuV/m)	Limit (dBuV/m)	Margin (dB)	Note
0.0066	0°	12.45	25.15	37.60	111.21	-73.61	AVG
0.0066	0°	14.06	25.15	39.21	131.21	-92.00	PEAK
0.0217	0°	5.19	24.19	29.38	100.88	-71.49	AVG
0.0217	0°	7.56	24.19	31.75	120.88	-89.12	PEAK
0.0326	0°	3.62	23.50	27.12	97.34	-70.22	AVG
0.0326	0°	5.38	23.50	28.88	117.34	-88.46	PEAK
0.0352	0°	0.85	23.34	24.19	96.67	-72.49	AVG
0.0352	0°	2.68	23.34	26.02	116.67	-90.66	PEAK
0.4960	0°	30.15	19.81	49.96	73.69	-23.73	QP
1.8540	0°	21.29	19.51	40.80	69.54	-28.74	QP

Frequency (MHz)	Ant 0°/90°	Read level dBuV/m	Factor (dB)	Measured(FS) (dBuV/m)	Limit (dBuV/m)	Margin (dB)	Note
0.0068	90°	12.02	24.30	36.32	130.95	-94.63	AVG
0.0068	90°	14.16	24.30	38.46	150.95	-112.49	PEAK
0.0358	90°	6.25	23.30	29.55	116.53	-86.98	AVG
0.0358	90°	8.55	23.30	31.85	136.53	-104.68	PEAK
0.0443	90°	3.85	22.76	26.61	114.68	-88.07	AVG
0.0443	90°	5.42	22.76	28.18	134.68	-106.50	PEAK
0.0482	90°	0.96	22.51	23.47	113.94	-90.47	AVG
0.0482	90°	2.71	22.51	25.22	133.94	-108.72	PEAK
0.5210	90°	30.46	19.87	50.33	73.27	-22.94	QP
1.8380	90°	21.48	19.52	41.00	69.54	-28.54	QP

For Dipole antenna

Test Mode:	TX Mode 2412MHz
------------	-----------------

Frequency (MHz)	Ant 0°/90°	Read level dBuV/m	Factor (dB)	Measured(FS) (dBuV/m)	Limit (dBuV/m)	Margin (dB)	Note
0.0038	0°	11.25	25.33	36.58	116.01	-79.43	AVG
0.0038	0°	15.24	25.33	40.57	136.01	-95.44	PEAK
0.0144	0°	5.89	24.65	30.54	104.44	-73.89	AVG
0.0144	0°	8.64	24.65	33.29	124.44	-91.14	PEAK
0.0982	0°	2.58	21.44	24.02	87.76	-63.75	AVG
0.0982	0°	4.98	21.44	26.42	107.76	-81.35	PEAK
0.1572	0°	0.57	20.59	21.16	83.68	-62.52	AVG
0.1527	0°	3.64	20.59	24.23	103.68	-79.45	PEAK
1.6280	0°	29.65	19.54	49.19	63.37	-14.18	QP
4.5270	0°	22.54	18.58	41.12	69.54	-28.42	QP

Frequency (MHz)	Ant 0°/90°	Read level dBuV/m	Factor (dB)	Measured(FS) (dBuV/m)	Limit (dBuV/m)	Margin (dB)	Note
0.0870	90°	12.42	21.66	34.08	108.81	-74.73	AVG
0.0870	90°	14.68	21.66	36.34	128.81	-92.47	PEAK
0.0920	90°	6.87	21.56	28.43	108.33	-79.90	AVG
0.0920	90°	9.05	21.56	30.61	128.33	-97.72	PEAK
0.1527	90°	4.27	20.59	24.86	103.93	-79.06	AVG
0.0153	90°	5.89	20.59	26.48	123.93	-97.44	PEAK
0.2682	90°	1.05	20.36	21.41	99.04	-77.63	AVG
0.2682	90°	3.25	20.36	23.61	119.04	-95.43	PEAK
2.5785	90°	29.51	19.15	48.66	69.54	-20.88	QP
4.2589	90°	22.45	18.79	41.24	69.54	-28.30	QP

ATTACHMENT C - RADIATED EMISSION (30MHZ TO 1000MHZ)

For Chip antenna

Test Mode: TX B MODE CHANNEL 01

Vertical

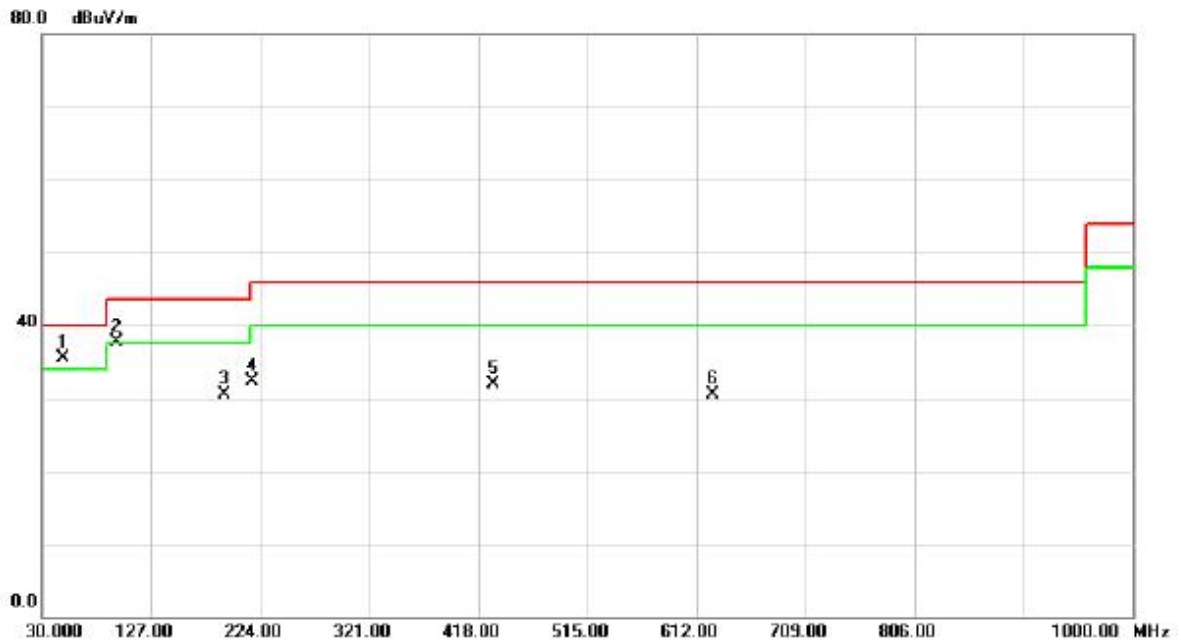

No.	Mk.	Freq. MHz	Reading Level dBuV	Correct Factor dB	Measure- ment dBuV/m	Limit dBuV/m	Over dB	Detector	Comment
1	*	48.4300	49.26	-13.70	35.56	40.00	-4.44	peak	
2	!	95.9600	54.35	-16.67	37.68	43.50	-5.82	peak	
3		191.9900	44.72	-14.29	30.43	43.50	-13.07	peak	
4		216.2400	47.06	-14.67	32.39	46.00	-13.61	peak	
5		431.5800	40.18	-8.27	31.91	46.00	-14.09	peak	
6		626.5500	36.28	-5.84	30.44	46.00	-15.56	peak	

Test Mode: TX B MODE CHANNEL 01

Horizontal

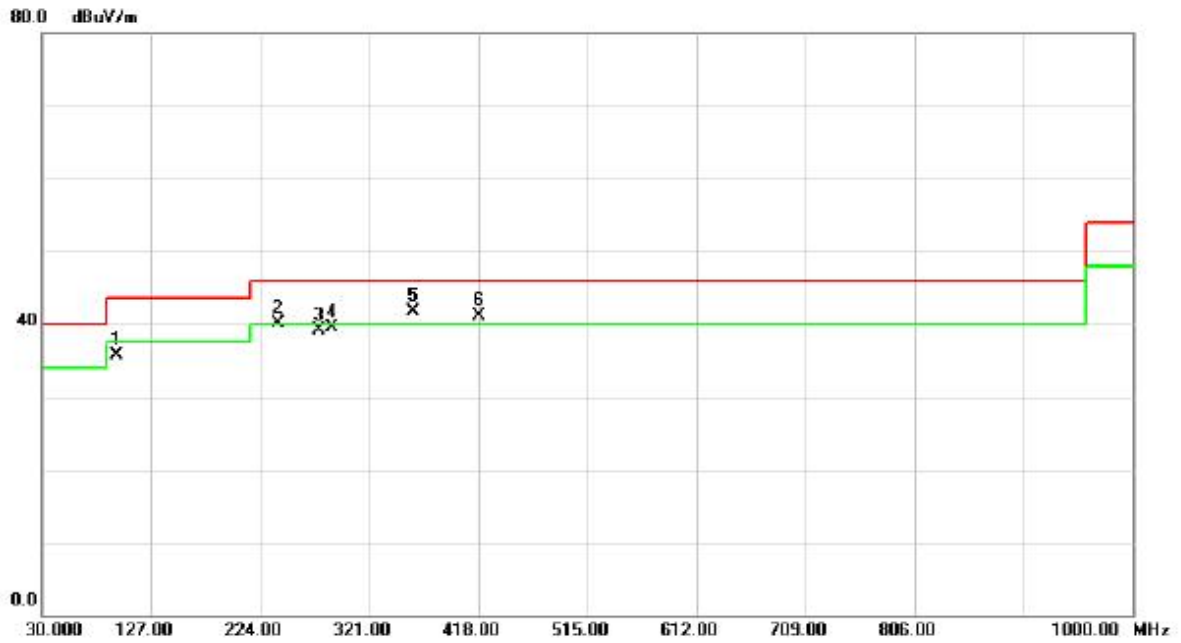

No.	Mk.	Freq. MHz	Reading Level dBuV	Correct Factor dB	Measure- ment dBuV/m	Limit dBuV/m	Over dB	Detector	Comment
1		95.9600	52.31	-16.67	35.64	43.50	-7.86	peak	
2	!	240.4900	53.69	-13.54	40.15	46.00	-5.85	peak	
3		276.3800	51.40	-12.23	39.17	46.00	-6.83	peak	
4		288.0200	50.49	-11.03	39.46	46.00	-6.54	peak	
5	*	359.8000	52.46	-10.77	41.69	46.00	-4.31	peak	
6	!	418.0000	49.66	-8.51	41.15	46.00	-4.85	peak	

Test Mode: TX B MODE CHANNEL 06

Vertical

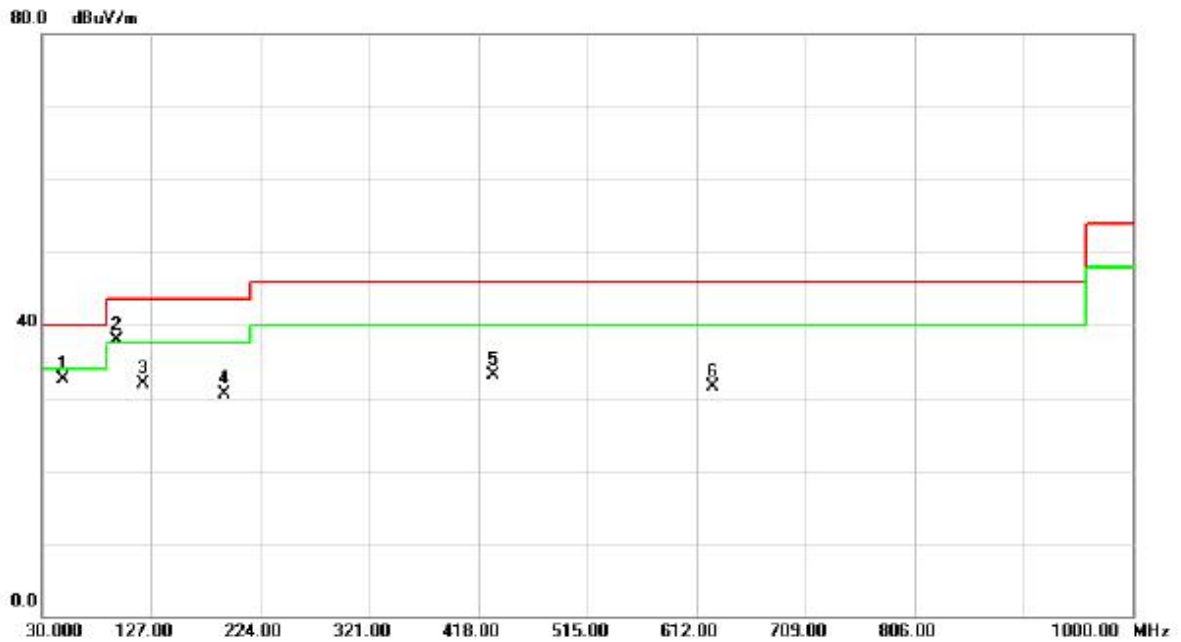

No.	Mk.	Freq. MHz	Reading Level dBuV	Correct Factor dB	Measure- ment dBuV/m	Limit dBuV/m	Over dB	Detector	Comment
1		48.4300	46.11	-13.70	32.41	40.00	-7.59	peak	
2	*	95.9600	54.64	-16.67	37.97	43.50	-5.53	peak	
3		120.2100	45.83	-13.90	31.93	43.50	-11.57	peak	
4		191.9900	44.77	-14.29	30.48	43.50	-13.02	peak	
5		431.5800	41.32	-8.27	33.05	46.00	-12.95	peak	
6		626.5500	37.28	-5.84	31.44	46.00	-14.56	peak	

Test Mode: TX B MODE CHANNEL 06

Horizontal

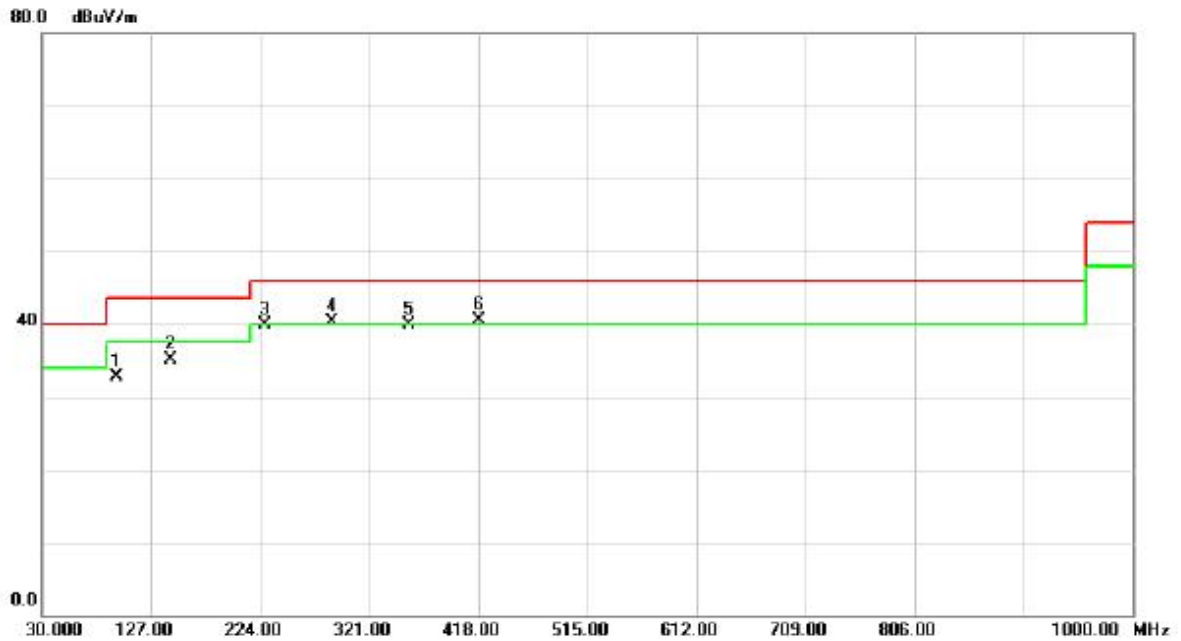

No.	Mk.	Freq. MHz	Reading Level dBuV	Correct Factor dB	Measure- ment dBuV/m	Limit dBuV/m	Over dB	Detector	Comment
1		95.9600	49.40	-16.67	32.73	43.50	-10.77	peak	
2		144.4600	48.05	-12.89	35.16	43.50	-8.34	peak	
3		227.8800	53.93	-13.99	39.94	46.00	-6.06	peak	
4	!	288.0200	51.39	-11.03	40.36	46.00	-5.64	peak	
5		356.8900	50.81	-10.90	39.91	46.00	-6.09	peak	
6	*	418.0000	49.10	-8.51	40.59	46.00	-5.41	peak	

Test Mode: TX B MODE CHANNEL 11

Vertical



No.	Mk.	Freq. MHz	Reading Level dBuV	Correct Factor dB	Measure- ment dBuV/m	Limit dBuV/m	Over dB	Detector	Comment
1		48.4300	46.71	-13.70	33.01	40.00	-6.99	peak	
2	*	95.9600	54.17	-16.67	37.50	43.50	-6.00	peak	
3		144.4600	43.97	-12.89	31.08	43.50	-12.42	peak	
4		223.0300	45.71	-14.31	31.40	46.00	-14.60	peak	
5		431.5800	40.05	-8.27	31.78	46.00	-14.22	peak	
6		621.7000	36.82	-6.12	30.70	46.00	-15.30	peak	

Test Mode: TX B MODE CHANNEL 11

Horizontal

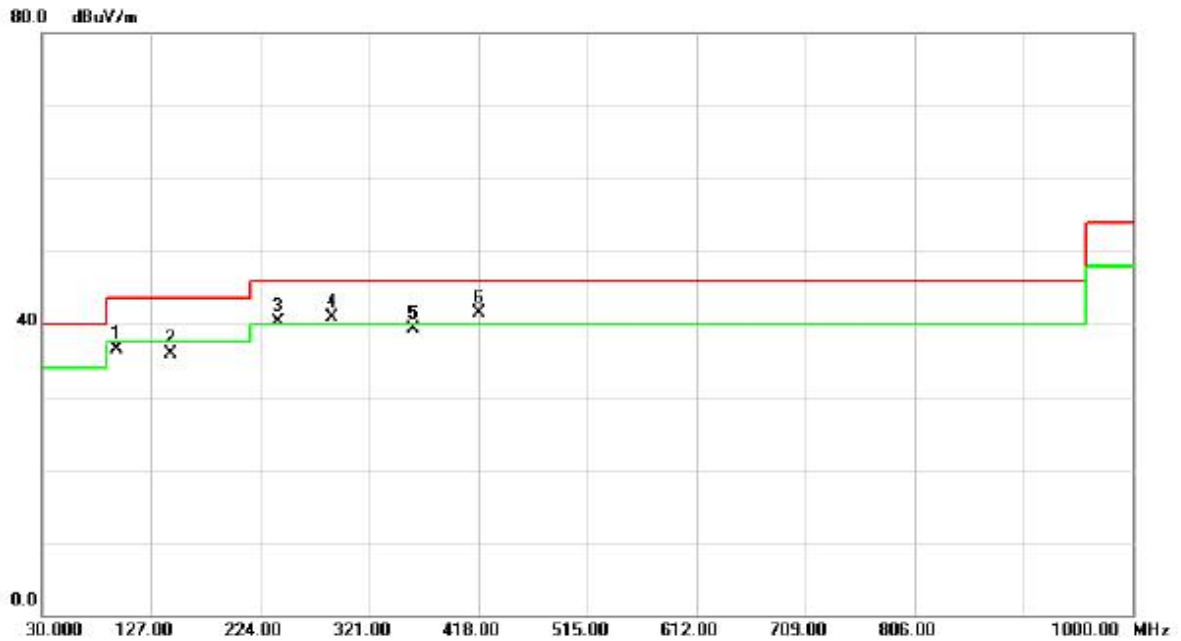

No.	Mk.	Freq. MHz	Reading Level dBuV	Correct Factor dB	Measure- ment dBuV/m	Limit dBuV/m	Over dB	Detector	Comment
1		95.9600	53.20	-16.67	36.53	43.50	-6.97	peak	
2		144.4600	48.78	-12.89	35.89	43.50	-7.61	peak	
3	!	240.4900	53.87	-13.54	40.33	46.00	-5.67	peak	
4	!	288.0200	51.93	-11.03	40.90	46.00	-5.10	peak	
5		359.8000	50.16	-10.77	39.39	46.00	-6.61	peak	
6	*	418.9700	50.00	-8.49	41.51	46.00	-4.49	peak	

For Dipole antenna

Test Mode: TX B MODE CHANNEL 01

Vertical



No.	Mk.	Freq. MHz	Reading Level dBuV	Correct Factor dB	Measure- ment dBuV/m	Limit dBuV/m	Over dB	Detector	Comment
1		48.4300	46.02	-13.70	32.32	40.00	-7.68	peak	
2	*	95.9600	53.82	-16.67	37.15	43.50	-6.35	peak	
3		226.9100	47.60	-14.05	33.55	46.00	-12.45	peak	
4		359.8000	43.49	-10.77	32.72	46.00	-13.28	peak	
5		424.7900	40.25	-8.39	31.86	46.00	-14.14	peak	
6		468.4400	40.22	-8.59	31.63	46.00	-14.37	peak	

Test Mode: TX B MODE CHANNEL 01

Horizontal

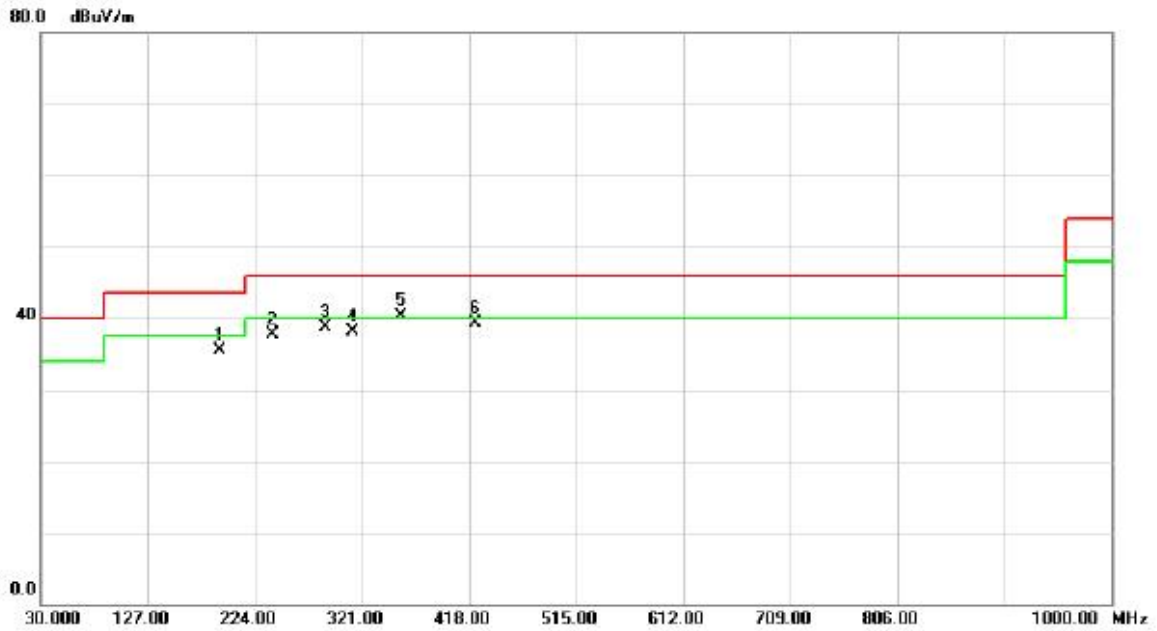

No.	Mk.	Freq. MHz	Reading Level dBuV	Correct Factor dB	Measure- ment dBuV/m	Limit dBuV/m	Over dB	Detector	Comment
1		191.9900	49.77	-14.29	35.48	43.50	-8.02	peak	
2		240.4900	51.25	-13.54	37.71	46.00	-8.29	peak	
3		288.0200	49.81	-11.03	38.78	46.00	-7.22	peak	
4		312.2700	48.89	-10.69	38.20	46.00	-7.80	peak	
5	*	355.9200	51.21	-10.96	40.25	46.00	-5.75	peak	
6		423.8200	47.78	-8.41	39.37	46.00	-6.63	peak	

Test Mode: TX B MODE CHANNEL 06

Vertical

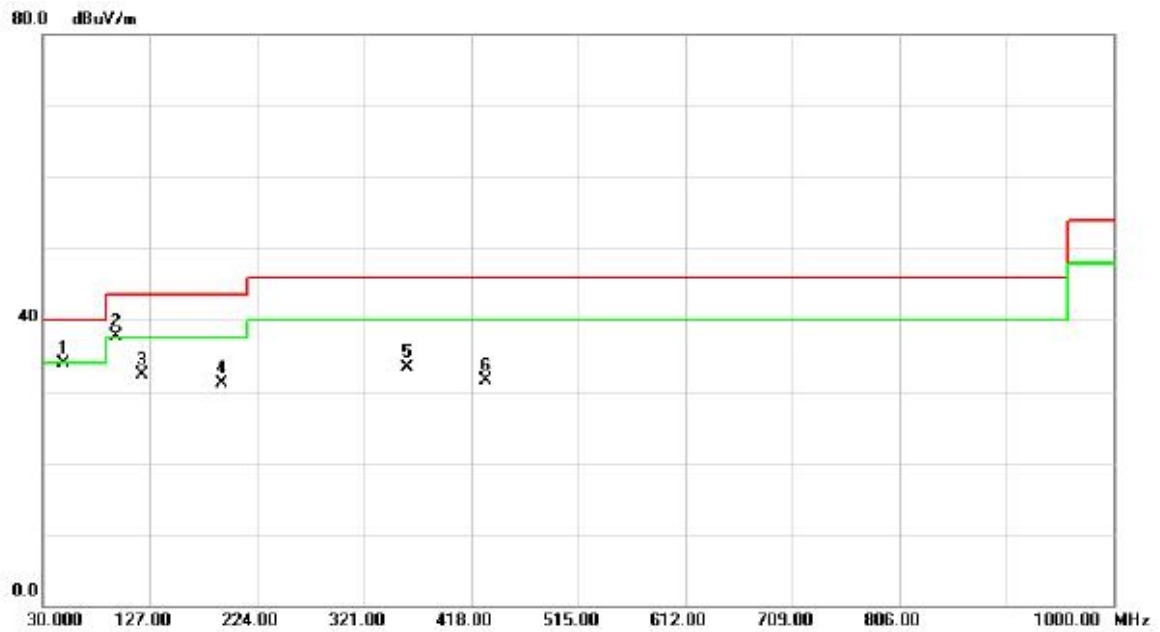

No.	Mk.	Freq. MHz	Reading Level dBuV	Correct Factor dB	Measure- ment dBuV/m	Limit dBuV/m	Over dB	Detector	Comment
1		48.4300	47.59	-13.70	33.89	40.00	-6.11	peak	
2	*	95.9600	54.31	-16.67	37.64	43.50	-5.86	peak	
3		120.2100	46.28	-13.90	32.38	43.50	-11.12	peak	
4		191.9900	45.40	-14.29	31.11	43.50	-12.39	peak	
5		359.8000	44.03	-10.77	33.26	46.00	-12.74	peak	
6		431.5800	39.69	-8.27	31.42	46.00	-14.58	peak	

Test Mode: TX B MODE CHANNEL 06

Horizontal

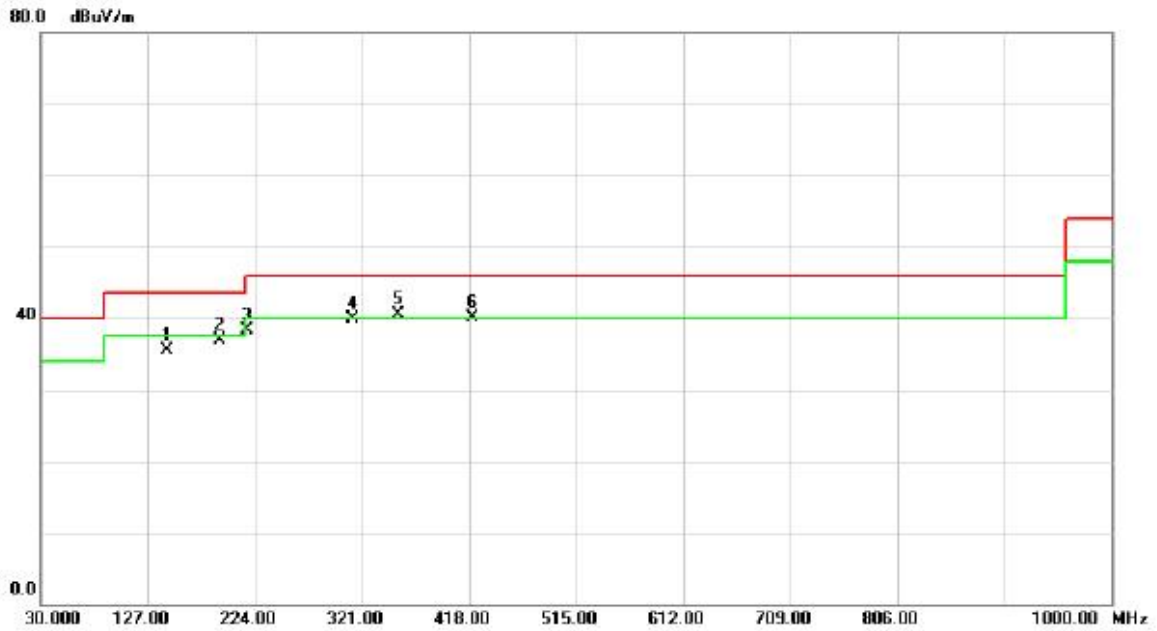

No.	Mk.	Freq. MHz	Reading Level dBuV	Correct Factor dB	Measure- ment dBuV/m	Limit dBuV/m	Over dB	Detector	Comment
1		144.4600	48.41	-12.89	35.52	43.50	-7.98	peak	
2		191.9900	51.21	-14.29	36.92	43.50	-6.58	peak	
3		216.2400	53.06	-14.67	38.39	46.00	-7.61	peak	
4		312.2700	50.62	-10.69	39.93	46.00	-6.07	peak	
5	*	353.9800	51.53	-11.05	40.48	46.00	-5.52	peak	
6	!	420.9100	48.60	-8.46	40.14	46.00	-5.86	peak	

Test Mode: TX B MODE CHANNEL 11

Vertical

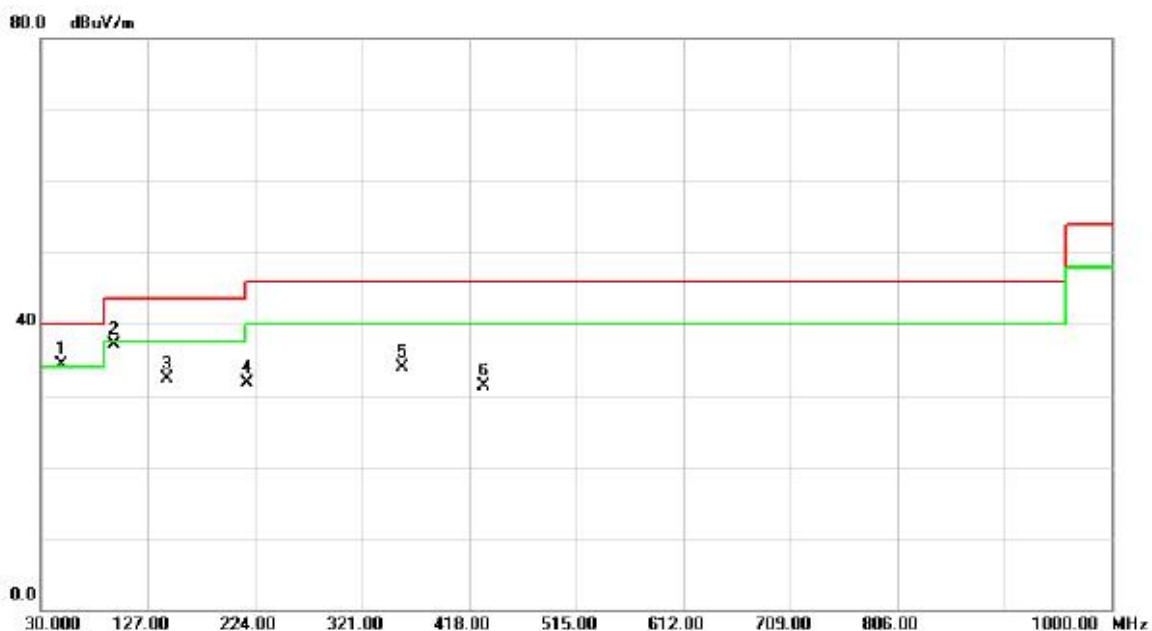

No.	Mk.	Freq. MHz	Reading Level dBuV	Correct Factor dB	Measure- ment dBuV/m	Limit dBuV/m	Over dB	Detector	Comment
1	*	48.4300	48.05	-13.70	34.35	40.00	-5.65	peak	
2		95.9600	53.76	-16.67	37.09	43.50	-6.41	peak	
3		144.4600	45.24	-12.89	32.35	43.50	-11.15	peak	
4		216.2400	46.28	-14.67	31.61	46.00	-14.39	peak	
5		357.8600	44.69	-10.86	33.83	46.00	-12.17	peak	
6		431.5800	39.54	-8.27	31.27	46.00	-14.73	peak	

Test Mode: TX B MODE CHANNEL 11

Horizontal

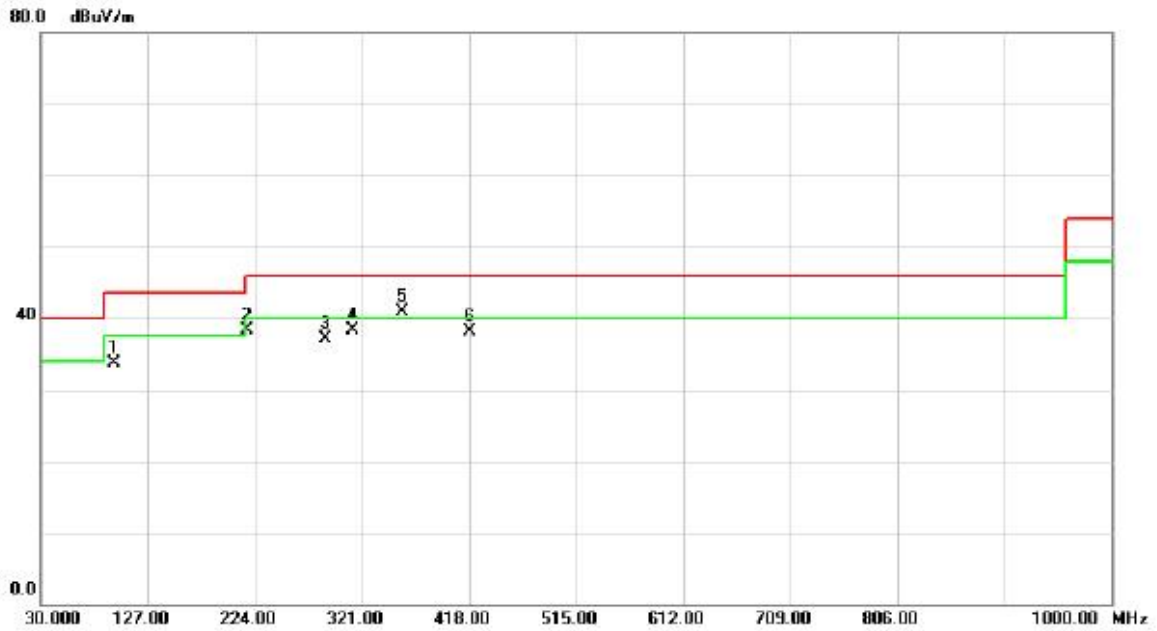

No.	Mk.	Freq. MHz	Reading Level dBuV	Correct Factor dB	Measure- ment dBuV/m	Limit dBuV/m	Over dB	Detector	Comment
1		95.9600	50.39	-16.67	33.72	43.50	-9.78	peak	
2		216.2400	52.89	-14.67	38.22	46.00	-7.78	peak	
3		288.0200	48.22	-11.03	37.19	46.00	-8.81	peak	
4		312.2700	49.02	-10.69	38.33	46.00	-7.67	peak	
5	*	357.8600	51.74	-10.86	40.88	46.00	-5.12	peak	
6		418.9700	46.52	-8.49	38.03	46.00	-7.97	peak	

ATTACHMENT D - RADIATED EMISSION (ABOVE 1000MHZ)

For Chip antenna

Orthogonal Axis :	X
Test Mode :	TX B MODE 2412MHz

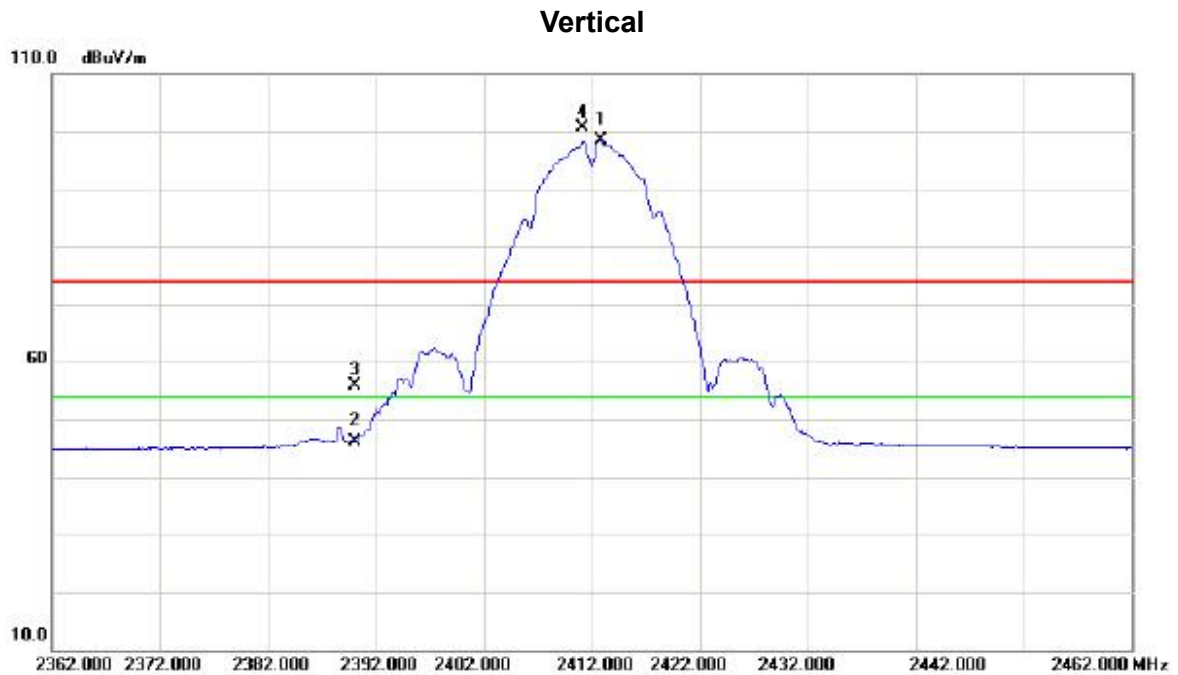

No.	Mk.	Freq. MHz	Reading Level dBuV	Correct Factor dB	Measure- ment dBuV/m	Limit dBuV/m	Margin dB	Detector	Comment
1	*	2412.800	65.57	32.71	98.28	54.00	44.28	AVG	NO LIMIT
2		2390.000	13.56	32.68	46.24	54.00	-7.76	AVG	
3		2390.000	23.22	32.68	55.90	74.00	-18.10	peak	
4	X	2411.100	67.98	32.71	100.69	74.00	26.69	peak	NO LIMIT

Orthogonal Axis :	X
Test Mode :	TX B MODE 2412MHz

Vertical

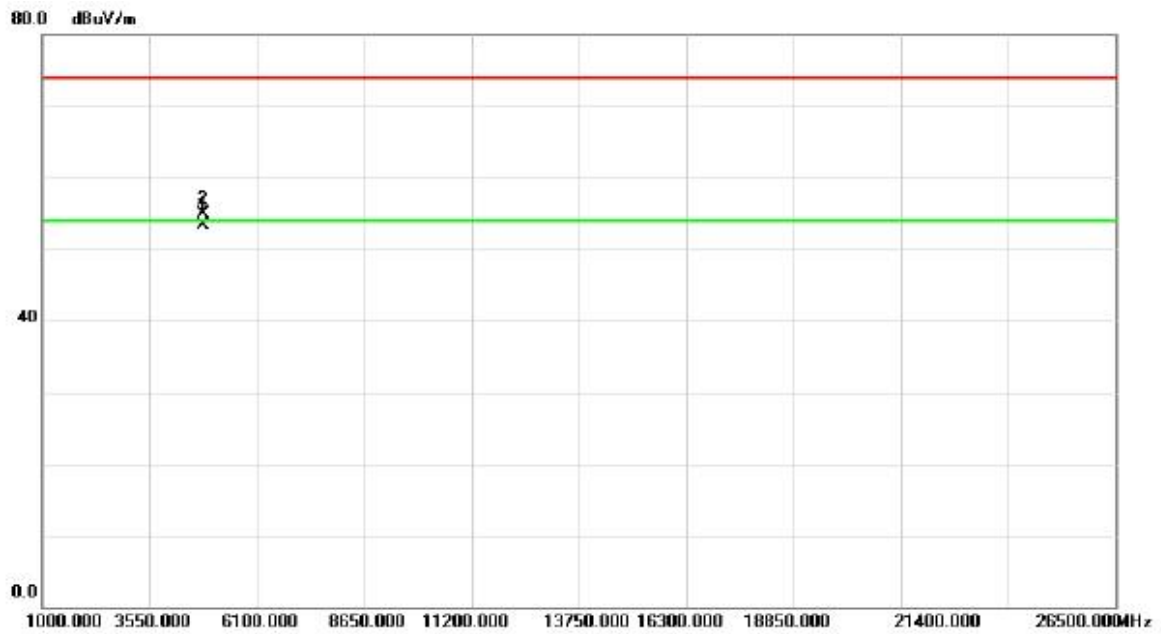

No.	Mk.	Freq. MHz	Reading Level dBuV	Correct Factor dB	Measure- ment dBuV/m	Limit dBuV/m	Margin dB	Detector	Comment
1	*	4824.040	49.61	3.62	53.23	54.00	-0.77	AVG	
2		4824.000	51.35	3.62	54.97	74.00	-19.03	peak	

Orthogonal Axis :	X
Test Mode :	TX B MODE 2412MHz

Horizontal



No.	Mk.	Freq. MHz	Reading Level dBuV	Correct Factor dB	Measure- ment dBuV/m	Limit dBuV/m	Margin dB	Detector	Comment
1	*	2412.700	56.37	32.71	89.08	54.00	35.08	AVG	NO LIMIT
2		2390.000	12.06	32.68	44.74	54.00	-9.26	AVG	
3		2390.000	23.17	32.68	55.85	74.00	-18.15	peak	
4	X	2411.100	68.25	32.71	100.96	74.00	26.96	peak	NO LIMIT

Orthogonal Axis :	X
Test Mode :	TX B MODE 2412MHz

Horizontal

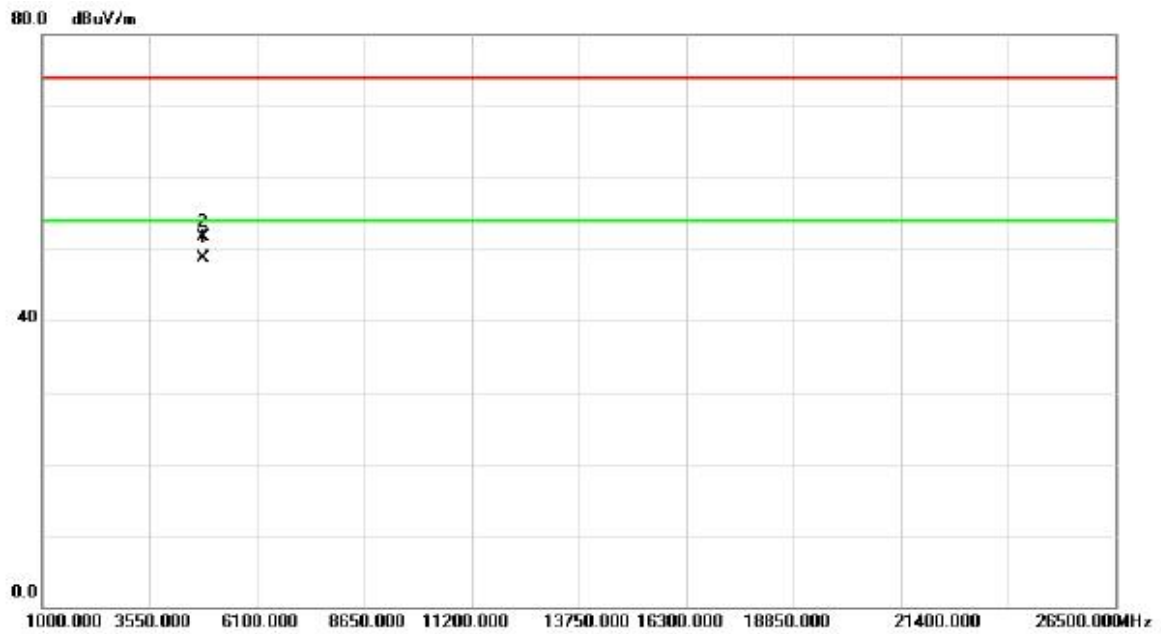

No.	Mk.	Freq. MHz	Reading Level dBuV	Correct Factor dB	Measure- ment dBuV/m	Limit dBuV/m	Margin dB	Detector	Comment
1	*	4823.940	45.05	3.62	48.67	54.00	-5.33	AVG	
2		4824.020	48.15	3.62	51.77	74.00	-22.23	peak	

Orthogonal Axis :	X
Test Mode :	TX B MODE 2437MHz

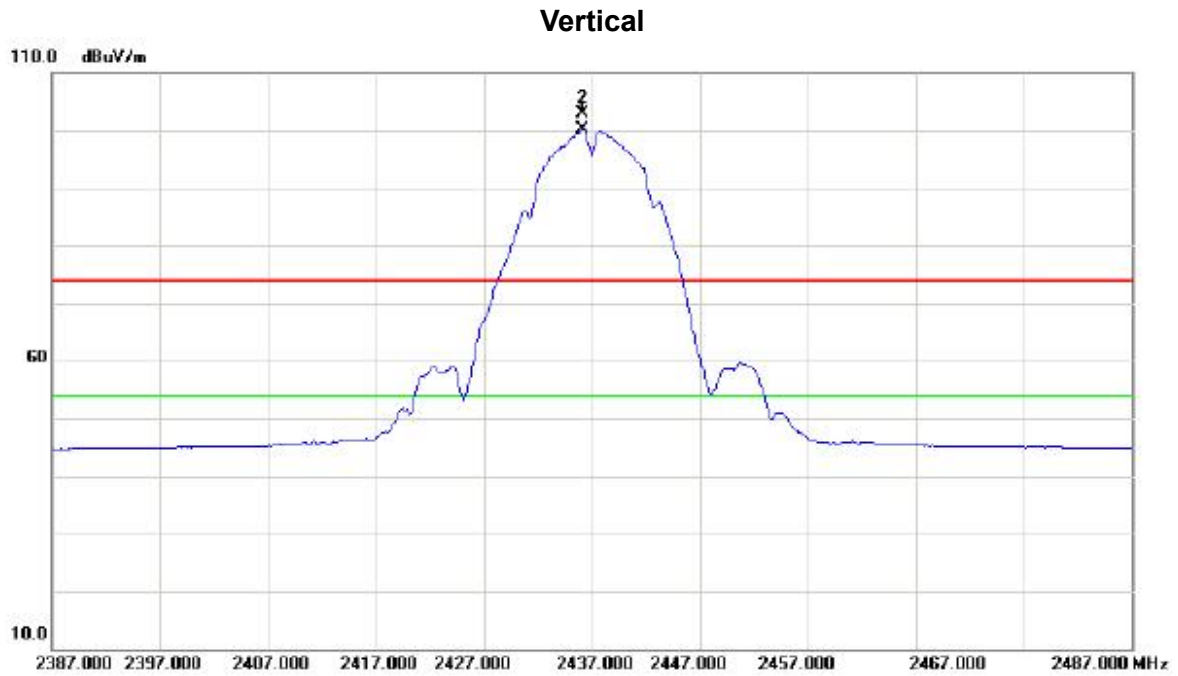

No.	Mk.	Freq. MHz	Reading Level dBuV	Correct Factor dB	Measure- ment dBuV/m	Limit dBuV/m	Margin dB	Detector	Comment
1	*	2436.200	67.37	32.74	100.11	54.00	46.11	AVG	NO LIMIT
2	X	2436.100	70.13	32.74	102.87	74.00	28.87	peak	NO LIMIT

Orthogonal Axis :	X
Test Mode :	TX B MODE 2437MHz

Vertical

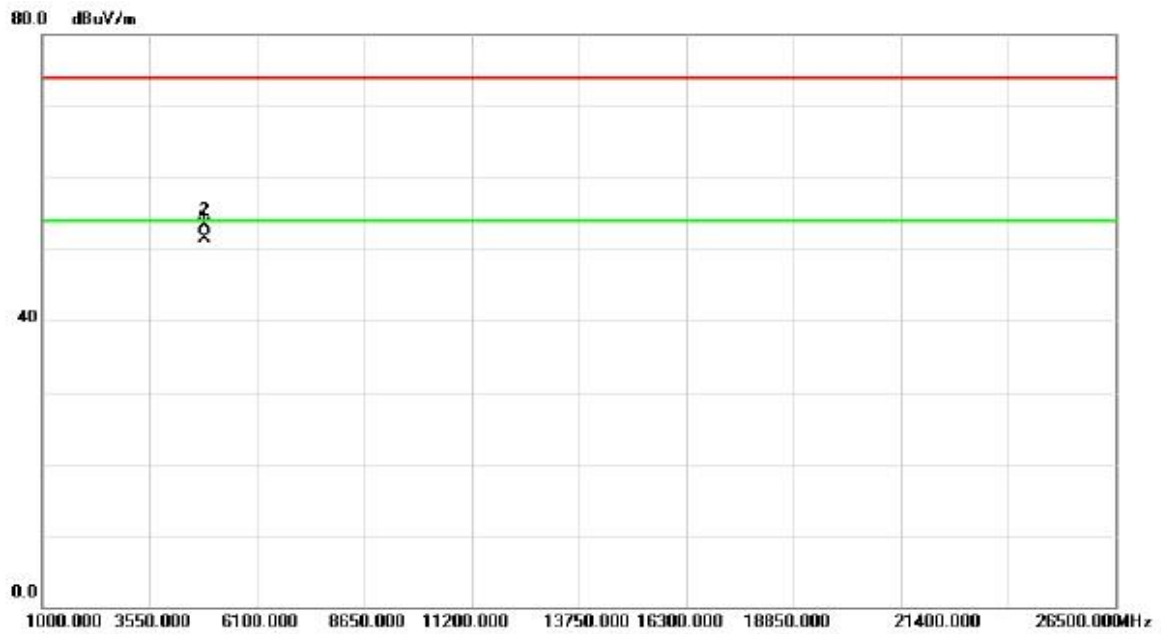

No.	Mk.	Freq. MHz	Reading Level dBuV	Correct Factor dB	Measure- ment dBuV/m	Limit dBuV/m	Margin dB	Detector	Comment
1	*	4874.000	47.86	3.72	51.58	54.00	-2.42	AVG	
2		4873.960	49.54	3.72	53.26	74.00	-20.74	peak	

Orthogonal Axis :	X
Test Mode :	TX B MODE 2437MHz

Horizontal

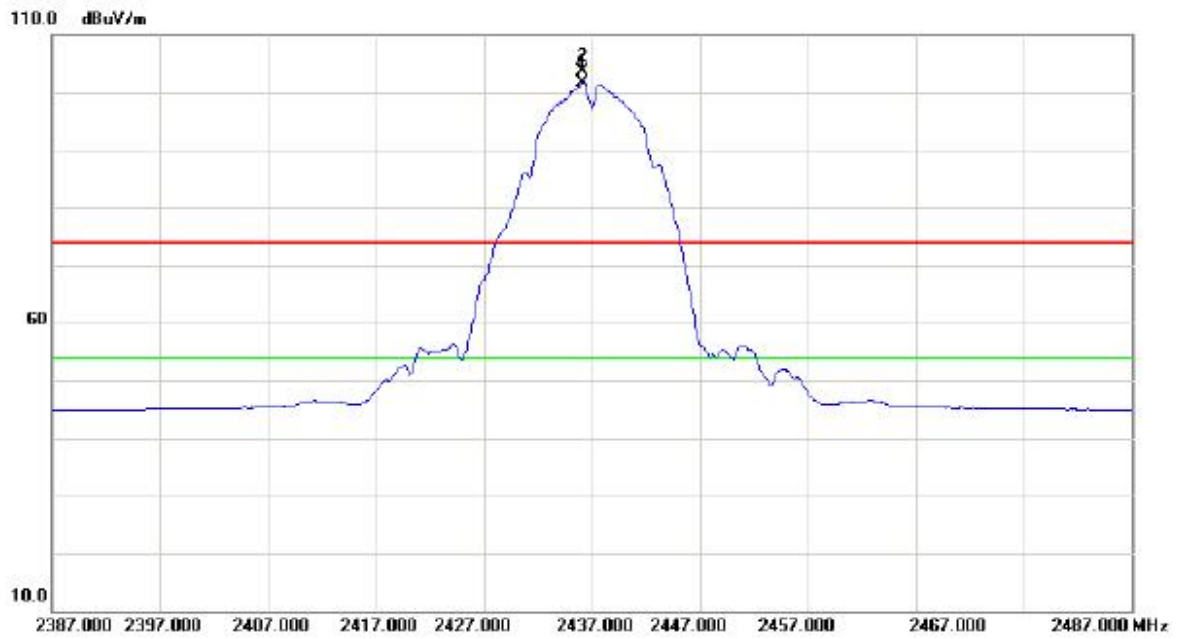

No.	Mk.	Freq. MHz	Reading Level dBuV	Correct Factor dB	Measure- ment dBuV/m	Limit dBuV/m	Margin dB	Detector	Comment
1	*	2436.200	68.85	32.74	101.59	54.00	47.59	AVG	NO LIMIT
2	X	2436.200	70.83	32.74	103.57	74.00	29.57	peak	NO LIMIT

Orthogonal Axis :	X
Test Mode :	TX B MODE 2437MHz

Horizontal

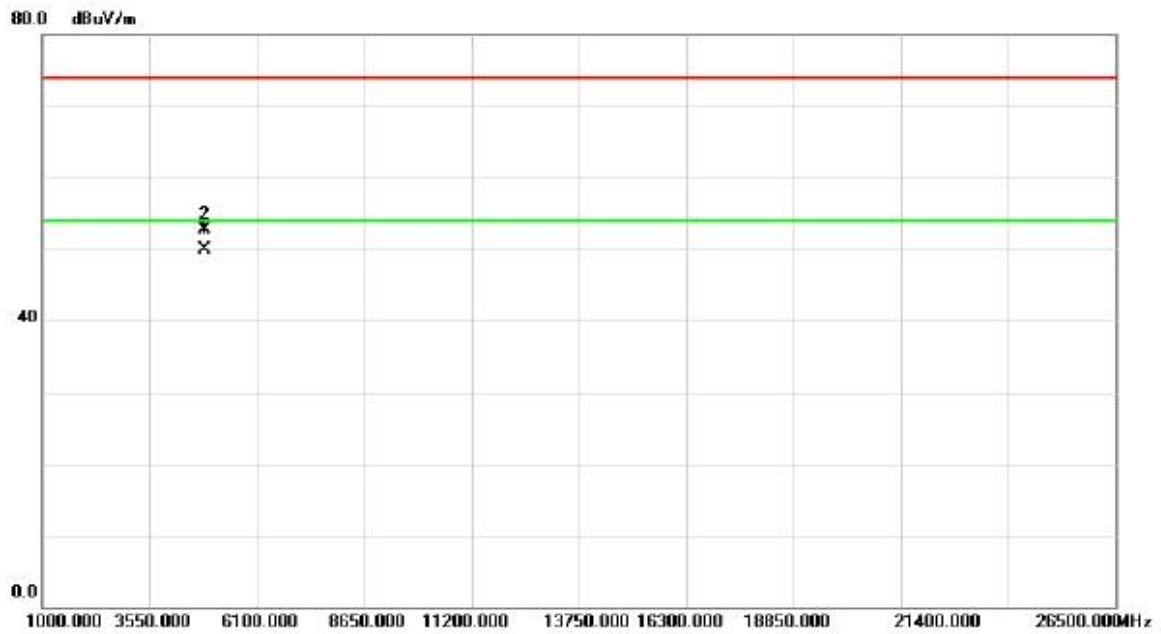

No.	Mk.	Freq. MHz	Reading Level dBuV	Correct Factor dB	Measure- ment dBuV/m	Limit dBuV/m	Margin dB	Detector	Comment
1	*	4873.980	46.28	3.72	50.00	54.00	-4.00	AVG	
2		4874.120	49.05	3.72	52.77	74.00	-21.23	peak	

Orthogonal Axis :	X
Test Mode :	TX B MODE 2462MHz

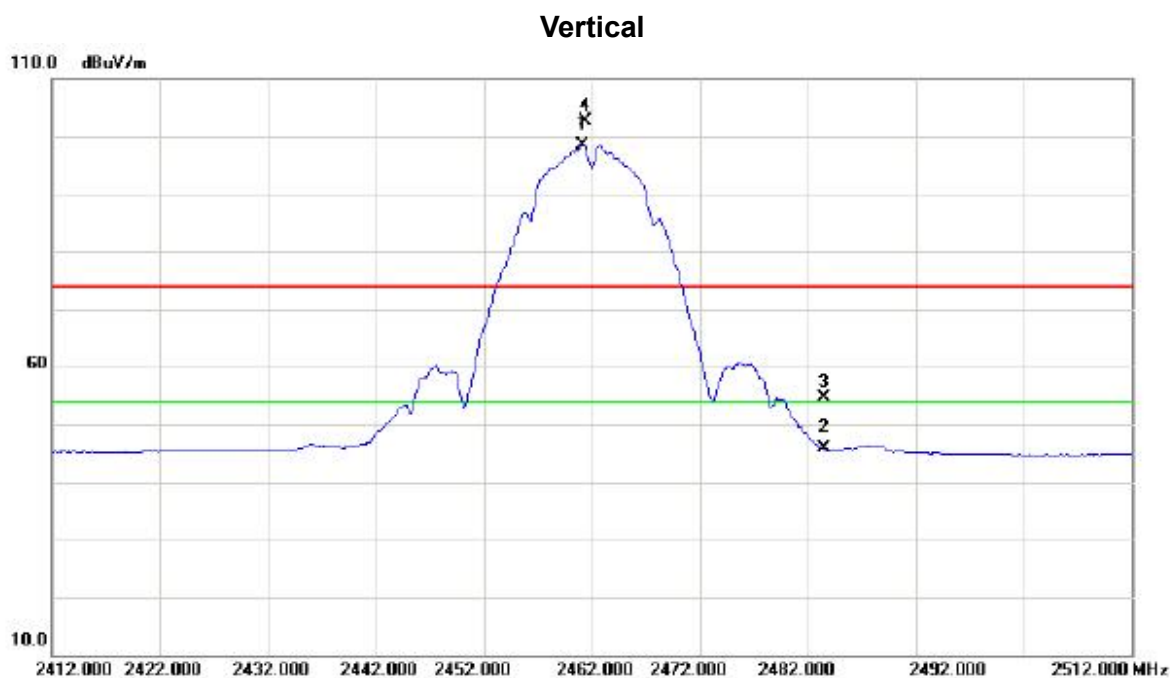

No.	Mk.	Freq. MHz	Reading Level dBuV	Correct Factor dB	Measure- ment dBuV/m	Limit dBuV/m	Margin dB	Detector	Comment
1	*	2461.200	65.71	32.78	98.49	54.00	44.49	AVG	NO LIMIT
2		2483.500	13.07	32.81	45.88	54.00	-8.12	AVG	
3		2483.500	21.88	32.81	54.69	74.00	-19.31	peak	
4	X	2461.400	69.77	32.78	102.55	74.00	28.55	peak	NO LIMIT

Orthogonal Axis :	X
Test Mode :	TX B MODE 2462MHz

Vertical



No.	Mk.	Freq. MHz	Reading Level dBuV	Correct Factor dB	Measure- ment dBuV/m	Limit dBuV/m	Margin dB	Detector	Comment
1	*	4924.000	43.57	3.80	47.37	54.00	-6.63	AVG	
2		4923.860	46.35	3.80	50.15	74.00	-23.85	peak	

Orthogonal Axis :	X
Test Mode :	TX B MODE 2462MHz

Horizontal

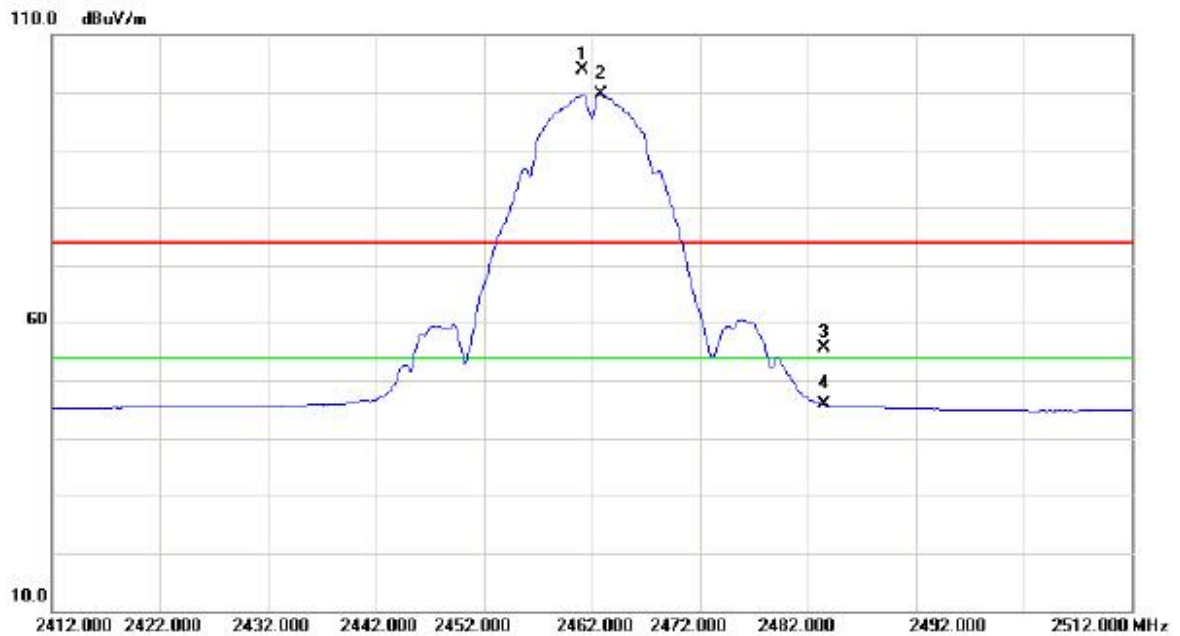

No.	Mk.	Freq. MHz	Reading Level dBuV	Correct Factor dB	Measure- ment dBuV/m	Limit dBuV/m	Margin dB	Detector	Comment
1	X	2461.200	71.11	32.78	103.89	74.00	29.89	peak	NO LIMIT
2	*	2462.800	66.89	32.78	99.67	54.00	45.67	AVG	NO LIMIT
3		2483.500	22.93	32.81	55.74	74.00	-18.26	peak	
4		2483.500	13.02	32.81	45.83	54.00	-8.17	AVG	

Orthogonal Axis :	X
Test Mode :	TX B MODE 2462MHz

Horizontal



No.	Mk.	Freq. MHz	Reading Level dBuV	Correct Factor dB	Measure- ment dBuV/m	Limit dBuV/m	Margin dB	Detector	Comment
1	*	4924.020	39.20	3.80	43.00	54.00	-11.00	AVG	
2		4924.160	44.12	3.80	47.92	74.00	-26.08	peak	

Orthogonal Axis :	X
Test Mode :	TX G MODE 2412MHz

Vertical

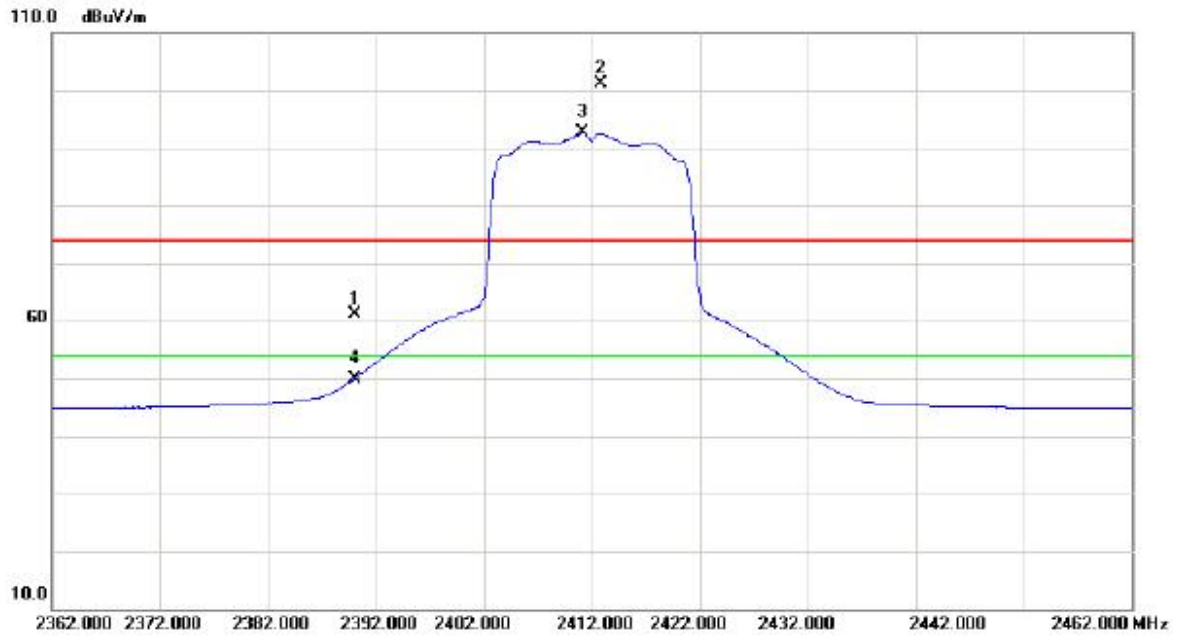

No.	Mk.	Freq. MHz	Reading Level dBuV	Correct Factor dB	Measure- ment dBuV/m	Limit dBuV/m	Margin dB	Detector	Comment
1		2390.000	32.31	28.91	61.22	74.00	-12.78	peak	
2	X	2412.800	72.28	28.93	101.21	74.00	27.21	peak	NO LIMIT
3	*	2411.200	63.60	28.93	92.53	54.00	38.53	AVG	NO LIMIT
4		2390.000	20.97	28.91	49.88	54.00	-4.12	AVG	

Orthogonal Axis :	X
Test Mode :	TX G MODE 2412MHz

Vertical



No.	Mk.	Freq. MHz	Reading Level dBuV	Correct Factor dB	Measure- ment dBuV/m	Limit dBuV/m	Margin dB	Detector	Comment
1	*	4824.000	39.32	3.62	42.94	54.00	-11.06	AVG	
2		4823.940	50.85	3.62	54.47	74.00	-19.53	peak	

Orthogonal Axis :	X
Test Mode :	TX G MODE 2412MHz

Horizontal

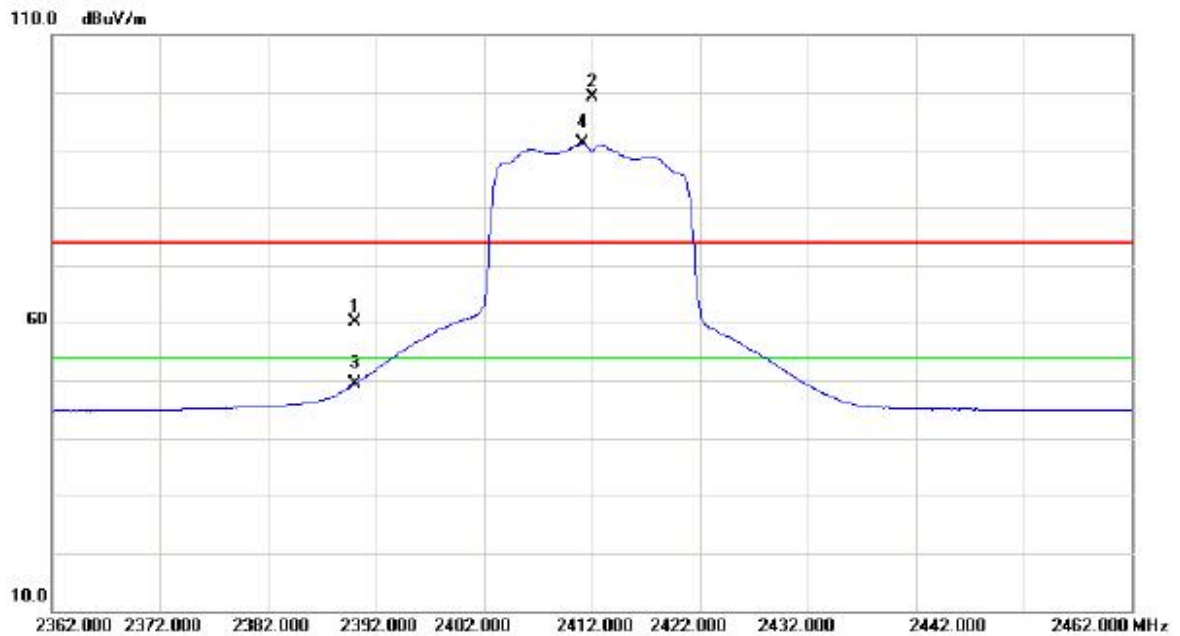

No.	Mk.	Freq. MHz	Reading Level dBuV	Correct Factor dB	Measure- ment dBuV/m	Limit dBuV/m	Margin dB	Detector	Comment
1		2390.000	31.33	28.91	60.24	74.00	-13.76	peak	
2	X	2412.000	70.29	28.93	99.22	74.00	25.22	peak	NO LIMIT
3		2390.000	20.39	28.91	49.30	54.00	-4.70	AVG	
4	*	2411.100	62.15	28.93	91.08	54.00	37.08	AVG	NO LIMIT

Orthogonal Axis :	X
Test Mode :	TX G MODE 2412MHz

Horizontal



No.	Mk.	Freq. MHz	Reading Level dBuV	Correct Factor dB	Measure- ment dBuV/m	Limit dBuV/m	Margin dB	Detector	Comment
1	*	4823.980	35.84	3.62	39.46	54.00	-14.54	AVG	
2		4824.040	47.49	3.62	51.11	74.00	-22.89	peak	

Orthogonal Axis :	X
Test Mode :	TX G MODE 2437MHz

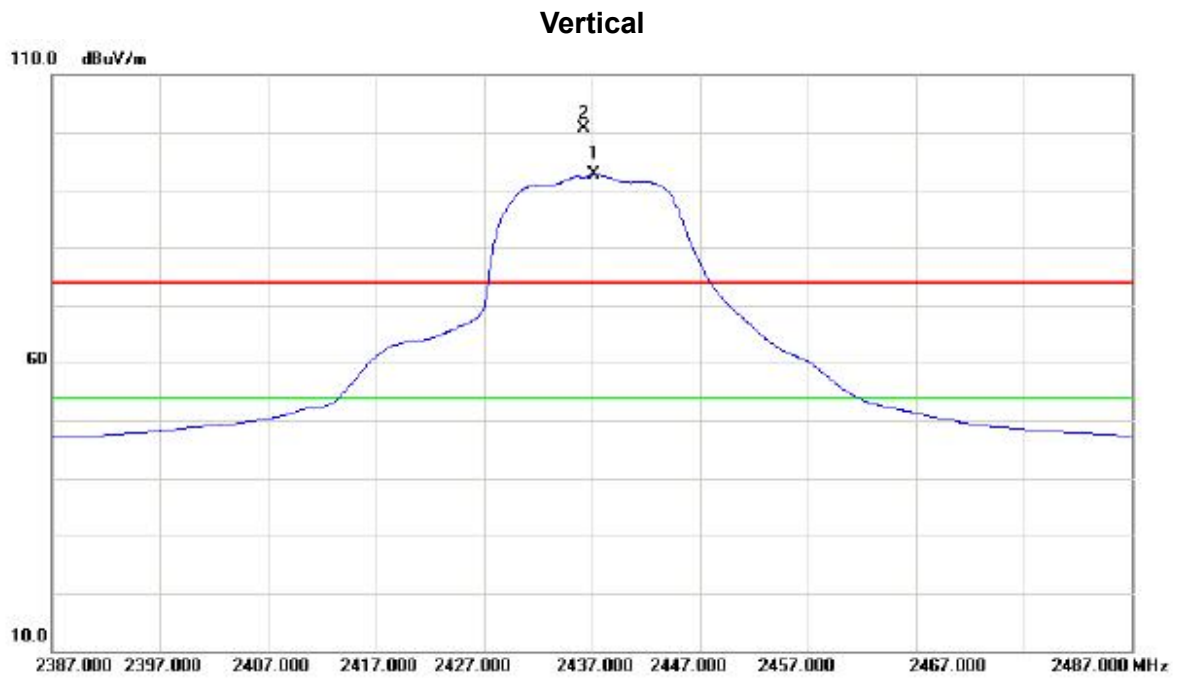

No.	Mk.	Freq. MHz	Reading Level dBuV	Correct Factor dB	Measure- ment dBuV/m	Limit dBuV/m	Margin dB	Detector	Comment
1	*	2437.200	59.81	32.74	92.55	54.00	38.55	AVG	NO LIMIT
2	X	2436.300	67.78	32.74	100.52	74.00	26.52	peak	NO LIMIT

Orthogonal Axis :	X
Test Mode :	TX G MODE 2437MHz

Vertical

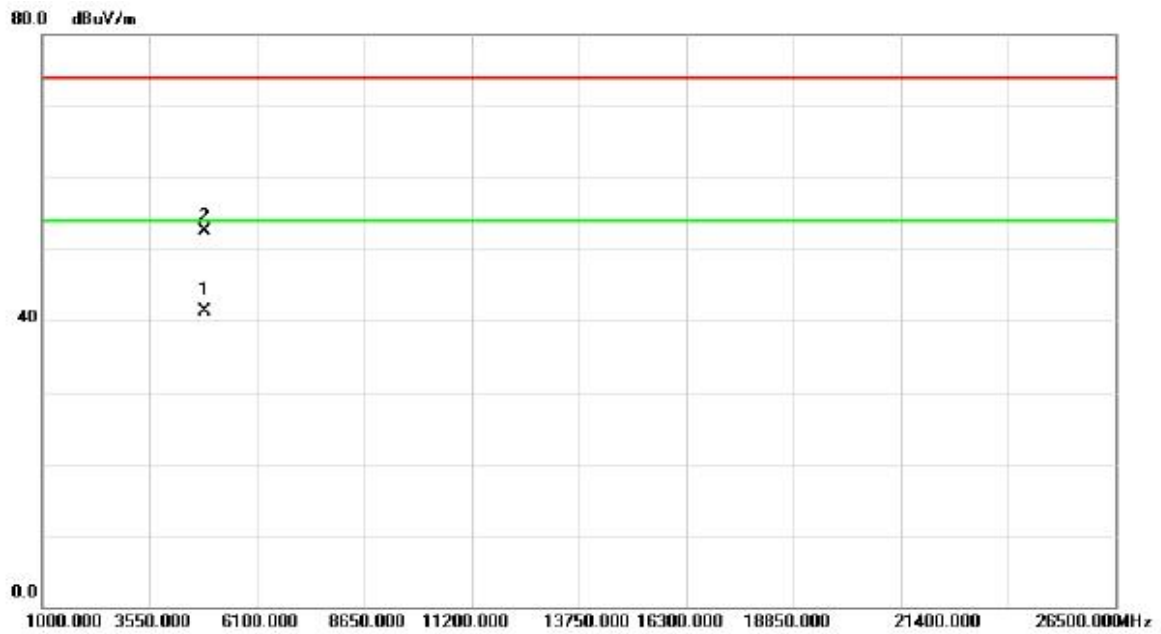

No.	Mk.	Freq. MHz	Reading Level dBuV	Correct Factor dB	Measure- ment dBuV/m	Limit dBuV/m	Margin dB	Detector	Comment
1	*	4873.960	37.68	3.72	41.40	54.00	-12.60	AVG	
2		4874.020	48.74	3.72	52.46	74.00	-21.54	peak	

Orthogonal Axis :	X
Test Mode :	TX G MODE 2437MHz

Horizontal

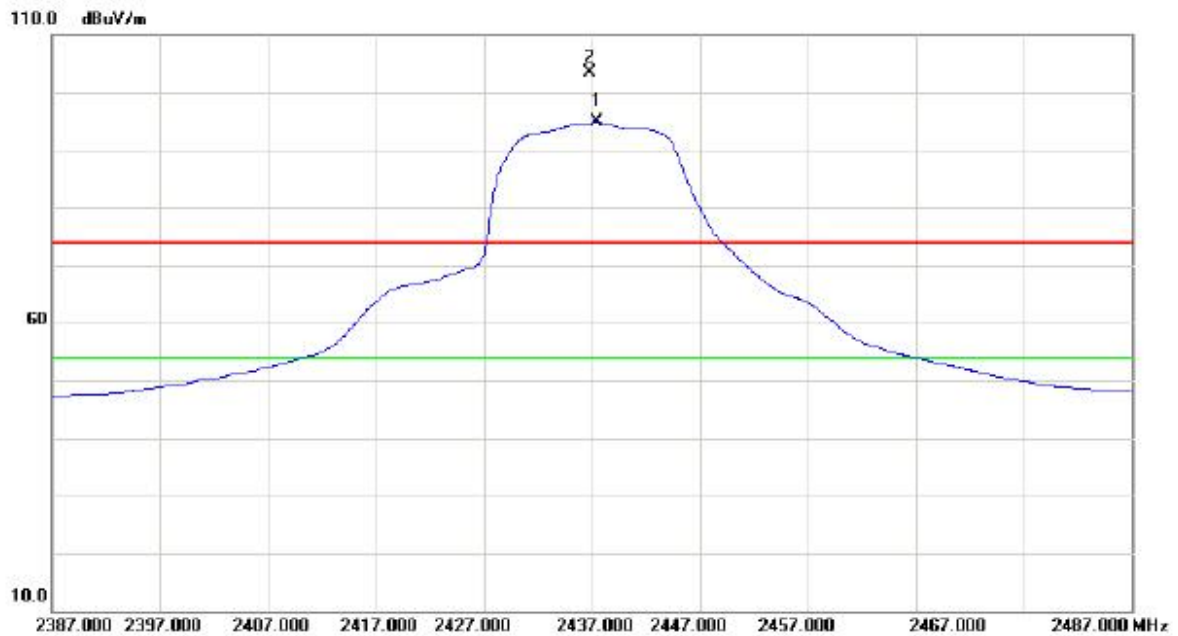

No.	Mk.	Freq. MHz	Reading Level dBuV	Correct Factor dB	Measure- ment dBuV/m	Limit dBuV/m	Margin dB	Detector	Comment
1	*	2437.400	62.05	32.74	94.79	54.00	40.79	AVG	NO LIMIT
2	X	2436.800	70.75	32.74	103.49	74.00	29.49	peak	NO LIMIT

Orthogonal Axis :	X
Test Mode :	TX G MODE 2437MHz

Horizontal



No.	Mk.	Freq. MHz	Reading Level dBuV	Correct Factor dB	Measure- ment dBuV/m	Limit dBuV/m	Margin dB	Detector	Comment
1	*	4874.020	34.84	3.72	38.56	54.00	-15.44	AVG	
2		4873.880	46.54	3.72	50.26	74.00	-23.74	peak	

Orthogonal Axis :	X
Test Mode :	TX G MODE 2462MHz

Vertical

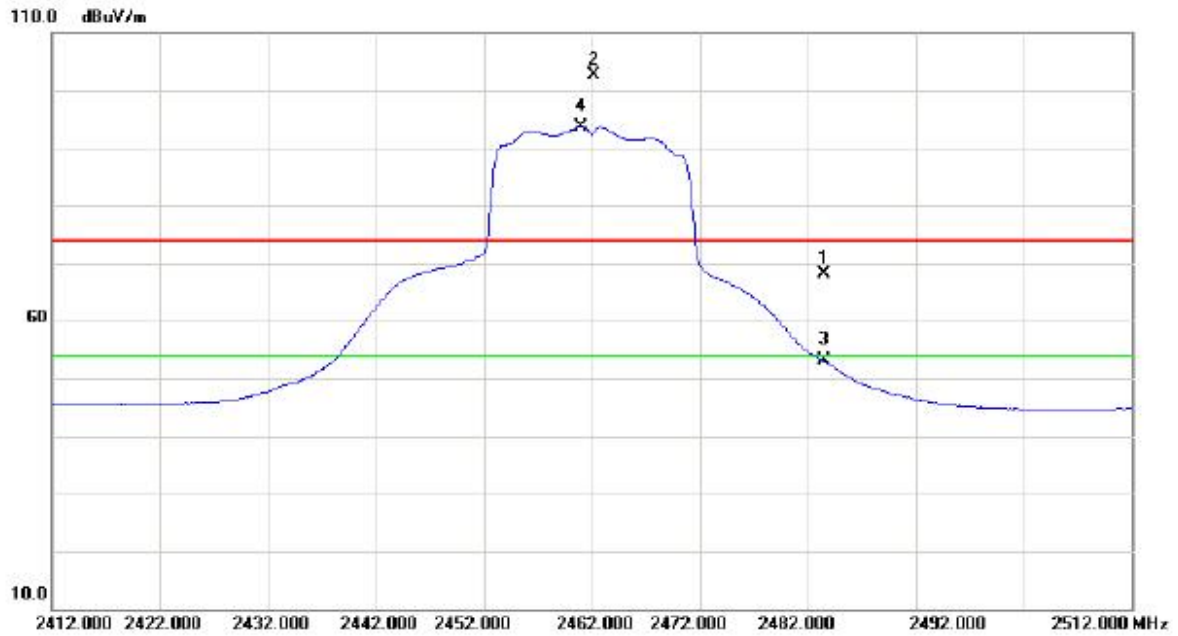

No.	Mk.	Freq. MHz	Reading Level dBuV	Correct Factor dB	Measure- ment dBuV/m	Limit dBuV/m	Margin dB	Detector	Comment
1		2483.500	39.18	28.99	68.17	74.00	-5.83	peak	
2	X	2462.200	73.70	28.97	102.67	74.00	28.67	peak	NO LIMIT
3		2483.500	24.05	28.99	53.04	54.00	-0.96	AVG	
4	*	2461.000	64.75	28.97	93.72	54.00	39.72	AVG	NO LIMIT

Orthogonal Axis :	X
Test Mode :	TX G MODE 2462MHz

Vertical



No.	Mk.	Freq. MHz	Reading Level dBuV	Correct Factor dB	Measure- ment dBuV/m	Limit dBuV/m	Margin dB	Detector	Comment
1	*	4924.000	35.14	3.80	38.94	54.00	-15.06	AVG	
2		4924.000	44.95	3.80	48.75	74.00	-25.25	peak	

Orthogonal Axis :	X
Test Mode :	TX G MODE 2462MHz

Horizontal

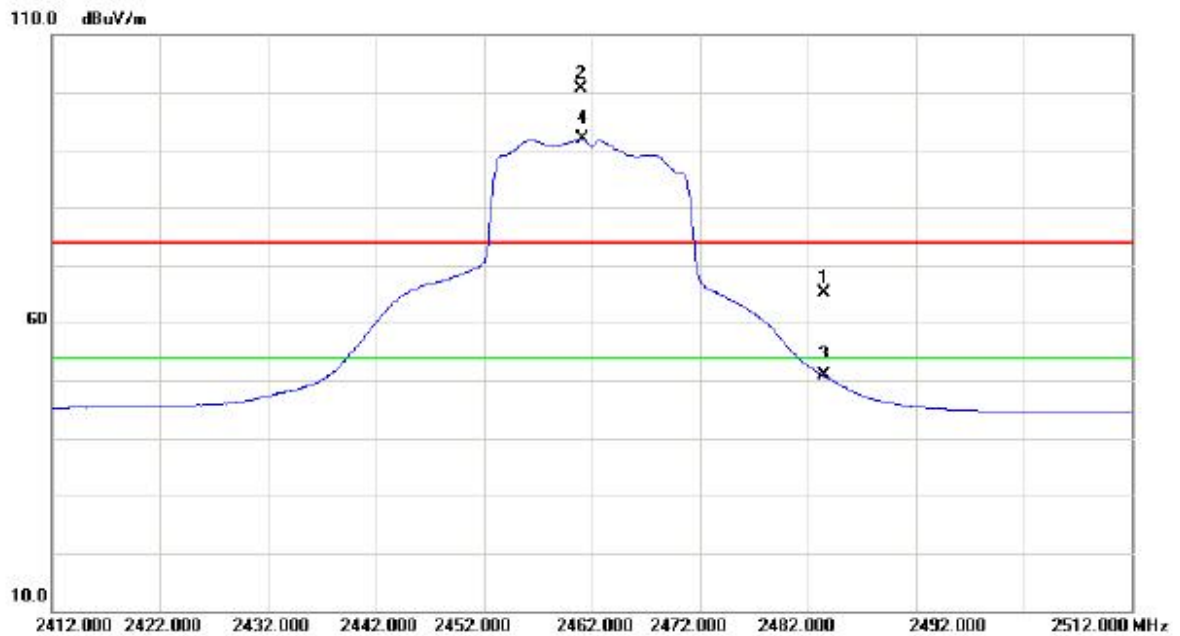

No.	Mk.	Freq. MHz	Reading Level dBuV	Correct Factor dB	Measure- ment dBuV/m	Limit dBuV/m	Margin dB	Detector	Comment
1		2483.500	36.05	28.99	65.04	74.00	-8.96	peak	
2	X	2461.000	71.73	28.97	100.70	74.00	26.70	peak	NO LIMIT
3		2483.500	21.79	28.99	50.78	54.00	-3.22	AVG	
4	*	2461.100	62.98	28.97	91.95	54.00	37.95	AVG	NO LIMIT

Orthogonal Axis :	X
Test Mode :	TX G MODE 2462MHz

Horizontal



No.	Mk.	Freq. MHz	Reading Level dBuV	Correct Factor dB	Measure- ment dBuV/m	Limit dBuV/m	Margin dB	Detector	Comment
1	*	4924.000	32.67	3.80	36.47	54.00	-17.53	AVG	
2		4923.820	42.58	3.80	46.38	74.00	-27.62	peak	

Orthogonal Axis :	X
Test Mode :	TX N-20M MODE 2412MHz

Vertical

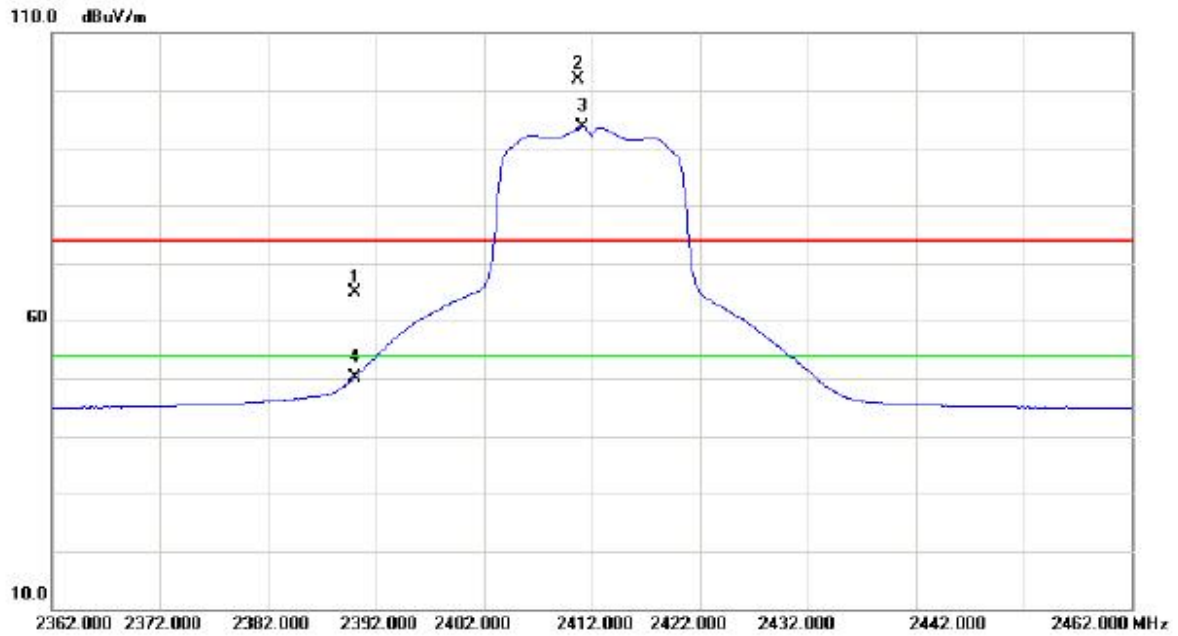

No.	Mk.	Freq. MHz	Reading Level dBuV	Correct Factor dB	Measure- ment dBuV/m	Limit dBuV/m	Margin dB	Detector	Comment
1		2390.000	35.91	28.91	64.82	74.00	-9.18	peak	
2	X	2410.700	73.01	28.93	101.94	74.00	27.94	peak	NO LIMIT
3	*	2411.200	64.60	28.93	93.53	54.00	39.53	AVG	NO LIMIT
4		2390.000	21.14	28.91	50.05	54.00	-3.95	AVG	

Orthogonal Axis :	X
Test Mode :	TX N-20M MODE 2412MHz

Vertical



No.	Mk.	Freq. MHz	Reading Level dBuV	Correct Factor dB	Measure- ment dBuV/m	Limit dBuV/m	Margin dB	Detector	Comment
1	*	4824.000	37.20	3.62	40.82	54.00	-13.18	AVG	
2		4823.880	49.55	3.62	53.17	74.00	-20.83	peak	

Orthogonal Axis :	X
Test Mode :	TX N-20M MODE 2412MHz

Horizontal

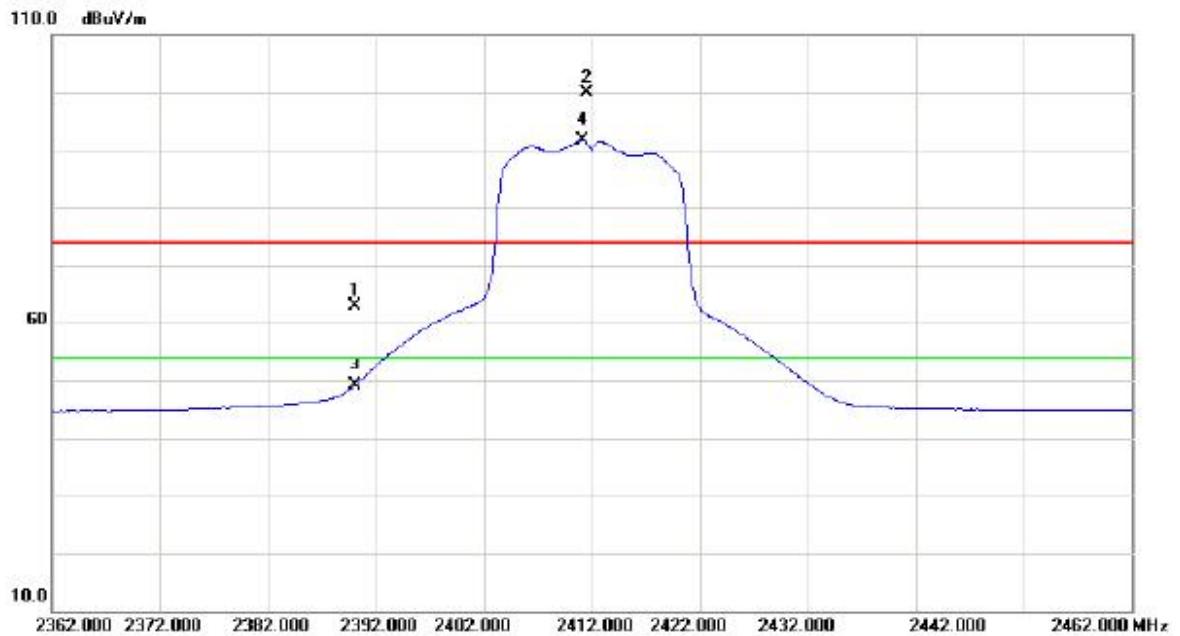

No.	Mk.	Freq. MHz	Reading Level dBuV	Correct Factor dB	Measure- ment dBuV/m	Limit dBuV/m	Margin dB	Detector	Comment
1		2390.000	33.85	28.91	62.76	74.00	-11.24	peak	
2	X	2411.600	70.93	28.93	99.86	74.00	25.86	peak	NO LIMIT
3		2390.000	20.11	28.91	49.02	54.00	-4.98	AVG	
4	*	2411.100	62.62	28.93	91.55	54.00	37.55	AVG	NO LIMIT

Orthogonal Axis :	X
Test Mode :	TX N-20M MODE 2412MHz

Horizontal

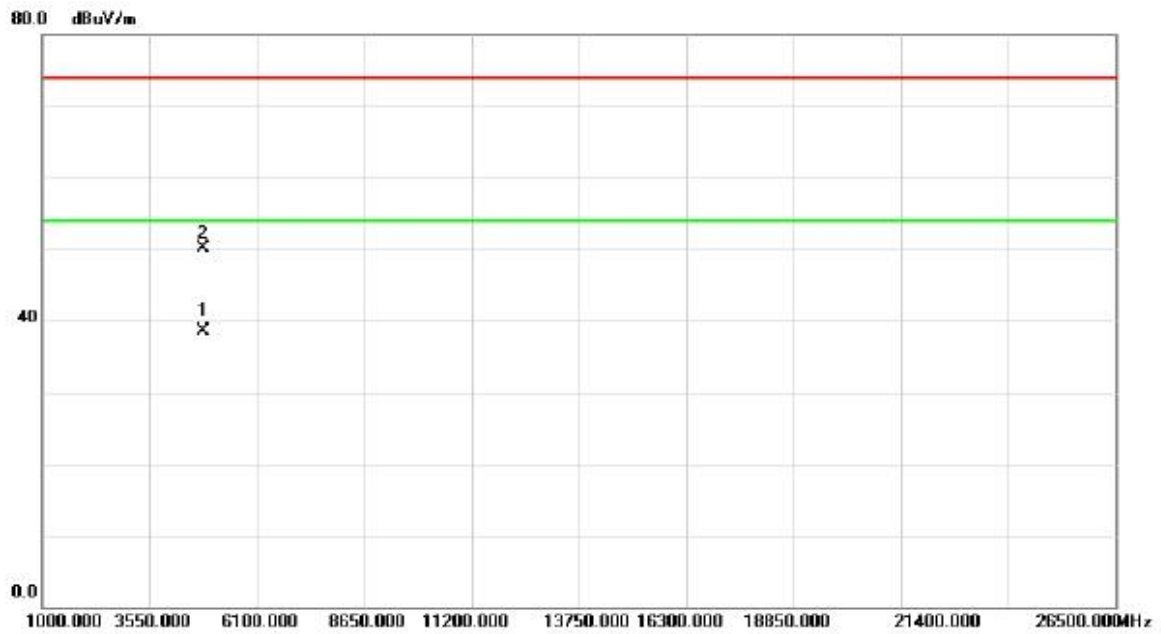

No.	Mk.	Freq. MHz	Reading Level dBuV	Correct Factor dB	Measure- ment dBuV/m	Limit dBuV/m	Margin dB	Detector	Comment
1	*	4824.000	34.96	3.62	38.58	54.00	-15.42	AVG	
2		4823.960	46.46	3.62	50.08	74.00	-23.92	peak	

Orthogonal Axis :	X
Test Mode :	TX N-20M MODE 2437MHz

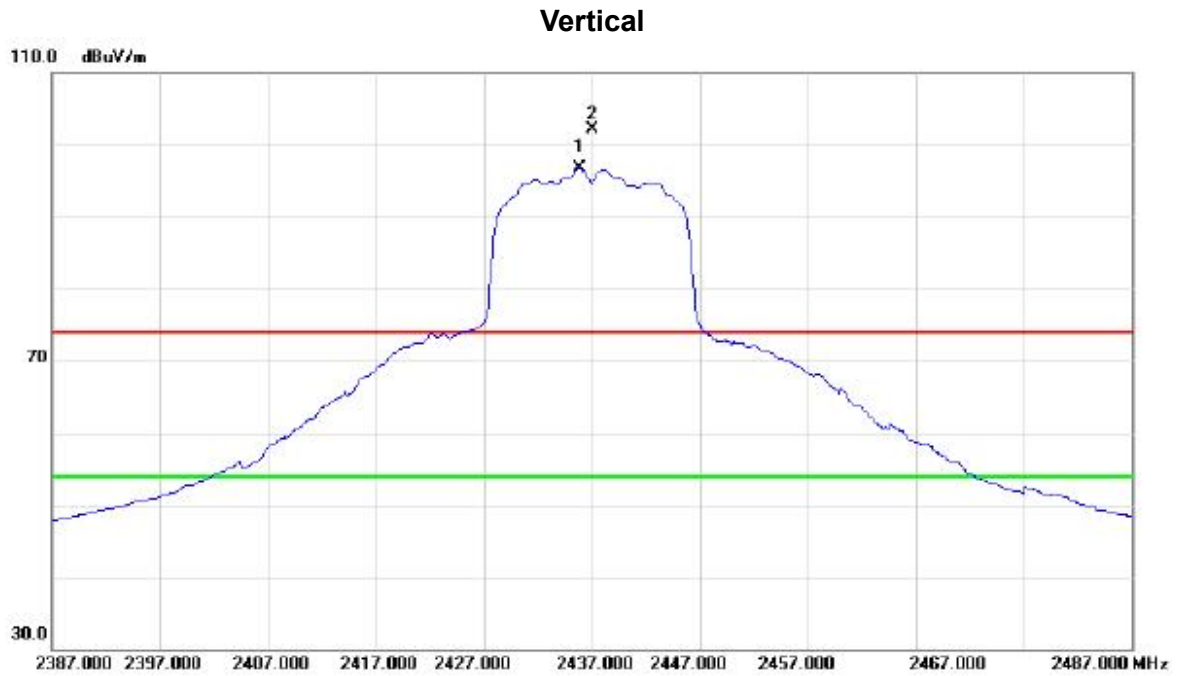

No.	Mk.	Freq. MHz	Reading Level dBuV	Correct Factor dB	Measure- ment dBuV/m	Limit dBuV/m	Margin dB	Detector	Comment
1	*	2435.800	63.98	32.74	96.72	54.00	42.72	AVG	NO LIMIT
2	X	2437.000	69.40	32.74	102.14	74.00	28.14	peak	NO LIMIT

Orthogonal Axis :	X
Test Mode :	TX N-20M MODE 2437MHz

Vertical



No.	Mk.	Freq. MHz	Reading Level dBuV	Correct Factor dB	Measure- ment dBuV/m	Limit dBuV/m	Margin dB	Detector	Comment
1	*	4874.040	35.60	3.72	39.32	54.00	-14.68	AVG	
2		4873.820	48.53	3.72	52.25	74.00	-21.75	peak	

Orthogonal Axis :	X
Test Mode :	TX N-20M MODE 2437MHz

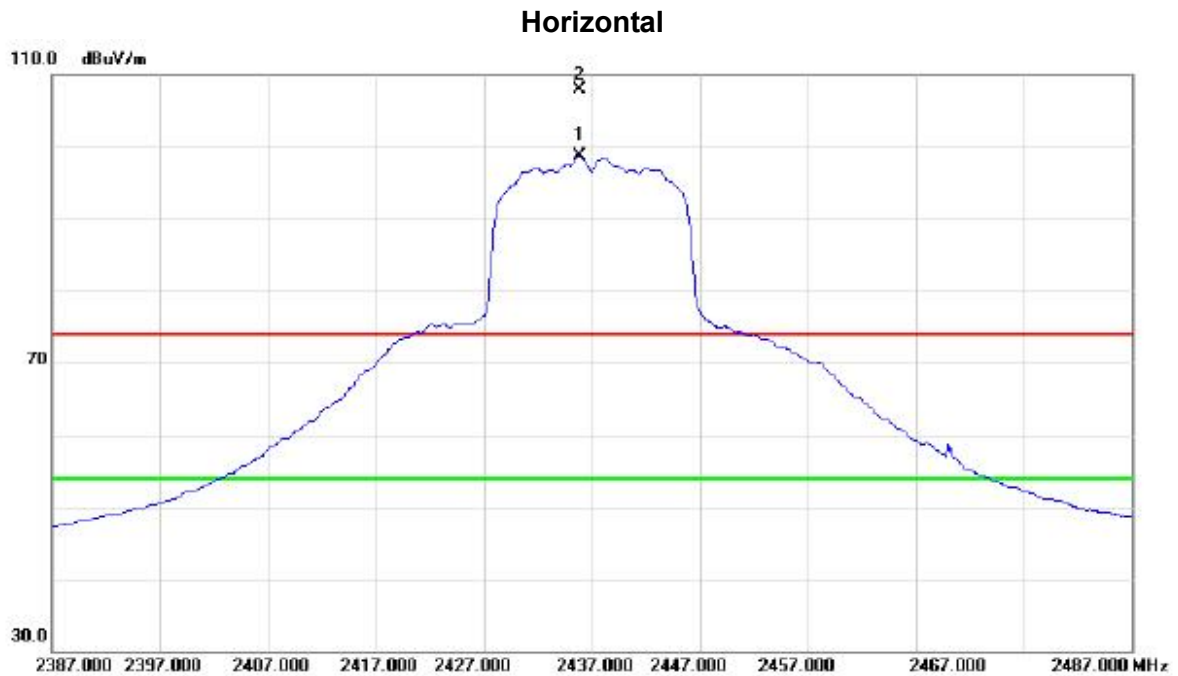

No.	Mk.	Freq. MHz	Reading Level dBuV	Correct Factor dB	Measure- ment dBuV/m	Limit dBuV/m	Margin dB	Detector	Comment
1	*	2435.900	65.97	32.74	98.71	54.00	44.71	AVG	NO LIMIT
2	X	2435.900	75.20	32.74	107.94	74.00	33.94	peak	NO LIMIT

Orthogonal Axis :	X
Test Mode :	TX N-20M MODE 2437MHz

Horizontal

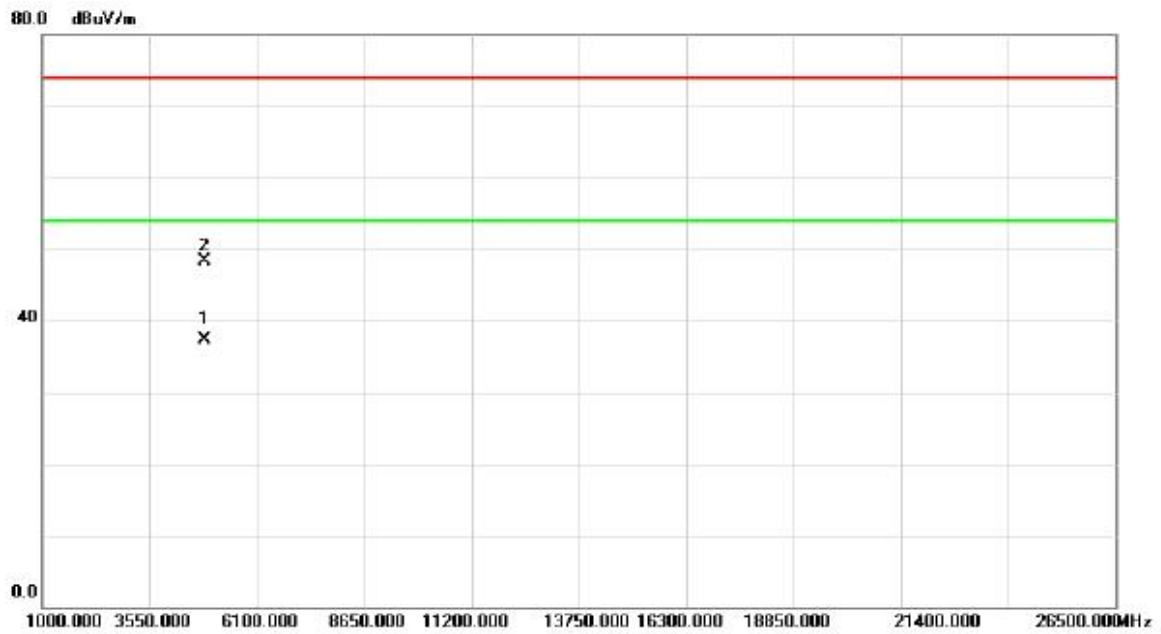

No.	Mk.	Freq. MHz	Reading Level dBuV	Correct Factor dB	Measure- ment dBuV/m	Limit dBuV/m	Margin dB	Detector	Comment
1	*	4874.000	33.66	3.72	37.38	54.00	-16.62	AVG	
2		4873.880	44.50	3.72	48.22	74.00	-25.78	peak	

Orthogonal Axis :	X
Test Mode :	TX N-20M MODE 2462MHz

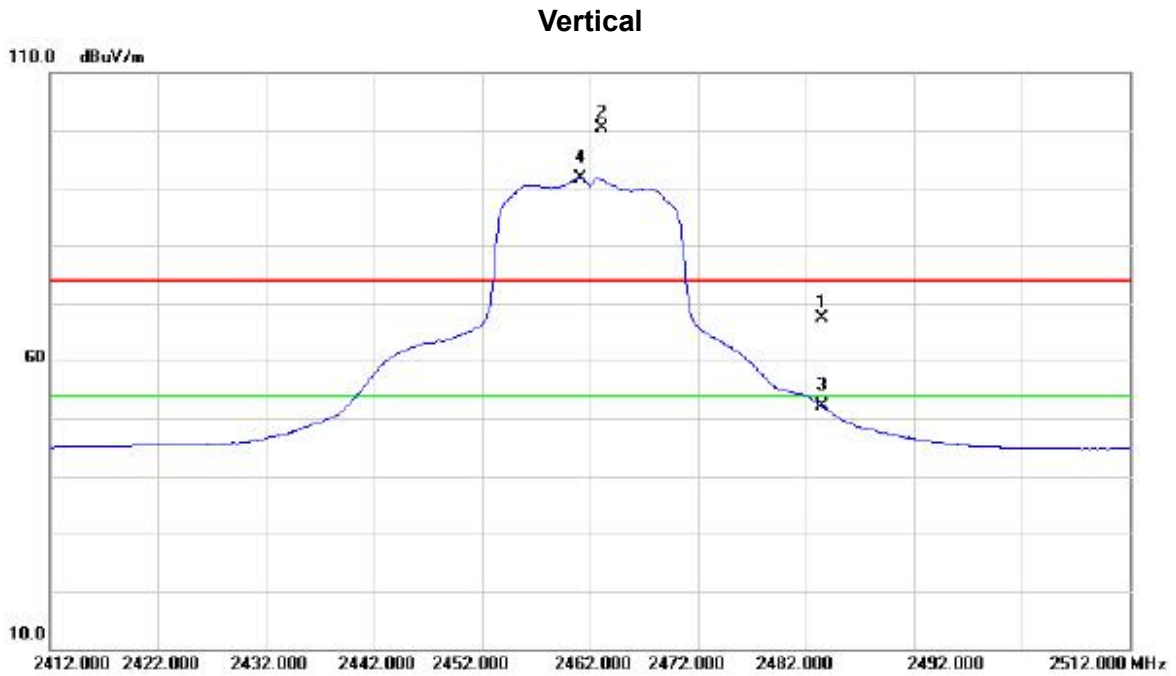

No.	Mk.	Freq. MHz	Reading Level dBuV	Correct Factor dB	Measure- ment dBuV/m	Limit dBuV/m	Margin dB	Detector	Comment
1		2483.500	38.30	28.99	67.29	74.00	-6.71	peak	
2	X	2463.100	71.40	28.97	100.37	74.00	26.37	peak	NO LIMIT
3		2483.500	23.15	28.99	52.14	54.00	-1.86	AVG	
4	*	2461.200	62.76	28.97	91.73	54.00	37.73	AVG	NO LIMIT

Orthogonal Axis :	X
Test Mode :	TX N-20M MODE 2462MHz

Vertical



No.	Mk.	Freq. MHz	Reading Level dBuV	Correct Factor dB	Measure- ment dBuV/m	Limit dBuV/m	Margin dB	Detector	Comment
1	*	4924.000	35.56	3.80	39.36	54.00	-14.64	AVG	
2		4924.040	43.92	3.80	47.72	74.00	-26.28	peak	

Orthogonal Axis :	X
Test Mode :	TX N-20M MODE 2462MHz

Horizontal

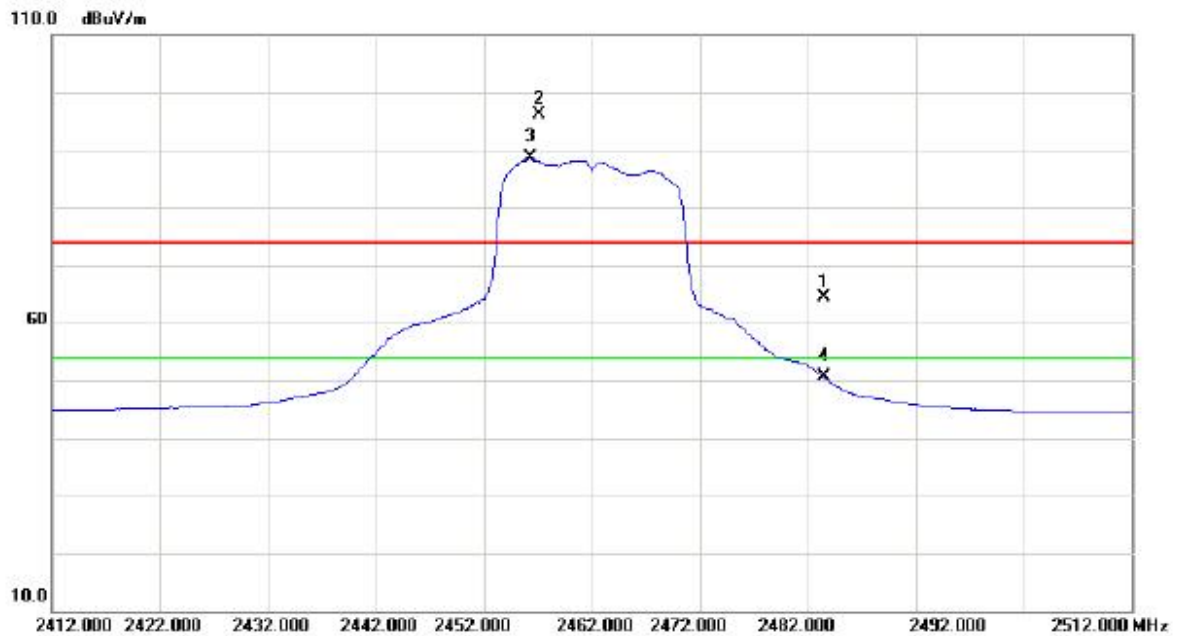

No.	Mk.	Freq. MHz	Reading Level dBuV	Correct Factor dB	Measure- ment dBuV/m	Limit dBuV/m	Margin dB	Detector	Comment
1		2483.500	35.45	28.99	64.44	74.00	-9.56	peak	
2	X	2457.100	67.22	28.97	96.19	74.00	22.19	peak	NO LIMIT
3	*	2456.300	59.57	28.97	88.54	54.00	34.54	AVG	NO LIMIT
4		2483.500	21.58	28.99	50.57	54.00	-3.43	AVG	

Orthogonal Axis :	X
Test Mode :	TX N-20M MODE 2462MHz

Horizontal



No.	Mk.	Freq. MHz	Reading Level dBuV	Correct Factor dB	Measure- ment dBuV/m	Limit dBuV/m	Margin dB	Detector	Comment
1	*	4924.060	31.67	3.80	35.47	54.00	-18.53	AVG	
2		4924.160	41.21	3.80	45.01	74.00	-28.99	peak	

For Dipole antenna

Orthogonal Axis :	X
Test Mode :	TX B MODE 2412MHz

Vertical

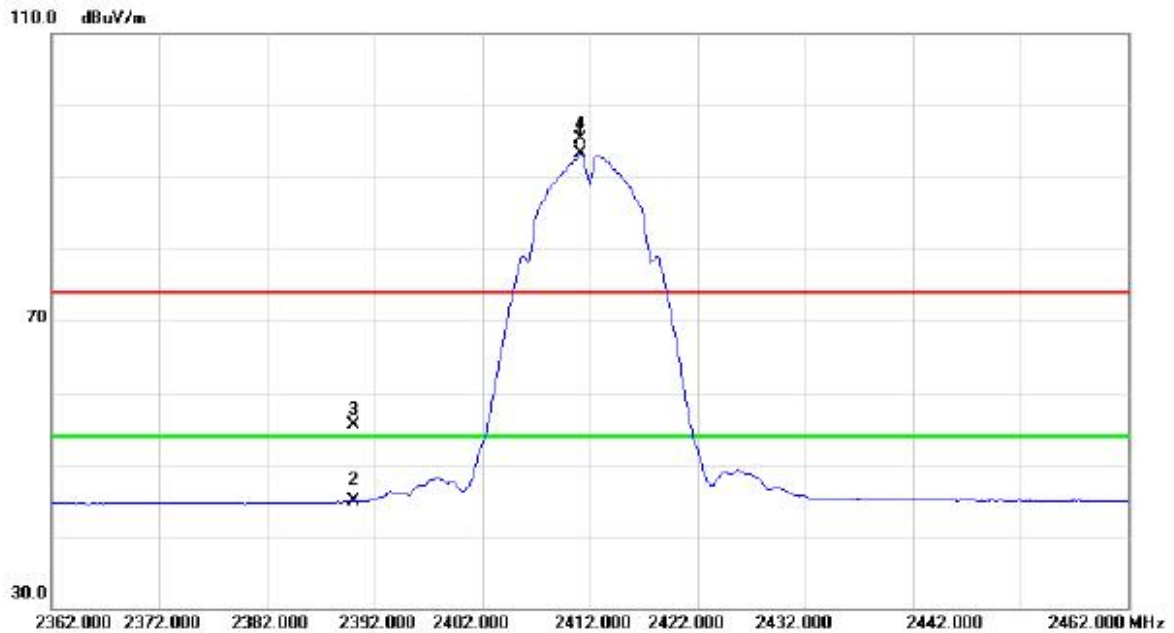

No.	Mk.	Freq. MHz	Reading Level dBuV	Correct Factor dB	Measure- ment dBuV/m	Limit dBuV/m	Margin dB	Detector	Comment
1	*	2411.200	60.52	32.71	93.23	54.00	39.23	AVG	NO LIMIT
2		2390.000	12.19	32.68	44.87	54.00	-9.13	AVG	
3		2390.000	22.77	32.68	55.45	74.00	-18.55	peak	
4	X	2411.200	62.56	32.71	95.27	74.00	21.27	peak	NO LIMIT

Orthogonal Axis :	X
Test Mode :	TX B MODE 2412MHz

Vertical



No.	Mk.	Freq. MHz	Reading Level dBuV	Correct Factor dB	Measure- ment dBuV/m	Limit dBuV/m	Over dB	Detector	Comment
1	*	4823.990	35.13	5.87	41.00	54.00	-13.00	AVG	
2		4823.950	42.87	5.87	48.74	74.00	-25.26	peak	

Orthogonal Axis :	X
Test Mode :	TX B MODE 2412MHz

Horizontal

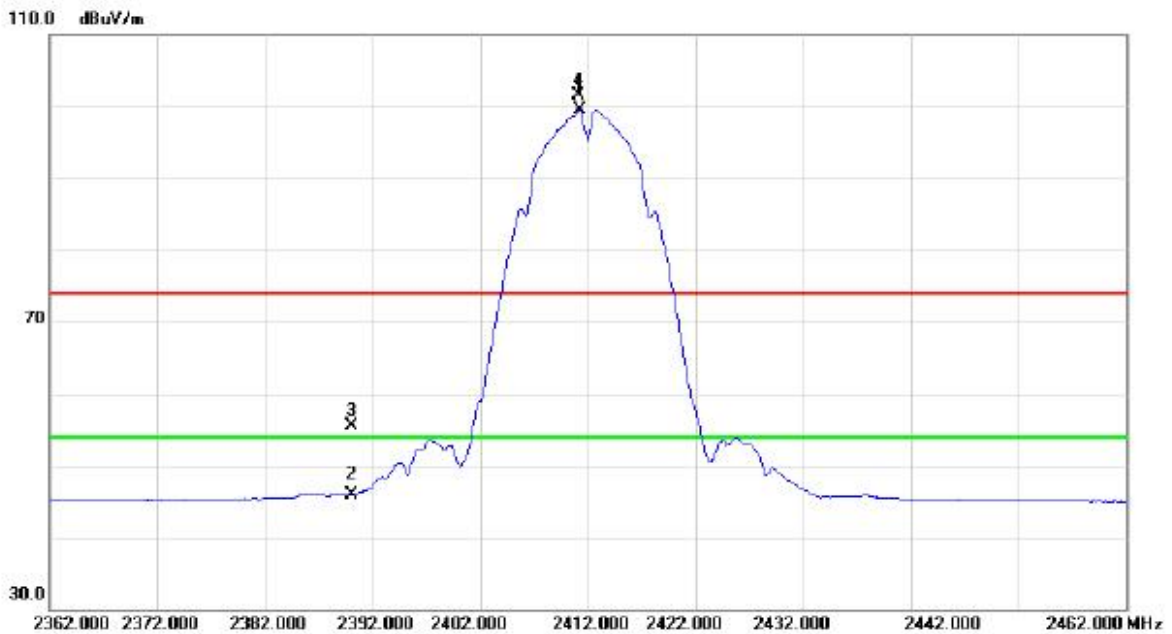

No.	Mk.	Freq. MHz	Reading Level dBuV	Correct Factor dB	Measure- ment dBuV/m	Limit dBuV/m	Margin dB	Detector	Comment
1	*	2411.300	66.79	32.71	99.50	54.00	45.50	AVG	NO LIMIT
2		2390.000	13.23	32.68	45.91	54.00	-8.09	AVG	
3		2390.000	22.87	32.68	55.55	74.00	-18.45	peak	
4	X	2411.200	68.89	32.71	101.60	74.00	27.60	peak	NO LIMIT

Orthogonal Axis :	X
Test Mode :	TX B MODE 2412MHz

Horizontal

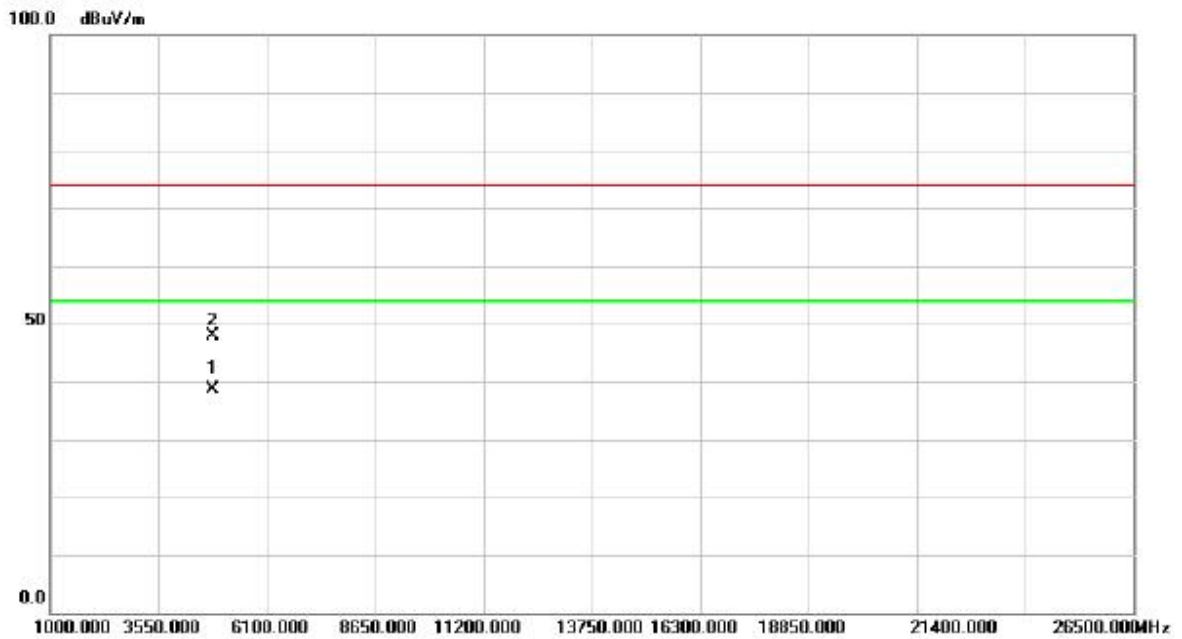

No.	Mk.	Freq. MHz	Reading Level dBuV	Correct Factor dB	Measure- ment dBuV/m	Limit dBuV/m	Over dB	Detector	Comment
1	*	4824.140	32.69	5.87	38.56	54.00	-15.44	AVG	
2		4823.990	42.04	5.87	47.91	74.00	-26.09	peak	

Orthogonal Axis :	X
Test Mode :	TX B MODE 2437MHz

Vertical

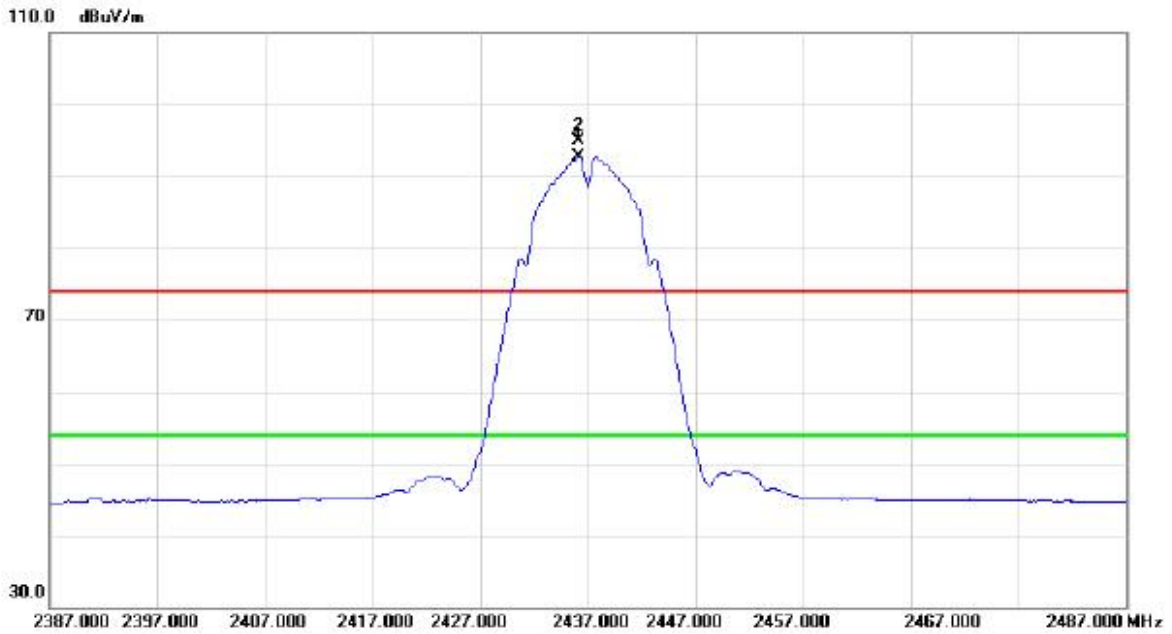

No.	Mk.	Freq. MHz	Reading Level dBuV	Correct Factor dB	Measure- ment dBuV/m	Limit dBuV/m	Margin dB	Detector	Comment
1	*	2436.200	60.05	32.74	92.79	54.00	38.79	AVG	NO LIMIT
2	X	2436.200	62.21	32.74	94.95	74.00	20.95	peak	NO LIMIT

Orthogonal Axis :	X
Test Mode :	TX B MODE 2437MHz

Vertical



No.	Mk.	Freq. MHz	Reading Level dBuV	Correct Factor dB	Measure- ment dBuV/m	Limit dBuV/m	Over dB	Detector	Comment
1	*	4874.020	33.18	6.01	39.19	54.00	-14.81	AVG	
2		4874.060	41.27	6.01	47.28	74.00	-26.72	peak	

Orthogonal Axis :	X
Test Mode :	TX B MODE 2437MHz

Horizontal

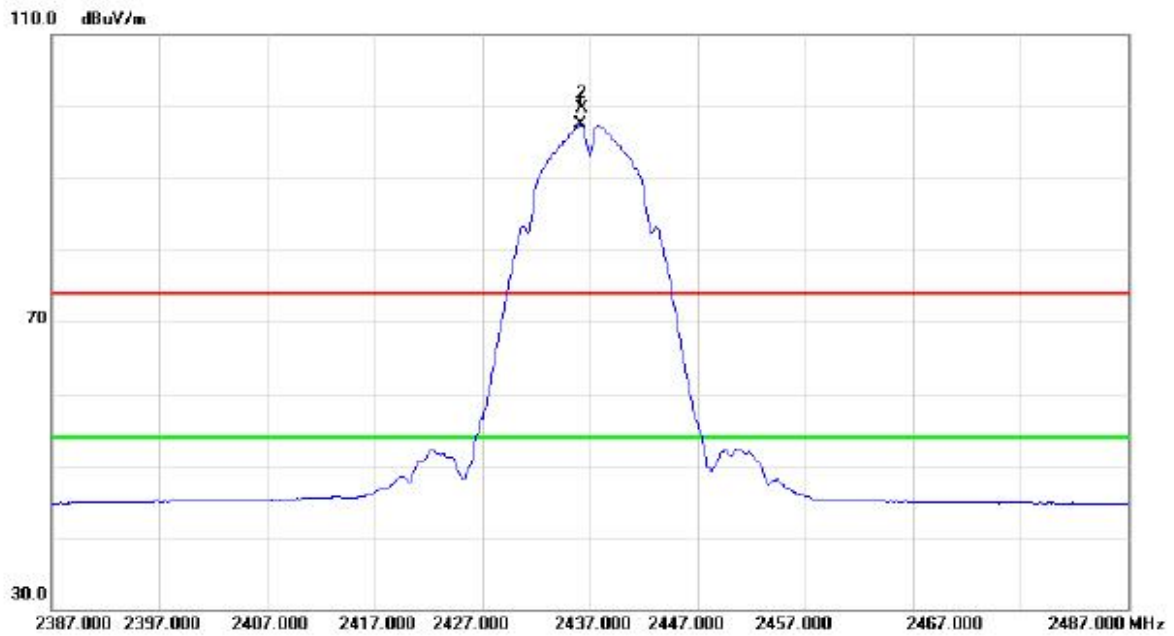

No.	Mk.	Freq. MHz	Reading Level dBuV	Correct Factor dB	Measure- ment dBuV/m	Limit dBuV/m	Margin dB	Detector	Comment
1	*	2436.200	64.70	32.74	97.44	54.00	43.44	AVG	NO LIMIT
2	X	2436.300	66.89	32.74	99.63	74.00	25.63	peak	NO LIMIT

Orthogonal Axis :	X
Test Mode :	TX B MODE 2437MHz

Horizontal



No.	Mk.	Freq. MHz	Reading Level dBuV	Correct Factor dB	Measure- ment dBuV/m	Limit dBuV/m	Over dB	Detector	Comment
1	*	4873.950	31.00	6.01	37.01	54.00	-16.99	AVG	
2		4876.920	39.85	6.01	45.86	74.00	-28.14	peak	

Orthogonal Axis :	X
Test Mode :	TX B MODE 2462MHz

Vertical

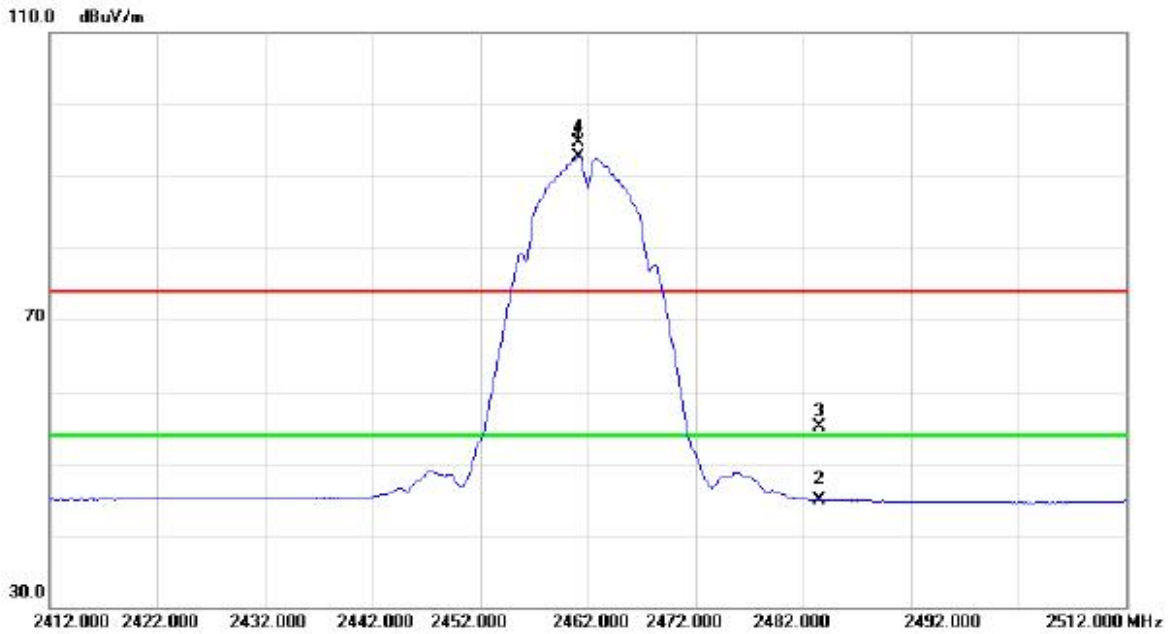

No.	Mk.	Freq. MHz	Reading Level dBuV	Correct Factor dB	Measure- ment dBuV/m	Limit dBuV/m	Margin dB	Detector	Comment
1	*	2461.200	60.00	32.78	92.78	54.00	38.78	AVG	NO LIMIT
2		2483.500	12.07	32.81	44.88	54.00	-9.12	AVG	
3		2483.500	22.34	32.81	55.15	74.00	-18.85	peak	
4	X	2461.200	62.02	32.78	94.80	74.00	20.80	peak	NO LIMIT

Orthogonal Axis :	X
Test Mode :	TX B MODE 2462MHz

Vertical

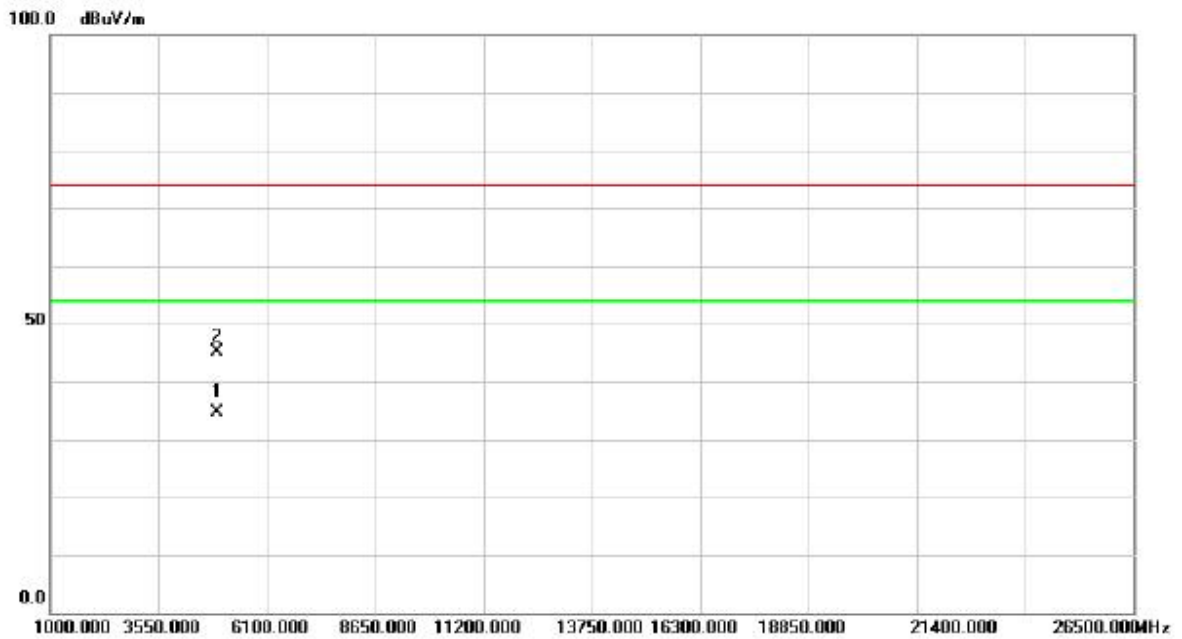

No.	Mk.	Freq. MHz	Reading Level dBuV	Correct Factor dB	Measure- ment dBuV/m	Limit dBuV/m	Over dB	Detector	Comment
1	*	4924.100	28.52	6.14	34.66	54.00	-19.34	AVG	
2		4924.200	38.89	6.14	45.03	74.00	-28.97	peak	

Orthogonal Axis :	X
Test Mode :	TX B MODE 2462MHz

Horizontal

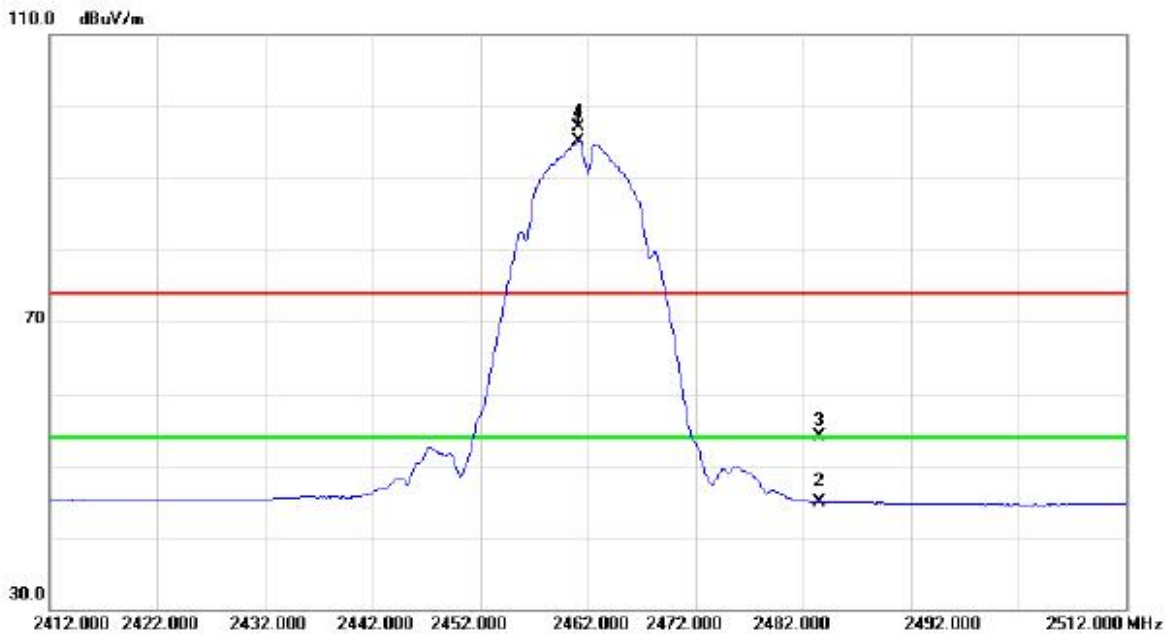

No.	Mk.	Freq. MHz	Reading Level dBuV	Correct Factor dB	Measure- ment dBuV/m	Limit dBuV/m	Margin dB	Detector	Comment
1	*	2461.200	62.39	32.78	95.17	54.00	41.17	AVG	NO LIMIT
2		2483.500	12.09	32.81	44.90	54.00	-9.10	AVG	
3		2483.500	21.24	32.81	54.05	74.00	-19.95	peak	
4	X	2461.200	64.25	32.78	97.03	74.00	23.03	peak	NO LIMIT

Orthogonal Axis :	X
Test Mode :	TX B MODE 2462MHz

Horizontal

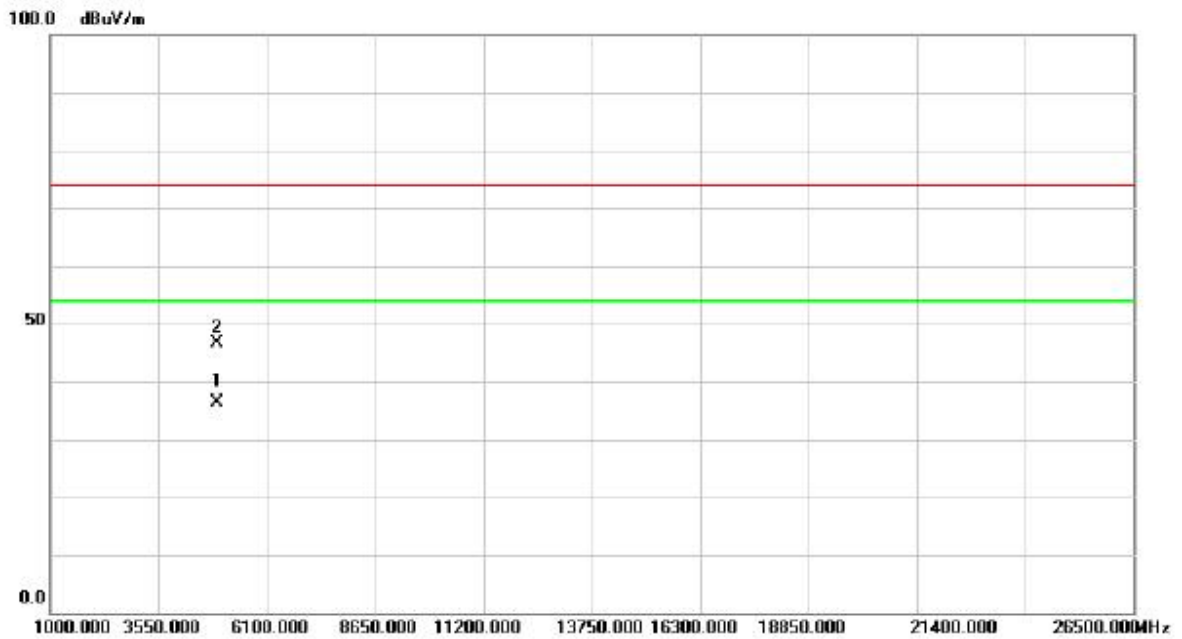

No.	Mk.	Freq. MHz	Reading Level dBuV	Correct Factor dB	Measure- ment dBuV/m	Limit dBuV/m	Over dB	Detector	Comment
1	*	4923.945	30.31	6.14	36.45	54.00	-17.55	AVG	
2		4924.200	40.40	6.14	46.54	74.00	-27.46	peak	