



Test Report No.: RF200520W003-3



# FCC TEST REPORT (PART 27)

Applicant:	Particle Industries, Inc
Address:	126 Post St, 4th floor, San Francisco, CA 94108 USA

Manufacturer or Supplier:	Particle Industries, Inc
Address:	126 Post St, 4th floor, San Francisco, CA 94108 USA
Product:	Tracker SoM LTE M1
Brand Name:	Particle
Model Name:	T402M/T404M
FCC ID:	2AEMI-T40X
Date of tests:	May. 21, 2020 ~ Jun. 09, 2020

The tests have been carried out according to the requirements of the following standard:

- FCC Part 27, Subpart C, L       ANSI/TIA/EIA-603- D
- FCC Part 2                               ANSI/TIA/EIA-603-E     ANSI C63.26-2015

CONCLUSION: The submitted sample was found to COMPLY with the test requirement

Prepared by Alex Chen Engineer / Mobile Department	Approved by Luke Lu Manager / Mobile Department
Date: Jun. 09, 2020	Date: Jun. 09, 2020

This report is governed by, and incorporates by reference, CPS Conditions of Service as posted at the date of issuance of this report at <http://www.bureauveritas.com/home/about-us/our-business/cps/about-us/terms-conditions> and is intended for your exclusive use. Any copying or replication of this report to or for any other person or entity, or use of our name or trademark, is permitted only with our prior written permission. This report sets forth our findings solely with respect to the test samples identified herein. The results set forth in this report are not indicative or representative of the quality or characteristics of the lot from which a test sample was taken or any similar or identical product unless specifically and expressly noted. Our report includes all of the tests requested by you and the results thereof based upon the information that you provided to us. Measurement uncertainty is only provided upon request for accredited tests. You have 60 days from date of issuance of this report to notify us of any material error or omission caused by our negligence or if you require measurement uncertainty; provided, however, that such notice shall be in writing and shall specifically address the issue you wish to raise. A failure to raise such issue within the prescribed time shall constitute your unqualified acceptance of the completeness of this report, the tests conducted and the correctness of the report contents.



# TABLE OF CONTENTS

**RELEASE CONTROL RECORD ..... 4**

**1 SUMMARY OF TEST RESULTS ..... 5**

1.1 MEASUREMENT UNCERTAINTY ..... 5

1.2 TEST SITE AND INSTRUMENTS ..... 6

**2 GENERAL INFORMATION..... 7**

2.1 GENERAL DESCRIPTION OF EUT ..... 7

2.2 CONFIGURATION OF SYSTEM UNDER TEST ..... 10

2.3 DESCRIPTION OF SUPPORT UNITS .....11

2.4 DESCRIPTION OF TEST MODES.....11

2.5 GENERAL DESCRIPTION OF APPLIED STANDARDS ..... 15

**3 TEST TYPES AND RESULTS ..... 16**

3.1 OUTPUT POWER MEASUREMENT ..... 16

3.1.1 LIMITS OF OUTPUT POWER MEASUREMENT ..... 16

3.1.2 TEST PROCEDURES ..... 16

3.1.3 TEST SETUP ..... 17

3.1.4 TEST RESULTS ..... 17

3.2 FREQUENCY STABILITY MEASUREMENT ..... 30

3.2.1 LIMITS OF FREQUENCY STABILIIY MEASUREMENT ..... 30

3.2.2 TEST PROCEDURE ..... 30

3.2.3 TEST SETUP ..... 30

3.2.4 TEST RESULTS ..... 31

3.3 OCCUPIED BANDWIDTH MEASUREMENT ..... 32

3.3.1 LIMITS OF OCCUPIED BANDWIDTH MEASUREMENT ..... 32

3.3.2 TEST SETUP ..... 32

3.3.3 TEST PROCEDURES ..... 32

3.3.4 TEST RESULTS ..... 32

3.4 PEAK TO AVERAGE RATIO ..... 33

3.4.1 LIMITS OF PEAK TO AVERAGE RATIO MEASUREMENT ..... 33

3.4.2 TEST SETUP ..... 33

3.4.3 TEST PROCEDURES ..... 33

3.4.4 TEST RESULTS ..... 33

3.5 BAND EDGE MEASUREMENT ..... 34

3.5.1 LIMITS OF BAND EDGE MEASUREMENT ..... 34

3.5.2 TEST SETUP ..... 34

3.5.3 TEST PROCEDURES ..... 35

3.5.4 TEST RESULTS ..... 35

3.6 CONDUCTED SPURIOUS EMISSIONS..... 36

3.6.1 LIMITS OF CONDUCTED SPURIOUS EMISSIONS MEASUREMENT ..... 36

3.6.2 TEST PROCEDURE ..... 36

3.6.3 TEST SETUP ..... 36

3.6.4 TEST RESULTS ..... 36

3.7 RADIATED EMISSION MEASUREMENT ..... 37

3.7.1 LIMITS OF RADIATED EMISSION MEASUREMENT ..... 37

3.7.2 TEST PROCEDURES ..... 37

3.7.3 DEVIATION FROM TEST STANDARD ..... 37

3.7.4 TEST SETUP ..... 38

3.7.5 TEST RESULTS ..... 39



**BUREAU  
VERITAS**

**Test Report No.: RF200520W003-3**

<b>4</b>	<b>INFORMATION ON THE TESTING LABORATORIES .....</b>	<b>77</b>
<b>5</b>	<b>APPENDIX A – MODIFICATIONS RECORDERS FOR ENGINEERING CHANGES TO THE EUT BY THE LAB .....</b>	<b>78</b>



Test Report No.: RF200520W003-3

## RELEASE CONTROL RECORD

ISSUE NO.	REASON FOR CHANGE	DATE ISSUED
RF200520W003-3	Original release	Jun. 09, 2020

## 1 SUMMARY OF TEST RESULTS

The EUT has been tested according to the following specifications:

APPLIED STANDARD: FCC Part 27 & Part 2		
STANDARD SECTION	TEST TYPE AND LIMIT	RESULT
2.1046 27.50(d)(4)	Maximum Peak Output Power	Compliance
2.1055 27.54	Frequency Stability	See Note
2.1049 27.53(h)	Occupied Bandwidth	See Note
27.50(d)(5)	Peak to average ratio	See Note
27.53(h)	Band Edge Measurements	See Note
2.1051 27.53(h)	Conducted Spurious Emissions	See Note
2.1053 27.53(h)	Radiated Spurious Emissions	Compliance

Note: Test data re-use from certified module BG96, BG96 MINIPCIE, more details please refer test report R1811A0536-R3 (FCC ID: XMR201707BG96).

### 1.1 MEASUREMENT UNCERTAINTY

Where relevant, the following measurement uncertainty levels have been estimated for tests performed on the EUT as specified in CISPR 16-4-2:

MEASUREMENT	UNCERTAINTY
Frequency Stability	$\pm 76.97\text{Hz}$
Radiated emissions & Radiated Power (30MHz~1GMHz)	$\pm 4.98\text{dB}$
Radiated emissions & Radiated Power (1GMHz ~6GMHz)	$\pm 4.70\text{dB}$
Radiated emissions (6GMHz ~18GMHz)	$\pm 4.60\text{dB}$
Radiated emissions (18GMHz ~40GMHz)	$\pm 4.12\text{dB}$
Conducted emissions	$\pm 4.01\text{dB}$
Occupied Channel Bandwidth	$\pm 43.58\text{KHz}$
Conducted Output power	$\pm 2.06\text{dB}$
Band Edge Measurements	$\pm 4.70\text{dB}$
Peak to average ratio	$\pm 0.76\text{dB}$

This uncertainty represents an expanded uncertainty expressed at approximately the 95% confidence level using a coverage factor of  $k=2$ .

## 1.2 TEST SITE AND INSTRUMENTS

Equipment	Manufacturer	Model No.	Serial No.	Last Cal.	Next Cal.
MXE EMI Receiver	KEYSIGHT	N9038A-544	MY54450026	Feb. 26,20	Feb. 25,21
EXA Signal Analyzer	KEYSIGHT	N9010A-544	MY54510355	Jun. 24,19	Jun. 23,20
Bilog Antenna	ETS-LINDGREN	3143B	00161965	Mar. 27,20	Mar. 26,21
Horn Antenna (1GHz-18GHz)	ETS-LINDGREN	3117	00168692	Mar. 27,20	Mar. 26,21
Horn Antenna (18GHz-40GHz)	N/A	QWH-SL-18-40 -K-SG/QMS-00 361	15433	Nov. 24,19	Nov. 23,20
Radio Communication Analyzer	ANRITSU	MT8820C	6201465426	Feb. 27,20	Feb. 26,21
Signal Pre-Amplifier	EMSI	EMC 9135	980249	Jun. 24,19	Jun. 23,20
Signal Pre-Amplifier	EMSI	EMC 012645B	980257	Jun. 24,19	Jun. 23,20
Signal Pre-Amplifier	EMSI	EMC 184045B	980259	Jun. 24,19	Jun. 23,20
3m Semi-anechoic Chamber	ETS-LINDGREN	9m*6m*6m	Euroshieldpn- CT0001143-1216	May. 18,20	May. 17,23
Test Software	E3	V 9.160323	N/A	N/A	N/A
Test Software	ADT	ADT_Radiated _V7.6.15.9.2	N/A	N/A	N/A
10dB Attenuator	JFW/USA	50HF-010-SM A	1505	Jun. 24,19	Jun. 23,20
Power Meter	Anritsu	ML2495A	1506002	Feb. 26,20	Feb. 25,21
Power Sensor	Anritsu	MA2411B	1339352	Feb. 26,20	Feb. 25,21
Humid & Temp Programmable Tester	Juyi	ITH-120-45-CP -AR	IAA1504-001	Jun. 24,19	Jun. 23,20
MXG Analog Microvave Signal Generator	KEYSIGHT	N5183A	MY50143024	Mar. 11,20	Mar. 10,21
Power Divider	MCLI/USA	PS2-15	24880	Nov. 22, 19	Nov. 21, 20

- NOTE:**
1. The calibration interval of the above test instruments is 12 months or 36 months and the calibrations are traceable to CEPREI/CHINA, GRGT/CHINA and NIM/CHINA.
  2. The test was performed in 3m Semi-anechoic Chamber and RF Oven Room.
  3. The horn antenna is used only for the measurement of emission frequency above 1GHz if tested.
  4. The FCC Site Registration No. is 525120; The Designation No. is CN1171.



**BUREAU  
VERITAS**

Test Report No.: RF200520W003-3

## 2 GENERAL INFORMATION

### 2.1 GENERAL DESCRIPTION OF EUT

<b>PRODUCT</b>	Tracker SoM LTE M1		
<b>BRAND NAME</b>	Particle		
<b>MODEL NAME</b>	T402M/T404M		
<b>POWER SUPPLY</b>	Li+ PIN: DC +3.3V--4.3V or Vusb PIN: DC +4.35V--5.5V or Vin PIN: DC +3.9V--17V		
<b>MODULATION TECHNOLOGY</b>	<b>LTE CAT-M1</b>	QPSK, 16QAM	
<b>FREQUENCY RANGE</b>	<b>LTE Band 4 Channel Bandwidth: 1.4MHz</b>	1710.7MHz ~ 1754.3MHz	
	<b>LTE Band 4 Channel Bandwidth: 3MHz</b>	1711.5MHz ~ 1753.5MHz	
	<b>LTE Band 4 Channel Bandwidth: 5MHz</b>	1712.5MHz ~ 1752.5MHz	
	<b>LTE Band 4 Channel Bandwidth: 10MHz</b>	1715.0MHz ~ 1750.0MHz	
	<b>LTE Band 4 Channel Bandwidth: 15MHz</b>	1717.5MHz ~ 1747.5MHz	
	<b>LTE Band 4 Channel Bandwidth: 20MHz</b>	1720.0MHz ~ 1745.0MHz	
	<b>LTE Band 12 Channel Bandwidth: 1.4MHz</b>	699.7MHz ~ 715.3MHz	
	<b>LTE Band 12 Channel Bandwidth: 3MHz</b>	700.5MHz ~ 714.5MHz	
	<b>LTE Band 12 Channel Bandwidth: 5MHz</b>	701.5MHz ~ 713.5MHz	
	<b>LTE Band 12 Channel Bandwidth: 10MHz</b>	704.0MHz ~ 711.0MHz	
	<b>LTE Band 13 Channel Bandwidth: 5MHz</b>	779.5MHz ~ 784.5MHz	
	<b>LTE Band 13 Channel Bandwidth: 10MHz</b>	782.0MHz	
	<b>EMISSION DESIGNATOR</b>	<b>LTE Band 4 Channel Bandwidth: 1.4MHz</b>	QPSK: 1M12G7D
			16QAM: 939KW7D
<b>LTE Band 4 Channel Bandwidth: 3MHz</b>		QPSK: 1M15G7D	
		16QAM: 981KW7D	
<b>LTE Band 4 Channel Bandwidth: 5MHz</b>		QPSK: 1M13G7D	
		16QAM: 1M02W7D	
<b>LTE Band 4 Channel Bandwidth: 10MHz</b>		QPSK: 1M18G7D	
		16QAM: 1M07W7D	
<b>EMISSION DESIGNATOR</b>	<b>LTE Band 4 Channel Bandwidth: 15MHz</b>	QPSK: 1M20G7D	
		16QAM: 1M06W7D	



**BUREAU  
VERITAS**

Test Report No.: RF200520W003-3

	LTE Band 4 Channel Bandwidth: 20MHz	QPSK: 1M21G7D 16QAM: 1M11W7D
	LTE Band 12 Channel Bandwidth: 1.4MHz	QPSK: 1M11G7D 16QAM: 939KW7D
	LTE Band 12 Channel Bandwidth: 3MHz	QPSK: 1M15G7D 16QAM: 985KW7D
	LTE Band 12 Channel Bandwidth: 5MHz	QPSK: 1M14G7D 16QAM: 976KW7D
	LTE Band 12 Channel Bandwidth: 10MHz	QPSK: 1M21G7D 16QAM: 1M08W7D
	LTE Band 13 Channel Bandwidth: 5MHz	QPSK: 1M15G7D 16QAM: 977KW7D
	LTE Band 13 Channel Bandwidth: 10MHz	QPSK: 1M18G7D 16QAM: 1M03W7D
<b>MAX. ERP/EIRP POWER</b>	LTE Band 4 Channel Bandwidth: 1.4MHz	412mW
	LTE Band 4 Channel Bandwidth: 3MHz	414mW
	LTE Band 4 Channel Bandwidth: 5MHz	411mW
	LTE Band 4 Channel Bandwidth: 10MHz	413mW
	LTE Band 4 Channel Bandwidth: 15MHz	412mW
	LTE Band 4 Channel Bandwidth: 20MHz	409mW
	LTE Band 12 Channel Bandwidth: 1.4MHz	184 mW
	LTE Band 12 Channel Bandwidth: 3MHz	185mW
	LTE Band 12 Channel Bandwidth: 5MHz	184mW
	LTE Band 12 Channel Bandwidth: 10MHz	183mW
	LTE Band 13 Channel Bandwidth: 5MHz	203mW
	LTE Band 13 Channel Bandwidth: 10MHz	198mW
<b>ANTENNA TYPE</b>	External Antenna with 3.77gain for LTE B4 External Antenna with 1.42gain for LTE LTE B12LTE B13	
<b>HW VERSION</b>	V1.0	
<b>SW VERSION</b>	V1.5.4	
<b>I/O PORTS</b>	Refer to user's manual	
<b>CABLE SUPPLIED</b>	N/A	





**BUREAU**  
**VERITAS**

**Test Report No.: RF200520W003-3**

**NOTE:**

1. For a more detailed features description, please refer to the manufacturer's specifications or the user's manual.
2. The schematic and PCB of the two models T402M and T404M used by our company for the certification is completely the same ,and the HW&SW used is the same. Because the product is sold in different market using different models eSIM, different models are named. the differences are as follows:T402M uses eSIM of Kore.T404M uses eSIM of Twilio.
3. For the test results, the EUT had been tested with all conditions. But only the worst case was shown in test report.

## 2.2 CONFIGURATION OF SYSTEM UNDER TEST

### FOR RADIATION EMISSION

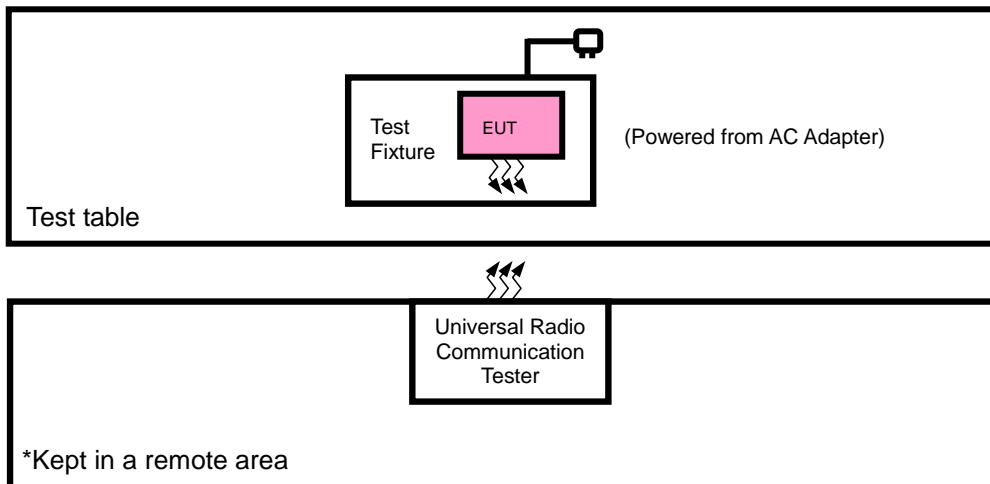



### 2.3 DESCRIPTION OF SUPPORT UNITS

The EUT has been tested as an independent unit together with other necessary accessories or support units. The following support units or accessories were used to form a representative test configuration during the tests.

NO.	PRODUCT	BRAND	MODEL NO.	SERIAL NO.	FCC ID
1	DC source	LONG WEI	PS-6403D	010934269	N/A

NO.	SIGNAL CABLE DESCRIPTION OF THE ABOVE SUPPORT UNITS
1	DC Line: Unshielded, Detachable 1.8m

**NOTE:**

- 1. All power cords of the above support units are non shielded (1.8m).

### 2.4 DESCRIPTION OF TEST MODES

Pre-Scan has been conducted to determine the worst-case mode from all possible combinations between available modulations, data rates, XYZ axis and antenna ports. The worst case in ERP/EIRP and radiated emission was found when positioned on X-plane for LTE. Following channel(s) was (were) selected for the final test as listed below:

EUT CONFIGURE MODE	DESCRIPTION
-	EUT + Adapter with LTE link
-	EUT + Battery with LTE link



Test Report No.: RF200520W003-3

#### LTE BAND 4

TEST ITEM	AVAILABLE CHANNEL	TESTED CHANNEL	CHANNEL BANDWIDTH	MODULATION	MODE
EIRP	19957 to 20393	19957, 20175, 20393	1.4MHz	QPSK, 16QAM	1 RB / 0 RB Offset
	19965 to 20385	19965, 20175, 20385	3MHz	QPSK, 16QAM	1 RB / 0 RB Offset
	19975 to 20375	19975, 20175, 20375	5MHz	QPSK, 16QAM	1 RB / 0 RB Offset
	20000 to 20350	20000, 20175, 20350	10MHz	QPSK, 16QAM	1 RB / 0 RB Offset
	20025 to 20325	20025, 20175, 20325	15MHz	QPSK, 16QAM	1 RB / 0 RB Offset
	20050 to 20300	20050, 20175, 20300	20MHz	QPSK, 16QAM	1 RB / 0 RB Offset
RADIATED EMISSION	19957 to 20393	20175	1.4MHz	QPSK	1 RB / 0 RB Offset
	19965 to 20385	19965, 20175, 20385	3MHz	QPSK	1 RB / 0 RB Offset
	19975 to 20375	20175	5MHz	QPSK	1 RB / 0 RB Offset
	20000 to 20350	20175,	10MHz	QPSK	1 RB / 0 RB Offset
	20025 to 20325	20175	15MHz	QPSK	1 RB / 0 RB Offset
	20050 to 20300	20175	20MHz	QPSK	1 RB / 0 RB Offset

**Note:** This device was tested under all bandwidths, RB configurations and modulations. The worst case was found in QPSK modulation.



BUREAU  
VERITAS

Test Report No.: RF200520W003-3

LTE Band 12

TEST ITEM	AVAILABLE CHANNEL	TESTED CHANNEL	CHANNEL BANDWIDTH	MODULATION	MODE
EIRP	23017 to 23173	23017, 23095, 23173	1.4MHz	QPSK, 16QAM	1 RB / 0 RB Offset
	23025 to 23165	23025, 23095, 23165	3MHz	QPSK, 16QAM	1 RB / 0 RB Offset
	23035 to 23155	23035, 23095, 23155	5MHz	QPSK, 16QAM	1 RB / 0 RB Offset
	23060 to 23130	23060, 23095, 23130	10MHz	QPSK, 16QAM	1 RB / 0 RB Offset
RADIATED EMISSION	23017 to 23173	23095	1.4MHz	QPSK	1 RB / 0 RB Offset
	23025 to 23165	23095	3MHz	QPSK	1 RB / 0 RB Offset
	23035 to 23155	23035, 23095, 23155	5MHz	QPSK	1 RB / 0 RB Offset
	23060 to 23130	23095	10MHz	QPSK	1 RB / 0 RB Offset

**Note:** This device was tested under all bandwidths, RB configurations and modulations. The worst case was found in QPSK modulation.



BUREAU  
VERITAS

Test Report No.: RF200520W003-3

**LTE Band 13**

TEST ITEM	AVAILABLE CHANNEL	TESTED CHANNEL	CHANNEL BANDWIDTH	MODULATION	MODE
EIRP	23205 to 23255	23205, 23230, 23255	5MHz	QPSK, 16QAM	1 RB / 0 RB Offset
	23230	23230	10MHz	QPSK, 16QAM	1 RB / 0 RB Offset
RADIATED EMISSION	23205 to 23255	23205, 23230, 23255	5MHz	QPSK	1 RB / 0 RB Offset
	23230	23230	10MHz	QPSK	1 RB / 0 RB Offset

**Note:** This device was tested under all bandwidths, RB configurations and modulations. The worst case was found in QPSK modulation.

**TEST CONDITION:**

TEST ITEM	ENVIRONMENTAL CONDITIONS	INPUT POWER	TESTED BY
EIRP	23deg. C, 70%RH	DC 5V	Tony Xiong
RADIATED EMISSION	23deg. C, 70%RH	DC 5V	Tony Xiong



Test Report No.: RF200520W003-3

## 2.5 GENERAL DESCRIPTION OF APPLIED STANDARDS

The EUT is a RF product. According to the specifications of the manufacturer, it must comply with the requirements of the following standards:

**FCC 47 CFR Part 2**

**FCC 47 CFR Part 27**

**KDB 971168 D01 Power Meas License Digital Systems v03r01**

**ANSI/TIA/EIA-603-D**

**ANSI/TIA/EIA-603-E**

**ANSI C63.26-2015**

**NOTE:** All test items have been performed and recorded as per the above standards.



### 3 TEST TYPES AND RESULTS

#### 3.1 OUTPUT POWER MEASUREMENT

##### 3.1.1 LIMITS OF OUTPUT POWER MEASUREMENT

Fixed, mobile, and portable (hand-held) stations operating in the 1710–1755 MHz band are limited to 1 watt EIRP.

27.50(b)(10) Portable stations (hand-held devices) transmitting in the 746-757 MHz, 776-788 MHz, and 805-806 MHz bands are limited to 3 watts ERP.

27.50(c)(10) Portable stations (hand-held devices) in the 600 MHz uplink band and the 698-746 MHz band, and fixed and mobile stations in the 600 MHz uplink band are limited to 3 watts ERP.

##### 3.1.2 TEST PROCEDURES

###### **EIRP / ERP MEASUREMENT:**

Per KDB 971168 D01 Power Meas License Digital Systems v03r01 or subclause 5.2.5.5 of ANSI C63.26-2015, the relevant equation for determining the ERP or EIRP from the conducted RF output power measured using the guidance provided above is:

$$\text{ERP or EIRP} = P_{\text{Meas}} + G_{\text{T}} - L_{\text{c}}$$

Where:

ERP or EIRP = effective radiated power or equivalent isotropically radiated power, respectively

(expressed in the same units as  $P_{\text{Meas}}$ , typically dBW or dBm);

$P_{\text{Meas}}$  = measured transmitter output power or PSD, in dBm or dBW;

$G_{\text{T}}$  = gain of the transmitting antenna, in dBd (ERP) or dBi (EIRP);

$L_{\text{c}}$  = signal attenuation in the connecting cable between the transmitter and antenna, in dB.

###### **CONDUCTED POWER MEASUREMENT:**

- a. The EUT was set up for the maximum power with LTE link data modulation and link up with simulator.
- b. Set the EUT to transmit under low, middle and high channel and record the power level shown on simulator.



### 3.1.3 TEST SETUP

#### EIRP MEASUREMENT:

#### CONDUCTED POWER MEASUREMENT:

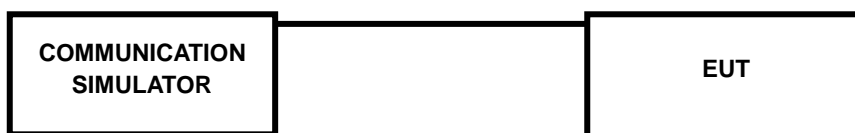

### 3.1.4 TEST RESULTS

#### AVERAGE CONDUCTED OUTPUT POWER (dBm)

#### LTE Band 4

Band/BW	Modulation	RB Size	RB Offset	Low CH 19957	Mid CH 20175	High CH 20393	Tune Up
				Frequency 1710.7 MHz	Frequency 1732.5 MHz	Frequency 1754.3 MHz	
4/ 1.4	QPSK	1	0	22.68	22.76	22.66	23.0
		1	5	22.52	22.66	22.64	
		3	0	22.77	22.66	22.70	23.0
		3	3	22.63	22.70	22.68	
		6	0	22.66	22.66	22.63	23.0
	16QAM	1	0	22.20	22.29	22.26	23.0
		1	5	22.24	22.31	22.27	
		3	0	22.49	22.48	22.56	23.0
		3	3	22.46	22.25	22.45	
		6	0	22.66	22.69	22.64	23.0

Band/BW	Modulation	RB Size	RB Offset	Low CH 19965	Mid CH 20175	High CH 20385	Tune Up
				Frequency 1711.5 MHz	Frequency 1732.5 MHz	Frequency 1753.5 MHz	
4/ 3	QPSK	1	0	22.70	22.78	22.65	23.0
		1	5	22.48	22.67	22.64	
		3	0	22.73	22.66	22.70	23.0
		3	3	22.62	22.73	22.68	
		6	0	22.59	22.66	22.65	23.0
	16QAM	1	0	22.17	22.35	22.29	23.0
		1	5	22.21	22.34	22.25	
		3	0	22.52	22.48	22.56	23.0
		3	3	22.42	22.26	22.45	
		6	0	22.71	22.64	22.67	23.0
Band/BW	Modulation	RB Size	RB Offset	Low CH 19975	Mid CH 20175	High CH 20375	Tune Up
				Frequency 1712.5 MHz	Frequency 1732.5 MHz	Frequency 1752.5 MHz	
4/ 5	QPSK	1	0	22.71	22.73	22.66	23.0
		1	5	22.53	22.64	22.64	
		3	0	22.74	22.65	22.74	23.0
		3	3	22.65	22.73	22.65	
		6	0	22.59	22.67	22.66	23.0
	16QAM	1	0	22.18	22.31	22.29	23.0
		1	5	22.18	22.37	22.24	
		3	0	22.52	22.48	22.55	23.0
		3	3	22.42	22.24	22.42	
		6	0	22.68	22.68	22.63	23.0

Band/BW	Modulation	RB Size	RB Offset	Low CH 20000	Mid CH 20175	High CH 20350	Tune Up
				Frequency 1715 MHz	Frequency 1732.5 MHz	Frequency 1750 MHz	
4/ 10	QPSK	1	0	22.68	22.76	22.66	23.0
		1	5	22.53	22.64	22.65	
		3	0	22.71	22.69	22.70	23.0
		3	3	22.66	22.72	22.68	
		6	0	22.65	22.61	22.66	23.0
	16QAM	1	0	22.18	22.28	22.25	23.0
		1	5	22.23	22.33	22.27	
		3	0	22.52	22.49	22.52	23.0
		3	3	22.44	22.22	22.48	
		6	0	22.72	22.62	22.68	23.0
Band/BW	Modulation	RB Size	RB Offset	Low CH 20025	Mid CH 20175	High CH 20325	Tune Up
				Frequency 1717.5 MHz	Frequency 1732.5 MHz	Frequency 1747.5 MHz	
4/ 15	QPSK	1	0	22.75	22.76	22.63	23.0
		1	5	22.51	22.69	22.60	
		3	0	22.77	22.72	22.71	23.0
		3	3	22.63	22.73	22.69	
		6	0	22.66	22.66	22.66	23.0
	16QAM	1	0	22.22	22.35	22.25	23.0
		1	5	22.22	22.34	22.27	
		3	0	22.48	22.54	22.54	23.0
		3	3	22.48	22.22	22.49	
		6	0	22.66	22.66	22.64	23.0



Test Report No.: RF200520W003-3

Band/BW	Modulation	RB Size	RB Offset	Low CH 20050	Mid CH 20175	High CH 20300	Tune Up
				Frequency 1720 MHz	Frequency 1732.5 MHz	Frequency 1745 MHz	
4/ 20	QPSK	1	0	22.76	<b>22.80</b>	22.71	23.0
		1	5	22.55	22.72	22.66	
		3	0	22.79	22.73	22.75	23.0
		3	3	22.69	22.78	22.70	
		6	0	22.67	22.68	22.71	23.0
	16QAM	1	0	22.25	22.36	22.31	23.0
		1	5	22.26	22.39	22.29	
		3	0	22.54	22.56	22.57	23.0
		3	3	22.50	22.30	22.50	
		6	0	22.74	22.70	22.69	23.0



**BUREAU  
VERITAS**

**Test Report No.: RF200520W003-3**

**LTE Band 12**

Band/BW	Modulation	RB Size	RB Offset	Low CH 23017	Mid CH 23095	High CH 23173	Tune Up
				Frequency 699.7 MHz	Frequency 707.5 MHz	Frequency 715.3 MHz	
12/ 1.4	QPSK	1	0	22.72	22.77	22.73	23.0
		1	5	22.65	22.63	22.64	
		3	0	22.71	22.67	22.66	23.0
		3	3	22.71	22.70	22.73	
		6	0	22.71	22.71	22.62	23.0
	16QAM	1	0	22.23	22.22	22.21	23.0
		1	5	22.30	22.25	22.28	
		3	0	22.59	22.57	22.61	23.0
		3	3	22.62	22.62	22.59	
		6	0	22.64	22.72	22.65	23.0
Band/BW	Modulation	RB Size	RB Offset	Low CH 23025	Mid CH 23095	High CH 23165	Tune Up
				Frequency 700.5 MHz	Frequency 707.5 MHz	Frequency 714.5 MHz	
12/ 3	QPSK	1	0	22.74	22.79	22.72	23.0
		1	5	22.61	22.64	22.64	
		3	0	22.67	22.67	22.66	23.0
		3	3	22.70	22.73	22.73	
		6	0	22.64	22.71	22.64	23.0
	16QAM	1	0	22.20	22.28	22.24	23.0
		1	5	22.27	22.28	22.26	
		3	0	22.62	22.57	22.61	23.0
		3	3	22.58	22.63	22.59	
		6	0	22.69	22.67	22.68	23.0

Band/BW	Modulation	RB Size	RB Offset	Low CH 23035	Mid CH 23095	High CH 23155	Tune Up
				Frequency 701.5 MHz	Frequency 707.5 MHz	Frequency 713.5 MHz	
12/ 5	QPSK	1	0	22.75	22.74	22.73	23.0
		1	5	22.66	22.61	22.64	
		3	0	22.68	22.66	22.70	23.0
		3	3	22.73	22.73	22.70	
		6	0	22.64	22.72	22.65	23.0
	16QAM	1	0	22.21	22.24	22.24	23.0
		1	5	22.24	22.31	22.25	
		3	0	22.62	22.57	22.60	23.0
		3	3	22.58	22.61	22.56	
		6	0	22.66	22.71	22.64	23.0
Band/BW	Modulation	RB Size	RB Offset	Low CH 23060	Mid CH 23095	High CH 23130	Tune Up
				Frequency 704 MHz	Frequency 707.5 MHz	Frequency 711 MHz	
12/ 10	QPSK	1	0	22.80	<b>22.81</b>	22.78	23.0
		1	5	22.68	22.69	22.66	
		3	0	22.73	22.74	22.71	23.0
		3	3	22.77	22.78	22.75	
		6	0	22.72	22.73	22.70	23.0
	16QAM	1	0	22.28	22.29	22.26	23.0
		1	5	22.32	22.33	22.30	
		3	0	22.64	22.65	22.62	23.0
		3	3	22.66	22.67	22.64	
		6	0	22.72	22.73	22.70	23.0



**BUREAU  
VERITAS**

Test Report No.: RF200520W003-3

**LTE Band 13**

Band/BW	Modulation	RB Size	RB Offset	Low CH 23205	Mid CH 23230	High CH 23255	Tune Up
				Frequency 779.5 MHz	Frequency 782.0 MHz	Frequency 784.5 MHz	
13/ 5	QPSK	1	0	22.38	22.36	22.38	23.0
		1	5	22.46	22.40	22.46	
		3	0	22.48	22.45	22.52	23.0
		3	3	22.40	22.39	22.39	
		6	0	22.38	22.45	22.41	23.0
	16QAM	1	0	22.00	22.02	22.05	23.0
		1	5	21.97	22.03	22.00	
		3	0	22.28	22.22	22.28	23.0
		3	3	22.12	22.14	22.12	
		6	0	22.31	22.35	22.31	23.0
Band/BW	Modulation	RB Size	RB Offset	-	Mid CH 23230	-	Tune Up
				-	Frequency 782.0 MHz		
13/ 10	QPSK	1	0	-	22.43	-	23.0
		1	5	-	22.48	-	
		3	0	-	<b>22.53</b>	-	23.0
		3	3	-	22.44	-	
		6	0	-	22.46	-	23.0
	16QAM	1	0	-	22.07	-	23.0
		1	5	-	22.05	-	
		3	0	-	22.30	-	23.0
		3	3	-	22.20	-	
		6	0	-	22.37	-	23.0

**EIRP**

**LTE BAND 4**

**CHANNEL BANDWIDTH: 1.4MHz QPSK**

Channel	Frequency (MHz)	Conducted Power (dBm)	G <sub>T</sub> -L <sub>C</sub> (dB)	EIRP (dBm)	EIRP (mW)	Limit (W)
19957	1710.7	22.38	3.77	26.15	<b>412.10</b>	1
20175	1732.5	22.31	3.77	26.08	405.51	1
20393	1754.3	22.37	3.77	26.14	411.15	1

**CHANNEL BANDWIDTH: 1.4MHz 16QAM**

Channel	Frequency (MHz)	Conducted Power (dBm)	G <sub>T</sub> -L <sub>C</sub> (dB)	EIRP (dBm)	EIRP (mW)	Limit (W)
19957	1710.7	22.06	3.77	25.83	382.82	1
20175	1732.5	22.03	3.77	25.80	380.19	1
20393	1754.3	22.21	3.77	25.98	396.28	1

**CHANNEL BANDWIDTH: 3MHz QPSK**

Channel	Frequency (MHz)	Conducted Power (dBm)	G <sub>T</sub> -L <sub>C</sub> (dB)	EIRP (dBm)	EIRP (mW)	Limit (W)
19965	1711.5	22.40	3.77	26.17	<b>414.00</b>	1
20175	1732.5	22.35	3.77	26.12	409.26	1
20385	1753.5	22.40	3.77	26.17	414.00	1

**CHANNEL BANDWIDTH: 3MHz 16QAM**

Channel	Frequency (MHz)	Conducted Power (dBm)	G <sub>T</sub> -L <sub>C</sub> (dB)	EIRP (dBm)	EIRP (mW)	Limit (W)
19965	1711.5	22.09	3.77	25.86	385.48	1
20175	1732.5	22.07	3.77	25.84	383.71	1
20385	1753.5	22.24	3.77	26.01	399.02	1





BUREAU  
VERITAS

Test Report No.: RF200520W003-3

**CHANNEL BANDWIDTH: 5MHz QPSK**

Channel	Frequency (MHz)	Conducted Power (dBm)	G <sub>T</sub> -L <sub>c</sub> (dB)	EIRP (dBm)	EIRP (mW)	Limit (W)
19975	1712.5	22.37	3.77	26.14	<b>411.15</b>	1
20175	1732.5	22.33	3.77	26.10	407.38	1
20375	1752.5	22.36	3.77	26.13	410.20	1

**CHANNEL BANDWIDTH: 5MHz 16QAM**

Channel	Frequency (MHz)	Conducted Power (dBm)	G <sub>T</sub> -L <sub>c</sub> (dB)	EIRP (dBm)	EIRP (mW)	Limit (W)
19975	1712.5	22.07	3.77	25.84	383.71	1
20175	1732.5	22.03	3.77	25.80	380.19	1
20375	1752.5	22.19	3.77	25.96	394.46	1

**CHANNEL BANDWIDTH: 10MHz QPSK**

Channel	Frequency (MHz)	Conducted Power (dBm)	G <sub>T</sub> -L <sub>c</sub> (dB)	EIRP (dBm)	EIRP (mW)	Limit (W)
18650	1715.0	22.39	3.77	26.16	<b>413.05</b>	1
18900	1732.5	22.34	3.77	26.11	408.32	1
19150	1750.0	22.39	3.77	26.16	413.05	1

**CHANNEL BANDWIDTH: 10MHz 16QAM**

Channel	Frequency (MHz)	Conducted Power (dBm)	G <sub>T</sub> -L <sub>c</sub> (dB)	EIRP (dBm)	EIRP (mW)	Limit (W)
20000	1715.0	22.10	3.77	25.87	386.37	1
20175	1732.5	22.08	3.77	25.85	384.59	1
20350	1750.0	22.23	3.77	26.00	398.11	1



BUREAU  
VERITAS

Test Report No.: RF200520W003-3

**CHANNEL BANDWIDTH: 15MHz QPSK**

Channel	Frequency (MHz)	Conducted Power (dBm)	G <sub>T</sub> -L <sub>c</sub> (dB)	EIRP (dBm)	EIRP (mW)	Limit (W)
20025	1717.5	22.38	3.77	26.15	<b>412.10</b>	1
20175	1732.5	22.30	3.77	26.07	404.58	1
20325	1747.5	22.37	3.77	26.14	411.15	1

**CHANNEL BANDWIDTH: 15MHz 16QAM**

Channel	Frequency (MHz)	Conducted Power (dBm)	G <sub>T</sub> -L <sub>c</sub> (dB)	EIRP (dBm)	EIRP (mW)	Limit (W)
20025	1717.5	22.07	3.77	25.84	383.71	1
20175	1732.5	22.03	3.77	25.80	380.19	1
20325	1747.5	22.19	3.77	25.96	394.46	1

**CHANNEL BANDWIDTH: 20MHz QPSK**

Channel	Frequency (MHz)	Conducted Power (dBm)	G <sub>T</sub> -L <sub>c</sub> (dB)	EIRP (dBm)	EIRP (mW)	Limit (W)
20050	1720.0	22.35	3.77	26.12	<b>409.26</b>	1
20175	1732.5	22.26	3.77	26.03	400.87	1
20300	1745.0	22.34	3.77	26.11	408.32	1

**CHANNEL BANDWIDTH: 20MHz 16QAM**

Channel	Frequency (MHz)	Conducted Power (dBm)	G <sub>T</sub> -L <sub>c</sub> (dB)	EIRP (dBm)	EIRP (mW)	Limit (W)
20050	1720.0	22.05	3.77	25.82	381.94	1
20175	1732.5	21.99	3.77	25.76	376.70	1
20300	1745.0	22.16	3.77	25.93	391.74	1

- REMARKS:** 1. EIRP Output Power (dBm) = SPA LVL (dBm) + Correction Factor (dB).  
 2. Correction factor (dB) = Free Space Loss + Antenna Factor + Cable Loss



BUREAU  
VERITAS

Test Report No.: RF200520W003-3

### LTE Band 12

#### CHANNEL BANDWIDTH: 1.4MHz QPSK

Channel	Frequency (MHz)	Conducted Power (dBm)	G <sub>T</sub> -L <sub>c</sub> (dB)	EIRP (dBm)	EIRP (mW)	Limit (W)
23017	699.7	22.74	1.42	22.01	158.85	3
23095	707.5	23.12	1.42	22.39	173.38	3
23173	715.3	23.37	1.42	22.64	<b>183.65</b>	3

#### CHANNEL BANDWIDTH: 1.4MHz 16QAM

Channel	Frequency (MHz)	Conducted Power (dBm)	G <sub>T</sub> -L <sub>c</sub> (dB)	EIRP (dBm)	EIRP (mW)	Limit (W)
23017	699.7	23.23	1.42	22.50	177.83	3
23095	707.5	22.90	1.42	22.17	164.82	3
23173	715.3	23.02	1.42	22.29	169.43	3

#### CHANNEL BANDWIDTH: 3MHz QPSK

Channel	Frequency (MHz)	Conducted Power (dBm)	G <sub>T</sub> -L <sub>c</sub> (dB)	EIRP (dBm)	EIRP (mW)	Limit (W)
23025	700.5	22.76	1.42	22.03	159.59	3
23095	707.5	23.13	1.42	22.40	173.78	3
23165	714.5	23.40	1.42	22.67	<b>184.93</b>	3

#### CHANNEL BANDWIDTH: 3MHz 16QAM

Channel	Frequency (MHz)	Conducted Power (dBm)	G <sub>T</sub> -L <sub>c</sub> (dB)	EIRP (dBm)	EIRP (mW)	Limit (W)
23025	700.5	23.25	1.42	22.52	178.65	3
23095	707.5	22.95	1.42	22.22	166.72	3
23165	714.5	23.04	1.42	22.31	170.22	3



BUREAU  
VERITAS

Test Report No.: RF200520W003-3

**CHANNEL BANDWIDTH: 5MHz QPSK**

Channel	Frequency (MHz)	Conducted Power (dBm)	G <sub>T</sub> -L <sub>C</sub> (dB)	EIRP (dBm)	EIRP (mW)	Limit (W)
23035	701.5	22.75	1.42	22.02	159.22	3
23095	707.5	23.09	1.42	22.36	172.19	3
23155	713.5	23.38	1.42	22.65	<b>184.08</b>	3

**CHANNEL BANDWIDTH: 5MHz 16QAM**

Channel	Frequency (MHz)	Conducted Power (dBm)	G <sub>T</sub> -L <sub>C</sub> (dB)	EIRP (dBm)	EIRP (mW)	Limit (W)
23035	701.5	23.20	1.42	22.47	176.6	3
23095	707.5	22.90	1.42	22.17	164.82	3
23155	713.5	23.02	1.42	22.29	169.43	3

**CHANNEL BANDWIDTH: 10MHz QPSK**

Channel	Frequency (MHz)	Conducted Power (dBm)	G <sub>T</sub> -L <sub>C</sub> (dB)	EIRP (dBm)	EIRP (mW)	Limit (W)
23060	704.0	22.72	1.42	21.99	158.12	3
23095	707.5	23.05	1.42	22.32	170.61	3
23130	711.0	23.35	1.42	22.62	<b>182.81</b>	3

**CHANNEL BANDWIDTH: 10MHz 16QAM**

Channel	Frequency (MHz)	Conducted Power (dBm)	G <sub>T</sub> -L <sub>C</sub> (dB)	EIRP (dBm)	EIRP (mW)	Limit (W)
23060	704.0	23.18	1.42	22.45	175.79	3
23095	707.5	22.86	1.42	22.13	163.31	3
23130	711.0	22.97	1.42	22.24	167.49	3



BUREAU  
VERITAS

Test Report No.: RF200520W003-3

**LTE Band 13**

**CHANNEL BANDWIDTH: 5MHz QPSK**

Channel	Frequency (MHz)	Conducted Power (dBm)	G <sub>T</sub> -L <sub>c</sub> (dB)	EIRP (dBm)	EIRP (mW)	Limit (W)
23205	779.5	23.10	1.42	22.37	172.58	3
23230	782.0	23.32	1.42	22.59	181.55	3
23255	784.5	23.11	1.42	22.38	172.98	3

**CHANNEL BANDWIDTH: 5MHz 16QAM**

Channel	Frequency (MHz)	Conducted Power (dBm)	G <sub>T</sub> -L <sub>c</sub> (dB)	EIRP (dBm)	EIRP (mW)	Limit (W)
23205	779.5	23.81	1.42	23.08	<b>203.24</b>	3
23230	782.0	23.14	1.42	22.41	174.18	3
23255	784.5	23.72	1.42	22.99	199.07	3

**CHANNEL BANDWIDTH: 10MHz QPSK**

Channel	Frequency (MHz)	Conducted Power (dBm)	G <sub>T</sub> -L <sub>c</sub> (dB)	EIRP (dBm)	EIRP (mW)	Limit (W)
23230	782.0	23.07	1.42	22.34	171.4	3

**CHANNEL BANDWIDTH: 10MHz 16QAM**

Channel	Frequency (MHz)	Conducted Power (dBm)	G <sub>T</sub> -L <sub>c</sub> (dB)	EIRP (dBm)	EIRP (mW)	Limit (W)
23230	782.0	23.70	1.42	22.97	198.15	3

### 3.2 FREQUENCY STABILITY MEASUREMENT

#### 3.2.1 LIMITS OF FREQUENCY STABILITY MEASUREMENT

The frequency stability shall be sufficient to ensure that the fundamental emissions stay within the authorized bands of operation.

#### 3.2.2 TEST PROCEDURE

- a. Device is placed at the oven room. The oven room could control the temperatures and humidity. Power warm up is at least 15 min and power applied should perform before recording frequency error.
- b. EUT is connected the external power supply to control the DC input power. The test voltage range is from minimum to maximum working voltage. Each step shall be record the frequency error rate.
- c. The temperature range step is 10 degrees in this test items. All temperature levels shall be hold the  $\pm 0.5^{\circ}\text{C}$  during the measurement testing. The each temperature step shall be at least 0.5 hours, consider the EUT could be test under the stability condition.

**NOTE:** The frequency error was recorded frequency error from the communication simulator.

#### 3.2.3 TEST SETUP

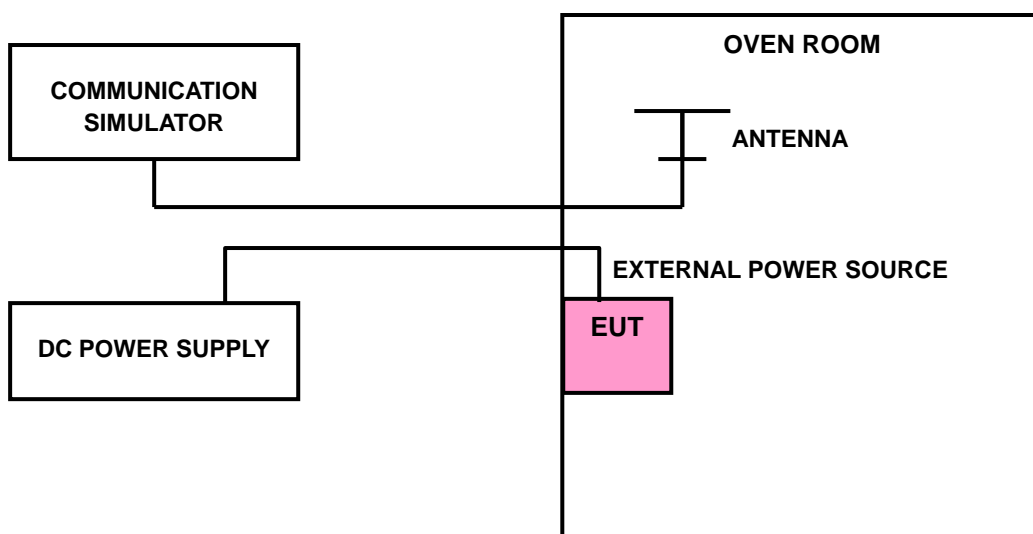



Test Report No.: RF200520W003-3

### 3.2.4 TEST RESULTS

The test results was recorded in Report No.: R1811A0536-R3(FCC ID: XMR201707BG96).

### 3.3 OCCUPIED BANDWIDTH MEASUREMENT

#### 3.3.1 LIMITS OF OCCUPIED BANDWIDTH MEASUREMENT

The width of a frequency band such that, below the lower and above the upper frequency limits, the mean powers emitted are each equal to a specified percentage 0.5 %of the total mean power of a given emission.

#### 3.3.2 TEST SETUP

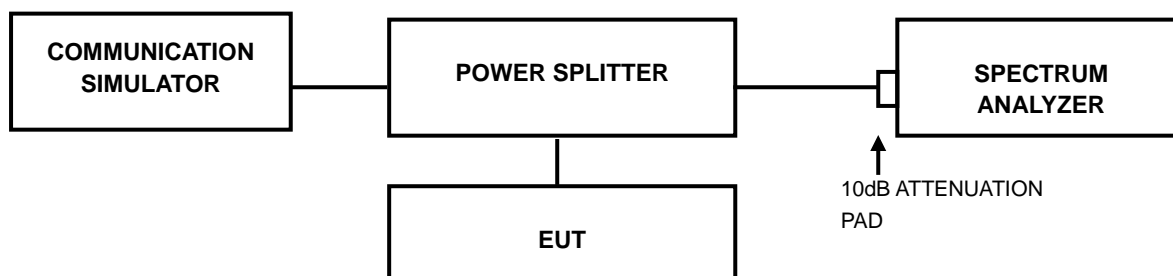

#### 3.3.3 TEST PROCEDURES

- The conducted occupied bandwidth used the power splitter via EUT RF power connector between simulation base station and spectrum analyzer.
- Use OBW measurement function of Spectrum analyzer to measure 99 % occupied bandwidth.

#### 3.3.4 TEST RESULTS

The test results was recorded in Report No.: R1811A0536-R3(FCC ID: XMR201707BG96).



### 3.4 PEAK TO AVERAGE RATIO

#### 3.4.1 LIMITS OF PEAK TO AVERAGE RATIO MEASUREMENT

In measuring transmissions in this band using an average power technique, the peak to-average ratio (PAR) of the transmission may not exceed 13 dB

#### 3.4.2 TEST SETUP

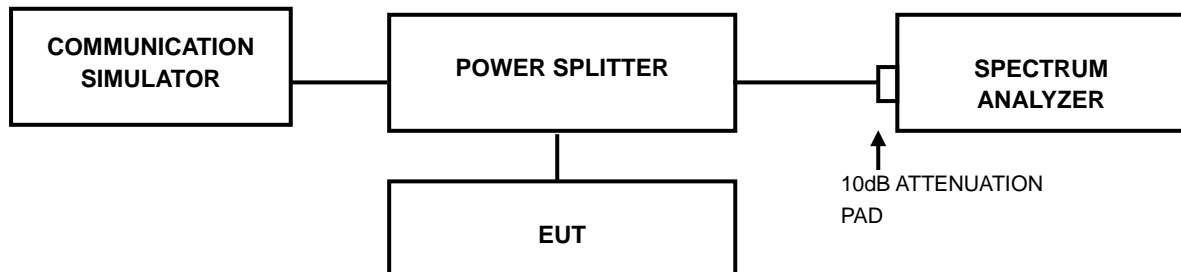

#### 3.4.3 TEST PROCEDURES

1. Set resolution/measurement bandwidth  $\geq$  signal's occupied bandwidth;
2. Set the number of counts to a value that stabilizes the measured CCDF curve;
3. Record the maximum PAPR level associated with a probability of 0.1%.

#### 3.4.4 TEST RESULTS

The test results was recorded in Report No.: R1811A0536-R3(FCC ID: XMR201707BG96).

### 3.5 BAND EDGE MEASUREMENT

#### 3.5.1 LIMITS OF BAND EDGE MEASUREMENT

The power of any emission outside a licensee's frequency band(s) of operation shall be attenuated below the transmitter power (P) within the licensed band(s) of operation, measured in watts, by at least  $43 + 10 \log (P)$  dB. Compliance with this provision is based on the use of measurement instrumentation employing a resolution bandwidth of 100 kilohertz or greater.

However, in the 100 kilohertz bands immediately outside and adjacent to a licensee's frequency block, a resolution bandwidth of at least 30 kHz may be employed.

#### 3.5.2 TEST SETUP

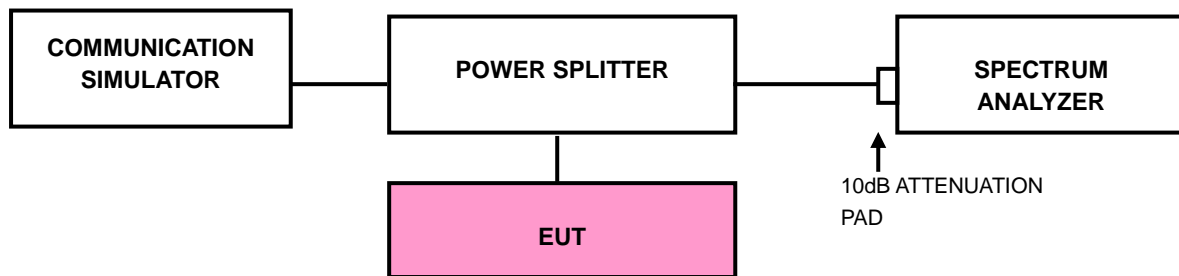



### 3.5.3 TEST PROCEDURES

- a. The EUT was set up for the maximum peak power with LTE link data modulation. The power was measured with R&S Spectrum Analyzer. All measurements were done at 2 channels (low and high operational frequency range.).
- b. The band edge measurement used the power splitter via EUT RF power connector between simulation base station and spectrum analyzer.
- c. The center frequency of spectrum is the band edge frequency and span is 1~5 MHz. RBW of the spectrum is 30kHz and VBW of the spectrum is 100 kHz. (LTE bandwidth 1.4MHz)
- d. The center frequency of spectrum is the band edge frequency and span is 1~5 MHz. RBW of the spectrum is 30kHz and VBW of the spectrum is 100kHz. (LTE bandwidth 3MHz)
- e. The center frequency of spectrum is the band edge frequency and span is 1~5 MHz. RBW of the spectrum is 50kHz and VBW of the spectrum is 200kHz. (LTE bandwidth 5MHz)
- f. The center frequency of spectrum is the band edge frequency and span is 1~5 MHz. RBW of the spectrum is 100kHz and VBW of the spectrum is 300kHz. (LTE bandwidth 10MHz)
- g. The center frequency of spectrum is the band edge frequency and span is 1~5 MHz. RBW of the spectrum is 200kHz and VBW of the spectrum is 1MHz. (LTE bandwidth 15MHz)
- h. The center frequency of spectrum is the band edge frequency and span is 1~5 MHz. RBW of the spectrum is 200kHz and VBW of the spectrum is 1MHz. (LTE bandwidth 20MHz)
- i. Record the max trace plot into the test report.

### 3.5.4 TEST RESULTS

The test results was recorded in Report No.: R1811A0536-R3(FCC ID: XMR201707BG96).

### 3.6 CONDUCTED SPURIOUS EMISSIONS

#### 3.6.1 LIMITS OF CONDUCTED SPURIOUS EMISSIONS MEASUREMENT

The power of any emission outside a licensee's frequency block shall be attenuated below the transmitter power (P) by at least  $43 + 10 \log_{10}(P)$  dB. The limit of emission equal to  $-13\text{dBm}$

#### 3.6.2 TEST PROCEDURE

- a. The EUT makes a phone call to the communication simulator. All measurements were done at middle operational frequency range.
- b. Measuring frequency range is from 30 MHz to 19.1GHz for WCDMA Band 4 & LTE Band 4. 10dB attenuation pad is connected with spectrum. RBW=1MHz and VBW=3MHz are used for conducted emission measurement.

#### 3.6.3 TEST SETUP

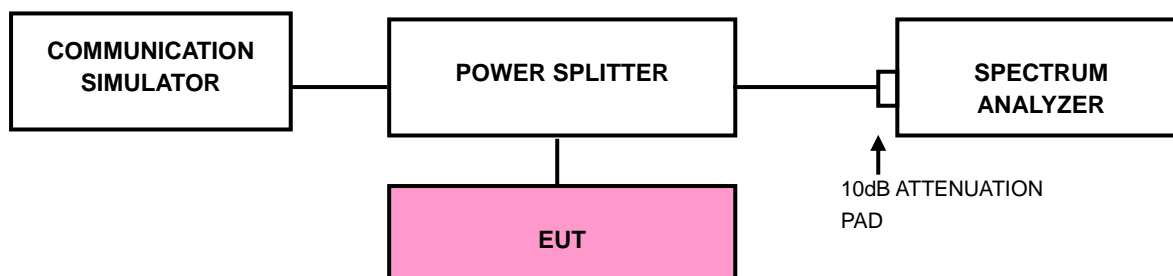

#### 3.6.4 TEST RESULTS

The test results was recorded in Report No.: R1811A0536-R3(FCC ID: XMR201707BG96).



### 3.7 RADIATED EMISSION MEASUREMENT

#### 3.7.1 LIMITS OF RADIATED EMISSION MEASUREMENT

The power of any emission outside a licensee's frequency block shall be attenuated below the transmitter power (P) by at least  $43 + 10 \log_{10}(P)$  dB. The limit of emission equal to  $-13\text{dBm}$

#### 3.7.2 TEST PROCEDURES

- a. Substitution method is used for E.I.R.P measurement. In the semi-anechoic chamber, EUT placed on the 0.8m height of Turn Table, rotated the table around 360 degrees to search the maximum radiation power and receiver antenna shall be rotated vertical and horizontal polarization and moved height from 1m to 4m to find the maximum polar radiated power. The "Read Value" is the spectrum reading the maximum power value.
- b. The substitution horn antenna is substituted for EUT at the same position and signals generator export the CW signal to the substitution antenna via a TX cable. Rotated the Turn Table and moved receiving antenna to find the maximum radiation power. Adjust output power level of S.G to get a Value of spectrum reading equal to "Read Value" of step a. Record the power level of S.G
- c.  $\text{EIRP} = \text{Output power level of S.G} - \text{TX cable loss} + \text{Antenna gain of substitution horn.}$
- d. E.R.P power can be calculated form E.I.R.P power by subtracting the gain of dipole,  $\text{E.R.P power} = \text{E.I.P.R power} - 2.15\text{dBi.}$

**NOTE:** The resolution bandwidth of spectrum analyzer is 1 MHz and the video bandwidth is 3 MHz.

#### 3.7.3 DEVIATION FROM TEST STANDARD

No deviation

### 3.7.4 TEST SETUP

#### < Frequency Range 30MHz~1GHz >

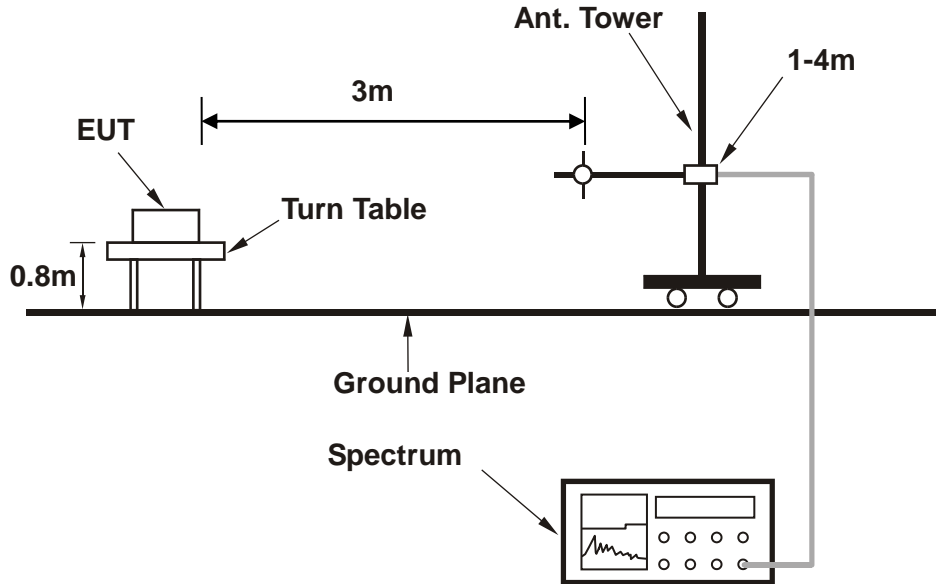

#### <Frequency Range above 1GHz>

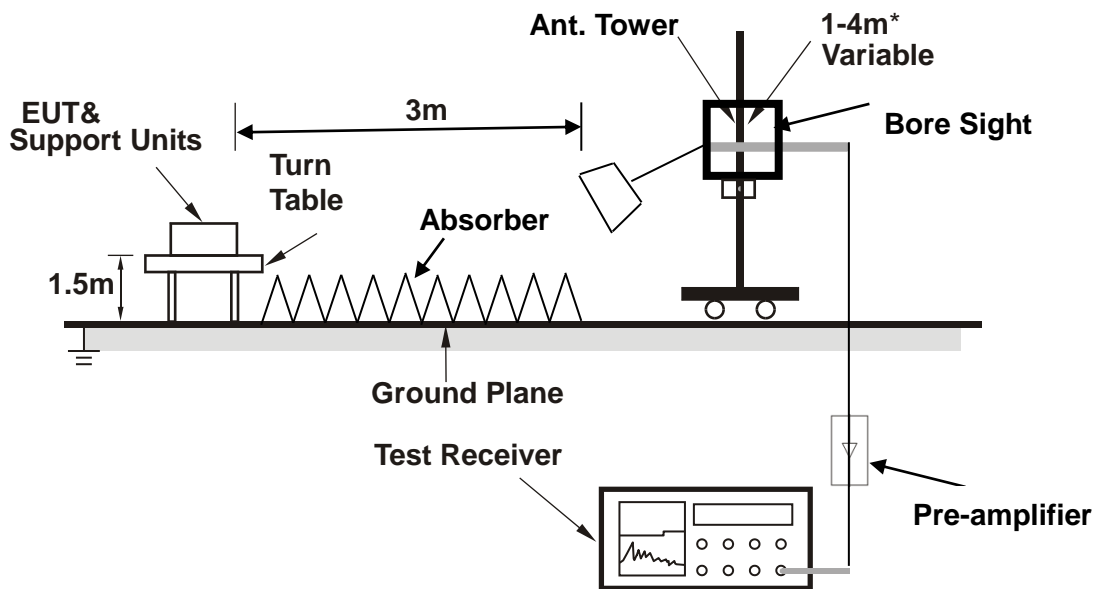

**Note:** Above 1G is a directional antenna

Depends on the EUT height and the antenna 3dB beamwidth both, refer to section 7.3 of CISPR 16-2-3.

For the actual test configuration, please refer to the attached file (Test Setup Photo).



### 3.7.5 TEST RESULTS

#### BELOW 1GHz WORST-CASE DATA FROM ANT 0

30 MHz – 1GHz data:

LTE Band 12

CHANNEL BANDWIDTH: 10MHz / QPSK

<b>MODE</b>	TX channel 23095	<b>FREQUENCY RANGE</b>	Below 1000MHz
<b>ENVIRONMENTAL CONDITIONS</b>	23deg. C, 70%RH	<b>INPUT POWER</b>	DC 5V
<b>TESTED BY</b>	Tony Xiong		
<b>ANTENNA POLARITY &amp; TEST DISTANCE: HORIZONTAL AT 3 M</b>			

	Freq	Level	Read Level	Limit Line	Over Limit	Factor	Remark	Pol/Phase	
	MHz	dBm/m	dBm	dBm/m	dB	dB/m			
1	PP	32.540	-38.50	-55.17	-13.00	-25.50	16.67	Peak	Horizontal
2		88.140	-46.78	-39.26	-13.00	-33.78	-7.52	Peak	Horizontal
3		178.260	-57.76	-41.64	-13.00	-44.76	-16.12	Peak	Horizontal
4		276.360	-62.50	-49.65	-13.00	-49.50	-12.85	Peak	Horizontal
5		312.690	-55.90	-44.78	-13.00	-42.90	-11.12	Peak	Horizontal
6		422.410	-67.61	-59.87	-13.00	-54.61	-7.74	Peak	Horizontal

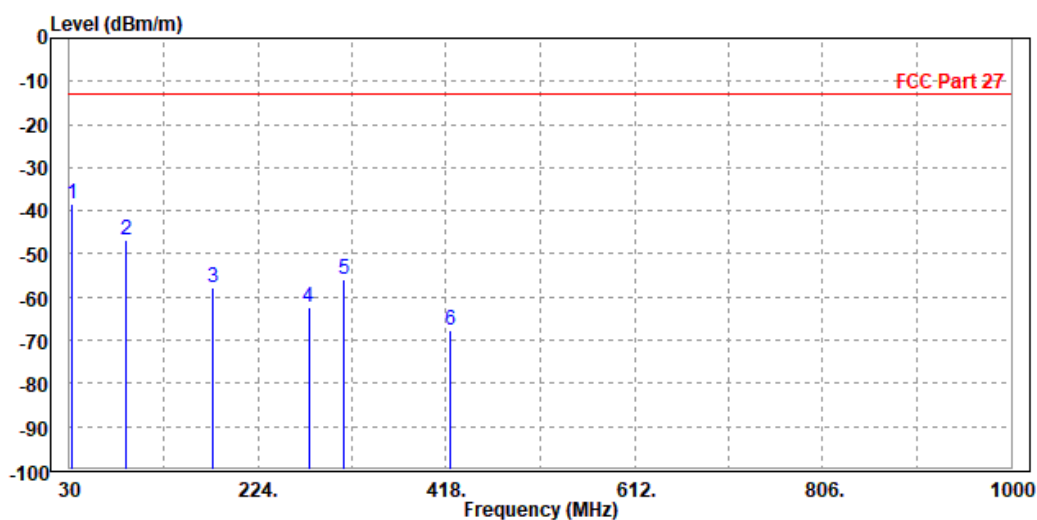



Test Report No.: RF200520W003-3

<b>MODE</b>	TX channel 23095	<b>FREQUENCY RANGE</b>	Below 1000MHz
<b>ENVIRONMENTAL CONDITIONS</b>	23deg. C, 70%RH	<b>INPUT POWER</b>	DC 5V
<b>TESTED BY</b>	Tony Xiong		
<b>ANTENNA POLARITY &amp; TEST DISTANCE: VERTICAL AT 3 M</b>			

	Freq	Level	Read Level	Limit Line	Over Limit	Factor	Remark	Pol/Phase
	MHz	dBm/m	dBm	dBm/m	dB	dB/m		
1	31.640	-46.22	-50.17	-13.00	-33.22	3.95	Peak	Vertical
2	48.140	-44.79	-41.65	-13.00	-31.79	-3.14	Peak	Vertical
3 PP	69.210	-44.71	-30.58	-13.00	-31.71	-14.13	Peak	Vertical
4	88.250	-49.90	-40.68	-13.00	-36.90	-9.22	Peak	Vertical
5	173.360	-53.75	-41.57	-13.00	-40.75	-12.18	Peak	Vertical
6	282.160	-53.92	-44.70	-13.00	-40.92	-9.22	Peak	Vertical

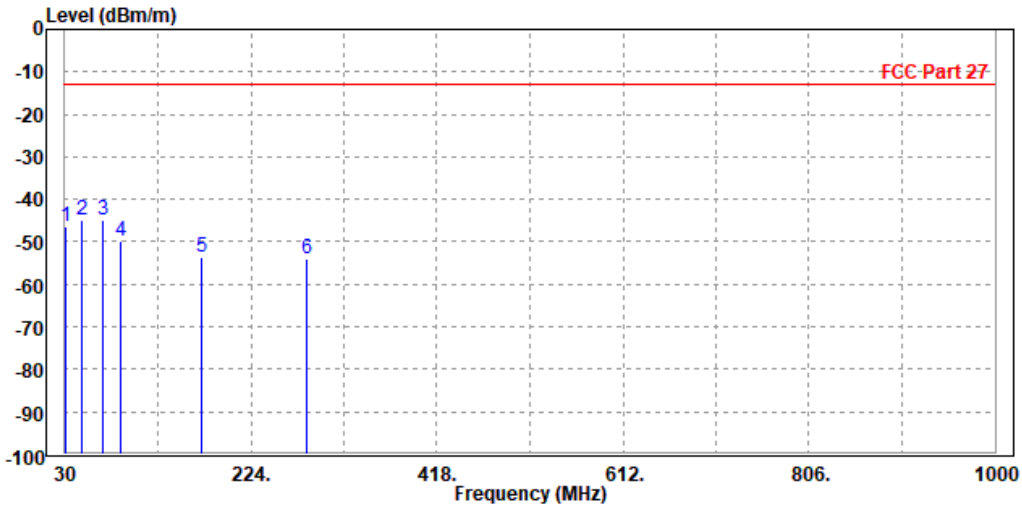





Test Report No.: RF200520W003-3

**ABOVE 1GHz**

**Note:** For higher frequency, the emission is too low to be detected.

**WORST-CASE DATA**

**LTE BAND 4**

**CHANNEL BANDWIDTH: 1.4MHz / QPSK**

<b>MODE</b>	TX channel 20175	<b>FREQUENCY RANGE</b>	Above 1000MHz
<b>ENVIRONMENTAL CONDITIONS</b>	23deg. C, 70%RH	<b>INPUT POWER</b>	DC 5V
<b>TESTED BY</b>	Tony Xiong		
<b>ANTENNA POLARITY &amp; TEST DISTANCE: HORIZONTAL AT 3 M</b>			

	Freq	Level	Read Level	Limit Line	Over Limit	Factor	Remark	Pol/Phase
	MHz	dBm/m	dBm	dBm/m	dB	dB/m		
1	PP 3470.000	-29.41	-37.99	-13.00	-16.41	8.58	Peak	Horizontal
2	5197.500	-36.82	-45.94	-13.00	-23.82	9.12	Peak	Horizontal

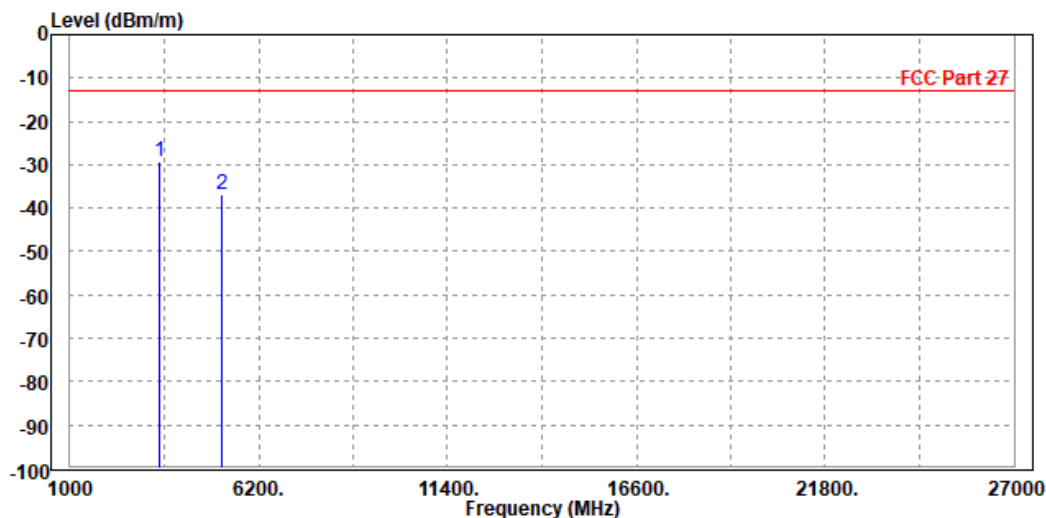



Test Report No.: RF200520W003-3

<b>MODE</b>	TX channel 20175	<b>FREQUENCY RANGE</b>	Above 1000MHz
<b>ENVIRONMENTAL CONDITIONS</b>	23deg. C, 70%RH	<b>INPUT POWER</b>	DC 5V
<b>TESTED BY</b>	Tony Xiong		
<b>ANTENNA POLARITY &amp; TEST DISTANCE: VERTICAL AT 3 M</b>			

	Freq	Level	Read Level	Limit Line	Over Limit	Factor	Remark	Pol/Phase
	MHz	dBm/m	dBm	dBm/m	dB	dB/m		
1	PP 3470.000	-32.96	-42.12	-13.00	-19.96	9.16	Peak	Vertical
2	5197.500	-33.18	-43.00	-13.00	-20.18	9.82	Peak	Vertical

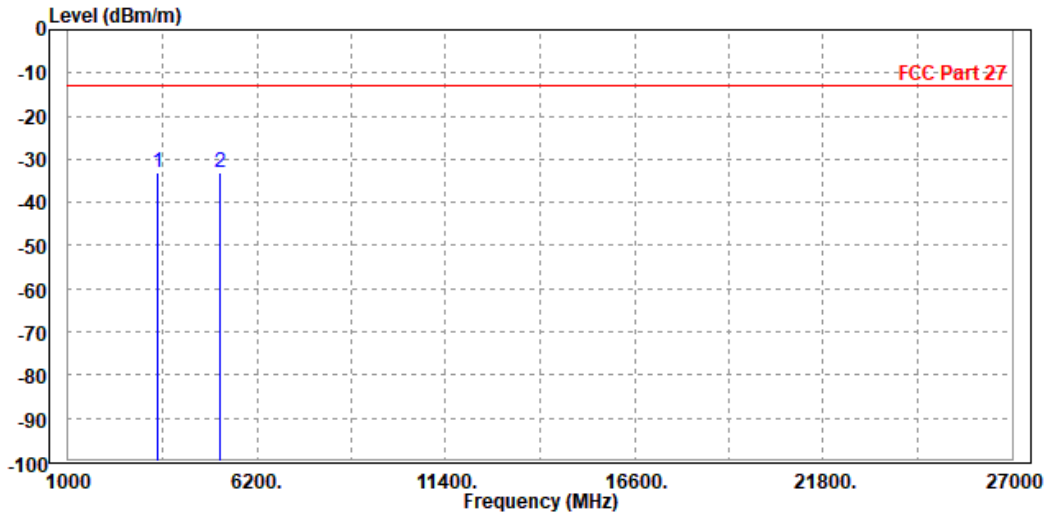



Test Report No.: RF200520W003-3

CHANNEL BANDWIDTH: 3MHz / QPSK

CH 19965

MODE	TX channel 19965	FREQUENCY RANGE	Above 1000MHz
ENVIRONMENTAL CONDITIONS	23deg. C, 70%RH	INPUT POWER	DC 5V
TESTED BY	Tony Xiong		
<b>ANTENNA POLARITY &amp; TEST DISTANCE: HORIZONTAL AT 3 M</b>			

	Freq	Level	Read Level	Limit Line	Over Limit	Factor	Remark	Pol/Phase
	MHz	dBm/m	dBm	dBm/m	dB	dB/m		
1	PP 3418.000	-30.68	-39.27	-13.00	-17.68	8.59	Peak	Horizontal
2	5134.000	-32.34	-41.27	-13.00	-19.34	8.93	Peak	Horizontal

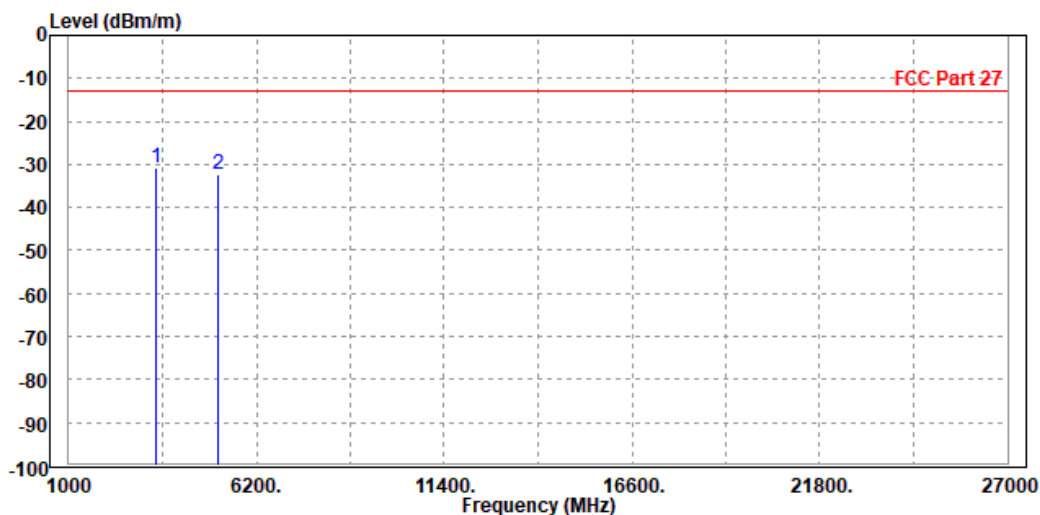



Test Report No.: RF200520W003-3

<b>MODE</b>	TX channel 19965	<b>FREQUENCY RANGE</b>	Above 1000MHz
<b>ENVIRONMENTAL CONDITIONS</b>	23deg. C, 70%RH	<b>INPUT POWER</b>	DC 5V
<b>TESTED BY</b>	Tony Xiong		
<b>ANTENNA POLARITY &amp; TEST DISTANCE: VERTICAL AT 3 M</b>			

	Freq	Level	Read Level	Limit Line	Over Limit	Factor	Remark	Pol/Phase
	MHz	dBm/m	dBm	dBm/m	dB	dB/m		
1	3418.000	-33.86	-42.97	-13.00	-20.86	9.11	Peak	Vertical
2 PP	5134.500	-32.38	-42.23	-13.00	-19.38	9.85	Peak	Vertical

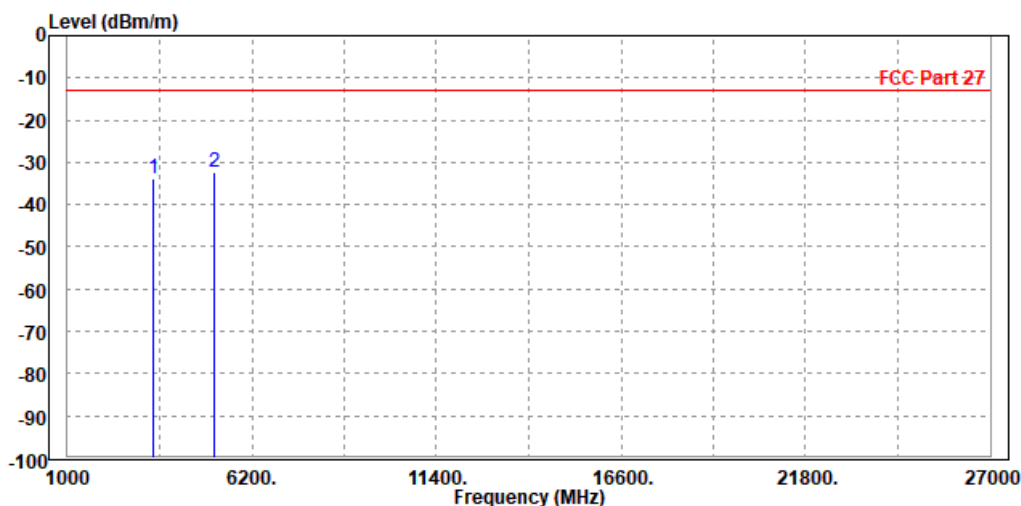



Test Report No.: RF200520W003-3

CH 20175

<b>MODE</b>	TX channel 20175	<b>FREQUENCY RANGE</b>	Above 1000MHz
<b>ENVIRONMENTAL CONDITIONS</b>	23deg. C, 70%RH	<b>INPUT POWER</b>	DC 5V
<b>TESTED BY</b>	Tony Xiong		
<b>ANTENNA POLARITY &amp; TEST DISTANCE: HORIZONTAL AT 3 M</b>			

	Freq	Level	Read Level	Limit Line	Over Limit	Factor	Remark	Pol/Phase
	MHz	dBm/m	dBm	dBm/m	dB	dB/m		
1	PP 3470.000	-30.44	-39.02	-13.00	-17.44	8.58	Peak	Horizontal
2	5197.500	-37.61	-46.73	-13.00	-24.61	9.12	Peak	Horizontal

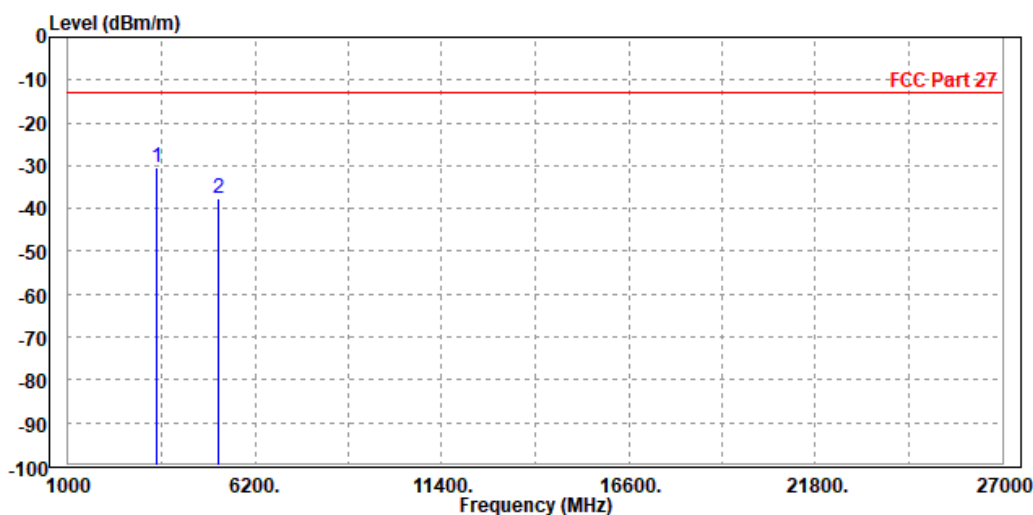



Test Report No.: RF200520W003-3

<b>MODE</b>	TX channel 20175	<b>FREQUENCY RANGE</b>	Above 1000MHz
<b>ENVIRONMENTAL CONDITIONS</b>	23deg. C, 70%RH	<b>INPUT POWER</b>	DC 5V
<b>TESTED BY</b>	Tony Xiong		
<b>ANTENNA POLARITY &amp; TEST DISTANCE: VERTICAL AT 3 M</b>			

	Freq	Level	Read Level	Limit Line	Over Limit	Factor	Remark	Pol/Phase
	MHz	dBm/m	dBm	dBm/m	dB	dB/m		
1	PP 3470.000	-31.56	-40.72	-13.00	-18.56	9.16	Peak	Vertical
2	5197.500	-34.35	-44.17	-13.00	-21.35	9.82	Peak	Vertical

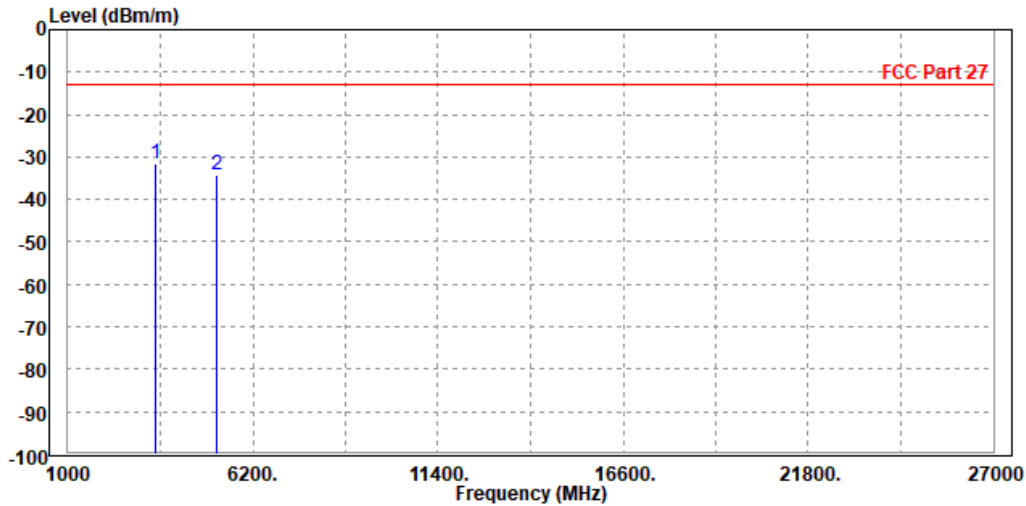



**BUREAU  
VERITAS**

Test Report No.: RF200520W003-3

**CH 20385**

<b>MODE</b>	TX channel 20385	<b>FREQUENCY RANGE</b>	Above 1000MHz
<b>ENVIRONMENTAL CONDITIONS</b>	23deg. C, 70%RH	<b>INPUT POWER</b>	DC 5V
<b>TESTED BY</b>	Tony Xiong		
<b>ANTENNA POLARITY &amp; TEST DISTANCE: HORIZONTAL AT 3 M</b>			

	Freq	Level	Read Level	Limit Line	Over Limit	Factor	Remark	Pol/Phase
	MHz	dBm/m	dBm	dBm/m	dB	dB/m		
1	PP 3496.000	-30.24	-38.81	-13.00	-17.24	8.57	Peak	Horizontal
2	5264.000	-37.04	-46.36	-13.00	-24.04	9.32	Peak	Horizontal

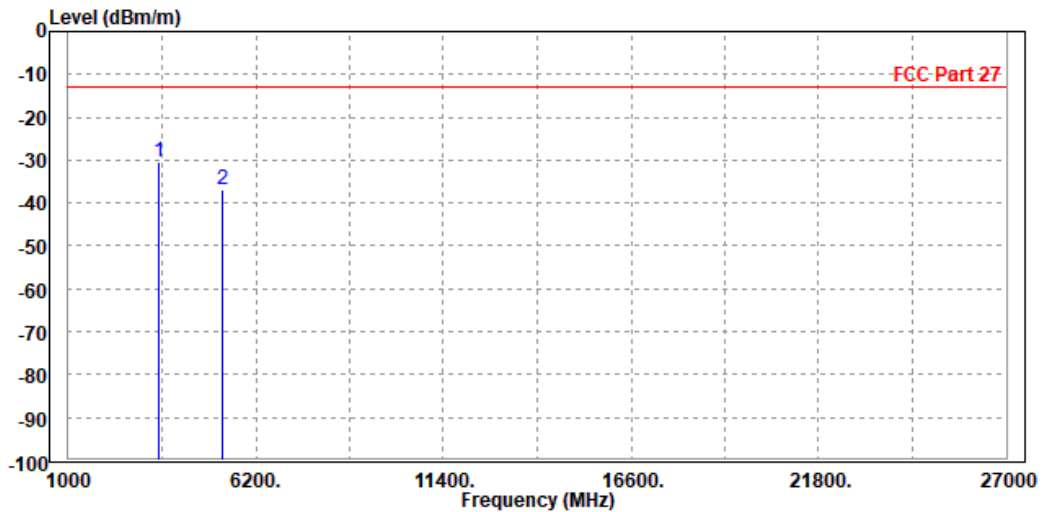



Test Report No.: RF200520W003-3

<b>MODE</b>	TX channel 20385	<b>FREQUENCY RANGE</b>	Above 1000MHz
<b>ENVIRONMENTAL CONDITIONS</b>	23deg. C, 70%RH	<b>INPUT POWER</b>	DC 5V
<b>TESTED BY</b>	Tony Xiong		
<b>ANTENNA POLARITY &amp; TEST DISTANCE: VERTICAL AT 3 M</b>			

	Freq	Level	Read Level	Limit Line	Over Limit	Factor	Remark	Pol/Phase
	MHz	dBm/m	dBm	dBm/m	dB	dB/m		
1	PP 3496.000	-31.18	-40.37	-13.00	-18.18	9.19	Peak	Vertical
2	5264.000	-33.77	-43.57	-13.00	-20.77	9.80	Peak	Vertical

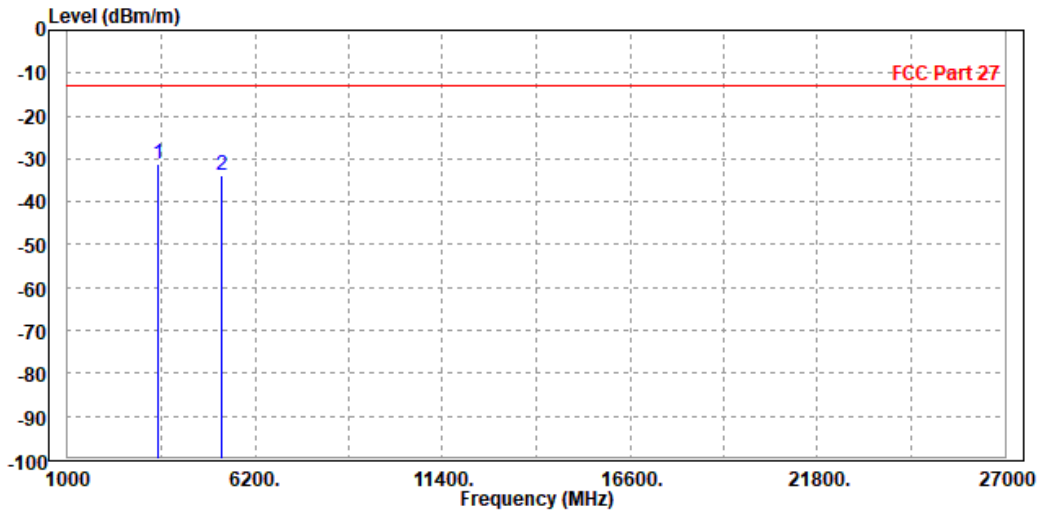





**BUREAU  
VERITAS**

Test Report No.: RF200520W003-3

**CHANNEL BANDWIDTH: 5MHz / QPSK**

<b>MODE</b>	TX channel 20175	<b>FREQUENCY RANGE</b>	Above 1000MHz
<b>ENVIRONMENTAL CONDITIONS</b>	23deg. C, 70%RH	<b>INPUT POWER</b>	DC 5V
<b>TESTED BY</b>	Tony Xiong		
<b>ANTENNA POLARITY &amp; TEST DISTANCE: HORIZONTAL AT 3 M</b>			

	Freq	Level	Read Level	Limit Line	Over Limit	Factor	Remark	Pol/Phase
	MHz	dBm/m	dBm	dBm/m	dB	dB/m		
1	PP 3470.000	-31.97	-40.55	-13.00	-18.97	8.58	Peak	Horizontal
2	5197.500	-41.46	-50.58	-13.00	-28.46	9.12	Peak	Horizontal

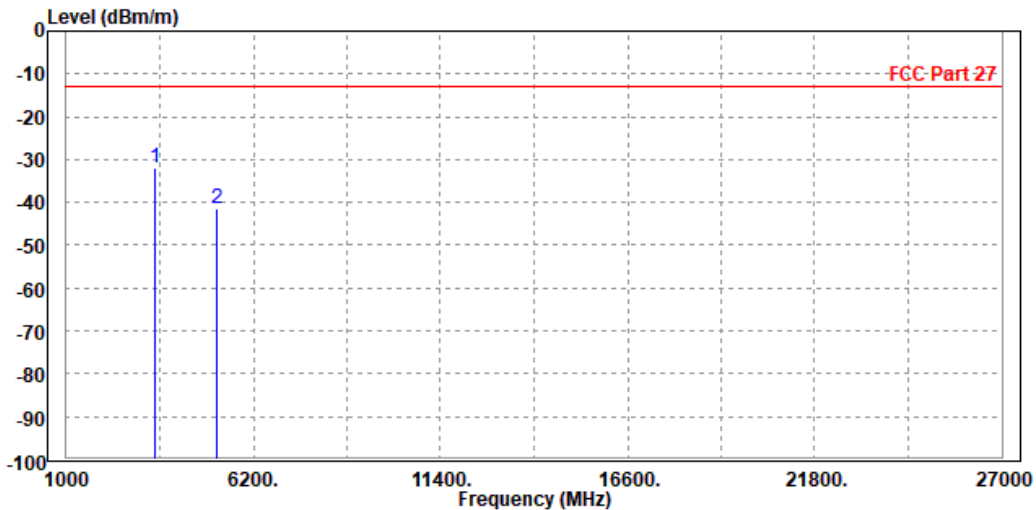



Test Report No.: RF200520W003-3

<b>MODE</b>	TX channel 20175	<b>FREQUENCY RANGE</b>	Above 1000MHz
<b>ENVIRONMENTAL CONDITIONS</b>	23deg. C, 70%RH	<b>INPUT POWER</b>	DC 5V
<b>TESTED BY</b>	Tony Xiong		
<b>ANTENNA POLARITY &amp; TEST DISTANCE: VERTICAL AT 3 M</b>			

	Freq	Level	Read Level	Limit Line	Over Limit	Factor	Remark	Pol/Phase
	MHz	dBm/m	dBm	dBm/m	dB	dB/m		
1	3470.000	-35.13	-44.29	-13.00	-22.13	9.16	Peak	Vertical
2 PP	5197.500	-33.95	-43.77	-13.00	-20.95	9.82	Peak	Vertical

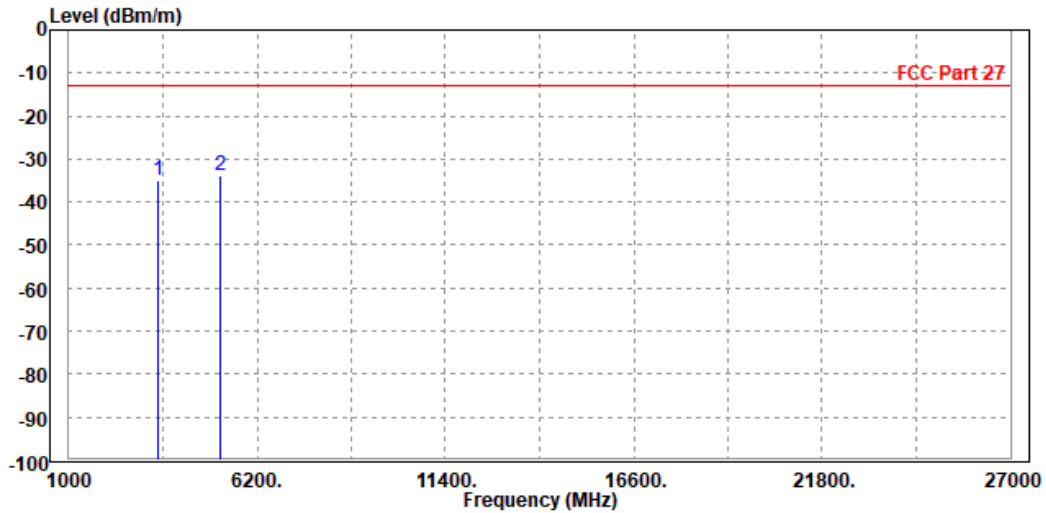



BUREAU VERITAS

Test Report No.: RF200520W003-3

CHANNEL BANDWIDTH: 10MHz / QPSK

MODE	TX channel 20175	FREQUENCY RANGE	Above 1000MHz
ENVIRONMENTAL CONDITIONS	23deg. C, 70%RH	INPUT POWER	DC 5V
TESTED BY	Tony Xiong		
ANTENNA POLARITY & TEST DISTANCE: HORIZONTAL AT 3 M			

	Freq	Level	Read Level	Limit Line	Over Limit	Factor	Remark	Pol/Phase
	MHz	dBm/m	dBm	dBm/m	dB	dB/m		
1 PP	3470.000	-32.22	-40.80	-13.00	-19.22	8.58	Peak	Horizontal
2	5197.500	-42.20	-51.32	-13.00	-29.20	9.12	Peak	Horizontal

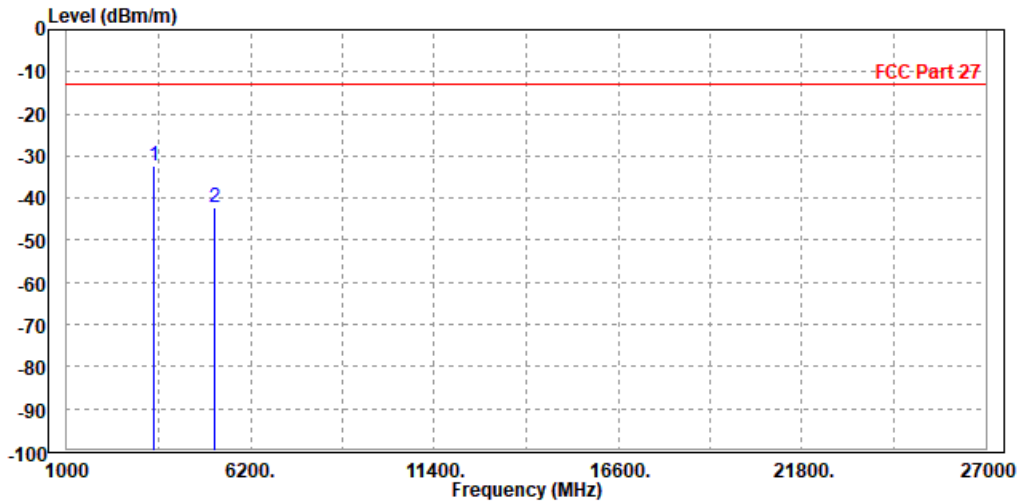



Test Report No.: RF200520W003-3

<b>MODE</b>	TX channel 20175	<b>FREQUENCY RANGE</b>	Above 1000MHz
<b>ENVIRONMENTAL CONDITIONS</b>	23deg. C, 70%RH	<b>INPUT POWER</b>	DC 5V
<b>TESTED BY</b>	Tony Xiong		
<b>ANTENNA POLARITY &amp; TEST DISTANCE: VERTICAL AT 3 M</b>			

	Freq	Level	Read Level	Limit Line	Over Limit	Factor	Remark	Pol/Phase
	MHz	dBm/m	dBm	dBm/m	dB	dB/m		
1	PP 3470.000	-33.75	-42.91	-13.00	-20.75	9.16	Peak	Vertical
2	5197.500	-35.18	-45.00	-13.00	-22.18	9.82	Peak	Vertical

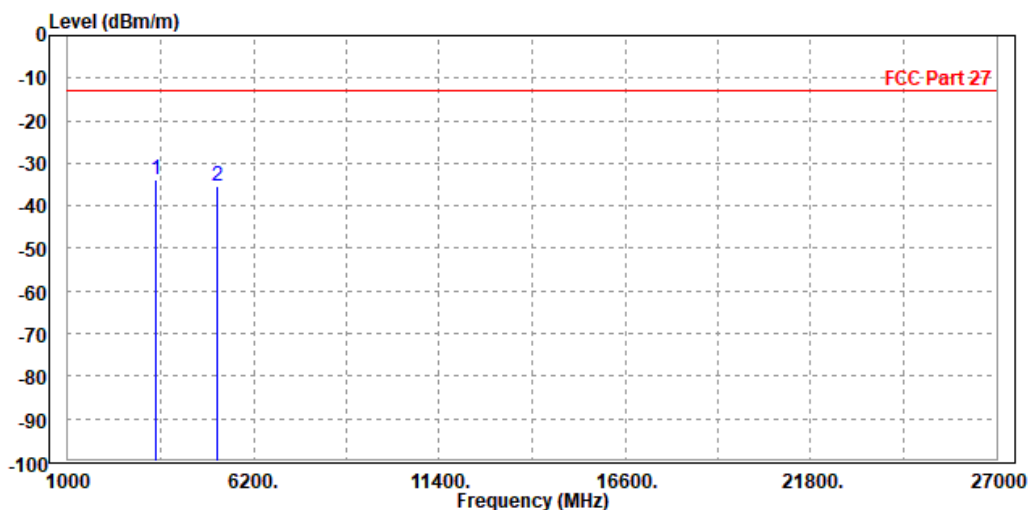



Test Report No.: RF200520W003-3

**CHANNEL BANDWIDTH: 15MHz / QPSK**

<b>MODE</b>	TX channel 20175	<b>FREQUENCY RANGE</b>	Above 1000MHz
<b>ENVIRONMENTAL CONDITIONS</b>	23deg. C, 70%RH	<b>INPUT POWER</b>	DC 5V
<b>TESTED BY</b>	Tony Xiong		
<b>ANTENNA POLARITY &amp; TEST DISTANCE: HORIZONTAL AT 3 M</b>			

	Freq	Level	Read Level	Limit	Over Limit	Factor	Remark	Pol/Phase
	MHz	dBm/m	dBm	dBm/m	dB	dB/m		
1	PP 3470.000	-29.93	-38.51	-13.00	-16.93	8.58	Peak	Horizontal
2	5197.500	-33.19	-42.31	-13.00	-20.19	9.12	Peak	Horizontal

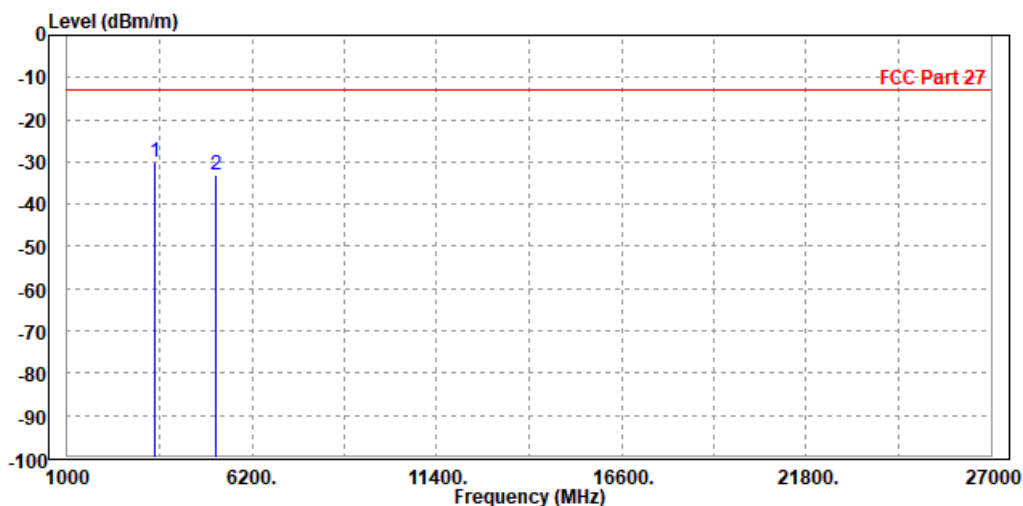



Test Report No.: RF200520W003-3

<b>MODE</b>	TX channel 20175	<b>FREQUENCY RANGE</b>	Above 1000MHz
<b>ENVIRONMENTAL CONDITIONS</b>	23deg. C, 70%RH	<b>INPUT POWER</b>	DC 5V
<b>TESTED BY</b>	Tony Xiong		
<b>ANTENNA POLARITY &amp; TEST DISTANCE: VERTICAL AT 3 M</b>			

	Freq	Level	Read Level	Limit Line	Over Limit	Factor	Remark	Pol/Phase
	MHz	dBm/m	dBm	dBm/m	dB	dB/m		
1	PP 3470.000	-34.07	-43.23	-13.00	-21.07	9.16	Peak	Vertical
2	5197.500	-34.96	-44.78	-13.00	-21.96	9.82	Peak	Vertical

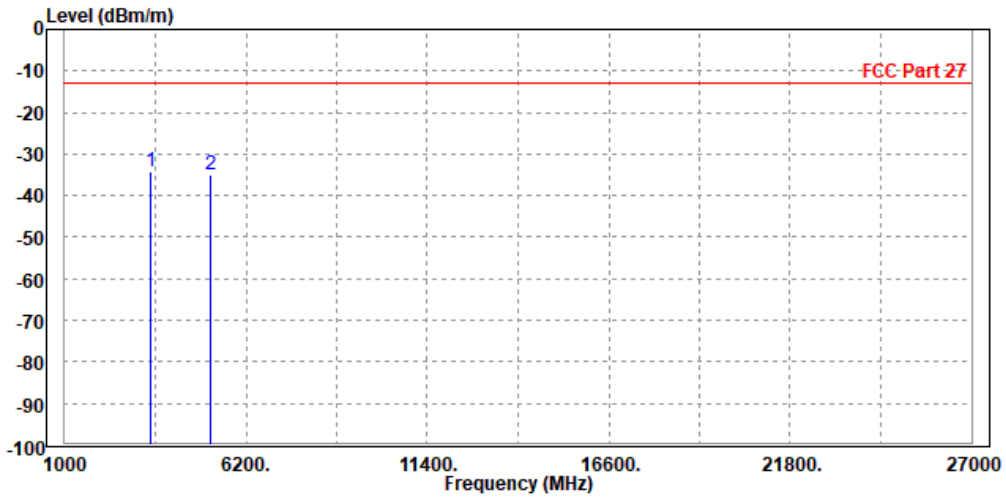



Test Report No.: RF200520W003-3

**CHANNEL BANDWIDTH: 20MHz / QPSK**

<b>MODE</b>	TX channel 20175	<b>FREQUENCY RANGE</b>	Above 1000MHz
<b>ENVIRONMENTAL CONDITIONS</b>	23deg. C, 70%RH	<b>INPUT POWER</b>	DC 5V
<b>TESTED BY</b>	Tony Xiong		
<b>ANTENNA POLARITY &amp; TEST DISTANCE: HORIZONTAL AT 3 M</b>			

	Freq	Level	Read Level	Limit Line	Over Limit	Factor	Remark	Pol/Phase
	MHz	dBm/m	dBm	dBm/m	dB	dB/m		
1	PP 3470.000	-31.83	-40.41	-13.00	-18.83	8.58	Peak	Horizontal
2	5197.500	-38.02	-47.14	-13.00	-25.02	9.12	Peak	Horizontal

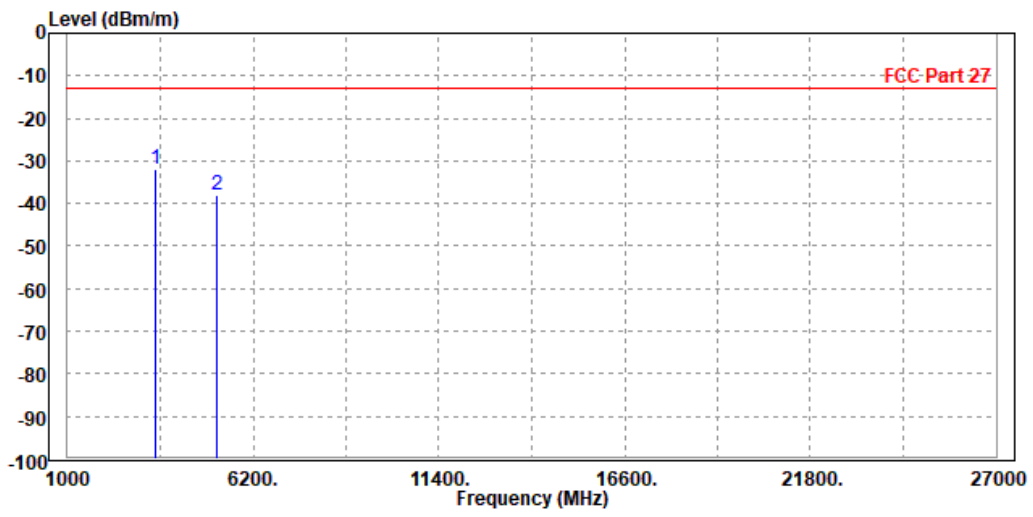



Test Report No.: RF200520W003-3

<b>MODE</b>	TX channel 20175	<b>FREQUENCY RANGE</b>	Above 1000MHz
<b>ENVIRONMENTAL CONDITIONS</b>	23deg. C, 70%RH	<b>INPUT POWER</b>	DC 5V
<b>TESTED BY</b>	Tony Xiong		
<b>ANTENNA POLARITY &amp; TEST DISTANCE: VERTICAL AT 3 M</b>			

	Freq	Level	Read Level	Limit Line	Over Limit	Factor	Remark	Pol/Phase
	MHz	dBm/m	dBm	dBm/m	dB	dB/m		
1	PP 3470.000	-34.34	-43.50	-13.00	-21.34	9.16	Peak	Vertical
2	5197.500	-43.18	-53.00	-13.00	-30.18	9.82	Peak	Vertical

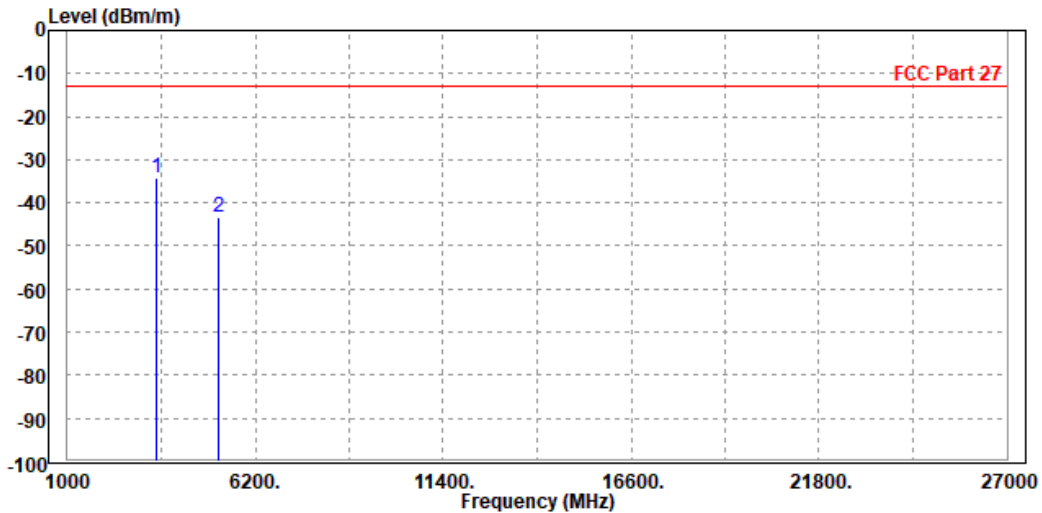





**BUREAU  
VERITAS**

Test Report No.: RF200520W003-3

**LTE Band 12**

**CHANNEL BANDWIDTH: 1.4MHz / QPSK**

<b>MODE</b>	TX channel 23095	<b>FREQUENCY RANGE</b>	Above 1000MHz
<b>ENVIRONMENTAL CONDITIONS</b>	23deg. C, 70%RH	<b>INPUT POWER</b>	DC 5V
<b>TESTED BY</b>	Tony Xiong		
<b>ANTENNA POLARITY &amp; TEST DISTANCE: HORIZONTAL AT 3 M</b>			

	Freq	Level	Read Level	Limit Line	Over Limit	Factor	Remark	Pol/Phase
	MHz	dBm/m	dBm	dBm/m	dB	dB/m		
1	1415.000	-45.20	-46.27	-13.00	-32.20	1.07	Peak	Horizontal
2 PP	2118.000	-28.69	-36.36	-13.00	-15.69	7.67	Peak	Horizontal

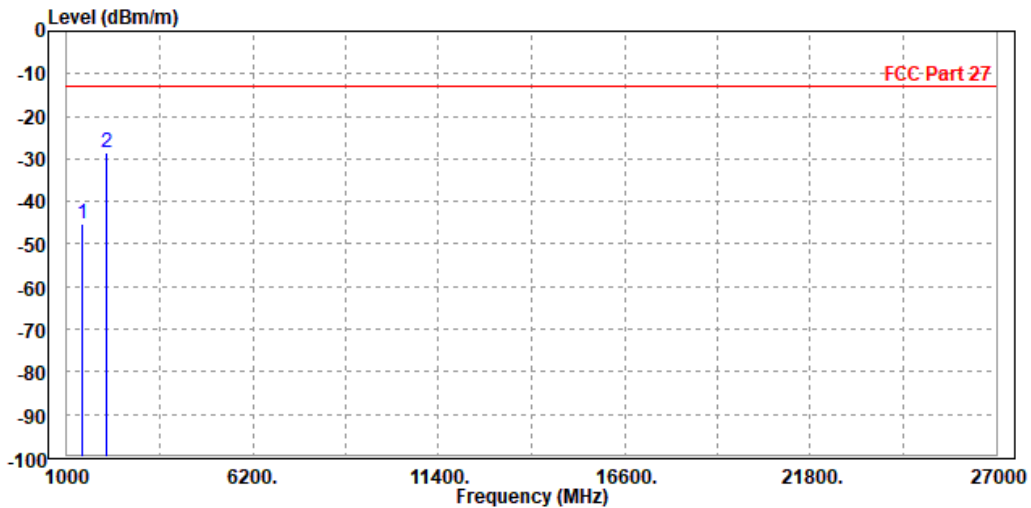



Test Report No.: RF200520W003-3

<b>MODE</b>	TX channel 23095	<b>FREQUENCY RANGE</b>	Above 1000MHz
<b>ENVIRONMENTAL CONDITIONS</b>	23deg. C, 70%RH	<b>INPUT POWER</b>	DC 5V from adapter
<b>TESTED BY</b>	Tony Xiong		
<b>ANTENNA POLARITY &amp; TEST DISTANCE: VERTICAL AT 3 M</b>			

	Freq	Level	Read Level	Limit Line	Over Limit	Factor	Remark	Pol/Phase
	MHz	dBm/m	dBm	dBm/m	dB	dB/m		
1	1416.000	-43.79	-45.48	-13.00	-30.79	1.69	Peak	Vertical
2 PP	2122.500	-37.15	-43.84	-13.00	-24.15	6.69	Peak	Vertical

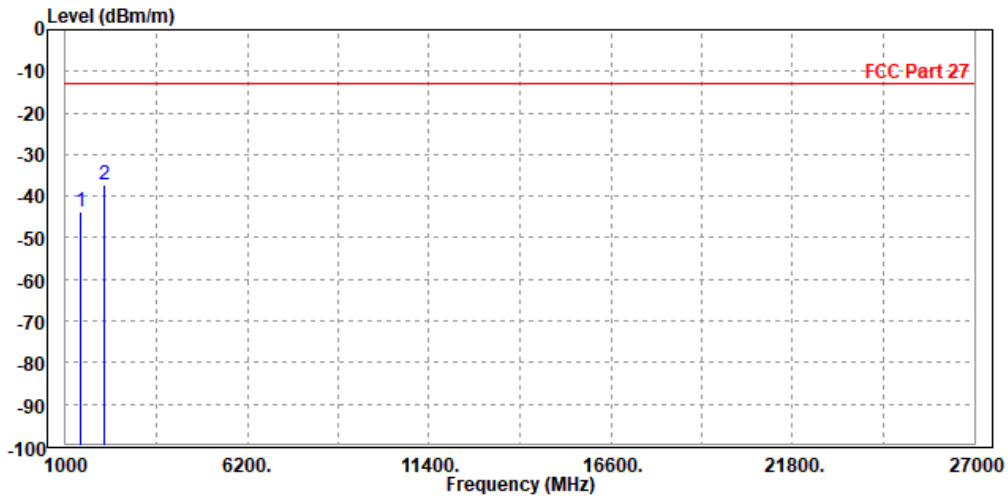



Test Report No.: RF200520W003-3

**CHANNEL BANDWIDTH: 3MHz / QPSK**

<b>MODE</b>	TX channel 23095	<b>FREQUENCY RANGE</b>	Above 1000MHz
<b>ENVIRONMENTAL CONDITIONS</b>	23deg. C, 70%RH	<b>INPUT POWER</b>	DC 5V
<b>TESTED BY</b>	Tony Xiong		
<b>ANTENNA POLARITY &amp; TEST DISTANCE: HORIZONTAL AT 3 M</b>			

	Freq	Level	Read Level	Limit Line	Over Limit	Factor	Remark	Pol/Phase
	MHz	dBm/m	dBm	dBm/m	dB	dB/m		
1	1416.000	-44.68	-45.76	-13.00	-31.68	1.08	Peak	Horizontal
2	PP 2122.500	-27.42	-35.09	-13.00	-14.42	7.67	Peak	Horizontal

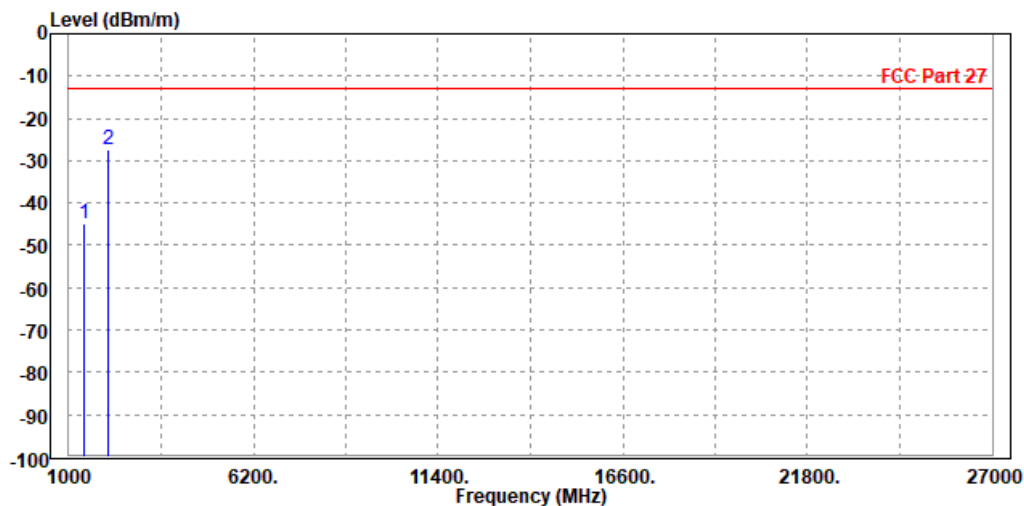



Test Report No.: RF200520W003-3

<b>MODE</b>	TX channel 23095	<b>FREQUENCY RANGE</b>	Above 1000MHz
<b>ENVIRONMENTAL CONDITIONS</b>	23deg. C, 70%RH	<b>INPUT POWER</b>	DC 5V
<b>TESTED BY</b>	Tony Xiong		
<b>ANTENNA POLARITY &amp; TEST DISTANCE: VERTICAL AT 3 M</b>			

	Freq	Level	Read Level	Limit Line	Over Limit	Factor	Remark	Pol/Phase
	MHz	dBm/m	dBm	dBm/m	dB	dB/m		
1	1415.000	-44.79	-46.48	-13.00	-31.79	1.69	Peak	Vertical
2	PP 2118.000	-37.66	-44.34	-13.00	-24.66	6.68	Peak	Vertical

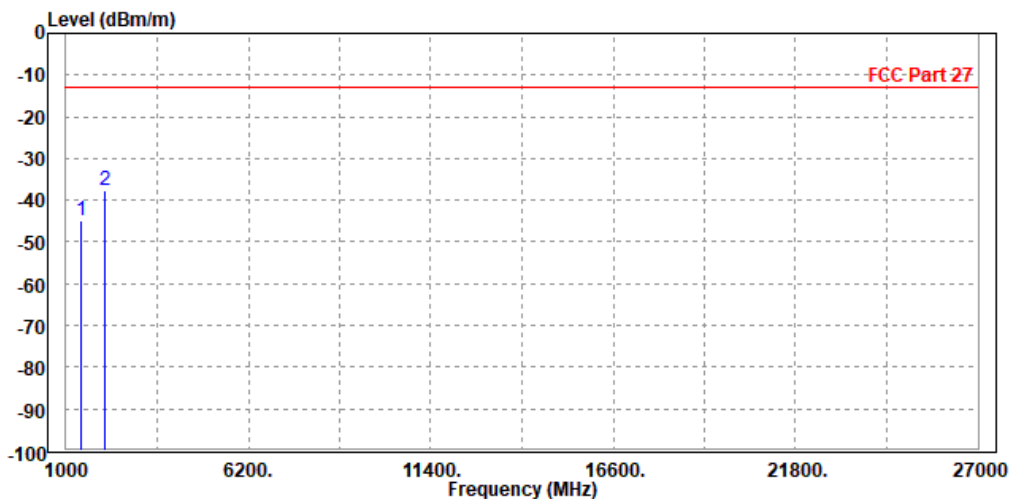



Test Report No.: RF200520W003-3

CHANNEL BANDWIDTH: 5MHz / QPSK

CH 23035

MODE	TX channel 23035	FREQUENCY RANGE	Above 1000MHz
ENVIRONMENTAL CONDITIONS	23deg. C, 70%RH	INPUT POWER	DC 5V
TESTED BY	Tony Xiong		
<b>ANTENNA POLARITY &amp; TEST DISTANCE: HORIZONTAL AT 3 M</b>			

	Freq	Level	Read Level	Limit Line	Over Limit	Factor	Remark	Pol/Phase
	MHz	dBm/m	dBm	dBm/m	dB	dB/m		
1	1416.000	-45.35	-46.43	-13.00	-32.35	1.08	Peak	Horizontal
2 PP	2104.500	-27.75	-35.40	-13.00	-14.75	7.65	Peak	Horizontal

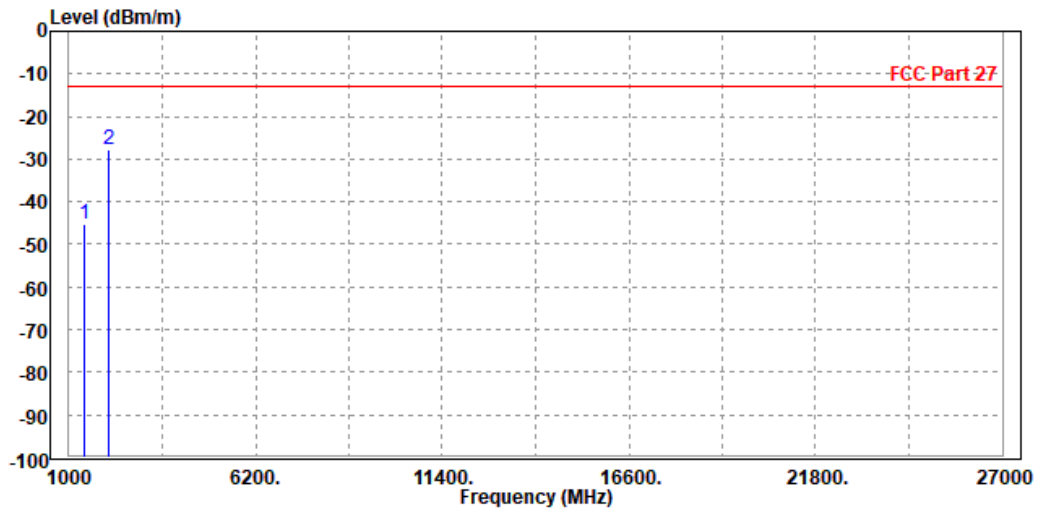



Test Report No.: RF200520W003-3

<b>MODE</b>	TX channel 23035	<b>FREQUENCY RANGE</b>	Above 1000MHz
<b>ENVIRONMENTAL CONDITIONS</b>	23deg. C, 70%RH	<b>INPUT POWER</b>	DC 5V
<b>TESTED BY</b>	Tony Xiong		
<b>ANTENNA POLARITY &amp; TEST DISTANCE: VERTICAL AT 3 M</b>			

	Freq	Level	Read Level	Limit Line	Over Limit	Factor	Remark	Pol/Phase
	MHz	dBm/m	dBm	dBm/m	dB	dB/m		
1	1403.000	-50.05	-51.69	-13.00	-37.05	1.64	Peak	Vertical
2 PP	2092.000	-42.24	-48.90	-13.00	-29.24	6.66	Peak	Vertical

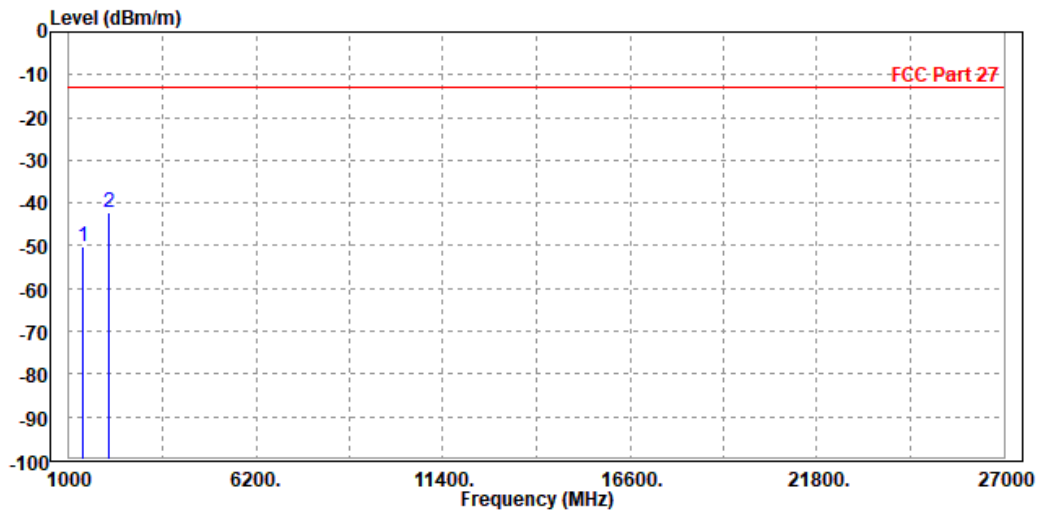



Test Report No.: RF200520W003-3

CH 23095

<b>MODE</b>	TX channel 23095	<b>FREQUENCY RANGE</b>	Above 1000MHz
<b>ENVIRONMENTAL CONDITIONS</b>	23deg. C, 70%RH	<b>INPUT POWER</b>	DC 5V
<b>TESTED BY</b>	Tony Xiong		
<b>ANTENNA POLARITY &amp; TEST DISTANCE: HORIZONTAL AT 3 M</b>			

	Freq	Level	Read Level	Limit Line	Over Limit	Factor	Remark	Pol/Phase
	MHz	dBm/m	dBm	dBm/m	dB	dB/m		
1	1415.000	-45.11	-46.18	-13.00	-32.11	1.07	Peak	Horizontal
2 PP	2118.000	-27.15	-34.82	-13.00	-14.15	7.67	Peak	Horizontal

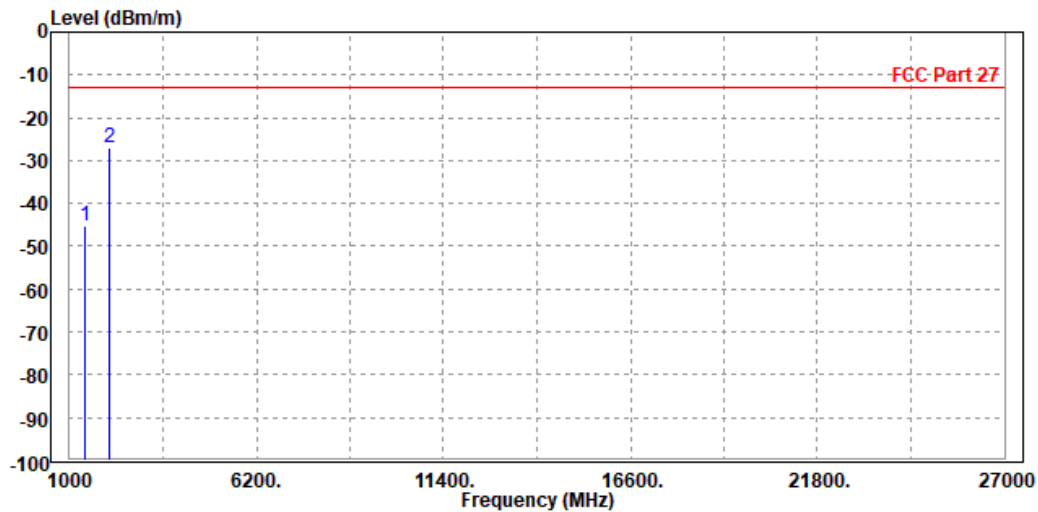



Test Report No.: RF200520W003-3

<b>MODE</b>	TX channel 23095	<b>FREQUENCY RANGE</b>	Above 1000MHz
<b>ENVIRONMENTAL CONDITIONS</b>	23deg. C, 70%RH	<b>INPUT POWER</b>	DC 5V
<b>TESTED BY</b>	Tony Xiong		
<b>ANTENNA POLARITY &amp; TEST DISTANCE: VERTICAL AT 3 M</b>			

	Freq	Level	Read Level	Limit Line	Over Limit	Factor	Remark	Pol/Phase
	MHz	dBm/m	dBm	dBm/m	dB	dB/m		
1	1416.000	-45.15	-46.84	-13.00	-32.15	1.69	Peak	Vertical
2 PP	2122.500	-35.17	-41.86	-13.00	-22.17	6.69	Peak	Vertical

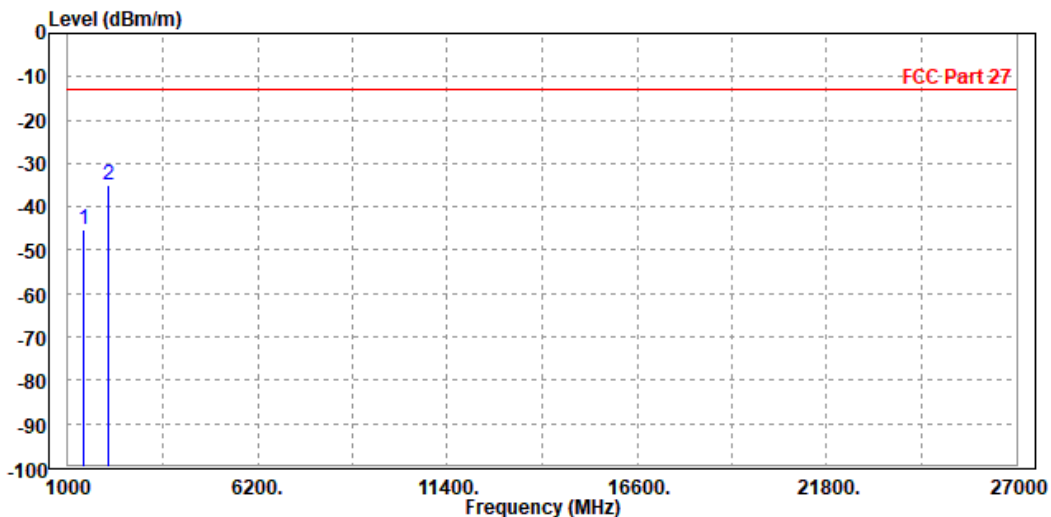





BUREAU VERITAS

Test Report No.: RF200520W003-3

CH 23155

MODE	TX channel 23155	FREQUENCY RANGE	Above 1000MHz
ENVIRONMENTAL CONDITIONS	23deg. C, 70%RH	INPUT POWER	DC 5V
TESTED BY	Tony Xiong		
<b>ANTENNA POLARITY &amp; TEST DISTANCE: HORIZONTAL AT 3 M</b>			

	Freq	Level	Read Level	Limit Line	Over Limit	Factor	Remark	Pol/Phase
	MHz	dBm/m	dBm	dBm/m	dB	dB/m		
1	1427.000	-44.34	-45.47	-13.00	-31.34	1.13	Peak	Horizontal
2	PP 2144.000	-28.14	-35.83	-13.00	-15.14	7.69	Peak	Horizontal

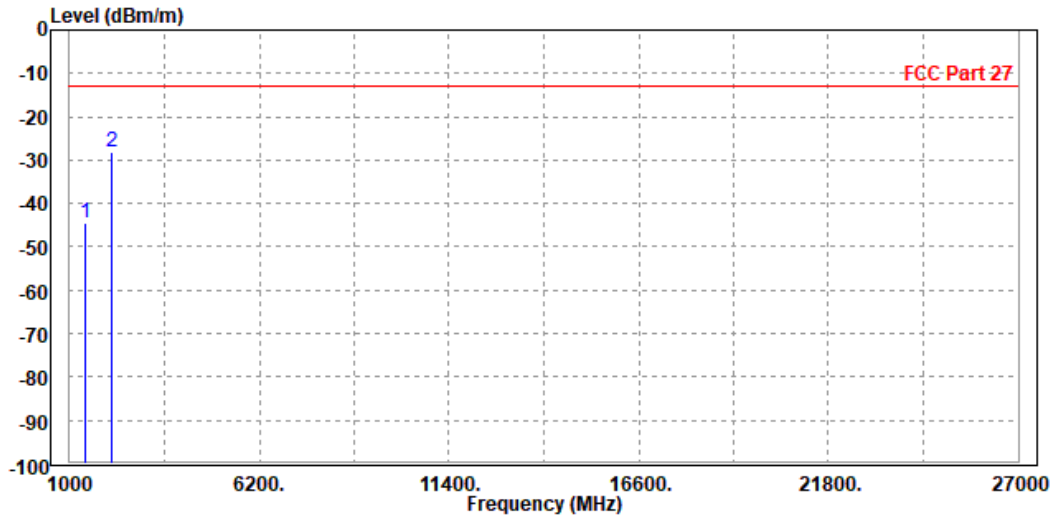



Test Report No.: RF200520W003-3

<b>MODE</b>	TX channel 23155	<b>FREQUENCY RANGE</b>	Above 1000MHz
<b>ENVIRONMENTAL CONDITIONS</b>	23deg. C, 70%RH	<b>INPUT POWER</b>	DC 5V
<b>TESTED BY</b>	Tony Xiong		
<b>ANTENNA POLARITY &amp; TEST DISTANCE: VERTICAL AT 3 M</b>			

	Freq	Level	Read Level	Limit Line	Over Limit	Factor	Remark	Pol/Phase
	MHz	dBm/m	dBm	dBm/m	dB	dB/m		
1	1416.000	-50.86	-52.55	-13.00	-37.86	1.69	Peak	Vertical
2	PP 2140.500	-38.71	-45.42	-13.00	-25.71	6.71	Peak	Vertical

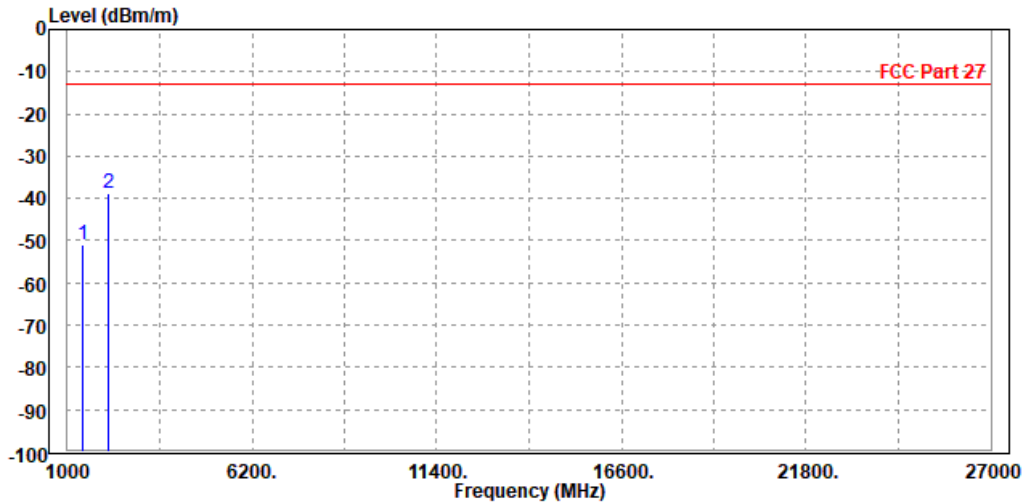



Test Report No.: RF200520W003-3

**CHANNEL BANDWIDTH: 10MHz / QPSK**

<b>MODE</b>	TX channel 23095	<b>FREQUENCY RANGE</b>	Above 1000MHz
<b>ENVIRONMENTAL CONDITIONS</b>	23deg. C, 70%RH	<b>INPUT POWER</b>	DC 5V
<b>TESTED BY</b>	Tony Xiong		
<b>ANTENNA POLARITY &amp; TEST DISTANCE: HORIZONTAL AT 3 M</b>			

	Freq	Level	Read Level	Limit Line	Over Limit	Factor	Remark	Pol/Phase
	MHz	dBm/m	dBm	dBm/m	dB	dB/m		
1	1416.000	-42.13	-43.21	-13.00	-29.13	1.08	Peak	Horizontal
2 PP	2122.500	-27.06	-34.73	-13.00	-14.06	7.67	Peak	Horizontal

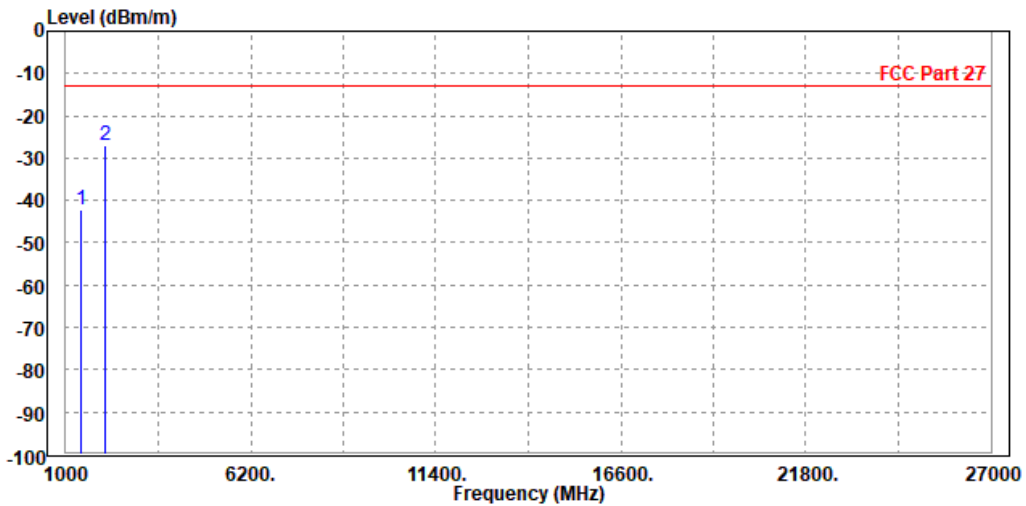



Test Report No.: RF200520W003-3

<b>MODE</b>	TX channel 23095	<b>FREQUENCY RANGE</b>	Above 1000MHz
<b>ENVIRONMENTAL CONDITIONS</b>	23deg. C, 70%RH	<b>INPUT POWER</b>	DC 5V
<b>TESTED BY</b>	Tony Xiong		
<b>ANTENNA POLARITY &amp; TEST DISTANCE: VERTICAL AT 3 M</b>			

	Freq	Level	Read Level	Limit Line	Over Limit	Factor	Remark	Pol/Phase
	MHz	dBm/m	dBm	dBm/m	dB	dB/m		
1	1415.000	-45.35	-47.04	-13.00	-32.35	1.69	Peak	Vertical
2	PP 2118.000	-39.00	-45.68	-13.00	-26.00	6.68	Peak	Vertical

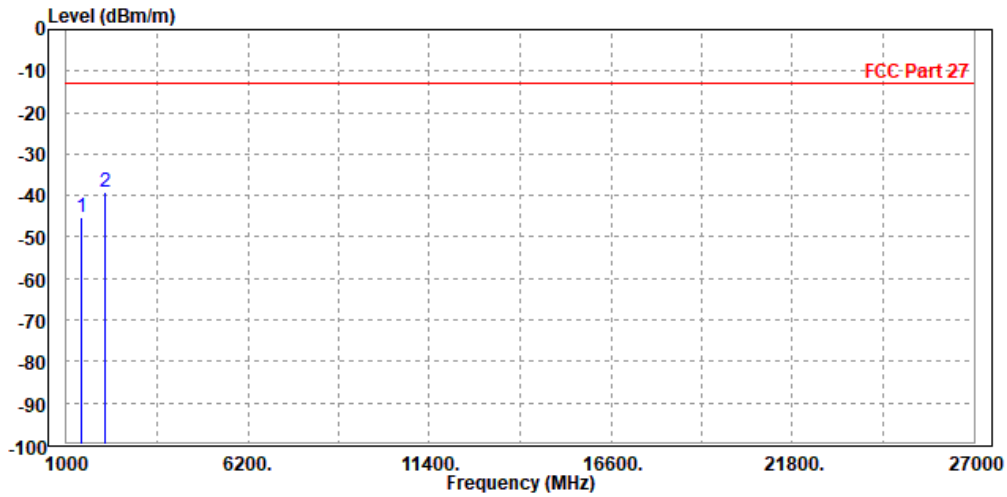



Test Report No.: RF200520W003-3

LTE Band 13  
 CHANNEL BANDWIDTH: 5MHz / QPSK  
 CH 23205

MODE	TX channel 23205	FREQUENCY RANGE	Above 1000MHz
ENVIRONMENTAL CONDITIONS	23deg. C, 70%RH	INPUT POWER	DC 5V
TESTED BY	Tony Xiong		
ANTENNA POLARITY & TEST DISTANCE: HORIZONTAL AT 3 M			

	Freq	Level	Read Level	Limit Line	Over Limit	Factor	Remark	Pol/Phase
	MHz	dBm/m	dBm	dBm/m	dB	dB/m		
1	1559.000	-39.51	-41.68	-13.00	-26.51	2.17	Peak	Horizontal
2 PP	2338.500	-38.00	-45.89	-13.00	-25.00	7.89	Peak	Horizontal

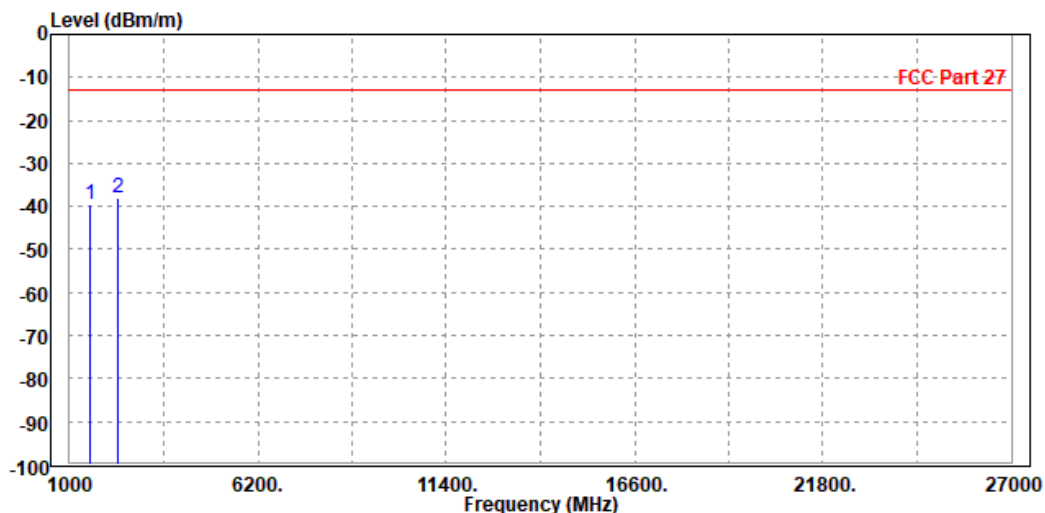



Test Report No.: RF200520W003-3

<b>MODE</b>	TX channel 23205	<b>FREQUENCY RANGE</b>	Above 1000MHz
<b>ENVIRONMENTAL CONDITIONS</b>	23deg. C, 70%RH	<b>INPUT POWER</b>	DC 5V
<b>TESTED BY</b>	Tony Xiong		
<b>ANTENNA POLARITY &amp; TEST DISTANCE: VERTICAL AT 3 M</b>			

	Freq	Level	Read Level	Limit Line	Over Limit	Factor	Remark	Pol/Phase
	MHz	dBm/m	dBm	dBm/m	dB	dB/m		
1	1559.000	-44.78	-47.36	-13.00	-31.78	2.58	Peak	Vertical
2 PP	2338.500	-42.75	-49.65	-13.00	-29.75	6.90	Peak	Vertical

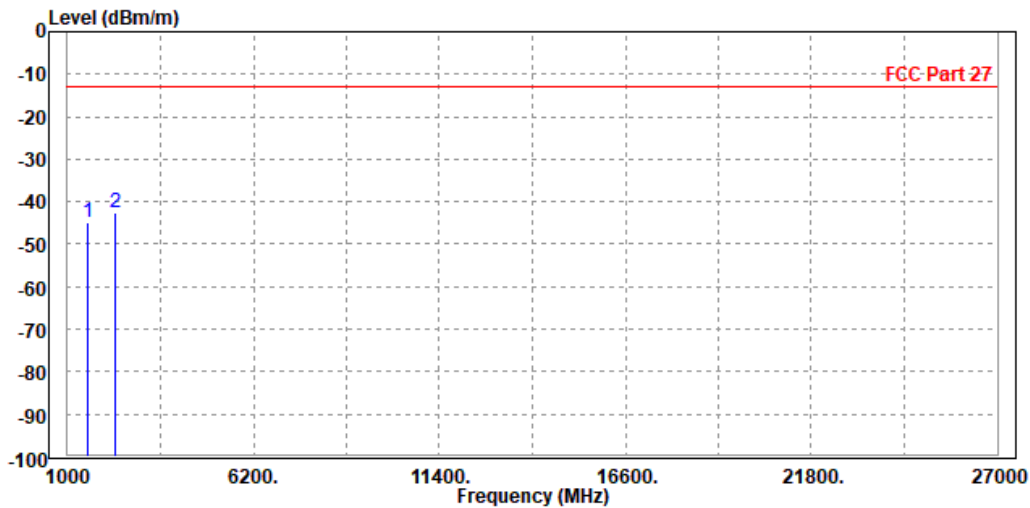



BUREAU VERITAS

Test Report No.: RF200520W003-3

CH 23230

MODE	TX channel 23230	FREQUENCY RANGE	Above 1000MHz
ENVIRONMENTAL CONDITIONS	23deg. C, 70%RH	INPUT POWER	DC 5V
TESTED BY	Tony Xiong		
<b>ANTENNA POLARITY &amp; TEST DISTANCE: HORIZONTAL AT 3 M</b>			

	Freq	Level	Read Level	Limit Line	Over Limit	Factor	Remark	Pol/Phase
	MHz	dBm/m	dBm	dBm/m	dB	dB/m		
1	1572.000	-40.84	-43.16	-13.00	-27.84	2.32	Peak	Horizontal
2 PP	2352.000	-38.37	-46.27	-13.00	-25.37	7.90	Peak	Horizontal

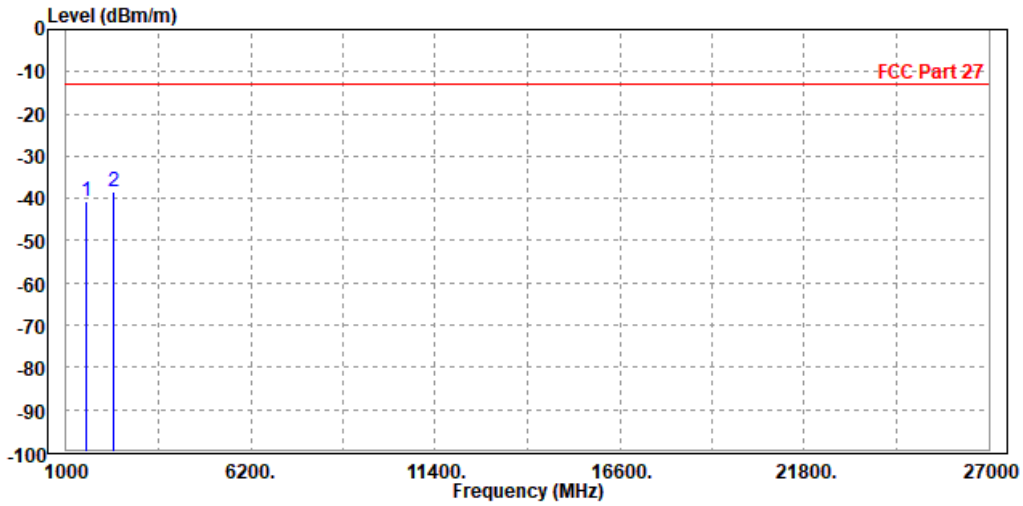



Test Report No.: RF200520W003-3

MODE	TX channel 23230	FREQUENCY RANGE	Above 1000MHz
ENVIRONMENTAL CONDITIONS	23deg. C, 70%RH	INPUT POWER	DC 5V
TESTED BY	Tony Xiong		
<b>ANTENNA POLARITY &amp; TEST DISTANCE: VERTICAL AT 3 M</b>			

	Freq	Level	Read Level	Limit Line	Over Limit	Factor	Remark	Pol/Phase
	MHz	dBm/m	dBm	dBm/m	dB	dB/m		
1	1564.000	-46.28	-48.90	-13.00	-33.28	2.62	Peak	Vertical
2 PP	2352.000	-42.14	-49.06	-13.00	-29.14	6.92	Peak	Vertical

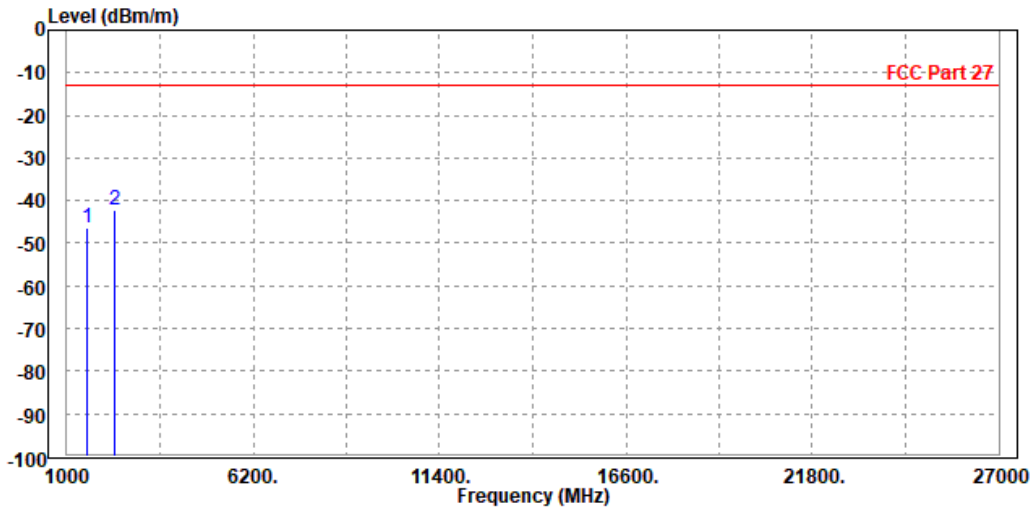





BUREAU VERITAS

Test Report No.: RF200520W003-3

CH 23255

MODE	TX channel 23255	FREQUENCY RANGE	Above 1000MHz
ENVIRONMENTAL CONDITIONS	23deg. C, 70%RH	INPUT POWER	DC 5V
TESTED BY	Tony Xiong		
<b>ANTENNA POLARITY &amp; TEST DISTANCE: HORIZONTAL AT 3 M</b>			

	Freq	Level	Read Level	Limit Line	Over Limit	Factor	Remark	Pol/Phase
	MHz	dBm/m	dBm	dBm/m	dB	dB/m		
1	1569.000	-40.40	-42.69	-13.00	-27.40	2.29	Peak	Horizontal
2 PP	2353.500	-37.98	-45.88	-13.00	-24.98	7.90	Peak	Horizontal

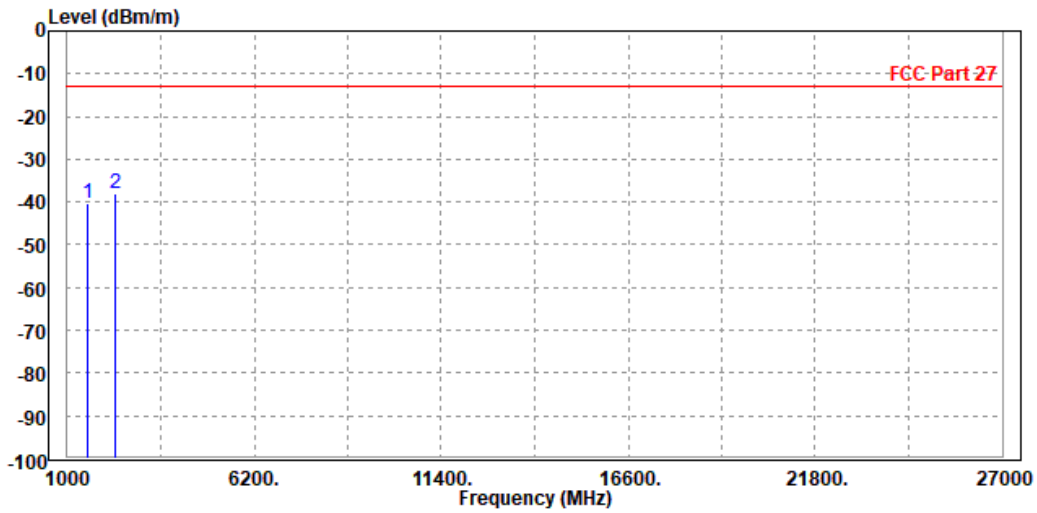



Test Report No.: RF200520W003-3

<b>MODE</b>	TX channel 23255	<b>FREQUENCY RANGE</b>	Above 1000MHz
<b>ENVIRONMENTAL CONDITIONS</b>	23deg. C, 70%RH	<b>INPUT POWER</b>	DC 5V
<b>TESTED BY</b>	Tony Xiong		
<b>ANTENNA POLARITY &amp; TEST DISTANCE: VERTICAL AT 3 M</b>			

	Freq	Level	Read Level	Limit Line	Over Limit	Factor	Remark	Pol/Phase
	MHz	dBm/m	dBm	dBm/m	dB	dB/m		
1	1569.000	-44.98	-47.65	-13.00	-31.98	2.67	Peak	Vertical
2 PP	2353.500	-41.73	-48.65	-13.00	-28.73	6.92	Peak	Vertical

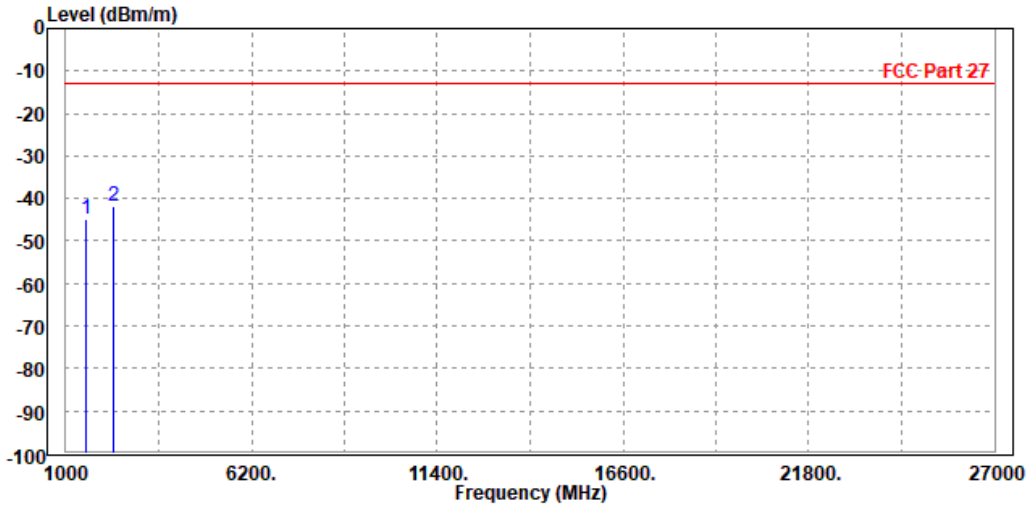



Test Report No.: RF200520W003-3

**CHANNEL BANDWIDTH: 10MHz / QPSK**

<b>MODE</b>	TX channel 23230	<b>FREQUENCY RANGE</b>	Above 1000MHz
<b>ENVIRONMENTAL CONDITIONS</b>	23deg. C, 70%RH	<b>INPUT POWER</b>	DC 5V
<b>TESTED BY</b>	Tony Xiong		
<b>ANTENNA POLARITY &amp; TEST DISTANCE: HORIZONTAL AT 3 M</b>			

	Freq	Level	Read Level	Limit Line	Over Limit	Factor	Remark	Pol/Phase
	MHz	dBm/m	dBm	dBm/m	dB	dB/m		
1	1572.000	-39.96	-42.28	-13.00	-26.96	2.32	Peak	Horizontal
2 PP	2346.000	-33.55	-41.45	-13.00	-20.55	7.90	Peak	Horizontal

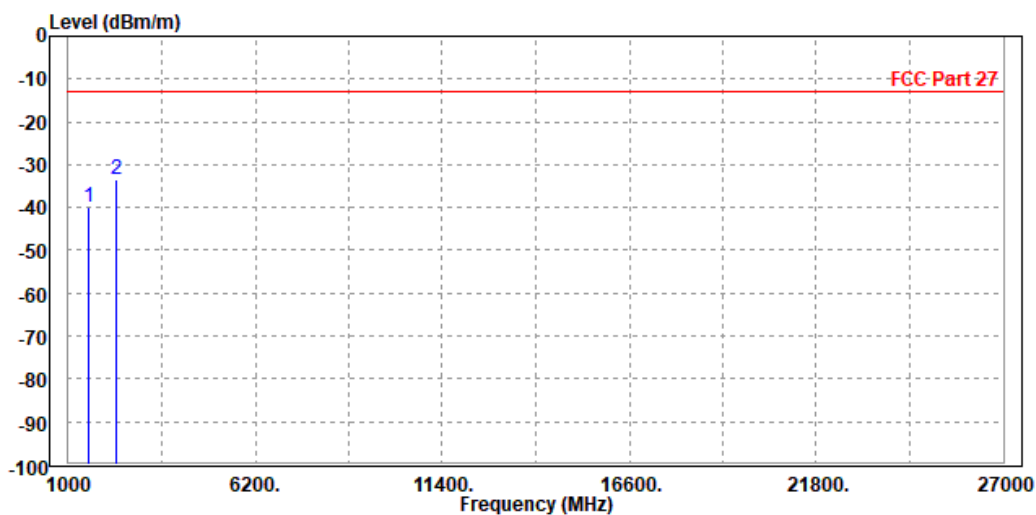



Test Report No.: RF200520W003-3

<b>MODE</b>	TX channel 23230	<b>FREQUENCY RANGE</b>	Above 1000MHz
<b>ENVIRONMENTAL CONDITIONS</b>	23deg. C, 70%RH	<b>INPUT POWER</b>	DC 5V
<b>TESTED BY</b>	Tony Xiong		
<b>ANTENNA POLARITY &amp; TEST DISTANCE: VERTICAL AT 3 M</b>			

	Freq	Level	Read Level	Limit Line	Over Limit	Factor	Remark	Pol/Phase
	MHz	dBm/m	dBm	dBm/m	dB	dB/m		
1	PP 1546.000	-42.40	-44.86	-13.00	-29.40	2.46	Peak	Vertical
2	2352.000	-43.27	-50.19	-13.00	-30.27	6.92	Peak	Vertical

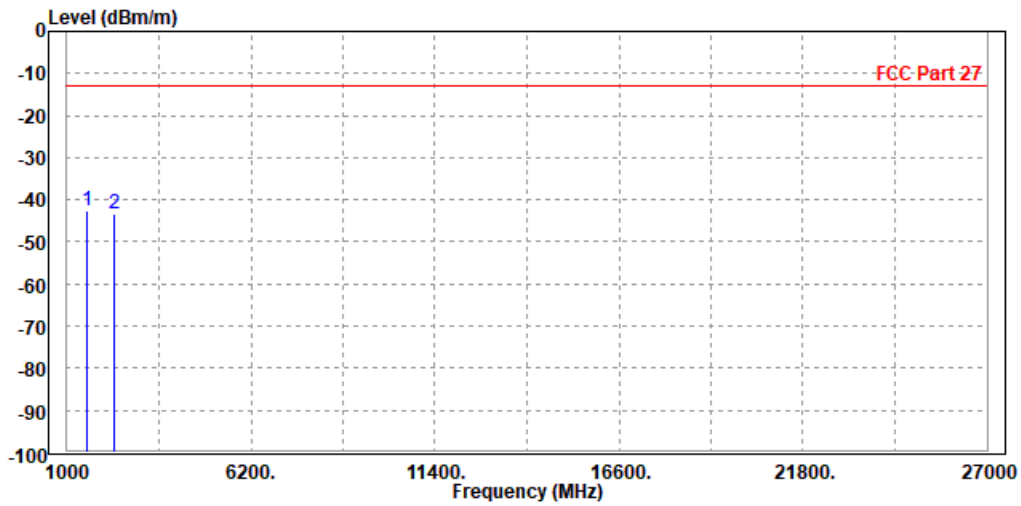



Test Report No.: RF200520W003-3

## 4 INFORMATION ON THE TESTING LABORATORIES

We, BV 7LAYERS COMMUNICATIONS TECHNOLOGY (SHENZHEN) CO. LTD., were founded in 2015 to provide our best service in EMC, Radio, Telecom and Safety consultation. Our laboratories are accredited and approved according to ISO/IEC 17025.

If you have any comments, please feel free to contact us at the following:

**Shenzhen EMC/RF Lab:**

Tel: +86-755-88696566

Fax: +86-755-88696577

**Email:** [customerservice.dg@cn.bureauveritas.com](mailto:customerservice.dg@cn.bureauveritas.com)

**Web Site:** [www.adt.com.tw](http://www.adt.com.tw)

The address and road map of all our labs can be found in our web site also.



Test Report No.: RF200520W003-3

## 5 APPENDIX A – MODIFICATIONS RECORDERS FOR ENGINEERING CHANGES TO THE EUT BY THE LAB

No modifications were made to the EUT by the lab during the test.

---END---