



BUREAU VERITAS

Test Report No.: RF200520W003-2



ACCREDITED

Certificate # 3939.01

FCC TEST REPORT (PART 24)

Applicant:	Particle Industries, Inc
Address:	126 Post St, 4th floor, San Francisco, CA 94108 USA

Manufacturer or Supplier	Particle Industries, Inc
Address	126 Post St, 4th floor, San Francisco, CA 94108 USA
Product	Tracker SoM LTE M1
Brand Name	Particle
Model Name	T402M/T404M
FCC ID	2AEMI-T40X
Date of tests	May. 21, 2020 ~ Jun. 09, 2020

The tests have been carried out according to the requirements of the following standard:

- FCC PART 24, Subpart E
- FCC PART 2
- ANSI/TIA/EIA-603-D
- ANSI/TIA/EIA-603-E
- ANSI C63.26-2015

CONCLUSION: The submitted sample was found to COMPLY with the test requirement

Prepared by Alex Chen
Engineer / Mobile Department

Approved by Luke Lu
Manager / Mobile Department

Date: Jun. 09, 2020

Date: Jun. 09, 2020

This report is governed by, and incorporates by reference, CPS Conditions of Service as posted at the date of issuance of this report at <http://www.bureauveritas.com/home/about-us/our-business/cps/about-us/terms-conditions> and is intended for your exclusive use. Any copying or replication of this report to or for any other person or entity, or use of our name or trademark, is permitted only with our prior written permission. This report sets forth our findings solely with respect to the test samples identified herein. The results set forth in this report are not indicative or representative of the quality or characteristics of the lot from which a test sample was taken or any similar or identical product unless specifically and expressly noted. Our report includes all of the tests requested by you and the results thereof based upon the information that you provided to us. Measurement uncertainty is only provided upon request for accredited tests. You have 60 days from date of issuance of this report to notify us of any material error or omission caused by our negligence or if you require measurement uncertainty; provided, however, that such notice shall be in writing and shall specifically address the issue you wish to raise. A failure to raise such issue within the prescribed time shall constitute your unqualified acceptance of the completeness of this report, the tests conducted and the correctness of the report contents.



TABLE OF CONTENTS

RELEASE CONTROL RECORD 4

1 SUMMARY OF TEST RESULTS 5

1.1 MEASUREMENT UNCERTAINTY 6

1.2 TEST SITE AND INSTRUMENTS 7

2 GENERAL INFORMATION 8

2.1 GENERAL DESCRIPTION OF EUT 8

2.2 CONFIGURATION OF SYSTEM UNDER TEST 12

2.3 DESCRIPTION OF SUPPORT UNITS 13

2.4 TEST ITEM AND TEST CONFIGURATION 13

2.5 EUT OPERATING CONDITIONS 14

2.6 GENERAL DESCRIPTION OF APPLIED STANDARDS 15

3 TEST TYPES AND RESULTS 16

3.1 OUTPUT POWER MEASUREMENT 16

3.1.1 LIMITS OF OUTPUT POWER MEASUREMENT 16

3.1.2 TEST PROCEDURES 16

3.1.3 TEST SETUP 17

3.1.4 TEST RESULTS 17

3.2 FREQUENCY STABILITY MEASUREMENT 31

3.2.1 LIMITS OF FREQUENCY STABILITY MEASUREMENT 31

3.2.2 TEST PROCEDURE 31

3.2.3 TEST SETUP 31

3.2.4 TEST RESULTS 32

3.3 OCCUPIED BANDWIDTH MEASUREMENT 33

3.3.1 TEST PROCEDURES 33

3.3.2 TEST SETUP 33

3.3.3 TEST RESULTS 33

3.4 BAND EDGE MEASUREMENT 34

3.4.1 LIMITS OF BAND EDGE MEASUREMENT 34

3.4.2 TEST SETUP 34

3.4.3 TEST PROCEDURES 35

3.4.4 TEST RESULTS 35

3.5 CONDUCTED SPURIOUS EMISSIONS 36

3.5.1 LIMITS OF CONDUCTED SPURIOUS EMISSIONS MEASUREMENT 36

3.5.2 TEST PROCEDURE 36

3.5.3 TEST SETUP 36

3.5.4 TEST RESULTS 36

3.6 RADIATED EMISSION MEASUREMENT 37

3.6.1 LIMITS OF RADIATED EMISSION MEASUREMENT 37

3.6.2 TEST PROCEDURES 37

3.6.3 DEVIATION FROM TEST STANDARD 37

3.6.4 TEST SETUP 38

3.6.5 TEST RESULTS 39

3.7 PEAK TO AVERAGE RATIO 85

3.7.1 LIMITS OF PEAK TO AVERAGE RATIO MEASUREMENT 85

3.7.2 TEST SETUP 85

3.7.3 TEST PROCEDURES 85

3.7.4 TEST RESULTS 85



4 INFORMATION ON THE TESTING LABORATORIES..... 86

5 APPENDIX A – MODIFICATIONS RECORDERS FOR ENGINEERING CHANGES TO THE EUT BY THE LAB 87



BUREAU
VERITAS

Test Report No.: RF200520W003-2

RELEASE CONTROL RECORD

ISSUE NO.	REASON FOR CHANGE	DATE ISSUED
RF200520W003-2	Original release	Jun. 09, 2020



1 SUMMARY OF TEST RESULTS

The EUT has been tested according to the following specifications:

APPLIED STANDARD: FCC Part 24 & Part 2		
STANDARD SECTION	TEST TYPE	RESULT
2.1046 24.232	Equivalent Isotropic Radiated Power	Compliance
2.1055 24.235	Frequency Stability	See Note
2.1049 24.238(b)	Occupied Bandwidth	See Note
24.232(d)	Peak to average ratio	See Note
24.238(b)	Band Edge Measurements	See Note
2.1051 24.238	Conducted Spurious Emissions	See Note
2.1053 24.238	Radiated Spurious Emissions	Compliance

Note: Test data re-use from certified module BG96, BG96 MINIPCIE, more details please refer test report R1811A0536-R2 (FCC ID: XMR201707BG96).



1.1 MEASUREMENT UNCERTAINTY

Where relevant, the following measurement uncertainty levels have been estimated for tests performed on the EUT as specified in CISPR 16-4-2:

MEASUREMENT	UNCERTAINTY
Frequency Stability	± 76.97Hz
Radiated emissions & Radiated Power (30MHz~1GMHz)	±4.98dB
Radiated emissions & Radiated Power (1GMHz ~6GMHz)	±4.70dB
Radiated emissions (6GMHz ~18GMHz)	±4.60dB
Radiated emissions (18GMHz ~40GMHz)	±4.12dB
Conducted emissions	±4.01dB
Occupied Channel Bandwidth	±43.58KHz
Conducted Output power	±2.06dB
Band Edge Measurements	±4.70dB
Peak to average ratio	±0.76dB

This uncertainty represents an expanded uncertainty expressed at approximately the 95% confidence level using a coverage factor of k=2.



1.2 TEST SITE AND INSTRUMENTS

Equipment	Manufacturer	Model No.	Serial No.	Last Cal.	Next Cal.
MXE EMI Receiver	KEYSIGHT	N9038A-544	MY54450026	Feb. 26,20	Feb. 25,21
EXA Signal Analyzer	KEYSIGHT	N9010A-544	MY54510355	Jun. 24,19	Jun. 23,20
Bilog Antenna	ETS-LINDGREN	3143B	00161965	Mar. 27,20	Mar. 26,21
Horn Antenna (1GHz-18GHz)	ETS-LINDGREN	3117	00168692	Mar. 27,20	Mar. 26,21
Horn Antenna (18GHz-40GHz)	N/A	QWH-SL-18-40-K-SG/QMS-00361	15433	Nov. 24,19	Nov. 23,20
Radio Communication Analyzer	ANRITSU	MT8820C	6201465426	Feb. 27,20	Feb. 26,21
Signal Pre-Amplifier	EMSI	EMC 9135	980249	Jun. 24,19	Jun. 23,20
Signal Pre-Amplifier	EMSI	EMC 012645B	980257	Jun. 24,19	Jun. 23,20
Signal Pre-Amplifier	EMSI	EMC 184045B	980259	Jun. 24,19	Jun. 23,20
3m Semi-anechoic Chamber	ETS-LINDGREN	9m*6m*6m	Euroshieldpn-CT0001143-1216	May. 18,20	May. 17,23
Test Software	E3	V 9.160323	N/A	N/A	N/A
Test Software	ADT	ADT_Radiated_V7.6.15.9.2	N/A	N/A	N/A
10dB Attenuator	JFW/USA	50HF-010-SMA	1505	Jun. 24,19	Jun. 23,20
Power Meter	Anritsu	ML2495A	1506002	Feb. 26,20	Feb. 25,21
Power Sensor	Anritsu	MA2411B	1339352	Feb. 26,20	Feb. 25,21
Humid & Temp Programmable Tester	Juyi	ITH-120-45-CP-AR	IAA1504-001	Jun. 24,19	Jun. 23,20
MXG Analog Microwave Signal Generator	KEYSIGHT	N5183A	MY50143024	Mar. 11,20	Mar. 10,21
Power Divider	MCLI/USA	PS2-15	24880	Nov. 22, 19	Nov. 21, 20

- NOTE:**
1. The calibration interval of the above test instruments is 12 months or 36 months and the calibrations are traceable to CEPREI/CHINA, GRGT/CHINA and NIM/CHINA.
 2. The test was performed in 3m Semi-anechoic Chamber and RF Oven Room.
 3. The horn antenna is used only for the measurement of emission frequency above 1GHz if tested.
 4. The FCC Site Registration No. is 525120; The Designation No. is CN1171.



2 GENERAL INFORMATION

2.1 GENERAL DESCRIPTION OF EUT

PRODUCT	Tracker SoM LTE M1	
BRAND NAME	Particle	
MODEL NAME	T402M/T404M	
POWER SUPPLY	Li+ PIN: DC +3.3V--4.3V or Vusb PIN: DC +4.35V--5.5V or Vin PIN: DC +3.9V--17V	
MODULATION TYPE	GSM, GPRS: GMSK EDGE:8PSK LTE CAT-M1: QPSK, 16QAM	
FREQUENCY RANGE	GSM, GPRS, EDGE	1850.2MHz ~ 1909.8MHz
	LTE Band 2 Channel Bandwidth: 1.4MHz	1850.7MHz ~ 1909.3MHz
	LTE Band 2 Channel Bandwidth: 3MHz	1851.5MHz ~ 1908.5MHz
	LTE Band 2 Channel Bandwidth: 5MHz	1852.5MHz ~ 1907.5MHz
	LTE Band 2 Channel Bandwidth: 10MHz	1855.0MHz ~ 1905.0MHz
	LTE Band 2 Channel Bandwidth: 15MHz	1857.5MHz ~ 1902.5MHz
	LTE Band 2 Channel Bandwidth: 20MHz	1860.0MHz ~ 1900.0MHz
	LTE Band 25 Channel Bandwidth: 1.4MHz	1850.7MHz ~ 1914.3MHz
	LTE Band 25 Channel Bandwidth: 3MHz	1851.5MHz ~ 1913.5MHz
	LTE Band 25 Channel Bandwidth: 5MHz	1852.5MHz ~ 1912.5MHz
	LTE Band 25 Channel Bandwidth: 10MHz	1855.0MHz ~ 1910.0MHz
	LTE Band 25 Channel Bandwidth: 15MHz	1857.5MHz ~ 1907.5MHz
	LTE Band 25 Channel Bandwidth: 20MHz	1860.0MHz ~ 1905.0MHz
	MAX. EIRP POWER	GSM
EDGE		800mW
LTE Band 2 Channel Bandwidth: 1.4MHz		562mW
LTE Band 2 Channel Bandwidth: 3MHz		581mW



	LTE Band 2 Channel Bandwidth: 5MHz	577mW
	LTE Band 2 Channel Bandwidth: 10MHz	579mW
	LTE Band 2 Channel Bandwidth: 15MHz	577mW
	LTE Band 2 Channel Bandwidth: 20MHz	570mW
	LTE Band 25 Channel Bandwidth: 1.4MHz	612mW
	LTE Band 25 Channel Bandwidth: 3MHz	615mW
	LTE Band 25 Channel Bandwidth: 5MHz	675mW
	LTE Band 25 Channel Bandwidth: 10MHz	676mW
	LTE Band 25 Channel Bandwidth: 15MHz	671mW
	LTE Band 25 Channel Bandwidth: 20MHz	659mW
	EMISSION DESIGNATOR	GSM
EDGE		248KG7W
LTE Band 2 Channel Bandwidth: 1.4MHz		QPSK: 1M11G7D 16QAM: 948KW7D
LTE Band 2 Channel Bandwidth: 3MHz		QPSK: 1M16G7D 16QAM: 985KW7D
LTE Band 2 Channel Bandwidth: 5MHz		QPSK: 1M17G7D 16QAM: 1M01W7D
LTE Band 2 Channel Bandwidth: 10MHz		QPSK: 1M19G7D 16QAM: 1M19W7D
LTE Band 2 Channel Bandwidth: 15MHz		QPSK: 1M22G7D 16QAM: 1M90W7D
LTE Band 2 Channel Bandwidth: 20MHz		QPSK: 1M25G7D 16QAM: 1M15W7D



EMISSION DESIGNATOR	LTE Band 25 Channel Bandwidth: 1.4MHz	QPSK: 1M11G7D 16QAM: 951KW7D
	LTE Band 25 Channel Bandwidth: 3MHz	QPSK: 1M16G7D 16QAM: 992KW7D
	LTE Band 25 Channel Bandwidth: 5MHz	QPSK: 1M14G7D 16QAM: 975KW7D
	LTE Band 25 Channel Bandwidth: 10MHz	QPSK: 1M18G7D 16QAM: 1M05W7D
	LTE Band 25 Channel Bandwidth: 15MHz	QPSK: 1M20G7D 16QAM: 1M06W7D
	LTE Band 25 Channel Bandwidth: 20MHz	QPSK: 1M21G7D 16QAM: 1M11W7D
ANTENNA TYPE	External Antenna with 3.77dBi gain for GSM 1900/LTE Band 2/LTE Band 25	
HW VERSION	V1.0	
SW VERSION	V1.5.4	
I/O PORTS	Refer to user's manual	
CABLE SUPPLIED	N/A	



NOTE:

1. For a more detailed features description, please refer to the manufacturer's specifications or the user's manual.
2. The schematic and PCB of the two models T402M and T404M used by our company for the certification is completely the same ,and the HW&SW used is the same. Because the product is sold in different market using different models eSIM, different models are named. the differences are as follows:T402M uses eSIM of Kore.T404M uses eSIM of Twilio.
3. The EUT incorporates a SISO function. Physically, the EUT provides one completed transmitter and one receiver.

MODULATION MODE	TX FUNCTION
GSM/GPRS/EDGE	1TX/1RX diversity
LTE	1TX/1RX diversity

4. For the test results, the EUT had been tested with all conditions. But only the worst case was shown in test report.



2.2 CONFIGURATION OF SYSTEM UNDER TEST

FOR RADIATION EMISSION

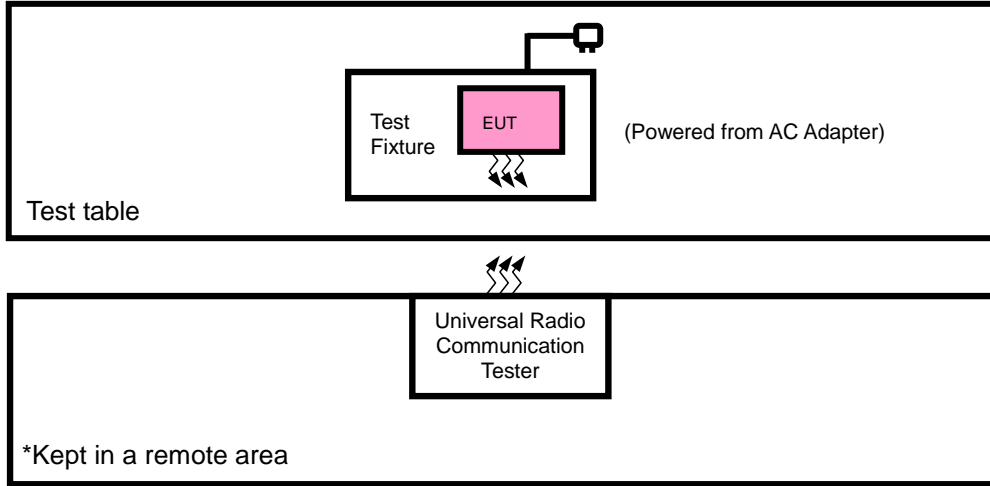



2.3 DESCRIPTION OF SUPPORT UNITS

The EUT has been tested as an independent unit together with other necessary accessories or support units. The following support units or accessories were used to form a representative test configuration during the tests.

NO.	PRODUCT	BRAND	MODEL NO.	SERIAL NO.	FCC ID
1	DC source	LONG WEI	PS-6403D	010934269	N/A

NO.	SIGNAL CABLE DESCRIPTION OF THE ABOVE SUPPORT UNITS
1	DC Line: Unshielded, Detachable 1.8m

2.4 TEST ITEM AND TEST CONFIGURATION

Pre-Scan has been conducted to determine the worst-case mode from all possible combinations between available modulations, data rates, XYZ axis and antenna ports

The worst case in EIRP and radiated emission was found when positioned on X-plane for GSM/EDGE / LTE. Following channel(s) was (were) selected for the final test as listed below:

EUT CONFIGURE MODE	DESCRIPTION
-	EUT + with GSM/EDGE or LTE link
-	EUT + with GSM/EDGE or LTE link

GSM MODE

TEST ITEM	AVAILABLE CHANNEL	TESTED CHANNEL	MODE
EIRP	512 to 810	512, 661, 810	GSM, EDGE
RADIATED EMISSION	512 to 810	512, 661, 810	GSM, EDGE

**LTE BAND 2**

TEST ITEM	AVAILABLE CHANNEL	TESTED CHANNEL	CHANNEL BANDWIDTH	MODULATION	MODE
EIRP	18607 to 19193	18607, 18900, 19193	1.4MHz	QPSK,16QAM	1 RB / 0 RB Offset
	18615 to 19185	18615, 18900, 19185	3MHz	QPSK,16QAM	1 RB / 0 RB Offset
	18625 to 19175	18625, 18900, 19175	5MHz	QPSK,16QAM	1 RB / 0 RB Offset
	18650 to 19150	18650, 18900, 19150	10MHz	QPSK,16QAM	1 RB / 0 RB Offset
	18675 to 19125	18675, 18900, 19125	15MHz	QPSK,16QAM	1 RB / 0 RB Offset
	18700 to 19100	18700, 18900, 19100	20MHz	QPSK,16QAM	1 RB / 0 RB Offset
RADIATED EMISSION	18607 to 19193	18900	1.4MHz	QPSK	1 RB / 0 RB Offset
	18615 to 19185	18900	3MHz	QPSK	1 RB / 0 RB Offset
	18625 to 19175	18900	5MHz	QPSK	1 RB / 0 RB Offset
	18650 to 19150	18900	10MHz	QPSK	1 RB / 0 RB Offset
	18675 to 19125	18675, 18900, 19125	15MHz	QPSK	1 RB / 0 RB Offset
	18700 to 19100	18900	20MHz	QPSK	1 RB / 0 RB Offset

LTE BAND 25

TEST ITEM	AVAILABLE CHANNEL	TESTED CHANNEL	CHANNEL BANDWIDTH	MODULATION	MODE
EIRP	26047 to 26683	26047, 26365, 26683	1.4MHz	QPSK,16QAM	2 RB / 0 RB Offset
	26055 to 26675	26055, 26365, 26675	3MHz	QPSK,16QAM	2 RB / 0 RB Offset
	26065 to 26665	26065, 26365, 26665	5MHz	QPSK,16QAM	2 RB / 0 RB Offset
	26090 to 26640	26090, 26365, 26640	10MHz	QPSK,16QAM	2 RB / 0 RB Offset
	26115 to 26615	26115, 26365, 26615	15MHz	QPSK,16QAM	2 RB / 0 RB Offset
	26140 to 26590	26140, 26365, 26590	20MHz	QPSK,16QAM	2 RB / 0 RB Offset
RADIATED EMISSION	26047 to 26683	26365	1.4MHz	QPSK	2 RB / 0 RB Offset
	26055 to 26675	26055, 26365, 26675	3MHz	QPSK	2 RB / 0 RB Offset
	26065 to 26665	26365	5MHz	QPSK	2 RB / 0 RB Offset
	26090 to 26640	26365	10MHz	QPSK	2 RB / 0 RB Offset
	26115 to 26615	26365	15MHz	QPSK	2 RB / 0 RB Offset
	26140 to 26590	26365	20MHz	QPSK	2 RB / 0 RB Offset

TEST CONDITION:

TEST ITEM	ENVIRONMENTAL CONDITIONS	INPUT POWER	TESTED BY
EIRP	25deg. C, 57%RH	DC 5V	Tony
RADIATED EMISSION	23deg. C, 70%RH	DC 5V	Tony

2.5 EUT OPERATING CONDITIONS

The EUT makes a call to the communication simulator. The communication simulator station system controlled a EUT to export maximum output power under transmission mode and specific channel frequency



2.6 GENERAL DESCRIPTION OF APPLIED STANDARDS

The EUT is a RF product. According to the specifications of the manufacturer, it must comply with the requirements of the following standards:

FCC 47 CFR Part 2

FCC 47 CFR Part 24

KDB 971168 D01 Power Meas License Digital Systems v03r01

ANSI/TIA/EIA-603-D

ANSI/TIA/EIA-603-E

ANSI C63.26-2015

NOTE: All test items have been performed and recorded as per the above standards.



3 TEST TYPES AND RESULTS

3.1 OUTPUT POWER MEASUREMENT

3.1.1 LIMITS OF OUTPUT POWER MEASUREMENT

Mobile and portable stations are limited to 2 watts EIRP.

3.1.2 TEST PROCEDURES

EIRP MEASUREMENT:

Per KDB 971168 D01 Power Meas License Digital Systems v03r01 or subclause 5.2.5.5 of ANSI C63.26-2015, the relevant equation for determining the ERP or EIRP from the conducted RF output power measured using the guidance provided above is:

$$\text{ERP or EIRP} = P_{\text{Meas}} + G_{\text{T}} - L_{\text{C}}$$

Where:

ERP or EIRP = effective radiated power or equivalent isotropically radiated power, respectively

(expressed in the same units as P_{Meas} , typically dBW or dBm);

P_{Meas} = measured transmitter output power or PSD, in dBm or dBW;

G_{T} = gain of the transmitting antenna, in dBd (ERP) or dBi (EIRP);

L_{C} = signal attenuation in the connecting cable between the transmitter and antenna, in dB.

CONDUCTED POWER MEASUREMENT:

The EUT was set up for the maximum power with WCDMA link data modulation and link up with simulator. Set the EUT to transmit under low, middle and high channel and record the power level shown on simulator.



3.1.3 TEST SETUP

EIRP / ERP Measurement:

CONDUCTED POWER MEASUREMENT:



3.1.4 TEST RESULTS

CONDUCTED OUTPUT POWER (dBm)

Band Channel	GSM1900			GSM1900 Max. Tune-up Power
	512 1850.2	661 1880	810 1909.8	
Frequency				
GPRS (GMSK, 1Tx-slot)	29.81	29.85	29.95	30.0
GPRS (GMSK, 2Tx-slot)	29.71	29.66	29.82	30.0
GPRS (GMSK, 3Tx-slot)	29.62	29.62	29.72	30.0
GPRS (GMSK, 4Tx-slot)	29.46	29.45	29.56	30.0
EDGE (GMSK, 1Tx-slot)	25.18	25.00	25.26	25.5
EDGE (GMSK, 2Tx-slot)	25.03	24.89	25.10	25.5
EDGE (GMSK, 3Tx-slot)	24.96	24.73	24.94	25.0
EDGE (GMSK, 4Tx-slot)	24.74	24.43	24.78	25.0



LTE Band 2

Band/BW	Modulation	RB Size	RB Offset	Low CH 18607	Mid CH 18900	High CH 19193	Tune Up
				Frequency 1850.7 MHz	Frequency 1880 MHz	Frequency 1909.3 MHz	
2/ 1.4	QPSK	1	0	23.32	23.25	23.33	23.5
		1	5	23.38	23.16	23.37	
		3	0	23.41	23.27	23.36	23.5
		3	3	23.32	23.18	23.34	
		6	0	23.33	23.31	23.24	23.5
	16QAM	1	0	22.75	22.75	22.73	23.5
		1	5	22.81	22.76	22.79	
		3	0	23.14	23.03	23.16	23.5
		3	3	23.18	23.09	23.15	
		6	0	23.28	23.31	23.29	23.5

Band/BW	Modulation	RB Size	RB Offset	Low CH 18615	Mid CH 18900	High CH 19185	Tune Up
				Frequency 1851.5 MHz	Frequency 1880 MHz	Frequency 1908.5 MHz	
2/ 3	QPSK	1	0	23.34	23.27	23.32	23.5
		1	5	23.34	23.17	23.37	
		3	0	23.37	23.27	23.36	23.5
		3	3	23.31	23.21	23.34	
		6	0	23.26	23.31	23.26	23.5
	16QAM	1	0	22.72	22.81	22.76	23.5
		1	5	22.78	22.79	22.77	
		3	0	23.17	23.03	23.16	23.5
		3	3	23.14	23.10	23.15	
		6	0	23.33	23.26	23.32	23.5



Band/BW	Modulation	RB Size	RB Offset	Low CH 18625	Mid CH 18900	High CH 19175	Tune Up
				Frequency 1852.5 MHz	Frequency 1880 MHz	Frequency 1907.5 MHz	
2/ 5	QPSK	1	0	23.35	23.22	23.33	23.5
		1	5	23.39	23.14	23.37	
		3	0	23.38	23.26	23.40	23.5
		3	3	23.34	23.21	23.31	
		6	0	23.26	23.32	23.27	23.5
	16QAM	1	0	22.73	22.77	22.76	23.5
		1	5	22.75	22.82	22.76	
		3	0	23.17	23.03	23.15	23.5
		3	3	23.14	23.08	23.12	
		6	0	23.30	23.30	23.28	23.5

Band/BW	Modulation	RB Size	RB Offset	Low CH 18650	Mid CH 18900	High CH 19150	Tune Up
				Frequency 1855 MHz	Frequency 1880 MHz	Frequency 1905 MHz	
2/ 10	QPSK	1	0	23.32	23.25	23.33	23.5
		1	5	23.39	23.14	23.38	
		3	0	23.35	23.30	23.36	23.5
		3	3	23.35	23.20	23.34	
		6	0	23.32	23.26	23.27	23.5
	16QAM	1	0	22.73	22.74	22.72	23.5
		1	5	22.80	22.78	22.79	
		3	0	23.17	23.04	23.12	23.5
		3	3	23.16	23.06	23.18	
		6	0	23.34	23.24	23.33	23.5



Band/BW	Modulation	RB Size	RB Offset	Low CH 18675	Mid CH 18900	High CH 19125	Tune Up
				Frequency 1857.5 MHz	Frequency 1880 MHz	Frequency 1902.5 MHz	
2/ 15	QPSK	1	0	23.39	23.25	23.30	23.5
		1	5	23.37	23.19	23.33	
		3	0	23.41	23.33	23.37	23.5
		3	3	23.32	23.21	23.35	
		6	0	23.33	23.31	23.27	23.5
	16QAM	1	0	22.77	22.81	22.72	23.5
		1	5	22.79	22.79	22.79	
		3	0	23.13	23.09	23.14	23.5
		3	3	23.20	23.06	23.19	
		6	0	23.28	23.28	23.29	23.5

Band/BW	Modulation	RB Size	RB Offset	Low CH 18700	Mid CH 18900	High CH 19100	Tune Up
				Frequency 1860 MHz	Frequency 1880 MHz	Frequency 1900 MHz	
2/ 20	QPSK	1	0	23.40	23.29	23.38	23.5
		1	5	23.41	23.22	23.39	
		3	0	23.43	23.34	23.41	23.5
		3	3	23.38	23.26	23.36	
		6	0	23.34	23.33	23.32	23.5
	16QAM	1	0	22.80	22.82	22.78	23.5
		1	5	22.83	22.84	22.81	
		3	0	23.19	23.11	23.17	23.5
		3	3	23.22	23.14	23.20	
		6	0	23.36	23.32	23.34	23.5



LTE Band 25

Band/BW	Modulation	RB Size	RB Offset	Low CH 26047	Mid CH 26365	High CH 26683	Tune Up
				Frequency 1850.7 MHz	Frequency 1882.5 MHz	Frequency 1914.3 MHz	
25/ 1.4	QPSK	1	0	23.85	23.86	24.03	24.5
		1	5	23.83	23.77	23.99	
		3	0	23.88	23.80	24.00	24.5
		3	3	23.78	23.73	23.97	
		6	0	23.91	23.87	23.99	24.5
	16QAM	1	0	23.25	23.20	23.40	24.5
		1	5	23.26	23.17	23.41	
		3	0	23.56	23.50	23.75	24.5
		3	3	23.52	23.48	23.66	
		6	0	23.78	23.82	23.96	24.5

Band/BW	Modulation	RB Size	RB Offset	Low CH 26055	Mid CH 26365	High CH 26675	Tune Up
				Frequency 1851.5 MHz	Frequency 1882.5 MHz	Frequency 1913.5 MHz	
25/ 3	QPSK	1	0	23.87	23.88	24.02	24.5
		1	5	23.79	23.78	23.99	
		3	0	23.84	23.80	24.00	24.5
		3	3	23.77	23.76	23.97	
		6	0	23.84	23.87	24.01	24.5
	16QAM	1	0	23.22	23.26	23.43	24.5
		1	5	23.23	23.20	23.39	
		3	0	23.59	23.50	23.75	24.5
		3	3	23.48	23.49	23.66	
		6	0	23.83	23.77	23.99	24.5



Band/BW	Modulation	RB Size	RB Offset	Low CH 26065	Mid CH 26365	High CH 26665	Tune Up
				Frequency 1852.5 MHz	Frequency 1882.5 MHz	Frequency 1912.5 MHz	
25/ 5	QPSK	1	0	23.88	23.83	24.03	24.5
		1	5	23.84	23.75	23.99	
		3	0	23.85	23.79	24.04	24.5
		3	3	23.80	23.76	23.94	
		6	0	23.84	23.88	24.02	24.5
	16QAM	1	0	23.23	23.22	23.43	24.5
		1	5	23.20	23.23	23.38	
		3	0	23.59	23.50	23.74	24.5
		3	3	23.48	23.47	23.63	
		6	0	23.80	23.81	23.95	24.5

Band/BW	Modulation	RB Size	RB Offset	Low CH 26090	Mid CH 26365	High CH 26640	Tune Up
				Frequency 1855 MHz	Frequency 1882.5 MHz	Frequency 1910 MHz	
25/ 10	QPSK	1	0	23.85	23.86	24.03	24.5
		1	5	23.84	23.75	24.00	
		3	0	23.82	23.83	24.00	24.5
		3	3	23.81	23.75	23.97	
		6	0	23.90	23.82	24.02	24.5
	16QAM	1	0	23.23	23.19	23.39	24.5
		1	5	23.25	23.19	23.41	
		3	0	23.59	23.51	23.71	24.5
		3	3	23.50	23.45	23.69	
		6	0	23.84	23.75	24.00	24.5



Band/BW	Modulation	RB Size	RB Offset	Low CH 26115	Mid CH 26365	High CH 26615	Tune Up
				Frequency 1857.5 MHz	Frequency 1882.5 MHz	Frequency 1907.5 MHz	
25/ 15	QPSK	1	0	23.92	23.86	24.00	24.5
		1	5	23.82	23.80	23.95	
		3	0	23.88	23.86	24.01	24.5
		3	3	23.78	23.76	23.98	
		6	0	23.91	23.87	24.02	24.5
	16QAM	1	0	23.27	23.26	23.39	24.5
		1	5	23.24	23.20	23.41	
		3	0	23.55	23.56	23.73	24.5
		3	3	23.54	23.45	23.70	
		6	0	23.78	23.79	23.96	24.5

Band/BW	Modulation	RB Size	RB Offset	Low CH 26140	Mid CH 26365	High CH 26590	Tune Up
				Frequency 1860 MHz	Frequency 1882.5 MHz	Frequency 1905 MHz	
25/ 20	QPSK	1	0	23.93	23.90	24.08	24.5
		1	5	23.86	23.83	24.01	
		3	0	23.90	23.87	24.05	24.5
		3	3	23.84	23.81	23.99	
		6	0	23.92	23.89	24.07	24.5
	16QAM	1	0	23.30	23.27	23.45	24.5
		1	5	23.28	23.25	23.43	
		3	0	23.61	23.58	23.76	24.5
		3	3	23.56	23.53	23.71	
		6	0	23.86	23.83	24.01	24.5



EIRP POWER (dBm)

GSM 1900

Channel	Frequency (MHz)	Conducted Power (dBm)	G _T -L _c (dB)	EIRP (dBm)	EIRP (mW)	Limit (W)
512	1850.2	29.81	3.77	33.58	2280.34	2
661	1880.0	29.85	3.77	33.62	2301.44	2
810	1909.8	29.95	3.77	33.72	2355.05	2

EDGE 1900

Channel	Frequency (MHz)	Conducted Power (dBm)	G _T -L _c (dB)	EIRP (dBm)	EIRP (mW)	Limit (W)
512	1850.2	25.18	3.77	28.95	785.24	2
661	1880.0	25.00	3.77	28.77	753.36	2
810	1909.8	25.26	3.77	29.03	799.83	2

LTE BAND 2

CHANNEL BANDWIDTH: 1.4MHz QPSK

Channel	Frequency (MHz)	Conducted Power (dBm)	G _T -L _c (dB)	EIRP (dBm)	EIRP (mW)	Limit (W)
18607	1850.7	23.42	3.77	27.19	523.60	2
18900	1880.0	23.55	3.77	27.32	539.51	2
19193	1908.3	23.73	3.77	27.50	562.34	2

CHANNEL BANDWIDTH: 1.4MHz 16QAM

Channel	Frequency (MHz)	Conducted Power (dBm)	G _T -L _c (dB)	EIRP (dBm)	EIRP (mW)	Limit (W)
18607	1850.7	22.53	3.77	26.30	426.58	2
18900	1880.0	22.53	3.77	26.30	426.58	2
19193	1908.3	22.49	3.77	26.26	422.67	2



CHANNEL BANDWIDTH: 3MHz QPSK

Channel	Frequency (MHz)	Conducted Power (dBm)	G _T -L _c (dB)	EIRP (dBm)	EIRP (mW)	Limit (W)
18615	1851.5	23.84	3.77	27.61	576.77	2
18900	1880.0	23.59	3.77	27.36	544.5	2
19185	1908.5	23.76	3.77	27.53	566.24	2

CHANNEL BANDWIDTH: 3MHz 16QAM

Channel	Frequency (MHz)	Conducted Power (dBm)	G _T -L _c (dB)	EIRP (dBm)	EIRP (mW)	Limit (W)
18615	1851.5	23.83	3.77	27.60	575.44	2
18900	1880.0	23.85	3.77	27.62	578.1	2
19185	1908.5	23.87	3.77	27.64	580.76	2

CHANNEL BANDWIDTH: 5MHz QPSK

Channel	Frequency (MHz)	Conducted Power (dBm)	G _T -L _c (dB)	EIRP (dBm)	EIRP (mW)	Limit (W)
18625	1852.5	23.43	3.77	27.20	524.81	2
18900	1880.0	23.58	3.77	27.35	543.25	2
19175	1907.5	23.72	3.77	27.49	561.05	2

CHANNEL BANDWIDTH: 5MHz 16QAM

Channel	Frequency (MHz)	Conducted Power (dBm)	G _T -L _c (dB)	EIRP (dBm)	EIRP (mW)	Limit (W)
18625	1852.5	23.80	3.77	27.57	571.48	2
18900	1880.0	23.81	3.77	27.58	572.8	2
19175	1907.5	23.84	3.77	27.61	576.77	2



CHANNEL BANDWIDTH: 10MHz QPSK

Channel	Frequency (MHz)	Conducted Power (dBm)	G _T -L _c (dB)	EIRP (dBm)	EIRP (mW)	Limit (W)
18650	1855.0	23.51	3.77	27.28	534.56	2
18900	1880.0	23.60	3.77	27.37	545.76	2
19150	1905.0	23.75	3.77	27.52	564.94	2

CHANNEL BANDWIDTH: 10MHz 16QAM

Channel	Frequency (MHz)	Conducted Power (dBm)	G _T -L _c (dB)	EIRP (dBm)	EIRP (mW)	Limit (W)
18650	1855.0	23.82	3.77	27.59	574.12	2
18900	1880.0	23.84	3.77	27.61	576.77	2
19150	1905.0	23.86	3.77	27.63	579.43	2

CHANNEL BANDWIDTH: 15MHz QPSK

Channel	Frequency (MHz)	Conducted Power (dBm)	G _T -L _c (dB)	EIRP (dBm)	EIRP (mW)	Limit (W)
18675	1857.5	23.49	3.77	27.26	532.11	2
18900	1880.0	23.56	3.77	27.33	540.75	2
19125	1902.5	23.73	3.77	27.50	562.34	2

CHANNEL BANDWIDTH: 15MHz 16QAM

Channel	Frequency (MHz)	Conducted Power (dBm)	G _T -L _c (dB)	EIRP (dBm)	EIRP (mW)	Limit (W)
18675	1857.5	23.77	3.77	27.54	567.54	2
18900	1880.0	23.82	3.77	27.59	574.12	2
19125	1902.5	23.84	3.77	27.61	576.77	2



CHANNEL BANDWIDTH: 20MHz QPSK

Channel	Frequency (MHz)	Conducted Power (dBm)	G _T -L _c (dB)	EIRP (dBm)	EIRP (mW)	Limit (W)
18675	1857.5	23.46	3.77	27.23	528.45	2
18900	1880.0	23.51	3.77	27.28	534.56	2
19125	1902.5	23.70	3.77	27.47	558.47	2

CHANNEL BANDWIDTH: 20MHz 16QAM

Channel	Frequency (MHz)	Conducted Power (dBm)	G _T -L _c (dB)	EIRP (dBm)	EIRP (mW)	Limit (W)
18675	1857.5	23.75	3.77	27.52	564.94	2
18900	1880.0	23.78	3.77	27.55	568.85	2
19125	1902.5	23.79	3.77	27.56	570.16	2



LTE BAND 25

CHANNEL BANDWIDTH: 1.4MHz QPSK

Channel	Frequency (MHz)	Conducted Power (dBm)	G _T -L _C (dB)	EIRP (dBm)	EIRP (mW)	Limit (W)
26047	1850.7	23.53	3.77	27.30	537.03	2
26340	1880.0	24.10	3.77	27.87	612.35	2
26683	1914.3	23.62	3.77	27.39	548.28	2

CHANNEL BANDWIDTH: 1.4MHz 16QAM

Channel	Frequency (MHz)	Conducted Power (dBm)	G _T -L _C (dB)	EIRP (dBm)	EIRP (mW)	Limit (W)
26047	1850.7	24.08	3.77	27.85	609.54	2
26340	1880.0	23.94	3.77	27.71	590.2	2
26683	1914.3	23.98	3.77	27.75	595.66	2

CHANNEL BANDWIDTH: 3MHz QPSK

Channel	Frequency (MHz)	Conducted Power (dBm)	G _T -L _C (dB)	EIRP (dBm)	EIRP (mW)	Limit (W)
26055	1851.5	23.63	3.77	27.40	549.54	2
26340	1880.0	23.79	3.77	27.56	570.16	2
26675	1913.5	24.02	3.77	27.79	601.17	2

CHANNEL BANDWIDTH: 3MHz 16QAM

Channel	Frequency (MHz)	Conducted Power (dBm)	G _T -L _C (dB)	EIRP (dBm)	EIRP (mW)	Limit (W)
26055	1851.5	23.88	3.77	27.65	582.1	2
26340	1880.0	24.00	3.77	27.77	598.41	2
26675	1913.5	24.12	3.77	27.89	615.18	2



CHANNEL BANDWIDTH: 5MHz QPSK

Channel	Frequency (MHz)	Conducted Power (dBm)	G _T -L _c (dB)	EIRP (dBm)	EIRP (mW)	Limit (W)
26065	1852.5	23.77	3.77	27.54	567.54	2
26340	1880.0	23.69	3.77	27.46	557.19	2
26665	1912.5	23.76	3.77	27.53	566.24	2

CHANNEL BANDWIDTH: 5MHz 16QAM

Channel	Frequency (MHz)	Conducted Power (dBm)	G _T -L _c (dB)	EIRP (dBm)	EIRP (mW)	Limit (W)
26065	1852.5	24.17	3.77	27.94	622.3	2
26340	1880.0	24.24	3.77	28.01	632.41	2
26665	1912.5	24.52	3.77	28.29	674.53	2

CHANNEL BANDWIDTH: 10MHz QPSK

Channel	Frequency (MHz)	Conducted Power (dBm)	G _T -L _c (dB)	EIRP (dBm)	EIRP (mW)	Limit (W)
26090	1855.0	24.00	3.77	27.77	598.41	2
26340	1880.0	23.66	3.77	27.43	553.35	2
26640	1910.0	23.85	3.77	27.62	578.10	2

CHANNEL BANDWIDTH: 10MHz 16QAM

Channel	Frequency (MHz)	Conducted Power (dBm)	G _T -L _c (dB)	EIRP (dBm)	EIRP (mW)	Limit (W)
26090	1855.0	24.37	3.77	28.14	651.63	2
26340	1880.0	24.41	3.77	28.18	657.66	2
26640	1910.0	24.53	3.77	28.30	676.08	2



CHANNEL BANDWIDTH: 15MHz QPSK

Channel	Frequency (MHz)	Conducted Power (dBm)	G _T -L _c (dB)	EIRP (dBm)	EIRP (mW)	Limit (W)
26115	1857.5	23.85	3.77	27.62	578.10	2
26340	1880.0	23.68	3.77	27.45	555.90	2
26615	1907.5	23.81	3.77	27.58	572.80	2

CHANNEL BANDWIDTH: 15MHz 16QAM

Channel	Frequency (MHz)	Conducted Power (dBm)	G _T -L _c (dB)	EIRP (dBm)	EIRP (mW)	Limit (W)
26115	1857.5	24.09	3.77	27.86	610.94	2
26340	1880.0	24.41	3.77	28.18	657.66	2
26615	1907.5	24.50	3.77	28.27	671.43	2

CHANNEL BANDWIDTH: 20MHz QPSK

Channel	Frequency (MHz)	Conducted Power (dBm)	G _T -L _c (dB)	EIRP (dBm)	EIRP (mW)	Limit (W)
26140	1860.0	23.81	3.77	27.58	572.8	2
26340	1880.0	23.78	3.77	27.55	568.85	2
26590	1905.0	23.99	3.77	27.76	597.04	2

CHANNEL BANDWIDTH: 20MHz 16QAM

Channel	Frequency (MHz)	Conducted Power (dBm)	G _T -L _c (dB)	EIRP (dBm)	EIRP (mW)	Limit (W)
26140	1860.0	23.80	3.77	27.57	571.48	2
26340	1880.0	24.42	3.77	28.19	659.17	2
26590	1905.0	24.28	3.77	28.05	638.26	2



3.2 FREQUENCY STABILITY MEASUREMENT

3.2.1 LIMITS OF FREQUENCY STABILITY MEASUREMENT

The frequency stability shall be sufficient to ensure that the fundamental emission stays within the authorized frequency block.

3.2.2 TEST PROCEDURE

- a. Device is placed at the oven room. The oven room could control the temperatures and humidity. Power warm up is at least 15 min and power applied should perform before recording frequency error.
- b. EUT is connected the external power supply to control the DC input power. The test voltage range is from minimum to maximum working voltage. Each step shall be record the frequency error rate.
- c. The temperature range step is 10 degrees in this test items. All temperature levels shall be hold the $\pm 0.5^{\circ}\text{C}$ during the measurement testing. The each temperature step shall be at least 0.5 hours, consider the EUT could be test under the stability condition.

NOTE: The frequency error was recorded frequency error from the communication simulator.

3.2.3 TEST SETUP

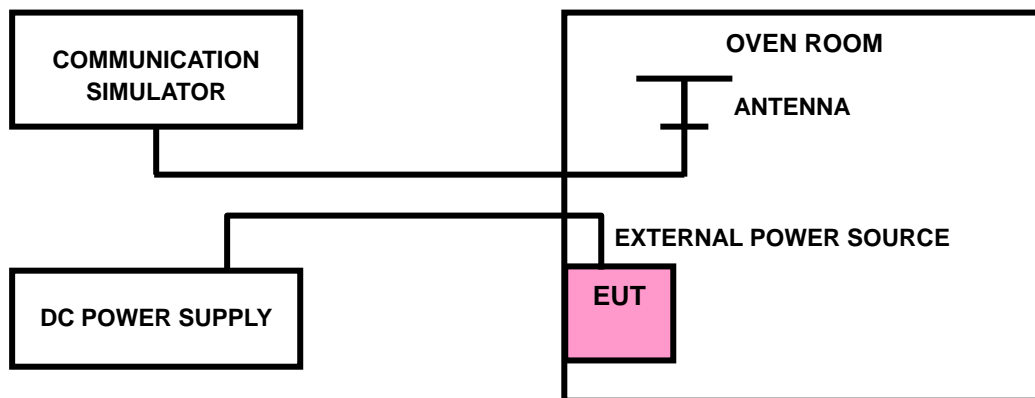



BUREAU VERITAS Test Report No.: RF200520W003-2

3.2.4 TEST RESULTS

The test results was recorded in Report No.: R1811A0536-R2(FCC ID: XMR201707BG96).



3.3 OCCUPIED BANDWIDTH MEASUREMENT

3.3.1 TEST PROCEDURES

The EUT makes a call to the communication simulator. All measurements were done at low, middle and high operational frequency range. The communication simulator station system controlled a EUT to export maximum output power under transmission mode and specific channel frequency. Use OBW measurement function of Spectrum analyzer to measure 99 % occupied bandwidth.

3.3.2 TEST SETUP

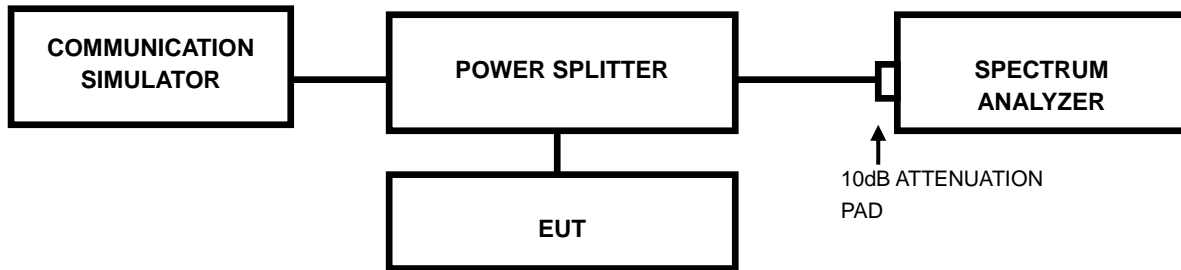

3.3.3 TEST RESULTS

The test results was recorded in Report No.: R1811A0536-R2(FCC ID: XMR201707BG96).



3.4 BAND EDGE MEASUREMENT

3.4.1 LIMITS OF BAND EDGE MEASUREMENT

Power of any emission outside of the authorized operating frequency ranges must be attenuated below the transmitting power (P) by a factor of at least $43 + 10 \log(P)$ dB. In the 1 MHz bands immediately outside and adjacent to the frequency block a resolution bandwidth of at least one percent of the emission bandwidth of the fundamental emission of the transmitter may be employed.

3.4.2 TEST SETUP

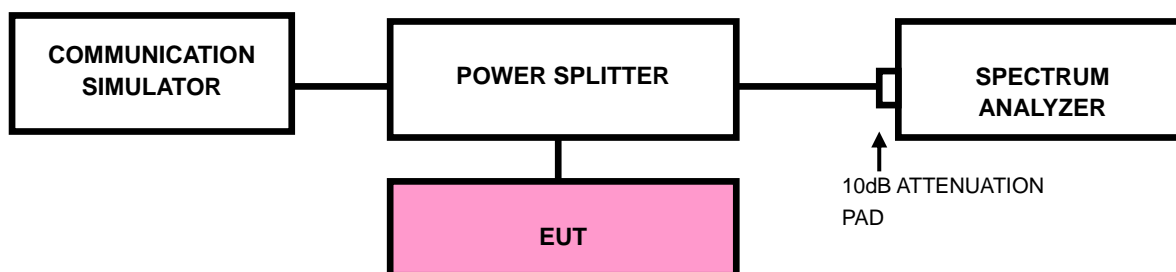



3.4.3 TEST PROCEDURES

- a. All measurements were done at low and high operational frequency range.
- b. The center frequency of spectrum is the band edge frequency and span is 1.5 MHz. RBW of the spectrum is 10kHz and VBW of the spectrum is 30kHz (GSM/GPRS/ EDGE).
- c. The center frequency of spectrum is the band edge frequency and span is 1~5 MHz. RBW of the spectrum is 20kHz and VBW of the spectrum is 100 kHz. (LTE bandwidth 1.4MHz)
- d. The center frequency of spectrum is the band edge frequency and span is 1~5 MHz. RBW of the spectrum is 30kHz and VBW of the spectrum is 100kHz. (LTE bandwidth 3MHz)
- e. The center frequency of spectrum is the band edge frequency and span is 1~5 MHz. RBW of the spectrum is 50kHz and VBW of the spectrum is 200kHz. (LTE bandwidth 5MHz)
- f. The center frequency of spectrum is the band edge frequency and span is 1~5 MHz. RBW of the spectrum is 100kHz and VBW of the spectrum is 300kHz. (LTE bandwidth 10MHz)
- g. The center frequency of spectrum is the band edge frequency and span is 1~5 MHz. RBW of the spectrum is 200kHz and VBW of the spectrum is 1MHz. (LTE bandwidth 15MHz)
- h. he center frequency of spectrum is the band edge frequency and span is 1~5 MHz. RBW of the spectrum is 200kHz and VBW of the spectrum is 1MHz. (LTE bandwidth 20MHz)
- i. Record the max trace plot into the test report.

3.4.4. TEST RESULTS

The test results was recorded in Report No.: R1811A0536-R2(FCC ID: XMR201707BG96).



3.5 CONDUCTED SPURIOUS EMISSIONS

3.5.1 LIMITS OF CONDUCTED SPURIOUS EMISSIONS MEASUREMENT

The power of any emission outside of the authorized operating frequency ranges must be attenuated below the transmitting power (P) by a factor of at least $43 + 10 \log(P)$ dB. The emission limit equal to -13dBm .

3.5.2 TEST PROCEDURE

- a. The EUT makes a phone call to the communication simulator. All measurements were done at low, middle and high operational frequency range.
- b. Measuring frequency range is from 30 MHz to 19.1GHz. 10dB attenuation pad is connected with spectrum. RBW=1MHz and VBW=3MHz is used for conducted emission measurement.

3.5.3 TEST SETUP

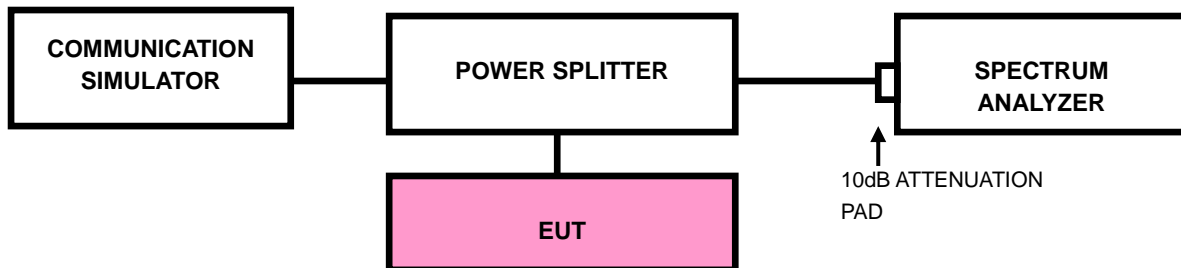

3.5.4 TEST RESULTS

The test results was recorded in Report No.: R1811A0536-R2(FCC ID: XMR201707BG96).



3.6 RADIATED EMISSION MEASUREMENT

3.6.1 LIMITS OF RADIATED EMISSION MEASUREMENT

The power of any emission outside of the authorized operating frequency ranges must be attenuated below the transmitting power (P) by a factor of at least $43 + 10 \log(P)$ dB. The emission limit equal to -13dBm .

3.6.2 TEST PROCEDURES

- a. Substitution method is used for E.I.R.P measurement. In the semi-anechoic chamber, EUT placed on the 0.8m height of Turn Table, rotated the table around 360 degrees to search the maximum radiation power and receiver antenna shall be rotated vertical and horizontal polarization and moved height from 1m to 4m to find the maximum polar radiated power. The “Read Value” is the spectrum reading the maximum power value.
- b. The substitution horn antenna is substituted for EUT at the same position and signals generator export the CW signal to the substitution antenna via a TX cable. Rotated the Turn Table and moved receiving antenna to find the maximum radiation power. Adjust output power level of S.G to get a Value of spectrum reading equal to “Read Value “ of step a. Record the power level of S.G
- c. $\text{EIRP} = \text{Output power level of S.G} - \text{TX cable loss} + \text{Antenna gain of substitution horn}$.

NOTE: The resolution bandwidth and video bandwidth of test receiver/spectrum analyzer is 1MHz/3MHz.

3.6.3 DEVIATION FROM TEST STANDARD

No deviation

3.6.4 TEST SETUP

< Frequency Range 30MHz~1GHz >

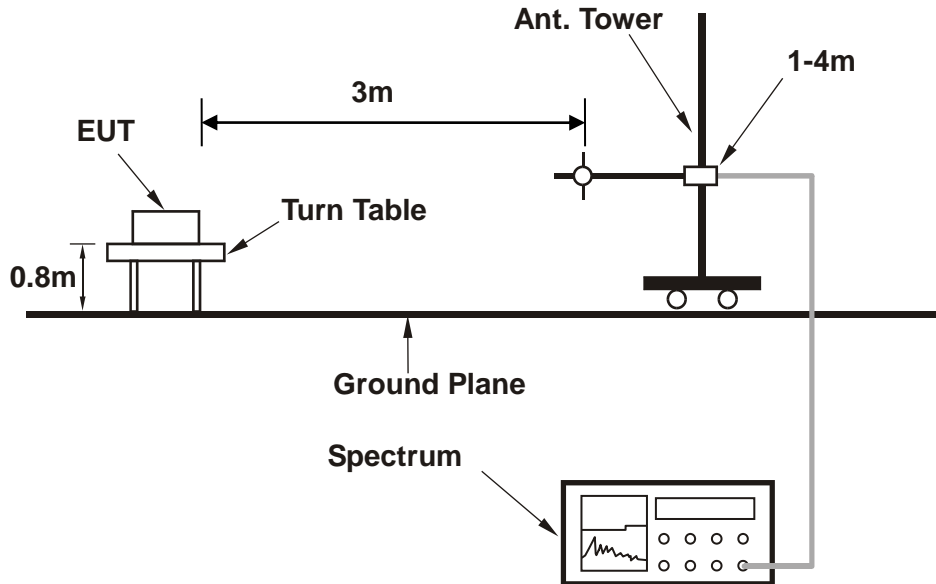

<Frequency Range above 1GHz>

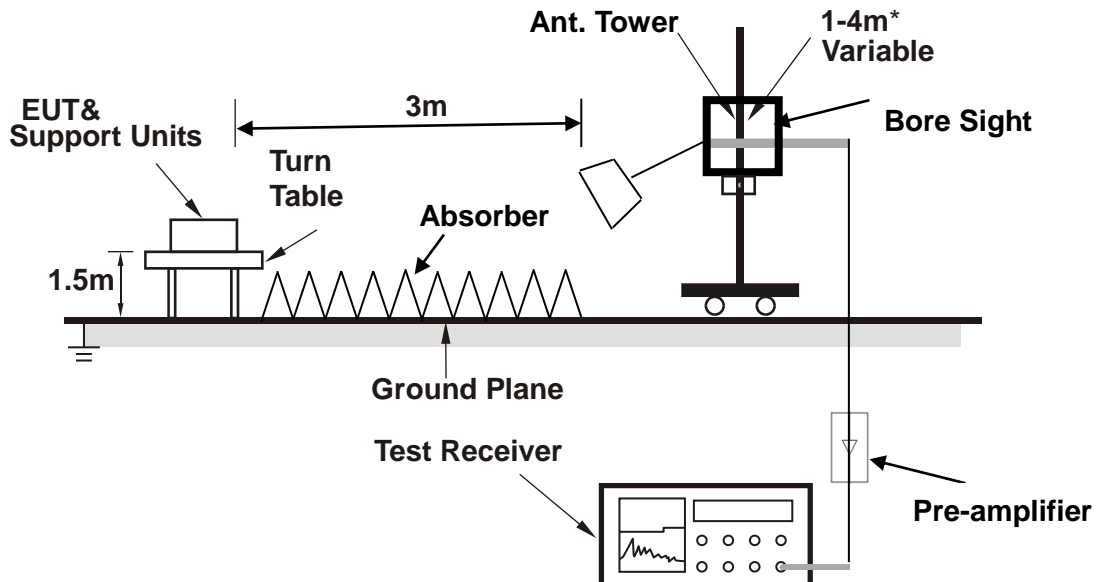

Note: Above 1G is a directional antenna

Depends on the EUT height and the antenna 3dB beamwidth both, refer to section 7.3 of CISPR 16-2-3.

For the actual test configuration, please refer to the attached file (Test Setup Photo).



3.6.5 TEST RESULTS

BELOW 1GHz WORST-CASE DATA FROM ANT 0

30 MHz – 1GHz data:

LTE Band 25

CHANNEL BANDWIDTH: 3Hz / QPSK

MODE	TX channel 26365	FREQUENCY RANGE	Below 1000MHz
ENVIRONMENTAL CONDITIONS	23deg. C, 70%RH	INPUT POWER	DC 5V
TESTED BY	Tony		
ANTENNA POLARITY & TEST DISTANCE: HORIZONTAL AT 3 M			

	Freq	Level	Read Level	Limit Line	Over Limit	Factor	Remark	Pol/Phase
	MHz	dBm/m	dBm	dBm/m	dB	dB/m		
1	PP	31.940	-37.91	-55.38	-13.00	-24.91	17.47 Peak	Horizontal
2		86.260	-46.83	-39.56	-13.00	-33.83	-7.27 Peak	Horizontal
3		175.500	-57.94	-41.71	-13.00	-44.94	-16.23 Peak	Horizontal
4		274.440	-61.95	-49.00	-13.00	-48.95	-12.95 Peak	Horizontal
5		310.330	-58.70	-47.49	-13.00	-45.70	-11.21 Peak	Horizontal
6		422.850	-69.85	-62.11	-13.00	-56.85	-7.74 Peak	Horizontal

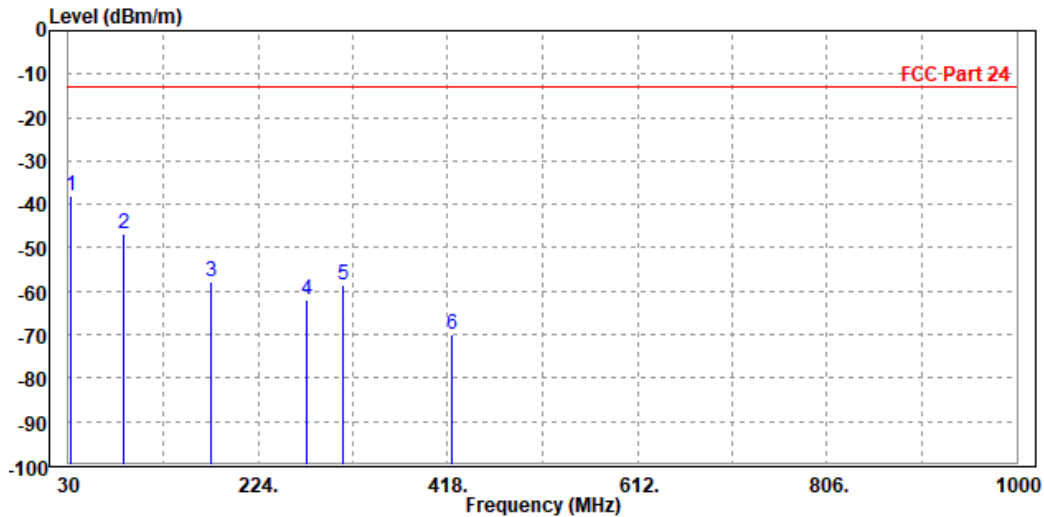



**BUREAU
VERITAS**

Test Report No.: RF200520W003-2

MODE	TX channel 26365	FREQUENCY RANGE	Below 1000MHz
ENVIRONMENTAL CONDITIONS	23deg. C, 70%RH	INPUT POWER	DC 5V
TESTED BY	Tony		
ANTENNA POLARITY & TEST DISTANCE: VERTICAL AT 3 M			

	Freq	Level	Read Level	Limit Line	Over Limit	Factor	Remark	Pol/Phase
	MHz	dBm/m	dBm	dBm/m	dB	dB/m		
1	PP	30.970	-43.19	-48.02	-13.00	-30.19	4.83 Peak	Vertical
2		46.490	-43.70	-41.09	-13.00	-30.70	-2.61 Peak	Vertical
3		67.830	-46.50	-32.79	-13.00	-33.50	-13.71 Peak	Vertical
4		85.290	-50.19	-41.03	-13.00	-37.19	-9.16 Peak	Vertical
5		171.620	-57.26	-44.89	-13.00	-44.26	-12.37 Peak	Vertical
6		278.320	-56.73	-47.48	-13.00	-43.73	-9.25 Peak	Vertical

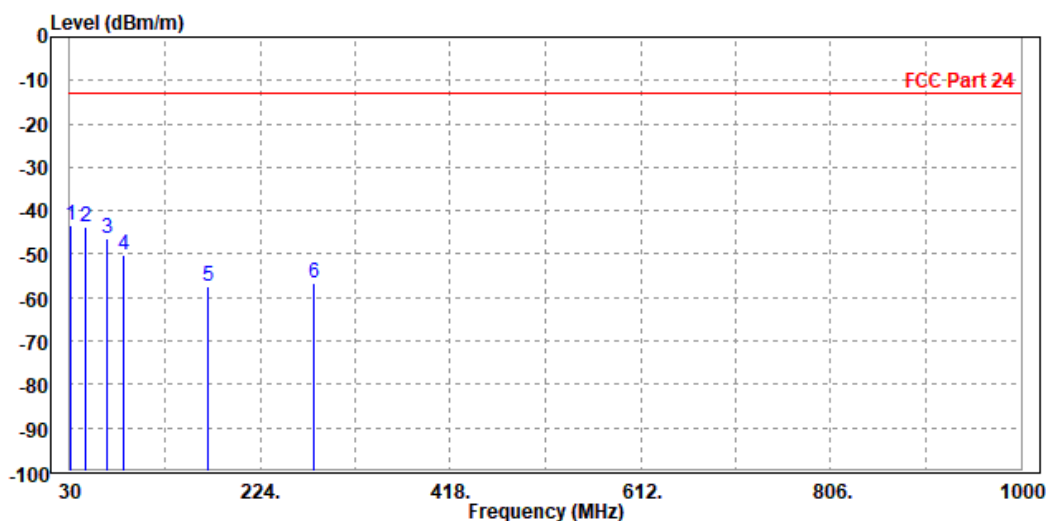



ABOVE 1GHz DATA

Note: For higher frequency, the emission is too low to be detected.

WORST-CASE DATA

PCS 1900:

CH 512

MODE	TX channel 512	FREQUENCY RANGE	Above 1000MHz
ENVIRONMENTAL CONDITIONS	23deg. C, 70%RH	INPUT POWER	DC 5V
TESTED BY	Tony		
ANTENNA POLARITY & TEST DISTANCE: HORIZONTAL AT 3 M			

	Freq	Level	Read Level	Limit Line	Over Limit	Factor	Remark	Pol/Phase
	MHz	dBm/m	dBm	dBm/m	dB	dB/m		
1	3700.000	-49.81	-58.60	-13.00	-36.81	8.79	Peak	Horizontal
2 PP	5550.600	-49.12	-59.31	-13.00	-36.12	10.19	Peak	Horizontal

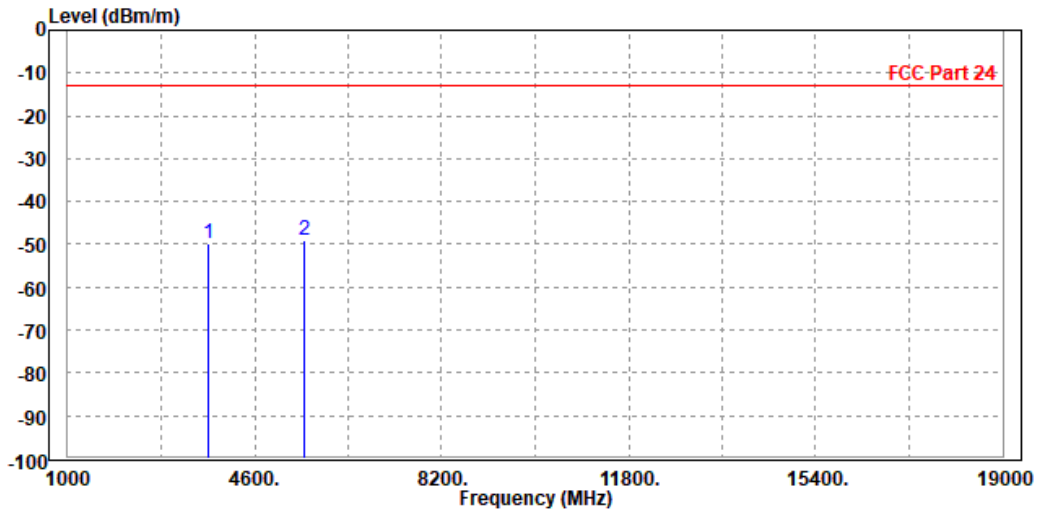



BUREAU VERITAS

Test Report No.: RF200520W003-2

MODE	TX channel 512	FREQUENCY RANGE	Above 1000MHz
ENVIRONMENTAL CONDITIONS	23deg. C, 70%RH	INPUT POWER	DC 5V
TESTED BY	Tony		
ANTENNA POLARITY & TEST DISTANCE: VERTICAL AT 3 M			

	Read	Limit	Over				
Freq	Level	Level	Line	Limit	Factor	Remark	Pol/Phase
MHz	dBm/m	dBm	dBm/m	dB	dB/m		
1 PP 3700.000	-48.40	-57.65	-13.00	-35.40	9.25	Peak	Vertical
2 5550.600	-49.41	-59.31	-13.00	-36.41	9.90	Peak	Vertical

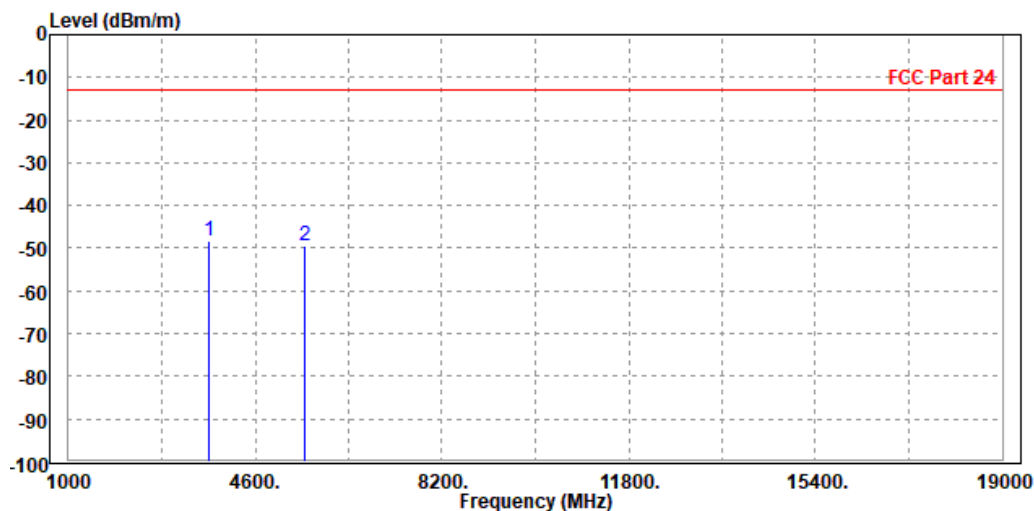



CH 661

MODE	TX channel 661	FREQUENCY RANGE	Above 1000MHz
ENVIRONMENTAL CONDITIONS	23deg. C, 70%RH	INPUT POWER	DC 5V
TESTED BY	Tony		
ANTENNA POLARITY & TEST DISTANCE: HORIZONTAL AT 3 M			

	Freq	Level	Read Level	Limit Line	Over Limit	Factor	Remark	Pol/Phase
	MHz	dBm/m	dBm	dBm/m	dB	dB/m		
1	3754.000	-49.10	-57.94	-13.00	-36.10	8.84	Peak	Horizontal
2 PP	5640.000	-48.67	-59.15	-13.00	-35.67	10.48	Peak	Horizontal

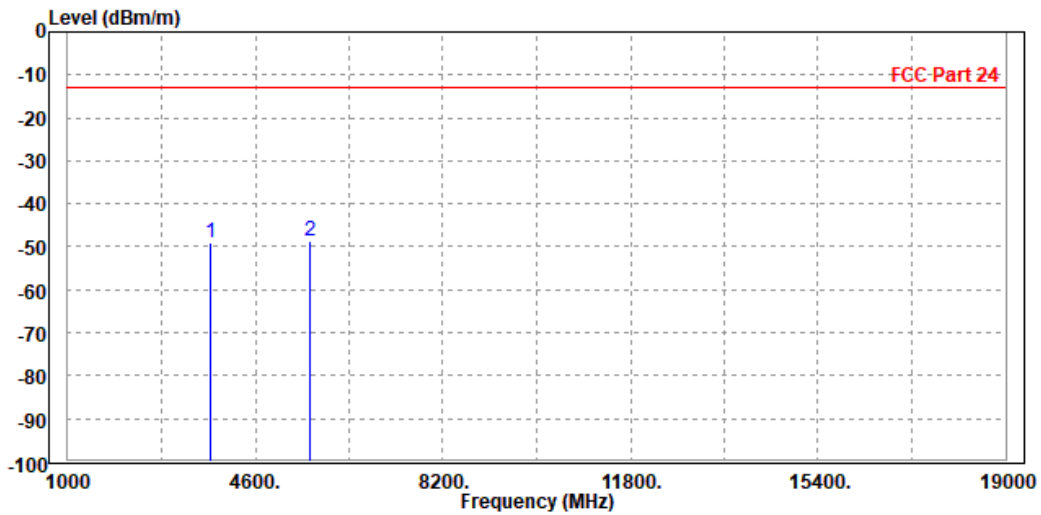



BUREAU VERITAS

Test Report No.: RF200520W003-2

MODE	TX channel 661	FREQUENCY RANGE	Above 1000MHz
ENVIRONMENTAL CONDITIONS	23deg. C, 70%RH	INPUT POWER	DC 5V
TESTED BY	Tony		
ANTENNA POLARITY & TEST DISTANCE: VERTICAL AT 3 M			

	Read	Limit	Over				
Freq	Level	Level	Line	Limit	Factor	Remark	Pol/Phase
MHz	dBm/m	dBm	dBm/m	dB	dB/m		
1	3754.000	-48.41	-57.68	-13.00	-35.41	9.27 Peak	Vertical
2	PP 5640.000	-47.77	-58.02	-13.00	-34.77	10.25 Peak	Vertical

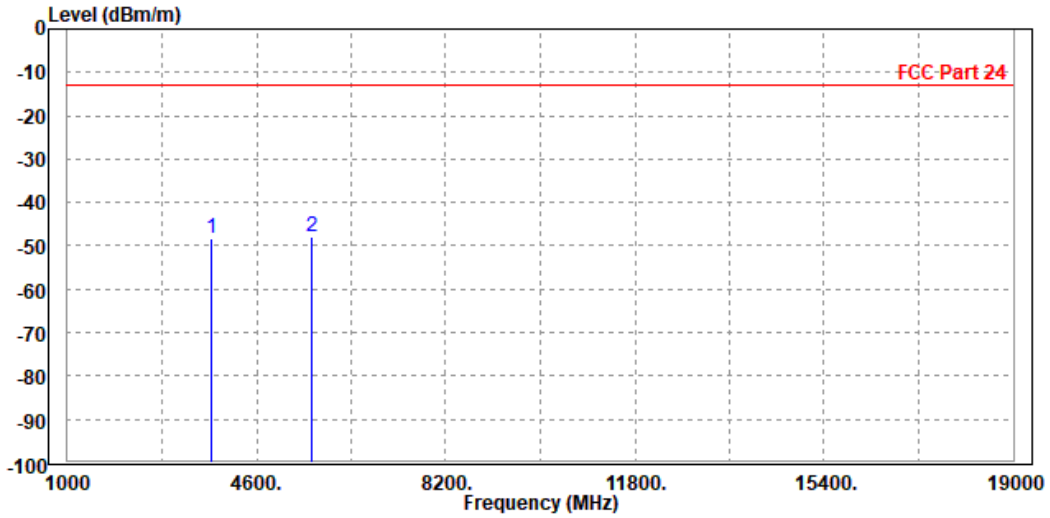



CH 810

MODE	TX channel 810	FREQUENCY RANGE	Above 1000MHz
ENVIRONMENTAL CONDITIONS	23deg. C, 70%RH	INPUT POWER	DC 5V
TESTED BY	Tony		
ANTENNA POLARITY & TEST DISTANCE: HORIZONTAL AT 3 M			

	Freq	Level	Read Level	Limit Line	Over Limit	Factor	Remark	Pol/Phase
	MHz	dBm/m	dBm	dBm/m	dB	dB/m		
1	3826.000	-47.74	-56.66	-13.00	-34.74	8.92	Peak	Horizontal
2 PP	5729.400	-47.00	-57.78	-13.00	-34.00	10.78	Peak	Horizontal

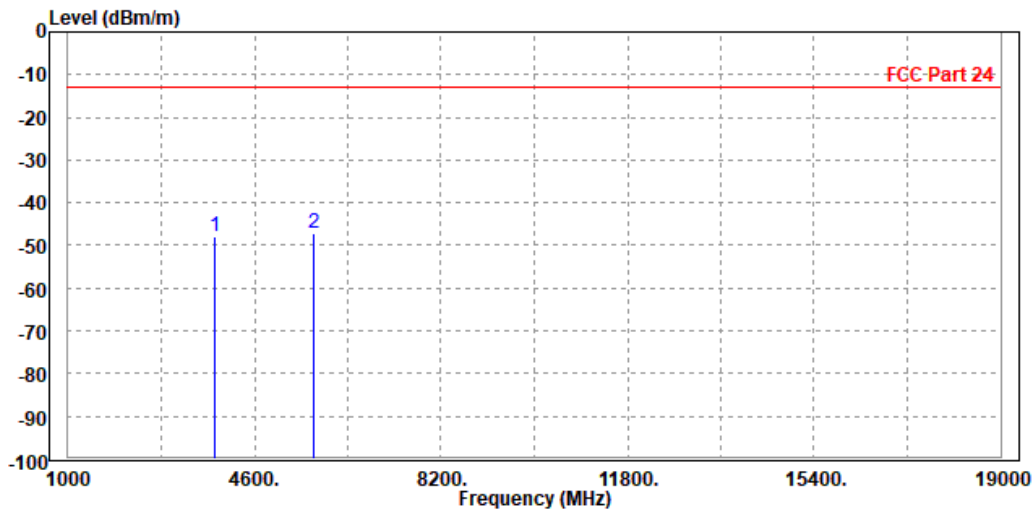



**BUREAU
VERITAS**

Test Report No.: RF200520W003-2

MODE	TX channel 810	FREQUENCY RANGE	Above 1000MHz
ENVIRONMENTAL CONDITIONS	23deg. C, 70%RH	INPUT POWER	DC 5V
TESTED BY	Tony		
ANTENNA POLARITY & TEST DISTANCE: VERTICAL AT 3 M			

	Freq	Level	Read Level	Limit Line	Over Limit	Factor	Remark	Pol/Phase
	MHz	dBm/m	dBm	dBm/m	dB	dB/m		
1	3826.000	-47.71	-57.00	-13.00	-34.71	9.29	Peak	Vertical
2 PP	5729.400	-46.59	-57.18	-13.00	-33.59	10.59	Peak	Vertical

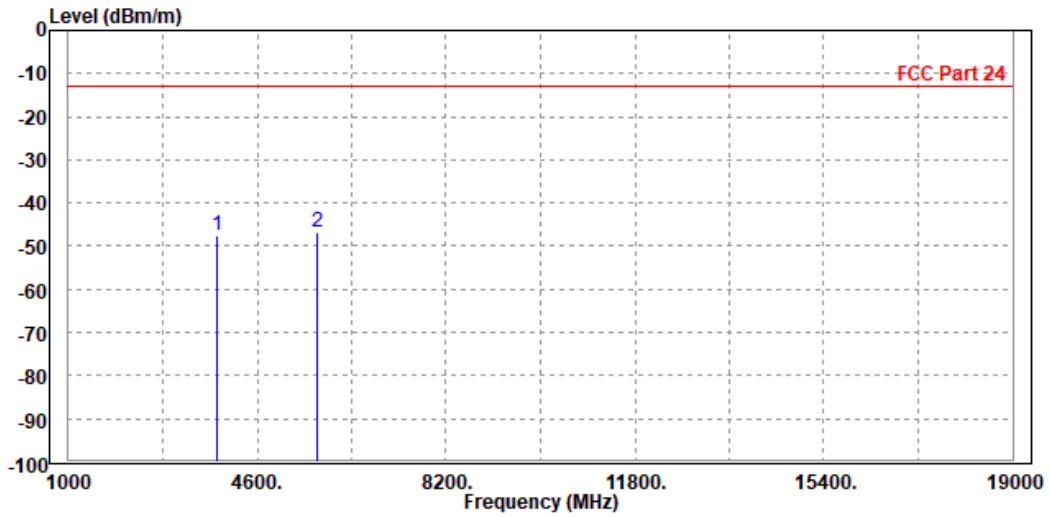



EDGE 1900:

CH 512

MODE	TX channel 512	FREQUENCY RANGE	Above 1000MHz
ENVIRONMENTAL CONDITIONS	23deg. C, 70%RH	INPUT POWER	DC 5V from adapter
TESTED BY	Tony Xiong		
ANTENNA POLARITY & TEST DISTANCE: HORIZONTAL AT 3 M			

	Freq	Level	Read Level	Limit Line	Over Limit	Factor	Remark	Pol/Phase
	MHz	dBm/m	dBm	dBm/m	dB	dB/m		
1	3700.000	-48.36	-57.15	-13.00	-35.36	8.79	Peak	Horizontal
2 PP	5550.600	-47.97	-58.16	-13.00	-34.97	10.19	Peak	Horizontal

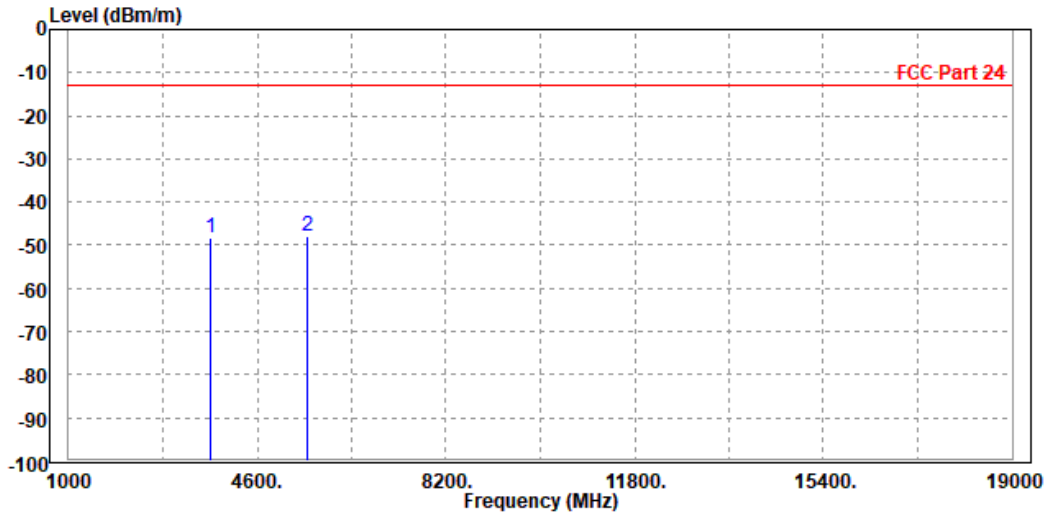



**BUREAU
VERITAS**

Test Report No.: RF200520W003-2

MODE	TX channel 512	FREQUENCY RANGE	Above 1000MHz
ENVIRONMENTAL CONDITIONS	23deg. C, 70%RH	INPUT POWER	DC 5V from adapter
TESTED BY	Tony Xiong		
ANTENNA POLARITY & TEST DISTANCE: VERTICAL AT 3 M			

	Freq	Level	Read Level	Limit Line	Over Limit	Factor	Remark	Pol/Phase
	MHz	dBm/m	dBm	dBm/m	dB	dB/m		
1	PP 3700.000	-48.89	-58.14	-13.00	-35.89	9.25	Peak	Vertical
2	5550.600	-49.10	-59.00	-13.00	-36.10	9.90	Peak	Vertical

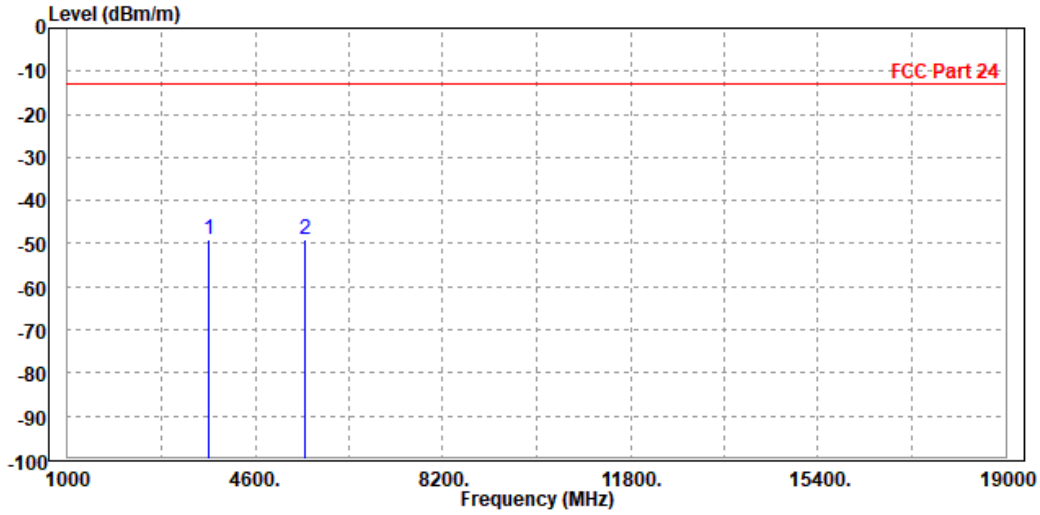



CH 661

MODE	TX channel 661	FREQUENCY RANGE	Above 1000MHz
ENVIRONMENTAL CONDITIONS	23deg. C, 70%RH	INPUT POWER	DC 5V from adapter
TESTED BY	Tony Xiong		
ANTENNA POLARITY & TEST DISTANCE: HORIZONTAL AT 3 M			

	Freq	Level	Read Level	Limit Line	Over Limit	Factor	Remark	Pol/Phase
	MHz	dBm/m	dBm	dBm/m	dB	dB/m		
1	PP 3754.000	-47.37	-56.21	-13.00	-34.37	8.84	Peak	Horizontal
2	5640.000	-47.64	-58.12	-13.00	-34.64	10.48	Peak	Horizontal

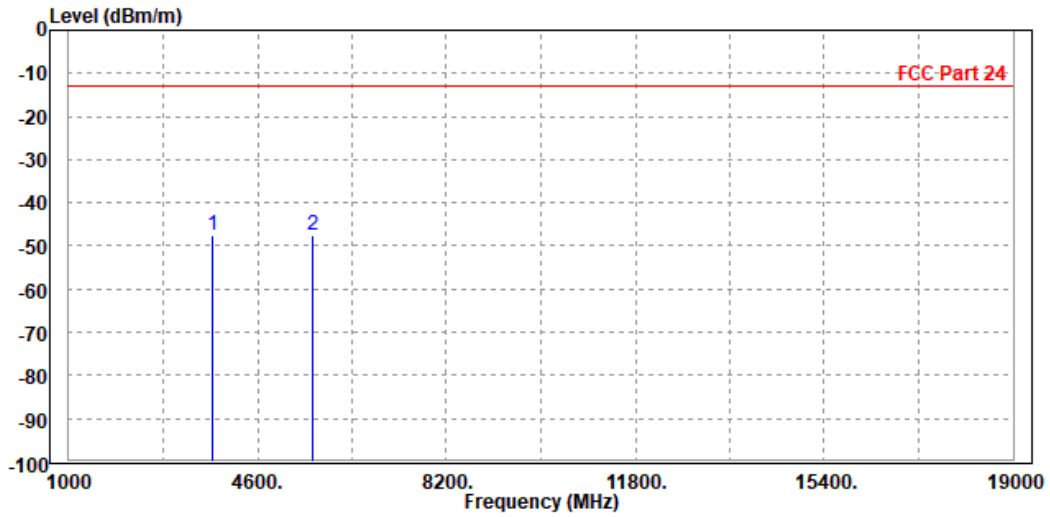



**BUREAU
VERITAS**

Test Report No.: RF200520W003-2

MODE	TX channel 661	FREQUENCY RANGE	Above 1000MHz
ENVIRONMENTAL CONDITIONS	23deg. C, 70%RH	INPUT POWER	DC 5V from adapter
TESTED BY	Tony Xiong		
ANTENNA POLARITY & TEST DISTANCE: VERTICAL AT 3 M			

	Freq	Level	Read Level	Limit Line	Over Limit	Factor	Remark	Pol/Phase
	MHz	dBm/m	dBm	dBm/m	dB	dB/m		
1	3754.000	-48.85	-58.12	-13.00	-35.85	9.27	Peak	Vertical
2	PP 5640.000	-46.86	-57.11	-13.00	-33.86	10.25	Peak	Vertical

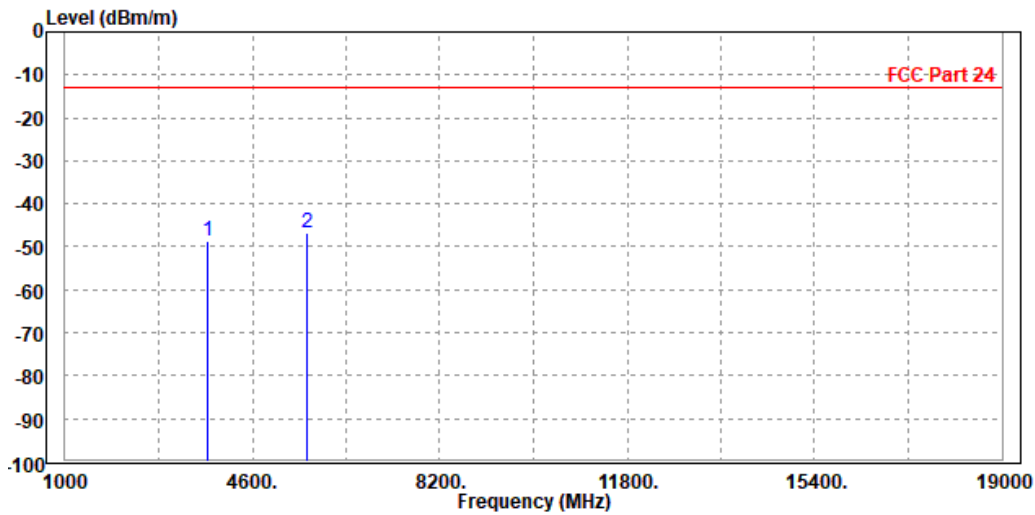



CH 810

MODE	TX channel 810	FREQUENCY RANGE	Above 1000MHz
ENVIRONMENTAL CONDITIONS	23deg. C, 70%RH	INPUT POWER	DC 5V from adapter
TESTED BY	Tony Xiong		
ANTENNA POLARITY & TEST DISTANCE: HORIZONTAL AT 3 M			

	Freq	Level	Read Level	Limit Line	Over Limit	Factor	Remark	Pol/Phase
	MHz	dBm/m	dBm	dBm/m	dB	dB/m		
1	3826.000	-46.21	-55.13	-13.00	-33.21	8.92	Peak	Horizontal
2 PP	5729.400	-45.72	-56.50	-13.00	-32.72	10.78	Peak	Horizontal

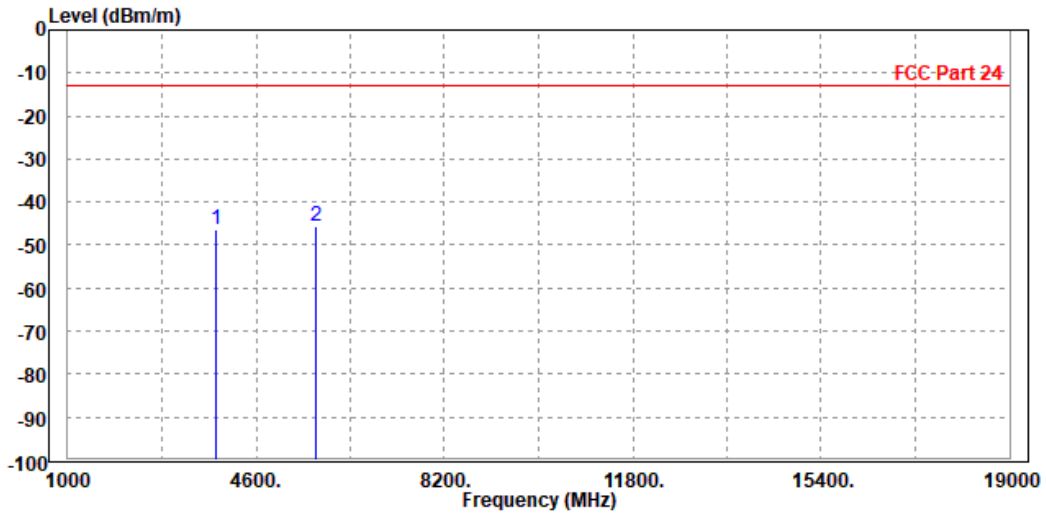



MODE	TX channel 810	FREQUENCY RANGE	Above 1000MHz
ENVIRONMENTAL CONDITIONS	23deg. C, 70%RH	INPUT POWER	DC 5V from adapter
TESTED BY	Tony Xiong		
ANTENNA POLARITY & TEST DISTANCE: VERTICAL AT 3 M			

	Freq	Level	Read Level	Limit Line	Over Limit	Factor	Remark	Pol/Phase
	MHz	dBm/m	dBm	dBm/m	dB	dB/m		
1	3826.000	-47.31	-56.60	-13.00	-34.31	9.29	Peak	Vertical
2 PP	5729.400	-45.93	-56.52	-13.00	-32.93	10.59	Peak	Vertical

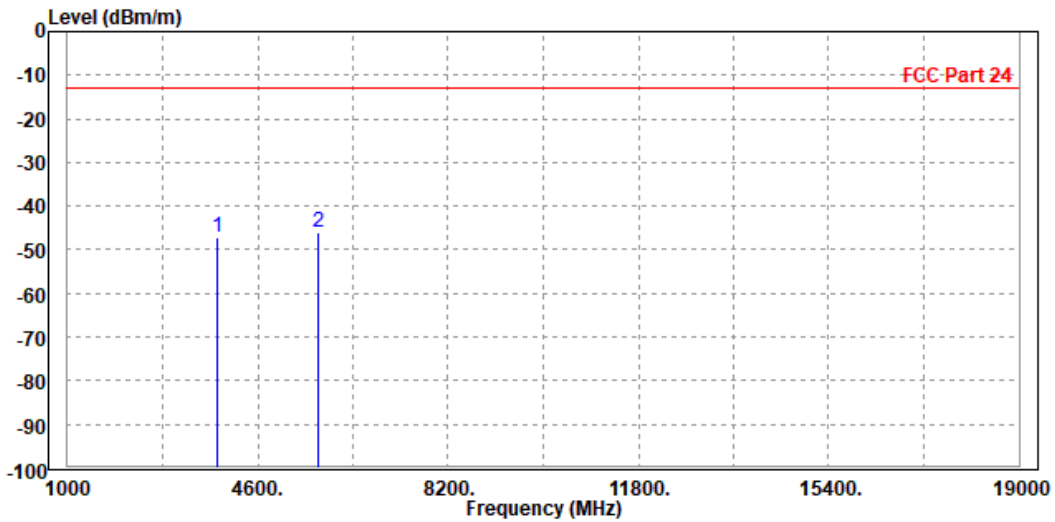



BUREAU VERITAS

Test Report No.: RF200520W003-2

LTE Band 2

CHANNEL BANDWIDTH: 1.4MHz / QPSK

MODE	TX channel 18900	FREQUENCY RANGE	Above 1000MHz
ENVIRONMENTAL CONDITIONS	23deg. C, 70%RH	INPUT POWER	DC 5V
TESTED BY	Tony		
ANTENNA POLARITY & TEST DISTANCE: HORIZONTAL AT 3 M			

	Freq	Level	Read Level	Limit Line	Over Limit	Factor	Remark	Pol/Phase
	MHz	dBm/m	dBm	dBm/m	dB	dB/m		
1	PP 3754.000	-46.02	-54.86	-13.00	-33.02	8.84	Peak	Horizontal
2	5644.000	-48.41	-58.91	-13.00	-35.41	10.50	Peak	Horizontal

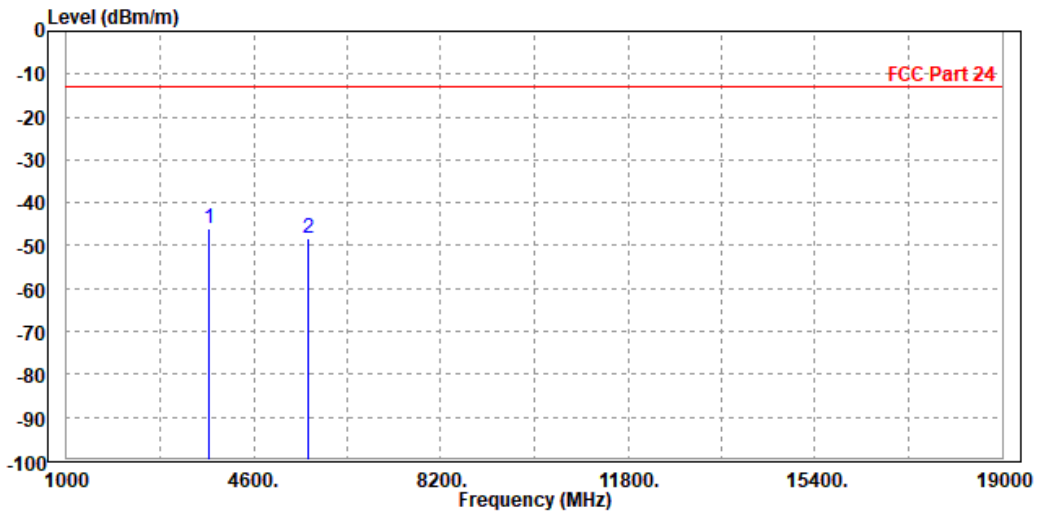



**BUREAU
VERITAS**

Test Report No.: RF200520W003-2

MODE	TX channel 18900	FREQUENCY RANGE	Above 1000MHz
ENVIRONMENTAL CONDITIONS	23deg. C, 70%RH	INPUT POWER	DC 5V
TESTED BY	Tony		
ANTENNA POLARITY & TEST DISTANCE: VERTICAL AT 3 M			

	Freq	Level	Read Level	Limit Line	Over Limit	Factor	Remark	Pol/Phase
	MHz	dBm/m	dBm	dBm/m	dB	dB/m		
1	PP 3754.000	-43.69	-52.96	-13.00	-30.69	9.27	Peak	Vertical
2	5640.000	-48.39	-58.64	-13.00	-35.39	10.25	Peak	Vertical

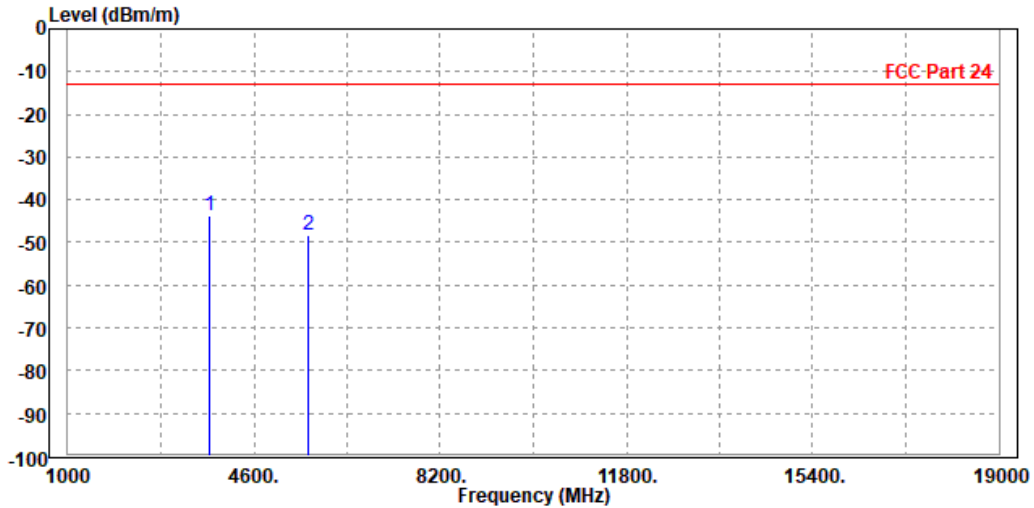



BUREAU VERITAS

Test Report No.: RF200520W003-2

CHANNEL BANDWIDTH: 3MHz / QPSK

MODE	TX channel 18900	FREQUENCY RANGE	Above 1000MHz
ENVIRONMENTAL CONDITIONS	23deg. C, 70%RH	INPUT POWER	DC 5V
TESTED BY	Tony		
ANTENNA POLARITY & TEST DISTANCE: HORIZONTAL AT 3 M			

	Freq	Level	Read Level	Limit Line	Over Limit	Factor	Remark	Pol/Phase
	MHz	dBm/m	dBm	dBm/m	dB	dB/m		
1 PP	3754.000	-48.62	-57.46	-13.00	-35.62	8.84	Peak	Horizontal
2	5640.000	-49.00	-59.48	-13.00	-36.00	10.48	Peak	Horizontal

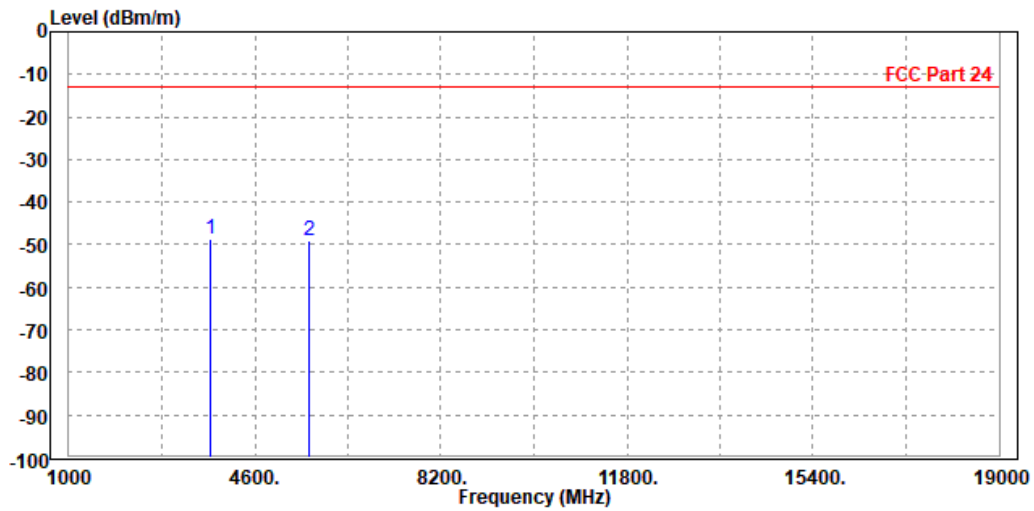



BUREAU VERITAS

Test Report No.: RF200520W003-2

MODE	TX channel 18900	FREQUENCY RANGE	Above 1000MHz
ENVIRONMENTAL CONDITIONS	23deg. C, 70%RH	INPUT POWER	DC 5V
TESTED BY	Tony		
ANTENNA POLARITY & TEST DISTANCE: VERTICAL AT 3 M			

	Read	Limit	Over				
Freq	Level	Level	Line	Limit	Factor	Remark	Pol/Phase
MHz	dBm/m	dBm	dBm/m	dB	dB/m		
1 PP 3754.000	-45.25	-54.52	-13.00	-32.25	9.27	Peak	Vertical
2 5640.000	-48.60	-58.85	-13.00	-35.60	10.25	Peak	Vertical

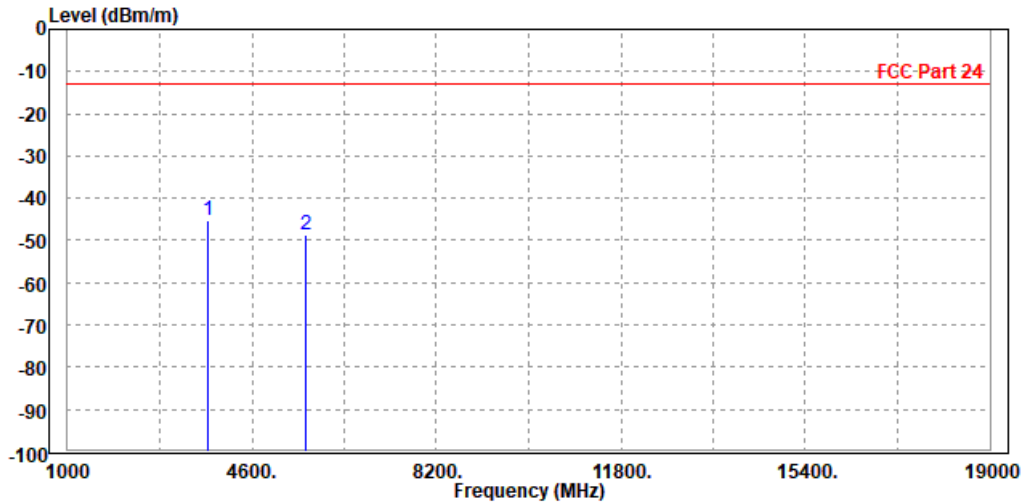



CHANNEL BANDWIDTH: 5MHz / QPSK

MODE	TX channel 18900	FREQUENCY RANGE	Above 1000MHz
ENVIRONMENTAL CONDITIONS	23deg. C, 70%RH	INPUT POWER	DC 5V
TESTED BY	Tony		
ANTENNA POLARITY & TEST DISTANCE: HORIZONTAL AT 3 M			

	Freq	Level	Read Level	Limit Line	Over Limit	Factor	Remark	Pol/Phase
	MHz	dBm/m	dBm	dBm/m	dB	dB/m		
1	3754.000	-48.88	-57.72	-13.00	-35.88	8.84	Peak	Horizontal
2	PP 5640.000	-48.47	-58.95	-13.00	-35.47	10.48	Peak	Horizontal

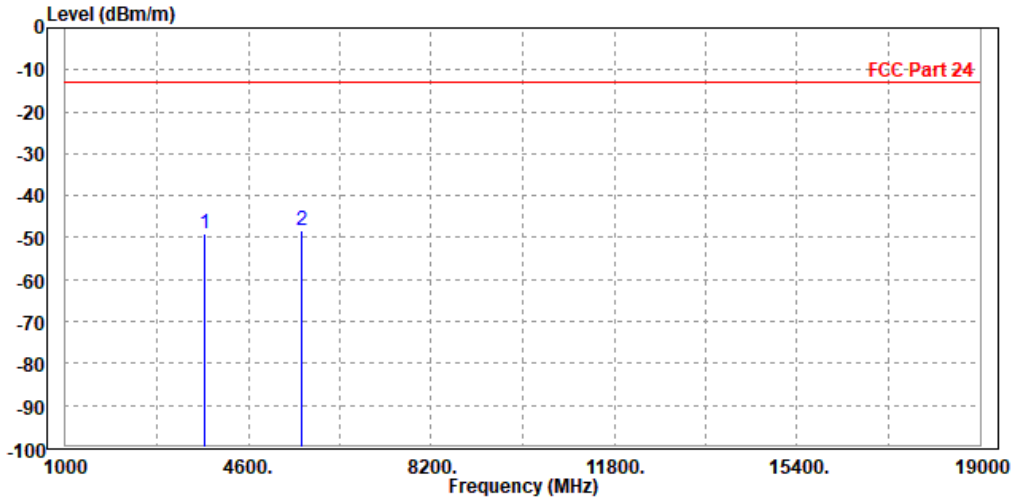



BUREAU VERITAS

Test Report No.: RF200520W003-2

MODE	TX channel 18900	FREQUENCY RANGE	Above 1000MHz
ENVIRONMENTAL CONDITIONS	23deg. C, 70%RH	INPUT POWER	DC 5V
TESTED BY	Tony		
ANTENNA POLARITY & TEST DISTANCE: VERTICAL AT 3 M			

	Freq	Level	Read Level	Limit Line	Over Limit	Factor	Remark	Pol/Phase
	MHz	dBm/m	dBm	dBm/m	dB	dB/m		
1	PP 3754.000	-44.35	-53.62	-13.00	-31.35	9.27	Peak	Vertical
2	5640.000	-47.97	-58.22	-13.00	-34.97	10.25	Peak	Vertical

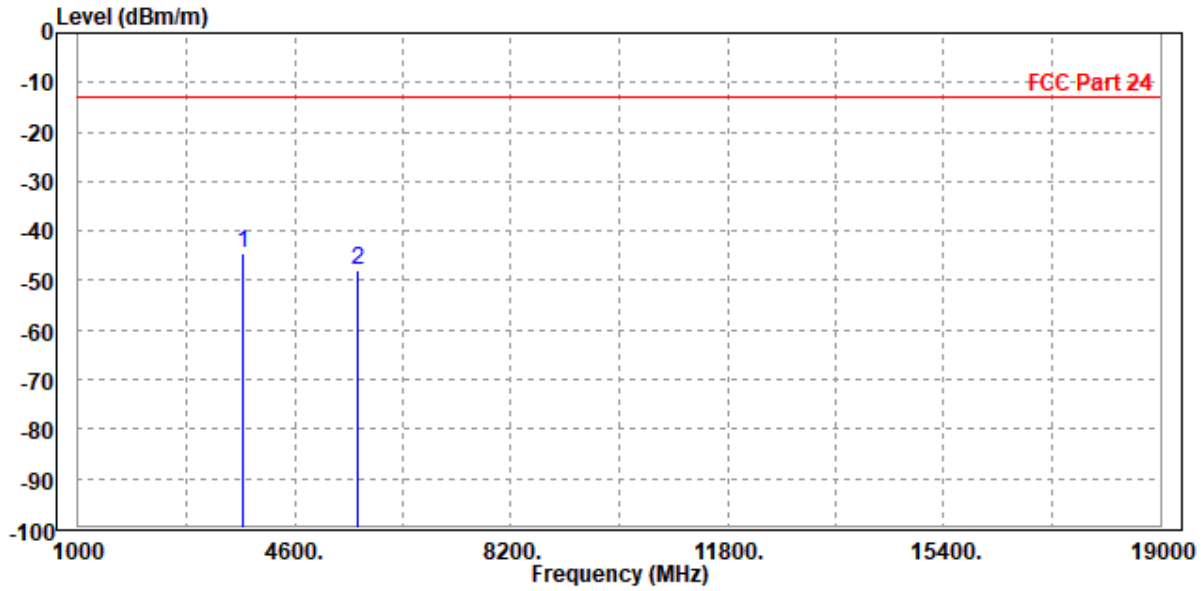



BUREAU VERITAS

Test Report No.: RF200520W003-2

CHANNEL BANDWIDTH: 10MHz / QPSK

MODE	TX channel 18900	FREQUENCY RANGE	Above 1000MHz
ENVIRONMENTAL CONDITIONS	23deg. C, 70%RH	INPUT POWER	DC 5V
TESTED BY	Tony		
ANTENNA POLARITY & TEST DISTANCE: HORIZONTAL AT 3 M			

	Read	Limit	Over				
Freq	Level	Level	Line	Limit	Factor	Remark	Pol/Phase
MHz	dBm/m	dBm	dBm/m	dB	dB/m		
1 PP 3754.000	-45.85	-54.69	-13.00	-32.85	8.84	Peak	Horizontal
2 5640.000	-48.65	-59.13	-13.00	-35.65	10.48	Peak	Horizontal

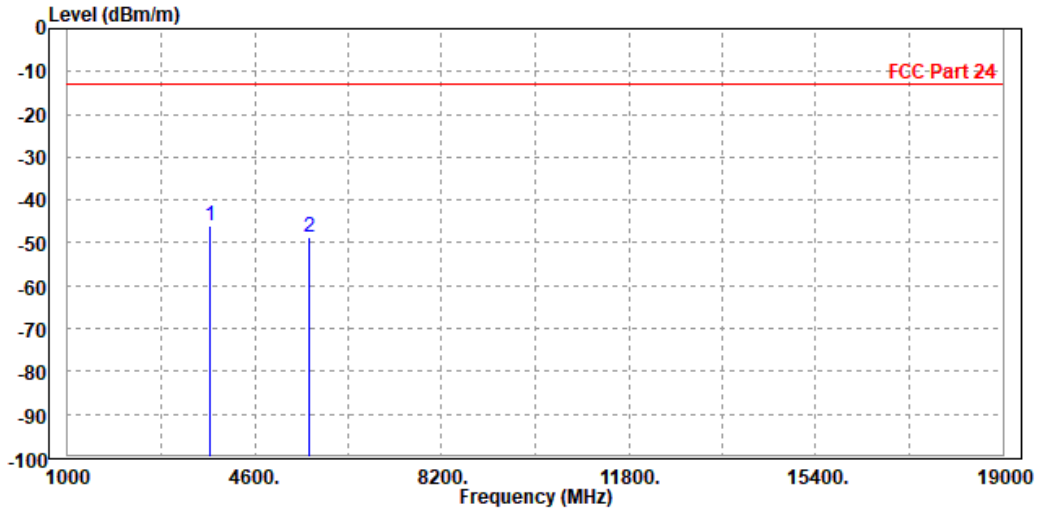



BUREAU VERITAS

Test Report No.: RF200520W003-2

MODE	TX channel 18900	FREQUENCY RANGE	Above 1000MHz
ENVIRONMENTAL CONDITIONS	23deg. C, 70%RH	INPUT POWER	DC 5V
TESTED BY	Tony		
ANTENNA POLARITY & TEST DISTANCE: VERTICAL AT 3 M			

	Freq	Level	Read Level	Limit Line	Over Limit	Factor	Remark	Pol/Phase
	MHz	dBm/m	dBm	dBm/m	dB	dB/m		
1	PP 3754.000	-43.32	-52.59	-13.00	-30.32	9.27	Peak	Vertical
2	5640.000	-47.71	-57.96	-13.00	-34.71	10.25	Peak	Vertical

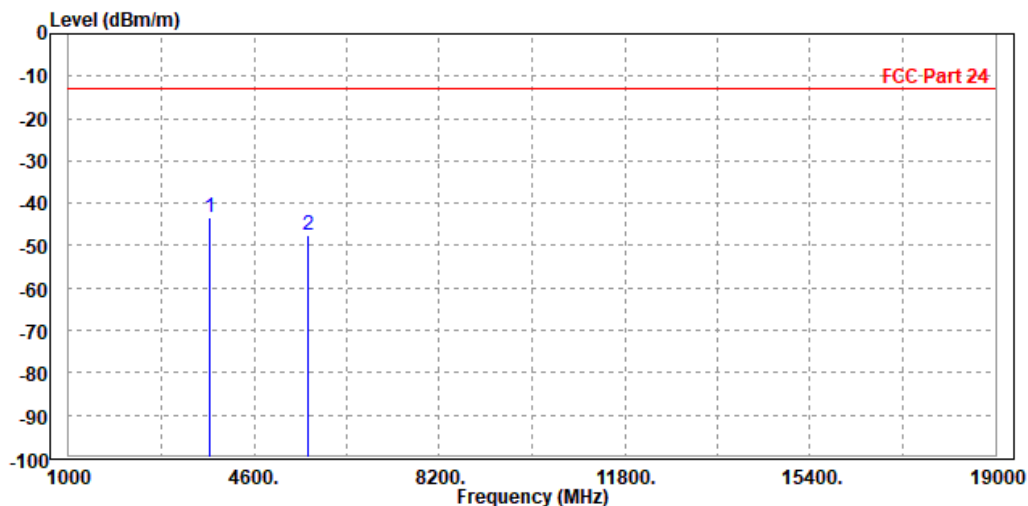



CHANNEL BANDWIDTH: 15MHz / QPSK
CH 18675

MODE	TX channel 18675	FREQUENCY RANGE	Above 1000MHz
ENVIRONMENTAL CONDITIONS	23deg. C, 70%RH	INPUT POWER	DC 5V
TESTED BY	Tony		
ANTENNA POLARITY & TEST DISTANCE: HORIZONTAL AT 3 M			

	Freq	Level	Read Level	Limit Line	Over Limit	Factor	Remark	Pol/Phase
	MHz	dBm/m	dBm	dBm/m	dB	dB/m		
1	PP 3718.000	-47.84	-56.65	-13.00	-34.84	8.81	Peak	Horizontal
2	5572.500	-48.77	-59.03	-13.00	-35.77	10.26	Peak	Horizontal

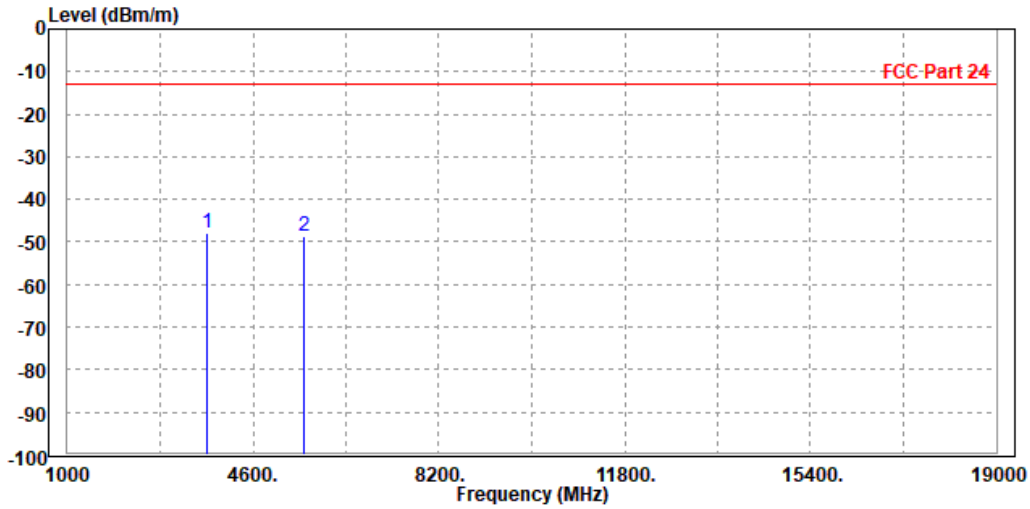



BUREAU VERITAS

Test Report No.: RF200520W003-2

MODE	TX channel 18675	FREQUENCY RANGE	Above 1000MHz
ENVIRONMENTAL CONDITIONS	23deg. C, 70%RH	INPUT POWER	DC 5V
TESTED BY	Tony		
ANTENNA POLARITY & TEST DISTANCE: VERTICAL AT 3 M			

	Freq	Level	Read Level	Limit Line	Over Limit	Factor	Remark	Pol/Phase
	MHz	dBm/m	dBm	dBm/m	dB	dB/m		
1	PP 3718.000	-48.48	-57.74	-13.00	-35.48	9.26	Peak	Vertical
2	5572.500	-48.73	-58.72	-13.00	-35.73	9.99	Peak	Vertical

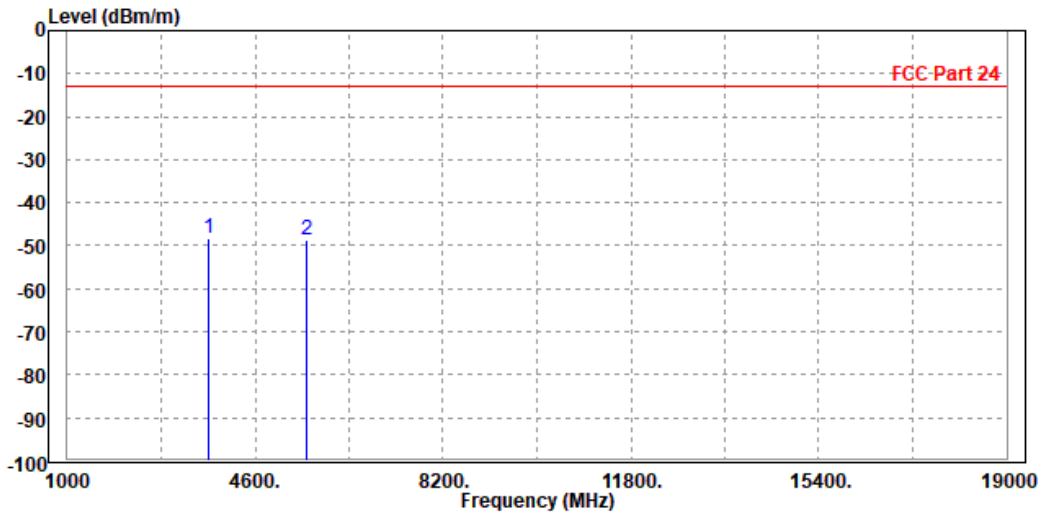



CH 18900

MODE	TX channel 18900	FREQUENCY RANGE	Above 1000MHz
ENVIRONMENTAL CONDITIONS	23deg. C, 70%RH	INPUT POWER	DC 5V
TESTED BY	Tony		
ANTENNA POLARITY & TEST DISTANCE: HORIZONTAL AT 3 M			

	Freq	Level	Read Level	Limit Line	Over Limit	Factor	Remark	Pol/Phase
	MHz	dBm/m	dBm	dBm/m	dB	dB/m		
1	PP 3754.000	-33.67	-42.51	-13.00	-20.67	8.84	Peak	Horizontal
2	5640.000	-47.70	-58.18	-13.00	-34.70	10.48	Peak	Horizontal

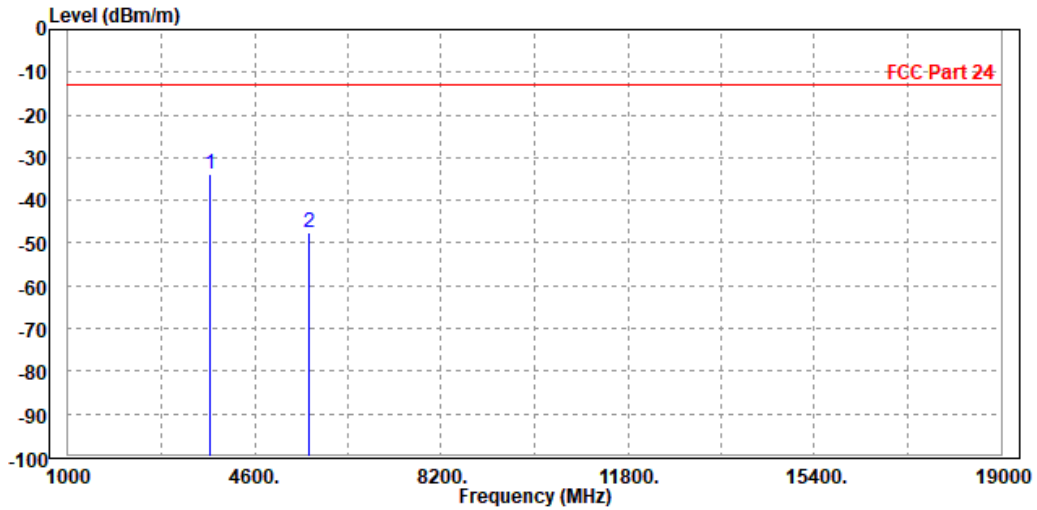



MODE	TX channel 18900	FREQUENCY RANGE	Above 1000MHz
ENVIRONMENTAL CONDITIONS	23deg. C, 70%RH	INPUT POWER	DC 5V
TESTED BY	Tony		
ANTENNA POLARITY & TEST DISTANCE: VERTICAL AT 3 M			

	Freq	Level	Read Level	Limit Line	Over Limit	Factor	Remark	Pol/Phase
	MHz	dBm/m	dBm	dBm/m	dB	dB/m		
1	3754.000	-48.16	-57.43	-13.00	-35.16	9.27	Peak	Vertical
2 PP	5640.000	-48.08	-58.33	-13.00	-35.08	10.25	Peak	Vertical

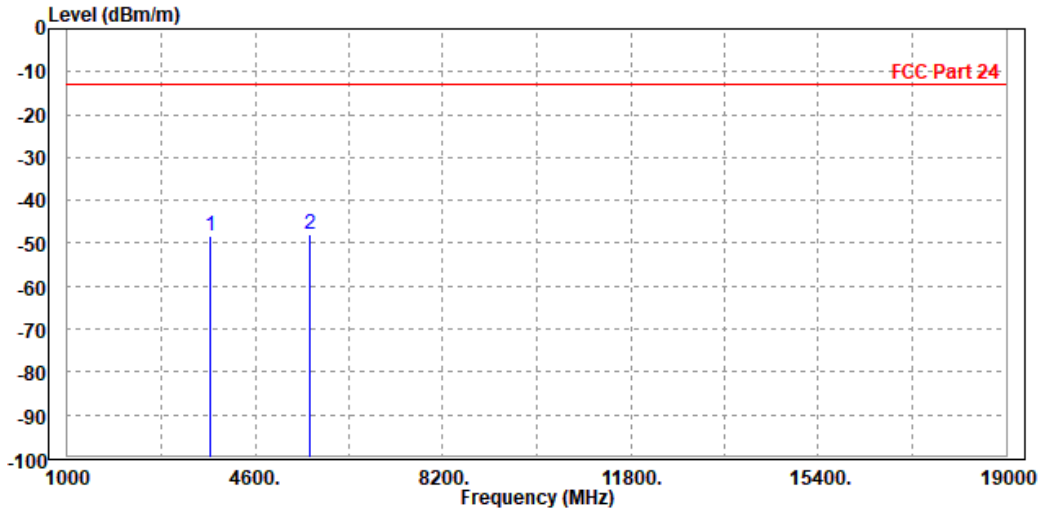



BUREAU VERITAS

Test Report No.: RF200520W003-2

CH 19125

MODE	TX channel 19125	FREQUENCY RANGE	Above 1000MHz
ENVIRONMENTAL CONDITIONS	23deg. C, 70%RH	INPUT POWER	DC 5V
TESTED BY	Tony		
ANTENNA POLARITY & TEST DISTANCE: HORIZONTAL AT 3 M			

	Freq	Level	Read Level	Limit Line	Over Limit	Factor	Remark	Pol/Phase
	MHz	dBm/m	dBm	dBm/m	dB	dB/m		
1	3808.000	-49.79	-58.69	-13.00	-36.79	8.90	Peak	Horizontal
2	PP 5707.500	-46.86	-57.57	-13.00	-33.86	10.71	Peak	Horizontal

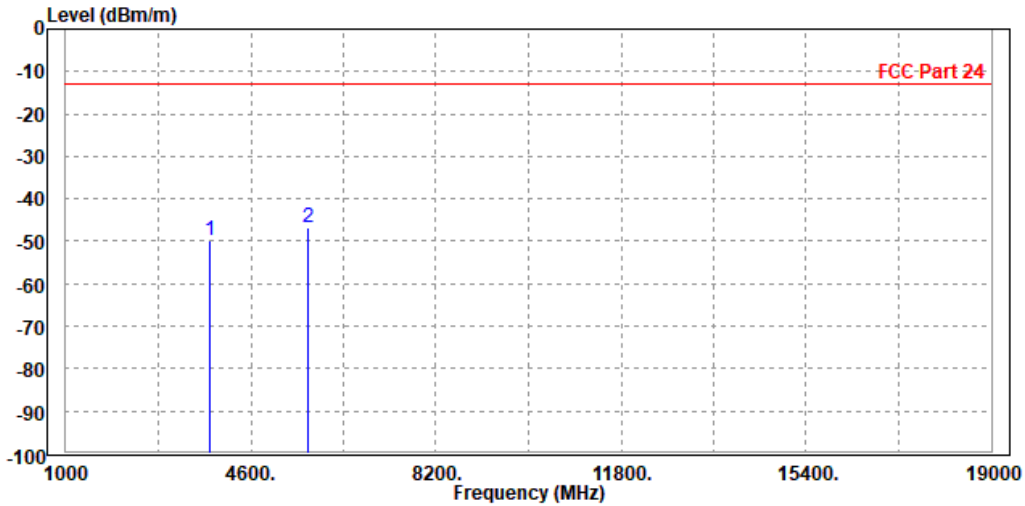



**BUREAU
VERITAS**

Test Report No.: RF200520W003-2

MODE	TX channel 19125	FREQUENCY RANGE	Above 1000MHz
ENVIRONMENTAL CONDITIONS	23deg. C, 70%RH	INPUT POWER	DC 5V
TESTED BY	Tony		
ANTENNA POLARITY & TEST DISTANCE: VERTICAL AT 3 M			

	Freq	Level	Read Level	Limit Line	Over Limit	Factor	Remark	Pol/Phase
	MHz	dBm/m	dBm	dBm/m	dB	dB/m		
1	3808.000	-48.40	-57.68	-13.00	-35.40	9.28	Peak	Vertical
2 PP	5707.500	-46.11	-56.62	-13.00	-33.11	10.51	Peak	Vertical

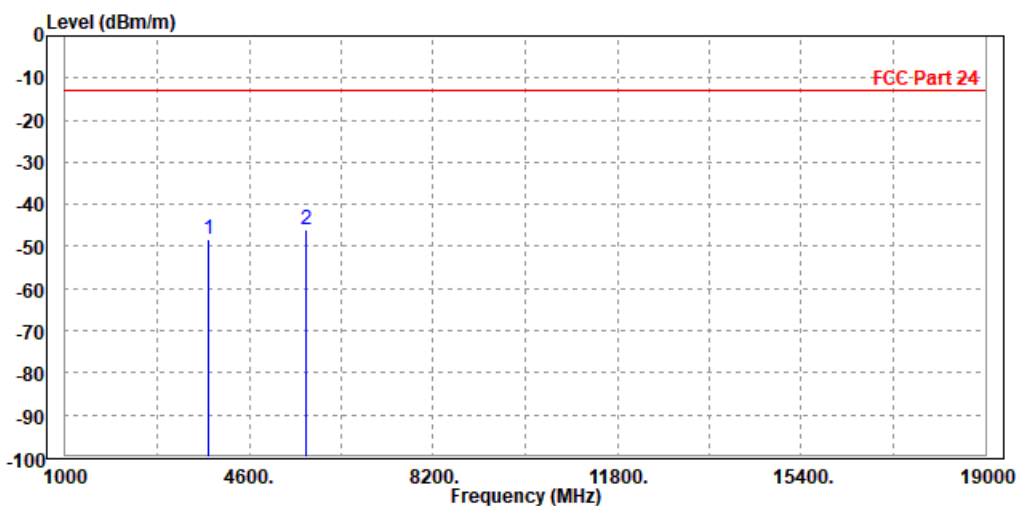



CHANNEL BANDWIDTH: 20MHz / QPSK

MODE	TX channel 18900	FREQUENCY RANGE	Above 1000MHz
ENVIRONMENTAL CONDITIONS	23deg. C, 70%RH	INPUT POWER	DC 5V
TESTED BY	Tony		
ANTENNA POLARITY & TEST DISTANCE: HORIZONTAL AT 3 M			

	Freq	Level	Read Level	Limit Line	Over Limit	Factor	Remark	Pol/Phase
	MHz	dBm/m	dBm	dBm/m	dB	dB/m		
1	3754.000	-48.11	-56.95	-13.00	-35.11	8.84	Peak	Horizontal
2 PP	5640.000	-48.00	-58.48	-13.00	-35.00	10.48	Peak	Horizontal

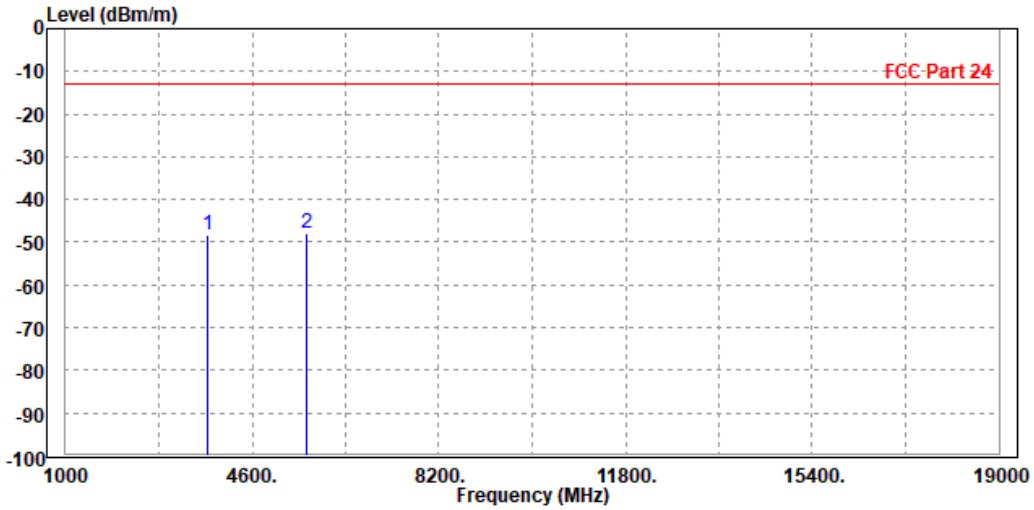



MODE	TX channel 18900	FREQUENCY RANGE	Above 1000MHz
ENVIRONMENTAL CONDITIONS	23deg. C, 70%RH	INPUT POWER	DC 5V
TESTED BY	Tony		
ANTENNA POLARITY & TEST DISTANCE: VERTICAL AT 3 M			

	Freq	Level	Read Level	Limit Line	Over Limit	Factor	Remark	Pol/Phase
	MHz	dBm/m	dBm	dBm/m	dB	dB/m		
1	PP 3754.000	-44.52	-53.79	-13.00	-31.52	9.27	Peak	Vertical
2	5640.000	-47.99	-58.24	-13.00	-34.99	10.25	Peak	Vertical

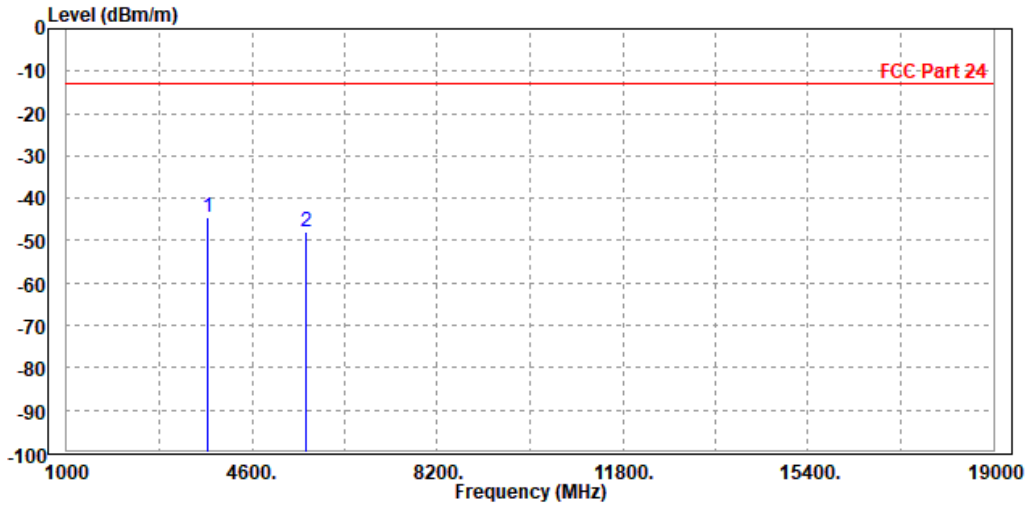



LTE Band 25

CHANNEL BANDWIDTH: 1.4MHz / QPSK

MODE	TX channel 26365	FREQUENCY RANGE	Above 1000MHz
ENVIRONMENTAL CONDITIONS	23deg. C, 70%RH	INPUT POWER	DC 5V
TESTED BY	Tony Xiong		
ANTENNA POLARITY & TEST DISTANCE: HORIZONTAL AT 3 M			

	Freq	Level	Read Level	Limit Line	Over Limit	Factor	Remark	Pol/Phase
	MHz	dBm/m	dBm	dBm/m	dB	dB/m		
1	PP 3765.000	-37.91	-46.77	-13.00	-24.91	8.86	Peak	Horizontal
2	5654.000	-42.22	-52.75	-13.00	-29.22	10.53	Peak	Horizontal

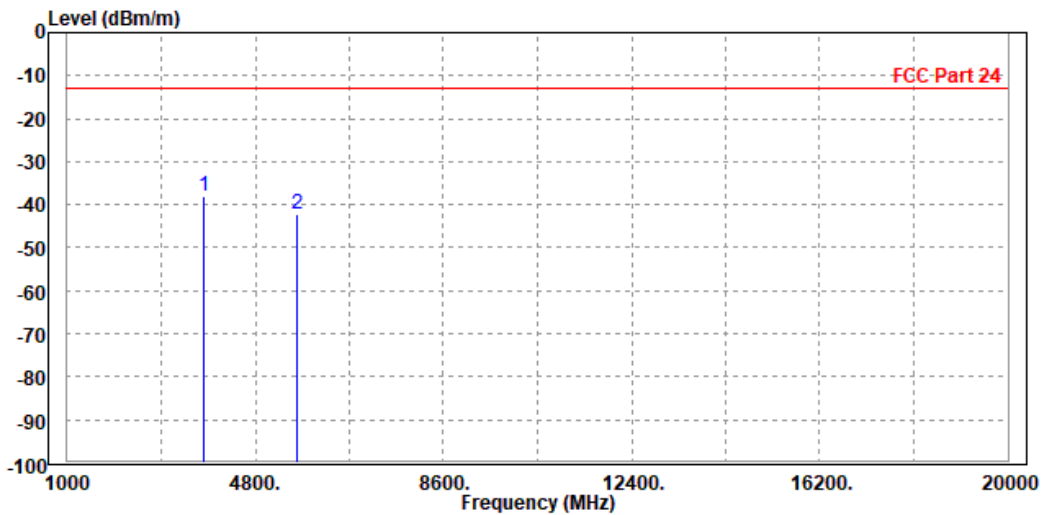



BUREAU VERITAS

Test Report No.: RF200520W003-2

MODE	TX channel 26365	FREQUENCY RANGE	Above 1000MHz
ENVIRONMENTAL CONDITIONS	23deg. C, 70%RH	INPUT POWER	DC 5V
TESTED BY	Tony Xiong		
ANTENNA POLARITY & TEST DISTANCE: VERTICAL AT 3 M			

	Freq	Level	Read Level	Limit Line	Over Limit	Factor	Remark	Pol/Phase
	MHz	dBm/m	dBm	dBm/m	dB	dB/m		
1	PP 3756.000	-33.98	-43.25	-13.00	-20.98	9.27	Peak	Vertical
2	5647.500	-42.11	-52.39	-13.00	-29.11	10.28	Peak	Vertical

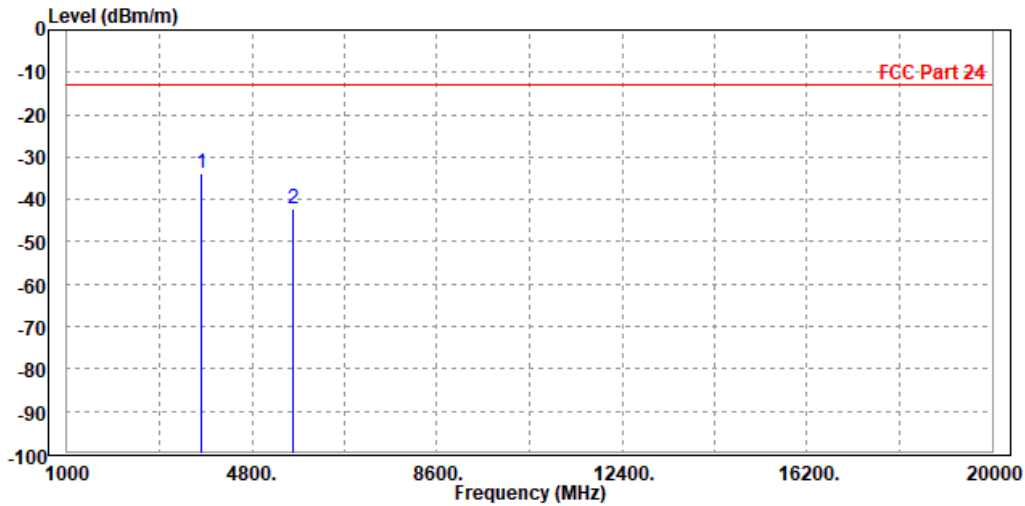



**BUREAU
VERITAS**

Test Report No.: RF200520W003-2

CHANNEL BANDWIDTH: 3MHz / QPSK

CH 26055

MODE	TX channel 26055	FREQUENCY RANGE	Above 1000MHz
ENVIRONMENTAL CONDITIONS	23deg. C, 70%RH	INPUT POWER	DC 5V
TESTED BY	Tony Xiong		
ANTENNA POLARITY & TEST DISTANCE: HORIZONTAL AT 3 M			

	Freq	Level	Read Level	Limit Line	Over Limit	Factor	Remark	Pol/Phase
	MHz	dBm/m	dBm	dBm/m	dB	dB/m		
1	PP 3704.000	-33.17	-41.96	-13.00	-20.17	8.79	Peak	Horizontal
2	5554.500	-36.04	-46.24	-13.00	-23.04	10.20	Peak	Horizontal

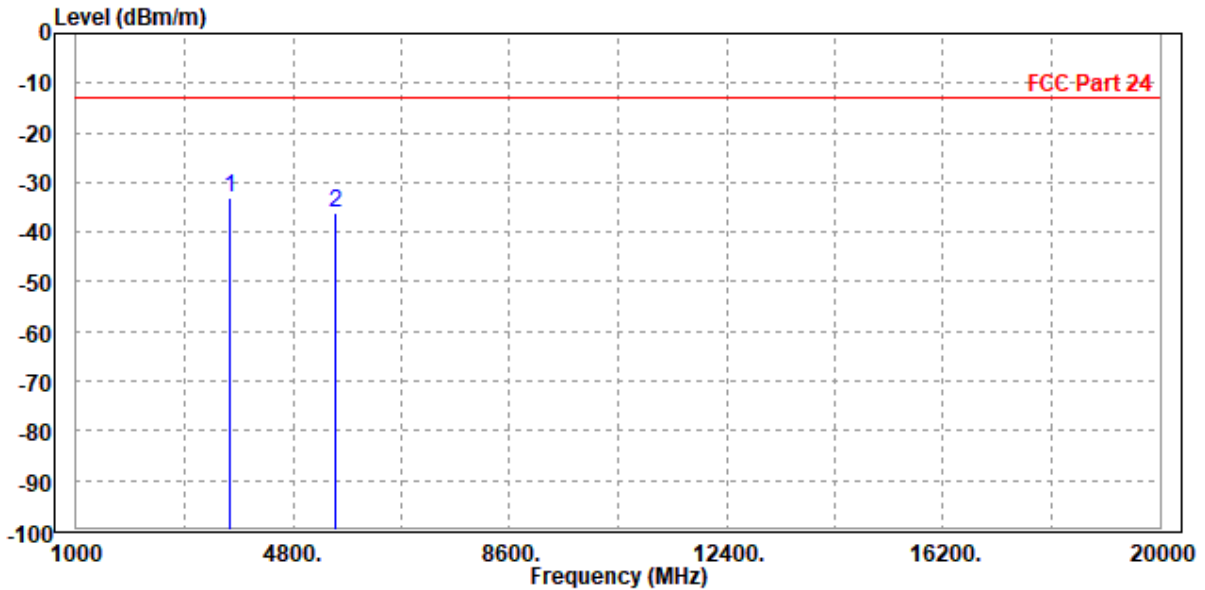



MODE	TX channel 26055	FREQUENCY RANGE	Above 1000MHz
ENVIRONMENTAL CONDITIONS	23deg. C, 70%RH	INPUT POWER	DC 5V
TESTED BY	Tony Xiong		
ANTENNA POLARITY & TEST DISTANCE: VERTICAL AT 3 M			

	Read	Limit	Over			
Freq	Level	Level	Line	Limit	Factor	Remark
MHz	dBm/m	dBm	dBm/m	dB	dB/m	Pol/Phase
1 PP 3703.000	-30.80	-40.05	-13.00	-17.80	9.25	Peak Vertical
2 5550.000	-38.80	-48.70	-13.00	-25.80	9.90	Peak Vertical

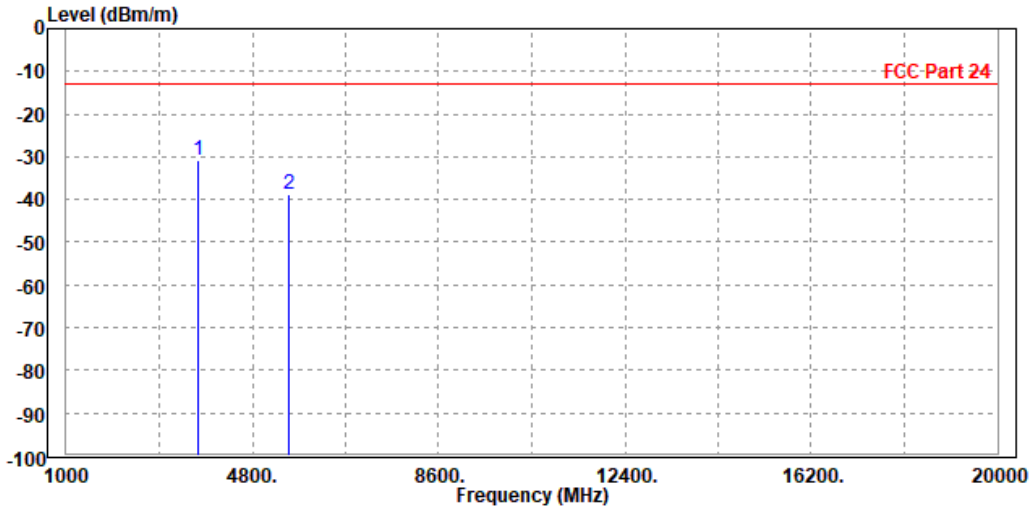



CH 26365

MODE	TX channel 26365	FREQUENCY RANGE	Above 1000MHz
ENVIRONMENTAL CONDITIONS	23deg. C, 70%RH	INPUT POWER	DC 5V
TESTED BY	Tony Xiong		
ANTENNA POLARITY & TEST DISTANCE: HORIZONTAL AT 3 M			

	Freq	Level	Read Level	Limit Line	Over Limit	Factor	Remark	Pol/Phase
	MHz	dBm/m	dBm	dBm/m	dB	dB/m		
1	PP 3756.000	-38.70	-47.55	-13.00	-25.70	8.85	Peak	Horizontal
2	5647.500	-45.05	-55.56	-13.00	-32.05	10.51	Peak	Horizontal

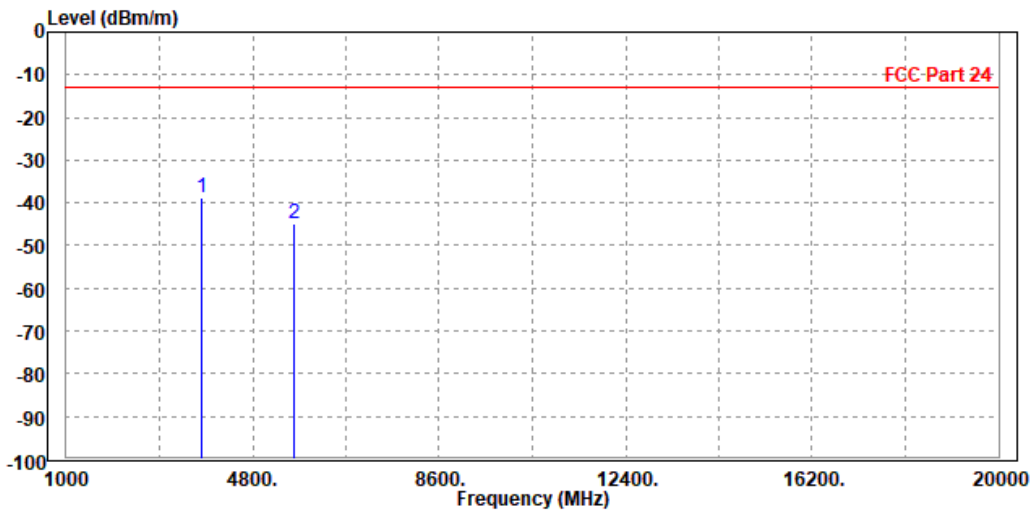



BUREAU VERITAS

Test Report No.: RF200520W003-2

MODE	TX channel 26365	FREQUENCY RANGE	Above 1000MHz
ENVIRONMENTAL CONDITIONS	23deg. C, 70%RH	INPUT POWER	DC 5V
TESTED BY	Tony Xiong		
ANTENNA POLARITY & TEST DISTANCE: VERTICAL AT 3 M			

	Freq	Level	Read Level	Limit Line	Over Limit	Factor	Remark	Pol/Phase
	MHz	dBm/m	dBm	dBm/m	dB	dB/m		
1	PP 3765.000	-35.34	-44.61	-13.00	-22.34	9.27	Peak	Vertical
2	5654.000	-45.19	-55.49	-13.00	-32.19	10.30	Peak	Vertical

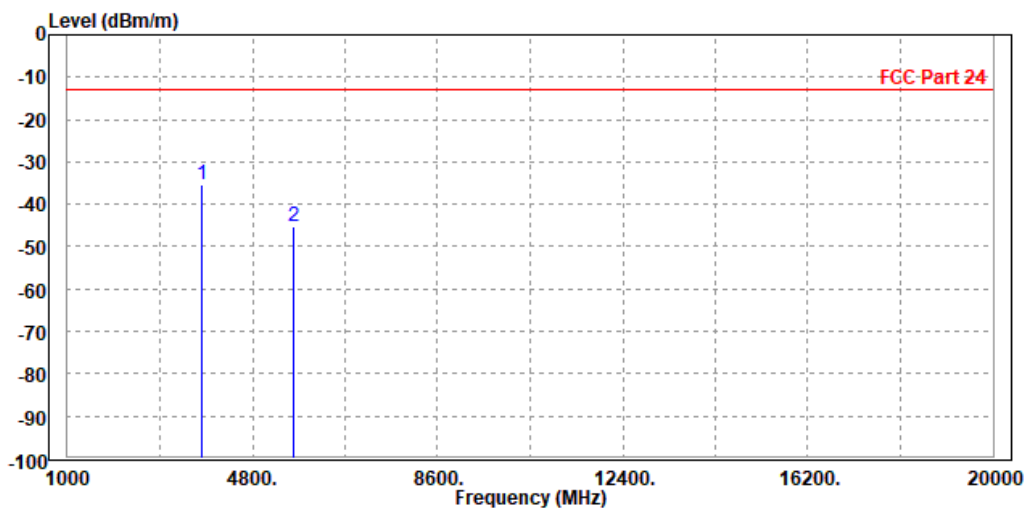



CH 26675

MODE	TX channel 26675	FREQUENCY RANGE	Above 1000MHz
ENVIRONMENTAL CONDITIONS	23deg. C, 70%RH	INPUT POWER	DC 5V
TESTED BY	Tony Xiong		
ANTENNA POLARITY & TEST DISTANCE: HORIZONTAL AT 3 M			

	Freq	Level	Read Level	Limit Line	Over Limit	Factor	Remark	Pol/Phase
	MHz	dBm/m	dBm	dBm/m	dB	dB/m		
1	PP 3827.000	-43.19	-52.11	-13.00	-30.19	8.92	Peak	Horizontal
2	5732.000	-46.20	-56.99	-13.00	-33.20	10.79	Peak	Horizontal

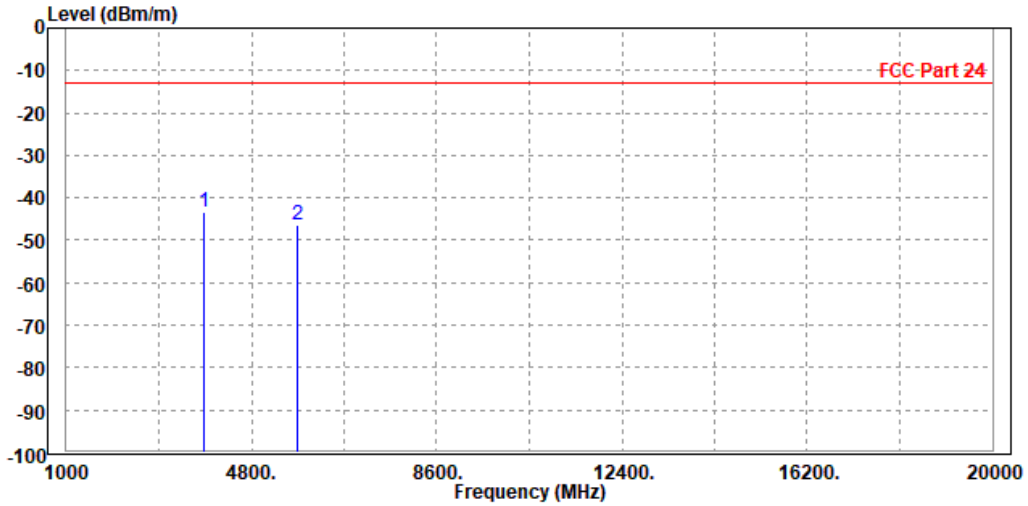



**BUREAU
VERITAS**

Test Report No.: RF200520W003-2

MODE	TX channel 26675	FREQUENCY RANGE	Above 1000MHz
ENVIRONMENTAL CONDITIONS	23deg. C, 70%RH	INPUT POWER	DC 5V
TESTED BY	Tony Xiong		
ANTENNA POLARITY & TEST DISTANCE: VERTICAL AT 3 M			

	Freq	Level	Read Level	Limit Line	Over Limit	Factor	Remark	Pol/Phase
	MHz	dBm/m	dBm	dBm/m	dB	dB/m		
1	PP 3834.000	-43.08	-52.37	-13.00	-30.08	9.29	Peak	Vertical
2	5740.500	-46.86	-57.50	-13.00	-33.86	10.64	Peak	Vertical

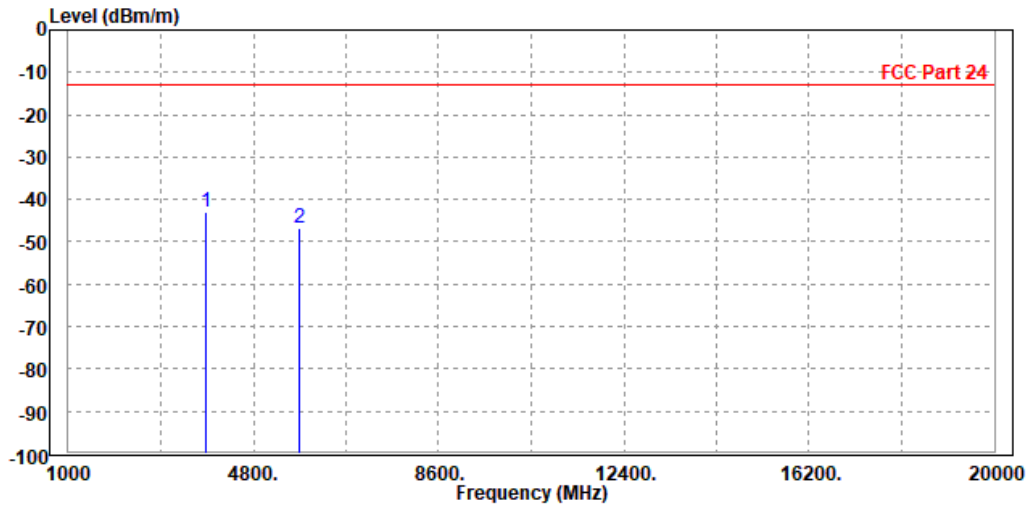



CHANNEL BANDWIDTH: 5MHz / QPSK

MODE	TX channel 26365	FREQUENCY RANGE	Above 1000MHz
ENVIRONMENTAL CONDITIONS	23deg. C, 70%RH	INPUT POWER	DC 5V
TESTED BY	Tony Xiong		
ANTENNA POLARITY & TEST DISTANCE: HORIZONTAL AT 3 M			

	Freq	Level	Read Level	Limit Line	Over Limit	Factor	Remark	Pol/Phase
	MHz	dBm/m	dBm	dBm/m	dB	dB/m		
1	PP 3765.000	-37.14	-46.00	-13.00	-24.14	8.86	Peak	Horizontal
2	5654.000	-42.05	-52.58	-13.00	-29.05	10.53	Peak	Horizontal

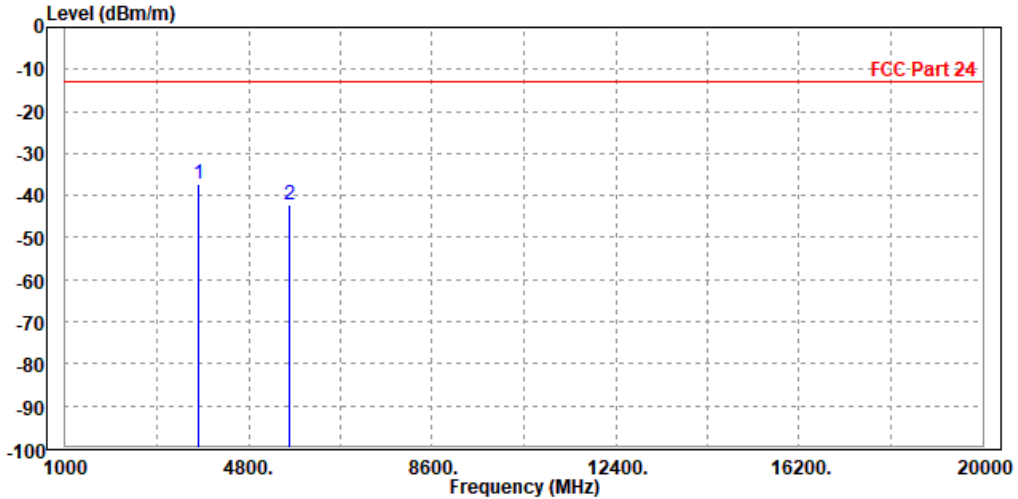



MODE	TX channel 26365	FREQUENCY RANGE	Above 1000MHz
ENVIRONMENTAL CONDITIONS	23deg. C, 70%RH	INPUT POWER	DC 5V
TESTED BY	Tony Xiong		
ANTENNA POLARITY & TEST DISTANCE: VERTICAL AT 3 M			

	Read	Limit	Over				
Freq	Level	Level	Line	Limit	Factor	Remark	Pol/Phase
MHz	dBm/m	dBm	dBm/m	dB	dB/m		
1 PP 3756.000	-35.82	-45.09	-13.00	-22.82	9.27	Peak	Vertical
2 5647.500	-41.63	-51.91	-13.00	-28.63	10.28	Peak	Vertical

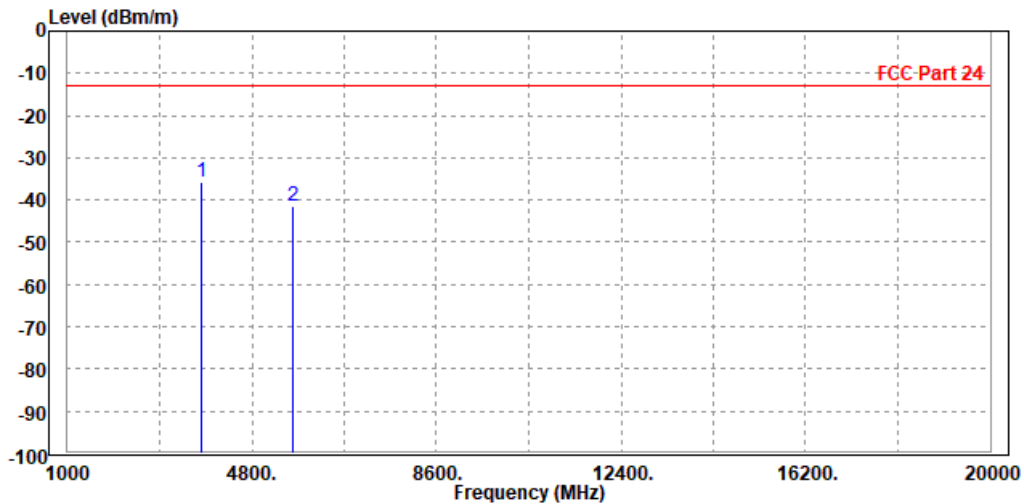



CHANNEL BANDWIDTH: 10MHz / QPSK

MODE	TX channel 26365	FREQUENCY RANGE	Above 1000MHz
ENVIRONMENTAL CONDITIONS	23deg. C, 70%RH	INPUT POWER	DC 5V
TESTED BY	Tony Xiong		
ANTENNA POLARITY & TEST DISTANCE: HORIZONTAL AT 3 M			

	Freq	Level	Read Level	Limit Line	Over Limit	Factor	Remark	Pol/Phase
	MHz	dBm/m	dBm	dBm/m	dB	dB/m		
1 PP	3765.000	-38.93	-47.79	-13.00	-25.93	8.86	Peak	Horizontal
2	5654.000	-43.03	-53.56	-13.00	-30.03	10.53	Peak	Horizontal

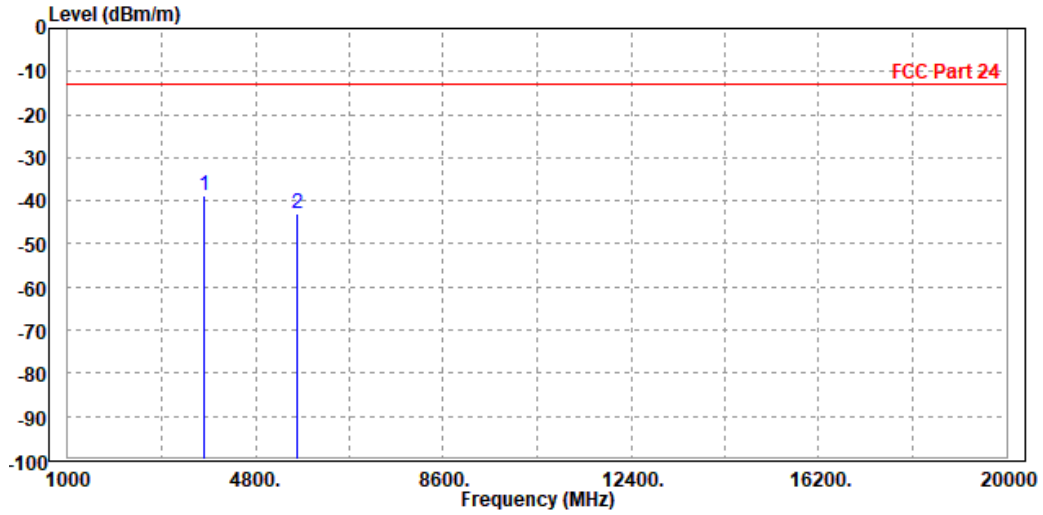



**BUREAU
VERITAS**

Test Report No.: RF200520W003-2

MODE	TX channel 26365	FREQUENCY RANGE	Above 1000MHz
ENVIRONMENTAL CONDITIONS	23deg. C, 70%RH	INPUT POWER	DC 5V
TESTED BY	Tony Xiong		
ANTENNA POLARITY & TEST DISTANCE: VERTICAL AT 3 M			

	Freq	Level	Read Level	Limit Line	Over Limit	Factor	Remark	Pol/Phase
	MHz	dBm/m	dBm	dBm/m	dB	dB/m		
1	PP 3756.000	-35.49	-44.76	-13.00	-22.49	9.27	Peak	Vertical
2	5647.500	-47.85	-58.13	-13.00	-34.85	10.28	Peak	Vertical

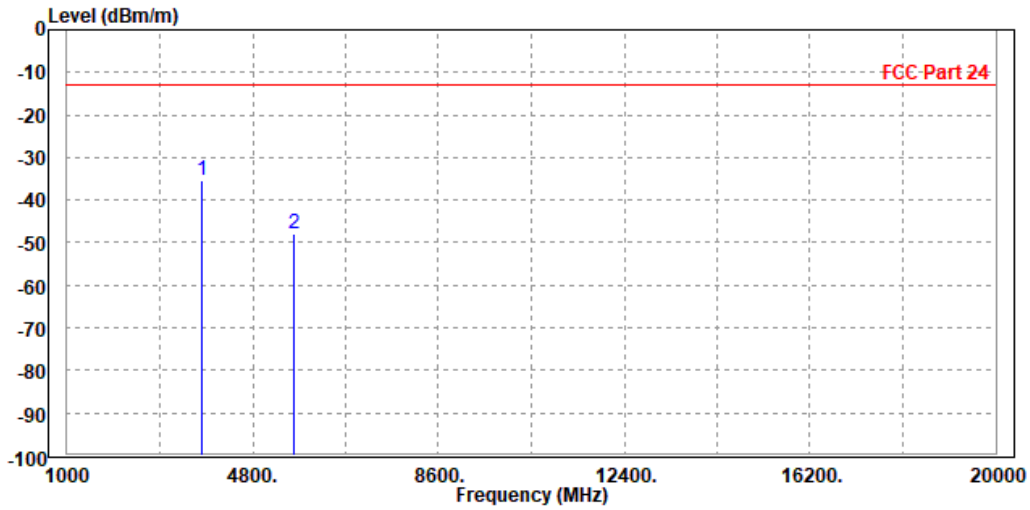



BUREAU VERITAS

Test Report No.: RF200520W003-2

CHANNEL BANDWIDTH: 15MHz / QPSK

MODE	TX channel 26365	FREQUENCY RANGE	Above 1000MHz
ENVIRONMENTAL CONDITIONS	23deg. C, 70%RH	INPUT POWER	DC 5V
TESTED BY	Tony Xiong		
ANTENNA POLARITY & TEST DISTANCE: HORIZONTAL AT 3 M			

	Freq	Level	Read Level	Limit Line	Over Limit	Factor	Remark	Pol/Phase
	MHz	dBm/m	dBm	dBm/m	dB	dB/m		
1	PP 3756.000	-42.48	-51.33	-13.00	-29.48	8.85	Peak	Horizontal
2	5647.500	-44.29	-54.80	-13.00	-31.29	10.51	Peak	Horizontal

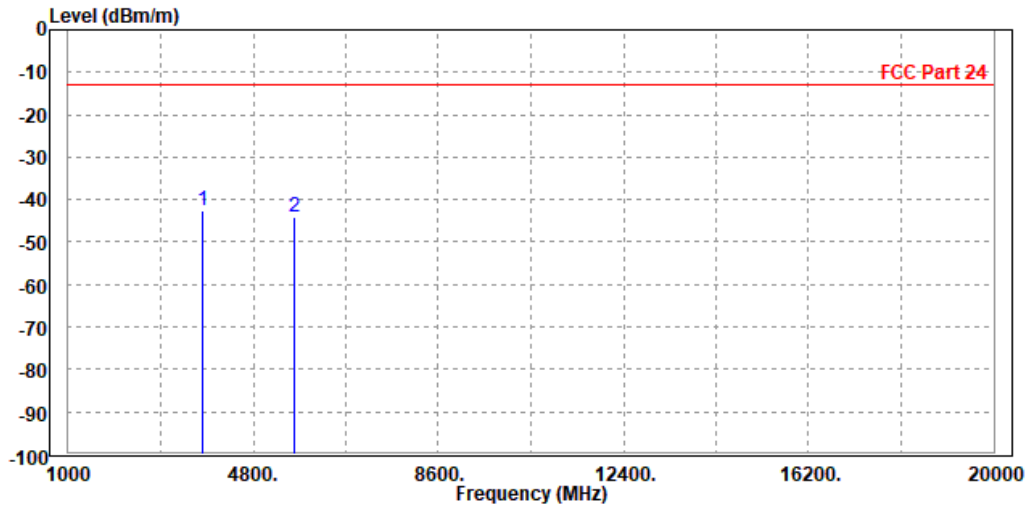



MODE	TX channel 26365	FREQUENCY RANGE	Above 1000MHz
ENVIRONMENTAL CONDITIONS	23deg. C, 70%RH	INPUT POWER	DC 5V
TESTED BY	Tony Xiong		
ANTENNA POLARITY & TEST DISTANCE: VERTICAL AT 3 M			

	Read	Limit	Over				
Freq	Level	Level	Line	Limit	Factor	Remark	Pol/Phase
MHz	dBm/m	dBm	dBm/m	dB	dB/m		
1 PP 3765.000	-35.40	-44.67	-13.00	-22.40	9.27	Peak	Vertical
2 5654.000	-48.11	-58.41	-13.00	-35.11	10.30	Peak	Vertical

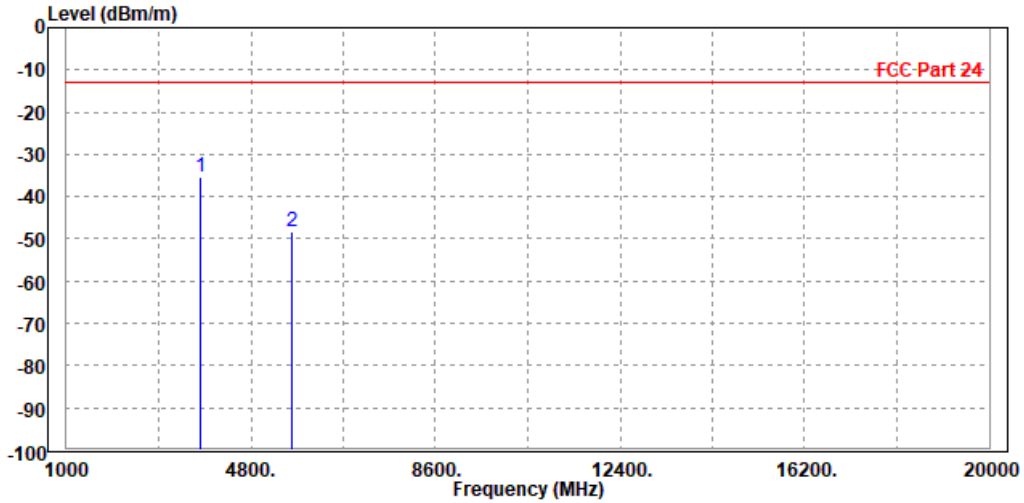



BUREAU VERITAS

Test Report No.: RF200520W003-2

CHANNEL BANDWIDTH: 20MHz / QPSK

MODE	TX channel 26365	FREQUENCY RANGE	Above 1000MHz
ENVIRONMENTAL CONDITIONS	23deg. C, 70%RH	INPUT POWER	DC 5V
TESTED BY	Tony Xiong		
ANTENNA POLARITY & TEST DISTANCE: HORIZONTAL AT 3 M			

	Freq	Level	Read Level	Limit Line	Over Limit	Factor	Remark	Pol/Phase
	MHz	dBm/m	dBm	dBm/m	dB	dB/m		
1 PP	3765.000	-38.17	-47.03	-13.00	-25.17	8.86	Peak	Horizontal
2	5654.000	-47.80	-58.33	-13.00	-34.80	10.53	Peak	Horizontal

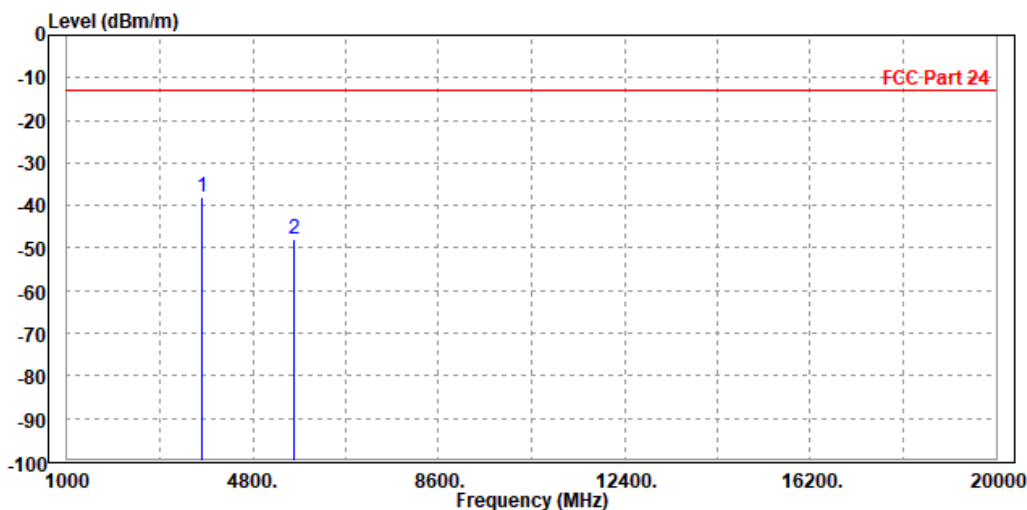



**BUREAU
VERITAS**

Test Report No.: RF200520W003-2

MODE	TX channel 26365	FREQUENCY RANGE	Above 1000MHz
ENVIRONMENTAL CONDITIONS	23deg. C, 70%RH	INPUT POWER	DC 5V
TESTED BY	Tony Xiong		
ANTENNA POLARITY & TEST DISTANCE: VERTICAL AT 3 M			

	Freq	Level	Read Level	Limit Line	Over Limit	Factor	Remark	Pol/Phase
	MHz	dBm/m	dBm	dBm/m	dB	dB/m		
1	PP 3756.000	-35.66	-44.93	-13.00	-22.66	9.27	Peak	Vertical
2	5647.500	-48.18	-58.46	-13.00	-35.18	10.28	Peak	Vertical

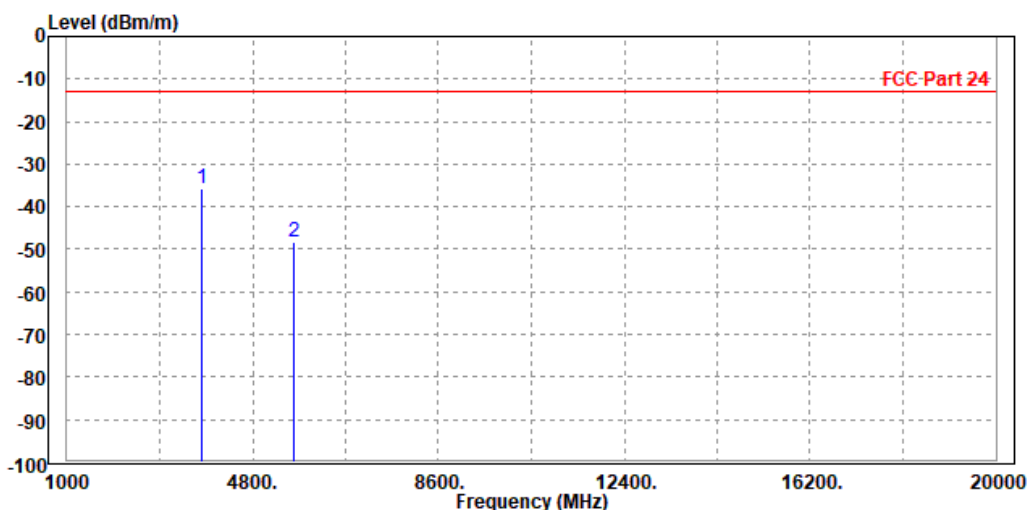



3.7 PEAK TO AVERAGE RATIO

3.7.1 LIMITS OF peak to average ratio MEASUREMENT

In measuring transmissions in this band using an average power technique, the peak to-average ratio (PAR) of the transmission may not exceed 13 dB

3.7.2 TEST SETUP

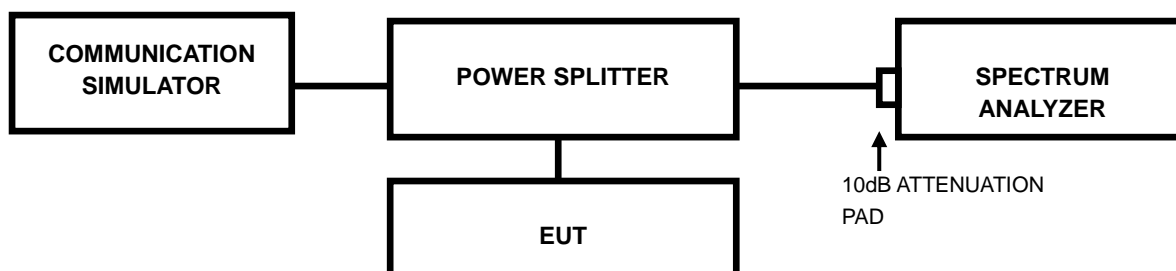

3.7.3 TEST PROCEDURES

1. Set resolution/measurement bandwidth \geq signal's occupied bandwidth;
2. Set the number of counts to a value that stabilizes the measured CCDF curve;
3. Record the maximum PAPR level associated with a probability of 0.1%.

3.7.4 TEST RESULTS

The test results was recorded in Report No.: R1811A0536-R2(FCC ID: XMR201707BG96).



BUREAU VERITAS Test Report No.: RF200520W003-2

4 INFORMATION ON THE TESTING LABORATORIES

We, BV 7LAYERS COMMUNICATIONS TECHNOLOGY (SHENZHEN) CO. LTD., were founded in 2015 to provide our best service in EMC, Radio, Telecom and Safety consultation. Our laboratories are accredited and approved according to ISO/IEC 17025.

If you have any comments, please feel free to contact us at the following:

Shenzhen EMC/RF Lab:

Tel: +86-755-88696566

Fax: +86-755-88696577

Email: customerservice.dg@cn.bureauveritas.com

Web Site: www.adt.com.tw

The address and road map of all our labs can be found in our web site also.



BUREAU VERITAS Test Report No.: RF200520W003-2

5 APPENDIX A – MODIFICATIONS RECORDERS FOR ENGINEERING CHANGES TO THE EUT BY THE LAB

No any modifications are made to the EUT by the lab during the test.

---END---