



Test Report No.: W7L-P23100004RF02



FCC TEST REPORT (PART 24)



Applicant:	Particle Industries, Inc
Address:	325 9th Street, San Francisco, CA 94103, United States Of America

Manufacturer or Supplier:	Particle Industries, Inc
Address:	325 9th Street, San Francisco, CA 94103, United States Of America
Product:	Montior One DE
Brand Name:	Particle
Model Name:	MON404-DE
FCC ID:	2AEMI-MONEDE
Date of tests:	Oct. 11, 2023 ~ Oct. 20, 2023

The tests have been carried out according to the requirements of the following standard:

- FCC PART 24, Subpart E
- FCC PART 2
- ANSI/TIA/EIA-603-D
- ANSI/TIA/EIA-603-E
- ANSI C63.26-2015

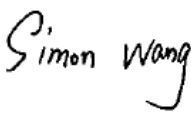
CONCLUSION: The submitted sample was found to COMPLY with the test requirement

Prepared by Simon Wang Engineer / Mobile Department	Approved by Luke Lu Manager / Mobile Department
	
Date: Oct. 20, 2023	Date: Oct. 20, 2023

This report is governed by, and incorporates by reference, the Conditions of Testing as posted at the date of issuance of this report at <http://www.bureauveritas.com/home/about-us/our-business/cps/about-us/terms-conditions/> and is intended for your exclusive use. Any copying or replication of this report to or for any other person or entity, or use of our name or trademark, is permitted only with our prior written permission. This report sets forth our findings solely with respect to the test samples identified herein. The results set forth in this report are not indicative or representative of the quality or characteristics of the lot from which a test sample was taken or any similar or identical product unless specifically and expressly noted. Our report includes all of the tests requested by you and the results thereof based upon the information that you provided to us. Measurement uncertainty is only provided upon request for accredited tests. Statements of conformity are based on simple acceptance criteria without taking measurement uncertainty into account, unless otherwise requested in writing. You have 60 days from date of issuance of this report to notify us of any material error or omission caused by our negligence or if you require measurement uncertainty; provided, however, that such notice shall be in writing and shall specifically address the issue you wish to raise. A failure to raise such issue within the prescribed time shall constitute your unqualified acceptance of the completeness of this report, the tests conducted and the correctness of the report contents.



TABLE OF CONTENTS

RELEASE CONTROL RECORD4

1 SUMMARY OF TEST RESULTS5

1.1 MEASUREMENT UNCERTAINTY6

1.2 TEST SITE AND INSTRUMENTS7

2 GENERAL INFORMATION8

2.1 GENERAL DESCRIPTION OF EUT8

2.2 CONFIGURATION OF SYSTEM UNDER TEST 12

2.3 DESCRIPTION OF SUPPORT UNITS 13

2.4 TEST ITEM AND TEST CONFIGURATION..... 13

2.5 EUT OPERATING CONDITIONS 16

2.6 GENERAL DESCRIPTION OF APPLIED STANDARDS 16

3 TEST TYPES AND RESULTS17

3.1 OUTPUT POWER MEASUREMENT 17

3.1.1 LIMITS OF OUTPUT POWER MEASUREMENT 17

3.1.2 TEST PROCEDURES 17

3.1.3 TEST SETUP 18

3.1.4 TEST RESULTS 18

3.2 FREQUENCY STABILITY MEASUREMENT 32

3.2.1 LIMITS OF FREQUENCY STABILITY MEASUREMENT 32

3.2.2 TEST PROCEDURE 32

3.2.3 TEST SETUP 32

3.2.4 TEST RESULTS 33

3.3 OCCUPIED BANDWIDTH MEASUREMENT 34

3.3.1 LIMITS OF OCCUPIED BANDWIDTH MEASUREMENT 34

3.3.2 TEST SETUP 34

3.3.3 TEST PROCEDURES 34

3.3.4 TEST RESULTS 35

3.4 BAND EDGE MEASUREMENTC 36

3.4.1 LIMITS OF BAND EDGE MEASUREMENT 36

3.4.2 TEST SETUP 36

3.4.3 TEST PROCEDURES 37

3.4.4. TEST RESULTS 38

3.5 CONDUCTED SPURIOUS EMISSIONS..... 39

3.5.1 LIMITS OF CONDUCTED SPURIOUS EMISSIONS MEASUREMENT 39

3.5.2 TEST PROCEDURE 39

3.5.3 TEST SETUP 39

3.5.4 TEST RESULTS 40

3.6 RADIATED EMISSION MEASUREMENT 41

3.6.1 LIMITS OF RADIATED EMISSION MEASUREMENT 41

3.6.2 TEST PROCEDURES 41



**BUREAU
VERITAS**

Test Report No.: W7L-P23100004RF02

3.6.3 DEVIATION FROM TEST STANDARD	41
3.6.4 TEST SETUP	42
3.6.5 TEST RESULTS	44
3.7 PEAK TO AVERAGE RATIO	74
3.7.1 LIMITS OF PEAK TO AVERAGE RATIO MEASUREMENT	74
3.7.2 TEST SETUP	74
3.7.3 TEST PROCEDURES	74
3.7.4 TEST RESULTS	75
4 INFORMATION ON THE TESTING LABORATORIES	76
5 MODIFICATIONS RECORDERS FOR ENGINEERING CHANGES TO THE EUT BY THE LAB.....	77



BUREAU
VERITAS

Test Report No.: W7L-P23100004RF02

RELEASE CONTROL RECORD

ISSUE NO.	REASON FOR CHANGE	DATE ISSUED
W7L-P23100004RF02	Original release	Oct. 20, 2023



1 SUMMARY OF TEST RESULTS

The EUT has been tested according to the following specifications:

APPLIED STANDARD: FCC Part 24 & Part 2		
STANDARD SECTION	TEST TYPE	RESULT
§2.1046	Conducted Output Power	Compliance
§24.232(c)	Equivalent Isotropic Radiated Power	Compliance
§2.1055 §24.235	Frequency Stability	See Note
§2.1049	Occupied Bandwidth	See Note
§24.232(d)	Peak to average ratio	See Note
§24.238(a)(b)	Band Edge Measurements	See Note
§2.1051 §24.238(a)(b)	Conducted Spurious Emissions	See Note
§2.1053 §24.238(a)(b)	Radiated Spurious Emissions	Compliance

NOTE: Refer to Module report R2007A0435-R5, FCC ID:XMR201707BG96.

1.1 MEASUREMENT UNCERTAINTY

Where relevant, the following measurement uncertainty levels have been estimated for tests performed on the EUT as specified in CISPR 16-4-2:

MEASUREMENT	UNCERTAINTY
Frequency Stability	$\pm 76.97\text{Hz}$
Radiated emissions (9KHz~30MHz)	$\pm 2.68\text{dB}$
Radiated emissions & Radiated Power (30MHz~1GHz)	$\pm 4.98\text{dB}$
Radiated emissions & Radiated Power (1GHz ~6GHz)	$\pm 4.70\text{dB}$
Radiated emissions (6GHz ~18GHz)	$\pm 4.60\text{dB}$
Radiated emissions (18GHz ~40GHz)	$\pm 4.12\text{dB}$
Conducted emissions	$\pm 4.01\text{dB}$
Occupied Channel Bandwidth	$\pm 43.58\text{KHz}$
Conducted Output power	$\pm 2.06\text{dB}$
Band Edge Measurements	$\pm 4.70\text{dB}$
Peak to average ratio	$\pm 0.76\text{dB}$

This uncertainty represents an expanded uncertainty expressed at approximately the 95% confidence level using a coverage factor of $k=2$.



1.2 TEST SITE AND INSTRUMENTS

Equipment	Manufacturer	Model No.	Serial No.	Last Cal.	Next Cal.
MXE EMI Receiver	KEYSIGHT	N9038A-544	MY54450026	Mar. 28,23	Mar. 27,24
EXA Signal Analyzer	KEYSIGHT	N9010A-544	MY54510355	May.10,23	May.09,24
Loop Antenna	Schwarzbeck	FMZB 1519B	00173	Sep.02,23	Sep.01,24
Bilog Antenna	ETS-LINDGRE N	3143B	00161965	Feb. 18,23	Feb. 17,24
Horn Antenna	ETS-LINDGRE N	3117	00168692	Feb. 18,23	Feb. 17,24
Horn Antenna (18GHz-40GHz)	N/A	QWH-SL-18-40-K- SG/QMS-00361	15433	Sep.03, 23	Sep.02, 24
Radio Communication Analyzer	ANRITSU	MT8820C	6201465426	Feb. 14,23	Feb. 13,24
Signal Pre-Amplifier	EMSI	EMC 9135	980249	May. 06,23	May. 05,24
Signal Pre-Amplifier	EMSI	EMC 012645B	980257	May.10,23	May.09,24
Signal Pre-Amplifier	EMSI	EMC 184045B	980259	Feb. 17,23	Feb.16,24
3m Semi-anechoic Chamber	ETS-LINDGRE N	9m*6m*6m	Euroshieldpn- CT0001143-121 6	May. 22, 23	May. 21,26
Test Software	E3	V 9.160323	N/A	N/A	N/A
Test Software	JS1120	3.1.36	N/A	N/A	N/A
10dB Attenuator	JFW/USA	50HF-010-SMA	50HF-010-SMA	May. 06,23	May. 05,24
Power Meter	Anritsu	ML2495A	1506002	Feb. 14,23	Feb. 13,24
Power Sensor	Anritsu	MA2411B	1339352	Feb. 14,23	Feb. 13,24
Temperature Chamber	ESPEC	SH-242	93000855	May. 06,23	May. 05,24
MXG Analog Microwave Signal Generator	KEYSIGHT	N5183A	MY50143024	Feb. 14,23	Feb. 13,24
Base station R&S CMW500	Rohde&Schwa rz	CMW500	153085	May.10,23	May.09,24
DC Source	Kikusui/JP	PMX18-5A	N/A	Aug. 11,23	Aug. 10,24

- NOTE:** 1. The calibration interval of the above test instruments is 12 months or 36 months and the calibrations are traceable to CEPREI/CHINA, GRGT/CHINA and NIM/CHINA.
2. The test was performed in 3m Semi-anechoic Chamber and RF Oven Room.
3. The horn antenna is used only for the measurement of emission frequency above 1GHz if tested.
4. The FCC Site Registration No. is 525120; The Designation No. is CN1171.



2 GENERAL INFORMATION

2.1 GENERAL DESCRIPTION OF EUT

PRODUCT	Montior One DE	
BRAND NAME	Particle	
MODEL NAME	MON404-DE	
NOMINAL VOLTAGE	24Vdc(adapter or host equipment) 3.7Vdc (Li-ion, battery)	
MODULATION TYPE	GSM: GMSK EDGE: 8PSK LTE CAT-M1: Band 2/25: QPSK, 16QAM	
FREQUENCY RANGE	GSM, EDGE	1850.2MHz ~ 1909.8MHz
	LTE Band 2 Channel Bandwidth: 1.4MHz	1850.7MHz ~ 1909.3MHz
	LTE Band 2 Channel Bandwidth: 3MHz	1851.5MHz ~ 1908.5MHz
	LTE Band 2 Channel Bandwidth: 5MHz	1852.5MHz ~ 1907.5MHz
	LTE Band 2 Channel Bandwidth: 10MHz	1855.0MHz ~ 1905.0MHz
	LTE Band 2 Channel Bandwidth: 15MHz	1857.5MHz ~ 1902.5MHz
	LTE Band 2 Channel Bandwidth: 20MHz	1860.0MHz ~ 1900.0MHz
	LTE Band 25 Channel Bandwidth: 1.4MHz	1850.7MHz ~ 1914.3MHz
	LTE Band 25 Channel Bandwidth: 3MHz	1851.5MHz ~ 1913.5MHz
	LTE Band 25 Channel Bandwidth: 5MHz	1852.5MHz ~ 1912.5MHz
	LTE Band 25 Channel Bandwidth: 10MHz	1855.0MHz ~ 1910.0MHz
	LTE Band 25 Channel Bandwidth: 15MHz	1857.5MHz ~ 1907.5MHz
	LTE Band 25 Channel Bandwidth: 20MHz	1860.0MHz ~ 1905.0MHz
	MAX. EIRP POWER	GSM
EDGE		722.77mW
LTE Band 2 Channel Bandwidth: 1.4MHz		425.6mW
LTE Band 2 Channel Bandwidth: 3MHz		430.53mW



MAX. EIRP POWER	LTE Band 2 Channel Bandwidth: 5MHz	423.64mW
	LTE Band 2 Channel Bandwidth: 10MHz	431.52mW
	LTE Band 2 Channel Bandwidth: 15MHz	432.51mW
	LTE Band 2 Channel Bandwidth: 20MHz	437.52mW
	LTE Band 25 Channel Bandwidth: 1.4MHz	473.15mW
	LTE Band 25 Channel Bandwidth: 3MHz	473.15mW
	LTE Band 25 Channel Bandwidth: 5MHz	470.98mW
	LTE Band 25 Channel Bandwidth: 10MHz	470.98mW
	LTE Band 25 Channel Bandwidth: 15MHz	467.74mW
	LTE Band 25 Channel Bandwidth: 20MHz	475.34mW
	EMISSION DESIGNATOR	GSM
EDGE		248KG7W
LTE Band 2 Channel Bandwidth: 1.4MHz		QPSK: 1M11G7D
		16QAM: 948KW7D
		64QAM: /
LTE Band 2 Channel Bandwidth: 3MHz		QPSK: 1M16G7D
		16QAM: 985KW7D
		64QAM: /
LTE Band 2 Channel Bandwidth: 5MHz		QPSK: 1M17G7D
		16QAM: 1M01W7D
		64QAM: /
LTE Band 2 Channel Bandwidth: 10MHz		QPSK: 1M19G7D
		16QAM: 1M19W7D
	64QAM: /	
LTE Band 2 Channel Bandwidth: 15MHz	QPSK: 1M22G7D	
	16QAM: 1M90W7D	
	64QAM: /	



EMISSION DESIGNATOR	LTE Band 2 Channel Bandwidth: 20MHz	QPSK: 1M25G7D	
		16QAM: 951KW7D	
		64QAM: /	
	LTE Band 25 Channel Bandwidth: 1.4MHz	QPSK: 1M11G7D	
		16QAM: 951KW7D	
		64QAM: /	
	LTE Band 25 Channel Bandwidth: 3MHz	QPSK: 1M16G7D	
		16QAM: 992KW7D	
		64QAM: /	
	LTE Band 25 Channel Bandwidth: 5MHz	QPSK: 1M14G7D	
		16QAM: 975KW7D	
		64QAM: /	
	LTE Band 25 Channel Bandwidth: 10MHz	QPSK: 1M18G7D	
		16QAM: 1M05W7D	
		64QAM: /	
	LTE Band 25 Channel Bandwidth: 15MHz	QPSK: 1M20G7D	
		16QAM: 1M06W7D	
		64QAM: /	
	LTE Band 25 Channel Bandwidth: 20MHz	QPSK: 1M21G7D	
		16QAM: 1M11W7D	
		64QAM: /	
	ANTENNA TYPE	Fixed External Antenna with 3.47dBi gain for GSM1900/ LTE B2/ LTE B25	
	HW VERSION	v1.2.0	
	SW VERSION	v4.0.2	
I/O PORTS	Refer to user's manual		
CABLE SUPPLIED	Cable 1: non-shielded cable, with w/o ferrite core, 1.5 meter Cable 2: non-shielded cable, with w/o ferrite core, 1.5 meter		
EXTREME TEMPERATURE	-20~60 °C		
EXTREME VOLTAGE	3.6V - 4.2V		

NOTE:

1. For a more detailed features description, please refer to the manufacturer's specifications or the user's manual.



- 2. The EUT incorporates a SISO function. Physically, the EUT provides one completed transmitter and one receiver.

MODULATION MODE	TX FUNCTION
GSM/GPRS/EDGE	1TX/1RX
LTE	1TX/1RX

- 3. For the test results, the EUT had been tested with all conditions. But only the worst case was shown in test report.

List of Accessory:

ACCESSORIES	BRAND	MANUFACTURER	MODEL	SPECIFICATION
Battery	Guangdong Zhaoneng	Guangdong Zhaoneng	ZN18650-4P	Capacity: 3.7Vdc, 12200mAh
AC Adapter	TRI-MAG	TRI-MAG LLC	L6R30-240	I/P: 100-240Vac, 0.8A, O/P: 24Vdc, 1.25A
Cable 1	KAWEEI	KAWEEI technology	CBH-M12M-04 -1500	Signal Line, 1.5meter
Cable 2	KAWEEI	KAWEEI technology	115-00014 CBH-M12M-08 -1500	Signal Line, 1.5meter



2.2 CONFIGURATION OF SYSTEM UNDER TEST

FOR RADIATION EMISSION TEST

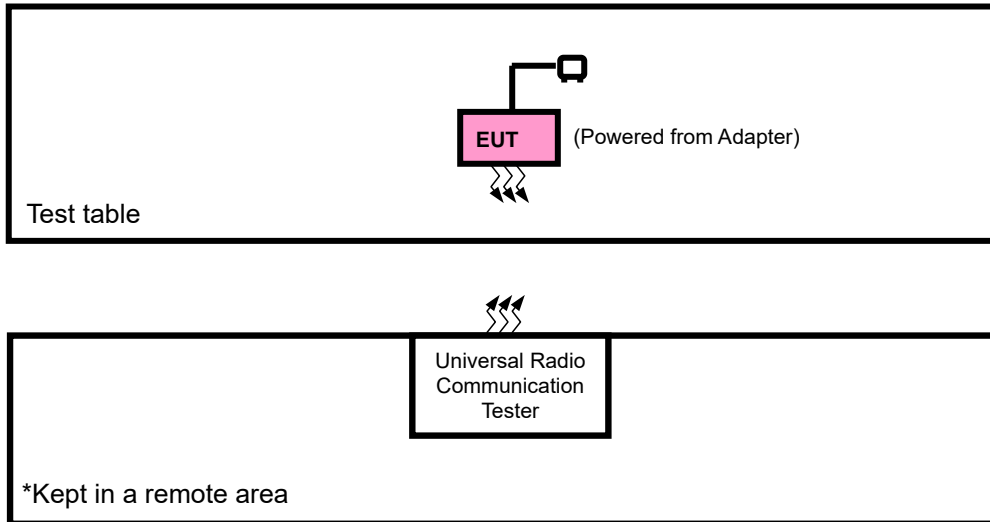



2.3 DESCRIPTION OF SUPPORT UNITS

The EUT has been tested as an independent unit together with other necessary accessories or support units. The following support units or accessories were used to form a representative test configuration during the tests.

NO.	PRODUCT	BRAND	MODEL NO.	SERIAL NO.	FCC ID
1	Adapter	Jingsai	CLS-050200	NA	N/A

NO.	SIGNAL CABLE DESCRIPTION OF THE ABOVE SUPPORT UNITS
1	N/A

2.4 TEST ITEM AND TEST CONFIGURATION

Pre-Scan has been conducted to determine the worst-case mode from all possible combinations between available modulations, data rates, XYZ axis and antenna ports. The worst case in EIRP and radiated emission was found when positioned on X-plane for GSM/EDGE/ LTE. Following channel(s) was (were) selected for the final test as listed below:

EUT CONFIGURE MODE	DESCRIPTION
A	EUT + Adapter with GSM or LTE link

GSM MODE

EUT CONFIGURE MODE	TEST ITEM	AVAILABLE CHANNEL	TESTED CHANNEL	MODE
A	EIRP	512 to 810	512, 661, 810	GSM,EDGE
A	RADIATED EMISSION	512 to 810	512, 661, 810	GSM,EDGE



LTE BAND 2 MODE

EUT CONFIGURE MODE	TEST ITEM	AVAILABLE CHANNEL	TESTED CHANNEL	CHANNEL BANDWIDTH	MODULATION	MODE
A	EIRP	18607 to 19193	18607, 18900, 19193	1.4MHz	QPSK,16QAM	1 RB / 0 RB Offset
		18615 to 19185	18615, 18900, 19185	3MHz	QPSK,16QAM	1 RB / 0 RB Offset
		18625 to 19175	18625, 18900, 19175	5MHz	QPSK,16QAM	1 RB / 0 RB Offset
		18650 to 19150	18650, 18900, 19150	10MHz	QPSK,16QAM	1 RB / 0 RB Offset
		18675 to 19125	18675, 18900, 19125	15MHz	QPSK,16QAM	1 RB / 0 RB Offset
		18700 to 19100	18700, 18900, 19100	20MHz	QPSK,16QAM	1 RB / 0 RB Offset

Note: 1.This device was tested under all bandwidths, RB configurations and modulations. The worst case was found in QPSK modulation.

2. LTE Band 2 are covered by LTE Band 25, Because it is a subset of LTE Band 25 with the same output power and supported bandwidths, So the conducted test data and RSE test data please refer to LTE Band 25



LTE BAND 25 MODE

EUT CONFIGURE MODE	TEST ITEM	AVAILABLE CHANNEL	TESTED CHANNEL	CHANNEL BANDWIDTH	MODULATION	MODE
A	EIRP	26047 to 26683	26047, 26365, 26683	1.4MHz	QPSK,16QAM	1 RB / 0 RB Offset
		26055 to 26675	26055, 26365, 26675	3MHz	QPSK,16QAM	1 RB / 0 RB Offset
		26065 to 26665	26065, 26365, 26665	5MHz	QPSK,16QAM	1 RB / 0 RB Offset
		26090 to 26640	26090, 26365, 26640	10MHz	QPSK,16QAM	1 RB / 0 RB Offset
		26115 to 26615	26115, 26365, 26615	15MHz	QPSK,16QAM	1 RB / 0 RB Offset
		26140 to 26590	26140, 26365, 26590	20MHz	QPSK,16QAM	1 RB / 0 RB Offset
A	RADIATED EMISSION	26047 to 26683	26365	1.4MHz	QPSK	1 RB / 0 RB Offset
		26055 to 26675	26365	3MHz	QPSK	1 RB / 0 RB Offset
		26065 to 26665	26365	5MHz	QPSK	1 RB / 0 RB Offset
		26090 to 26640	26365	10MHz	QPSK	1 RB / 0 RB Offset
		26115 to 26615	26115, 26365, 26615	15MHz	QPSK	1 RB / 0 RB Offset
		26140 to 26590	26365	20MHz	QPSK	1 RB / 0 RB Offset

Note: This device was tested under all bandwidths, RB configurations and modulations. The worst case was found in QPSK modulation.



TEST CONDITION:

TEST ITEM	ENVIRONMENTAL CONDITIONS	INPUT POWER	TESTED BY
EIRP	25deg. C, 57%RH	DC 24V By Adapter	Jace Hu
RADIATED EMISSION	23deg. C, 70%RH	DC 24V By Adapter	Jace Hu

2.5 EUT OPERATING CONDITIONS

The EUT makes a call to the communication simulator. The communication simulator station system controlled a EUT to export maximum output power under transmission mode and specific channel frequency

2.6 GENERAL DESCRIPTION OF APPLIED STANDARDS

The EUT is a RF product. According to the specifications of the manufacturer, it must comply with the requirements of the following standards:

FCC 47 CFR Part 2

FCC 47 CFR Part 24

KDB 971168 D01 Power Meas License Digital Systems v03r01

ANSI/TIA/EIA-603-D

ANSI/TIA/EIA-603-E

ANSI C63.26-2015

NOTE: All test items have been performed and recorded as per the above standards.

3 TEST TYPES AND RESULTS

3.1 OUTPUT POWER MEASUREMENT

3.1.1 LIMITS OF OUTPUT POWER MEASUREMENT

Mobile and portable stations are limited to 2 watts EIRP.

3.1.2 TEST PROCEDURES

EIRP MEASUREMENT:

Per KDB 971168 D01 Power Meas License Digital Systems v03r01 or subclause 5.2.5.5 of ANSI C63.26-2015, the relevant equation for determining the ERP or EIRP from the conducted RF output power measured using the guidance provided above is:

$$\text{ERP or EIRP} = P_{\text{Meas}} + G_{\text{T}} - L_{\text{C}}$$

Where:

ERP or EIRP = effective radiated power or equivalent isotropically radiated power, respectively

(expressed in the same units as P_{Meas} , typically dBW or dBm);

P_{Meas} = measured transmitter output power or PSD, in dBm or dBW;

G_{T} = gain of the transmitting antenna, in dBd (ERP) or dBi (EIRP);

L_{C} = signal attenuation in the connecting cable between the transmitter and antenna, in dB.

CONDUCTED POWER MEASUREMENT:

The EUT was set up for the maximum power with WCDMA link data modulation and link up with simulator. Set the EUT to transmit under low, middle and high channel and record the power level shown on simulator.



3.1.3 TEST SETUP

EIRP / ERP Measurement:

CONDUCTED POWER MEASUREMENT:

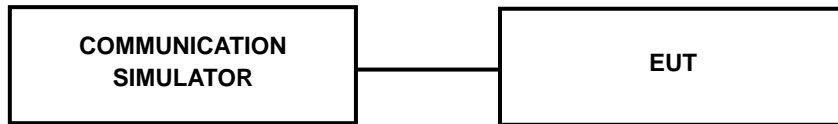

3.1.4 TEST RESULTS

CONDUCTED OUTPUT POWER (dBm)

Band	GSM1900		
	512	661	810
Channel	1850.2	1880	1909.8
Frequency (MHz)	1850.2	1880	1909.8
GPRS (GMSK, 1Tx-slot)	29.35	29.28	29.43
GPRS (GMSK, 2Tx-slot)	29.25	29.19	29.32
GPRS (GMSK, 3Tx-slot)	29.12	29.10	29.19
GPRS (GMSK, 4Tx-slot)	29.02	28.97	29.04
EDGE (8PSK, 1Tx-slot)	25.09	25.00	25.12
EDGE (8PSK, 2Tx-slot)	24.97	24.91	24.95
EDGE (8PSK, 3Tx-slot)	24.83	24.82	24.88
EDGE (8PSK, 4Tx-slot)	24.62	24.58	24.65



LTE BAND 2

Band/BW	Modulation	RB Size	RB Offset	Low CH 18607	Mid CH 18900	High CH 19193
				Frequency 1850.7 MHz	Frequency 1880 MHz	Frequency 1909.3 MHz
2/ 1.4	QPSK	1	0	22.78	22.70	22.62
		1	5	22.70	22.59	22.73
		3	0	22.81	22.73	22.71
		3	3	22.64	22.63	22.52
		6	0	22.71	22.70	22.71
	16QAM	1	0	22.72	22.64	22.65
		1	5	22.61	22.63	22.67
		3	0	22.72	22.81	22.67
		3	3	22.82	22.79	22.80
		5	0	22.70	22.65	22.73

Band/BW	Modulation	RB Size	RB Offset	Low CH 18615	Mid CH 18900	High CH 19185
				Frequency 1851.5 MHz	Frequency 1880 MHz	Frequency 1908.5 MHz
2/ 3	QPSK	1	0	22.78	22.65	22.69
		1	5	22.73	22.56	22.76
		3	0	22.87	22.66	22.80
		3	3	22.75	22.58	22.61
		6	0	22.70	22.66	22.69
	16QAM	1	0	22.81	22.67	22.62
		1	5	22.65	22.61	22.57
		3	0	22.71	22.69	22.66
		3	3	22.81	22.76	22.69
		5	0	22.78	22.70	22.70



Band/BW	Modulation	RB Size	RB Offset	Low CH 18625	Mid CH 18900	High CH 19175
				Frequency 1852.5 MHz	Frequency 1880 MHz	Frequency 1907.5 MHz
2/ 5	QPSK	1	0	22.65	22.69	22.68
		1	5	22.65	22.58	22.63
		3	0	22.80	22.66	22.73
		3	3	22.70	22.63	22.56
		6	0	22.74	22.69	22.70
	16QAM	1	0	22.68	22.77	22.60
		1	5	22.67	22.66	22.54
		3	0	22.70	22.71	22.77
		3	3	22.79	22.78	22.72
		5	0	22.74	22.65	22.72

Band/BW	Modulation	RB Size	RB Offset	Low CH 18650	Mid CH 18900	High CH 19150
				Frequency 1855 MHz	Frequency 1880 MHz	Frequency 1905 MHz
2/ 10	QPSK	1	0	22.68	22.62	22.71
		1	5	22.63	22.59	22.65
		3	0	22.88	22.79	22.73
		3	3	22.77	22.61	22.60
		6	0	22.70	22.73	22.66
	16QAM	1	0	22.73	22.65	22.69
		1	5	22.72	22.63	22.55
		3	0	22.69	22.77	22.75
		3	3	22.87	22.76	22.71
		5	0	22.76	22.60	22.63



**BUREAU
VERITAS**

Test Report No.: W7L-P23100004RF02

Band/BW	Modulation	RB Size	RB Offset	Low CH 18675	Mid CH 18900	High CH 19125
				Frequency 1857.5 MHz	Frequency 1880 MHz	Frequency 1902.5 MHz
2/ 15	QPSK	1	0	22.67	22.65	22.70
		1	5	22.63	22.60	22.66
		3	0	22.84	22.76	22.80
		3	3	22.75	22.67	22.63
		6	0	22.69	22.72	22.67
	16QAM	1	0	22.82	22.67	22.68
		1	5	22.69	22.65	22.62
		3	0	22.73	22.77	22.78
		3	3	22.89	22.65	22.71
		5	0	22.77	22.70	22.69

Band/BW	Modulation	RB Size	RB Offset	Low CH 18700	Mid CH 18900	High CH 19100
				Frequency 1860 MHz	Frequency 1880 MHz	Frequency 1900 MHz
2/ 20	QPSK	1	0	22.80	22.75	22.74
		1	5	22.78	22.71	22.78
		3	0	22.94	22.81	22.81
		3	3	22.78	22.73	22.65
		6	0	22.79	22.81	22.75
	16QAM	1	0	22.83	22.78	22.71
		1	5	22.73	22.70	22.69
		3	0	22.74	22.82	22.79
		3	3	22.94	22.80	22.81
		5	0	22.79	22.73	22.78



LTE BAND 25

Band/BW	Modulation	RB Size	RB Offset	Low CH 26047	Mid CH 26365	High CH 26683
				Frequency 1850.7 MHz	Frequency 1882.5 MHz	Frequency 1914.3 MHz
25/ 1.4	QPSK	1	0	23.08	23.08	23.28
		1	5	23.17	23.12	23.22
		3	0	23.04	23.12	23.11
		3	3	23.08	23.14	23.16
		6	0	23.22	23.04	23.06
	16QAM	1	0	23.11	23.05	23.23
		1	5	23.08	23.09	23.14
		3	0	23.23	23.12	23.26
		3	3	23.09	23.12	23.13
		5	0	23.13	23.12	23.16

Band/BW	Modulation	RB Size	RB Offset	Low CH 26055	Mid CH 26365	High CH 26675
				Frequency 1851.5 MHz	Frequency 1882.5 MHz	Frequency 1913.5 MHz
25/ 3	QPSK	1	0	23.08	23.08	23.28
		1	5	23.21	23.11	23.14
		3	0	23.02	23.18	23.05
		3	3	23.10	23.12	23.11
		6	0	23.11	23.05	23.17
	16QAM	1	0	23.07	23.04	23.12
		1	5	23.09	23.09	23.26
		3	0	23.17	23.10	23.25
		3	3	23.02	23.03	23.03
		5	0	23.13	23.19	23.11



Band/BW	Modulation	RB Size	RB Offset	Low CH 26065	Mid CH 26365	High CH 26665
				Frequency 1852.5 MHz	Frequency 1882.5 MHz	Frequency 1912.5 MHz
25/ 5	QPSK	1	0	23.06	23.01	23.26
		1	5	23.21	23.22	23.22
		3	0	23.12	23.16	23.03
		3	3	23.17	23.13	23.05
		6	0	23.15	23.08	23.08
	16QAM	1	0	23.15	23.14	23.16
		1	5	23.05	23.10	23.14
		3	0	23.15	23.13	23.19
		3	3	23.04	23.12	23.05
		5	0	23.12	23.14	23.12

Band/BW	Modulation	RB Size	RB Offset	Low CH 26090	Mid CH 26365	High CH 26640
				Frequency 1855 MHz	Frequency 1882.5 MHz	Frequency 1910 MHz
25/ 10	QPSK	1	0	23.15	23.11	23.26
		1	5	23.19	23.10	23.19
		3	0	23.10	23.04	23.05
		3	3	23.12	23.16	23.10
		6	0	23.22	23.14	23.12
	16QAM	1	0	23.19	23.05	23.14
		1	5	23.03	23.09	23.23
		3	0	23.13	23.10	23.19
		3	3	23.06	23.12	23.14
		5	0	23.05	23.17	23.14



Band/BW	Modulation	RB Size	RB Offset	Low CH 26115	Mid CH 26365	High CH 26615
				Frequency 1857.5 MHz	Frequency 1882.5 MHz	Frequency 1907.5 MHz
25/ 15	QPSK	1	0	23.15	23.13	23.18
		1	5	23.17	23.14	23.23
		3	0	23.04	23.08	23.04
		3	3	23.06	23.07	23.14
		6	0	23.17	23.07	23.04
	16QAM	1	0	23.16	23.07	23.22
		1	5	23.09	23.14	23.13
		3	0	23.20	23.13	23.16
		3	3	23.04	23.07	23.04
		5	0	23.12	23.19	23.15

Band/BW	Modulation	RB Size	RB Offset	Low CH 26140	Mid CH 26365	High CH 26590
				Frequency 1860 MHz	Frequency 1882.5 MHz	Frequency 1905 MHz
25/ 20	QPSK	1	0	23.20	23.15	23.30
		1	5	23.29	23.23	23.27
		3	0	23.17	23.19	23.17
		3	3	23.18	23.21	23.18
		6	0	23.24	23.19	23.19
	16QAM	1	0	23.22	23.15	23.27
		1	5	23.12	23.19	23.28
		3	0	23.24	23.25	23.28
		3	3	23.13	23.17	23.18
		5	0	23.17	23.22	23.18



**BUREAU
VERITAS**

Test Report No.: W7L-P23100004RF02

EIRP POWER (dBm)

GSM

Channel	Frequency (MHz)	Conducted Power (dBm)	G _T -L _c (dB)	EIRP (dBm)	EIRP (mW)	Limit (W)
512	1850.2	29.35	3.47	32.82	1914.26	2
661	1880.0	29.28	3.47	32.75	1883.65	2
810	1909.8	29.43	3.47	32.9	1949.84	2

EDGE

Channel	Frequency (MHz)	Conducted Power (dBm)	G _T -L _c (dB)	EIRP (dBm)	EIRP (mW)	Limit (W)
512	1850.2	25.09	3.47	28.56	717.79	2
661	1880.0	25	3.47	28.47	703.07	2
810	1909.8	25.12	3.47	28.59	722.77	2



LTE BAND 2

CHANNEL BANDWIDTH: 1.4MHz QPSK

Channel	Frequency (MHz)	Conducted Power (dBm)	G _{T-Lc} (dB)	EIRP (dBm)	EIRP (mW)	Limit (W)
18607	1850.7	22.81	3.47	26.28	424.62	2
18900	1880.0	22.73	3.47	26.2	416.87	2
19193	1909.3	22.73	3.47	26.2	416.87	2

CHANNEL BANDWIDTH: 1.4MHz 16QAM

Channel	Frequency (MHz)	Conducted Power (dBm)	G _{T-Lc} (dB)	EIRP (dBm)	EIRP (mW)	Limit (W)
18607	1850.7	22.82	3.47	26.29	425.6	2
18900	1880.0	22.81	3.47	26.28	424.62	2
19193	1909.3	22.8	3.47	26.27	423.64	2

CHANNEL BANDWIDTH: 3MHz QPSK

Channel	Frequency (MHz)	Conducted Power (dBm)	G _{T-Lc} (dB)	EIRP (dBm)	EIRP (mW)	Limit (W)
18615	1851.5	22.87	3.47	26.34	430.53	2
18900	1880.0	22.66	3.47	26.13	410.2	2
19185	1908.5	22.8	3.47	26.27	423.64	2

CHANNEL BANDWIDTH: 3MHz 16QAM

Channel	Frequency (MHz)	Conducted Power (dBm)	G _{T-Lc} (dB)	EIRP (dBm)	EIRP (mW)	Limit (W)
18615	1851.5	22.81	3.47	26.28	424.62	2
18900	1880.0	22.76	3.47	26.23	419.76	2
19185	1908.5	22.7	3.47	26.17	414	2



CHANNEL BANDWIDTH: 5MHz QPSK

Channel	Frequency (MHz)	Conducted Power (dBm)	G _T -L _C (dB)	EIRP (dBm)	EIRP (mW)	Limit (W)
18625	1852.5	22.8	3.47	26.27	423.64	2
18900	1880.0	22.69	3.47	26.16	413.05	2
19175	1907.5	22.73	3.47	26.2	416.87	2

CHANNEL BANDWIDTH: 5MHz 16QAM

Channel	Frequency (MHz)	Conducted Power (dBm)	G _T -L _C (dB)	EIRP (dBm)	EIRP (mW)	Limit (W)
18625	1852.5	22.79	3.47	26.26	422.67	2
18900	1880.0	22.78	3.47	26.25	421.7	2
19175	1907.5	22.77	3.47	26.24	420.73	2

CHANNEL BANDWIDTH: 10MHz QPSK

Channel	Frequency (MHz)	Conducted Power (dBm)	G _T -L _C (dB)	EIRP (dBm)	EIRP (mW)	Limit (W)
18650	1855.0	22.88	3.47	26.35	431.52	2
18900	1880.0	22.79	3.47	26.26	422.67	2
19150	1905.0	22.73	3.47	26.2	416.87	2

CHANNEL BANDWIDTH: 10MHz 16QAM

Channel	Frequency (MHz)	Conducted Power (dBm)	G _T -L _C (dB)	EIRP (dBm)	EIRP (mW)	Limit (W)
18650	1855.0	22.87	3.47	26.34	430.53	2
18900	1880.0	22.77	3.47	26.24	420.73	2
19150	1905.0	22.75	3.47	26.22	418.79	2



CHANNEL BANDWIDTH: 15MHz QPSK

Channel	Frequency (MHz)	Conducted Power (dBm)	G _{T-Lc} (dB)	EIRP (dBm)	EIRP (mW)	Limit (W)
18675	1857.5	22.84	3.47	26.31	427.56	2
18900	1880.0	22.76	3.47	26.23	419.76	2
19125	1902.5	22.8	3.47	26.27	423.64	2

CHANNEL BANDWIDTH: 15MHz 16QAM

Channel	Frequency (MHz)	Conducted Power (dBm)	G _{T-Lc} (dB)	EIRP (dBm)	EIRP (mW)	Limit (W)
18675	1857.5	22.89	3.47	26.36	432.51	2
18900	1880.0	22.77	3.47	26.24	420.73	2
19125	1902.5	22.78	3.47	26.25	421.7	2

CHANNEL BANDWIDTH: 20MHz QPSK

Channel	Frequency (MHz)	Conducted Power (dBm)	G _{T-Lc} (dB)	EIRP (dBm)	EIRP (mW)	Limit (W)
18700	1860	22.94	3.47	26.41	437.52	2
18900	1880	22.81	3.47	26.28	424.62	2
19100	1900	22.81	3.47	26.28	424.62	2

CHANNEL BANDWIDTH: 20MHz 16QAM

Channel	Frequency (MHz)	Conducted Power (dBm)	G _{T-Lc} (dB)	EIRP (dBm)	EIRP (mW)	Limit (W)
18700	1860	22.94	3.47	26.41	437.52	2
18900	1880	22.82	3.47	26.29	425.6	2
19100	1900	22.81	3.47	26.28	424.62	2



LTE BAND 25

CHANNEL BANDWIDTH: 1.4MHz QPSK

Channel	Frequency (MHz)	Conducted Power (dBm)	G _T -L _C (dB)	EIRP (dBm)	EIRP (mW)	Limit (W)
26047	1850.7	23.22	3.47	26.69	466.66	2
26365	1882.5	23.14	3.47	26.61	458.14	2
26683	1914.3	23.28	3.47	26.75	473.15	2

CHANNEL BANDWIDTH: 1.4MHz 16QAM

Channel	Frequency (MHz)	Conducted Power (dBm)	G _T -L _C (dB)	EIRP (dBm)	EIRP (mW)	Limit (W)
26047	1850.7	23.23	3.47	26.7	467.74	2
26365	1882.5	23.12	3.47	26.59	456.04	2
26683	1914.3	23.26	3.47	26.73	470.98	2

CHANNEL BANDWIDTH: 3MHz QPSK

Channel	Frequency (MHz)	Conducted Power (dBm)	G _T -L _C (dB)	EIRP (dBm)	EIRP (mW)	Limit (W)
26055	1851.5	23.21	3.47	26.68	465.59	2
26365	1882.5	23.18	3.47	26.65	462.38	2
26675	1913.5	23.28	3.47	26.75	473.15	2

CHANNEL BANDWIDTH: 3MHz 16QAM

Channel	Frequency (MHz)	Conducted Power (dBm)	G _T -L _C (dB)	EIRP (dBm)	EIRP (mW)	Limit (W)
26055	1851.5	23.17	3.47	26.64	461.32	2
26365	1882.5	23.19	3.47	26.66	463.45	2
26675	1913.5	23.26	3.47	26.73	470.98	2



CHANNEL BANDWIDTH: 5MHz QPSK

Channel	Frequency (MHz)	Conducted Power (dBm)	G _T -L _c (dB)	EIRP (dBm)	EIRP (mW)	Limit (W)
26065	1852.5	23.21	3.47	26.68	465.59	2
26365	1882.5	23.22	3.47	26.69	466.66	2
26665	1912.5	23.26	3.47	26.73	470.98	2

CHANNEL BANDWIDTH: 5MHz 16QAM

Channel	Frequency (MHz)	Conducted Power (dBm)	G _T -L _c (dB)	EIRP (dBm)	EIRP (mW)	Limit (W)
26065	1852.5	23.15	3.47	26.62	459.2	2
26365	1882.5	23.14	3.47	26.61	458.14	2
26665	1912.5	23.19	3.47	26.66	463.45	2

CHANNEL BANDWIDTH: 10MHz QPSK

Channel	Frequency (MHz)	Conducted Power (dBm)	G _T -L _c (dB)	EIRP (dBm)	EIRP (mW)	Limit (W)
26090	1855	23.22	3.47	26.69	466.66	2
26365	1882.5	23.16	3.47	26.63	460.26	2
26640	1910	23.26	3.47	26.73	470.98	2

CHANNEL BANDWIDTH: 10MHz 16QAM

Channel	Frequency (MHz)	Conducted Power (dBm)	G _T -L _c (dB)	EIRP (dBm)	EIRP (mW)	Limit (W)
26090	1855	23.19	3.47	26.66	463.45	2
26365	1882.5	23.17	3.47	26.64	461.32	2
26640	1910	23.23	3.47	26.7	467.74	2



CHANNEL BANDWIDTH: 15MHz QPSK

Channel	Frequency (MHz)	Conducted Power (dBm)	G _{T-Lc} (dB)	EIRP (dBm)	EIRP (mW)	Limit (W)
26115	1857.5	23.17	3.47	26.64	461.32	2
26365	1882.5	23.14	3.47	26.61	458.14	2
26615	1907.5	23.23	3.47	26.7	467.74	2

CHANNEL BANDWIDTH: 15MHz 16QAM

Channel	Frequency (MHz)	Conducted Power (dBm)	G _{T-Lc} (dB)	EIRP (dBm)	EIRP (mW)	Limit (W)
26115	1857.5	23.2	3.47	26.67	464.52	2
26365	1882.5	23.19	3.47	26.66	463.45	2
26615	1907.5	23.22	3.47	26.69	466.66	2

CHANNEL BANDWIDTH: 20MHz QPSK

Channel	Frequency (MHz)	Conducted Power (dBm)	G _{T-Lc} (dB)	EIRP (dBm)	EIRP (mW)	Limit (W)
26140	1860	23.29	3.47	26.76	474.24	2
26365	1882.5	23.23	3.47	26.7	467.74	2
26590	1905	23.3	3.47	26.77	475.34	2

CHANNEL BANDWIDTH: 20MHz 16QAM

Channel	Frequency (MHz)	Conducted Power (dBm)	G _{T-Lc} (dB)	EIRP (dBm)	EIRP (mW)	Limit (W)
26140	1860	23.24	3.47	26.71	468.81	2
26365	1882.5	23.25	3.47	26.72	469.89	2
26590	1905	23.28	3.47	26.75	473.15	2



3.2 FREQUENCY STABILITY MEASUREMENT

3.2.1 LIMITS OF FREQUENCY STABILITY MEASUREMENT

The frequency stability shall be sufficient to ensure that the fundamental emission stays within the authorized frequency block.

3.2.2 TEST PROCEDURE

- a. Device is placed at the oven room. The oven room could control the temperatures and humidity. Power warm up is at least 15 min and power applied should perform before recording frequency error.
- b. EUT is connected the external power supply to control the DC input power. The test voltage range is from minimum to maximum working voltage. Each step shall be record the frequency error rate.
- c. The temperature range step is 10 degrees in this test items. All temperature levels shall be hold the $\pm 0.5^{\circ}\text{C}$ during the measurement testing. The each temperature step shall be at least 0.5 hours, consider the EUT could be test under the stability condition.

NOTE: The frequency error was recorded frequency error from the communication simulator.

3.2.3 TEST SETUP

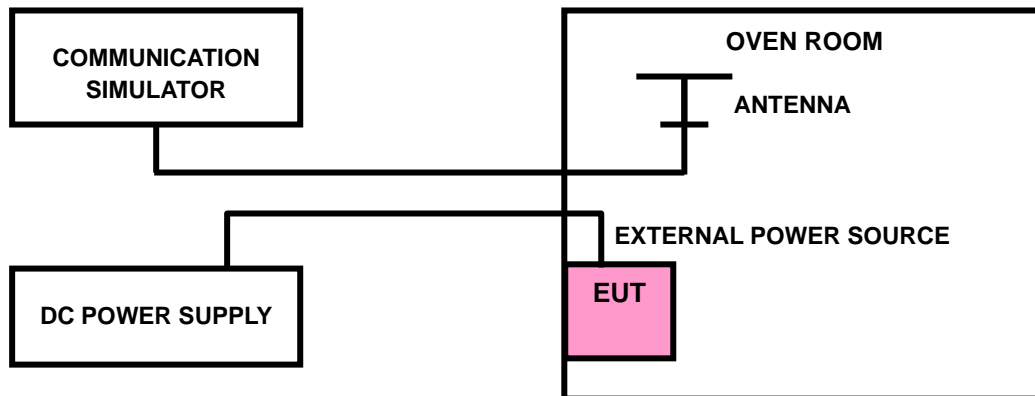



**BUREAU
VERITAS**

Test Report No.: W7L-P23100004RF02

3.2.4 TEST RESULTS

Please Refer to Module report R2007A0435-R5.



3.3 OCCUPIED BANDWIDTH MEASUREMENT

3.3.1 LIMITS OF OCCUPIED BANDWIDTH MEASUREMENT

The width of a frequency band such that, below the lower and above the upper frequency limits, the mean powers emitted are each equal to a specified percentage 0.5 % of the total mean power of a given emission.

3.3.2 TEST SETUP

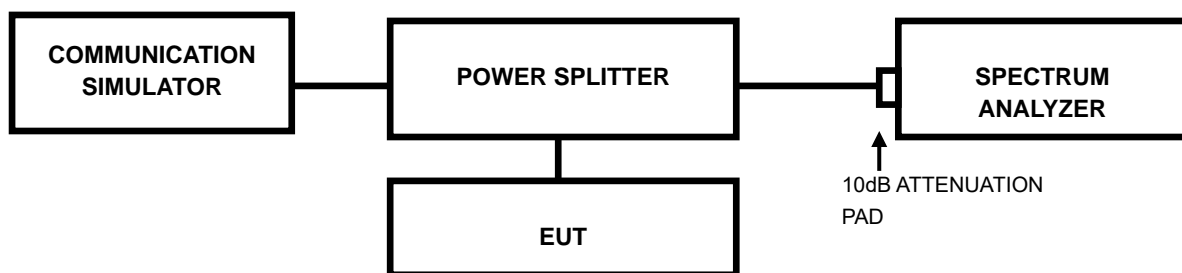

3.3.3 TEST PROCEDURES

- The conducted occupied bandwidth used the power splitter via EUT RF power connector between simulation base station and spectrum analyzer.
- Use OBW measurement function of Spectrum analyzer to measure 99 % occupied bandwidth.



Test Report No.: W7L-P23100004RF02

3.3.4 TEST RESULTS

Please Refer to Module report R2007A0435-R5.



3.4 BAND EDGE MEASUREMENTC

3.4.1 LIMITS OF BAND EDGE MEASUREMENT

Power of any emission outside of the authorized operating frequency ranges must be attenuated below the transmitting power (P) by a factor of at least $43 + 10 \log(P)$ dB. In the 1 MHz bands immediately outside and adjacent to the frequency block a resolution bandwidth of at least one percent of the emission bandwidth of the fundamental emission of the transmitter may be employed.

3.4.2 TEST SETUP

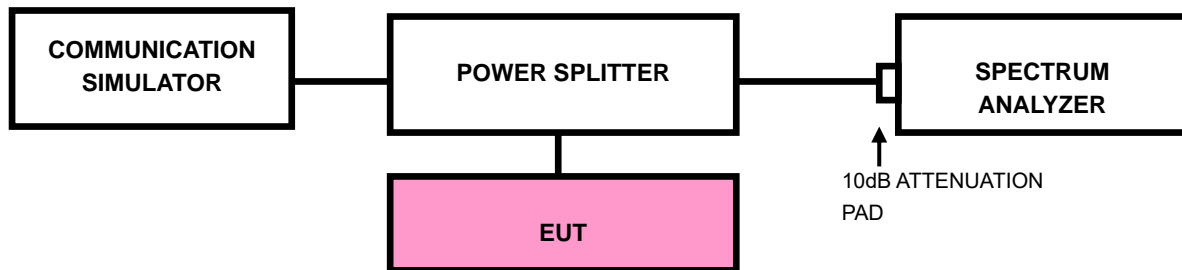



3.4.3 TEST PROCEDURES

- a) All measurements were done at low and high operational frequency range
- b) Connect the transmitter to the spectrum analyzer via coaxial cable while ensuring proper impedance matching.
- c) Tune the analyzer to the nominal center frequency of the emission bandwidth (EBW)
- d) .Set the resolution bandwidth (RBW) $\geq 1\%$ EBW in the 1MHz band immediately outside and adjacent to the band edge.
- e) Beyond the 1MHz band from the band edge, RBW=1MHz was used.
- f) Set the video bandwidth (VBW) to $\geq 3 \times$ RBW.
- g) Select the average power (RMS) display detector.
- h) Set the number of measurement points to ≥ 1001 .
- i) Use auto-coupled sweep time.
- j) Perform the measurement over an interval of time when the transmission is continuous and at its maximum power level.
- k) The RF fundamental frequency should be excluded against the limit line in the operating frequency band and use RBW is 10KHz or 100KHz.
- l) Record the max trace plot into the test report.



**BUREAU
VERITAS**

Test Report No.: W7L-P23100004RF02

3.4.4. TEST RESULTS

Please Refer to Module report R2007A0435-R5.



3.5 CONDUCTED SPURIOUS EMISSIONS

3.5.1 LIMITS OF CONDUCTED SPURIOUS EMISSIONS MEASUREMENT

The power of any emission outside of the authorized operating frequency ranges must be attenuated below the transmitting power (P) by a factor of at least $43 + 10 \log(P)$ dB. The emission limit equal to -13dBm .

3.5.2 TEST PROCEDURE

- The EUT makes a phone call to the communication simulator. All measurements were done at low, middle and high operational frequency range.
- Measuring frequency range is from 30MHz up to a frequency including its 10th harmonic. 10dB attenuation pad is connected with spectrum. RBW=1MHz and VBW=3MHz is used for conducted emission measurement.

3.5.3 TEST SETUP

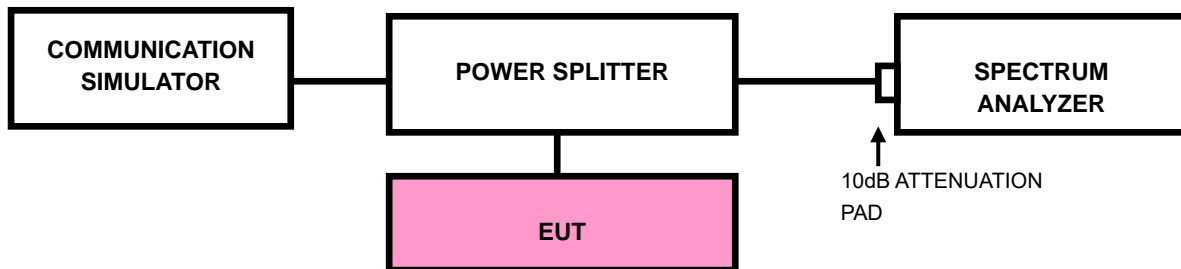



**BUREAU
VERITAS**

Test Report No.: W7L-P23100004RF02

3.5.4 TEST RESULTS

NOTE : The 9K~30MHz amplitude of spurious emissions attenuated more than 20 dB below the permissible value is not required in the report.

Please Refer to Module report R2007A0435-R5.



3.6 RADIATED EMISSION MEASUREMENT

3.6.1 LIMITS OF RADIATED EMISSION MEASUREMENT

The power of any emission outside of the authorized operating frequency ranges must be attenuated below the transmitting power (P) by a factor of at least $43 + 10 \log(P)$ dB. The emission limit equal to -13dBm .

3.6.2 TEST PROCEDURES

- a. Substitution method is used for E.I.R.P measurement. In the semi-anechoic chamber, EUT placed on the 0.8m height of Turn Table, rotated the table around 360 degrees to search the maximum radiation power and receiver antenna shall be rotated vertical and horizontal polarization and moved height from 1m to 4m to find the maximum polar radiated power. The “Read Value” is the spectrum reading the maximum power value.
- b. The substitution horn antenna is substituted for EUT at the same position and signals generator export the CW signal to the substitution antenna via a TX cable. Rotated the Turn Table and moved receiving antenna to find the maximum radiation power. Adjust output power level of S.G to get a Value of spectrum reading equal to “Read Value” of step a. Record the power level of S.G
- c. $\text{EIRP} = \text{Output power level of S.G} - \text{TX cable loss} + \text{Antenna gain of substitution horn}$.

NOTE: The resolution bandwidth and video bandwidth of test receiver/spectrum analyzer is 1MHz/3MHz.

3.6.3 DEVIATION FROM TEST STANDARD

No deviation



3.6.4 TEST SETUP

< Frequency Range below 30MHz >

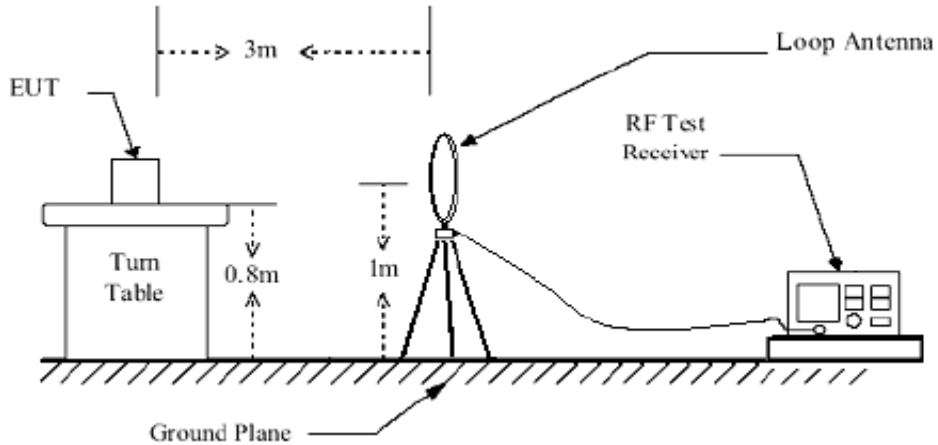

< Frequency Range 30MHz~1GHz >

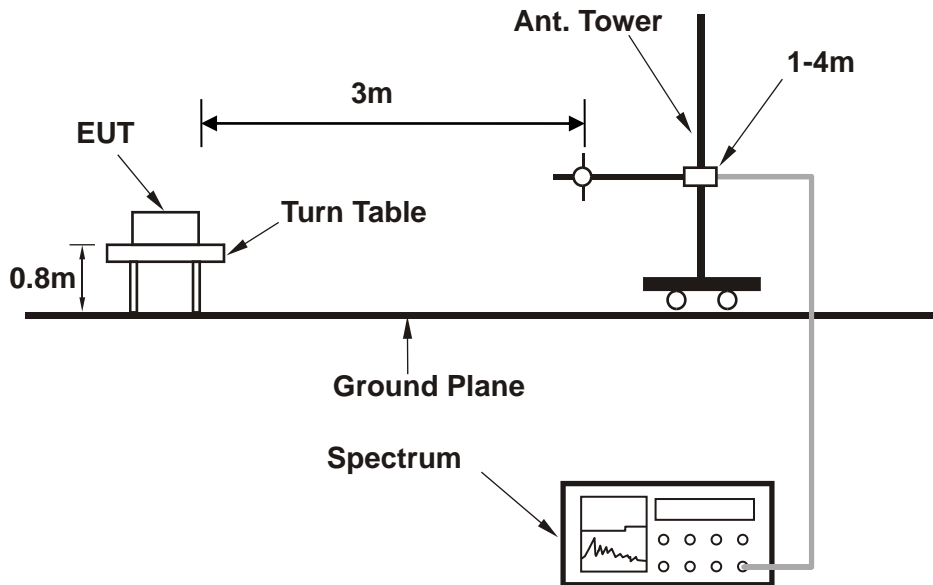



<Frequency Range above 1GHz>

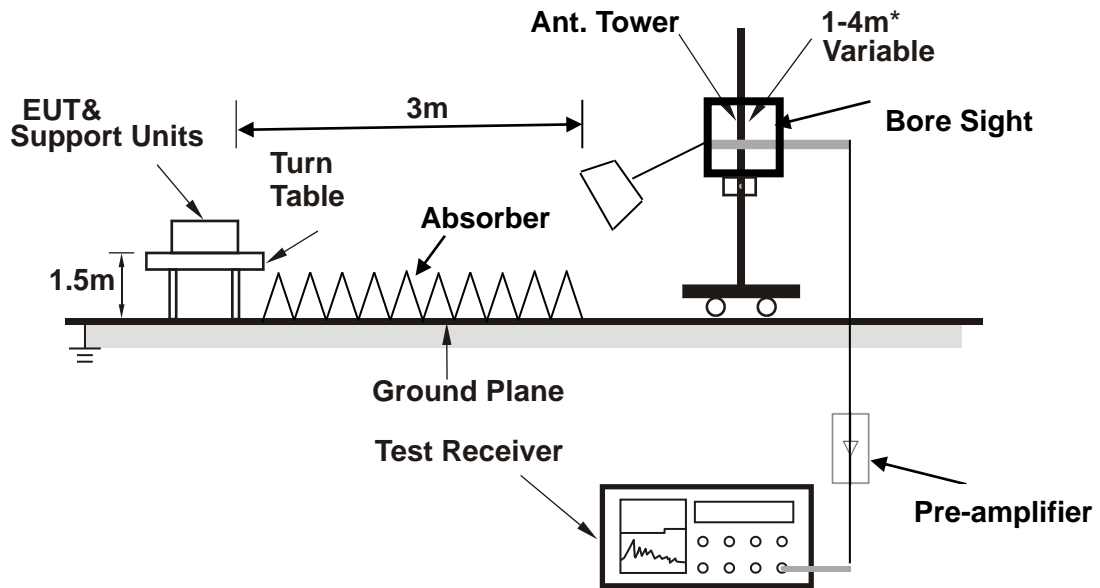

Note: Above 1G is a directional antenna

Depends on the EUT height and the antenna 3dB beamwidth both, refer to section 7.3 of CISPR 16-2-3.

For the actual test configuration, please refer to the attached file (Test Setup Photo).



**BUREAU
VERITAS**

Test Report No.: W7L-P23100004RF02

3.6.5 TEST RESULTS

NOTE : The 9K~30MHz amplitude of spurious emissions attenuated more than 20 dB below the permissible value is not required in the report.

BELOW 1GHz WORST-CASE DATA

30 MHz – 1GHz data:

EDGE 1900:

CHANNEL BANDWIDTH: 512 ~ 810

MODE	Tx channel 810	FREQUENCY RANGE	Below 1000MHz
ENVIRONMENTAL CONDITIONS	23deg. C, 70%RH	INPUT POWER	AC 120V/60HZ
TESTED BY	Jace Hu		
ANTENNA POLARITY & TEST DISTANCE: HORIZONTAL AT 3 M			

No.	Frequency MHz	Factor dB	Reading dBm	Emission dBm	Limit dBm	Margin dB	Tower / Table cm deg	
1	33.11	-1.74	-58.09	-59.83	-13.00	-46.83	100	0
2	45.54	-10.05	-49.66	-59.71	-13.00	-46.71	100	0
3	98.40	-10.59	-56.77	-67.36	-13.00	-54.36	100	0
* 4	146.59	-7.41	-49.89	-57.30	-13.00	-44.30	100	0
5	246.07	-8.17	-58.30	-66.47	-13.00	-53.47	100	0
6	469.92	-1.95	-66.35	-68.30	-13.00	-55.30	100	0

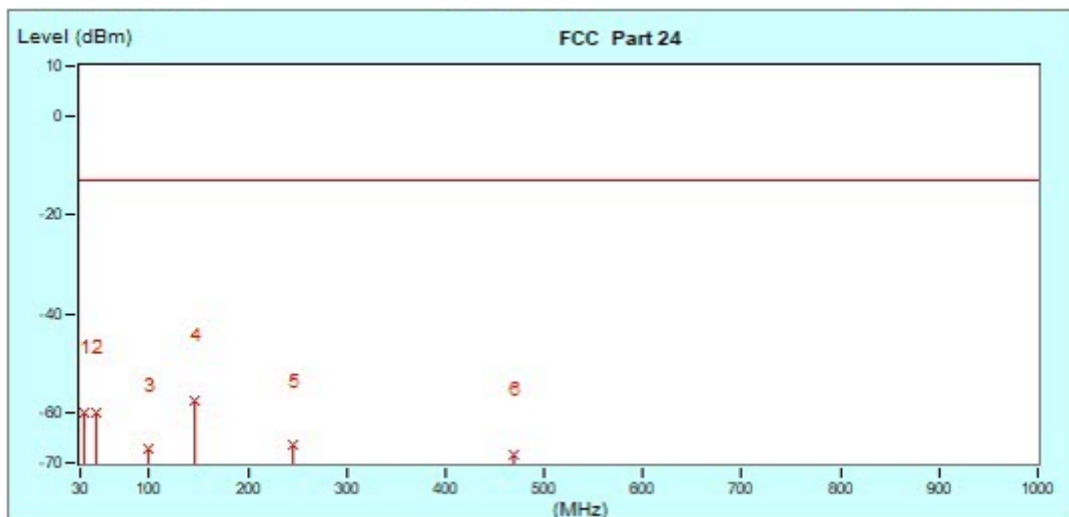



**BUREAU
VERITAS**

Test Report No.: W7L-P23100004RF02

MODE	TX channel 810	FREQUENCY RANGE	Below 1000MHz
ENVIRONMENTAL CONDITIONS	23deg. C, 70%RH	INPUT POWER	AC 120V/60HZ
TESTED BY	Jace Hu		
ANTENNA POLARITY & TEST DISTANCE: VERTICAL AT 3 M			

No.	Frequency MHz	Factor dB	Reading dBm	Emission dBm	Limit dBm	Margin dB	Tower / Table	
							cm	deg
1	45.54	-10.05	-57.19	-67.24	-13.00	-54.24	100	0
2	98.40	-10.59	-52.69	-63.28	-13.00	-50.28	100	0
3	309.81	-8.20	-66.52	-72.72	-13.00	-59.72	100	0
4	519.66	-1.04	-66.40	-67.44	-13.00	-54.44	100	0
5	661.12	0.99	-66.36	-65.37	-13.00	-52.37	100	0
* 6	883.41	3.91	-66.99	-63.08	-13.00	-50.08	100	0

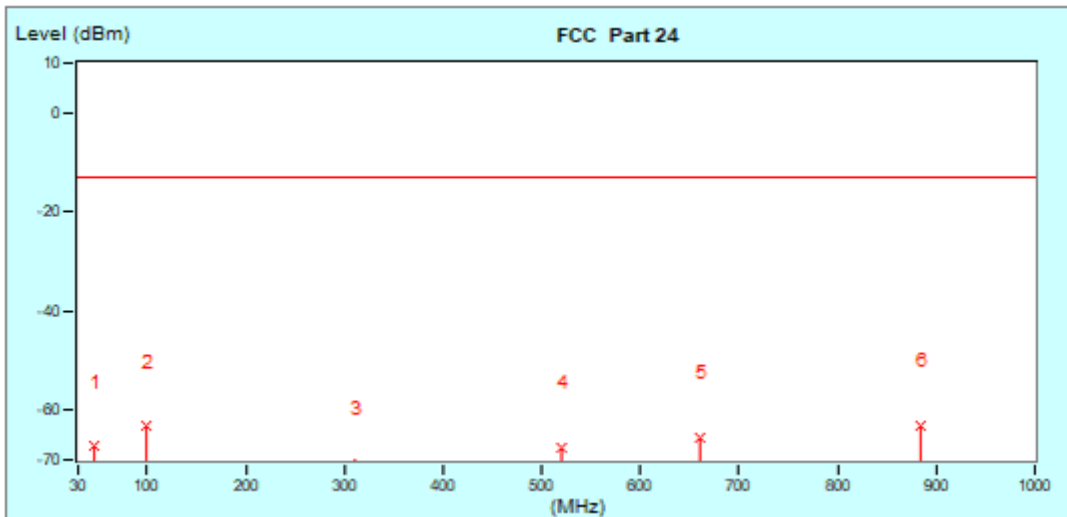



BUREAU
VERITAS

Test Report No.: W7L-P23100004RF02

ABOVE 1GHz DATA

Note: For higher frequency, the emission is too low to be detected.

WORST-CASE DATA

GSM 1900:

CH 512

MODE	TX channel 512	FREQUENCY RANGE	Above 1000MHz
ENVIRONMENTAL CONDITIONS	23deg. C, 70%RH	INPUT POWER	AC 120V/60HZ
TESTED BY	Jace Hu		
ANTENNA POLARITY & TEST DISTANCE: HORIZONTAL AT 3 M			

No.	Frequency MHz	Factor dB	Reading dBm	Emission dBm	Limit dBm	Margin dB	Tower / Table cm deg	
1	3700.40 (PK)	-9.09	-50.12	-59.21	-13.00	-46.21	100	0
* 2	5550.60 (PK)	-3.24	-50.22	-53.46	-13.00	-40.46	100	0

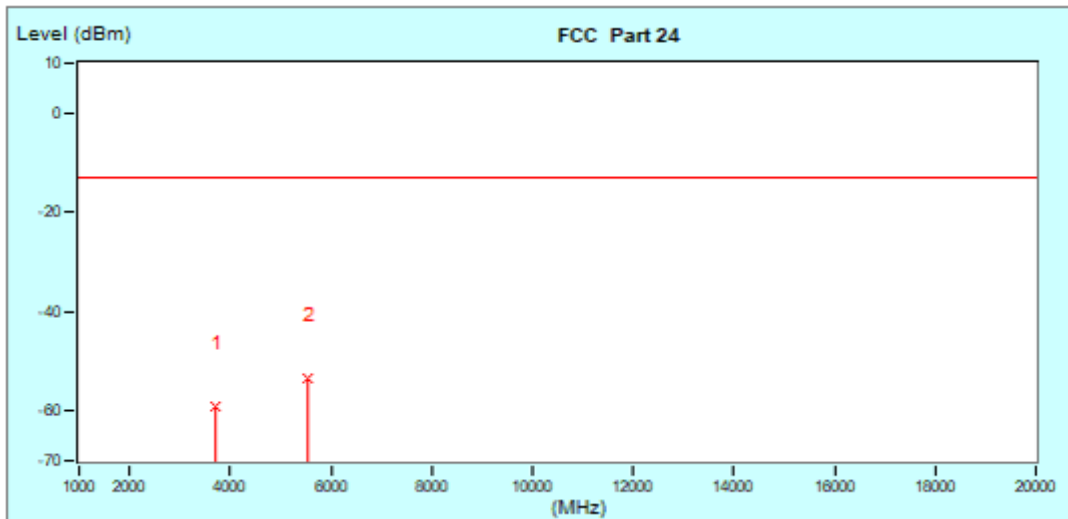



**BUREAU
VERITAS**

Test Report No.: W7L-P23100004RF02

MODE	TX channel 512	FREQUENCY RANGE	Above 1000MHz
ENVIRONMENTAL CONDITIONS	23deg. C, 70%RH	INPUT POWER	AC 120V/60HZ
TESTED BY	Jace Hu		
ANTENNA POLARITY & TEST DISTANCE: VERTICAL AT 3 M			

No.	Frequency MHz	Factor dB	Reading dBm	Emission dBm	Limit dBm	Margin dB	Tower / Table cm deg	
1	3700.40 (PK)	-9.09	-47.00	-56.09	-13.00	-43.09	100	0
* 2	5550.60 (PK)	-3.24	-51.77	-55.01	-13.00	-42.01	100	0

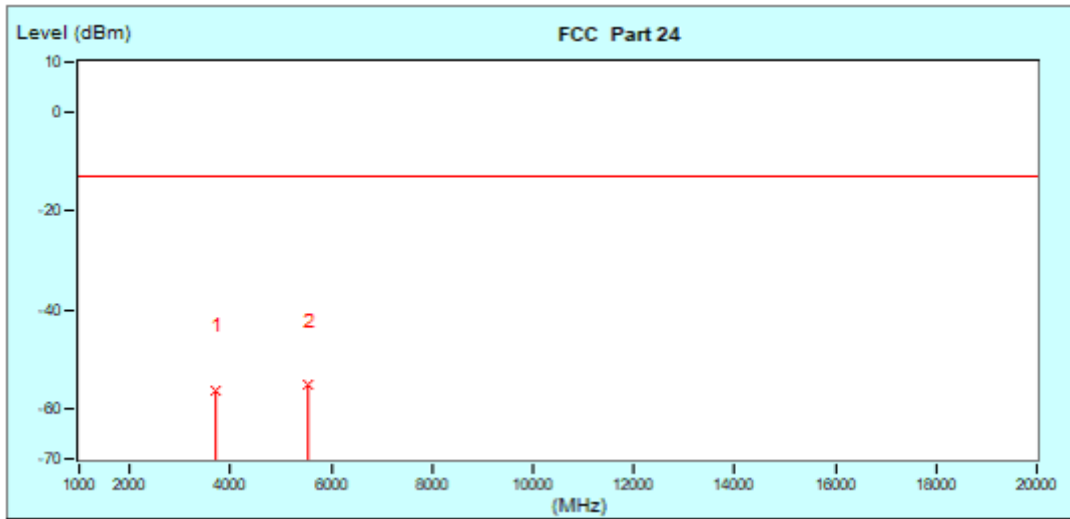



BUREAU VERITAS

Test Report No.: W7L-P23100004RF02

CH 661

MODE	TX channel 661	FREQUENCY RANGE	Above 1000MHz
ENVIRONMENTAL CONDITIONS	23deg. C, 70%RH	INPUT POWER	AC 120V/60HZ
TESTED BY	Jace Hu		
ANTENNA POLARITY & TEST DISTANCE: HORIZONTAL AT 3 M			

No.	Frequency MHz	Factor dB	Reading dBm	Emission dBm	Limit dBm	Margin dB	Tower / Table cm deg	
1	3780.00 (PK)	-9.07	-47.45	-56.52	-13.00	-43.52	100	0
* 2	5640.00 (PK)	-3.17	-50.15	-53.32	-13.00	-40.32	100	0

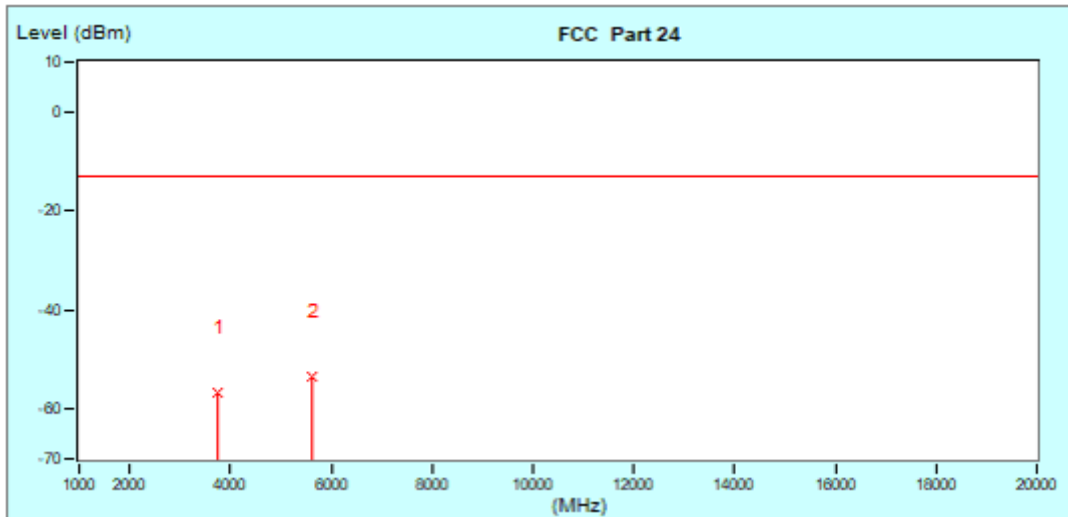



**BUREAU
VERITAS**

Test Report No.: W7L-P23100004RF02

MODE	TX channel 661	FREQUENCY RANGE	Above 1000MHz
ENVIRONMENTAL CONDITIONS	23deg. C, 70%RH	INPUT POWER	AC 120V/60HZ
TESTED BY	Jace Hu		
ANTENNA POLARITY & TEST DISTANCE: VERTICAL AT 3 M			

No.	Frequency MHz	Factor dB	Reading dBm	Emission dBm	Limit dBm	Margin dB	Tower / Table cm deg	
1	3760.00 (PK)	-9.07	-47.24	-56.31	-13.00	-43.31	100	0
* 2	5640.00 (PK)	-3.17	-52.10	-55.27	-13.00	-42.27	100	0

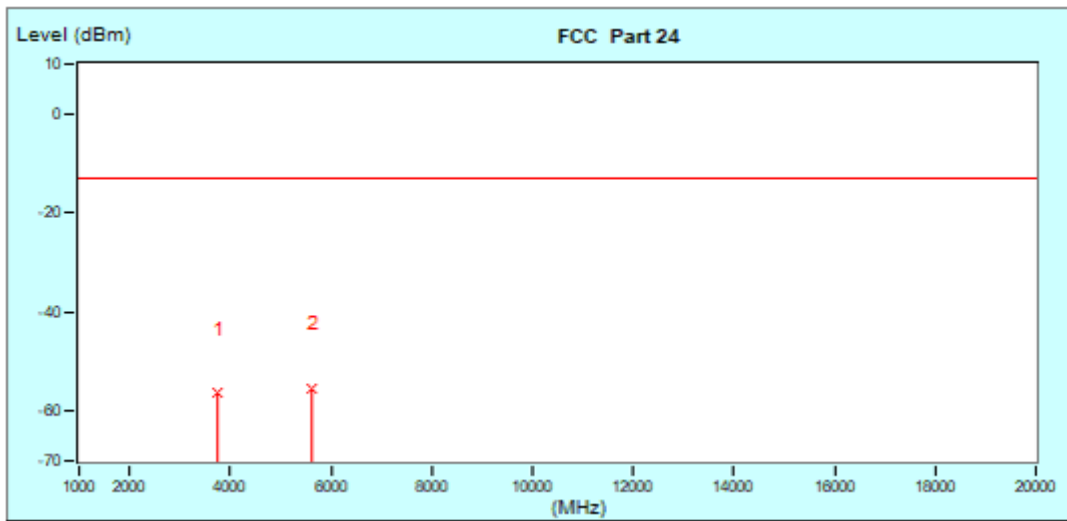



BUREAU VERITAS

Test Report No.: W7L-P23100004RF02

CH 810

MODE	TX channel 810	FREQUENCY RANGE	Above 1000MHz
ENVIRONMENTAL CONDITIONS	23deg. C, 70%RH	INPUT POWER	AC 120V/60HZ
TESTED BY	Jace Hu		
ANTENNA POLARITY & TEST DISTANCE: HORIZONTAL AT 3 M			

No.	Frequency MHz	Factor dB	Reading dBm	Emission dBm	Limit dBm	Margin dB	Tower / Table cm deg	
1	3819.60 (PK)	-9.05	-51.07	-60.12	-13.00	-47.12	100	0
* 2	5729.40 (PK)	-3.11	-49.16	-52.27	-13.00	-39.27	100	0

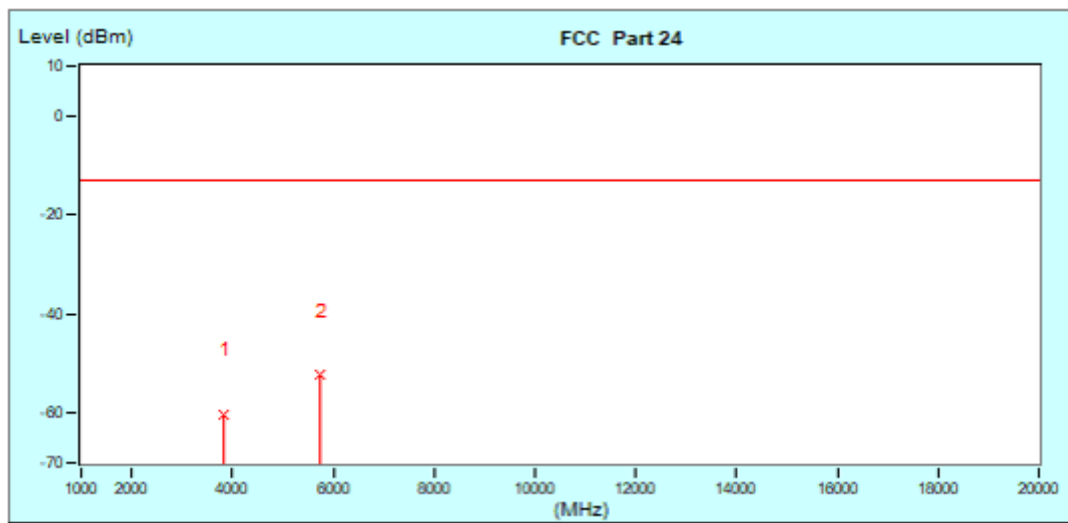



BUREAU VERITAS

Test Report No.: W7L-P23100004RF02

MODE	TX channel 810	FREQUENCY RANGE	Above 1000MHz
ENVIRONMENTAL CONDITIONS	23deg. C, 70%RH	INPUT POWER	AC 120V/60HZ
TESTED BY	Jace Hu		
ANTENNA POLARITY & TEST DISTANCE: VERTICAL AT 3 M			

No.	Frequency MHz	Factor dB	Reading dBm	Emission dBm	Limit dBm	Margin dB	Tower / Table cm deg	
1	3819.60 (PK)	-9.05	-50.32	-59.37	-13.00	-46.37	100	0
* 2	5729.40 (PK)	-3.11	-36.70	-39.81	-13.00	-26.81	100	0

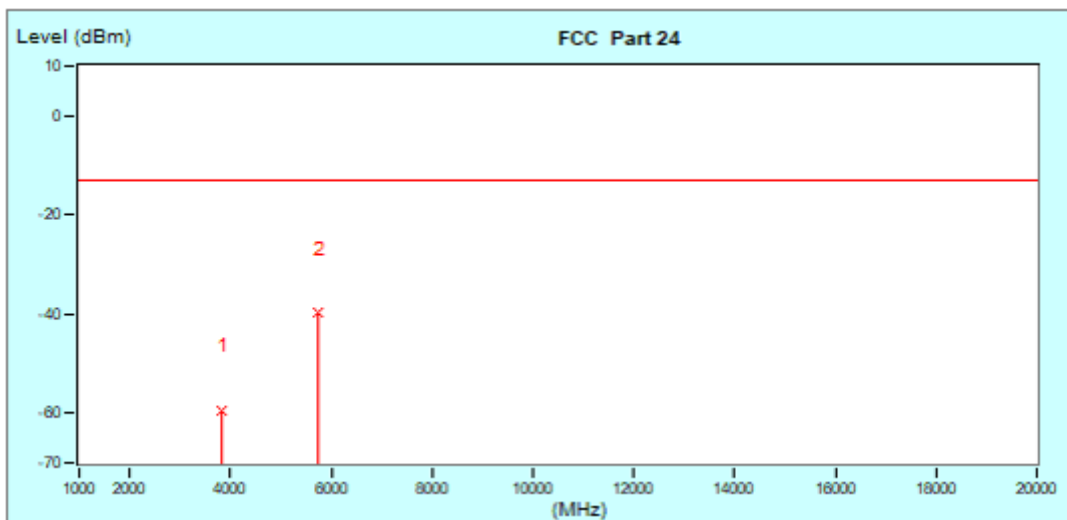



BUREAU
VERITAS

Test Report No.: W7L-P23100004RF02

EDGE 1900:

CH 512

MODE	TX channel 512	FREQUENCY RANGE	Above 1000MHz
ENVIRONMENTAL CONDITIONS	23deg. C, 70%RH	INPUT POWER	AC 120V/60HZ
TESTED BY	Jace Hu		
ANTENNA POLARITY & TEST DISTANCE: HORIZONTAL AT 3 M			

No.	Frequency MHz	Factor dB	Reading dBm	Emission dBm	Limit dBm	Margin dB	Tower / Table cm deg	
1	3700.40 (PK)	-9.09	-45.92	-55.01	-13.00	-42.01	100	0
* 2	5550.80 (PK)	-3.24	-44.62	-47.86	-13.00	-34.86	100	0

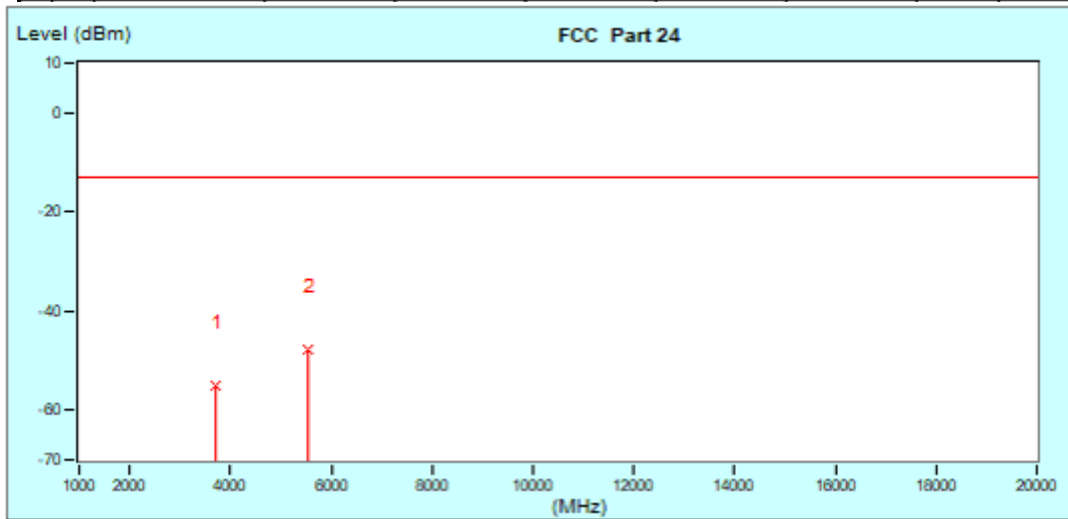



**BUREAU
VERITAS**

Test Report No.: W7L-P23100004RF02

MODE	TX channel 512	FREQUENCY RANGE	Above 1000MHz
ENVIRONMENTAL CONDITIONS	23deg. C, 70%RH	INPUT POWER	AC 120V/60HZ
TESTED BY	Jace Hu		
ANTENNA POLARITY & TEST DISTANCE: VERTICAL AT 3 M			

No.	Frequency MHz	Factor dB	Reading dBm	Emission dBm	Limit dBm	Margin dB	Tower / Table cm deg	
1	3700.50 (PK)	-9.09	-47.85	-58.94	-13.00	-43.94	100	0
*	2	-3.24	-44.19	-47.43	-13.00	-34.43	100	0

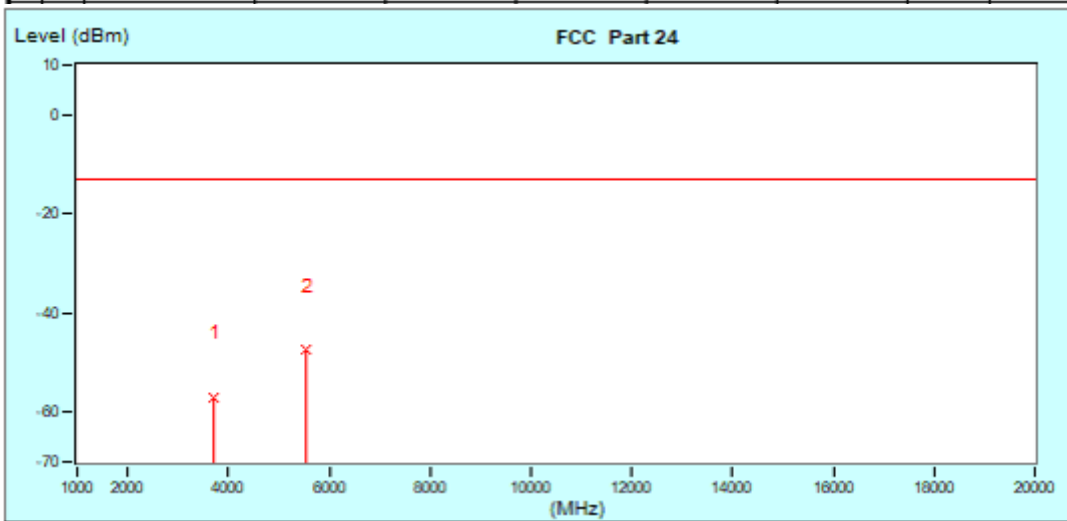



BUREAU
VERITAS

Test Report No.: W7L-P23100004RF02

CH 661

MODE	TX channel 661	FREQUENCY RANGE	Above 1000MHz
ENVIRONMENTAL CONDITIONS	23deg. C, 70%RH	INPUT POWER	AC 120V/60HZ
TESTED BY	Jace Hu		
ANTENNA POLARITY & TEST DISTANCE: HORIZONTAL AT 3 M			

No.	Frequency MHz	Factor dB	Reading dBm	Emission dBm	Limit dBm	Margin dB	Tower / Table cm deg	
1	3780.00 (PK)	-9.07	-46.49	-55.56	-13.00	-42.56	100	0
* 2	5640.00 (PK)	-3.17	-42.91	-46.08	-13.00	-33.08	100	0

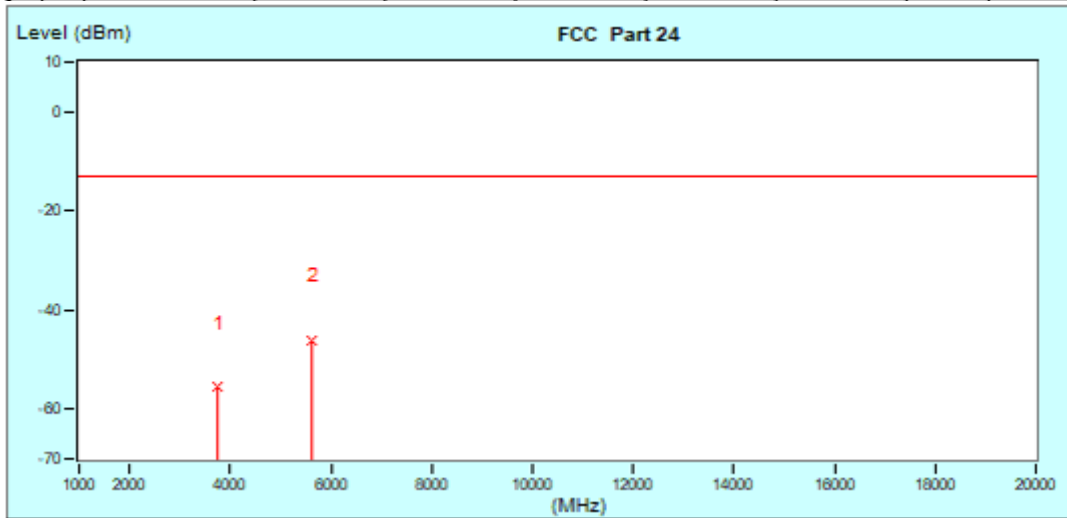



BUREAU VERITAS

Test Report No.: W7L-P23100004RF02

MODE	TX channel 661	FREQUENCY RANGE	Above 1000MHz
ENVIRONMENTAL CONDITIONS	23deg. C, 70%RH	INPUT POWER	AC 120V/60HZ
TESTED BY	Jace Hu		
ANTENNA POLARITY & TEST DISTANCE: VERTICAL AT 3 M			

No.	Frequency MHz	Factor dB	Reading dBm	Emission dBm	Limit dBm	Margin dB	Tower / Table cm deg	
1	3780.00 (PK)	-9.07	-48.24	-55.31	-13.00	-42.31	100	0
2	5640.00 (PK)	-3.17	-45.67	-48.84	-13.00	-35.84	100	0

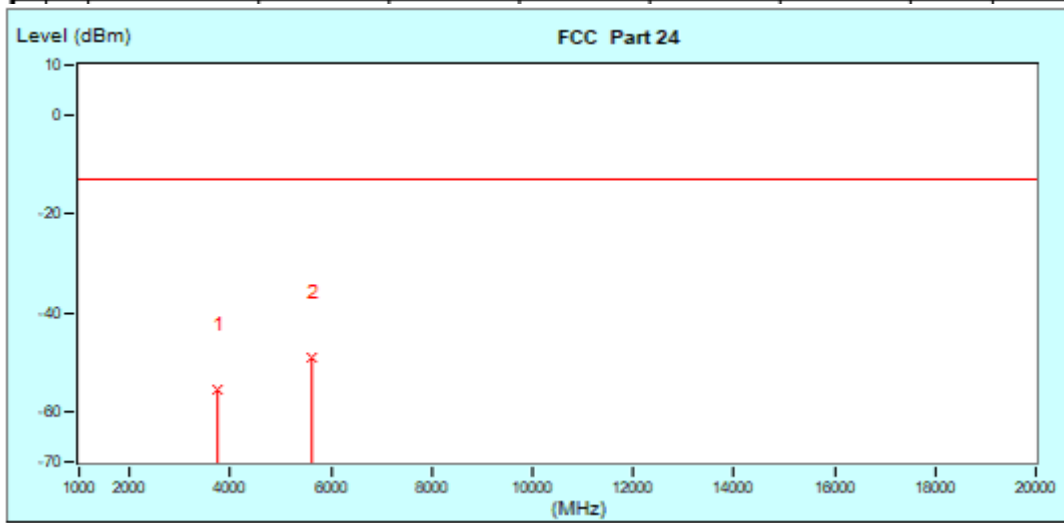



BUREAU VERITAS

Test Report No.: W7L-P23100004RF02

CH 810

MODE	TX channel 810	FREQUENCY RANGE	Above 1000MHz
ENVIRONMENTAL CONDITIONS	23deg. C, 70%RH	INPUT POWER	AC 120V/60HZ
TESTED BY	Jace Hu		
ANTENNA POLARITY & TEST DISTANCE: HORIZONTAL AT 3 M			

No.	Frequency MHz	Factor dB	Reading dBm	Emission dBm	Limit dBm	Margin dB	Tower / Table cm deg	
1	3819.60 (PK)	-9.05	-50.94	-59.99	-13.00	-46.99	100	0
2	5729.40 (PK)	-3.11	-45.50	-48.61	-13.00	-35.61	100	0

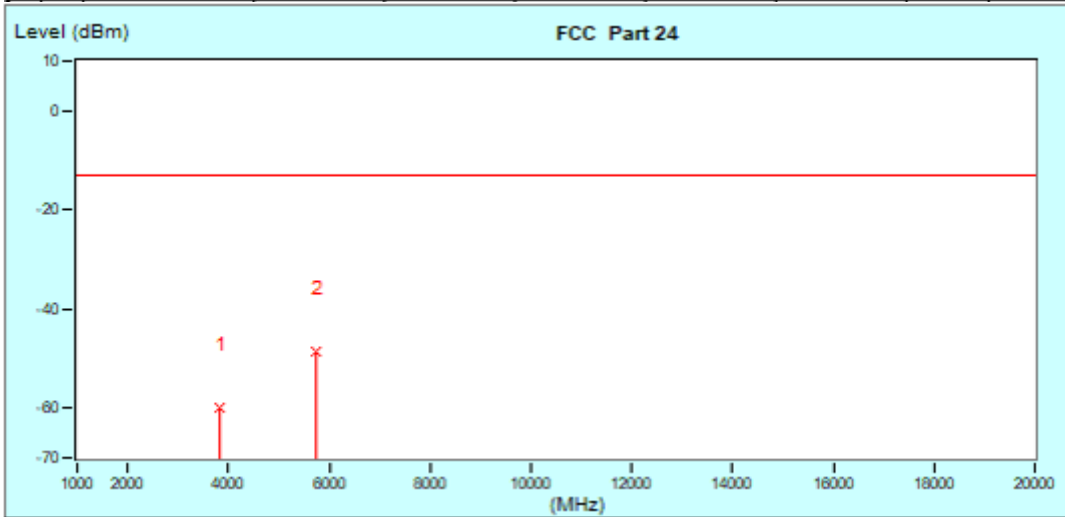



BUREAU VERITAS

Test Report No.: W7L-P23100004RF02

MODE	TX channel 810	FREQUENCY RANGE	Above 1000MHz
ENVIRONMENTAL CONDITIONS	23deg. C, 70%RH	INPUT POWER	AC 120V/60HZ
TESTED BY	Jace Hu		
ANTENNA POLARITY & TEST DISTANCE: VERTICAL AT 3 M			

No.	Frequency MHz	Factor dB	Reading dBm	Emission dBm	Limit dBm	Margin dB	Tower / Table cm deg
1	3819.60 (PK)	-9.05	-50.75	-59.80	-13.00	-46.80	100 0
* 2	5729.40 (PK)	-3.11	-29.61	-32.72	-13.00	-19.72	100 0

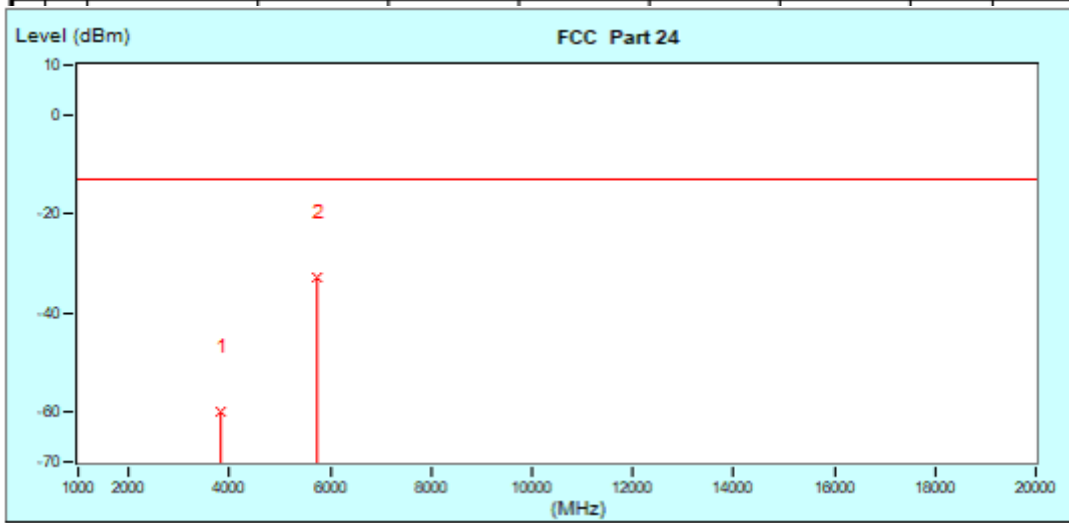



Test Report No.: W7L-P23100004RF02

LTE Band 25

CHANNEL BANDWIDTH: 1.4MHz / QPSK

MODE	TX channel 26365	FREQUENCY RANGE	Above 1000MHz
ENVIRONMENTAL CONDITIONS	23deg. C, 70%RH	INPUT POWER	AC 120V/60HZ
TESTED BY	Jace Hu		
ANTENNA POLARITY & TEST DISTANCE: HORIZONTAL AT 3 M			

No.	Frequency MHz	Factor dB	Reading dBm	Emission dBm	Limit dBm	Margin dB	Tower / Table cm deg	
1	3760.00 (PK)	-9.07	-47.80	-56.87	-13.00	-43.87	100	0
* 2	5640.00 (PK)	-3.17	-52.07	-55.24	-13.00	-42.24	100	0

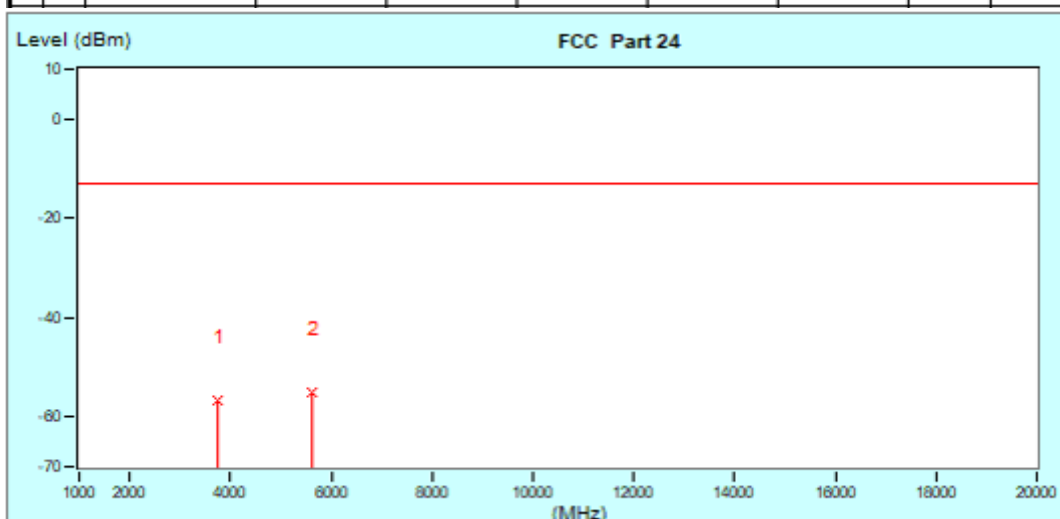



**BUREAU
VERITAS**

Test Report No.: W7L-P23100004RF02

MODE	TX channel 26365	FREQUENCY RANGE	Above 1000MHz
ENVIRONMENTAL CONDITIONS	23deg. C, 70%RH	INPUT POWER	AC 120V/60HZ
TESTED BY	Jace Hu		
ANTENNA POLARITY & TEST DISTANCE: VERTICAL AT 3 M			

No.	Frequency MHz	Factor dB	Reading dBm	Emission dBm	Limit dBm	Margin dB	Tower / Table cm deg	
1	3780.00 (PK)	-9.07	-48.27	-57.34	-13.00	-44.34	100	0
* 2	5640.00 (PK)	-3.17	-52.42	-55.59	-13.00	-42.59	100	0

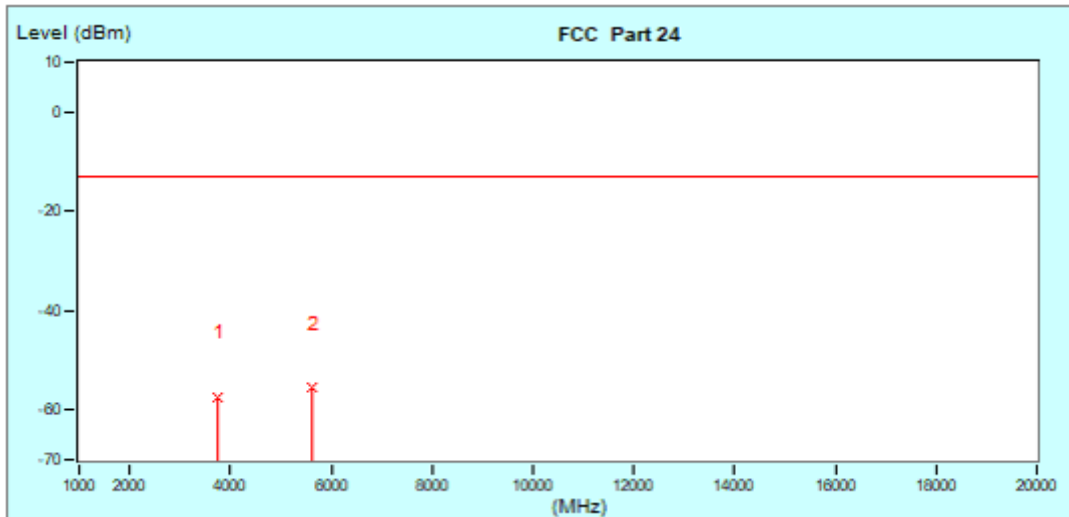



BUREAU VERITAS

Test Report No.: W7L-P23100004RF02

CHANNEL BANDWIDTH: 3MHz / QPSK

MODE	TX channel 26365	FREQUENCY RANGE	Above 1000MHz
ENVIRONMENTAL CONDITIONS	23deg. C, 70%RH	INPUT POWER	AC 120V/60HZ
TESTED BY	Jace Hu		
ANTENNA POLARITY & TEST DISTANCE: HORIZONTAL AT 3 M			

No.	Frequency MHz	Factor dB	Reading dBm	Emission dBm	Limit dBm	Margin dB	Tower / Table cm deg	
1	3760.00 (PK)	-9.07	-48.35	-57.42	-13.00	-44.42	100	0
* 2	5640.00 (PK)	-3.17	-52.06	-55.23	-13.00	-42.23	100	0

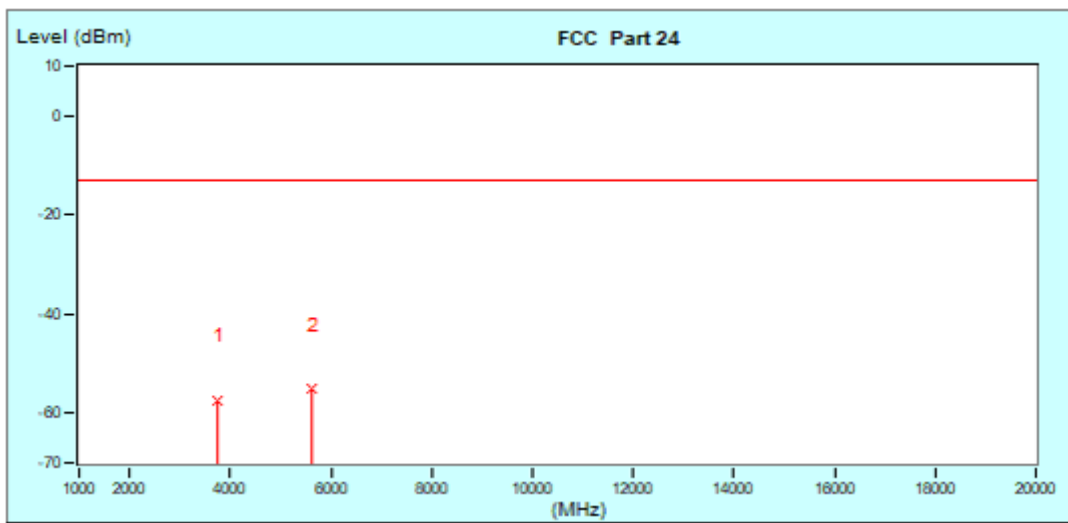



**BUREAU
VERITAS**

Test Report No.: W7L-P23100004RF02

MODE	TX channel 26365	FREQUENCY RANGE	Above 1000MHz
ENVIRONMENTAL CONDITIONS	23deg. C, 70%RH	INPUT POWER	AC 120V/60HZ
TESTED BY	Jace Hu		
ANTENNA POLARITY & TEST DISTANCE: VERTICAL AT 3 M			

No.	Frequency MHz	Factor dB	Reading dBm	Emission dBm	Limit dBm	Margin dB	Tower / Table cm deg
1	3760.00 (PK)	-9.07	-47.82	-56.89	-13.00	-43.89	100 0
* 2	5640.00 (PK)	-3.17	-52.31	-55.48	-13.00	-42.48	100 0

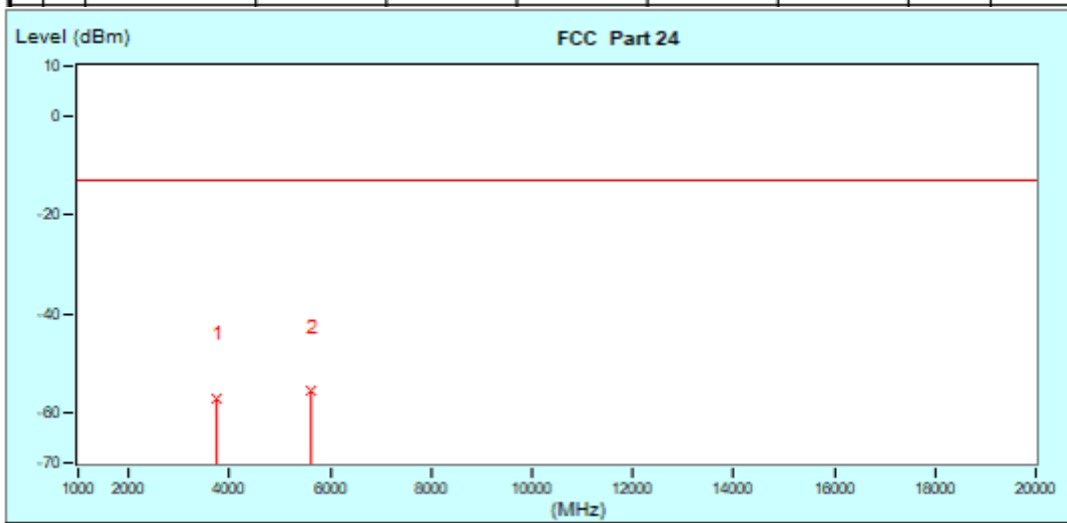



BUREAU VERITAS

Test Report No.: W7L-P23100004RF02

CHANNEL BANDWIDTH: 5MHz / QPSK

MODE	TX channel 26365	FREQUENCY RANGE	Above 1000MHz
ENVIRONMENTAL CONDITIONS	23deg. C, 70%RH	INPUT POWER	AC 120V/60HZ
TESTED BY	Jace Hu		
ANTENNA POLARITY & TEST DISTANCE: HORIZONTAL AT 3 M			

No.	Frequency MHz	Factor dB	Reading dBm	Emission dBm	Limit dBm	Margin dB	Tower / Table cm deg	
1	3780.00 (PK)	-9.07	-48.93	-58.00	-13.00	-43.00	100	0
* 2	5640.00 (PK)	-3.17	-51.91	-55.08	-13.00	-42.08	100	0

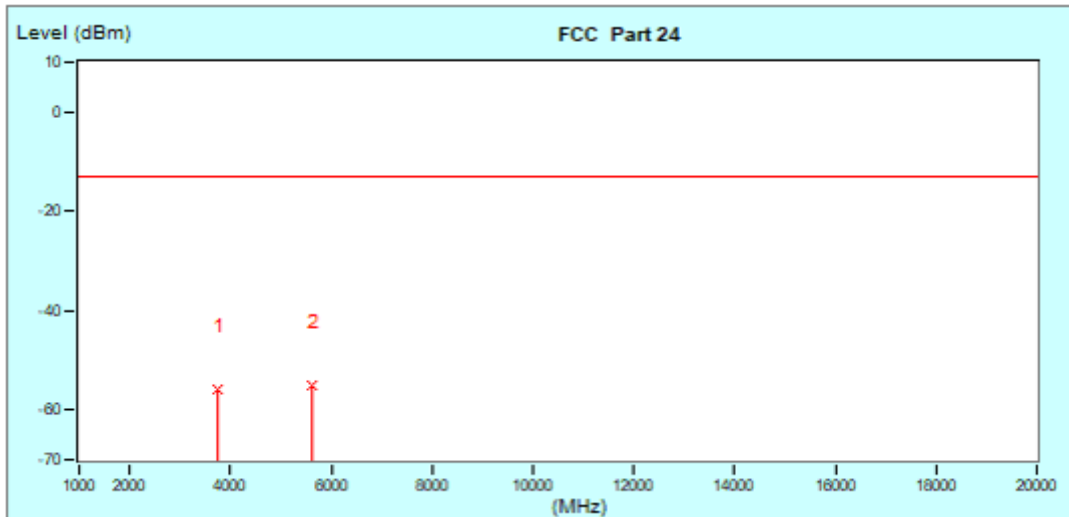



**BUREAU
VERITAS**

Test Report No.: W7L-P23100004RF02

MODE	TX channel 26365	FREQUENCY RANGE	Above 1000MHz
ENVIRONMENTAL CONDITIONS	23deg. C, 70%RH	INPUT POWER	AC 120V/60HZ
TESTED BY	Jace Hu		
ANTENNA POLARITY & TEST DISTANCE: VERTICAL AT 3 M			

No.	Frequency MHz	Factor dB	Reading dBm	Emission dBm	Limit dBm	Margin dB	Tower / Table cm deg	
* 1	3760.00 (PK)	-9.07	-46.12	-55.19	-13.00	-42.19	100	0
2	5640.00 (PK)	-3.17	-52.09	-55.26	-13.00	-42.26	100	0

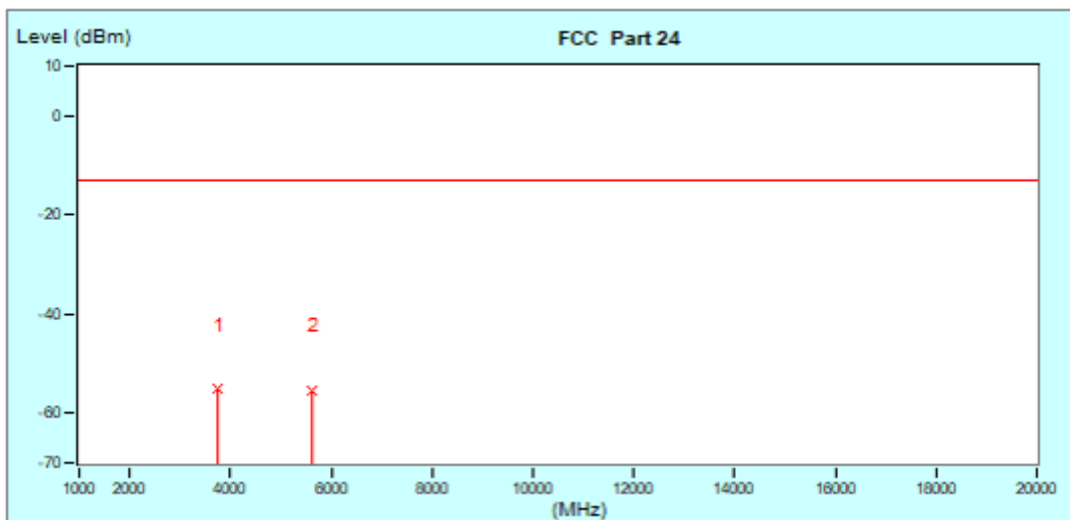



BUREAU VERITAS

Test Report No.: W7L-P23100004RF02

CHANNEL BANDWIDTH: 10MHz / QPSK

MODE	TX channel 26365	FREQUENCY RANGE	Above 1000MHz
ENVIRONMENTAL CONDITIONS	23deg. C, 70%RH	INPUT POWER	AC 120V/60HZ
TESTED BY	Jace Hu		
ANTENNA POLARITY & TEST DISTANCE: HORIZONTAL AT 3 M			

No.	Frequency MHz	Factor dB	Reading dBm	Emission dBm	Limit dBm	Margin dB	Tower / Table cm deg	
1	3780.00 (PK)	-9.07	-48.22	-57.29	-13.00	-44.29	100	0
* 2	5640.00 (PK)	-3.17	-52.15	-55.32	-13.00	-42.32	100	0

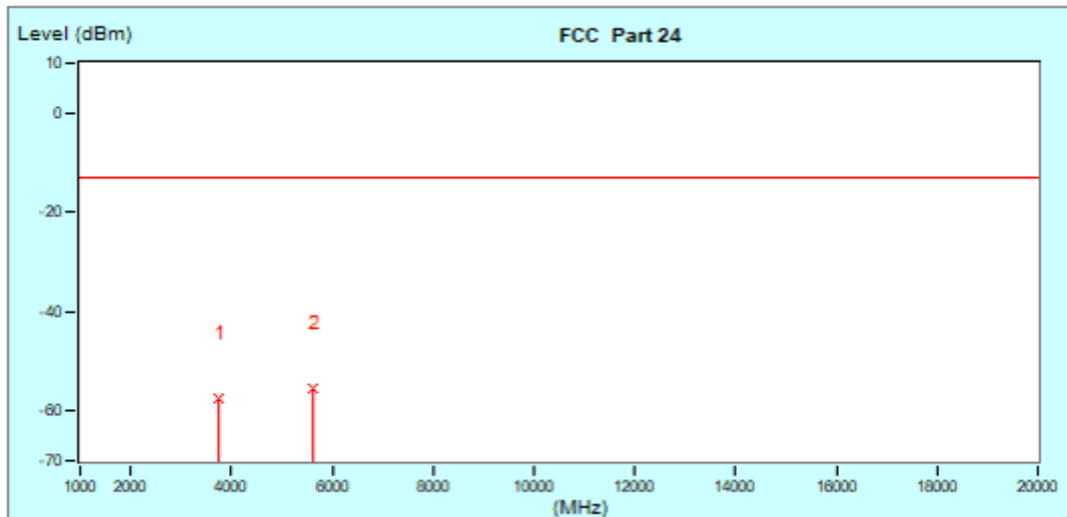



**BUREAU
VERITAS**

Test Report No.: W7L-P23100004RF02

MODE	TX channel 26365	FREQUENCY RANGE	Above 1000MHz
ENVIRONMENTAL CONDITIONS	23deg. C, 70%RH	INPUT POWER	AC 120V/60HZ
TESTED BY	Jace Hu		
ANTENNA POLARITY & TEST DISTANCE: VERTICAL AT 3 M			

No.	Frequency MHz	Factor dB	Reading dBm	Emission dBm	Limit dBm	Margin dB	Tower / Table cm deg	
1	3760.00 (PK)	-9.07	-47.49	-56.56	-13.00	-43.56	100	0
2	5640.00 (PK)	-3.17	-51.46	-54.63	-13.00	-41.63	100	0

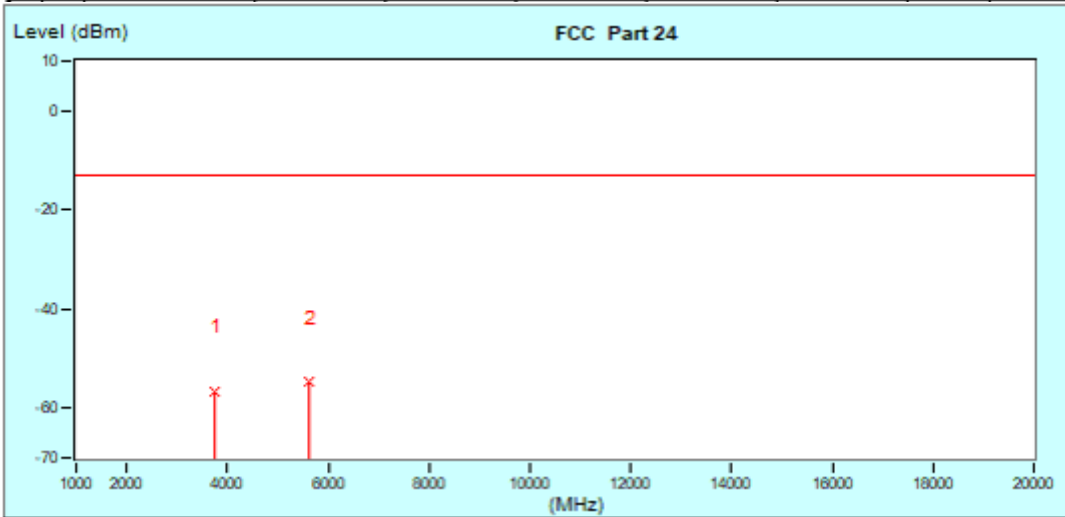



BUREAU VERITAS

Test Report No.: W7L-P23100004RF02

CHANNEL BANDWIDTH: 15MHz / QPSK

CH26115

MODE	TX channel 26115	FREQUENCY RANGE	Above 1000MHz
ENVIRONMENTAL CONDITIONS	23deg. C, 70%RH	INPUT POWER	AC 120V/60HZ
TESTED BY	Jace Hu		
ANTENNA POLARITY & TEST DISTANCE: HORIZONTAL AT 3 M			

No.	Frequency MHz	Factor dB	Reading dBm	Emission dBm	Limit dBm	Margin dB	Tower / Table cm deg	
1	3715.00 (PK)	-9.08	-45.18	-54.26	-13.00	-41.26	100	0
2	5572.50 (PK)	-3.22	-51.77	-54.99	-13.00	-41.99	100	0

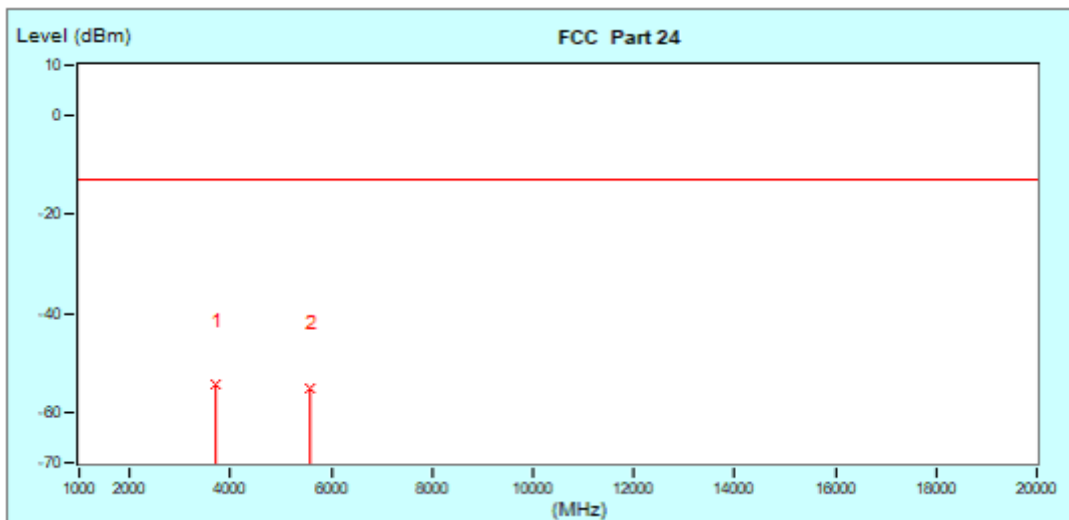



BUREAU VERITAS

Test Report No.: W7L-P23100004RF02

MODE	TX channel 26115	FREQUENCY RANGE	Above 1000MHz
ENVIRONMENTAL CONDITIONS	23deg. C, 70%RH	INPUT POWER	AC 120V/60HZ
TESTED BY	Jace Hu		
ANTENNA POLARITY & TEST DISTANCE: VERTICAL AT 3 M			

No.	Frequency MHz	Factor dB	Reading dBm	Emission dBm	Limit dBm	Margin dB	Tower / Table cm deg	
1	3715.00 (PK)	-9.08	-45.18	-54.26	-13.00	-41.26	100	0
2	5572.50 (PK)	-3.22	-51.77	-54.99	-13.00	-41.99	100	0

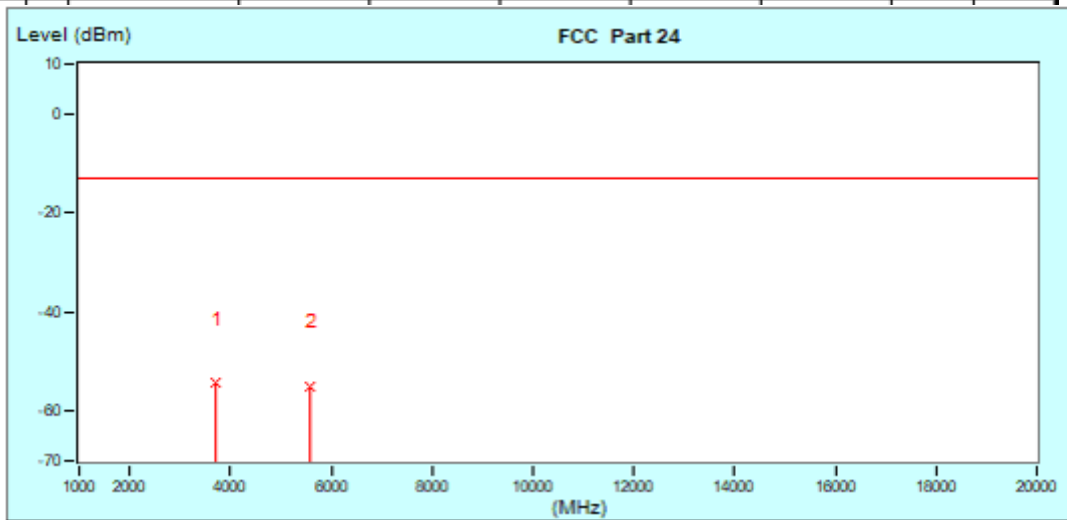



BUREAU
VERITAS

Test Report No.: W7L-P23100004RF02

CH26365

MODE	TX channel 26365	FREQUENCY RANGE	Above 1000MHz
ENVIRONMENTAL CONDITIONS	23deg. C, 70%RH	INPUT POWER	AC 120V/60HZ
TESTED BY	Jace Hu		
ANTENNA POLARITY & TEST DISTANCE: HORIZONTAL AT 3 M			

No.	Frequency MHz	Factor dB	Reading dBm	Emission dBm	Limit dBm	Margin dB	Tower / Table cm deg	
1	3760.00 (PK)	-9.07	-51.39	-60.46	-13.00	-47.46	100	0
2	5640.00 (PK)	-3.17	-50.29	-53.46	-13.00	-40.46	100	0

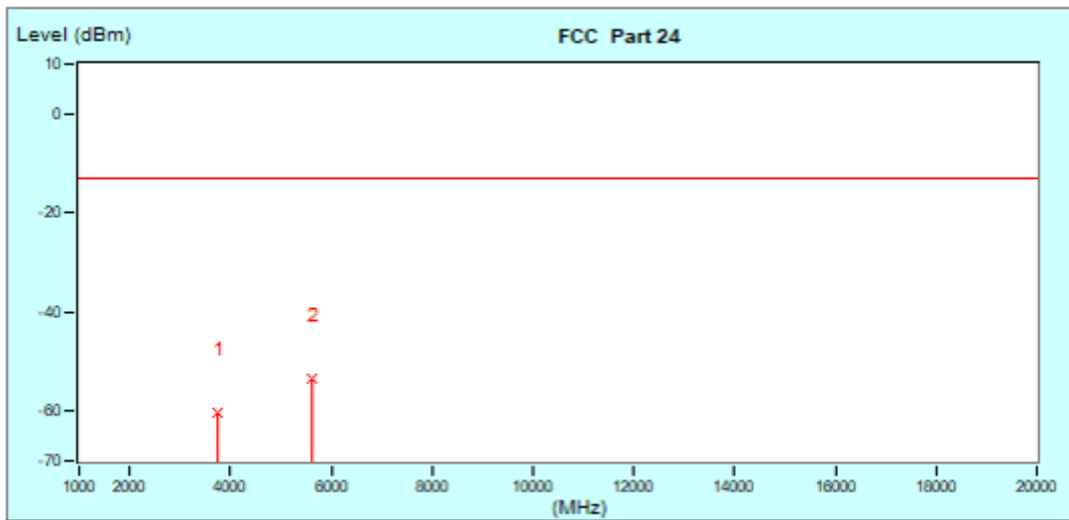



**BUREAU
VERITAS**

Test Report No.: W7L-P23100004RF02

MODE	TX channel 26365	FREQUENCY RANGE	Above 1000MHz
ENVIRONMENTAL CONDITIONS	23deg. C, 70%RH	INPUT POWER	AC 120V/60HZ
TESTED BY	Jace Hu		
ANTENNA POLARITY & TEST DISTANCE: VERTICAL AT 3 M			

No.	Frequency MHz	Factor dB	Reading dBm	Emission dBm	Limit dBm	Margin dB	Tower / Table cm deg	
1	3760.00 (PK)	-9.07	-50.12	-59.19	-13.00	-46.19	100	0
* 2	5640.00 (PK)	-3.17	-51.02	-54.19	-13.00	-41.19	100	0

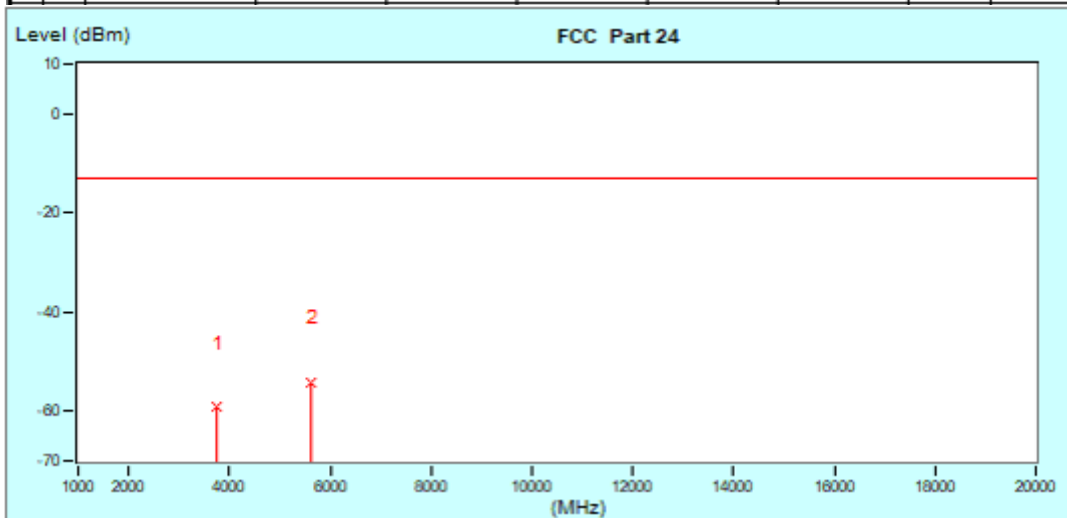



**BUREAU
VERITAS**

Test Report No.: W7L-P23100004RF02

CH26615

MODE	TX channel 26615	FREQUENCY RANGE	Above 1000MHz
ENVIRONMENTAL CONDITIONS	23deg. C, 70%RH	INPUT POWER	AC 120V/60HZ
TESTED BY	Jace Hu		
ANTENNA POLARITY & TEST DISTANCE: HORIZONTAL AT 3 M			

No.	Frequency MHz	Factor dB	Reading dBm	Emission dBm	Limit dBm	Margin dB	Tower / Table cm deg	
1	3815.00 (PK)	-9.05	-47.62	-56.67	-13.00	-43.67	100	0
2	5722.50 (PK)	-3.12	-52.28	-55.40	-13.00	-42.40	100	0

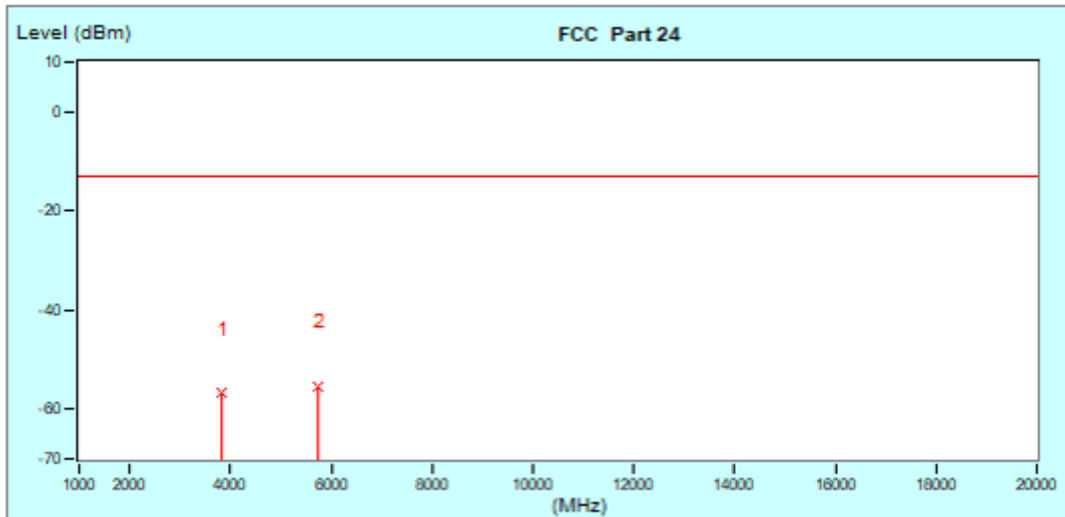



**BUREAU
VERITAS**

Test Report No.: W7L-P23100004RF02

MODE	TX channel 26615	FREQUENCY RANGE	Above 1000MHz
ENVIRONMENTAL CONDITIONS	23deg. C, 70%RH	INPUT POWER	AC 120V/60HZ
TESTED BY	Jace Hu		
ANTENNA POLARITY & TEST DISTANCE: VERTICAL AT 3 M			

No.	Frequency MHz	Factor dB	Reading dBm	Emission dBm	Limit dBm	Margin dB	Tower / Table cm deg	
1	3815.00 (PK)	-9.05	-49.63	-58.68	-13.00	-45.68	100	0
2	5722.50 (PK)	-3.12	-52.40	-55.52	-13.00	-42.52	100	0

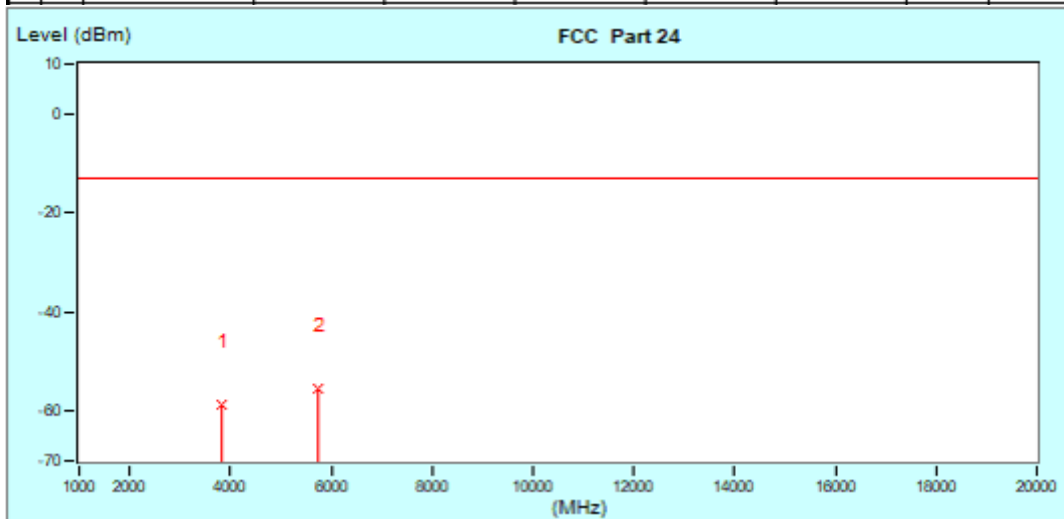



BUREAU VERITAS

Test Report No.: W7L-P23100004RF02

CHANNEL BANDWIDTH: 20MHz / QPSK

MODE	TX channel 26365	FREQUENCY RANGE	Above 1000MHz
ENVIRONMENTAL CONDITIONS	23deg. C, 70%RH	INPUT POWER	AC 120V/60HZ
TESTED BY	Jace Hu		
ANTENNA POLARITY & TEST DISTANCE: HORIZONTAL AT 3 M			

No.	Frequency MHz	Factor dB	Reading dBm	Emission dBm	Limit dBm	Margin dB	Tower / Table cm deg	
1	3780.00 (PK)	-9.07	-51.42	-60.49	-13.00	-47.49	100	0
2	5840.00 (PK)	-3.17	-52.78	-55.95	-13.00	-42.95	100	0

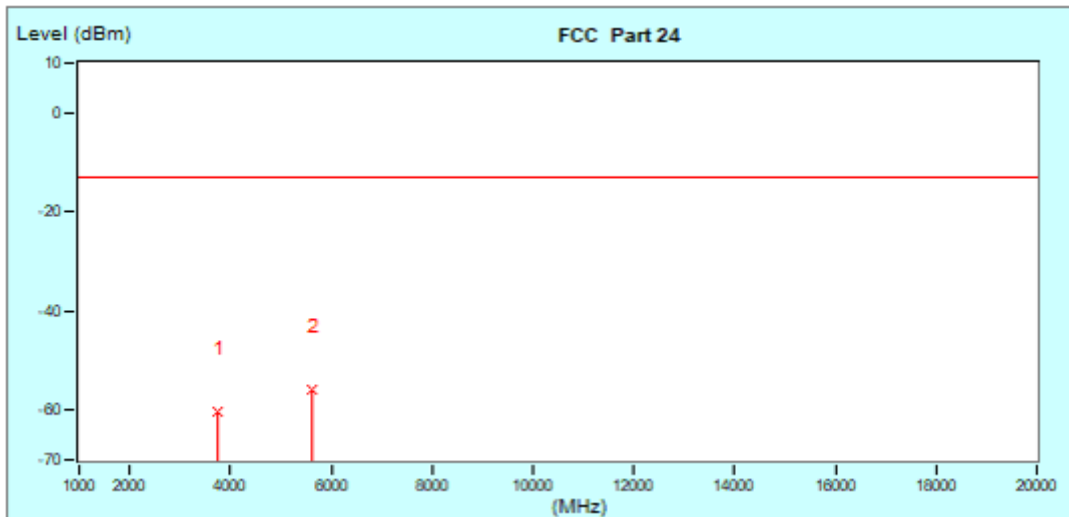



BUREAU VERITAS

Test Report No.: W7L-P23100004RF02

MODE	TX channel 26365	FREQUENCY RANGE	Above 1000MHz
ENVIRONMENTAL CONDITIONS	23deg. C, 70%RH	INPUT POWER	AC 120V/60HZ
TESTED BY	Jace Hu		
ANTENNA POLARITY & TEST DISTANCE: VERTICAL AT 3 M			

No.	Frequency MHz	Factor dB	Reading dBm	Emission dBm	Limit dBm	Margin dB	Tower / Table cm deg	
1	3760.00 (PK)	-9.07	-51.46	-60.53	-13.00	-47.53	100	0
* 2	5640.00 (PK)	-3.17	-52.68	-55.85	-13.00	-42.85	100	0

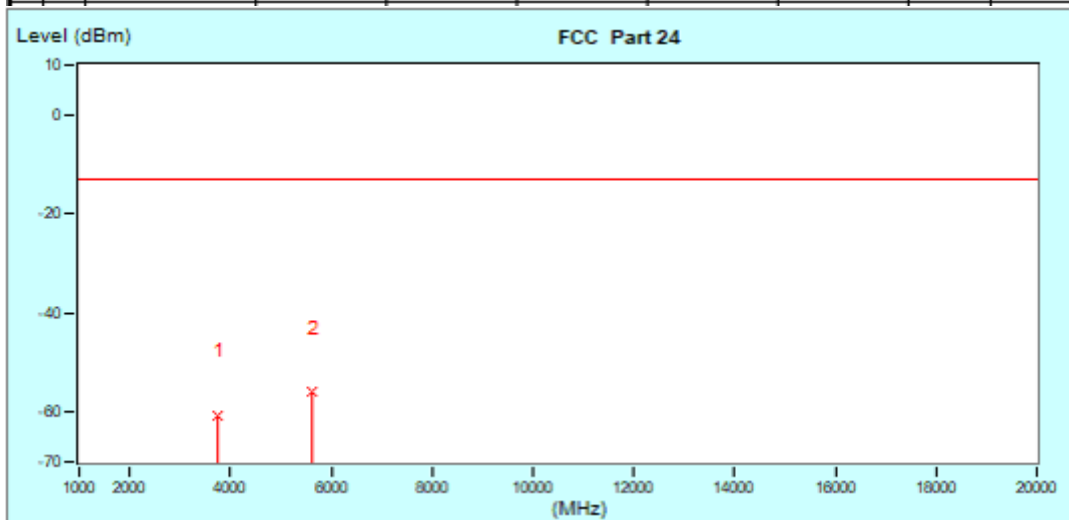



3.7 PEAK TO AVERAGE RATIO

3.7.1 LIMITS OF PEAK TO AVERAGE RATIO MEASUREMENT

In measuring transmissions in this band using an average power technique, the peak to-average ratio (PAR) of the transmission may not exceed 13 dB

3.7.2 TEST SETUP

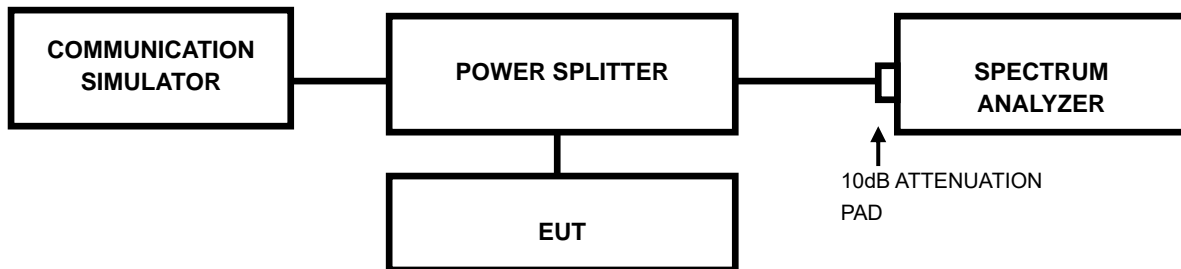

3.7.3 TEST PROCEDURES

1. Set resolution/measurement bandwidth \geq signal's occupied bandwidth;
2. Set the number of counts to a value that stabilizes the measured CCDF curve;
3. Record the maximum PAPR level associated with a probability of 0.1%.



**BUREAU
VERITAS**

Test Report No.: W7L-P23100004RF02

3.7.4 TEST RESULTS

Please Refer to Module report R2007A0435-R5.



**BUREAU
VERITAS**

Test Report No.: W7L-P23100004RF02

4 INFORMATION ON THE TESTING LABORATORIES

We, BV 7LAYERS COMMUNICATIONS TECHNOLOGY (SHENZHEN) CO. LTD., were founded in 2015 to provide our best service in EMC, Radio, Telecom and Safety consultation. Our laboratories are accredited and approved according to ISO/IEC 17025.

If you have any comments, please feel free to contact us at the following:

Shenzhen EMC/RF Lab:

Tel: +86-755-88696566

Fax: +86-755-88696577

Email: customerservice.sw@bureauveritas.com

Web Site: www.adt.com.tw

The address and road map of all our labs can be found in our web site also.



Test Report No.: W7L-P23100004RF02

5 MODIFICATIONS RECORDERS FOR ENGINEERING CHANGES TO THE EUT BY THE LAB

No any modifications are made to the EUT by the lab during the test.

---END---