



Test Report No.: W7L-P23100004RF01



# FCC TEST REPORT (PART 22)



Applicant:	Particle Industries, Inc
Address:	325 9th Street, San Francisco, CA 94103, United States Of America

Manufacturer or Supplier:	Particle Industries, Inc
Address:	325 9th Street, San Francisco, CA 94103, United States Of America
Product:	Montior One DE
Brand Name:	Particle
Model Name:	MON404-DE
FCC ID:	2AEMI-MONEDE
Date of tests:	Oct. 11, 2023 ~ Oct. 20, 2023

The tests have been carried out according to the requirements of the following standard:

- FCC PART 22, Subpart H     FCC Part 2
- ANSI/TIA/EIA-603-D     ANSI C63.26-2015
- ANSI/TIA/EIA-603-E

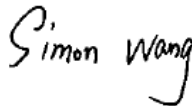
CONCLUSION: The submitted sample was found to COMPLY with the test requirement

Prepared by Simon Wang Engineer / Mobile Department	Approved by Luke Lu Manager / Mobile Department
	
Date: Oct. 20, 2023	Date: Oct. 20, 2023

This report is governed by, and incorporates by reference, the Conditions of Testing as posted at the date of issuance of this report at <http://www.bureauveritas.com/home/about-us/our-business/cps/about-us/terms-conditions/> and is intended for your exclusive use. Any copying or replication of this report to or for any other person or entity, or use of our name or trademark, is permitted only with our prior written permission. This report sets forth our findings solely with respect to the test samples identified herein. The results set forth in this report are not indicative or representative of the quality or characteristics of the lot from which a test sample was taken or any similar or identical product unless specifically and expressly noted. Our report includes all of the tests requested by you and the results thereof based upon the information that you provided to us. Measurement uncertainty is only provided upon request for accredited tests. Statements of conformity are based on simple acceptance criteria without taking measurement uncertainty into account, unless otherwise requested in writing. You have 60 days from date of issuance of this report to notify us of any material error or omission caused by our negligence or if you require measurement uncertainty; provided, however, that such notice shall be in writing and shall specifically address the issue you wish to raise. A failure to raise such issue within the prescribed time shall constitute your unqualified acceptance of the completeness of this report, the tests conducted and the correctness of the report contents.



# TABLE OF CONTENTS

**RELEASE CONTROL RECORD .....4**

**1 SUMMARY OF TEST RESULTS.....5**

1.1 MEASUREMENT UNCERTAINTY .....6

1.2 TEST SITE AND INSTRUMENTS .....7

**2 GENERAL INFORMATION .....8**

2.1 GENERAL DESCRIPTION OF EUT .....8

2.2 CONFIGURATION OF SYSTEM UNDER TEST ..... 10

2.3 DESCRIPTION OF SUPPORT UNITS ..... 11

2.4 TEST ITEM AND TEST CONFIGURATION..... 11

2.5 EUT OPERATING CONDITIONS ..... 13

2.6 GENERAL DESCRIPTION OF APPLIED STANDARDS ..... 14

**3 TEST TYPES AND RESULTS.....15**

3.1 OUTPUT POWER MEASUREMENT ..... 15

3.1.1 LIMITS OF OUTPUT POWER MEASUREMENT ..... 15

3.1.2 TEST PROCEDURES ..... 15

3.1.3 TEST SETUP ..... 16

3.1.4 TEST RESULTS ..... 16

3.2 FREQUENCY STABILITY MEASUREMENT ..... 22

3.2.1 LIMITS OF FREQUENCY STABILITY MEASUREMENT ..... 22

3.2.2 TEST PROCEDURE ..... 22

3.2.3 TEST SETUP ..... 22

3.2.4 TEST RESULTS ..... 23

3.3 OCCUPIED BANDWIDTH MEASUREMENT ..... 24

3.3.1 LIMITS OF OCCUPIED BANDWIDTH MEASUREMENT ..... 24

3.3.2 TEST SETUP ..... 24

3.3.3 TEST PROCEDURES ..... 24

3.3.4 TEST RESULTS ..... 25

3.4 BAND EDGE MEASUREMENT ..... 26

3.4.1 LIMITS OF BAND EDGE MEASUREMENT ..... 26

3.4.2 TEST SETUP ..... 26

3.4.3 TEST PROCEDURES ..... 27

3.4.4 TEST RESULTS ..... 28

3.5 CONDUCTED SPURIOUS EMISSIONS..... 29

3.5.1 LIMITS OF CONDUCTED SPURIOUS EMISSIONS MEASUREMENT ..... 29

3.5.2 TEST PROCEDURE ..... 29

3.5.3 TEST SETUP ..... 29

3.5.4 TEST RESULTS ..... 30

3.6 RADIATED EMISSION MEASUREMENT ..... 31

3.6.1 LIMITS OF RADIATED EMISSION MEASUREMENT ..... 31

3.6.2 TEST PROCEDURES ..... 31

3.6.3 DEVIATION FROM TEST STANDARD ..... 31

3.6.4 TEST SETUP ..... 32



**BUREAU  
VERITAS**

**Test Report No.: W7L-P23100004RF01**

3.6.5	TEST RESULTS .....	34
3.7	PEAK TO AVERAGE RATIO .....	60
3.7.1	LIMITS OF PEAK TO AVERAGE RATIO MEASUREMENT .....	60
3.7.2	TEST SETUP .....	60
3.7.3	TEST PROCEDURES .....	60
3.7.4	TEST RESULTS .....	61
<b>4</b>	<b>PHOTOGRAPHS OF THE TEST CONFIGURATION .....</b>	<b>62</b>
<b>5</b>	<b>INFORMATION ON THE TESTING LABORATORIES .....</b>	<b>63</b>
<b>6</b>	<b>MODIFICATIONS RECORDERS FOR ENGINEERING CHANGES TO THE EUT BY THE LAB .....</b>	<b>64</b>



**BUREAU**  
**VERITAS**

Test Report No.: W7L-P23100004RF01

## RELEASE CONTROL RECORD

ISSUE NO.	REASON FOR CHANGE	DATE ISSUED
W7L-P23100004RF01	Original release	Oct. 20, 2023



# 1 SUMMARY OF TEST RESULTS

The EUT has been tested according to the following specifications:

APPLIED STANDARD: FCC Part 22 & Part 2		
STANDARD SECTION	TEST TYPE	RESULT
§2.1046	Conducted Output Power	Compliance
§22.913 (a)(5)	Effective Radiated Power	Compliance
§2.1055 §22.355	Frequency Stability	See Note
§2.1049	Occupied Bandwidth	See Note
§22.913 (d)	Peak to average ratio*	See Note
§22.917(a)	Band Edge Measurements	See Note
§2.1051 §22.917(a)	Conducted Spurious Emissions	See Note
§2.1053 §22.917(a)	Radiated Spurious Emissions	Compliance

\* Refer to KDB 971168 D01 Power Meas License Digital Systems v03r01.

**NOTE:** Refer to Module report R2007A0435-R4, FCC ID: XMR201707BG96.



## 1.1 MEASUREMENT UNCERTAINTY

Where relevant, the following measurement uncertainty levels have been estimated for tests performed on the EUT as specified in CISPR 16-4-2:

MEASUREMENT	UNCERTAINTY
Maximum Peak Output Power	±2.06dB
Frequency Stability	±76.97Hz
Radiated emissions (9KHz~30MHz)	±2.68dB
Radiated emissions (30MHz~1GHz)	±4.98dB
Radiated emissions (1GHz ~6GHz)	±4.70dB
Radiated emissions (6GHz ~18GHz)	±4.60dB
Radiated emissions (18GHz ~40GHz)	±4.12dB
Conducted emissions	±4.01dB
Occupied Channel Bandwidth	±43.58KHz
Band Edge Measurements	±4.70dB
Peak to average ratio	±0.76dB

This uncertainty represents an expanded uncertainty expressed at approximately the 95% confidence level using a coverage factor of k=2.



## 1.2 TEST SITE AND INSTRUMENTS

Equipment	Manufacturer	Model No.	Serial No.	Last Cal.	Next Cal.
MXE EMI Receiver	KEYSIGHT	N9038A-544	MY54450026	Mar. 28,23	Mar. 27,24
EXA Signal Analyzer	KEYSIGHT	N9010A-544	MY54510355	May.10,23	May.09,24
Loop Antenna	Schwarzbeck	FMZB 1519B	00173	Sep.02,23	Sep.01,24
Bilog Antenna	ETS-LINDGRE N	3143B	00161965	Feb. 18,23	Feb. 17,24
Horn Antenna	ETS-LINDGRE N	3117	00168692	Feb. 18,23	Feb. 17,24
Horn Antenna (18GHz-40GHz)	N/A	QWH-SL-18-40-K- SG/QMS-00361	15433	Sep.03, 23	Sep.02, 24
Radio Communication Analyzer	ANRITSU	MT8820C	6201465426	Feb. 14,23	Feb. 13,24
Signal Pre-Amplifier	EMSI	EMC 9135	980249	May. 06,23	May. 05,24
Signal Pre-Amplifier	EMSI	EMC 012645B	980257	May.10,23	May.09,24
Signal Pre-Amplifier	EMSI	EMC 184045B	980259	Feb. 17,23	Feb.16,24
3m Semi-anechoic Chamber	ETS-LINDGRE N	9m*6m*6m	Euroshieldpn- CT0001143-121 6	May. 22, 23	May. 21,26
Test Software	E3	V 9.160323	N/A	N/A	N/A
Test Software	JS1120	3.1.36	N/A	N/A	N/A
10dB Attenuator	JFW/USA	50HF-010-SMA	50HF-010-SMA	May. 06,23	May. 05,24
Power Meter	Anritsu	ML2495A	1506002	Feb. 14,23	Feb. 13,24
Power Sensor	Anritsu	MA2411B	1339352	Feb. 14,23	Feb. 13,24
Temperature Chamber	ESPEC	SH-242	93000855	May. 06,23	May. 05,24
MXG Analog Microwave Signal Generator	KEYSIGHT	N5183A	MY50143024	Feb. 14,23	Feb. 13,24
Base station R&S CMW500	Rohde&Schwa rz	CMW500	153085	May.10,23	May.09,24
DC Source	Kikusui/JP	PMX18-5A	N/A	Aug. 11,23	Aug. 10,24

- NOTE:**
1. The calibration interval of the above test instruments is 12 months or 36 months and the calibrations are traceable to CEPREI/CHINA, GRGT/CHINA and NIM/CHINA.
  2. The test was performed in 3m Semi-anechoic Chamber and RF Oven Room.
  3. The horn antenna is used only for the measurement of emission frequency above 1GHz if tested.
  4. The FCC Site Registration No. is 525120; The Designation No. is CN1171.



## 2 GENERAL INFORMATION

### 2.1 GENERAL DESCRIPTION OF EUT

<b>PRODUCT</b>	Montior One DE	
<b>BRAND NAME</b>	Particle	
<b>MODEL NAME</b>	MON404-DE	
<b>NOMINAL VOLTAGE</b>	24Vdc (adapter or host equipment) 3.7Vdc (Li-ion, battery)	
<b>MODULATION TYPE</b>	<b>GSM/EDGE</b>	GMSK, 8PSK
	<b>LTE CAT-M1</b>	QPSK, 16QAM
<b>FREQUENCY RANGE</b>	<b>GSM/EDGE</b>	824.2MHz ~ 848.8MHz
	<b>LTE Band 5 (Channel Bandwidth: 1.4MHz)</b>	824.7MHz ~ 848.3MHz
	<b>LTE Band 5 (Channel Bandwidth: 3MHz)</b>	825.5MHz ~ 847.5MHz
	<b>LTE Band 5 (Channel Bandwidth: 5MHz)</b>	826.5MHz ~ 846.5MHz
	<b>LTE Band 5 (Channel Bandwidth: 10MHz)</b>	829MHz ~ 844MHz
<b>MAX. ERP POWER</b>	<b>GSM</b>	1527.57mW
	<b>EDGE</b>	376.7mW
	<b>LTE Band 5 (Channel Bandwidth: 1.4MHz)</b>	211.35mW
	<b>LTE Band 5 (Channel Bandwidth: 3MHz)</b>	208.45mW
	<b>LTE Band 5 (Channel Bandwidth: 5MHz)</b>	210.86mW
	<b>LTE Band 5 (Channel Bandwidth: 10MHz)</b>	213.8mW
<b>EMISSION DESIGNATOR GOGN</b>	<b>GSM</b>	246KGXW
	<b>EDGE</b>	249KG7W
	<b>LTE Band 5 (Channel Bandwidth: 1.4MHz)</b>	QPSK: 1M11G7D
		16QAM: 947KW7D
		64QAM: /
	<b>LTE Band 5 (Channel Bandwidth: 3MHz)</b>	QPSK: 1M16G7D
		16QAM: 983KW7D
		64QAM: /
	<b>LTE Band 5 (Channel Bandwidth: 5MHz)</b>	QPSK: 1M15G7D
		16QAM: 1M01W7D





		64QAM: /
	<b>LTE Band 5 (Channel Bandwidth: 10MHz)</b>	QPSK: 1M20G7D
		16QAM: 1M05W7D
		64QAM: /
<b>ANTENNA TYPE</b>	Fixed External Antenna with 1.7dBi gain for GSM850/ LTE B5	
<b>HW VERSION</b>	v1.2.0	
<b>SW VERSION</b>	v4.0.2	
<b>I/O PORTS</b>	Refer to user's manual	
<b>CABLE SUPPLIED</b>	Cable 1: non-shielded cable, with w/o ferrite core, 1.5 meter Cable 2: non-shielded cable, with w/o ferrite core, 1.5 meter	
<b>EXTREME TEMPERATURE</b>	-20~60 °C	
<b>EXTREME VOLTAGE</b>	3.6V - 4.2V	

**NOTE:**

- For a more detailed features description, please refer to the manufacturer's specifications or the user's manual.
- The EUT incorporates a SISO function. Physically, the EUT provides one completed transmitter and one receiver.

MODULATION MODE	TX FUNCTION
GSM/GPRS/EDGE	1TX/1RX
LTE	1TX/1RX

- For the test results, the EUT had been tested with all conditions. But only the worst case was shown in test report.

**List of Accessory:**

ACCESSORIES	BRAND	MANUFACTURER	MODEL	SPECIFICATION
Battery	Guangdong Zhaoneng	Guangdong Zhaoneng	ZN18650-4P	Capacity: 3.7Vdc, 12200mAh
AC Adapter	TRI-MAG	TRI-MAG LLC	L6R30-240	I/P: 100-240Vac, 0.8A, O/P: 24Vdc, 1.25A
Cable 1	KAWEEI	KAWEEI technology	CBH-M12M-04 -1500	Signal Line, 1.5meter
Cable 2	KAWEEI	KAWEEI technology	115-00014 CBH-M12M-08 -1500	Signal Line, 1.5meter



## 2.2 CONFIGURATION OF SYSTEM UNDER TEST FOR RADIATION EMISSION

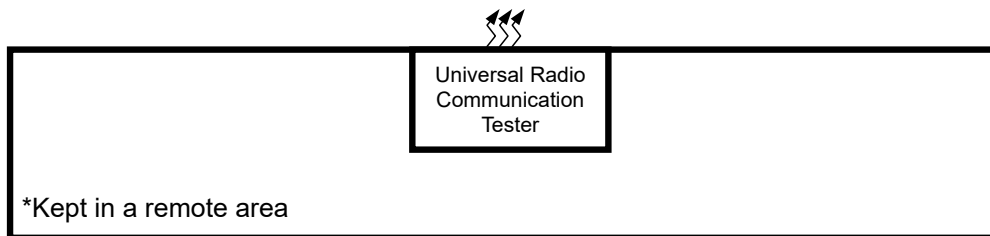
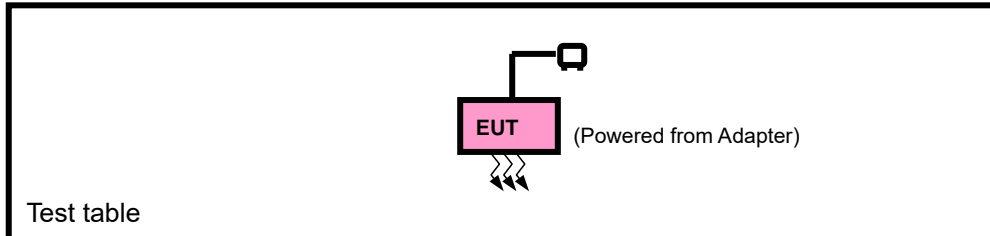



### 2.3 DESCRIPTION OF SUPPORT UNITS

The EUT has been tested as an independent unit together with other necessary accessories or support units. The following support units or accessories were used to form a representative test configuration during the tests.

NO.	PRODUCT	BRAND	MODEL NO.	SERIAL NO.	FCC ID
1	Adapter	Jingsai	CLS-050200	NA	N/A

NO.	SIGNAL CABLE DESCRIPTION OF THE ABOVE SUPPORT UNITS
1	NA

### 2.4 TEST ITEM AND TEST CONFIGURATION

Pre-Scan has been conducted to determine the worst-case mode from all possible combinations between available modulations, data rates, XYZ axis and antenna ports. The worst case in ERP and radiated emission was found when positioned on X-plane for GSM /EDGE /LTE. Following channel(s) was (were) selected for the final test as listed below:

EUT CONFIGURE MODE	DESCRIPTION
A	EUT + Adapter with GSM or LTE link



GSM MODE

EUT CONFIGURE MODE	TEST ITEM	AVAILABLE CHANNEL	TESTED CHANNEL	MODE
A	ERP	128 to 251	128, 190, 251	GSM,EDGE
A	RADIATED EMISSION	128 to 251	128, 190, 251	GSM,EDGE

LTE BAND 5 MODE

EUT CONFIGURE MODE	TEST ITEM	Available Channel	Tested Channel	Channel bandwidth	modulation	mode
A	ERP	20407 to 20643	20407, 20525, 20643	1.4MHz	QPSK,16QAM	1 RB / 0 RB Offset
		20415 to 20635	20415, 20525, 20635	3MHz	QPSK,16QAM	1 RB / 0 RB Offset
		20425 to 20625	20425, 20525, 20625	5MHz	QPSK,16QAM	1 RB / 0 RB Offset
		20450 to 20600	20450, 20525, 20600	10MHz	QPSK,16QAM	1 RB / 0 RB Offset
A	RADIATED EMISSION	20407 to 20643	20525	1.4MHz	QPSK	1 RB / 0 RB Offset
		20415 to 20635	20415, 20525, 20635	3MHz	QPSK	1 RB / 0 RB Offset
		20425 to 20625	20525	5MHz	QPSK	1 RB / 0 RB Offset
		20450 to 20600	20525	10MHz	QPSK	1 RB / 0 RB Offset

Note: 1.This device was tested under all bandwidths, RB configurations and modulations. The worst case was found in QPSK modulation.



**TEST CONDITION:**

TEST ITEM	ENVIRONMENTAL CONDITIONS	INPUT POWER	TESTED BY
ERP	23deg. C, 70%RH	DC 24V By Adapter	Jace Hu
RADIATED EMISSION	23deg. C, 70%RH	DC 24V By Adapter	Jace Hu

**2.5 EUT OPERATING CONDITIONS**

The EUT makes a call to the communication simulator. The communication simulator station system controlled a EUT to export maximum output power under transmission mode and specific channel frequency



**BUREAU  
VERITAS**

Test Report No.: W7L-P23100004RF01

## 2.6 GENERAL DESCRIPTION OF APPLIED STANDARDS

The EUT is a RF product. According to the specifications of the manufacturer, it must comply with the requirements of the following standards:

**FCC 47 CFR Part 2**

**FCC 47 CFR Part 22**

**KDB 971168 D01 Power Meas License Digital Systems v03r01**

**ANSI/TIA/EIA-603-D**

**ANSI/TIA/EIA-603-E**

**ANSI C63.26-2015**

**NOTE:** All test items have been performed and recorded as per the above standards.

### 3 TEST TYPES AND RESULTS

#### 3.1 OUTPUT POWER MEASUREMENT

##### 3.1.1 LIMITS OF OUTPUT POWER MEASUREMENT

Mobile / Portable station are limited to 7 watts e.r.p.

##### 3.1.2 TEST PROCEDURES

###### **EIRP / ERP MEASUREMENT:**

Per KDB 971168 D01 Power Meas License Digital Systems v03r01 or subclause 5.2.5.5 of ANSI C63.26-2015, the relevant equation for determining the ERP or EIRP from the conducted RF output power measured using the guidance provided above is:

$$\text{ERP or EIRP} = P_{\text{Meas}} + G_{\text{T}} - L_{\text{C}}$$

Where:

ERP or EIRP = effective radiated power or equivalent isotropically radiated power, respectively

(expressed in the same units as  $P_{\text{Meas}}$ , typically dBW or dBm);

$P_{\text{Meas}}$  = measured transmitter output power or PSD, in dBm or dBW;

$G_{\text{T}}$  = gain of the transmitting antenna, in dBd (ERP) or dBi (EIRP);

$L_{\text{C}}$  = signal attenuation in the connecting cable between the transmitter and antenna, in dB.

###### **CONDUCTED POWER MEASUREMENT:**

The EUT was set up for the maximum power with WCDMA link data modulation and link up with simulator. Set the EUT to transmit under low, middle and high channel and record the power level shown on simulator.



### 3.1.3 TEST SETUP

**EIRP / ERP Measurement:**

**CONDUCTED POWER MEASUREMENT:**

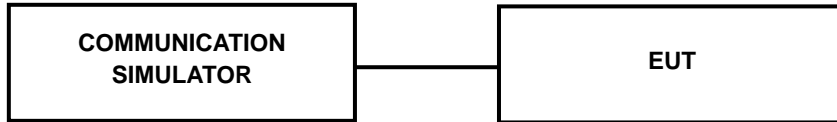

### 3.1.4 TEST RESULTS

**CONDUCTED OUTPUT POWER (dBm)**

Band	GSM850		
Channel	128	190	251
Frequency (MHz)	824.2	836.6	848.8
GPRS (GMSK, 1Tx-slot)	32.29	32.25	32.16
GPRS (GMSK, 2Tx-slot)	32.21	32.19	32.09
GPRS (GMSK, 3Tx-slot)	31.34	30.85	30.84
GPRS (GMSK, 4Tx-slot)	29.64	29.73	29.37
EDGE (8PSK, 1Tx-slot)	26.01	26.21	26.04
EDGE (8PSK, 2Tx-slot)	25.84	26.06	25.89
EDGE (8PSK, 3Tx-slot)	25.64	25.89	25.65
EDGE (8PSK, 4Tx-slot)	25.45	25.78	25.41





**LTE Band 5**

Band/BW	Modulation	RB Size	RB Offset	Low CH 20407	Mid CH 20525	High CH 20643
				Frequency 824.7 MHz	Frequency 836.5 MHz	Frequency 848.3 MHz
5/ 1.4	QPSK	1	0	23.54	23.40	23.70
		1	5	23.52	23.46	23.46
		3	0	23.54	23.41	23.57
		3	3	23.53	23.32	23.52
		6	0	23.57	23.52	23.59
	16QAM	1	0	23.48	23.59	23.61
		1	5	23.55	23.32	23.59
		3	0	23.59	23.46	23.44
		3	3	23.51	23.57	23.59
		5	0	23.54	23.40	23.54

Band/BW	Modulation	RB Size	RB Offset	Low CH 20415	Mid CH 20525	High CH 20635
				Frequency 825.5 MHz	Frequency 836.5 MHz	Frequency 847.5 MHz
5/ 3	QPSK	1	0	23.64	23.50	23.63
		1	5	23.44	23.39	23.47
		3	0	23.49	23.47	23.44
		3	3	23.61	23.42	23.60
		6	0	23.59	23.42	23.45
	16QAM	1	0	23.57	23.50	23.53
		1	5	23.55	23.40	23.48
		3	0	23.51	23.45	23.53
		3	3	23.60	23.60	23.52
		5	0	23.58	23.44	23.58



Band/BW	Modulation	RB Size	RB Offset	Low CH 20425	Mid CH 20525	High CH 20625
				Frequency 826.5 MHz	Frequency 836.5 MHz	Frequency 846.5 MHz
5/ 5	QPSK	1	0	23.67	23.44	23.69
		1	5	23.49	23.44	23.52
		3	0	23.54	23.39	23.46
		3	3	23.58	23.45	23.55
		6	0	23.55	23.55	23.52
	16QAM	1	0	23.52	23.46	23.57
		1	5	23.50	23.30	23.61
		3	0	23.54	23.41	23.48
		3	3	23.59	23.52	23.63
		5	0	23.50	23.53	23.55

Band/BW	Modulation	RB Size	RB Offset	Low CH 20450	Mid CH 20525	High CH 20600
				Frequency 829 MHz	Frequency 836.5 MHz	Frequency 844 MHz
5/ 10	QPSK	1	0	23.68	23.54	23.75
		1	5	23.55	23.49	23.54
		3	0	23.59	23.50	23.59
		3	3	23.62	23.46	23.61
		6	0	23.66	23.57	23.60
	16QAM	1	0	23.63	23.60	23.66
		1	5	23.64	23.42	23.62
		3	0	23.66	23.48	23.59
		3	3	23.64	23.61	23.66
		5	0	23.62	23.55	23.67



**ERP POWER (dBm)**

**GSM**

Channel	Frequency (MHz)	Conducted Power (dBm)	G <sub>T</sub> -L <sub>c</sub> (dB)	ERP (dBm)	ERP (mW)	Limit (W)
128	824.2	32.29	1.7	31.84	1527.57	7
190	836.6	32.25	1.7	31.8	1513.56	7
251	848.8	32.16	1.7	31.71	1482.52	7

**REMARKS:** ERP Output Power (dBm) = EIRP (dBm) -2.15(dB).

**EDGE**

Channel	Frequency (MHz)	Conducted Power (dBm)	G <sub>T</sub> -L <sub>c</sub> (dB)	ERP (dBm)	ERP (mW)	Limit (W)
128	824.2	26.01	1.7	25.56	359.75	7
190	836.6	26.21	1.7	25.76	376.7	7
251	848.8	26.04	1.7	25.59	362.24	7

**REMARKS:** ERP Output Power (dBm) = EIRP (dBm) -2.15(dB).



**LTE BAND 5**

**CHANNEL BANDWIDTH: 1.4MHz QPSK**

Channel	Frequency (MHz)	Conducted Power (dBm)	G <sub>T</sub> -L <sub>C</sub> (dB)	ERP (dBm)	ERP (mW)	Limit (W)
20407	824.7	23.57	1.7	23.12	205.12	7
20525	836.5	23.52	1.7	23.07	202.77	7
20643	848.3	23.7	1.7	23.25	211.35	7

**CHANNEL BANDWIDTH: 1.4MHz 16QAM**

Channel	Frequency (MHz)	Conducted Power (dBm)	G <sub>T</sub> -L <sub>C</sub> (dB)	ERP (dBm)	ERP (mW)	Limit (W)
20407	824.7	23.59	1.7	23.14	206.06	7
20525	836.5	23.59	1.7	23.14	206.06	7
20643	848.3	23.61	1.7	23.16	207.01	7

**CHANNEL BANDWIDTH: 3MHz QPSK**

Channel	Frequency (MHz)	Conducted Power (dBm)	G <sub>T</sub> -L <sub>C</sub> (dB)	ERP (dBm)	ERP (mW)	Limit (W)
20415	825.5	23.64	1.7	23.19	208.45	7
20525	836.5	23.5	1.7	23.05	201.84	7
20635	847.5	23.63	1.7	23.18	207.97	7

**CHANNEL BANDWIDTH: 3MHz 16QAM**

Channel	Frequency (MHz)	Conducted Power (dBm)	G <sub>T</sub> -L <sub>C</sub> (dB)	ERP (dBm)	ERP (mW)	Limit (W)
20415	825.5	23.6	1.7	23.15	206.54	7
20525	836.5	23.6	1.7	23.15	206.54	7
20635	847.5	23.58	1.7	23.13	205.59	7



**CHANNEL BANDWIDTH: 5MHz QPSK**

Channel	Frequency (MHz)	Conducted Power (dBm)	G <sub>T</sub> -L <sub>c</sub> (dB)	ERP (dBm)	ERP (mW)	Limit (W)
20425	826.5	23.67	1.7	23.22	209.89	7
20525	836.5	23.55	1.7	23.1	204.17	7
20625	846.5	23.69	1.7	23.24	210.86	7

**CHANNEL BANDWIDTH: 5MHz 16QAM**

Channel	Frequency (MHz)	Conducted Power (dBm)	G <sub>T</sub> -L <sub>c</sub> (dB)	ERP (dBm)	ERP (mW)	Limit (W)
20425	826.5	23.59	1.7	23.14	206.06	7
20525	836.5	23.53	1.7	23.08	203.24	7
20625	846.5	23.63	1.7	23.18	207.97	7

**CHANNEL BANDWIDTH: 10MHz QPSK**

Channel	Frequency (MHz)	Conducted Power (dBm)	G <sub>T</sub> -L <sub>c</sub> (dB)	ERP (dBm)	ERP (mW)	Limit (W)
20450	829.0	23.68	1.7	23.23	210.38	7
20525	836.5	23.57	1.7	23.12	205.12	7
20600	844.0	23.75	1.7	23.3	213.8	7

**CHANNEL BANDWIDTH: 10MHz 16QAM**

Channel	Frequency (MHz)	Conducted Power (dBm)	G <sub>T</sub> -L <sub>c</sub> (dB)	ERP (dBm)	ERP (mW)	Limit (W)
20450	829.0	23.66	1.7	23.21	209.41	7
20525	836.5	23.61	1.7	23.16	207.01	7
20600	844.0	23.67	1.7	23.22	209.89	7

**REMARKS:** ERP Output Power (dBm) = EIRP (dBm) -2.15(dB).



### 3.2 FREQUENCY STABILITY MEASUREMENT

#### 3.2.1 LIMITS OF FREQUENCY STABILITY MEASUREMENT

1.5 ppm is for base and fixed station. 2.5 ppm is for mobile station.

#### 3.2.2 TEST PROCEDURE

- a. Device is placed at the oven room. The oven room could control the temperatures and humidity. Power warm up is at least 15 min and power applied should perform before recording frequency error.
- b. EUT is connected the external power supply to control the DC input power. The test voltage range is from minimum to maximum working voltage. Each step shall be record the frequency error rate.
- c. The temperature range step is 10 degrees in this test items. All temperature levels shall be hold the  $\pm 0.5^{\circ}\text{C}$  during the measurement testing. The each temperature step shall be at least 0.5 hours, consider the EUT could be test under the stability condition.

NOTE: The frequency error was recorded frequency error from the communication simulator.

#### 3.2.3 TEST SETUP

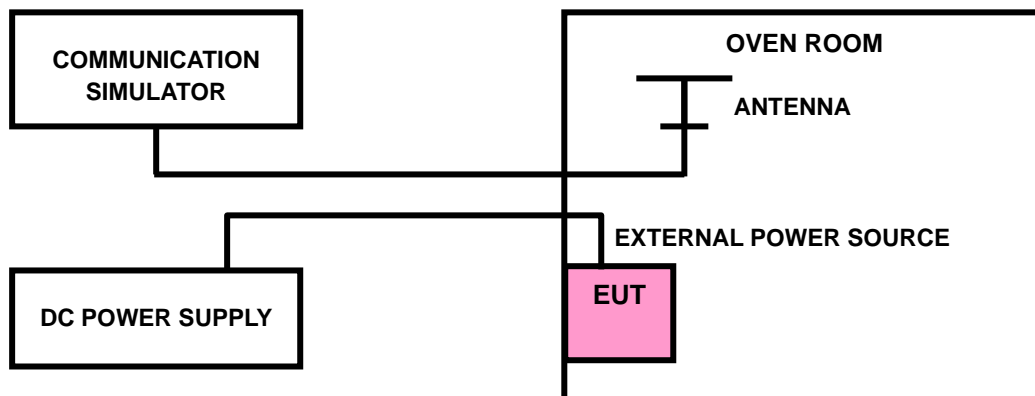



**Test Report No.: W7L-P23100004RF01**

### 3.2.4 TEST RESULTS

Please Refer to Module report R2007A0435-R4.



### 3.3 OCCUPIED BANDWIDTH MEASUREMENT

#### 3.3.1 LIMITS OF OCCUPIED BANDWIDTH MEASUREMENT

The width of a frequency band such that, below the lower and above the upper frequency limits, the mean powers emitted are each equal to a specified percentage 0.5 % of the total mean power of a given emission.

#### 3.3.2 TEST SETUP

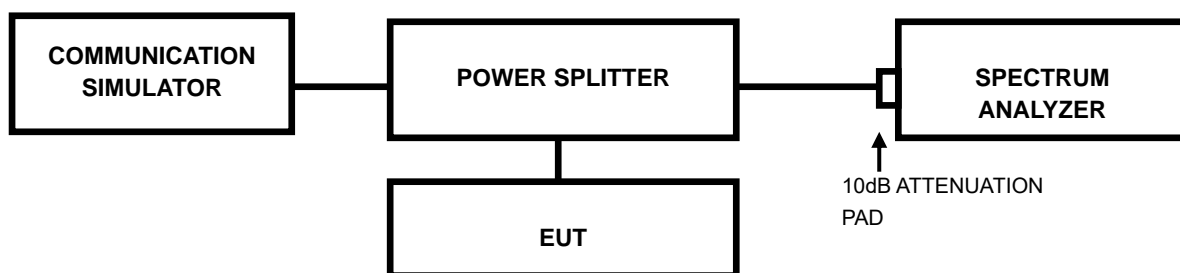

#### 3.3.3 TEST PROCEDURES

- The conducted occupied bandwidth used the power splitter via EUT RF power connector between simulation base station and spectrum analyzer.
- Use OBW measurement function of Spectrum analyzer to measure 99 % occupied bandwidth.





**Test Report No.: W7L-P23100004RF01**

### 3.3.4 TEST RESULTS

Please Refer to Module report R2007A0435-R4.

### 3.4 BAND EDGE MEASUREMENT

#### 3.4.1 LIMITS OF BAND EDGE MEASUREMENT

Power of any emission outside of the authorized operating frequency ranges must be attenuated below the transmitting power (P) by a factor of at least  $43 + 10 \log(P)$  dB. In the 1 MHz bands immediately outside and adjacent to the frequency block a resolution bandwidth of at least one percent of the emission bandwidth of the fundamental emission of the transmitter may be employed.

#### 3.4.2 TEST SETUP

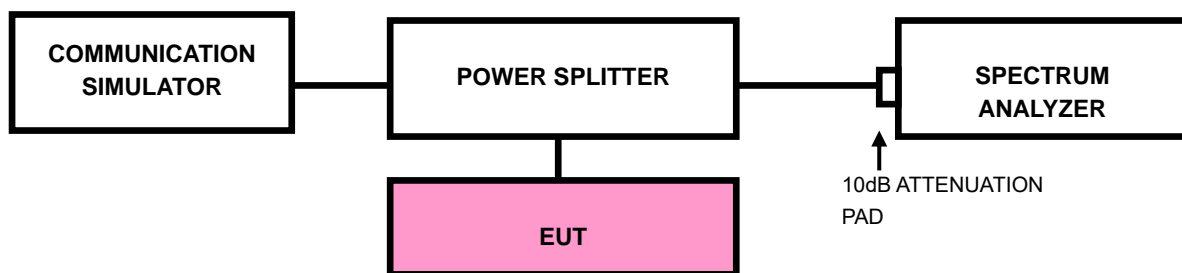



### 3.4.3 TEST PROCEDURES

- a) All measurements were done at low and high operational frequency range
- b) Connect the transmitter to the spectrum analyzer via coaxial cable while ensuring proper impedance matching.
- c) Tune the analyzer to the nominal center frequency of the emission bandwidth (EBW)
- d) .Set the resolution bandwidth (RBW)  $\geq 1\%$  EBW in the 1MHz band immediately outside and adjacent to the band edge.
- e) Beyond the 1MHz band from the band edge, RBW=1MHz was used.
- f) Set the video bandwidth (VBW) to  $\geq 3 \times$  RBW.
- g) Select the average power (RMS) display detector.
- h) Set the number of measurement points to  $\geq 1001$ .
- i) Use auto-coupled sweep time.
- j) Perform the measurement over an interval of time when the transmission is continuous and at its maximum power level.
- k) The RF fundamental frequency should be excluded against the limit line in the operating frequency band and use RBW is 10KHz or 100KHz.
- l) Record the max trace plot into the test report.



**BUREAU  
VERITAS**

**Test Report No.: W7L-P23100004RF01**

### 3.4.4 TEST RESULTS

Please Refer to Module report R2007A0435-R4.

### 3.5 CONDUCTED SPURIOUS EMISSIONS

#### 3.5.1 LIMITS OF CONDUCTED SPURIOUS EMISSIONS MEASUREMENT

The power of any emission outside of the authorized operating frequency ranges must be attenuated below the transmitting power (P) by a factor of at least  $43 + 10 \log(P)$  dB. The emission limit equal to  $-13\text{dBm}$ .

#### 3.5.2 TEST PROCEDURE

- a. The EUT makes a phone call to the communication simulator. All measurements were done at low, middle and high operational frequency range.
- b. Measuring frequency range is from 9kHz up to a frequency including its 10<sup>th</sup> harmonic. 10dB attenuation pad is connected with spectrum. RBW=1MHz and VBW=3MHz is used for conducted emission measurement.

#### 3.5.3 TEST SETUP

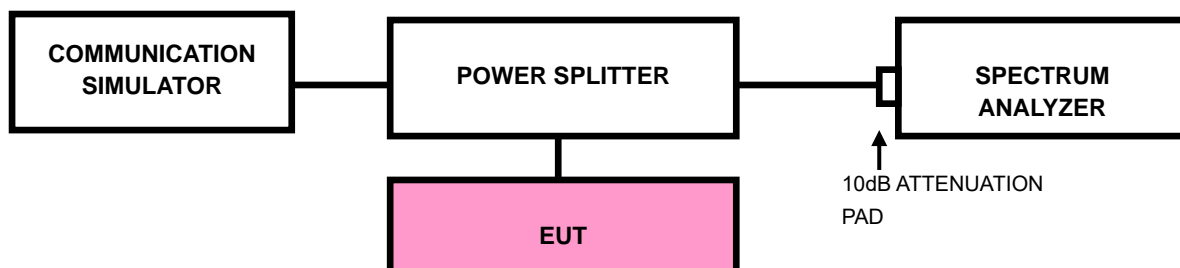



**BUREAU  
VERITAS**

**Test Report No.: W7L-P23100004RF01**

### 3.5.4 TEST RESULTS

NOTE : The 9K~30MHz amplitude of spurious emissions attenuated more than 20 dB below the permissible value is not required in the report.

Please Refer to Module report R2007A0435-R4.



### 3.6 RADIATED EMISSION MEASUREMENT

#### 3.6.1 LIMITS OF RADIATED EMISSION MEASUREMENT

The power of any emission outside of the authorized operating frequency ranges must be attenuated below the transmitting power (P) by a factor of at least  $43 + 10 \log(P)$  dB. The emission limit equal to  $-13\text{dBm}$ .

#### 3.6.2 TEST PROCEDURES

- a. Substitution method is used for E.I.R.P measurement. In the semi-anechoic chamber, EUT placed on the 0.8m height of Turn Table, rotated the table around 360 degrees to search the maximum radiation power and receiver antenna shall be rotated vertical and horizontal polarization and moved height from 1m to 4m to find the maximum polar radiated power. The "Read Value" is the spectrum reading the maximum power value.
- b. The substitution horn antenna is substituted for EUT at the same position and signals generator export the CW signal to the substitution antenna via a TX cable. Rotated the Turn Table and moved receiving antenna to find the maximum radiation power. Adjust output power level of S.G to get a Value of spectrum reading equal to "Read Value " of step a. Record the power level of S.G
- c.  $\text{EIRP} = \text{Output power level of S.G} - \text{TX cable loss} + \text{Antenna gain of substitution horn.}$
- d. E.R.P power can be calculated form E.I.R.P power by subtracting the gain of dipole,  
 $\text{E.R.P power} = \text{E.I.P.R power} - 2.15\text{dBi.}$

**NOTE:** The resolution bandwidth and video bandwidth of test receiver/spectrum analyzer is 1MHz/3MHz.

#### 3.6.3 DEVIATION FROM TEST STANDARD

No deviation



### 3.6.4 TEST SETUP

#### < Frequency Range below 30MHz >

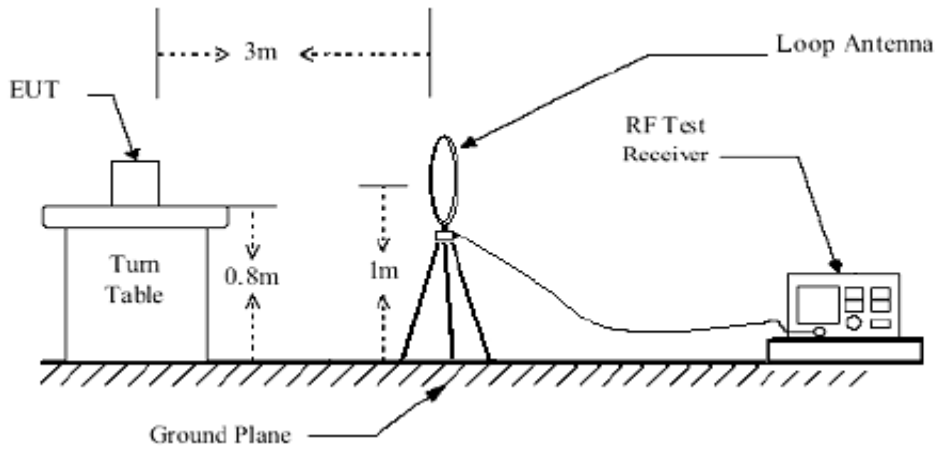

#### < Frequency Range 30MHz~1GHz >

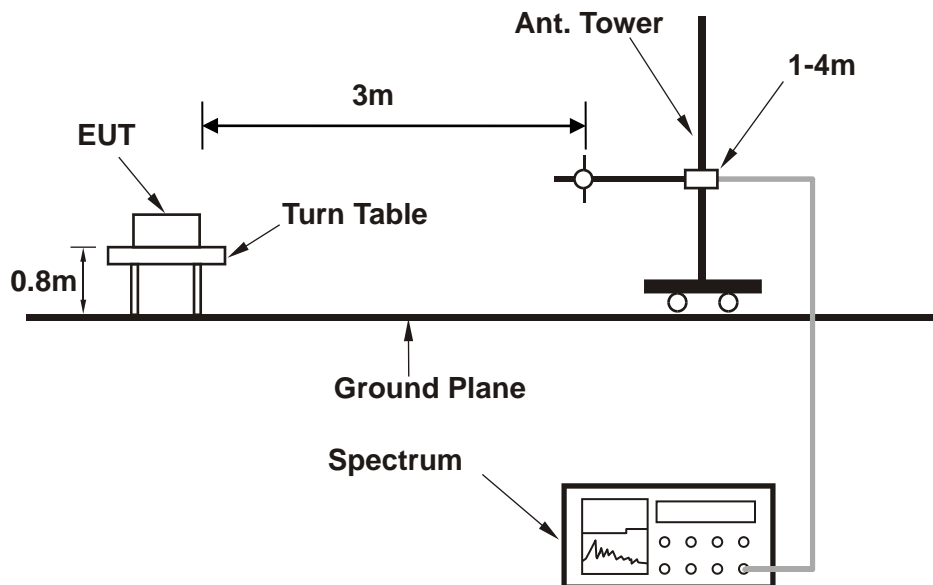





<Frequency Range above 1GHz>

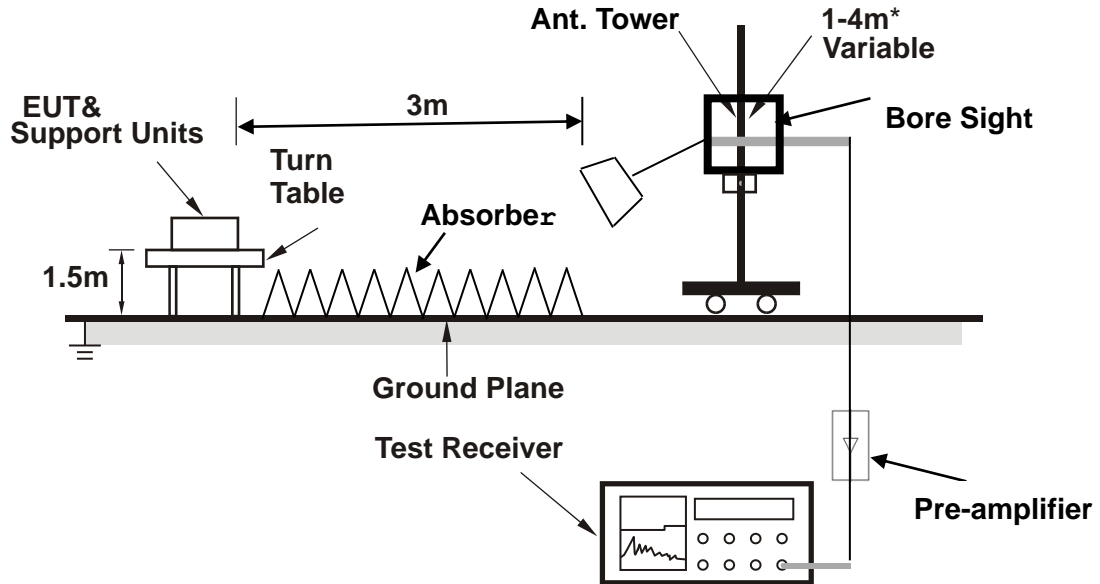

**Note:** Above 1G is a directional antenna

Depends on the EUT height and the antenna 3dB beamwidth both, refer to section 7.3 of CISPR 16-2-3.

For the actual test configuration, please refer to the attached file (Test Setup Photo).



### 3.6.5 TEST RESULTS

NOTE : The 9K~30MHz amplitude of spurious emissions attenuated more than 20 dB below the permissible value is not required in the report.

#### BELOW 1GHz WORST-CASE DATA

30 MHz – 1GHz data:

EDGE 850:

CHANNEL BANDWIDTH: 128 ~ 251

<b>MODE</b>	TX channel 190	<b>FREQUENCY RANGE</b>	Below 1000MHz
<b>ENVIRONMENTAL CONDITIONS</b>	23deg. C, 70%RH	<b>INPUT POWER</b>	AC 120V/60HZ
<b>TESTED BY</b>	Jace Hu		
<b>ANTENNA POLARITY &amp; TEST DISTANCE: HORIZONTAL AT 3 M</b>			

No.	Frequency MHz	Factor dB	Reading dBm	Emission dBm	Limit dBm	Margin dB	Tower / Table cm deg	
1	31.55	-0.58	-66.03	-66.61	-13.00	-53.61	100	0
2	62.64	-12.61	-52.01	-64.62	-13.00	-51.62	100	0
*	90.62	-12.50	-51.34	-63.84	-13.00	-50.84	100	0
4	174.57	-8.64	-55.93	-64.57	-13.00	-51.57	100	0
5	239.86	-8.04	-62.67	-70.71	-13.00	-57.71	100	0
6	370.43	-4.97	-62.68	-67.65	-13.00	-54.65	100	0

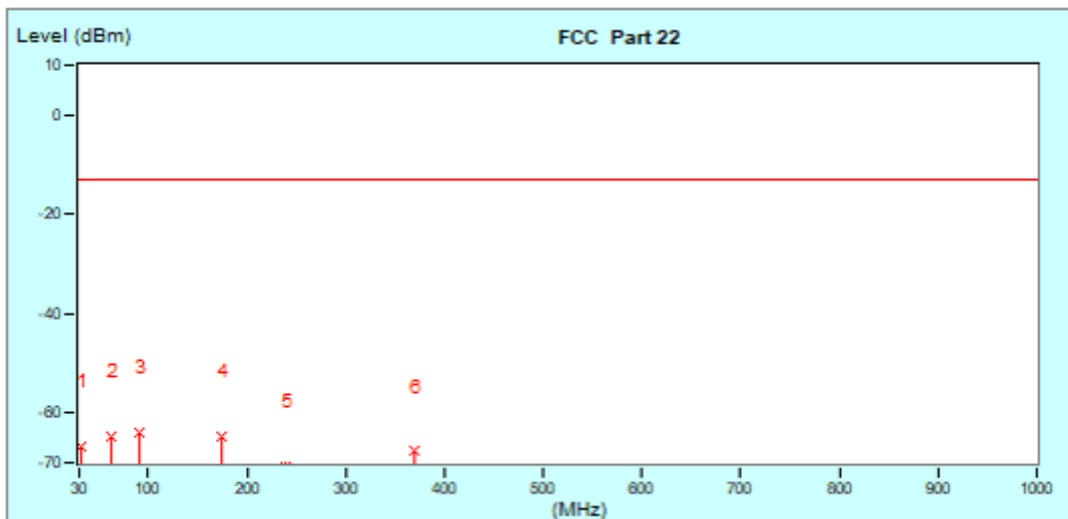



**BUREAU  
VERITAS**

**Test Report No.: W7L-P23100004RF01**

<b>MODE</b>	TX channel 190	<b>FREQUENCY RANGE</b>	Below 1000MHz
<b>ENVIRONMENTAL CONDITIONS</b>	23deg. C, 70%RH	<b>INPUT POWER</b>	AC 120V/60HZ
<b>TESTED BY</b>	Jace Hu		
<b>ANTENNA POLARITY &amp; TEST DISTANCE: VERTICAL AT 3 M</b>			

No.	Frequency MHz	Factor dB	Reading dBm	Emission dBm	Limit dBm	Margin dB	Tower / Table cm deg
1	30.00	0.60	-43.83	-43.23	-13.00	-30.23	100 0
2	43.99	-9.18	-40.34	-49.52	-13.00	-36.52	100 0
3	101.51	-9.78	-40.84	-50.62	-13.00	-37.62	100 0
4	115.50	-7.14	-43.27	-50.41	-13.00	-37.41	100 0
5	182.13	-8.14	-53.41	-61.55	-13.00	-48.55	100 0
6	216.54	-7.52	-51.20	-58.72	-13.00	-45.72	100 0

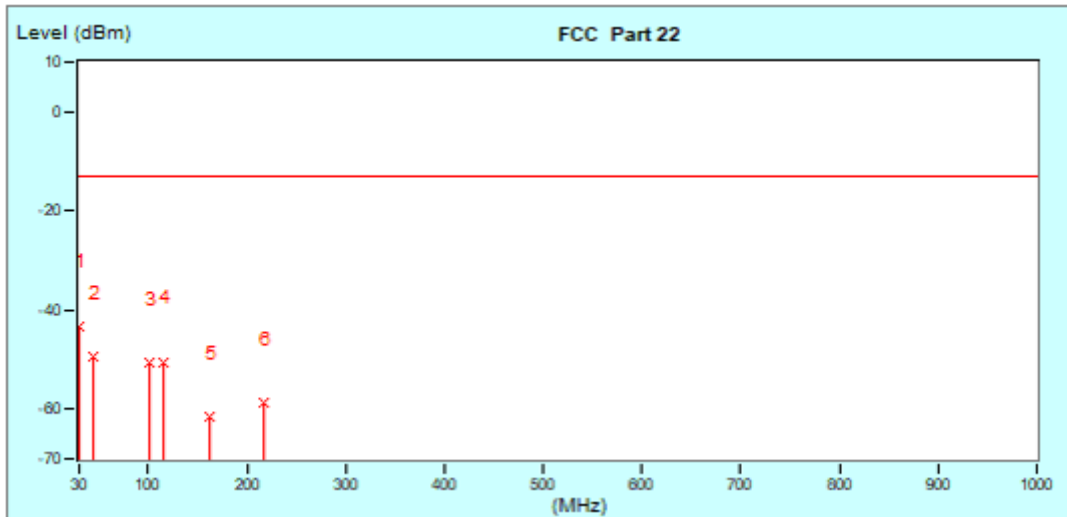



ABOVE 1GHz DATA

Note: For higher frequency, the emission is too low to be detected.

GSM 850

CH 128:

MODE	TX channel 128	FREQUENCY RANGE	Above 1000MHz
ENVIRONMENTAL CONDITIONS	23deg. C, 70%RH	INPUT POWER	AC 120V/60HZ
TESTED BY	Jace Hu		
<b>ANTENNA POLARITY &amp; TEST DISTANCE: HORIZONTAL AT 3 M</b>			

No.	Frequency MHz	Factor dB	Reading dBm	Emission dBm	Limit dBm	Margin dB	Tower / Table cm deg	
1	1648.40 (PK)	-13.06	-23.04	-36.10	-13.00	-23.10	100	0
2	2472.60 (PK)	-10.82	-36.29	-47.11	-13.00	-34.11	100	0

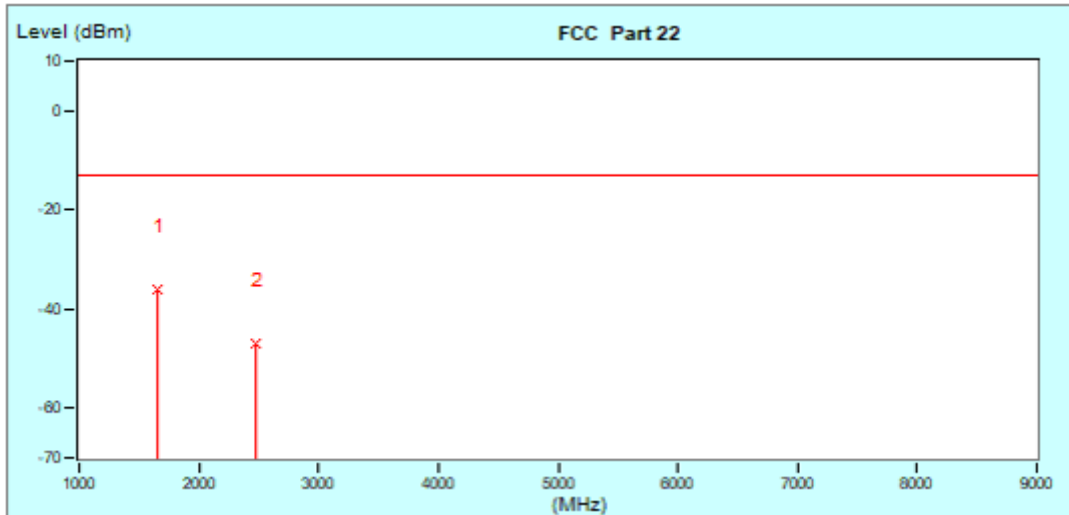



<b>MODE</b>	TX channel 128	<b>FREQUENCY RANGE</b>	Above 1000MHz
<b>ENVIRONMENTAL CONDITIONS</b>	23deg. C, 70%RH	<b>INPUT POWER</b>	AC 120V/60HZ
<b>TESTED BY</b>	Jace Hu		
<b>ANTENNA POLARITY &amp; TEST DISTANCE: VERTICAL AT 3 M</b>			

No.	Frequency MHz	Factor dB	Reading dBm	Emission dBm	Limit dBm	Margin dB	Tower / Table cm deg	
1	1648.40 (PK)	-13.06	-23.35	-36.41	-13.00	-23.41	100	0
2	2472.60 (PK)	-10.82	-35.72	-46.54	-13.00	-33.54	100	0

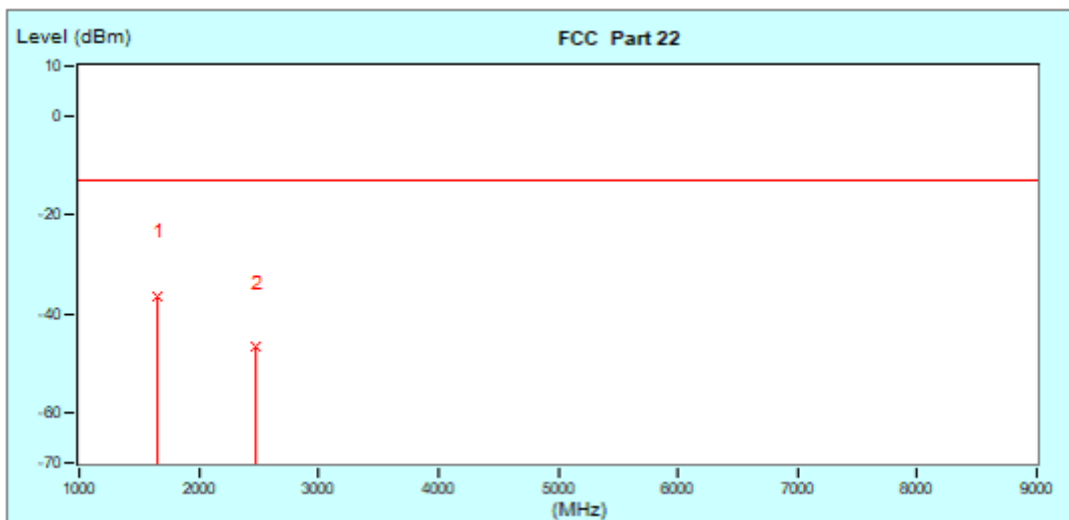



BUREAU VERITAS

Test Report No.: W7L-P23100004RF01

CH 190:

<b>MODE</b>	TX channel 190	<b>FREQUENCY RANGE</b>	Above 1000MHz
<b>ENVIRONMENTAL CONDITIONS</b>	23deg. C, 70%RH	<b>INPUT POWER</b>	AC 120V/60HZ
<b>TESTED BY</b>	Jace Hu		
<b>ANTENNA POLARITY &amp; TEST DISTANCE: HORIZONTAL AT 3 M</b>			

No.	Frequency MHz	Factor dB	Reading dBm	Emission dBm	Limit dBm	Margin dB	Tower / Table cm deg	
1	1672.80 (PK)	-12.76	-24.68	-37.44	-13.00	-24.44	100	0
2	2509.20 (PK)	-10.94	-37.85	-48.79	-13.00	-35.79	100	0

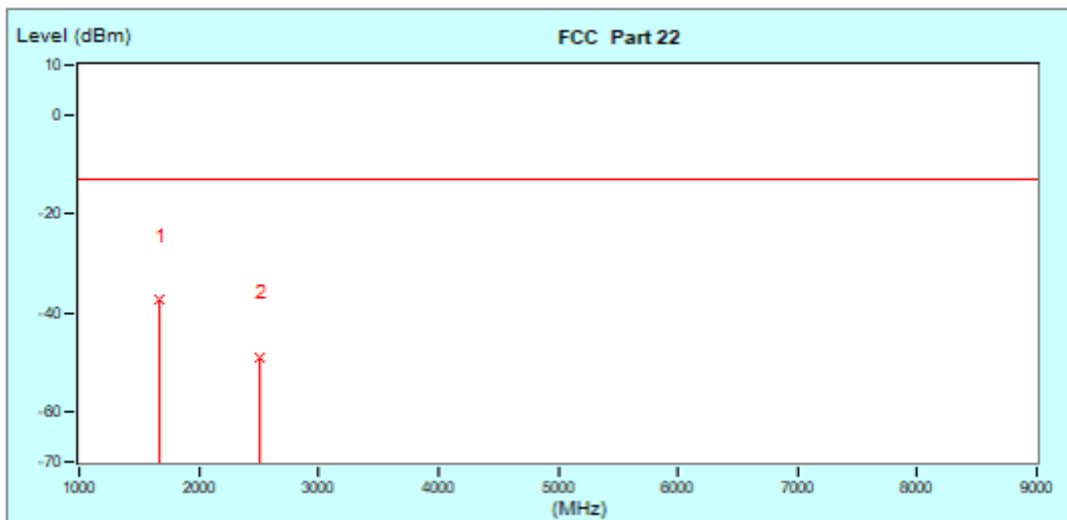



<b>MODE</b>	TX channel 190	<b>FREQUENCY RANGE</b>	Above 1000MHz
<b>ENVIRONMENTAL CONDITIONS</b>	23deg. C, 70%RH	<b>INPUT POWER</b>	AC 120V/60HZ
<b>TESTED BY</b>	Jace Hu		
<b>ANTENNA POLARITY &amp; TEST DISTANCE: VERTICAL AT 3 M</b>			

No.	Frequency MHz	Factor dB	Reading dBm	Emission dBm	Limit dBm	Margin dB	Tower / Table cm deg	
1	1872.80 (PK)	-12.76	-16.02	-28.78	-13.00	-15.78	100	0
2	2509.50 (PK)	-10.93	-27.66	-38.59	-13.00	-25.59	100	0

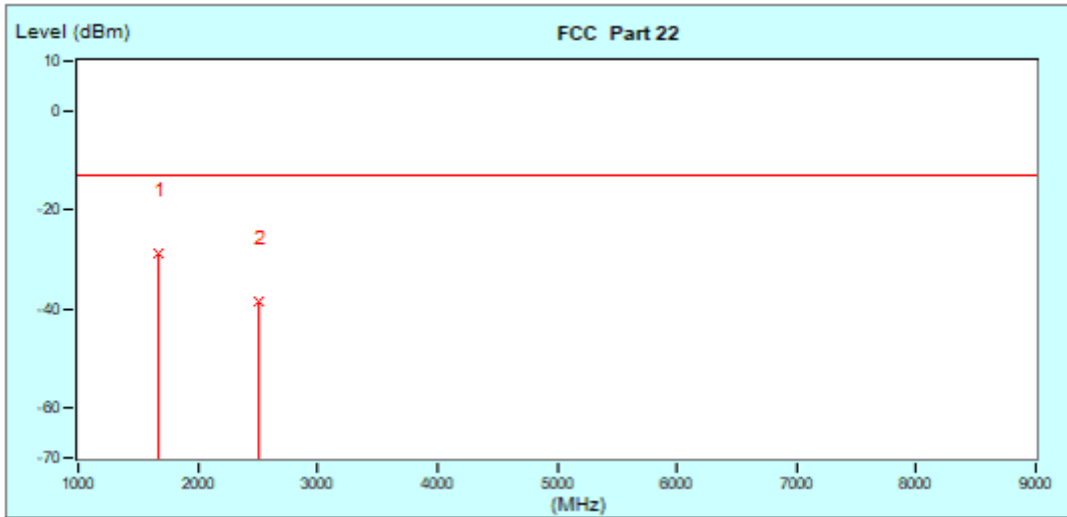



BUREAU VERITAS

Test Report No.: W7L-P23100004RF01

CH 251:

<b>MODE</b>	TX channel 251	<b>FREQUENCY RANGE</b>	Above 1000MHz
<b>ENVIRONMENTAL CONDITIONS</b>	23deg. C, 70%RH	<b>INPUT POWER</b>	AC 120V/60HZ
<b>TESTED BY</b>	Jace Hu		
<b>ANTENNA POLARITY &amp; TEST DISTANCE: HORIZONTAL AT 3 M</b>			

No.	Frequency MHz	Factor dB	Reading dBm	Emission dBm	Limit dBm	Margin dB	Tower / Table cm deg	
1	1697.60 (PK)	-12.46	-28.66	-41.12	-13.00	-28.12	100	0
2	2546.40 (PK)	-10.94	-37.98	-48.92	-13.00	-35.92	100	0

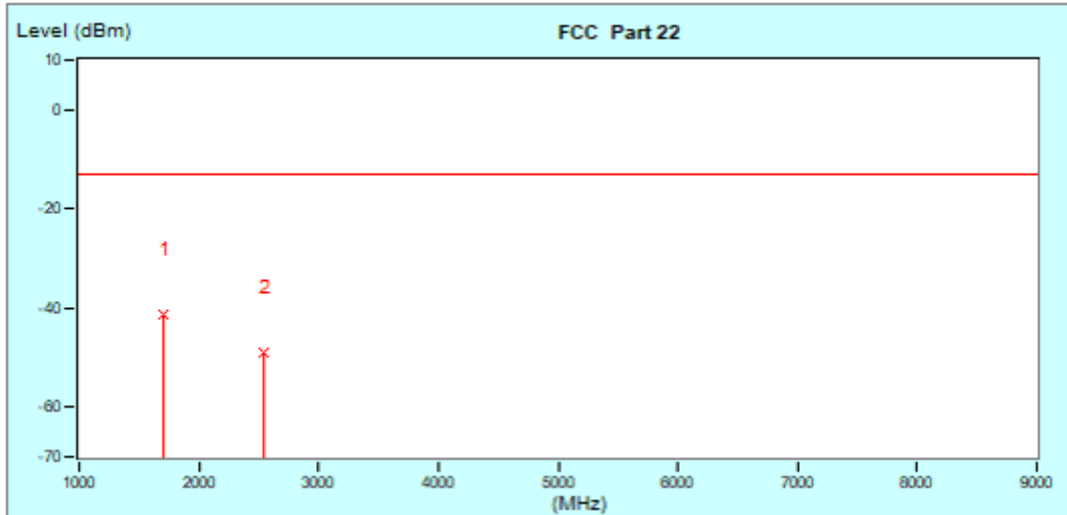





<b>MODE</b>	TX channel 251	<b>FREQUENCY RANGE</b>	Above 1000MHz
<b>ENVIRONMENTAL CONDITIONS</b>	23deg. C, 70%RH	<b>INPUT POWER</b>	AC 120V/60HZ
<b>TESTED BY</b>	Jace Hu		
<b>ANTENNA POLARITY &amp; TEST DISTANCE: VERTICAL AT 3 M</b>			

No.	Frequency MHz	Factor dB	Reading dBm	Emission dBm	Limit dBm	Margin dB	Tower / Table cm deg	
* 1	1697.60 (PK)	-12.46	-27.25	-39.71	-13.00	-26.71	100	0
2	2546.40 (PK)	-10.94	-40.82	-51.76	-13.00	-38.76	100	0

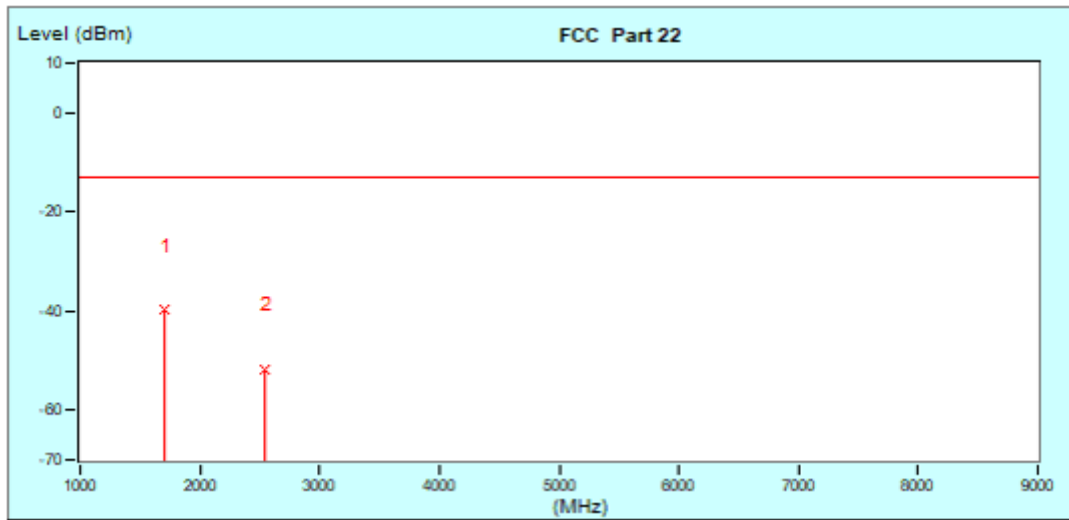



BUREAU VERITAS

Test Report No.: W7L-P23100004RF01

EDGE 850:

CH 128:

<b>MODE</b>	TX channel 128	<b>FREQUENCY RANGE</b>	Above 1000MHz
<b>ENVIRONMENTAL CONDITIONS</b>	23deg. C, 70%RH	<b>INPUT POWER</b>	AC 120V/60HZ
<b>TESTED BY</b>	Jace Hu		
<b>ANTENNA POLARITY &amp; TEST DISTANCE: HORIZONTAL AT 3 M</b>			

No.	Frequency MHz	Factor dB	Reading dBm	Emission dBm	Limit dBm	Margin dB	Tower / Table cm deg	
1	1648.40 (PK)	-13.06	-14.15	-27.21	-13.00	-14.21	100	0
2	2472.60 (PK)	-10.82	-29.05	-39.87	-13.00	-26.87	100	0

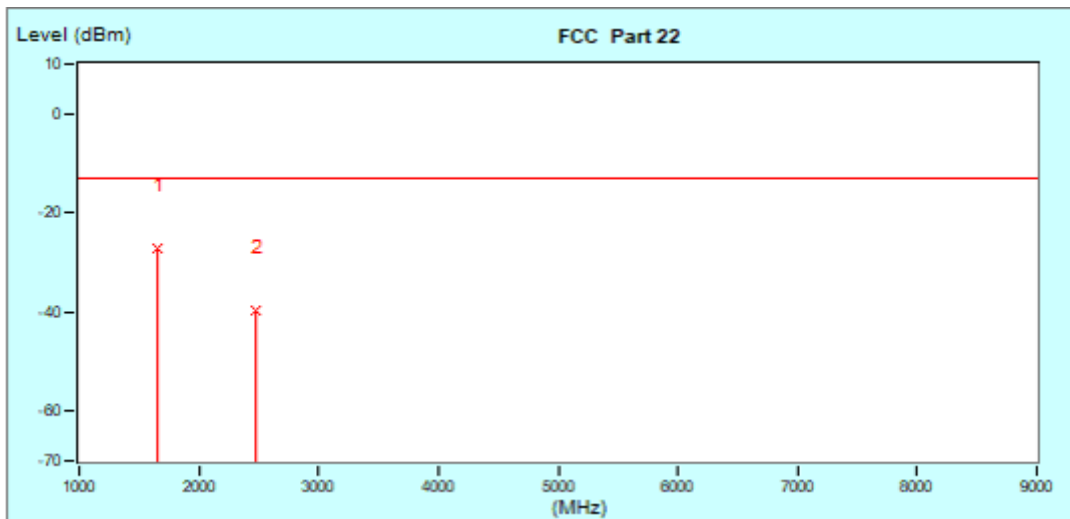



<b>MODE</b>	TX channel 128	<b>FREQUENCY RANGE</b>	Above 1000MHz
<b>ENVIRONMENTAL CONDITIONS</b>	23deg. C, 70%RH	<b>INPUT POWER</b>	AC 120V/60HZ
<b>TESTED BY</b>	Jace Hu		
<b>ANTENNA POLARITY &amp; TEST DISTANCE: VERTICAL AT 3 M</b>			

No.	Frequency MHz	Factor dB	Reading dBm	Emission dBm	Limit dBm	Margin dB	Tower / Table cm deg	
1	1648.40 (PK)	-13.06	-17.36	-30.42	-13.00	-17.42	100	0
2	2472.60 (PK)	-10.82	-28.46	-39.28	-13.00	-26.28	100	0

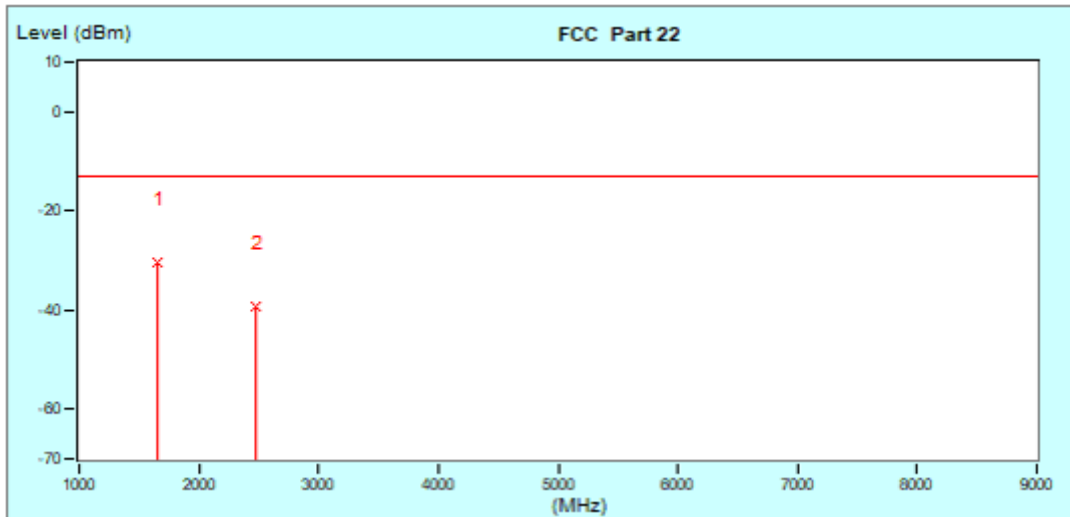



**BUREAU  
VERITAS**

**Test Report No.: W7L-P23100004RF01**

**CH 190:**

<b>MODE</b>	TX channel 190	<b>FREQUENCY RANGE</b>	Above 1000MHz
<b>ENVIRONMENTAL CONDITIONS</b>	23deg. C, 70%RH	<b>INPUT POWER</b>	AC 120V/60HZ
<b>TESTED BY</b>	Jace Hu		
<b>ANTENNA POLARITY &amp; TEST DISTANCE: HORIZONTAL AT 3 M</b>			

No.	Frequency MHz	Factor dB	Reading dBm	Emission dBm	Limit dBm	Margin dB	Tower / Table cm deg
1	1672.80 (PK)	-12.76	-12.83	-25.59	-13.00	-12.59	100 0
2	2509.20 (PK)	-10.94	-23.69	-34.63	-13.00	-21.63	100 0

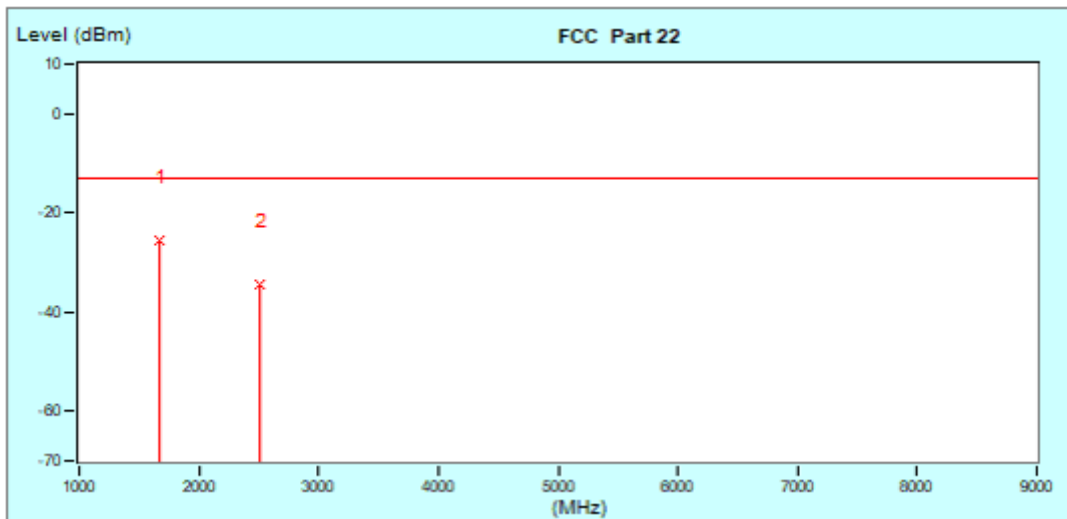



**BUREAU  
VERITAS**

**Test Report No.: W7L-P23100004RF01**

<b>MODE</b>	TX channel 190	<b>FREQUENCY RANGE</b>	Above 1000MHz
<b>ENVIRONMENTAL CONDITIONS</b>	23deg. C, 70%RH	<b>INPUT POWER</b>	AC 120V/60HZ
<b>TESTED BY</b>	Jace Hu		
<b>ANTENNA POLARITY &amp; TEST DISTANCE: VERTICAL AT 3 M</b>			

No.	Frequency MHz	Factor dB	Reading dBm	Emission dBm	Limit dBm	Margin dB	Tower / Table cm deg	
1	1672.80 (PK)	-12.76	-16.30	-29.06	-13.00	-16.06	100	0
2	2509.20 (PK)	-10.94	-27.46	-38.40	-13.00	-25.40	100	0

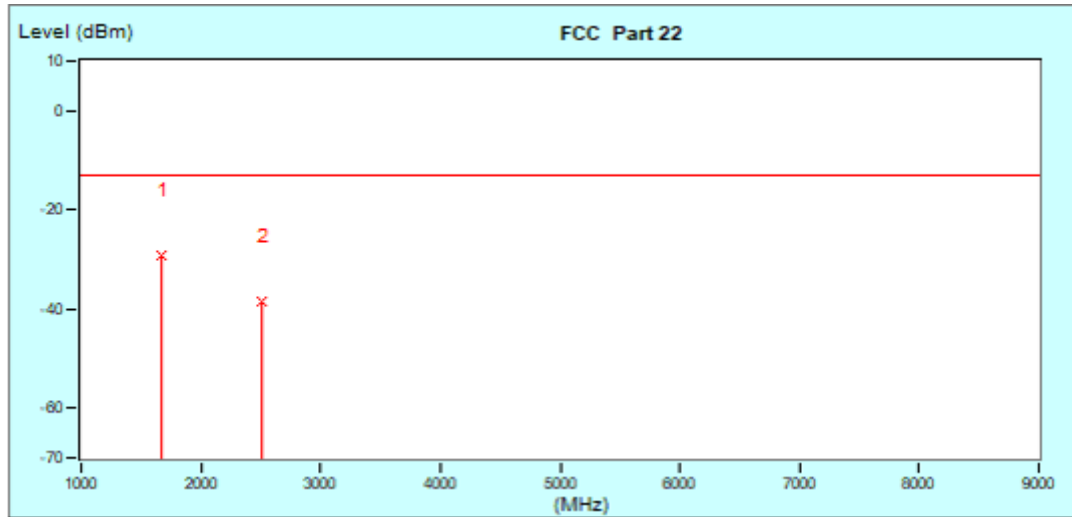



BUREAU VERITAS

Test Report No.: W7L-P23100004RF01

CH 251:

<b>MODE</b>	TX channel 251	<b>FREQUENCY RANGE</b>	Above 1000MHz
<b>ENVIRONMENTAL CONDITIONS</b>	23deg. C, 70%RH	<b>INPUT POWER</b>	AC 120V/60HZ
<b>TESTED BY</b>	Jace Hu		
<b>ANTENNA POLARITY &amp; TEST DISTANCE: HORIZONTAL AT 3 M</b>			

No.	Frequency MHz	Factor dB	Reading dBm	Emission dBm	Limit dBm	Margin dB	Tower / Table cm deg	
* 1	1697.60 (PK)	-12.48	-13.95	-26.41	-13.00	-13.41	100	0
2	2546.40 (PK)	-10.94	-21.69	-32.63	-13.00	-19.63	100	0

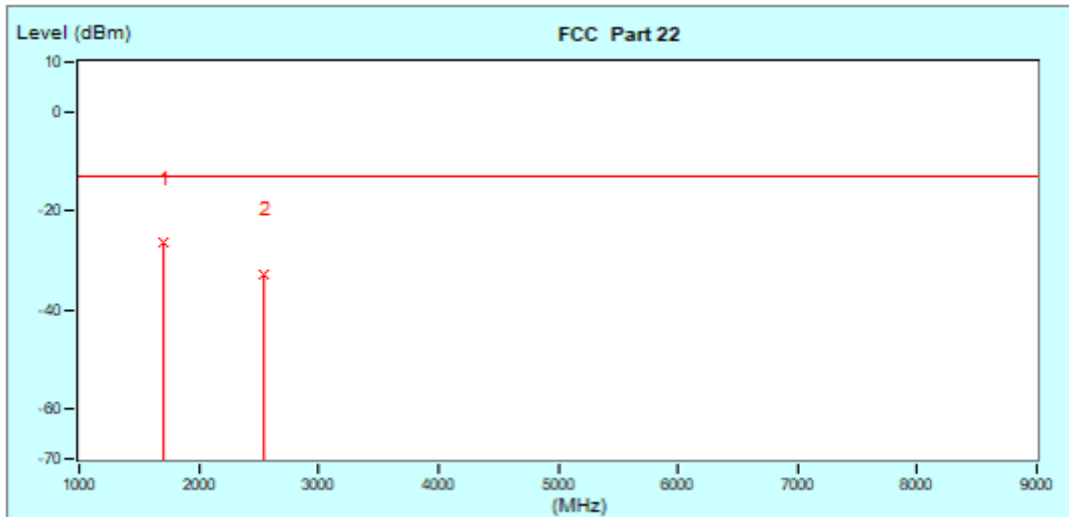



<b>MODE</b>	TX channel 251	<b>FREQUENCY RANGE</b>	Above 1000MHz
<b>ENVIRONMENTAL CONDITIONS</b>	23deg. C, 70%RH	<b>INPUT POWER</b>	AC 120V/60HZ
<b>TESTED BY</b>	Jace Hu		
<b>ANTENNA POLARITY &amp; TEST DISTANCE: VERTICAL AT 3 M</b>			

No.	Frequency MHz	Factor dB	Reading dBm	Emission dBm	Limit dBm	Margin dB	Tower / Table cm deg	
- 1	1697.60 (PK)	-12.46	-16.82	-29.28	-13.00	-16.28	100	0
- 2	2546.40 (PK)	-10.94	-24.78	-35.72	-13.00	-22.72	100	0

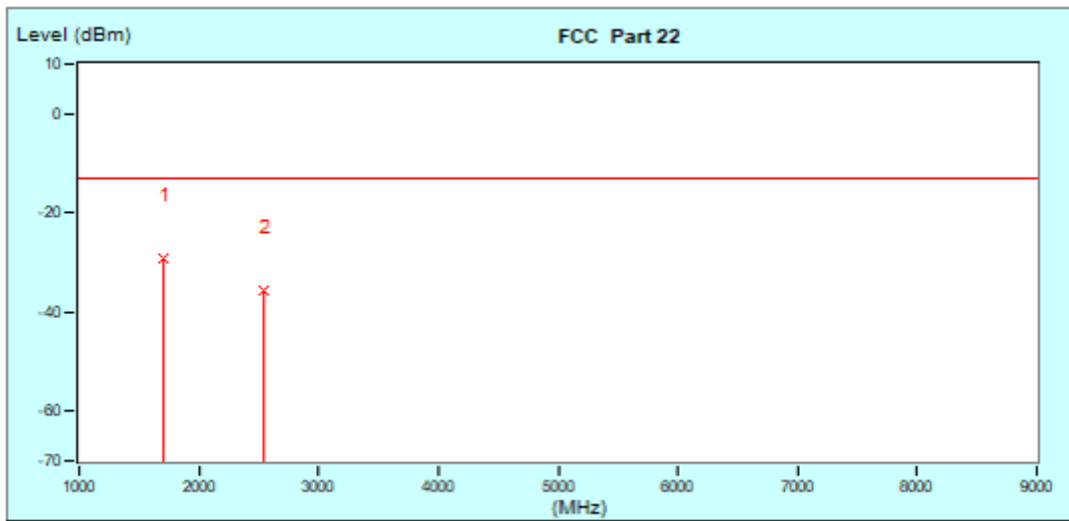



LTE Band 5

CHANNEL BANDWIDTH: 1.4MHz / QPSK

MODE	TX channel 20525	FREQUENCY RANGE	Above 1000MHz
ENVIRONMENTAL CONDITIONS	23deg. C, 70%RH	INPUT POWER	AC 120V/60HZ
TESTED BY	Jace Hu		
<b>ANTENNA POLARITY &amp; TEST DISTANCE: HORIZONTAL AT 3 M</b>			

No.	Frequency MHz	Factor dB	Reading dBm	Emission dBm	Limit dBm	Margin dB	Tower / Table cm deg	
1	1673.00 (PK)	-12.76	-29.18	-41.94	-13.00	-28.94	100	0
2	2509.50 (PK)	-10.93	-39.51	-50.44	-13.00	-37.44	100	0

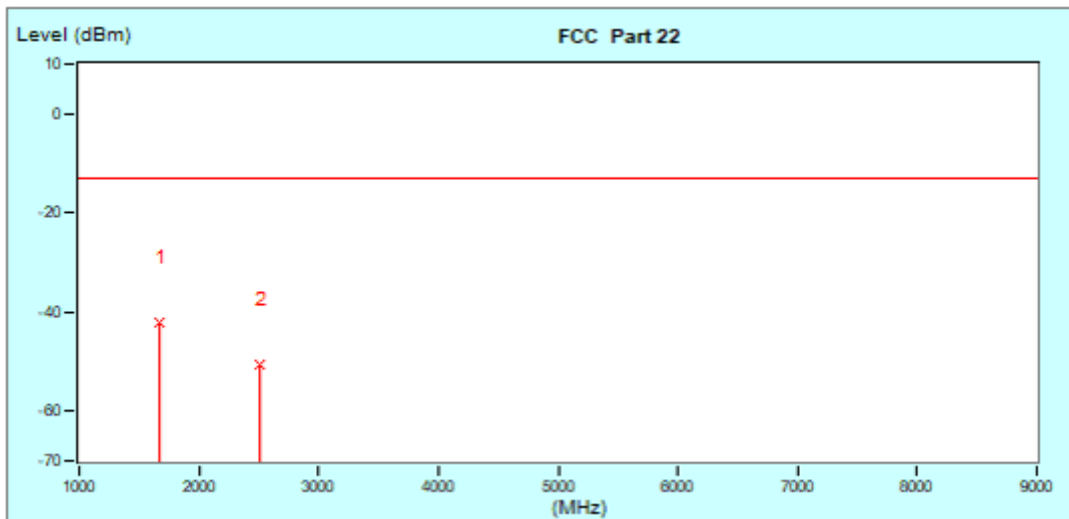





**BUREAU  
VERITAS**

**Test Report No.: W7L-P23100004RF01**

<b>MODE</b>	TX channel 20525	<b>FREQUENCY RANGE</b>	Above 1000MHz
<b>ENVIRONMENTAL CONDITIONS</b>	23deg. C, 70%RH	<b>INPUT POWER</b>	AC 120V/60HZ
<b>TESTED BY</b>	Jace Hu		
<b>ANTENNA POLARITY &amp; TEST DISTANCE: VERTICAL AT 3 M</b>			

No.	Frequency MHz	Factor dB	Reading dBm	Emission dBm	Limit dBm	Margin dB	Tower / Table cm deg
* 1	1673.00 (PK)	-12.76	-25.99	-38.75	-13.00	-25.75	100 0
2	2509.50 (PK)	-10.93	-42.13	-53.06	-13.00	-40.06	100 0

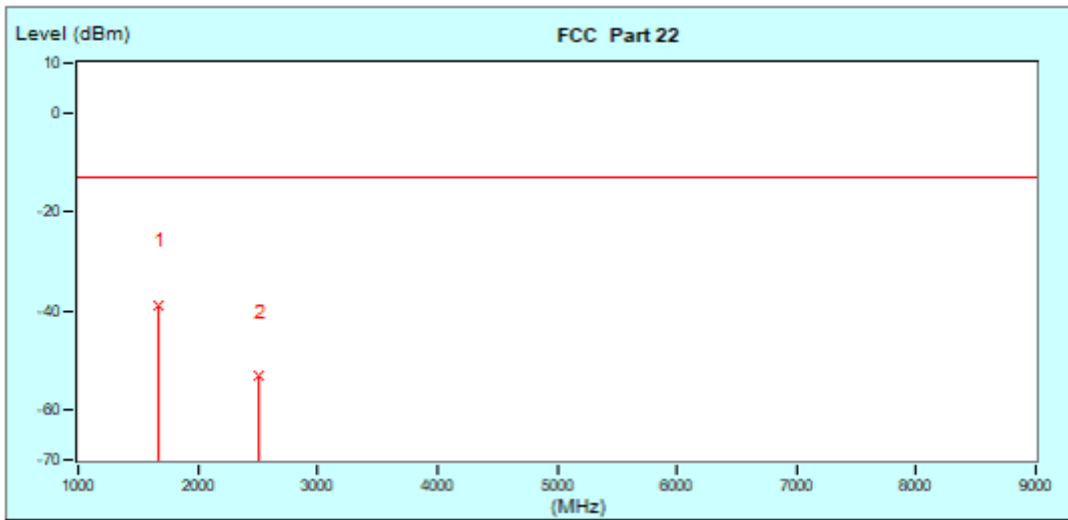



CHANNEL BANDWIDTH: 3MHz / QPSK

CH20415

MODE	TX channel 20415	FREQUENCY RANGE	Above 1000MHz
ENVIRONMENTAL CONDITIONS	23deg. C, 70%RH	INPUT POWER	AC 120V/60HZ
TESTED BY	Jace Hu		
<b>ANTENNA POLARITY &amp; TEST DISTANCE: HORIZONTAL AT 3 M</b>			

No.	Frequency MHz	Factor dB	Reading dBm	Emission dBm	Limit dBm	Margin dB	Tower / Table cm deg	
1	1851.00 (PK)	-13.02	-29.81	-42.83	-13.00	-29.83	100	0
2	2476.50 (PK)	-10.84	-38.94	-49.78	-13.00	-36.78	100	0

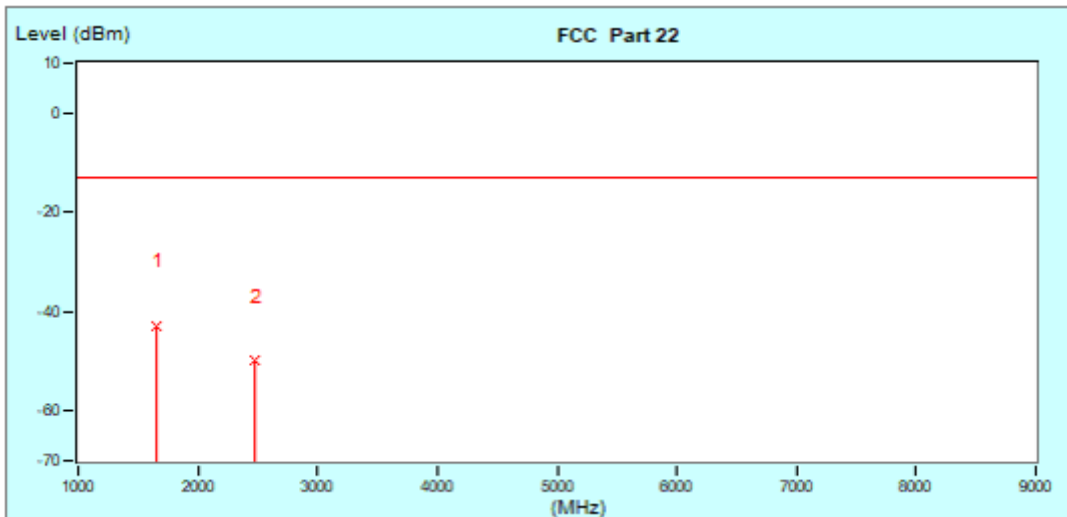



**BUREAU  
VERITAS**

**Test Report No.: W7L-P23100004RF01**

<b>MODE</b>	TX channel 20415	<b>FREQUENCY RANGE</b>	Above 1000MHz
<b>ENVIRONMENTAL CONDITIONS</b>	23deg. C, 70%RH	<b>INPUT POWER</b>	AC 120V/60HZ
<b>TESTED BY</b>	Jace Hu		
<b>ANTENNA POLARITY &amp; TEST DISTANCE: VERTICAL AT 3 M</b>			

No.	Frequency MHz	Factor dB	Reading dBm	Emission dBm	Limit dBm	Margin dB	Tower / Table cm deg	
- 1	1651.00 (PK)	-13.02	-25.76	-38.78	-13.00	-25.78	100	0
- 2	2476.50 (PK)	-10.84	-39.50	-50.34	-13.00	-37.34	100	0

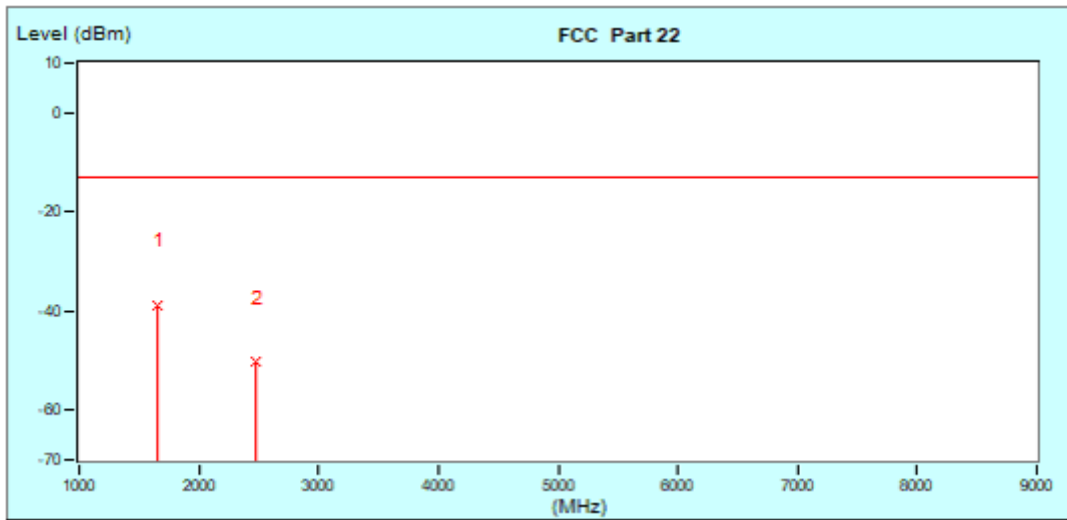



CH20525

<b>MODE</b>	TX channel 20525	<b>FREQUENCY RANGE</b>	Above 1000MHz
<b>ENVIRONMENTAL CONDITIONS</b>	23deg. C, 70%RH	<b>INPUT POWER</b>	AC 120V/60HZ
<b>TESTED BY</b>	Jace Hu		
<b>ANTENNA POLARITY &amp; TEST DISTANCE: HORIZONTAL AT 3 M</b>			

No.	Frequency MHz	Factor dB	Reading dBm	Emission dBm	Limit dBm	Margin dB	Tower / Table cm deg	
1	1673.00 (PK)	-12.76	-30.74	-43.50	-13.00	-30.50	100	0
2	2509.50 (PK)	-10.93	-40.93	-51.86	-13.00	-38.86	100	0

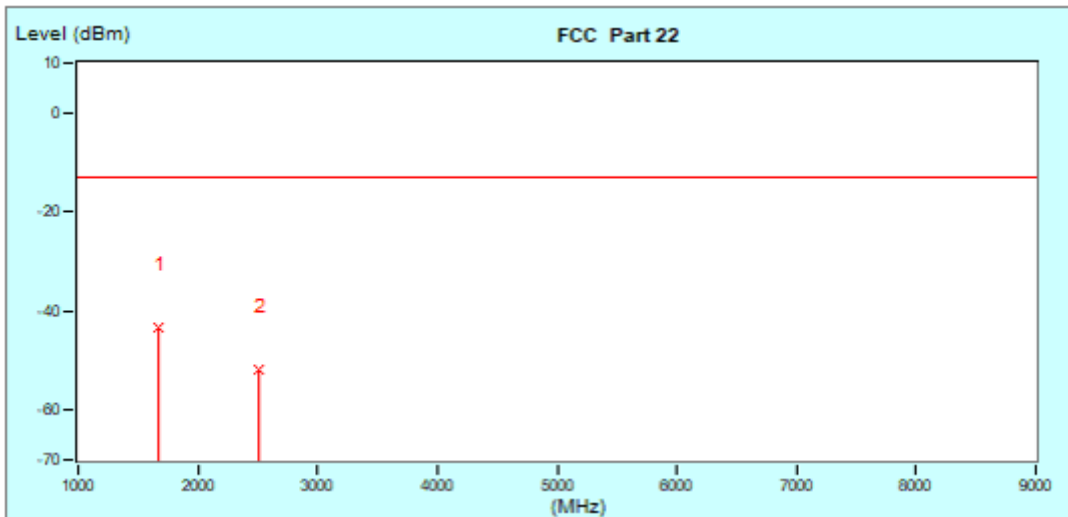



**BUREAU  
VERITAS**

**Test Report No.: W7L-P23100004RF01**

<b>MODE</b>	TX channel 20525	<b>FREQUENCY RANGE</b>	Above 1000MHz
<b>ENVIRONMENTAL CONDITIONS</b>	23deg. C, 70%RH	<b>INPUT POWER</b>	AC 120V/60HZ
<b>TESTED BY</b>	Jace Hu		
<b>ANTENNA POLARITY &amp; TEST DISTANCE: VERTICAL AT 3 M</b>			

No.	Frequency MHz	Factor dB	Reading dBm	Emission dBm	Limit dBm	Margin dB	Tower / Table cm deg
- 1	1673.00 (PK)	-12.76	-24.90	-37.66	-13.00	-24.66	100 0
- 2	2509.50 (PK)	-10.93	-42.11	-53.04	-13.00	-40.04	100 0

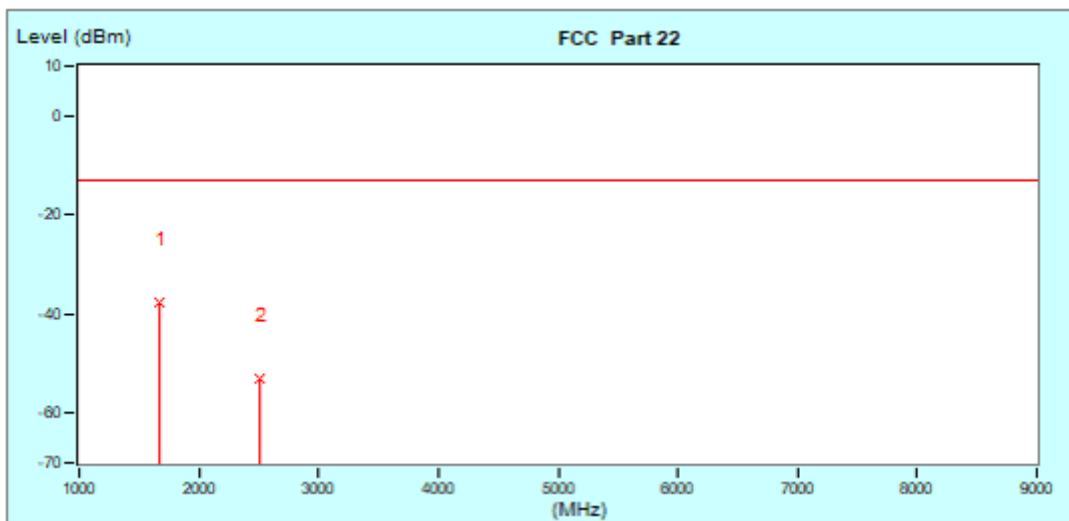



BUREAU VERITAS

Test Report No.: W7L-P23100004RF01

CH20635

MODE	TX channel 20635	FREQUENCY RANGE	Above 1000MHz
ENVIRONMENTAL CONDITIONS	23deg. C, 70%RH	INPUT POWER	AC 120V/60HZ
TESTED BY	Jace Hu		
<b>ANTENNA POLARITY &amp; TEST DISTANCE: HORIZONTAL AT 3 M</b>			

No.	Frequency MHz	Factor dB	Reading dBm	Emission dBm	Limit dBm	Margin dB	Tower / Table cm deg	
- 1	1695.00 (PK)	-12.49	-31.46	-43.95	-13.00	-30.95	100	0
- 2	2542.50 (PK)	-10.93	-41.39	-52.32	-13.00	-39.32	100	0

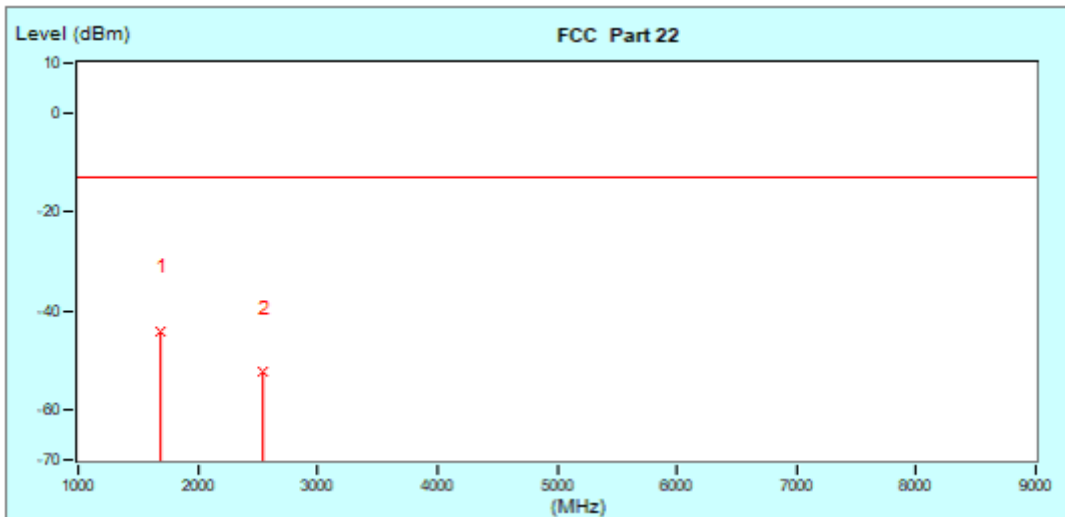



<b>MODE</b>	TX channel 20635	<b>FREQUENCY RANGE</b>	Above 1000MHz
<b>ENVIRONMENTAL CONDITIONS</b>	23deg. C, 70%RH	<b>INPUT POWER</b>	AC 120V/60HZ
<b>TESTED BY</b>	Jace Hu		
<b>ANTENNA POLARITY &amp; TEST DISTANCE: VERTICAL AT 3 M</b>			

No.	Frequency MHz	Factor dB	Reading dBm	Emission dBm	Limit dBm	Margin dB	Tower / Table cm deg	
- 1	1695.00 (PK)	-12.49	-27.86	-40.35	-13.00	-27.35	100	0
- 2	2542.50 (PK)	-10.93	-39.93	-50.86	-13.00	-37.86	100	0

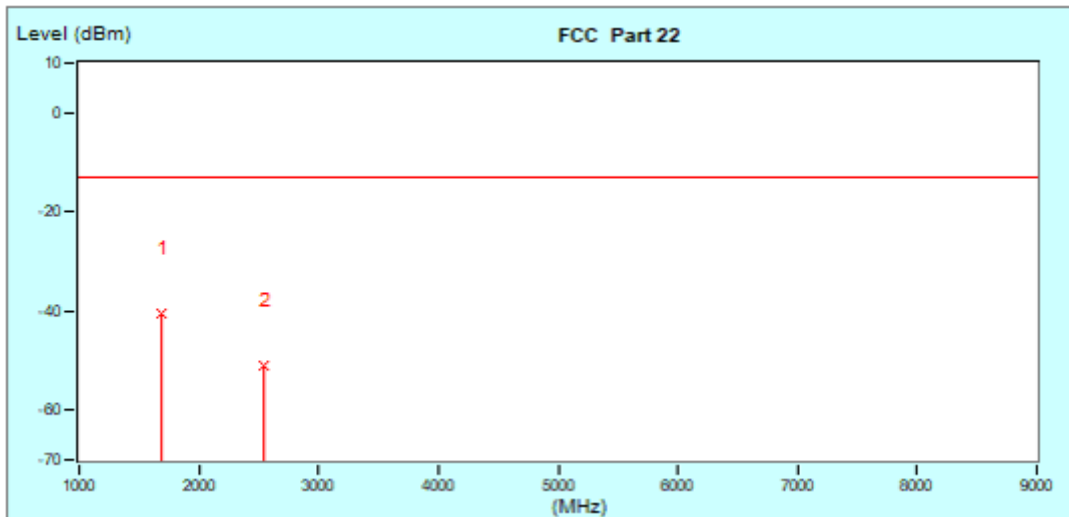



**CHANNEL BANDWIDTH: 5MHz / QPSK**

<b>MODE</b>	TX channel 20525	<b>FREQUENCY RANGE</b>	Above 1000MHz
<b>ENVIRONMENTAL CONDITIONS</b>	23deg. C, 70%RH	<b>INPUT POWER</b>	AC 120V/60HZ
<b>TESTED BY</b>	Jace Hu		
<b>ANTENNA POLARITY &amp; TEST DISTANCE: HORIZONTAL AT 3 M</b>			

No.	Frequency MHz	Factor dB	Reading dBm	Emission dBm	Limit dBm	Margin dB	Tower / Table cm deg	
1	1673.00 (PK)	-12.76	-31.63	-44.39	-13.00	-31.39	100	0
2	2509.50 (PK)	-10.93	-42.00	-52.93	-13.00	-39.93	100	0

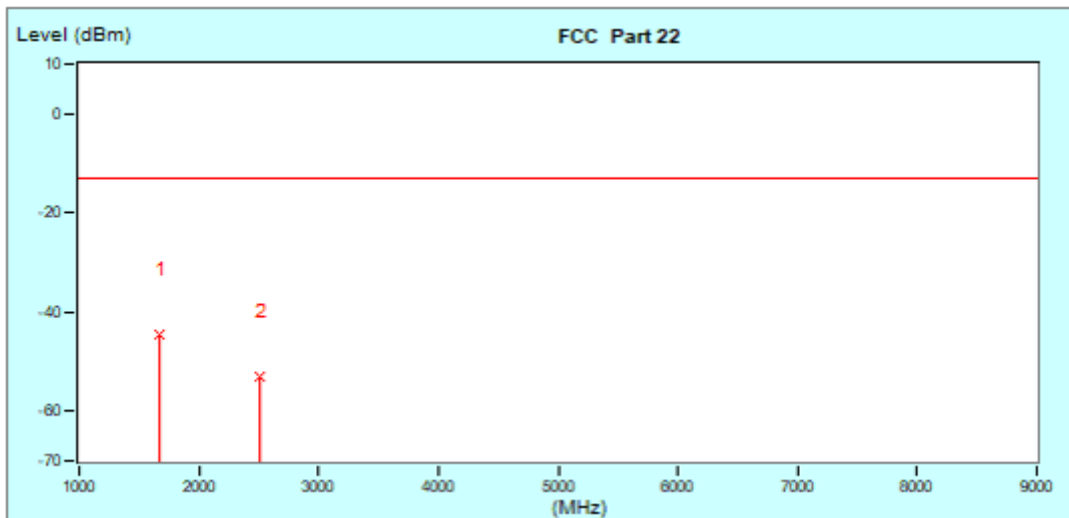





BUREAU VERITAS

Test Report No.: W7L-P23100004RF01

<b>MODE</b>	TX channel 20525	<b>FREQUENCY RANGE</b>	Above 1000MHz
<b>ENVIRONMENTAL CONDITIONS</b>	23deg. C, 70%RH	<b>INPUT POWER</b>	AC 120V/60HZ
<b>TESTED BY</b>	Jace Hu		
<b>ANTENNA POLARITY &amp; TEST DISTANCE: VERTICAL AT 3 M</b>			

No.	Frequency MHz	Factor dB	Reading dBm	Emission dBm	Limit dBm	Margin dB	Tower / Table cm deg	
1	1673.00 (PK)	-12.76	-28.02	-40.78	-13.00	-27.78	100	0
2	2509.50 (PK)	-10.93	-41.89	-52.82	-13.00	-39.82	100	0

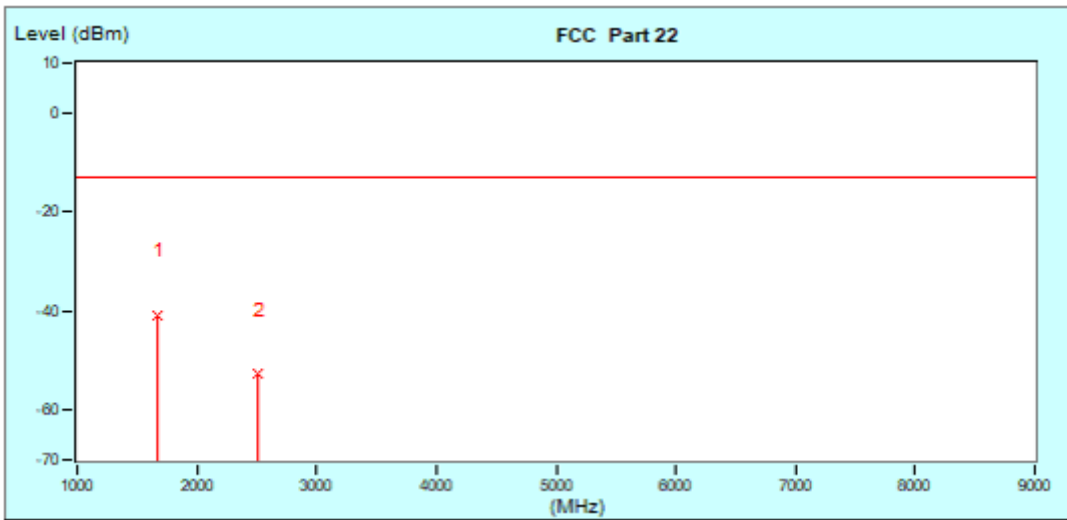



**CHANNEL BANDWIDTH: 10MHz / QPSK**

<b>MODE</b>	TX channel 20525	<b>FREQUENCY RANGE</b>	Above 1000MHz
<b>ENVIRONMENTAL CONDITIONS</b>	23deg. C, 70%RH	<b>INPUT POWER</b>	AC 120V/60HZ
<b>TESTED BY</b>	Jace Hu		
<b>ANTENNA POLARITY &amp; TEST DISTANCE: HORIZONTAL AT 3 M</b>			

No.	Frequency MHz	Factor dB	Reading dBm	Emission dBm	Limit dBm	Margin dB	Tower / Table cm deg	
1	1673.00 (PK)	-12.76	-32.83	-45.59	-13.00	-32.59	100	0
2	2509.50 (PK)	-10.93	-39.24	-50.17	-13.00	-37.17	100	0

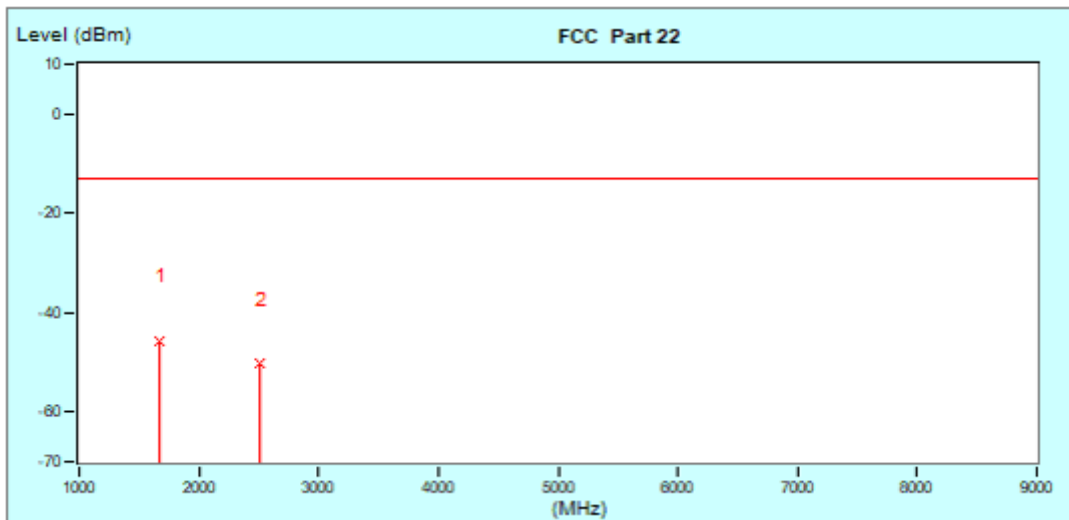



BUREAU VERITAS

Test Report No.: W7L-P23100004RF01

<b>MODE</b>	TX channel 20525	<b>FREQUENCY RANGE</b>	Above 1000MHz
<b>ENVIRONMENTAL CONDITIONS</b>	23deg. C, 70%RH	<b>INPUT POWER</b>	AC 120V/60HZ
<b>TESTED BY</b>	Jace Hu		
<b>ANTENNA POLARITY &amp; TEST DISTANCE: VERTICAL AT 3 M</b>			

No.	Frequency MHz	Factor dB	Reading dBm	Emission dBm	Limit dBm	Margin dB	Tower / Table cm deg	
* 1	1673.00 (PK)	-12.76	-27.72	-40.48	-13.00	-27.48	100	0
2	2509.50 (PK)	-10.93	-41.45	-52.38	-13.00	-39.38	100	0

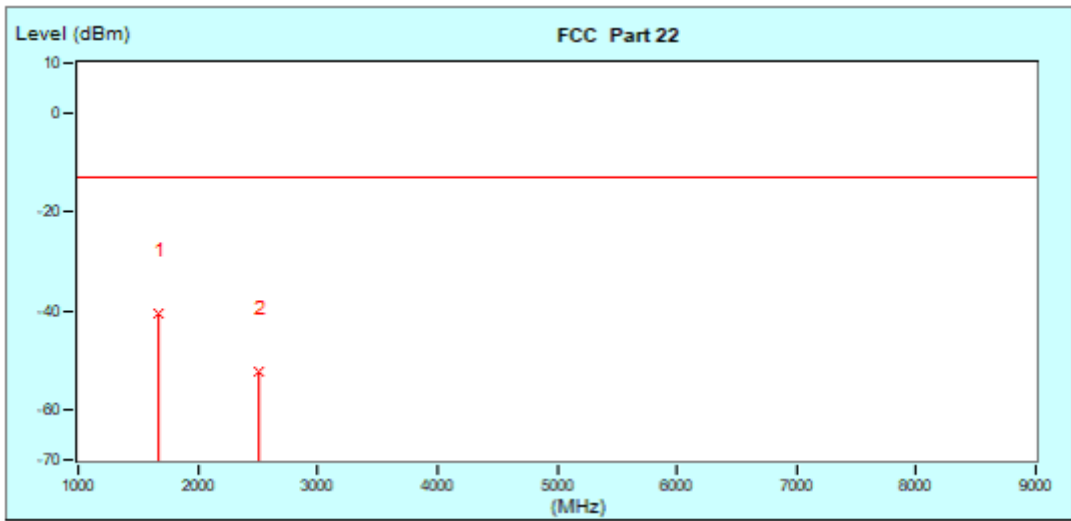

### 3.7 PEAK TO AVERAGE RATIO

#### 3.7.1 LIMITS OF PEAK TO AVERAGE RATIO MEASUREMENT

In measuring transmissions in this band using an average power technique, the peak to-average ratio (PAR) of the transmission may not exceed 13 dB

#### 3.7.2 TEST SETUP

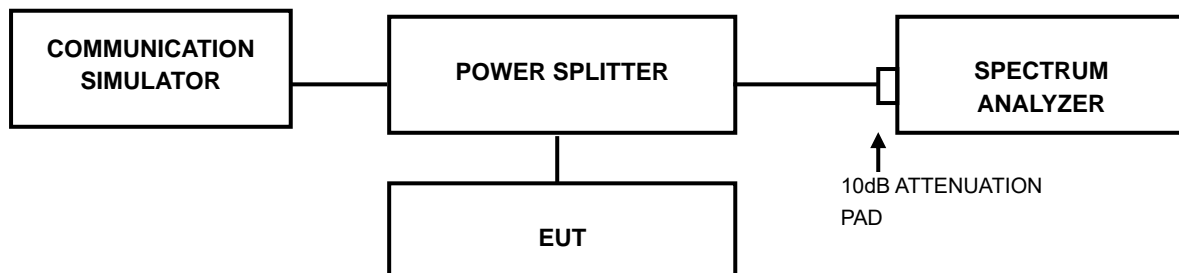

#### 3.7.3 TEST PROCEDURES

1. Set resolution/measurement bandwidth  $\geq$  signal's occupied bandwidth;
2. Set the number of counts to a value that stabilizes the measured CCDF curve;
3. Record the maximum PAPR level associated with a probability of 0.1%.



**BUREAU**  
**VERITAS**

**Test Report No.: W7L-P23100004RF01**

### 3.7.4 TEST RESULTS

Please Refer to Module report R2007A0435-R4.



**BUREAU**  
**VERITAS**

Test Report No.: W7L-P23100004RF01

## 4 PHOTOGRAPHS OF THE TEST CONFIGURATION

Please refer to the attached file (Test Setup Photo).



**BUREAU  
VERITAS**

Test Report No.: W7L-P23100004RF01

## 5 INFORMATION ON THE TESTING LABORATORIES

We, BV 7LAYERS COMMUNICATIONS TECHNOLOGY (SHENZHEN) CO. LTD., were founded in 2015 to provide our best service in EMC, Radio, Telecom and Safety consultation. Our laboratories are accredited and approved according to ISO/IEC 17025.

If you have any comments, please feel free to contact us at the following:

**Shenzhen EMC/RF Lab:**

Tel: +86-755-88696566

Fax: +86-755-88696577

**Email:** [customerservice.sw@bureauveritas.com](mailto:customerservice.sw@bureauveritas.com)

**Web Site:** [www.adt.com.tw](http://www.adt.com.tw)

The address and road map of all our labs can be found in our web site also.



**BUREAU  
VERITAS**

Test Report No.: W7L-P23100004RF01

## **6 MODIFICATIONS RECORDERS FOR ENGINEERING CHANGES TO THE EUT BY THE LAB**

No any modifications are made to the EUT by the lab during the test.

**---END---**





Test Report No.: W7L-P23100004RF01