



# RF TEST REPORT

**Applicant**      Quectel Wireless Solutions Co., Ltd.

**FCC ID**            XMR201707BG96

**Product**          LTE Cat M1 & Cat NB1 & EGPRS Module

**Brand**             Quectel

**Model**            BG96, BG96 MINIPCIE

**Marketing**        Quectel BG96, Quectel BG96 MINIPCIE

**Report No.**        R2007A0435-R4

**Issue Date**        August 18, 2020

TA Technology (Shanghai) Co., Ltd. tested the above equipment in accordance with the requirements in **FCC CFR47 Part 2 (2019)/ FCC CFR 47 Part 22H (2019)**. The test results show that the equipment tested is capable of demonstrating compliance with the requirements as documented in this report.

*Performed by: Peng Tao*

*Approved by: Kai Xu*

---

## TA Technology (Shanghai) Co., Ltd.

*No.145, Jintang Rd, Tangzhen Industry Park, Pudong Shanghai, China*

*TEL: +86-021-50791141/2/3*

*FAX: +86-021-50791141/2/3-8000*



## TABLE OF CONTENT

1. Test Laboratory .....	4
1.1. Notes of the Test Report .....	4
1.2. Test facility .....	4
1.3. Testing Location .....	5
2. General Description of Equipment under Test .....	6
3. Applied Standards .....	7
4. Test Configuration .....	8
5. Test Case Results .....	10
5.1. RF Power Output .....	10
5.2. Effective Radiated Power .....	13
5.3. Occupied Bandwidth .....	16
5.4. Band Edge Compliance .....	21
5.5. Peak-to-Average Power Ratio (PAPR) .....	29
5.6. Frequency Stability .....	31
5.7. Spurious Emissions at Antenna Terminals .....	36
5.8. Radiates Spurious Emission .....	42
6. Main Test Instruments .....	49
ANNEX A: Product Change Description .....	51

### Summary of measurement results

No.	Test Type	Clause in FCC rules	Verdict
1	RF power output	2.1046	Refer to the Original
2	Effective Radiated Power	22.913(a)(2)	Refer to the Original
3	Occupied Bandwidth	2.1049	Refer to the Original
4	Band Edge Compliance	2.1051 / 22.917(a)	Only test LTE Band
5	Peak-to-Average Power Ratio	22.913(d)/ KDB 971168 D01(5.7)	Refer to the Original
6	Frequency Stability	2.1055 / 22.355	Refer to the Original
7	Spurious Emissions at Antenna Terminals	2.1051 / 22.917(a)	Refer to the Original
8	Radiates Spurious Emission	2.1053 / 22.917 (a)	Refer to the Original

Date of Testing: June 24, 2017~July 3, 2017 and August10, 2020 ~ August12, 2020

Note: All indications of Pass/Fail in this report are opinions expressed by TA Technology (Shanghai) Co., Ltd. based on interpretations and/or observations of test results. Measurement Uncertainties were not taken into account and are published for informational purposes only.

**BG96, BG96 MINIPCIE (Report No.: R2007A0435-R4) is a variant model of BG96, BG96 MINIPCIE (Report No.: R1811A0536-R1). Test values partial duplicated from original for variant. There is only tested Band Edge Compliance of LTE Band for variant in this report. The detailed product change description please refers to the Statement letter\_BG96.**

**BG96, BG96 MINIPCIE (Report No: R1811A0536-R1) is a variant model of BG96 (Report No: RXA1706-0199RF01R1). Test values duplicated from Original for variant. There is no test for variant in this report. The detailed product change description please refers to the ANNEX A.**



## 1. Test Laboratory

### 1.1. Notes of the Test Report

This report shall not be reproduced in full or partial, without the written approval of **TA technology (shanghai) co., Ltd.** The results documented in this report apply only to the tested sample, under the conditions and modes of operation as described herein .Measurement Uncertainties were not taken into account and are published for informational purposes only. This report is written to support regulatory compliance of the applicable standards stated above. This report must not be used by the client to claim product certification, approval, or endorsement by any government agencies.

### 1.2. Test facility

#### **FCC (recognition number is 428261)**

TA Technology (Shanghai) Co., Ltd. has been listed on the US Federal Communications Commission list of test facilities recognized to perform electromagnetic emissions measurements.

#### **A2LA (Certificate Number: 3857.01)**

TA Technology (Shanghai) Co., Ltd. has been listed by American Association for Laboratory Accreditation to perform electromagnetic emission measurement.



### 1.3. Testing Location

Company: TA Technology (Shanghai) Co., Ltd.  
Address: No.145, Jintang Rd, Tangzhen Industry Park, Pudong  
City: Shanghai  
Post code: 201201  
Country: P. R. China  
Contact: Xu Kai  
Telephone: +86-021-50791141/2/3  
Fax: +86-021-50791141/2/3-8000  
Website: <http://www.ta-shanghai.com>  
E-mail: [xukai@ta-shanghai.com](mailto:xukai@ta-shanghai.com)

## 2. General Description of Equipment under Test

### Client Information

Applicant	Quectel Wireless Solutions Co., Ltd.
Applicant address	7th Floor, Hongye Building, No. 1801 Hongmei Road, Xuhui District, Shanghai, China
Manufacturer	Quectel Wireless Solutions Co., Ltd.
Manufacturer address	7th Floor, Hongye Building, No. 1801 Hongmei Road, Xuhui District, Shanghai, China

### General Information

EUT Description			
Model	BG96, BG96 MINIPCIE		
IMEI	866425038291656		
Hardware Version	R1.2		
Software Version	BG96MAR04A01M1G		
Power Supply	External power supply		
Antenna Type	The EUT don't have standard Antenna, The Antenna used for testing in this report is the after-market accessory (Dipole Antenna)		
Antenna Gain	4 dBi		
Test Mode(s)	GSM 850: LTE Band 5;		
Test Modulation	(GSM)GMSK,8PSK; (LTE)QPSK 16QAM;		
LTE Category	M1		
Maximum E.R.P.	GSM 850:	32.13 dBm	
	LTE Band 5:	27.65 dBm	
Rated Power Supply Voltage	3.8V		
Extreme Voltage	Minimum: 3.3V    Maximum: 4.3V		
Extreme Temperature	Lowest: -40°C    Highest: +85°C		
Frequency Range(s)	Band	Tx (MHz)	Rx (MHz)
	GSM850	824 ~ 849	869 ~ 894
	LTE Band 5	824 ~ 849	869 ~ 894
Note: The information of the EUT is declared by the manufacturer.			

The series model number is: BG96 MINIPCIE. The difference of these models are have different marketing requirement.



### 3. Applied Standards

According to the specifications of the manufacturer, it must comply with the requirements of the following standards:

**Test standards:**

**FCC CFR 47 Part 22H (2019)**

**ANSI C63.26 (2015)**

**Reference standard:**

**FCC CFR47 Part 2 (2019)**

**KDB 971168 D01 Power Meas License Digital Systems v03r01**

## 4. Test Configuration

Radiated measurements are performed by rotating the EUT in three different orthogonal test planes. EUT stand-up position (X, Y axis), lie-down position (Z axis). Receiver antenna polarization (horizontal and vertical), the worst emission was found in position (Z axis, vertical polarization) and the worst case was recorded.

All mode and data rates and positions were investigated. Subsequently, only the worst case emissions are reported.

The following testing in GSM/LTE is set based on the maximum RF Output Power.

Test modes are chosen to be reported as the worst case configuration below:

Test items	Modes/Modulation
	GSM 850
RF power output	GPRS EGPRS
Occupied Bandwidth	GPRS(1Tx slot) EGPRS(1Tx slot)
Band Edge Compliance	GPRS(1Tx slot) EGPRS(1Tx slot)
Peak-to-Average Power Ratio	GPRS(1Tx slot) EGPRS(1Tx slot)
Frequency Stability	GPRS(1Tx slot) EGPRS(1Tx slot)
Spurious Emissions at Antenna Terminals	GPRS(1Tx slot)
Effective Radiated Power	GPRS(1Tx slot) EGPRS(1Tx slot)
Radiates Spurious Emission	GPRS(1Tx slot)





Test modes are chosen as the worst case configuration below for LTE Band 5

Test items	Bandwidth (MHz)				Modulation		RB			Test Channel		
	1.4	3	5	10	QPSK	16QAM	1	50%	100%	L	M	H
RF power output	O	O	O	O	O	O	O	O	O	O	O	O
Effective Isotropic Radiated power	O	O	O	O	O	O	-	-	O	O	O	O
Occupied Bandwidth	O	O	O	O	O	O	-	-	O	-	O	-
Band Edge Compliance	O	O	O	O	O	O	O	-	O	O	-	O
Peak-to-Average Power Ratio	O	O	O	O	O	O	-	-	O	-	O	-
Frequency Stability	O	O	O	O	O	O	-	-	O	-	O	-
Spurious Emissions at Antenna Terminals	O	O	O	O	O	-	O	-	-	O	O	O
Radiates Spurious Emission	-	-	-	O	O	-	O	-	-	O	O	O
Note	1. The mark "O" means that this configuration is chosen for testing. 2. The mark "-" means that this configuration is not testing.											

## 5. Test Case Results

### 5.1. RF Power Output

#### Ambient condition

Temperature	Relative humidity	Pressure
23°C ~25°C	45%~50%	101.5kPa

#### Methods of Measurement

During the process of the testing, The EUT is controlled by the Base Station Simulator to ensure max power transmission and proper modulation.

#### Test Setup

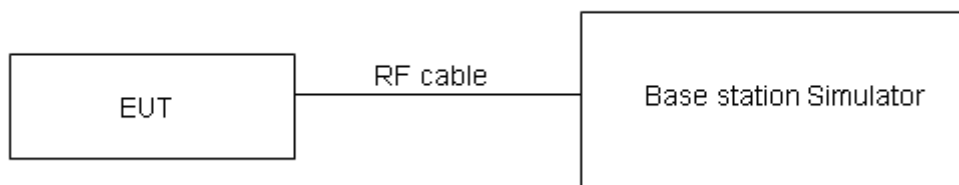

The loss between RF output port of the EUT and the input port of the tester has been taken into consideration.

#### Limits

No specific RF power output requirements in part 2.1046.

#### Measurement Uncertainty

The assessed measurement uncertainty to ensure 95% confidence level for the normal distribution is with the coverage factor  $k = 2$ ,  $U = 0.4$  dB.

**Test Results**

GSM 850		Conducted Power(dBm)		
		Channel 128	Channel 190	Channel 251
		824.2 (MHz)	836.6 (MHz)	848.8 (MHz)
GPRS (GMSK)	1TXslot	32.25	32.28	32.31
	2TXslots	32.11	32.05	32.10
	3TXslots	31.21	31.26	31.31
	4TXslots	30.01	30.11	30.28
EGPRS (8PSK)	1TXslot	26.58	26.65	26.78
	2TXslots	26.51	26.48	26.61
	3TXslots	26.27	26.28	26.42
	4TXslots	26.05	26.06	26.19



Mode	Bandwidth	Channel/ Frequency(MHz)	Index	RB# RBstart	Conducted Power (dBm)	
					QPSK	16QAM
Band5	1.4MHz	20407/824.7	0	1#0	22.66	23.79
			0	6#0	22.62	22.67
		20525/836.5	0	1#0	23.15	22.63
			0	6#0	22.71	23.20
		20643/848.3	0	1#5	23.21	23.14
			0	6#0	22.86	23.00
	3MHz	20415/825.5	0	1#0	22.68	23.81
			0	6#0	22.70	22.70
		20525/836.5	0	1#0	23.16	22.66
			0	6#0	22.73	23.25
		20635/847.5	1	1#5	23.24	23.16
			1	6#0	22.90	23.04
	5MHz	20425/826.5	3	1#0	22.67	23.76
			0	6#0	22.68	22.67
		20525/836.5	0	1#0	23.12	22.64
			0	6#0	22.69	23.20
		20625/846.5	0	1#5	23.22	23.14
			3	6#0	22.85	23.00
	10MHz	20450/829	3	1#0	22.64	23.74
			0	4#0	22.65	22.65
		20525/836.5	0	1#0	23.08	22.60
			0	4#0	22.64	23.16
		20600/844	4	1#5	23.19	23.09
			7	4#2	22.81	22.97

## 5.2. Effective Radiated Power

### Ambient condition

Temperature	Relative humidity	Pressure
23°C ~25°C	45%~50%	101.5kPa

### Methods of Measurement

The testing follows FCC KDB 971168 v03r01 Section 5.8 and ANSI C63.26 (2015).

- a) Connect the equipment as illustrated. Mount the equipment with the manufacturer specified antenna in a vertical orientation on a manufacturer specified mounting surface located on a non-conducting rotating platform of a RF anechoic chamber (preferred) or a standard radiation site.
- b) Key the transmitter, then rotate the EUT 360° azimuthally and record spectrum analyzer power level (LVL) measurements at angular increments that are sufficiently small to permit resolution of all peaks. If a standard radiation test site is used, raise and lower the test antenna to obtain a maximum reading at each angular increment. (Note: several batteries may be needed to offset the effect of battery voltage droop, which should not exceed 5% of the manufactured specified battery voltage during transmission).
- c) Replace the transmitter under test with a vertically polarized half-wave dipole (or an antenna whose gain is known relative to an ideal half-wave dipole). The center of the antenna should be at the same location as the center of the antenna under test.
- d) Connect the antenna to a signal generator with a known output power and record the path loss (in dB) as LOSS. If a standard radiation test site is used, raise and lower the test antenna to obtain a maximum reading.  $LOSS = \text{Generator Output Power (dBm)} - \text{Analyzer reading (dBm)}$
- e) Determine the effective radiated output power at each angular position from the readings in steps b) and d) using the following equation:  $ERP \text{ (dBm)} = \text{LVL (dBm)} + \text{LOSS (dB)}$
- f) The maximum ERP is the maximum value determined in the preceding step.
- g) When calculating ERP, in addition to knowing the antenna radiation and matching characteristics, it is necessary to know the loss values of all elements (e.g. transmission line attenuation, mismatches, filters, combiners) interposed between the point where transmitter output power is measured, and the point where power is applied to the antenna. ERP can then be calculated as follows:  
 $EIRP \text{ (dBm)} = \text{Output Power (dBm)} - \text{Losses (dB)} + \text{Antenna Gain (dBi)}$   
where: dBd refers to gain relative to an ideal dipole.  
 $EIRP \text{ (dBm)} = ERP \text{ (dBm)} + 2.15 \text{ (dB.)}$

The RB allocation refers to section 5.1, using the maximum output power configuration.

**Test setup**

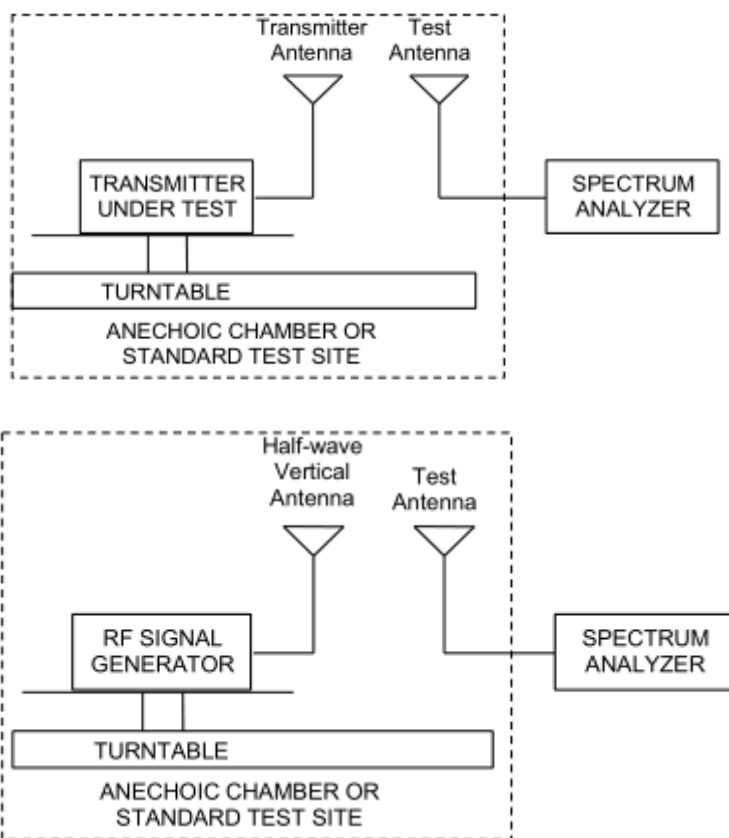

**Limits**

Rule Part 22.913(a)(5) specifies that "Mobile/portable stations are limited to 7 watts ERP".

Limit	$\leq 7 \text{ W}$ (38.45 dBm)
-------	--------------------------------

**Measurement Uncertainty**

The assessed measurement uncertainty to ensure 95% confidence level for the normal distribution is with the coverage factor  $k = 2$ ,  $U = 1.19 \text{ dB}$

**Test Results:**

The measurement is performed for both of horizontal and vertical antenna Polarization, and only the data of worst mode is recorded in this report.

Mode	Frequency (MHz)	Polarization	ERP (dBm)	Limit (dBm)	Conclusion
GPRS 850	824.2	Horizontal	32.13	38.45	Pass
	836.6	Horizontal	31.80	38.45	Pass
	848.8	Horizontal	31.09	38.45	Pass
EGPRS 850	824.2	Horizontal	26.43	38.45	Pass
	836.6	Horizontal	26.50	38.45	Pass
	848.8	Horizontal	26.63	38.45	Pass

LTE Band 5					
bandwidth	Channel/ Frequency (MHz)	Polarization	ERP (dBm)	Limit (dBm)	Conclusion
1.4 MHz (QPSK)	20407/824.7	Horizontal	26.04	38.45	Pass
	20525/836.5	Horizontal	26.98	38.45	Pass
	20643/848.3	Horizontal	27.29	38.45	Pass
3 MHz (QPSK)	20415/825.5	Horizontal	25.72	38.45	Pass
	20525/836.5	Horizontal	27.17	38.45	Pass
	20635/847.5	Horizontal	26.95	38.45	Pass
5 MHz (QPSK)	20425/826.5	Horizontal	25.49	38.45	Pass
	20525/836.5	Horizontal	26.73	38.45	Pass
	20625/846.5	Horizontal	27.53	38.45	Pass
10 MHz (QPSK)	20450/829	Horizontal	24.43	38.45	Pass
	20525/836.5	Horizontal	26.06	38.45	Pass
	20600/844	Horizontal	26.22	38.45	Pass
1.4 MHz (16QAM)	20407/824.7	Horizontal	25.70	38.45	Pass
	20525/836.5	Horizontal	26.66	38.45	Pass
	20643/848.3	Horizontal	26.95	38.45	Pass
3 MHz (16QAM)	20415/825.5	Horizontal	25.40	38.45	Pass
	20525/836.5	Horizontal	26.85	38.45	Pass
	20635/847.5	Horizontal	27.65	38.45	Pass
5 MHz (16QAM)	20425/826.5	Horizontal	25.17	38.45	Pass
	20525/836.5	Horizontal	26.40	38.45	Pass
	20625/846.5	Horizontal	27.20	38.45	Pass
10 MHz (16QAM)	20450/829	Horizontal	24.10	38.45	Pass
	20525/836.5	Horizontal	25.75	38.45	Pass
	20600/844	Horizontal	25.90	38.45	Pass

### 5.3. Occupied Bandwidth

#### Ambient condition

Temperature	Relative humidity	Pressure
23°C ~25°C	45%~50%	101.5kPa

#### Method of Measurement

The EUT was connected to Spectrum Analyzer and Base Station Simulator via power Splitter. The occupied bandwidth is measured using spectrum analyzer.

RBW is set to 3kHz, VBW is set to 10kHz for GSM 850,

RBW is set to 51 kHz, VBW is set to 160 kHz for LTE Band 5,

99% power and -26dBc occupied bandwidths are recorded. Spectrum analyzer plots are included on the following pages.

#### Test Setup

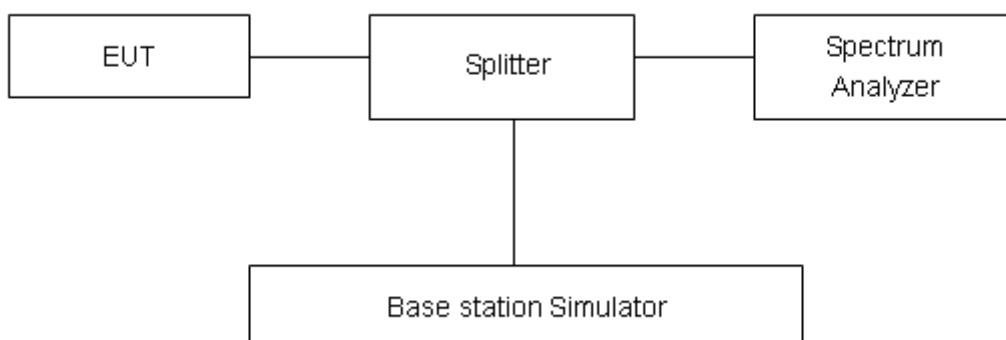

#### Limits

No specific occupied bandwidth requirements in part 2.1049.

#### Measurement Uncertainty

The assessed measurement uncertainty to ensure 95% confidence level for the normal distribution is with the coverage factor  $k = 2$ ,  $U = 624\text{Hz}$ .



**Test Result**

Mode	Channel	Frequency (MHz)	99% Power Bandwidth (MHz)	-26dBc Bandwidth(MHz)
<b>GPRS 850 (GMSK)</b>	128	824.2	0.24584	0.3134
	190	836.6	0.24471	0.3148
	251	848.8	0.24419	0.3039
<b>EGPRS 850 (8-PSK)</b>	128	824.2	0.24858	0.2973
	190	836.6	0.24438	0.3111
	251	848.8	0.24744	0.3130

Mode	Bandwidth	Modulation	Channel/ Frequency(MHz)	Bandwidth(MHz)	
				99% Power	-26dBc
Band5	1.4MHz	QPSK	20525/836.5	1.1074	1.329
		16QAM	20525/836.5	0.94726	1.198
	3MHz	QPSK	20525/836.5	1.1561	1.848
		16QAM	20525/836.5	0.98345	1.345
	5MHz	QPSK	20525/836.5	1.1536	1.866
		16QAM	20525/836.5	1.0072	1.453
	10MHz	QPSK	20525/836.5	1.1952	1.92
		16QAM	20525/836.5	1.0457	1.661

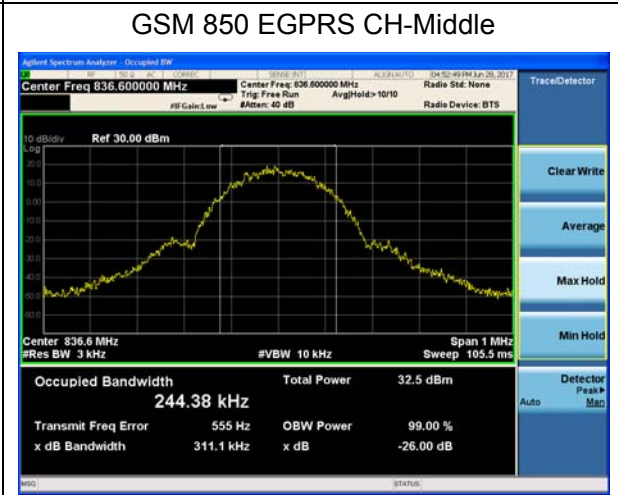
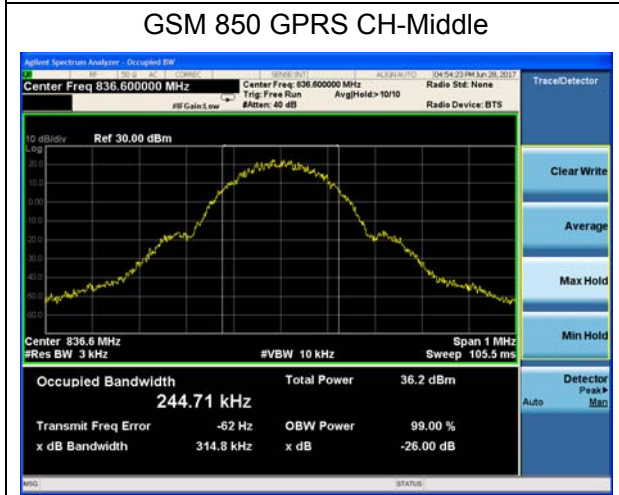
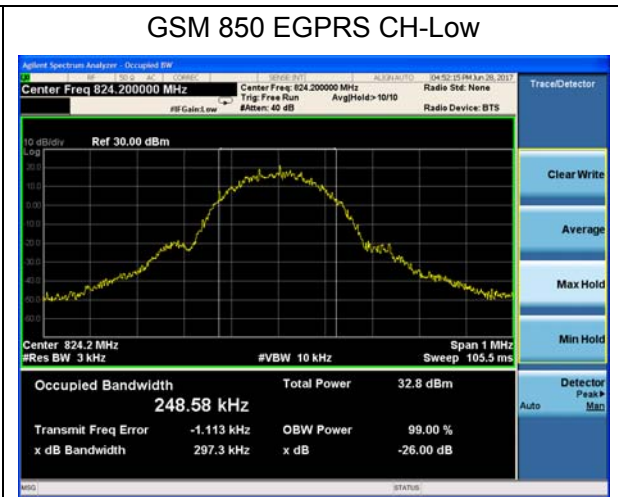

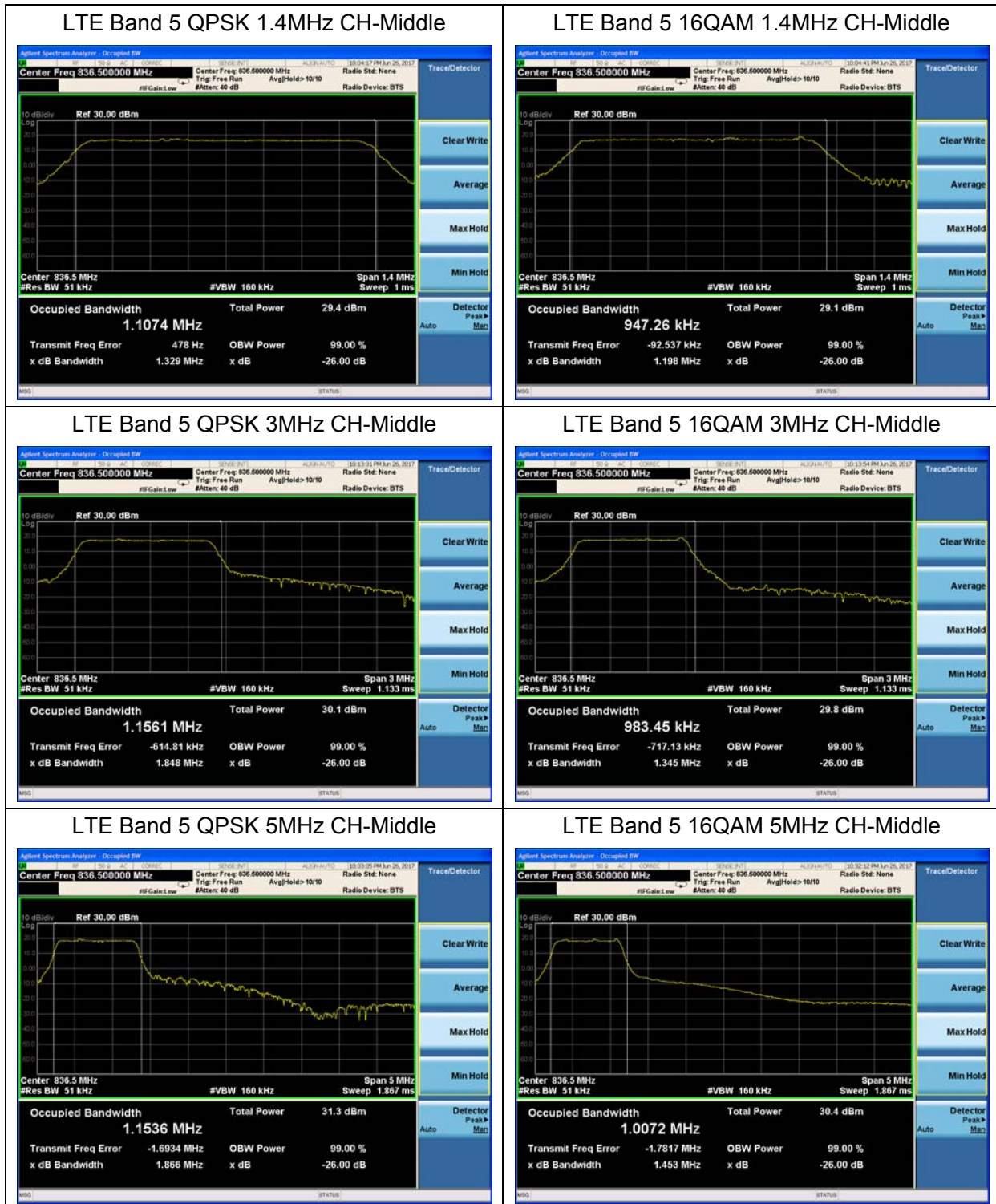

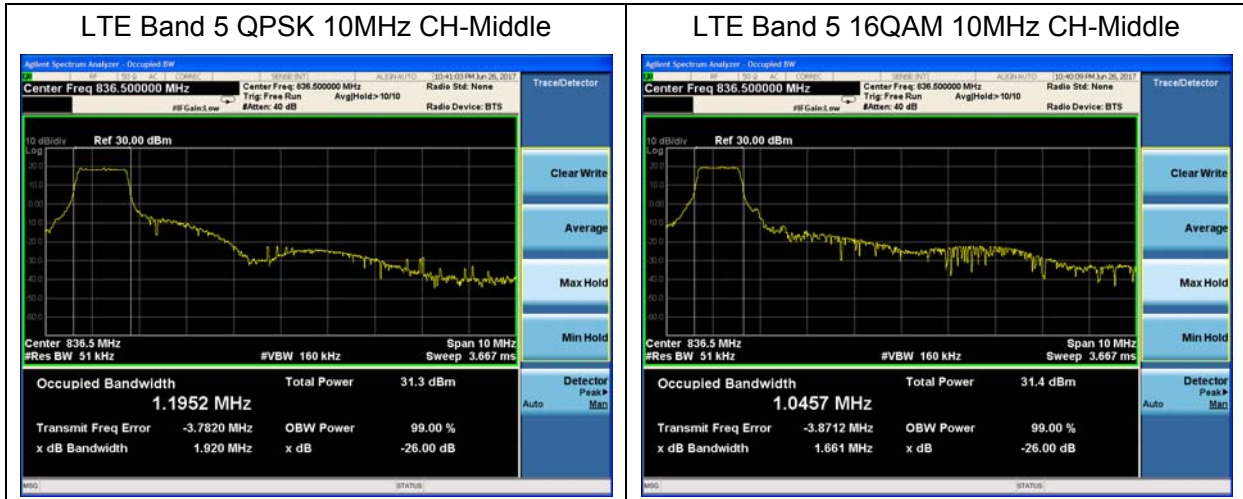

### 5.4. Band Edge Compliance

#### Ambient condition

Temperature	Relative humidity	Pressure
23°C ~25°C	45%~50%	101.5kPa

#### Method of Measurement

The EUT was connected to Spectrum Analyzer and Base Station Simulator via power Splitter. The band edge of the lowest and highest channels were measured. The average detector is used. RBW is set to 3kHz,VBW is set to 10kHz for GSM 850, RBW is set to 51kHz, VBW is set to 160kHz for LTE Band 5. Spectrum analyzer plots are included on the following pages.

#### Test Setup

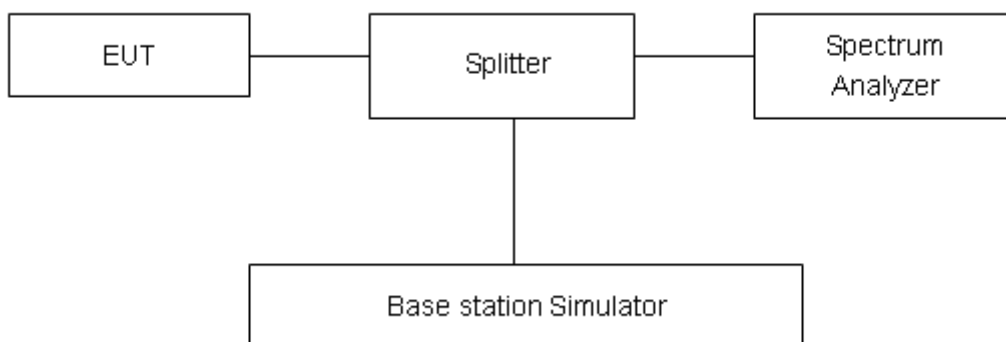

#### Limits

Rule Part 22.917(a) specifies that “The power of any emission outside of the authorized operating frequency ranges must be attenuated below the transmitting power (P) by a factor of at least 43 + 10 log(P) dB.”

Limit	-13 dBm
-------	---------

#### Measurement Uncertainty

The assessed measurement uncertainty to ensure 95% confidence level for the normal distribution is with the coverage factor  $k = 1.96$ ,  $U=0.684$ dB.



Test Result:

Original

GSM 850 GPRS CH-Low



GSM 850 GPRS CH-High



GSM 850 EGPRS CH-Low

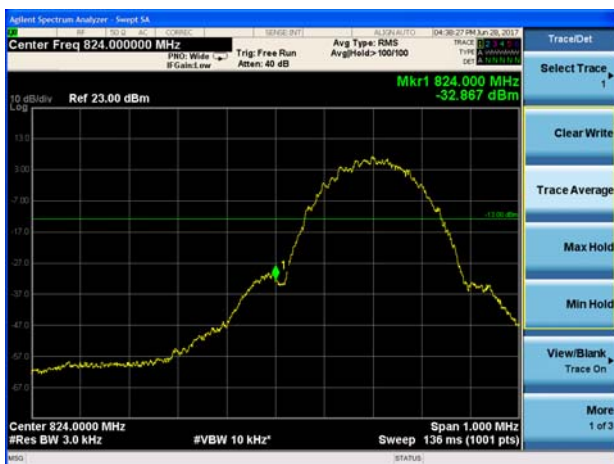

GSM 850 EGPRS CH-High



LTE Band 5 QPSK 1.4MHz CH-Low 1RB

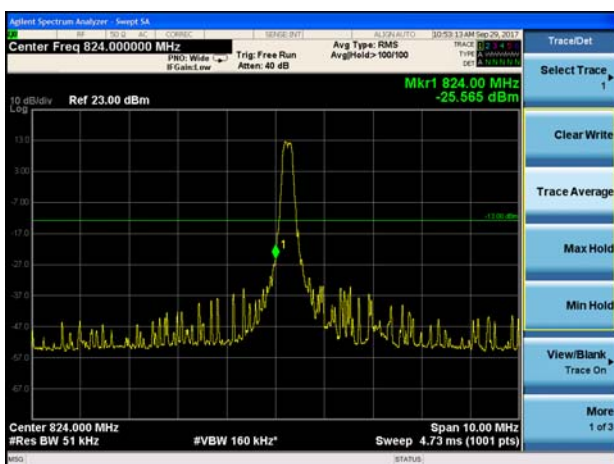

LTE Band 5 QPSK 1.4MHz CH-High 1RB

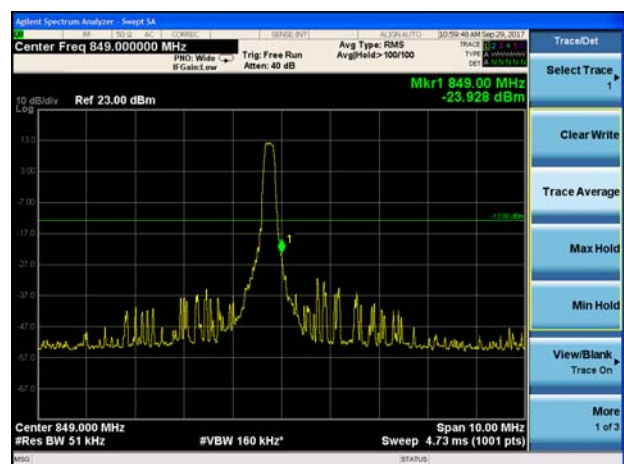

Variant

LTE Band 5 QPSK 1.4MHz CH-Low 1RB

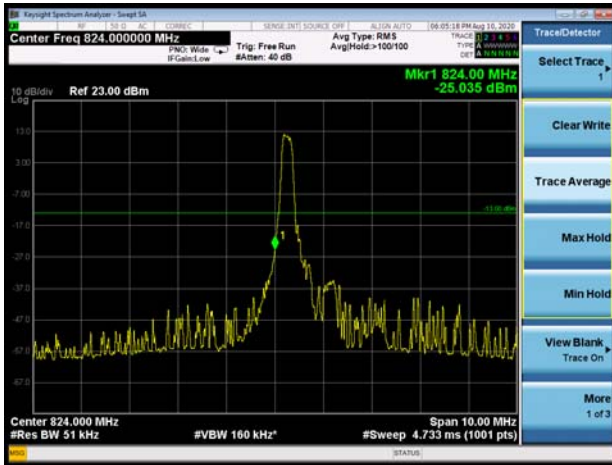

LTE Band 5 QPSK 1.4MHz CH-High 1RB

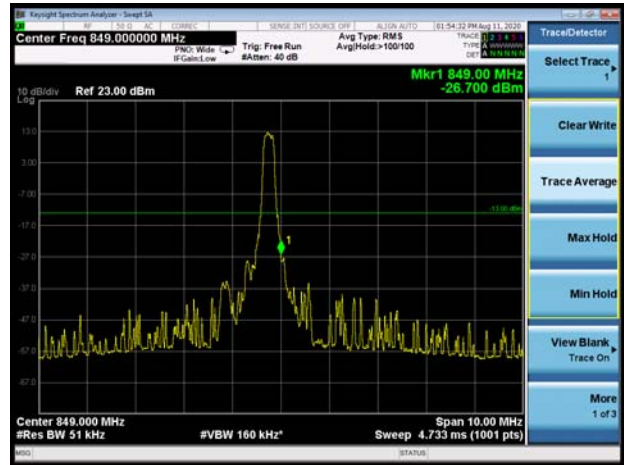

LTE Band 5 QPSK 1.4MHz CH-Low 100%RB

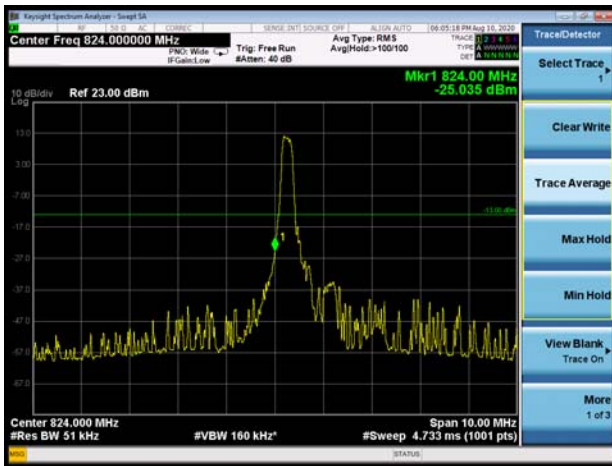

LTE Band 5 QPSK 1.4MHz CH-High 100%RB

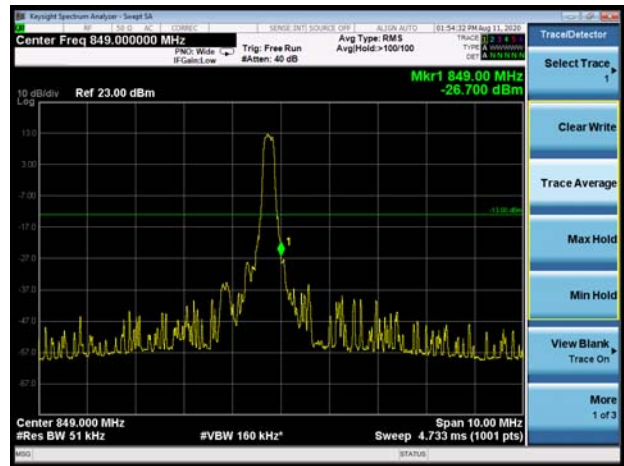

LTE Band 5 QPSK 3MHz CH-Low 1RB

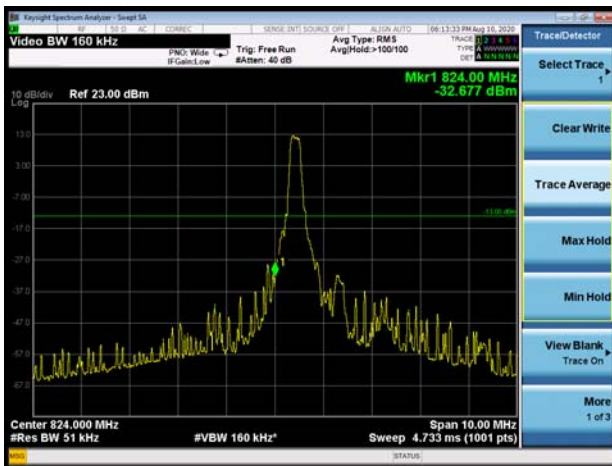

LTE Band 5 QPSK 3MHz CH-High 1RB

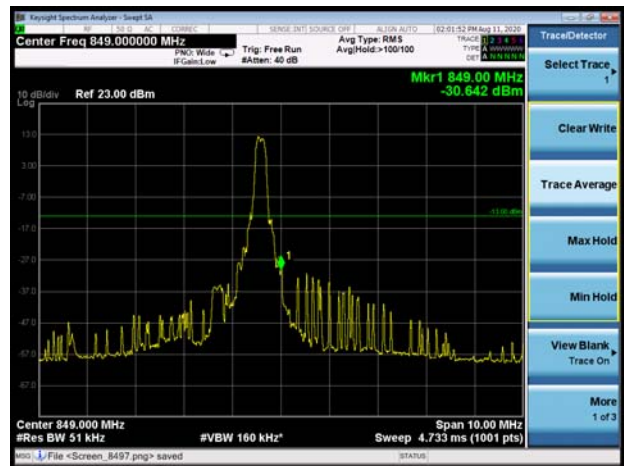

LTE Band 5 QPSK 3MHz CH-Low 100%RB

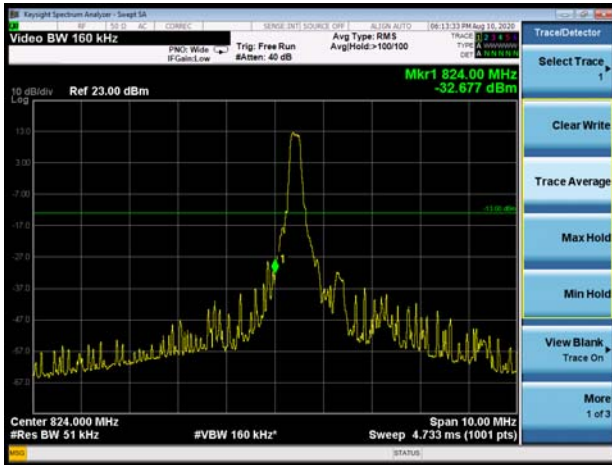

LTE Band 5 QPSK 3MHz CH-High 100%RB

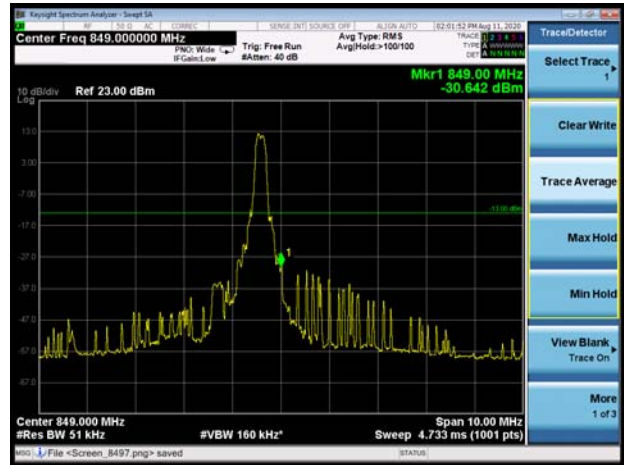

LTE Band 5 QPSK 5MHz CH-Low 1RB

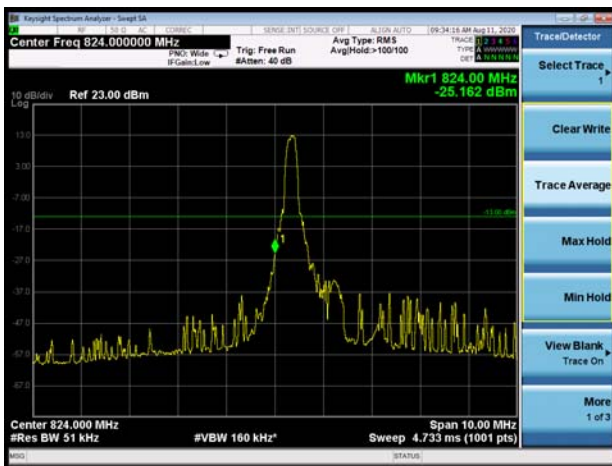

LTE Band 5 QPSK 5MHz CH-High 1RB

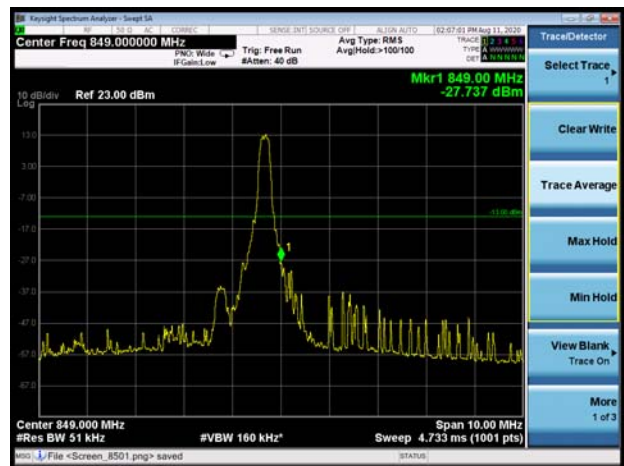

LTE Band 5 QPSK 5MHz CH-Low 100%RB

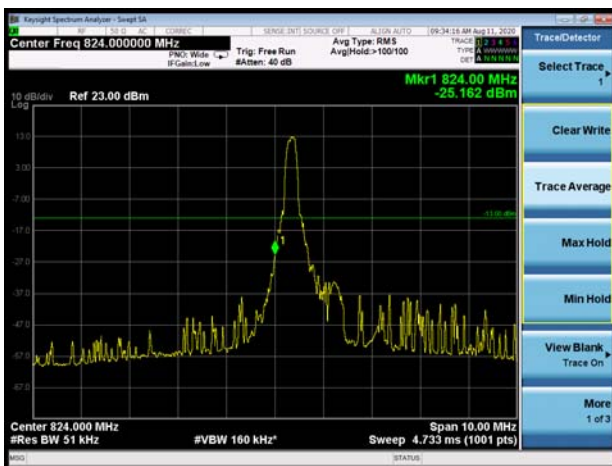

LTE Band 5 QPSK 5MHz CH-High 100%RB

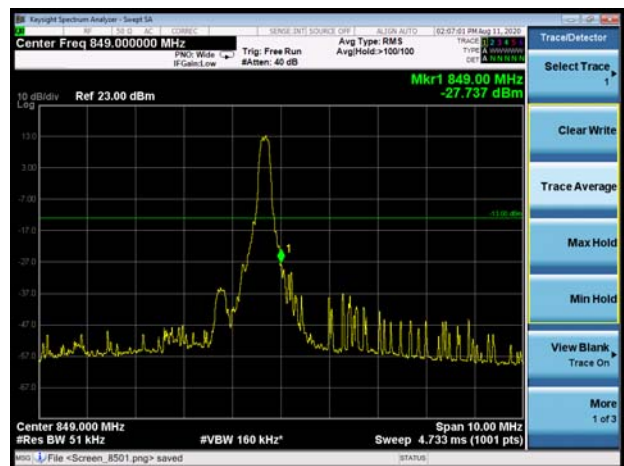



LTE Band 5 QPSK 10MHz CH-Low 1RB

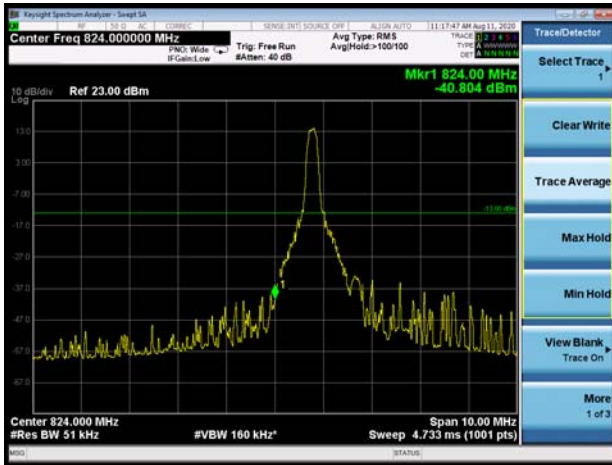

LTE Band 5 QPSK 10MHz CH-High 1RB

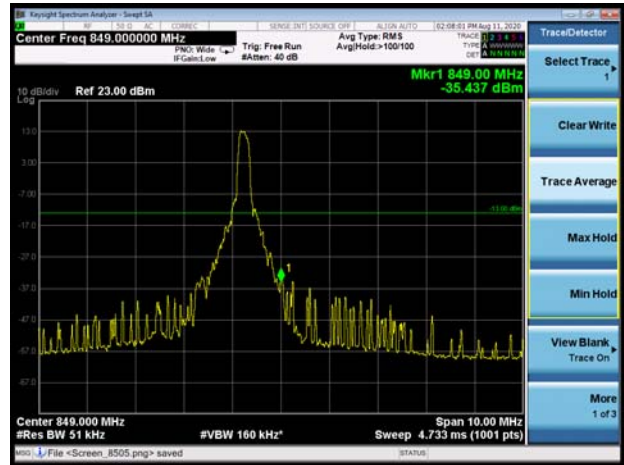

LTE Band 5 QPSK 10MHz CH-Low 100%RB

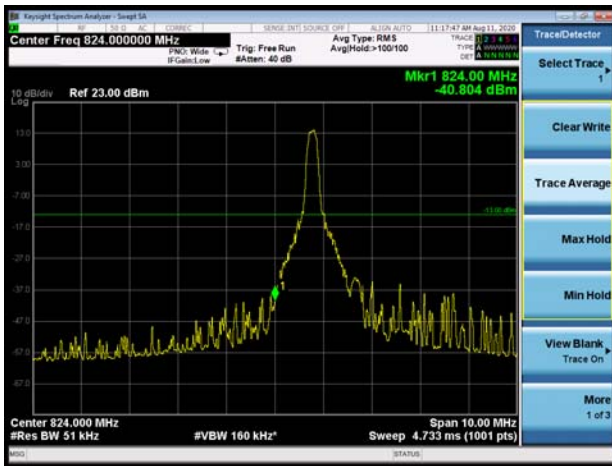

LTE Band 5 QPSK 10MHz CH-High 100%RB

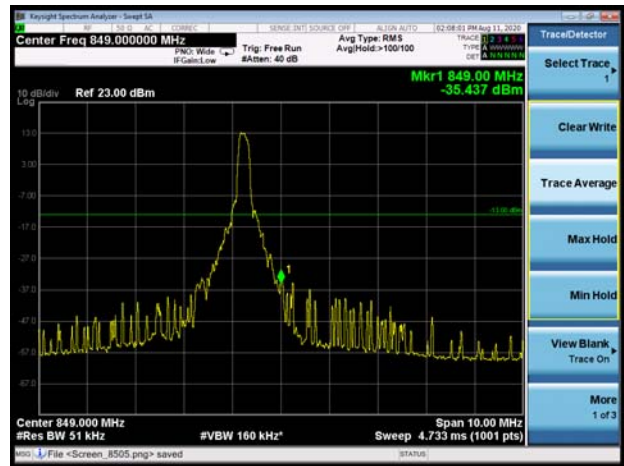

LTE Band 5 16QAM 1.4MHz CH-Low 1RB

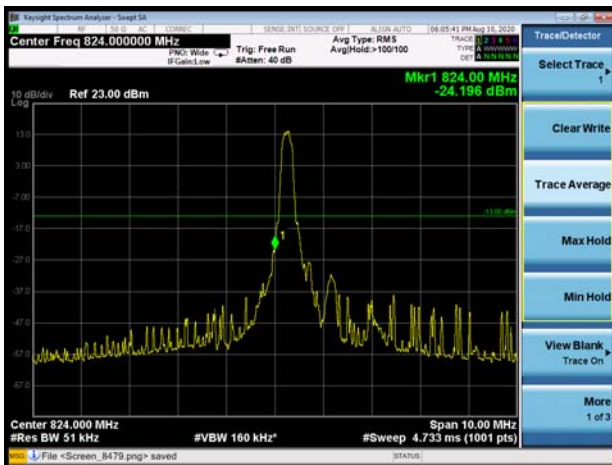

LTE Band 5 16QAM 1.4MHz CH-High 1RB

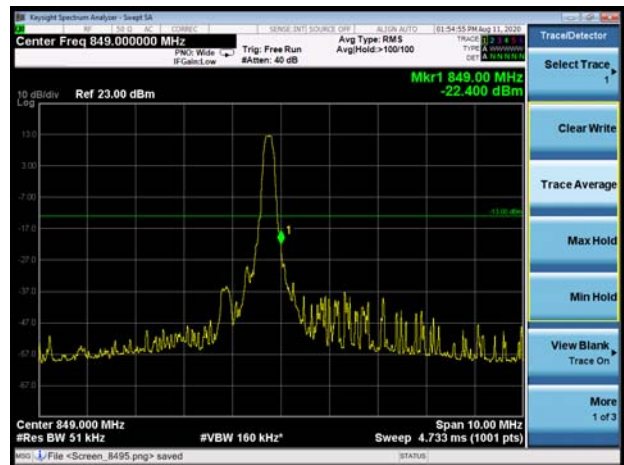

LTE Band 5 16QAM 1.4MHz CH-Low 100%RB

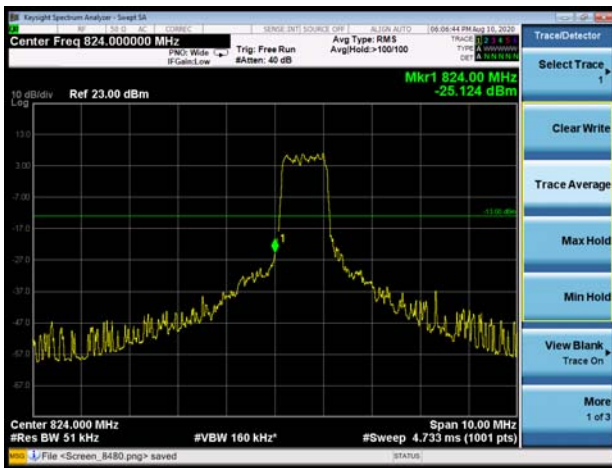

LTE Band 5 16QAM 1.4MHz CH-High 100%RB

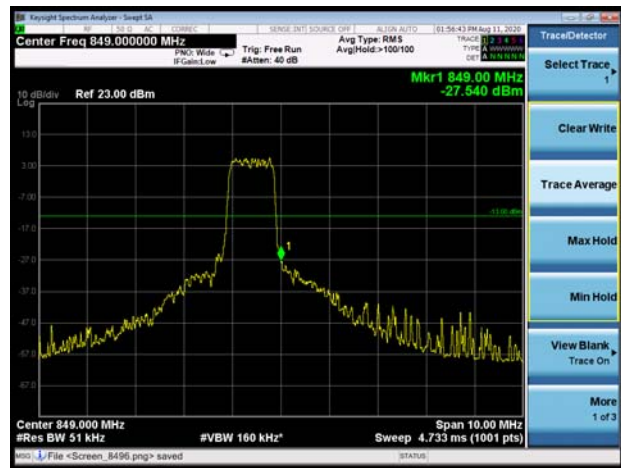

LTE Band 5 16QAM 3MHz CH-Low 1RB

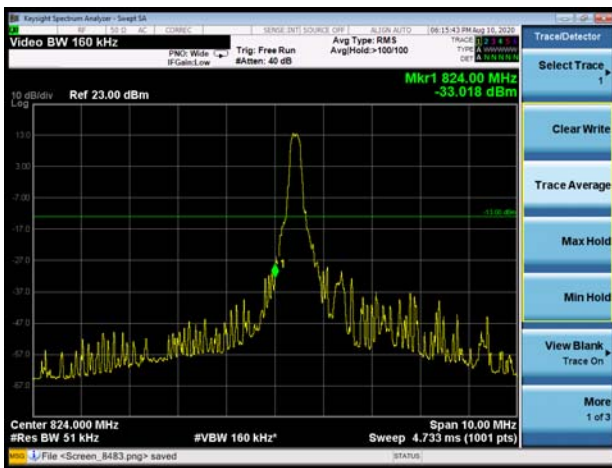

LTE Band 5 16QAM 3MHz CH-High 1RB

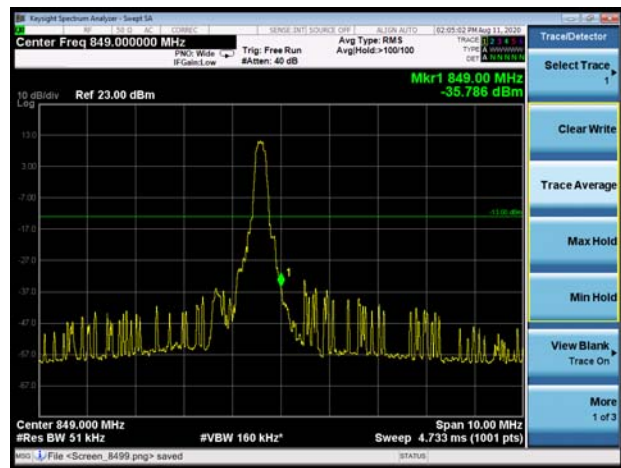

LTE Band 5 16QAM 3MHz CH-Low 100%RB

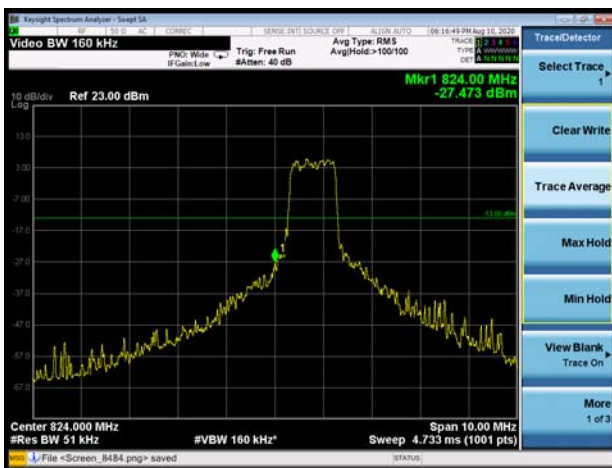

LTE Band 5 16QAM 3MHz CH-High 100%RB

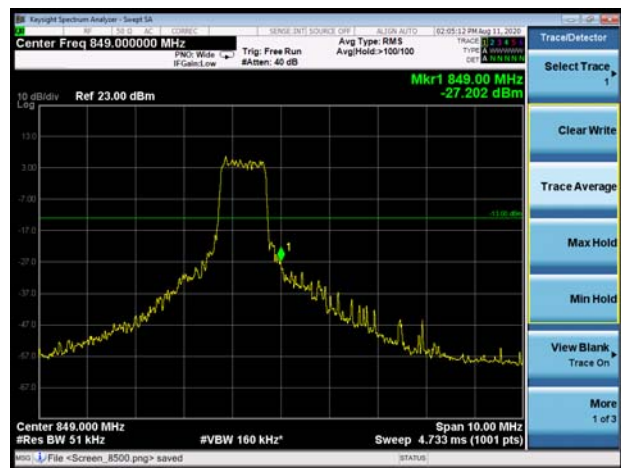

LTE Band 5 16QAM 5MHz CH-Low 1RB

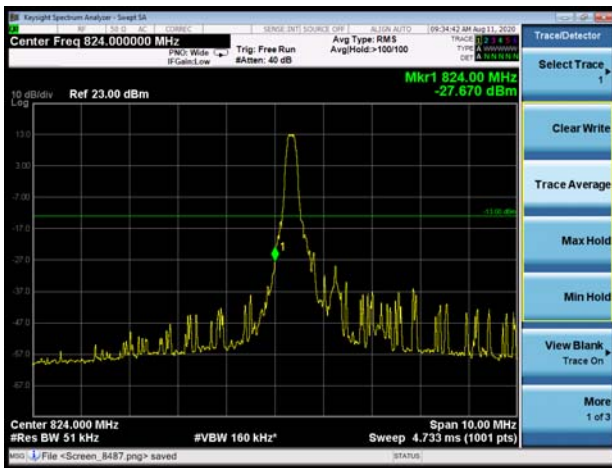

LTE Band 5 16QAM 5MHz CH-High 1RB



LTE Band 5 16QAM 5MHz CH-Low 100%RB

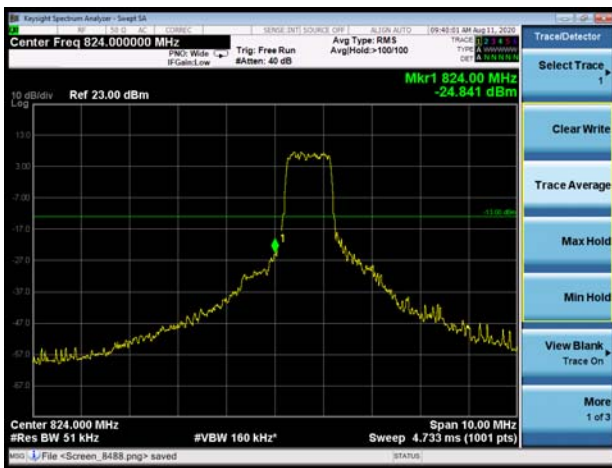

LTE Band 5 16QAM 5MHz CH-High 100%RB

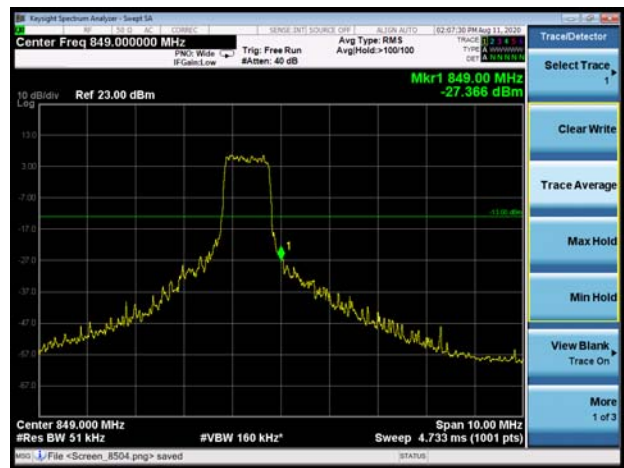

LTE Band 5 16QAM 10MHz CH-Low 1RB

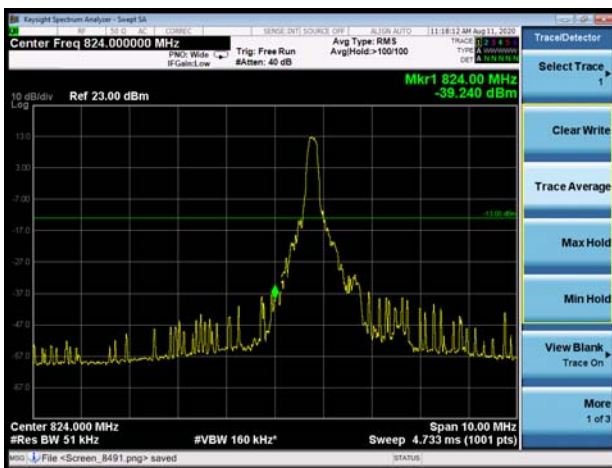

LTE Band 5 16QAM 10MHz CH-High 1RB

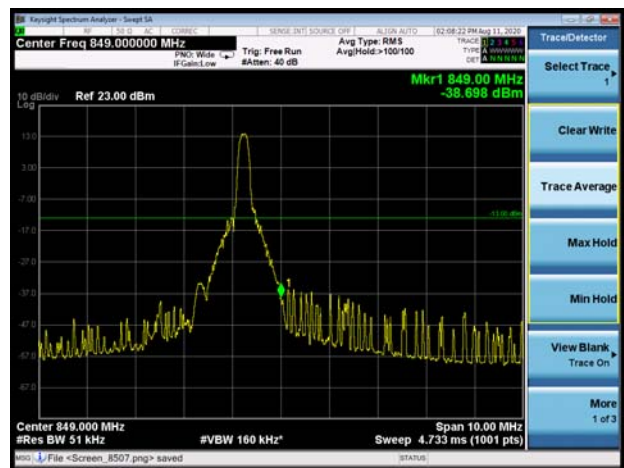

LTE Band 5 16QAM 10MHz CH-Low 100%RB

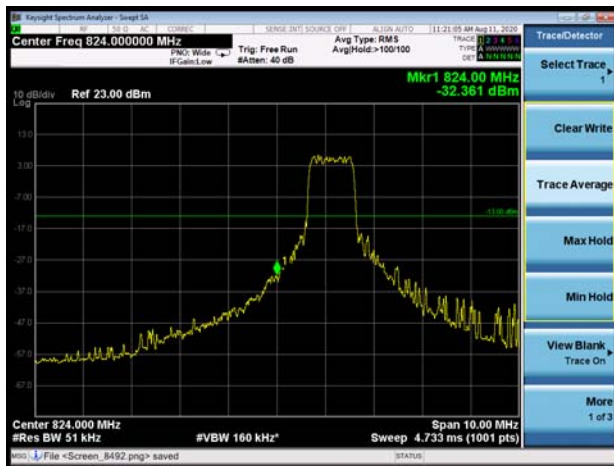

LTE Band 5 16QAM 10MHz CH-High 100%RB

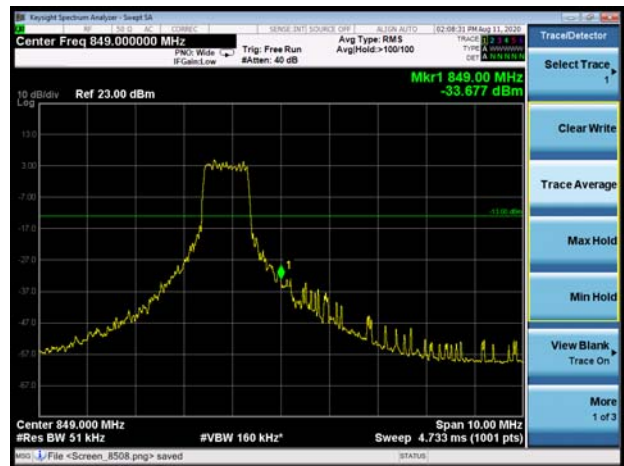

### 5.5. Peak-to-Average Power Ratio (PAPR)

#### Ambient condition

Temperature	Relative humidity	Pressure
23°C ~25°C	45%~50%	101.5kPa

#### Methods of Measurement

Measure the total peak power and record as  $P_{Pk}$ . And measure the total average power and record as  $P_{Avg}$ . Both the peak and average power levels must be expressed in the same logarithmic units (e.g., dBm). Determine the PAPR from:

$$PAPR (dB) = P_{Pk} (dBm) - P_{Avg} (dBm).$$

#### Test Setup

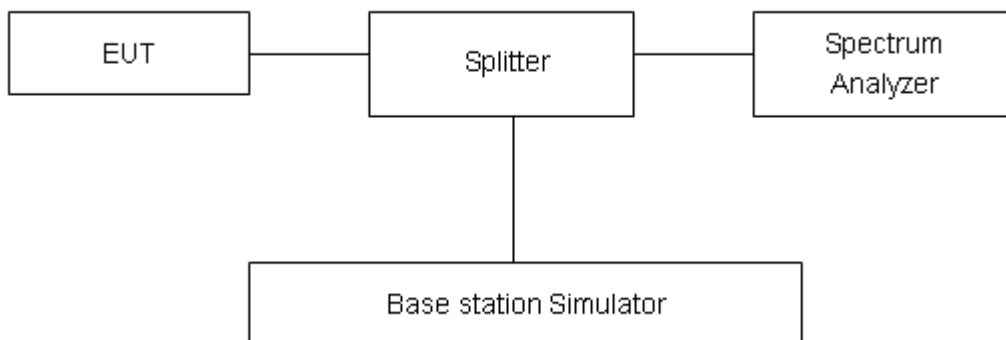

#### Limits

According to the Sec. 22.913(d), The peak-to-average ratio (PAR) of the transmission must not exceed 13 dB.

#### Measurement Uncertainty

The assessed measurement uncertainty to ensure 95% confidence level for the normal distribution is with the coverage factor  $k = 2$ ,  $U = 0.4$  dB.

**Test Results**

Mode	Channel	Frequency (MHz)	Peak (dBm)	Avg (dBm)	PAPR (dB)	Limit (dB)	Conclusion
<b>GPRS 850 (GMSK)</b>	128	824.2	30.69	30.01	0.68	≤13	PASS
	190	836.6	30.82	30.11	0.71	≤13	PASS
	251	848.8	30.92	30.28	0.64	≤13	PASS
<b>EGPRS 850 (8-PSK)</b>	128	824.2	26.84	26.05	0.79	≤13	PASS
	190	836.6	26.97	26.06	0.91	≤13	PASS
	251	848.8	27.00	26.19	0.81	≤13	PASS

Mode	Bandwidth	Modulation	Channel/ Frequency(MHz)	Peak-to-Average Power Ratio (PAPR)			Limit (dB)	Conclusion
				Peak(dBm)	Avg(dBm)	PAPR(dB)		
LTE Band5	1.4MHz	QPSK	20525/836.5	32.98	22.71	10.27	≤13	PASS
		16QAM	20525/836.5	34.24	23.20	11.04	≤13	PASS
	3MHz	QPSK	20525/836.5	32.95	22.73	10.22	≤13	PASS
		16QAM	20525/836.5	34.24	23.25	10.99	≤13	PASS
	5MHz	QPSK	20525/836.5	33.21	22.69	10.52	≤13	PASS
		16QAM	20525/836.5	34.41	23.20	11.21	≤13	PASS
	10MHz	QPSK	20525/836.5	32.60	22.64	9.96	≤13	PASS
		16QAM	20525/836.5	33.28	23.16	10.12	≤13	PASS

## 5.6. Frequency Stability

### Ambient condition

Temperature	Relative humidity	Pressure
23°C ~25°C	45%~50%	101.5kPa

### Method of Measurement

#### 1. Frequency Stability (Temperature Variation)

The temperature inside the climate chamber is varied from -40°C to +85°C in 10°C step size,

(1) With all power removed, the temperature was decreased to 0°C and permitted to stabilize for three hours.

(2) Measure the carrier frequency with the test equipment in a “call mode”. These measurements should be made within 1 minute of powering up the mobile station, to prevent significant self warming.

(3) Repeat the above measurements at 10°C increments from -40°C to +85°C. Allow at least 1.5 hours at each temperature, un-powered, before making measurements. Frequency Stability (Voltage Variation)

The frequency stability shall be measured with variation of primary supply voltage as follows:

(1) Vary primary supply voltage from 85 to 115 percent of the nominal value for other than hand carried battery equipment.

(2) For hand carried, battery powered equipment, reduce primary supply voltage to the battery-operating end point which shall be specified by the manufacturer.

This transceiver is specified to operate with an input voltage of between 3.3 V and 4.3 V, with a nominal voltage of 3.8V.

### Test setup

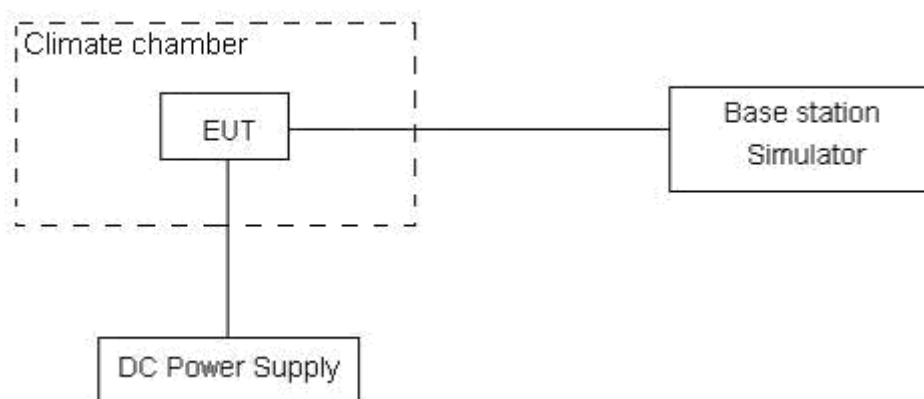

**Limits**

According to the Sec. 22.355, the frequency stability of the carrier shall be accurate to within 2.5 ppm of the received frequency for mobile stations.

Limits	$\leq 2.5$ ppm
--------	----------------

**Measurement Uncertainty**

The assessed measurement uncertainty to ensure 99.75% confidence level for the normal distribution is with the coverage factor  $k = 3$ ,  $U = 0.01$  ppm.





## Test Result

Mode	Test status	Test Results (ppm)	
		GPRS(GMSK)	EGPRS(8PSK)
GSM 850 Middle Channel	-40°C/Normal Voltage	0.0211	0.0202
	-30°C/Normal Voltage	0.0294	0.0242
	-20°C/Normal Voltage	0.0297	0.0257
	-10°C/Normal Voltage	0.0292	0.0253
	0°C/Normal Voltage	0.0301	0.0250
	10°C/Normal Voltage	0.0333	0.0241
	20°C/Normal Voltage	0.0395	0.0317
	30°C/Normal Voltage	0.0312	0.0262
	40°C/Normal Voltage	0.0343	0.0248
	50°C/Normal Voltage	0.0355	0.0288
	60°C/Normal Voltage	0.0325	0.0302
	70°C/Normal Voltage	0.0349	0.0273
	80°C/Normal Voltage	0.0350	0.0266
	85°C/Normal Voltage	0.0338	0.0279
	20°C/Minimum Voltage	0.0273	0.0234
	20°C/Maximum Voltage	0.0217	0.0208

Bandwidth	Test status	LTE Band 5 Middle Channel Test Results (ppm)	
		QPSK	16QAM
1.4MHz	-40°C/Normal Voltage	-0.00147	-0.01488
	-30°C/Normal Voltage	-0.00025	-0.01676
	-20°C/Normal Voltage	-0.00142	-0.01840
	-10°C/Normal Voltage	-0.00279	-0.01732
	0°C/Normal Voltage	-0.00198	-0.02276
	10°C/Normal Voltage	-0.00053	-0.02736
	20°C/Normal Voltage	-0.00059	-0.01711
	30°C/Normal Voltage	0.00234	-0.01736
	40°C/Normal Voltage	0.00104	-0.02404
	50°C/Normal Voltage	0.00429	-0.01883
	60°C/Normal Voltage	0.00430	-0.02723
	70°C/Normal Voltage	-0.00128	-0.02343
	80°C/Normal Voltage	-0.00143	-0.01695
	85°C/Normal Voltage	0.00212	-0.01592
	20°C/Minimum Voltage	-0.00146	-0.01522
	20°C/Maximum Voltage	0.00099	-0.02527



3MHz	-40°C/Normal Voltage	-0.00178	-0.01886
	-30°C/Normal Voltage	-0.00259	-0.01704
	-20°C/Normal Voltage	-0.00334	-0.01677
	-10°C/Normal Voltage	-0.00158	-0.02166
	0°C/Normal Voltage	-0.00031	-0.01933
	10°C/Normal Voltage	-0.00438	-0.01900
	20°C/Normal Voltage	-0.00491	-0.01522
	30°C/Normal Voltage	-0.00392	-0.00512
	40°C/Normal Voltage	-0.00197	-0.00279
	50°C/Normal Voltage	-0.00160	0.00207
	60°C/Normal Voltage	-0.00361	0.00385
	70°C/Normal Voltage	-0.00209	-0.00123
	80°C/Normal Voltage	-0.00061	0.00393
	85°C/Normal Voltage	-0.00164	0.00286
	20°C/Minimum Voltage	-0.00197	0.00123
	20°C/Maximum Voltage	0.00099	0.00146
	5MHz	-40°C/Normal Voltage	-0.00219
-30°C/Normal Voltage		-0.00092	-0.01994
-20°C/Normal Voltage		-0.00499	-0.01961
-10°C/Normal Voltage		-0.00552	-0.01583
0°C/Normal Voltage		-0.00453	-0.00573
10°C/Normal Voltage		-0.00258	-0.00340
20°C/Normal Voltage		-0.00221	0.00146
30°C/Normal Voltage		-0.00422	0.00324
40°C/Normal Voltage		-0.00056	-0.01977
50°C/Normal Voltage		-0.00463	-0.01600
60°C/Normal Voltage		-0.00516	-0.00589
70°C/Normal Voltage		-0.00417	-0.00356
80°C/Normal Voltage		-0.00222	0.00129
85°C/Normal Voltage		-0.00185	0.00307
20°C/Minimum Voltage		-0.00386	-0.02244
20°C/Maximum Voltage		-0.00183	-0.02011
10MHz		-40°C/Normal Voltage	-0.00252
	-30°C/Normal Voltage	-0.00126	0.00426
	-20°C/Normal Voltage	-0.00532	-0.00082
	-10°C/Normal Voltage	-0.00586	0.01753
	0°C/Normal Voltage	-0.00487	0.00326
	10°C/Normal Voltage	-0.00292	0.00164
	20°C/Normal Voltage	-0.00255	0.00186
	30°C/Normal Voltage	-0.00455	-0.01739



	40°C/Normal Voltage	-0.00090	-0.01339
	50°C/Normal Voltage	-0.00496	-0.01176
	60°C/Normal Voltage	-0.00550	-0.01542
	70°C/Normal Voltage	-0.00243	-0.00532
	80°C/Normal Voltage	-0.00094	-0.00299
	85°C/Normal Voltage	-0.00197	0.00186
	20°C/Minimum Voltage	-0.00231	0.00365
	20°C/Maximum Voltage	0.00066	-0.01578

### 5.7. Spurious Emissions at Antenna Terminals

#### Ambient condition

Temperature	Relative humidity	Pressure
23°C ~25°C	45%~50%	101.5kPa

#### Method of Measurement

The EUT was connected to Spectrum Analyzer and Base Station Simulator via power Splitter. The measurement is carried out using a spectrum analyzer. The spectrum analyzer scans from 9kHz to the 10th harmonic of the carrier.

The peak detector is used. RBW are set to 100 kHz and VBW are set to 300 kHz for below 1G, RBW are set to 1MHz and VBW are set to 3MHz for above 1G, Sweep is set to ATUO.

#### Test setup

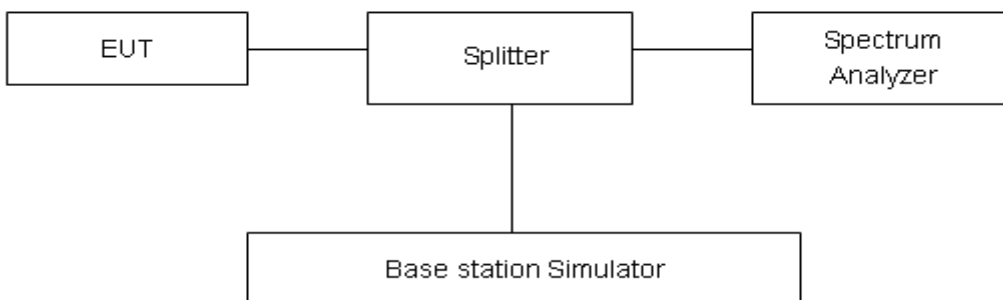

#### Limits

Rule Part 22.917(a) specifies that “The power of any emission outside of the authorized operating frequency ranges must be attenuated below the transmitting power (P) by a factor of at least 43 + 10 log (P) dB.”

Limit	-13 dBm
-------	---------

#### Measurement Uncertainty

The assessed measurement uncertainty to ensure 99.75% confidence level for the normal distribution is with the coverage factor  $k = 1.96$ .

Frequency	Uncertainty
100kHz-2GHz	0.684 dB
2GHz-12.75GHz	1.407 dB

**Test Result**

Sweep from 9 kHz to 30MHz, and the emissions more than 20 dB below the permissible value are not reported.

If disturbances were found more than 20dB below limit line, the mark is not required for the EUT. The signal beyond the limit is carrier.

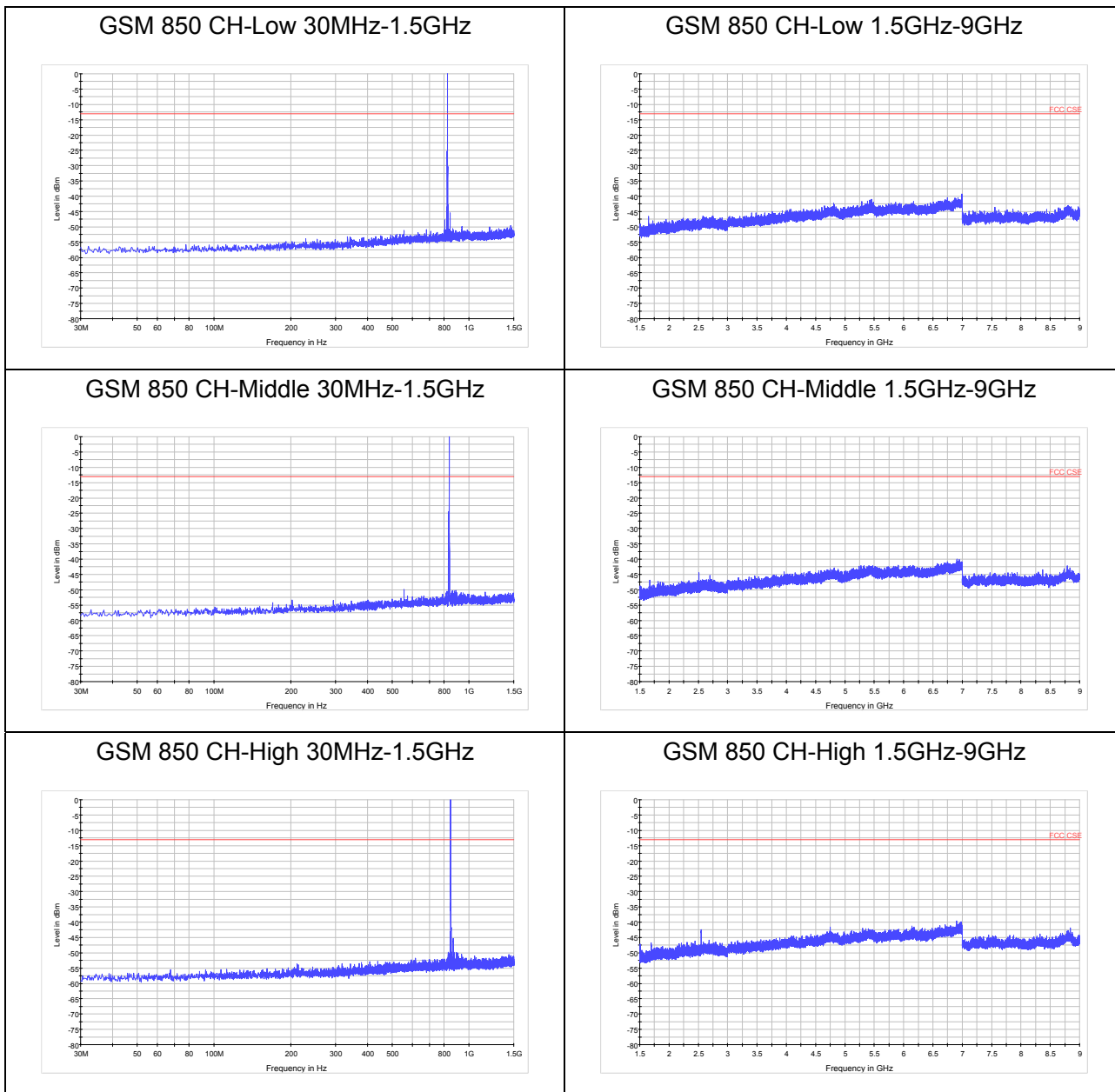



LTE Band 5 1.4MHz CH-Low 30MHz-1.5GHz

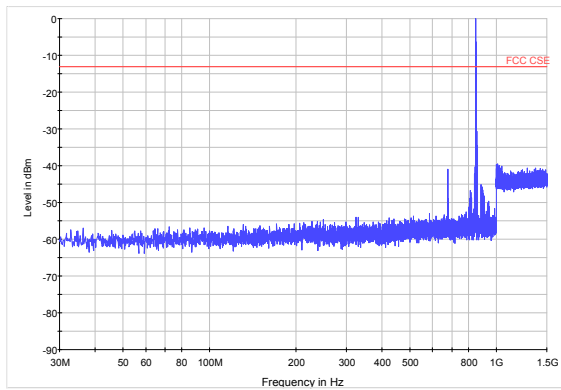

LTE Band 5 1.4MHz CH-Low 1.5GHz-9GHz

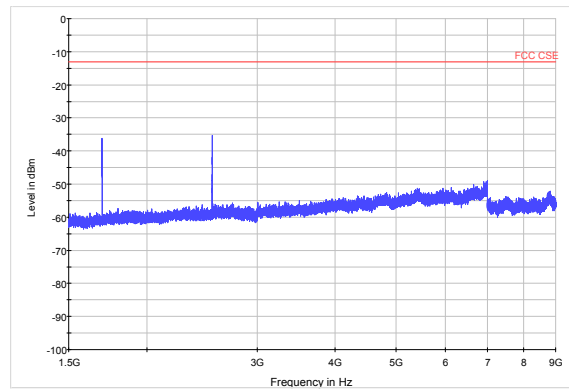

LTE Band 5 1.4MHz CH-Middle 30MHz-1.5GHz

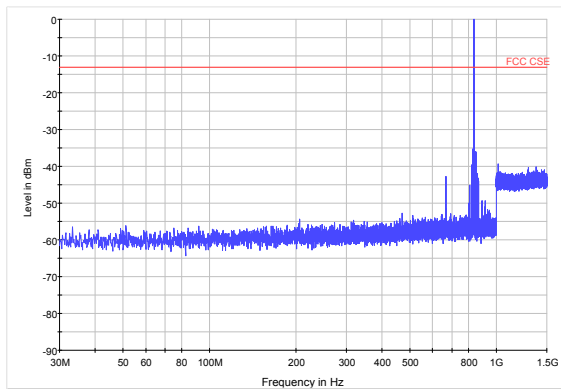

LTE Band 5 1.4MHz CH-Middle 1.5GHz-9GHz

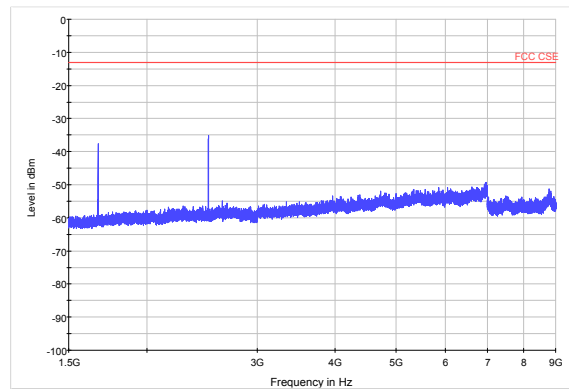

LTE Band 5 1.4MHz CH-High 30MHz-1.5GHz

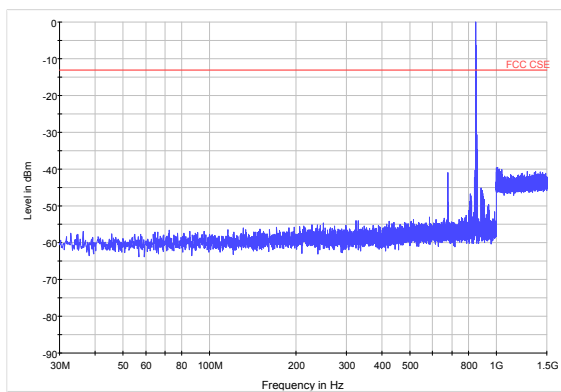

LTE Band 5 1.4MHz CH-High 1.5GHz-9GHz z

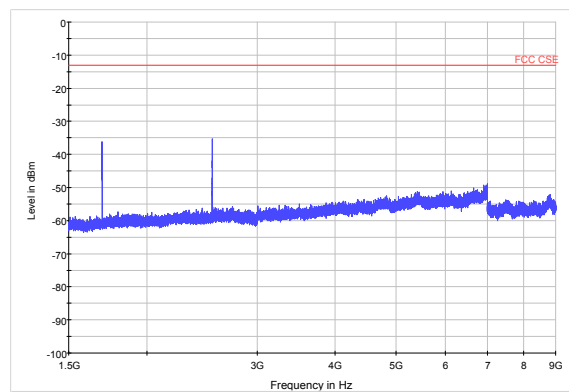



LTE Band 5 3MHz CH-Low 30MHz-1.5GHz

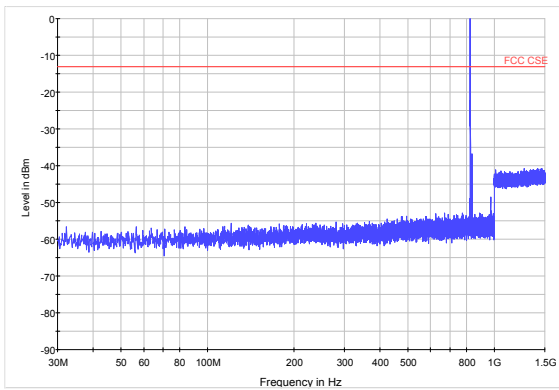

LTE Band 5 3MHz CH-Low 1.5GHz-9GHz z

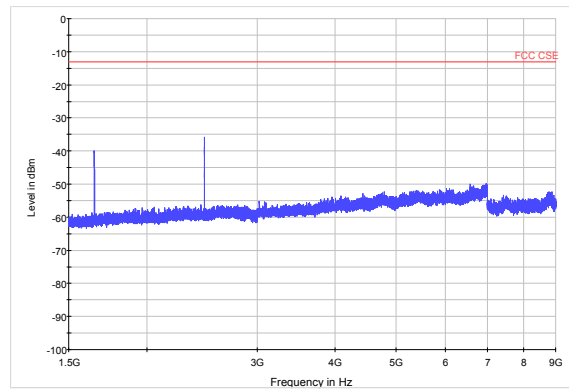

LTE Band 5 3MHz CH-Middle 30MHz-1.5GHz

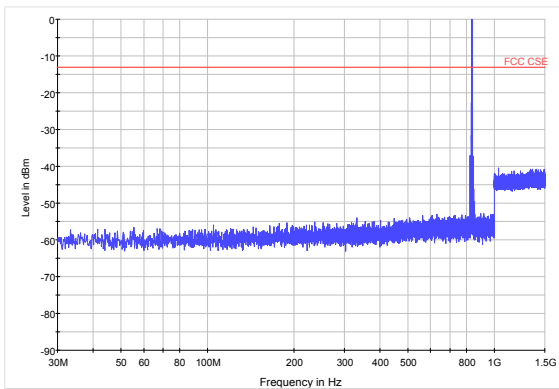

LTE Band 5 3MHz CH-Middle 1.5GHz-9GHz

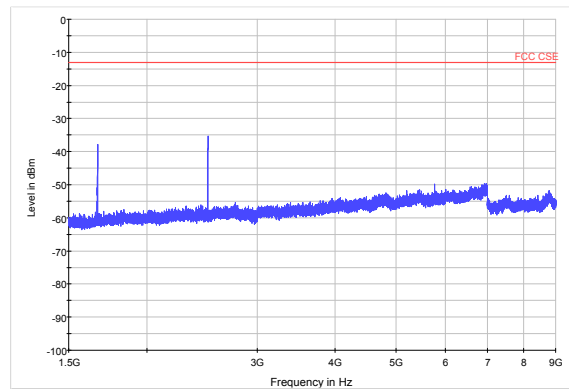

LTE Band 5 3MHz CH-High 30MHz-1.5GHz

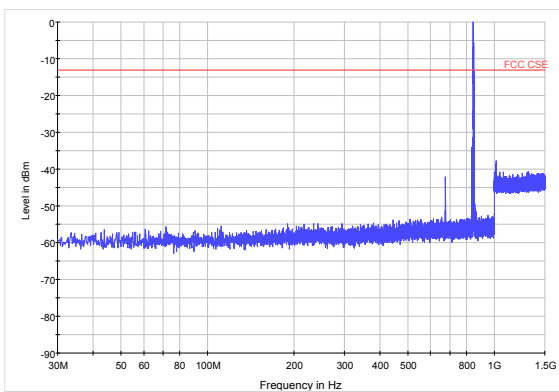

LTE Band 5 3MHz CH-High 1.5GHz-9GHz

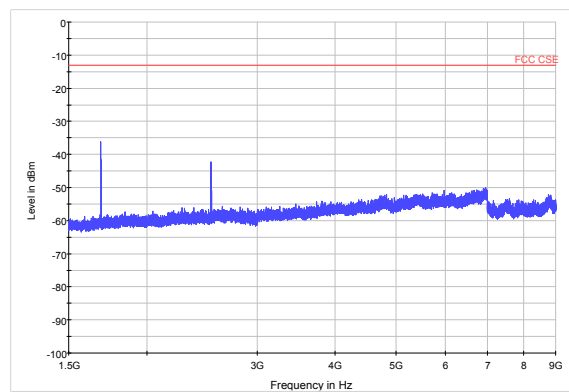



LTE Band 5 5MHz CH-Low 30MHz-1.5GHz

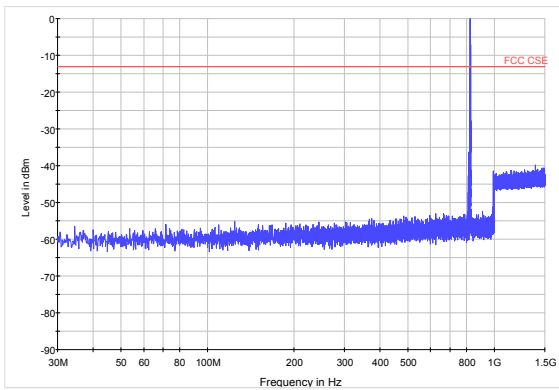

LTE Band 5 5MHz CH-Low 1.5GHz-9GHz

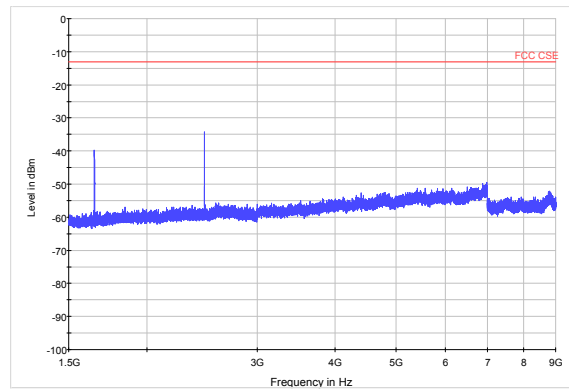

LTE Band 5 5MHz CH-Middle 30MHz-1.5GHz

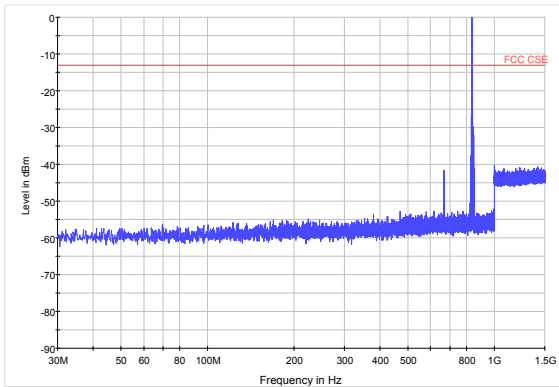

LTE Band 5 5MHz CH-Middle 1.5GHz-9GHz

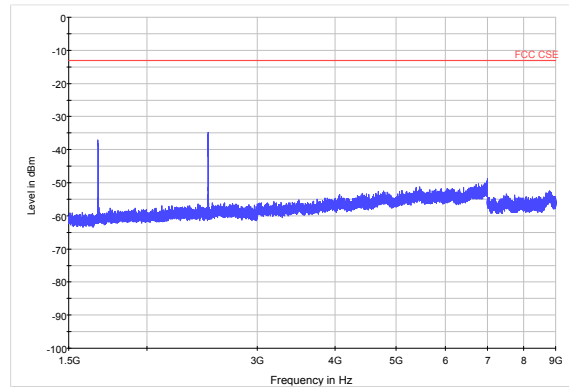

LTE Band 5 5MHz CH-High 30MHz-1.5GHz

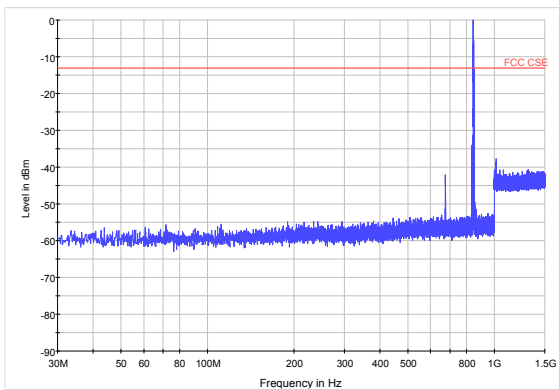

LTE Band 5 5MHz CH-High 1.5GHz-9GHz

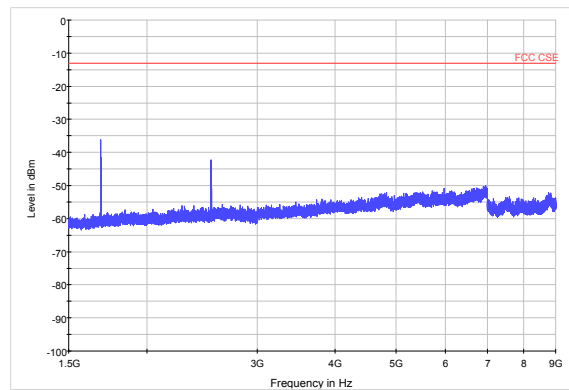





LTE Band 5 10MHz CH-Low 30MHz-1.5GHz

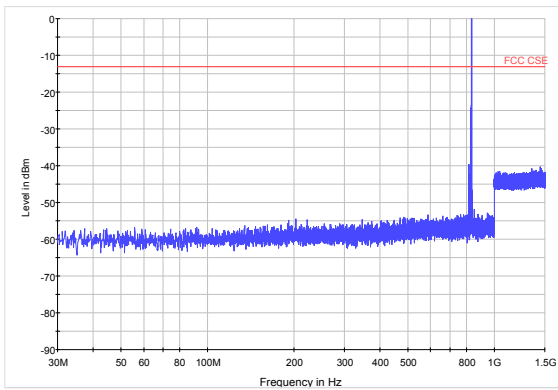

LTE Band 5 10MHz CH-Low 1.5GHz-9GHz

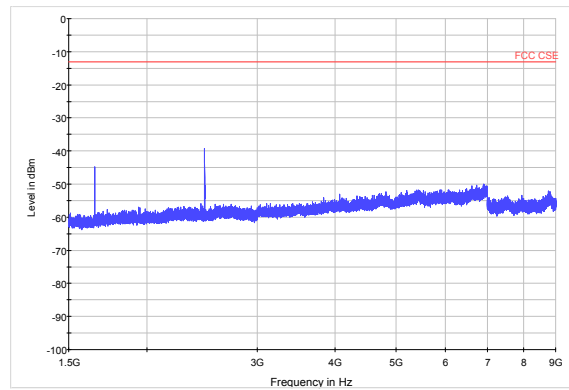

LTE Band 5 10MHz CH-Middle 30MHz-1.5GHz

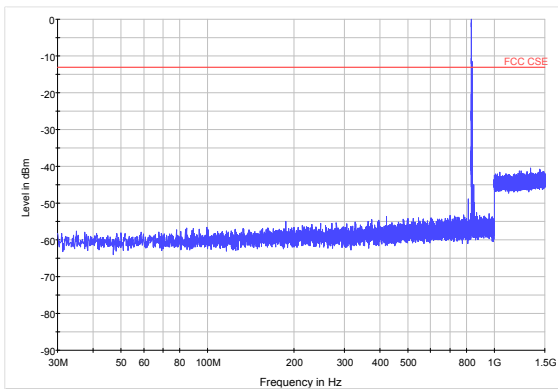

LTE Band 5 10MHz CH-Middle 1.5GHz-9GHz

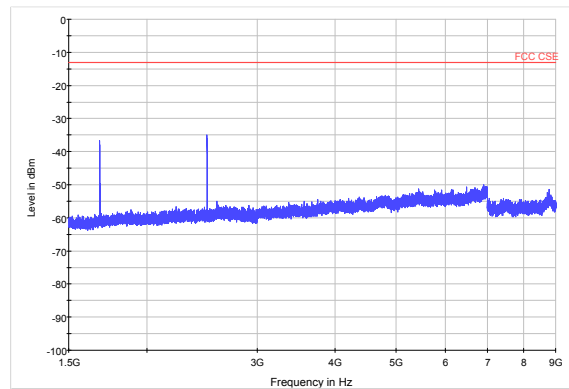

LTE Band 5 10MHz CH-High 30MHz-1.5GHz

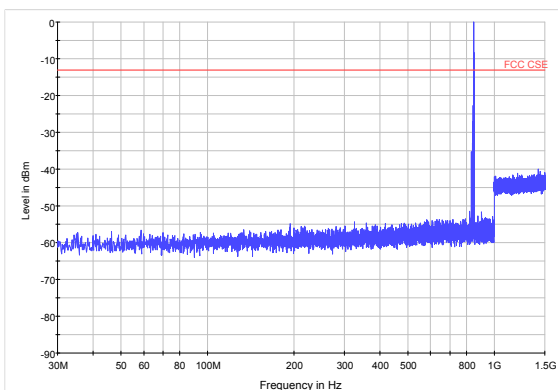

LTE Band 5 10MHz CH-High 1.5GHz-9GHz

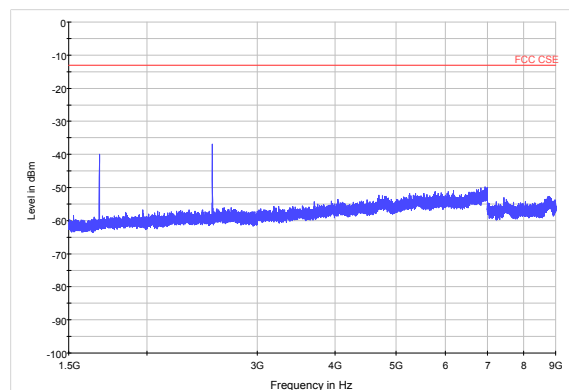

## 5.8. Radiates Spurious Emission

### Ambient condition

Temperature	Relative humidity	Pressure
23°C ~25°C	45%~50%	101.5kPa

### Method of Measurement

1. The testing follows FCC KDB 971168 v03r01 Section 5.8 and ANSI C63.26 (2015).
2. Below 1GHz: The EUT is placed on a turntable 0.8 meters above the ground in the chamber, 3 meter away from the antenna. The maximal emission value is acquired by adjusting the antenna height, polarisation and turntable azimuth. Normally, the height range of antenna is 1 m to 4 m, the azimuth range of turntable is 0° to 360°, and the receive antenna has two polarizations Vertical (V) and Horizontal (H). Above 1GHz: (Note: the FCC's permission to use 1.5m as an alternative per TCBC Conf call of Dec. 2, 2014.) The EUT is placed on a turntable 1.5 meters above the ground in the chamber, 3 meter away from the antenna. The maximal emission value is acquired by adjusting the antenna height, polarisation and turntable azimuth. Normally, the height range of antenna is 1 m to 4 m, the azimuth range of turntable is 0° to 360°, and the receive antenna has two polarizations Vertical (V) and Horizontal (H).
3. A loop antenna, A log-periodic antenna or horn antenna shall be substituted in place of the EUT. The log-periodic antenna will be driven by a signal generator and the level will be adjusted till the same power value on the spectrum analyzer or receiver. The level of the spurious emissions can be calculated through the level of the signal generator, cable loss, the gain of the substitution antenna and the reading of the spectrum analyzer or receiver.
4. The EUT is then put into continuously transmitting mode at its maximum power level during the test. Set Test Receiver or Spectrum RBW=200Hz,VBW=600Hz for 9kHz150kHz , RBW=10kHz, VBW=30kHz 150kHz-30MHz , RBW=100kHz,VBW=300kHz for 30MHz to 1GHz and RBW=1MHz, VBW=3MHz for above 1GHz, And the maximum value of the receiver should be recorded as (Pr).
5. The EUT shall be replaced by a substitution antenna. In the chamber, an substitution antenna for the frequency band of interest is placed at the reference point of the chamber. An RF Signal source for the frequency band of interest is connected to the substitution antenna with a cable that has been constructed to not interfere with the radiation pattern of the antenna. A power (PMea) is applied to the input of the substitution antenna, and adjust the level of the signal generator output until the value of the receiver reach the previously recorded (Pr). The power of signal source (PMea) is recorded. The test should be performed by rotating the test item and adjusting the receiving antenna polarization.
6. A amplifier should be connected to the Signal Source output port. And the cable should be connect between the Amplifier and the Substitution Antenna. The cable loss (Pcl) ,the Substitution Antenna Gain (Ga) and the Amplifier Gain (PAg) should be recorded after test.
7. The measurement results are obtained as described below:  
Power(EIRP)=PMea- PAg - Pcl + Ga  
The measurement results are amend as described below:  
Power(EIRP)=PMea- Pcl + Ga
8. This value is EIRP since the measurement is calibrated using an antenna of known gain (2.15 dBi)

and known input power. ERP can be calculated from EIRP by subtracting the gain of the dipole,  $ERP = EIRP - 2.15\text{dBi}$ .

The modulation mode and RB allocation refer to section 5.1, using the maximum output power configuration.

**Test setup**

**9KHz ~ 30MHz**

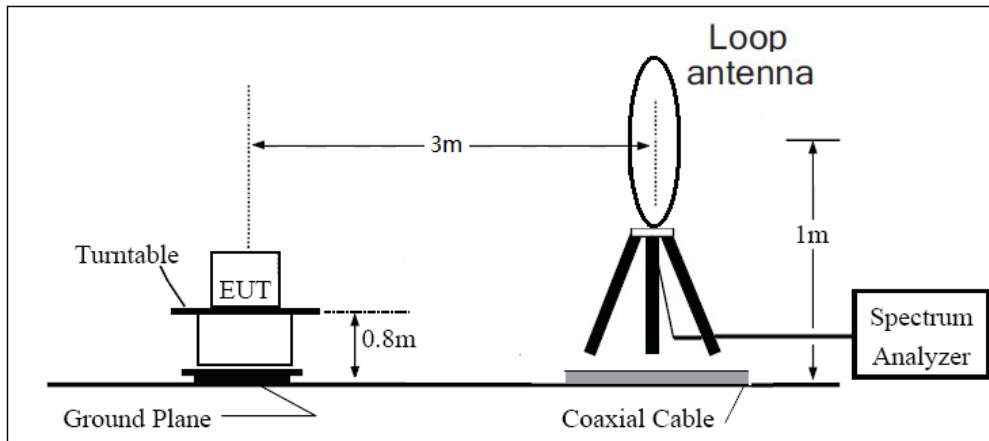

**30MHz ~ 1GHz**

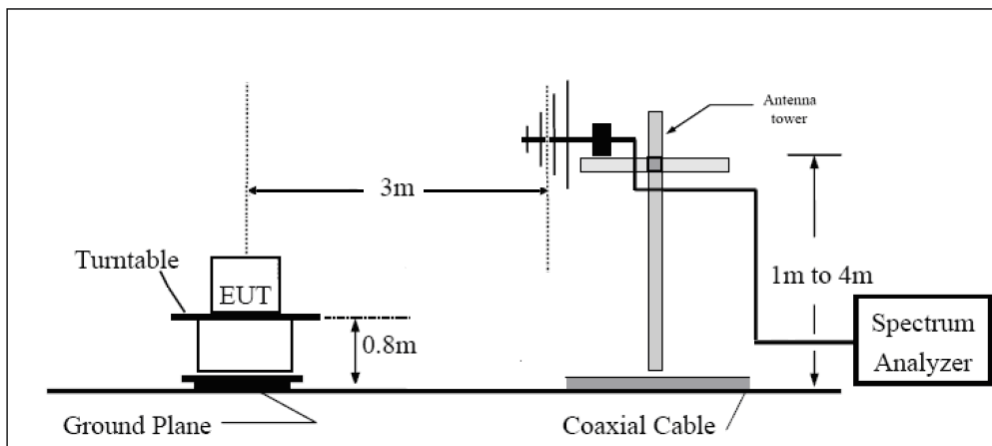

**Above 1GHz**

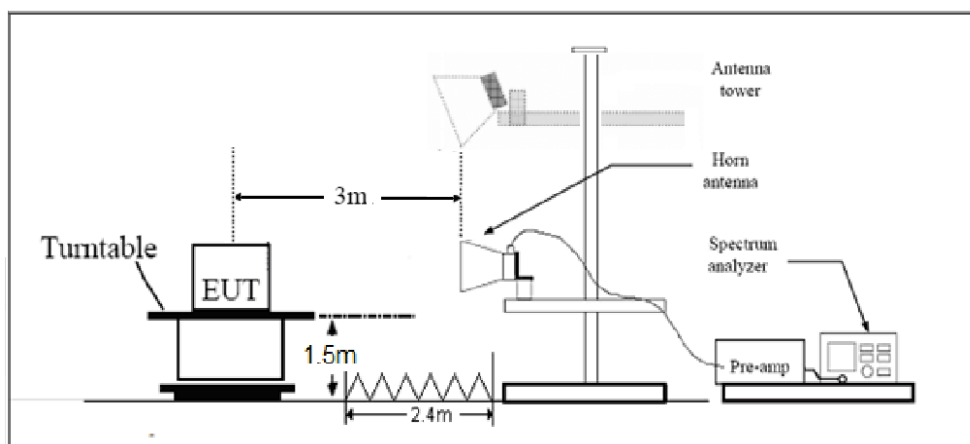

Note: Area side: 2.4mX3.6m

**Limits**

Rule Part 22.917(a) specifies that “The power of any emission outside of the authorized operating frequency ranges must be attenuated below the transmitting power (P) by a factor of at least  $43 + 10 \log (P)$  dB.”

Limit	-13 dBm
-------	---------

**Measurement Uncertainty**

The assessed measurement uncertainty to ensure 95% confidence level for the normal distribution is with the coverage factor  $k = 1.96$ ,  $U = 3.55$  dB.

**Test Result**

## GSM 850 CH-Low

Harmonic	Frequency (MHz)	SG (dBm)	Cable Loss (dB)	Gain (dBi)	Antenna Polarization	ERP Level (dBm)	Limit (dBm)	Margin (dB)	Azimuth (deg)
2	1648	-56.00	2	10.15	Vertical	-50.0	-13.0	37.0	45
3	2473	-56.69	2.51	11.35	Vertical	-50.0	-13.0	37.0	180
4	3297	-54.60	4.2	10.85	Vertical	-50.1	-13.0	37.1	180
5	4121	-53.30	5.2	11.35	Vertical	-49.3	-13.0	36.3	225
6	4945	-52.00	5.5	11.95	Vertical	-47.7	-13.0	34.7	135
7	5769	-52.30	5.7	13.55	Vertical	-46.6	-13.0	33.6	135
8	6594	-48.40	6.3	13.75	Vertical	-43.1	-13.0	30.1	45
9	7418	-46.30	6.8	13.85	Vertical	-41.4	-13.0	28.4	180
10	8242	-46.40	6.9	14.25	Vertical	-41.2	-13.0	28.2	270

Note: 1.The other Spurious RF Radiated emissions level is no more than noise floor.  
2.The worst emission was found in the antenna is vertical position.

## GSM 850 CH-Middle

Harmonic	Frequency (MHz)	SG (dBm)	Cable Loss (dB)	Gain (dBi)	Antenna Polarization	ERP Level (dBm)	Limit (dBm)	Margin (dB)	Azimuth (deg)
2	1673	-53.6	2	10.75	Vertical	-47.0	-13.0	34.0	225
3	2498	-55.49	2.51	11.05	Vertical	-49.1	-13.0	36.1	135
4	3346	-56.6	4.2	11.15	Vertical	-51.8	-13.0	38.8	135
5	4183	-53	5.2	11.15	Vertical	-49.2	-13.0	36.2	45
6	5020	-50.4	5.5	11.95	Vertical	-46.1	-13.0	33.1	270
7	5856	-51	5.7	13.55	Vertical	-45.3	-13.0	32.3	180
8	6693	-49.6	6.3	13.75	Vertical	-44.3	-13.0	31.3	270
9	7529	-46.9	6.8	13.85	Vertical	-42.0	-13.0	29.0	135
10	8366	-47	6.9	14.25	Vertical	-41.8	-13.0	28.8	45

Note: 1.The other Spurious RF Radiated emissions level is no more than noise floor.  
2.The worst emission was found in the antenna is vertical position.



## GSM 850 CH-High

Harmonic	Frequency (MHz)	SG (dBm)	Cable Loss (dB)	Gain (dBi)	Antenna Polarization	ERP Level (dBm)	Limit (dBm)	Margin (dB)	Azimuth (deg)
2	1698	-58.4	2	10.15	Vertical	-52.4	-13.0	39.4	90
3	2546	-57.49	2.51	11.05	Vertical	-51.1	-13.0	38.1	45
4	3395	-57.7	4.2	11.15	Vertical	-52.9	-13.0	39.9	180
5	4244	-53.7	5.2	11.15	Vertical	-49.9	-13.0	36.9	270
6	5093	-50.7	5.5	11.95	Vertical	-46.4	-13.0	33.4	135
7	5942	-51.6	5.7	13.55	Vertical	-45.9	-13.0	32.9	45
8	6790	-49.6	6.3	13.75	Vertical	-44.3	-13.0	31.3	270
9	7639	-46.9	6.8	13.85	Vertical	-42.0	-13.0	29.0	180
10	8488	-46.4	6.9	14.25	Vertical	-41.2	-13.0	28.2	270

Note: 1.The other Spurious RF Radiated emissions level is no more than noise floor.

2.The worst emission was found in the antenna is vertical position.

## LTE Band 5 10MHz CH-Low

Harmonic	Frequency (MHz)	SG (dBm)	Cable Loss (dB)	Gain (dBi)	Antenna Polarization	ERP Level (dBm)	Limit (dBm)	Margin (dB)	Azimuth (deg)
2	1658.0	-51.4	2.00	10.75	vertical	-44.8	-13.0	31.8	135
3	2487.0	-50.89	2.51	11.05	vertical	-44.5	-13.0	31.5	225
4	3316.0	-53.7	4.20	11.15	vertical	-48.9	-13.0	35.9	90
5	4145.0	-52.7	5.20	11.15	vertical	-48.9	-13.0	35.9	45
6	4974.0	-51.9	5.50	11.95	vertical	-47.6	-13.0	34.6	180
7	5803.0	-50.2	5.70	13.55	vertical	-44.5	-13.0	31.5	45
8	6632.0	-48.9	6.30	13.75	vertical	-43.6	-13.0	30.6	0
9	7461.0	-47.3	6.80	13.85	vertical	-42.4	-13.0	29.4	135
10	8290.0	-47.8	6.90	14.25	vertical	-42.6	-13.0	29.6	45

Note: 1.The other Spurious RF Radiated emissions level is no more than noise floor.

2.The worst emission was found in the antenna is vertical position.



## LTE Band 5 10MHz CH-Middle

Harmonic	Frequency (MHz)	SG (dBm)	Cable Loss (dB)	Gain (dBi)	Antenna Polarization	ERP Level (dBm)	Limit (dBm)	Margin (dB)	Azimuth (deg)
2	1673.0	-51.1	2.00	10.75	vertical	-44.5	-13.0	31.5	0
3	2509.5	-54.39	2.51	11.05	vertical	-48.0	-13.0	35.0	135
4	3346.0	-53.8	4.20	11.15	vertical	-49.0	-13.0	36.0	225
5	4182.5	-52.4	5.20	11.15	vertical	-48.6	-13.0	35.6	90
6	5019.0	-49.7	5.50	11.95	vertical	-45.4	-13.0	32.4	45
7	5855.5	-51.3	5.70	13.55	vertical	-45.6	-13.0	32.6	180
8	6692.0	-48.5	6.30	13.75	vertical	-43.2	-13.0	30.2	45
9	7528.5	-46.4	6.80	13.85	vertical	-41.5	-13.0	28.5	0
10	8365.0	-48	6.90	14.25	vertical	-42.8	-13.0	29.8	45

Note: 1.The other Spurious RF Radiated emissions level is no more than noise floor.

2.The worst emission was found in the antenna is vertical position.



## LTE Band 5 10MHz CH-High

Harmonic	Frequency (MHz)	SG (dBm)	Cable Loss (dB)	Gain (dBi)	Antenna Polarization	ERP Level (dBm)	Limit (dBm)	Margin (dB)	Azimuth (deg)
2	1688.0	-47.7	2.00	10.75	vertical	-41.1	-13.0	28.1	0
3	2532.0	-52.79	2.51	11.05	vertical	-46.4	-13.0	33.4	135
4	3376.0	-52.4	4.20	11.15	vertical	-47.6	-13.0	34.6	225
5	4220.0	-52.1	5.20	11.15	vertical	-48.3	-13.0	35.3	90
6	5064.0	-49.9	5.50	11.95	vertical	-45.6	-13.0	32.6	45
7	5908.0	-51.5	5.70	13.55	vertical	-45.8	-13.0	32.8	180
8	6752.0	-49.2	6.30	13.75	vertical	-43.9	-13.0	30.9	45
9	7596.0	-46.9	6.80	13.85	vertical	-42.0	-13.0	29.0	0
10	8440.0	-48.2	6.90	14.25	vertical	-43.0	-13.0	30.0	135

Note: 1.The other Spurious RF Radiated emissions level is no more than noise floor.

2.The worst emission was found in the antenna is vertical position.



## 6. Main Test Instruments

Date of Testing: June 24, 2017~July 3, 2017

Name	Manufacturer	Type	Serial Number	Calibration Date	Expiration Time
Base Station Simulator	R&S	CMW500	150415	2017-05-14	2018-05-13
Power Splitter	Hua Xiang	SHX-GF2-2-13	10120101	2017-05-14	2018-05-13
Spectrum Analyzer	Agilent	N9010A	MY47191109	2017-05-20	2018-05-19
Universal Radio Communication Tester	Agilent	E5515C	MY48367192	2017-05-20	2018-05-19
Signal Analyzer	R&S	FSV30	100815	2016-12-16	2017-12-15
EMI Test Receiver	R&S	ESCI	100948	2017-05-20	2018-05-19
Signal generator	R&S	SMB 100A	102594	2017-05-14	2018-05-13
Signal generator	R&S	SMR27	100365	2017-05-14	2018-05-13
Trilog Antenna	SCHWARZBEC K	VUBL 9163	9163-201	2014-12-06	2017-12-05
Horn Antenna	R&S	HF907	100126	2014-12-06	2017-12-05
Horn Antenna	ETS-Lindgren	3160-09	00102644	2015-01-30	2018-01-29
Climatic Chamber	Re Ce	PT-30B	20101891	2015-07-18	2018-07-17
RF Cable	Agilent	SMA 15cm	0001	2017-02-06	2017-08-05
Preampfier	R&S	SCU18	102327	2017-06-18	2018-06-17



Date of Testing: August10, 2020 ~ August12, 2020

Name	Manufacturer	Type	Serial Number	Calibration Date	Expiration Date
Base Station Simulator	R&S	CMW500	113824	2020-05-18	2021-05-17
Power Splitter	Hua Xiang	SHX-GF2-2-13	10120101	/	/
Spectrum Analyzer	Key sight	N9010A	MY50210259	2020-05-18	2021-05-17
Universal Radio Communication Tester	Key sight	E5515C	MY48367192	2020-05-27	2021-05-26
Signal Analyzer	R&S	FSV30	100815	2019-12-15	2020-12-14
Loop Antenna	SCHWARZBECK	FMZB1519	1519-047	2017-09-26	2020-09-25
Trilog Antenna	SCHWARZBECK	VUBL 9163	9163-201	2017-11-18	2020-11-17
Horn Antenna	R&S	HF907	102723	2018-08-11	2021-08-10
Horn Antenna	ETS-Lindgren	3160-09	00102643	2018-06-20	2021-06-19
Signal generator	R&S	SMB 100A	102594	2020-05-18	2021-05-17
Climatic Chamber	ESPEC	SU-242	93000506	2017-12-17	2020-12-16
Preamplifier	R&S	SCU18	102327	2020-05-18	2021-05-17
MOB COMMS DC SUPPLY	Keysight	66319D	MY43004105	2020-05-18	2021-05-17
RF Cable	Agilent	SMA 15cm	0001	2020-06-12	2020-12-11
Software	R&S	EMC32	9.26.0	/	/

\*\*\*\*\*END OF REPORT \*\*\*\*\*