



Test Report No.: RF2309WDG0199-1



TEST REPORT



Applicant	Particle Industries, Inc
Address	325 9th St, San Francisco, CA 94103 USA,415-319-1553

Manufacturer or Supplier	Particle Industries,Inc
Address	325 9th St, San Francisco, CA 94103 USA,415-319-1553
Product	Montior One DE
Brand Name	Particle
Model	MON404-DE
Additional Model & Model Difference	N/A
Date of tests	Oct. 11, 2023 ~ Oct. 31, 2023

The tests have been carried out according to the requirements of the following standard:

FCC Part 15, Subpart C, Section 15.247

CONCLUSION: The submitted sample was found to COMPLY with the test requirement

Tested by Lucas Chen Project Engineer / EMC Department	Approved by Glyn He Assistant Manager / EMC Department
	 Date: Nov. 20, 2023

This report is governed by, and incorporates by reference, the Conditions of Testing as posted at the date of issuance of this report at <http://www.bureauveritas.com/home/about-us/our-business/cps/about-us/terms-conditions/> and is intended for your exclusive use. Any copying or replication of this report to or for any other person or entity, or use of our name or trademark, is permitted only with our prior written permission. This report sets forth our findings solely with respect to the test samples identified herein. The results set forth in this report are not indicative or representative of the quality or characteristics of the lot from which a test sample was taken or any similar or identical product unless specifically and expressly noted. Our report includes all of the tests requested by you and the results thereof based upon the information that you provided to us. Measurement uncertainty is only provided upon request for accredited tests. Statements of conformity are based on simple acceptance criteria without taking measurement uncertainty into account, unless otherwise requested in writing. You have 60 days from date of issuance of this report to notify us of any material error or omission caused by our negligence or if you require measurement uncertainty; provided, however, that such notice shall be in writing and shall specifically address the issue you wish to raise. A failure to raise such issue within the prescribed time shall constitute your unqualified acceptance of the completeness of this report, the tests conducted and the correctness of the report contents.

TABLE OF CONTENTS

RELEASE CONTROL RECORD	4
1 SUMMARY OF TEST RESULTS.....	5
2 MEASUREMENT UNCERTAINTY	5
3 GENERAL INFORMATION	6
3.1 GENERAL DESCRIPTION OF EUT.....	6
3.2 DESCRIPTION OF TEST MODES.....	8
3.2.1 CONFIGURATION OF SYSTEM UNDER TEST	9
3.2.2 TEST MODE APPLICABILITY AND TESTED CHANNEL DETAIL.....	9
3.3 GENERAL DESCRIPTION OF APPLIED STANDARDS.....	11
3.4 DESCRIPTION OF SUPPORT UNITS.....	11
3.5 CONFIGURATION OF SYSTEM UNDER TEST.....	12
3.6 DUTY CYCLE OF TEST SIGNAL	13
4 TEST TYPES AND RESULTS.....	14
4.1. CONDUCTED EMISSION MEASUREMENT	14
4.1.1 LIMITS OF CONDUCTED EMISSION MEASUREMENT	14
4.1.2 TEST INSTRUMENTS.....	14
4.1.3 TEST PROCEDURES	15
4.1.4 DEVIATION FROM TEST STANDARD	15
4.1.5 TEST SETUP	16
4.1.6 EUT OPERATING CONDITIONS	16
4.1.7 TEST RESULTS	17
4.2. RADIATED EMISSION MEASUREMENT	19
4.2.1 LIMITS OF RADIATED EMISSION MEASUREMENT	19
4.2.2 TEST INSTRUMENTS.....	20
4.2.3 TEST PROCEDURES	21
4.2.4 DEVIATION FROM TEST STANDARD	21
4.2.5 TEST SETUP	22
4.2.6 EUT OPERATING CONDITIONS	23
4.2.7 TEST RESULTS	24
4.3 6DB BANDWIDTH MEASUREMENT.....	38
4.3.1 LIMITS OF 6DB BANDWIDTH MEASUREMENT	38
4.3.2 TEST INSTRUMENTS.....	38
4.3.3 TEST PROCEDURE.....	38



Test Report No.: RF2309WDG0199-1

4.3.4	DEVIATION FROM TEST STANDARD	39
4.3.5	TEST SETUP	39
4.3.6	EUT OPERATING CONDITIONS	39
4.3.7	TEST RESULTS	40
4.4	CONDUCTED OUTPUT POWER	45
4.4.1	LIMITS OF CONDUCTED OUTPUT POWER MEASUREMENT	45
4.4.2	TEST SETUP	45
4.4.3	TEST INSTRUMENTS.....	45
4.4.4	TEST PROCEDURES	46
4.4.5	DEVIATION FROM TEST STANDARD	46
4.4.6	EUT OPERATING CONDITIONS	46
4.4.7	TEST RESULTS	47
4.5	POWER SPECTRAL DENSITY MEASUREMENT	49
4.5.1	LIMITS OF POWER SPECTRAL DENSITY MEASUREMENT	49
4.5.2	TEST SETUP	49
4.5.3	TEST INSTRUMENTS.....	49
4.5.4	TEST PROCEDURE	49
4.5.5	DEVIATION FROM TEST STANDARD	49
4.5.6	EUT OPERATING CONDITION	50
4.5.7	TEST RESULTS	50
4.6	OUT OF BAND EMISSION MEASUREMENT	52
4.6.1	LIMITS OF OUT OF BAND EMISSION MEASUREMENT	52
4.6.2	TEST SETUP	52
4.6.3	TEST INSTRUMENTS.....	52
4.6.4	TEST PROCEDURE	52
4.6.5	DEVIATION FROM TEST STANDARD	53
4.6.6	EUT OPERATING CONDITION	53
4.6.7	TEST RESULTS	54
5	PHOTOGRAPHS OF THE TEST CONFIGURATION	60
6	APPENDIX A - MODIFICATIONS RECORDERS FOR ENGINEERING CHANGES TO THE EUT BY THE LAB	61



Test Report No.: RF2309WDG0199-1

RELEASE CONTROL RECORD

ISSUE NO.	REASON FOR CHANGE	DATE ISSUED
RF2309WDG0199-1	Original release	Nov. 20, 2023

1 SUMMARY OF TEST RESULTS

The EUT has been tested according to the following specifications:

APPLIED STANDARD: FCC PART 15, SUBPART C (SECTION 15.247)			
STANDARD SECTION	TEST TYPE AND LIMIT	RESULT	REMARK
15.207	AC Power Conducted Emission	PASS	Meet the requirement of limit.
15.247(d) 15.209	Radiated Emissions	PASS	Meet the requirement of limit.
15.247(d)	Band Edge Measurement	PASS	Meet the requirement of limit.
15.247(a)(2)	6dB bandwidth	PASS	Meet the requirement of limit.
15.247(b)	Conducted Output power	PASS	Meet the requirement of limit.
15.247(e)	Power Spectral Density	PASS	Meet the requirement of limit.
15.203	Antenna Requirement	PASS	Antenna connector is i-pex not a standard connector.

2 MEASUREMENT UNCERTAINTY

Where relevant, the following measurement uncertainty levels have been estimated for tests performed on the EUT as specified in CISPR 16-4-2:

MEASUREMENT	FREQUENCY	UNCERTAINTY
Conducted emissions	9kHz~30MHz	2.68dB
Radiated emissions	9KHz ~ 30MHz	2.80dB
	30MHz ~ 1GMHz	4.24dB
	1GHz ~ 18GHz	4.76dB
	18GHz ~ 40GHz	4.50dB

This uncertainty represents an expanded uncertainty expressed at approximately the 95% confidence level using a coverage factor of $k = 2$.

3 GENERAL INFORMATION

3.1 GENERAL DESCRIPTION OF EUT

PRODUCT	Montior One DE
BRAND	Particle
MODEL NO.	MON404-DE
ADDITIONAL NO.	N/A
FCC ID	2AEMI-MONEDE
NOMINAL VOLTAGE	24Vdc (adapter or host equipment) 3.7Vdc (Li-ion, battery)
MODULATION TECHNOLOGY	DSSS, OFDM
MODULATION TYPE	CCK, DQPSK, DBPSK for DSSS 64QAM, 16QAM, QPSK, BPSK for OFDM
OPERATING FREQUENCY	2412-2462MHz for 11b/g/n(HT20) 2422-2452MHz for 11n(HT40)
PEAK OUTPUT POWER	389.942 mW(Maximum)
ANTENNA TYPE	PCB Antenna, with 2dBi gain
I/O PORTS	Refer to user's manual
CABLE SUPPLIED	Cable 1: Unshielded, Detachable, 160cm Cable 2: Unshielded, Detachable, 160cm
RF POWER SETTING IN TEST SW	See notes 6

NOTES:

- The above EUT information is declared by manufacturer and for more detailed features description, please refers to the manufacturer's specifications or user's manual.
- Please refer to the EUT photo document (Reference No.: W7L_P23100004) for detailed product photo.
- The FCC Site Registration No. is 749762.
- The EUT provides completed transmitters and receivers:

MODULATION MODE	FUNCTION
802.11b	1TX/1RX
802.11g	1TX/1RX
802.11n (HT20)	1TX/1RX
802.11n (HT40)	1TX/1RX

- The EUT were powered by the following adapter:

ADAPTER	
BRAND:	N/A
MODEL:	L6R30-240
INPUT:	AC 100-240V, 50/60Hz 0.8A
OUTPUT:	DC 24V, 1.25A
DC LINE:	Unshielded, Detachable, 150cm.

6. By means of test software provided by manufacturer, the power levels during the tests were set according to the following codes:

802.11b		802.11g		802.11n(HT20)		802.11n(HT40)	
Channel	Power Setting	Channel	Power Setting	Channel	Power Setting	Channel	Power Setting
1	5	1	8	1	8	3	12
6	5	6	8	6	8	6	12
11	5	11	8	11	8	9	12

3.2 DESCRIPTION OF TEST MODES

11 channels are provided for 802.11b, 802.11g and 802.11n(HT20):

CHANNEL	FREQUENCY	CHANNEL	FREQUENCY
1	2412 MHz	7	2442 MHz
2	2417 MHz	8	2447 MHz
3	2422 MHz	9	2452 MHz
4	2427 MHz	10	2457 MHz
5	2432 MHz	11	2462 MHz
6	2437 MHz		

7 channels are provided for 802.11n (HT40):

CHANNEL	FREQUENCY	CHANNEL	FREQUENCY
3	2422MHz	7	2442MHz
4	2427MHz	8	2447MHz
5	2432MHz	9	2452MHz
6	2437MHz		

3.2.1 CONFIGURATION OF SYSTEM UNDER TEST

Please see section 5 photographs of the test configuration for reference.

3.2.2 TEST MODE APPLICABILITY AND TESTED CHANNEL DETAIL

Pre-Scan has been conducted to determine the worst-case mode from all possible combinations between available modulations, data rates, XYZ axis, power supply voltage range and antenna ports. The worst case was found when positioned on X axis for radiated emission. Following test modes were selected for the final test, and the final worst case is marked in boldface and recorded in the report:

EUT CONFIGURE MODE	APPLICABLE TO				MODE
	RE<1G	RE≥1G	PLC	APCM	
A	√	√	√	√	Powered by Adapter with WIFI function

Where **RE<1G**: Radiated Emission below 1GHz **RE≥1G**: Radiated Emission above 1GHz
PLC: Power Line Conducted Emission **APCM**: Antenna Port Conducted Measurement

POWER LINE CONDUCTED EMISSION TEST:

- Pre-Scan has been conducted to determine the worst-case mode from all possible combinations between available modulations, data rates and antenna ports (if EUT with antenna diversity architecture).
- Following channel(s) was (were) selected for the final test as listed below.

EUT CONFIGURE MODE	MODE	AVAILABLE CHANNEL	TESTED CHANNEL	MODULATION TECHNOLOGY	MODULATION TYPE	DATA RATE (Mbps)
A	802.11b	1 to 11	1	DSSS	DBPSK	1.0

For the test results, only the worst case was shown in test report.

RADIATED EMISSION TEST (BELOW 1GHz):

- Pre-Scan has been conducted to determine the worst-case mode from all possible combinations between available modulations, data rates, XYZ axis and antenna ports (if EUT with antenna diversity architecture).
- Following channel(s) was (were) selected for the final test as listed below.

EUT CONFIGURE MODE	MODE	AVAILABLE CHANNEL	TESTED CHANNEL	MODULATION TECHNOLOGY	MODULATION TYPE	DATA RATE (Mbps)
A	802.11b	1 to 11	1	DSSS	DBPSK	1.0

For the test results, only the worst case was shown in test report.

RADIATED EMISSION TEST (ABOVE 1GHz):

- Pre-Scan has been conducted to determine the worst-case mode from all possible combinations between available modulations, data rates, XYZ axis and antenna ports (if EUT with antenna diversity architecture).
- Following channel(s) was (were) selected for the final test as listed below.

EUT CONFIGURE MODE	MODE	AVAILABLE CHANNEL	TESTED CHANNEL	MODULATION TECHNOLOGY	MODULATION TYPE	DATA RATE (Mbps)
A	802.11b	1 to 11	1, 6, 11	DSSS	DBPSK	1.0
A	802.11g	1 to 11	1, 6, 11	OFDM	BPSK	6.0
A	802.11n HT20	1 to 11	1, 6, 11	OFDM	BPSK	6.5
A	802.11n HT40	1 to 11	3, 6, 9	OFDM	BPSK	13.5

ANTENNA PORT CONDUCTED MEASUREMENT:

- This item includes all test value of each mode, but only includes spectrum plot of worst value of each mode.
- Pre-Scan has been conducted to determine the worst-case mode from all possible combinations between available modulations, data rates and antenna ports (if EUT with antenna diversity architecture).
- Following channel(s) was (were) selected for the final test as listed below.

EUT CONFIGURE MODE	MODE	AVAILABLE CHANNEL	TESTED CHANNEL	MODULATION TECHNOLOGY	MODULATION TYPE	DATA RATE (Mbps)
A	802.11b	1 to 11	1, 6, 11	DSSS	DBPSK	1.0
A	802.11g	1 to 11	1, 6, 11	OFDM	BPSK	6.0
A	802.11n HT20	1 to 11	1, 6, 11	OFDM	BPSK	6.5
A	802.11n HT40	1 to 11	3, 6, 9	OFDM	BPSK	13.5

TEST CONDITION:

APPLICABLE TO	ENVIRONMENTAL CONDITIONS	TEST VOLTAGE	TESTED BY
RE<1G	25deg. C, 55%RH	AC 120V 60Hz	Stalker
RE≥1G	25deg. C, 55%RH	AC 120V 60Hz	Stalker
PLC	25deg. C, 60%RH	AC 120V 60Hz	Summer
APCM	20deg. C, 55%RH	AC 120V 60Hz	Jeffery

3.3 GENERAL DESCRIPTION OF APPLIED STANDARDS

The EUT is a RF Product. According to the specifications of the manufacturer, it must comply with the requirements of the following standards:

FCC Part 15, Subpart C, Section 15.247

KDB 558074 D01 15.247 Meas Guidance v05r02

ANSI C63.10-2013

All test items have been performed and recorded as per the above standards.

3.4 DESCRIPTION OF SUPPORT UNITS

The EUT has been tested as an independent unit together with other necessary accessories or support units. The following support units or accessories were used to form a representative test configuration during the tests.

NO.	PRODUCT	BRAND	MODEL NO.	SERIAL NO.	FCC ID
1	N/A	N/A	N/A	N/A	N/A

NO.	SIGNAL CABLE DESCRIPTION OF THE ABOVE SUPPORT UNITS
1	N/A

3.5 CONFIGURATION OF SYSTEM UNDER TEST

For Conducted Emission Test

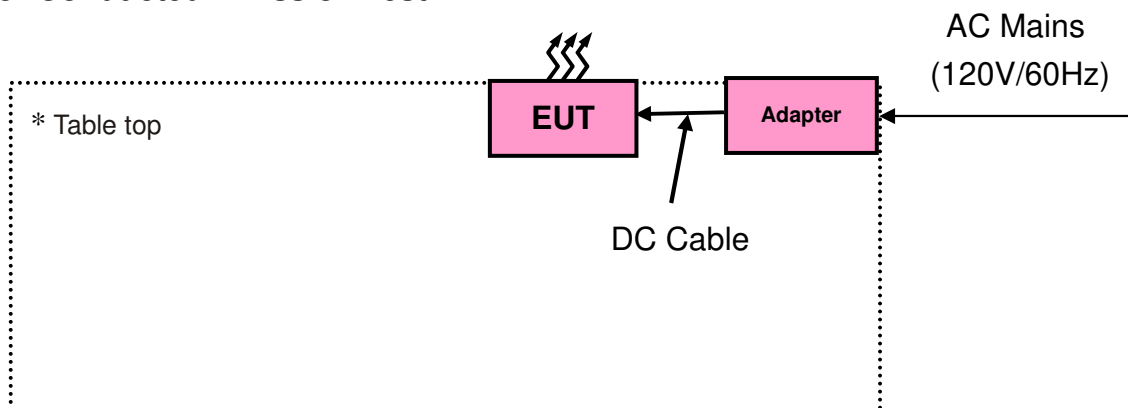

Note: For the actual test configuration, please refer to the attached file (Test Setup Photo).

For Radiated Emission Test

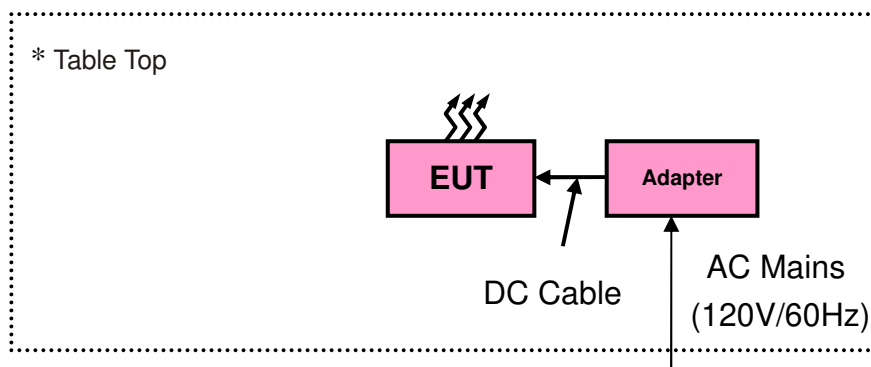

Note: For the actual test configuration, please refer to the attached file (Test Setup Photo).

3.6 DUTY CYCLE OF TESET SIGNAL

Test Mode	On Time (ms)	Period (ms)	Duty Cycle (%)	Duty factor (dB)	1/T Min. VBW (KHz)	VBW Setting
802.11b	/	/	100	/	/	10Hz
802.11g	/	/	100	/	/	10Hz
802.11n (HT20)	/	/	100	/	/	10Hz
802.11n (HT40)	/	/	100	/	/	10Hz

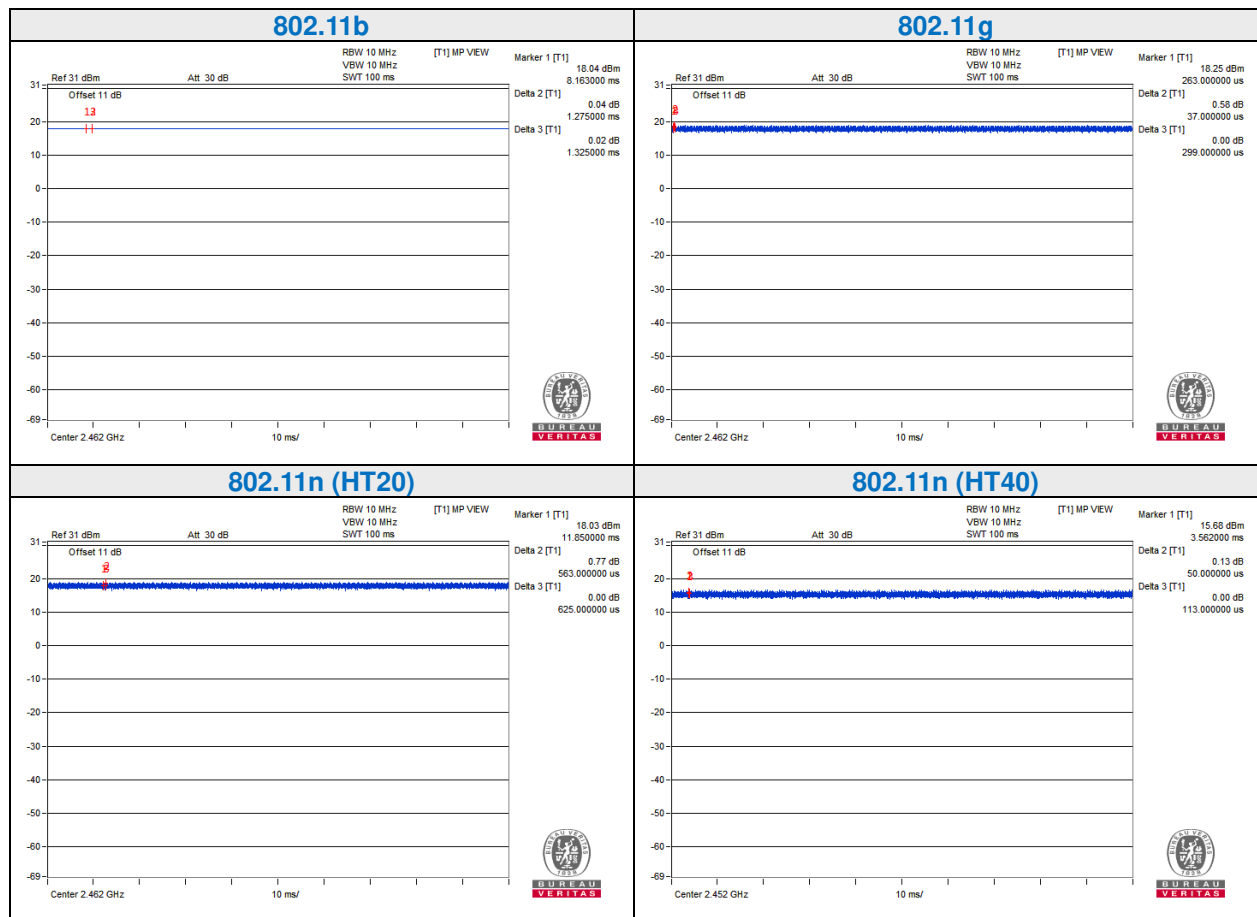

4 TEST TYPES AND RESULTS

4.1. CONDUCTED EMISSION MEASUREMENT

4.1.1 LIMITS OF CONDUCTED EMISSION MEASUREMENT

FREQUENCY OF EMISSION (MHz)	CONDUCTED LIMIT (dB μ V)	
	Quasi-peak	Average
0.15 ~ 0.5	66 to 56	56 to 46
0.5 ~ 5	56	46
5 ~ 30	60	50

- NOTES:**
1. The lower limit shall apply at the transition frequencies.
 2. The limit decreases in line with the logarithm of the frequency in the range of 0.15 to 0.50MHz.
 3. All emanations from a class A/B digital device or system, including any network of conductors and apparatus connected thereto, shall not exceed the level of field strengths specified above.

4.1.2 TEST INSTRUMENTS

Equipment	Manufacturer	Model No.	Serial No.	Next Cal.
EMI Test Receiver	Rohde&Schwarz	ESR7	101494	Jan. 10,24
Artificial Mains Network	Rohde&Schwarz	ENV216	101173	Jan. 11,24
Artificial Mains Network	Rohde&Schwarz	ESH3-Z5	100317	Jan. 10,24
V-LISN (CISPR 25)	SCHWARZBECK	NNBM 8124-200	8124-200 05857	Jun. 14, 24
V-LISN (CISPR 25)	SCHWARZBECK	NNBM 8124-200	8124-200 05858	Jun. 14, 24
Voltage probe	SCHWARZBECK	TK 9421	TK 9421-176	Jul. 27, 24
Coaxial RF Cable	SUHNER	RG 223/U-CE	C2310066DG	Jul. 24, 24
Test software	ADT	ADT_Cond_V7.3.7	N/A	N/A

- NOTES:**
1. The test was performed in shielded room 553.
 2. The calibration interval of the above test instruments is 12 months. And the calibrations are traceable to CEPREI/CHINA, GRGT/CHINA and NIM/CHINA.

4.1.3 TEST PROCEDURES

- a. The EUT was placed 0.4 meters from the conducting wall of the shielded room with EUT being connected to the power mains through a line impedance stabilization network (LISN). Other support units were connected to the power mains through another LISN. The two LISNs provide 50 ohm/ 50uH of coupling impedance for the measuring instrument.
- b. Both lines of the power mains connected to the EUT were checked for maximum conducted interference.
- c. The frequency range from 150kHz to 30MHz was searched. Emission levels under (Limit - 20dB) was not recorded.

NOTE: All modes of operation were investigated and the worst-case emissions are reported.

4.1.4 DEVIATION FROM TEST STANDARD

No deviation.

4.1.5 TEST SETUP

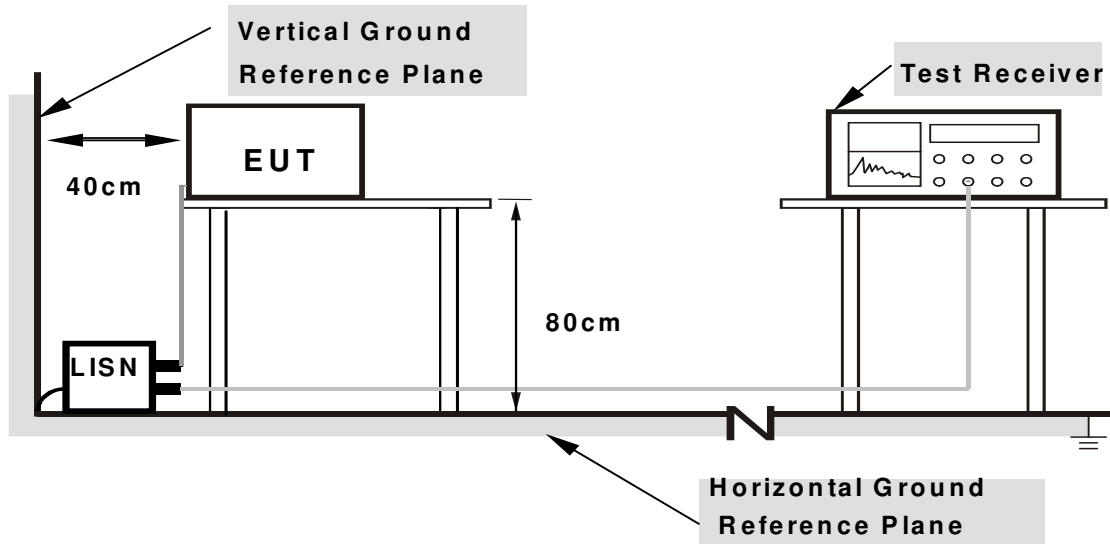

- Note:**
- 1.Support units were connected to second LISN.
 - 2.Both of LISNs (AMN) are 80 cm from EUT and at least 80 from other units and other metal planes

For the actual test configuration, please refer to the attached file (Test Setup Photo).

4.1.6 EUT OPERATING CONDITIONS

- a. Turned on the power and connected of all equipment.
- b. EUT was operated according to the type used was description in manufacturer's specifications or the User's Manual.

4.1.7 TEST RESULTS

CONDUCTED WORST-CASE DATA: 802. 11b channel 1

PHASE	Line	6dB BANDWIDTH	9kHz
--------------	------	----------------------	------

No	Freq. [MHz]	Corr. Factor (dB)	Reading Value [dB (uV)]		Emission Level [dB (uV)]		Limit [dB (uV)]		Margin (dB)	
			Q.P.	AV.	Q.P.	AV.	Q.P.	AV.	Q.P.	AV.
1	0.15000	9.98	21.11	10.34	31.09	20.32	66.00	56.00	-34.91	-35.68
2	0.19983	10.03	16.33	7.23	26.36	17.26	63.62	53.62	-37.26	-36.36
3	0.39750	10.12	16.20	8.17	26.32	18.29	57.91	47.91	-31.59	-29.62
4	0.41305	10.12	14.06	7.56	24.18	17.68	57.59	47.59	-33.40	-29.90
5	0.89025	10.18	10.26	3.16	20.44	13.34	56.00	46.00	-35.56	-32.66
6	1.23886	10.19	12.69	4.44	22.88	14.63	56.00	46.00	-33.12	-31.37

- REMARKS:**
1. Q.P. and AV. are abbreviations of quasi-peak and average individually.
 2. "-": The Quasi-peak reading value also meets average limit and measurement with the average detector is unnecessary.
 3. The emission levels of other frequencies were very low against the limit.
 4. Margin value = Emission level - Limit value
 5. Correction factor = Insertion loss + Cable loss
 6. Emission Level = Correction Factor + Reading Value.

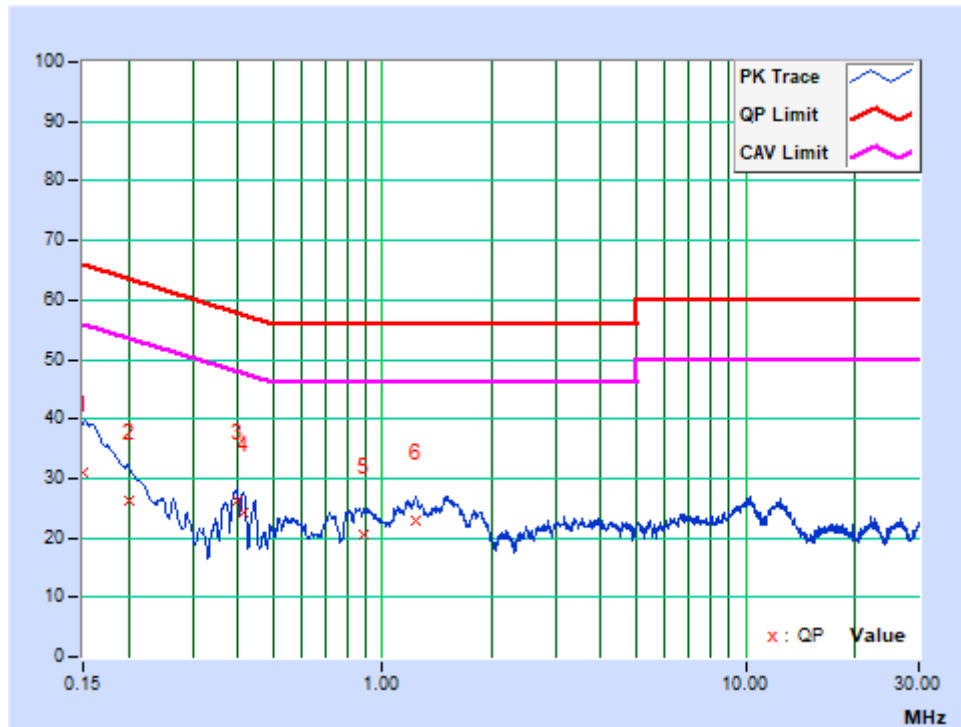

PHASE	Neutral	6dB BANDWIDTH	9kHz
--------------	---------	----------------------	------

No	Freq. [MHz]	Corr. Factor (dB)	Reading Value [dB (uV)]		Emission Level [dB (uV)]		Limit [dB (uV)]		Margin (dB)	
			Q.P.	AV.	Q.P.	AV.	Q.P.	AV.	Q.P.	AV.
1	0.15000	9.95	21.84	11.60	31.79	21.55	66.00	56.00	-34.21	-34.45
2	0.22151	10.03	21.69	14.08	31.72	24.11	62.76	52.76	-31.04	-28.65
3	0.24488	10.05	20.66	14.61	30.71	24.66	61.93	51.93	-31.22	-27.27
4	0.26788	10.05	18.40	12.73	28.45	22.78	61.18	51.18	-32.73	-28.40
5	0.37067	10.08	20.07	13.92	30.15	24.00	58.49	48.49	-28.33	-24.48
6	0.39975	10.09	16.64	5.12	26.73	15.21	57.86	47.86	-31.13	-32.65

- REMARKS:**
1. Q.P. and AV. are abbreviations of quasi-peak and average individually.
 2. "-": The Quasi-peak reading value also meets average limit and measurement with the average detector is unnecessary.
 3. The emission levels of other frequencies were very low against the limit.
 4. Margin value = Emission level - Limit value
 5. Correction factor = Insertion loss + Cable loss
 6. Emission Level = Correction Factor + Reading Value.

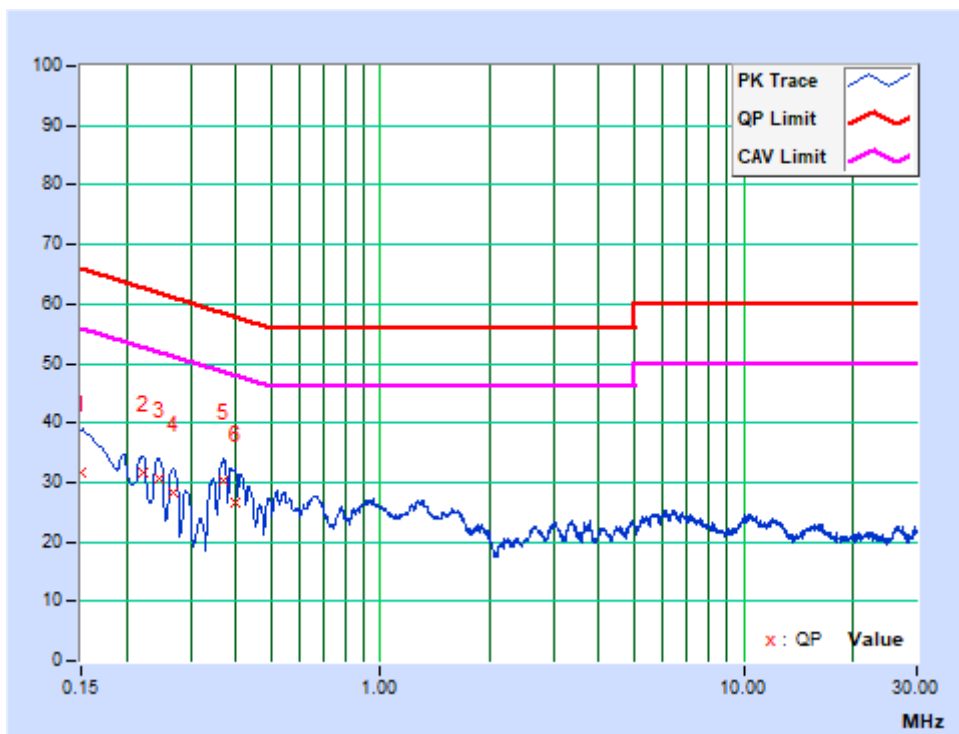

4.2. RADIATED EMISSION MEASUREMENT

4.2.1 LIMITS OF RADIATED EMISSION MEASUREMENT

Radiated emissions which fall in the restricted bands, as defined in Section 15.205(a), must also comply with the radiated emission limits specified in Section 15.209(a).

FREQUENCIES (MHz)	FIELD STRENGTH (microvolts/meter)	MEASUREMENT DISTANCE (meters)
0.009 ~ 0.490	2400/F(kHz)	300
0.490 ~ 1.705	24000/F(kHz)	30
1.705 ~ 30.0	30	30
30 ~ 88	100	3
88 ~ 216	150	3
216 ~ 960	200	3
Above 960	500	3

NOTES:

1. The lower limit shall apply at the transition frequencies.
2. Emission level (dBuV/m) = 20 log Emission level (uV/m).
3. As shown in 15.35(b), for frequencies above 1000MHz, the field strength limits are based on average detector, however, the peak field strength of any emission shall not exceed the maximum permitted average limits, specified above by more than 20dB under any condition of modulation.



4.2.2 TEST INSTRUMENTS

Equipment	Manufacturer	Model No.	Serial No.	Next Cal.
EMI Test Receiver	Rohde&Schwarz	ESU40	100449	Jan. 10, 24
Signal and Spectrum Analyzer	Rohde&Schwarz	FSV7	102331	May. 09, 24
Active Loop Antenna (9KHz -30MHz)	SCHWARZBECK	FMZB 1519B	1519B-045	Apr. 27, 24
Amplifier (9KHz -1GHz)	Burgeon	BPA-530	100210	Mar. 06, 24
Trilog-Broadband Antenna(20M-2G)	SCHWARZBECK	VULB 9168	01282	Aug. 21, 24
Horn Antenna (1GHz -18GHz)	ETS -Lindgren	3117	00062558	Apr. 27, 24
Horn Antenna (18GHz -40GHz)	SCHWARZBECK	BBHA 9170	BBHA9170147	Apr. 28, 24
3m Semi-anechoic Chamber	ETS-LINDGREN	9m*6m*6m	NSEMC003	May 22, 24
Test Software	ADT	ADT_Radiated_V7.6.15.9.2	N/A	N/A
Broadband Preamplifier (1GHz~18GHz)	SCHWARZBECK	BBV9718	305	Apr. 26, 24
Pre-Amplifier (18GHz-40GHz)	EMCI	EMC 184045	980102	Jan. 16, 24
BLUETOOTH TESTER	Rohde&Schwarz	CBT32	100811	N/A

NOTES:

1. The test was performed in 966 Chamber.
2. The calibration interval of the above test instruments is 12 months and the calibrations are traceable to CEPREI/CHINA, GRGT/CHINA and NIM/CHINA.
3. The horn antenna is used only for the measurement of emission frequency above 1GHz if tested.
4. The FCC Site Registration No. is 749762.

4.2.3 TEST PROCEDURES

- a. The EUT was placed on the top of a rotating table 1.5 meters (above 1GHz) and 0.8 meters (below 1GHz) above the ground at a 3 meters semi-anechoic chamber. The table was rotated 360 degrees to determine the position of the highest radiation.
- b. The EUT was set 3 meters away from the interference-receiving antenna, which was mounted on the top of a variable-height antenna tower.
- c. For below 1GHz was used bilog antenna, and above 1GHz was used horn antenna, and its height is varied from one meter to four meters above the ground to determine the maximum value of the field strength. Both horizontal and vertical polarizations of the antenna are set to make the measurement.
- d. For each suspected emission, the EUT was arranged to its worst case and then the antenna was tuned to heights from 1 meter to 4 meters and the rotatable table was turned from 0 degrees to 360 degrees to find the maximum reading.
- e. The test-receiver system was set to Peak Detect Function and Specified Bandwidth with Maximum Hold Mode.
- f. For below 30MHz, a loop antenna with its vertical plane is place 3m from the EUT and rotated about its vertical axis for maximum response at each azimuth about the EUT, and the centre of the loop shall be 1.3m above the ground.
- g. During the test, each emission was maximized by: having the EUT continuously working, investigated all operating modes, rotated about all 3 axis (X, Y & Z) and considered typical configuration to obtain worst position, manipulating interconnecting cables, For battery operated equipment, the equipment tests shall be perform using fresh batteries. The turntable was rotated to maximize the emission level.

NOTES:

1. The resolution bandwidth and video bandwidth of test receiver/spectrum analyzer is 120kHz for Quasi-peak detection at frequency below 1GHz.
2. The resolution bandwidth of test receiver/spectrum analyzer is 1MHz and video bandwidth is 3MHz for Peak detection at frequency above 1GHz.
3. The resolution bandwidth of test receiver/spectrum analyzer is 1MHz and the video bandwidth is 10Hz(Duty cycle > 98%) for Average detection (AV) at frequency above 1GHz.
4. All modes of operation were investigated and the worst-case emissions are reported.
5. The testing of the EUT was performed on all 3 orthogonal axes, the worst-case test configuration was reported on the file test setup photo.

4.2.4 DEVIATION FROM TEST STANDARD

No deviation.

4.2.5 TEST SETUP

Below 30MHz test setup

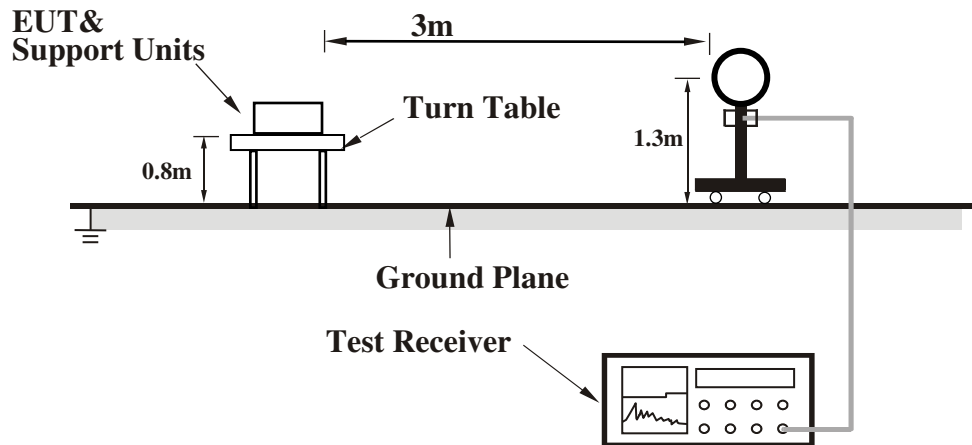

Below 1GHz test setup

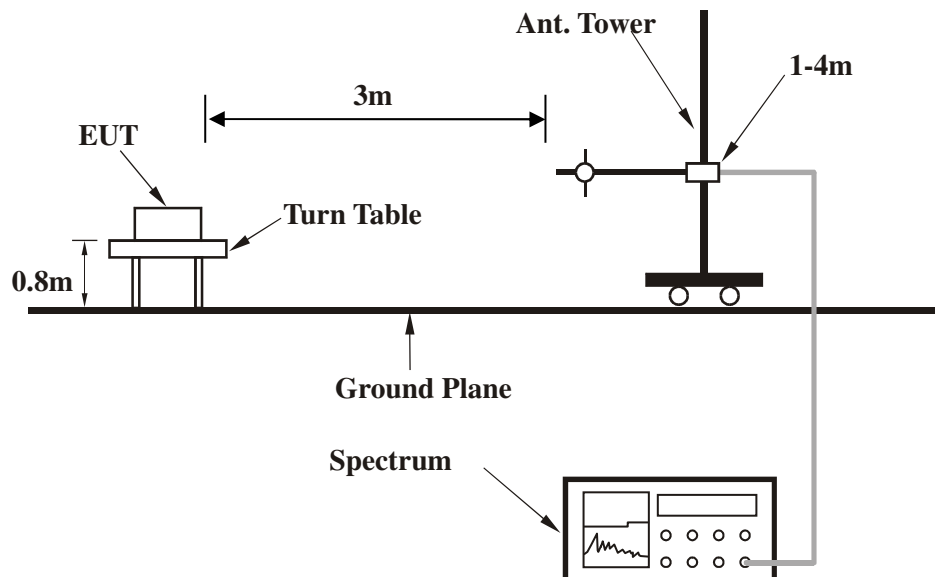

Note: For the actual test configuration, please refer to the attached file (Test Setup Photo).

Above 1GHz test setup

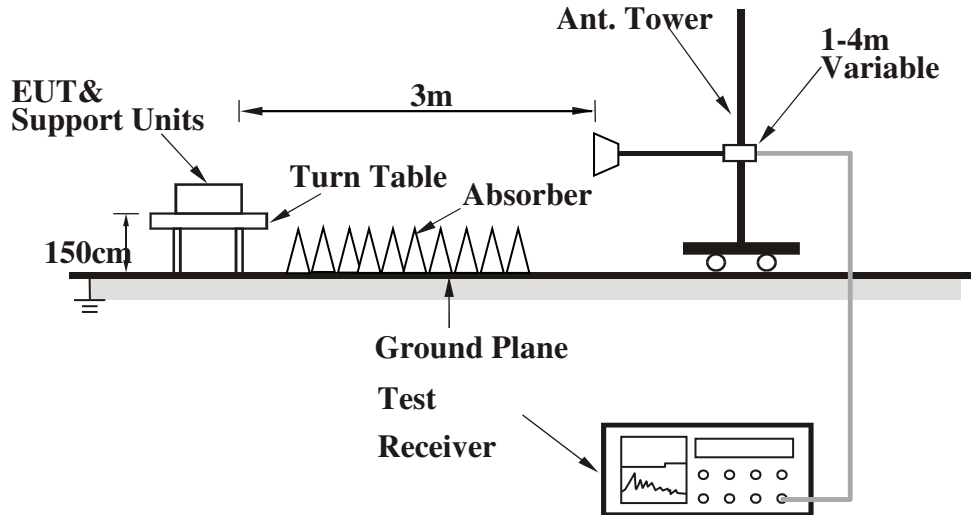

Note: For the actual test configuration, please refer to the attached file (Test Setup Photo).

4.2.6 EUT OPERATING CONDITIONS

- Placed the EUT on a testing table.
- Set the transmitter part of EUT under transmission condition continuously at specific channel frequency.
- The necessary accessories enable the EUT in full functions.

4.2.7 TEST RESULTS

BELOW 1GHz WORST-CASE DATA:

802.11b

CHANNEL	TX Channel 1	DETECTOR FUNCTION	Quasi-Peak (QP)
FREQUENCY RANGE	9KHz ~ 1GHz		

ANTENNA POLARITY & TEST DISTANCE: HORIZONTAL AT 3 M								
NO.	FREQ. (MHz)	EMISSION LEVEL (dBuV/m)	LIMIT (dBuV/m)	MARGIN (dB)	ANTENNA HEIGHT (m)	TABLE ANGLE (Degree)	RAW VALUE (dBuV)	CORRECTION FACTOR (dB/m)
1	82.85	29.67 QP	40.00	-10.33	1.88 H	56	51.33	-21.66
2	95.92	36.40 QP	43.50	-7.10	2.00 H	152	57.68	-21.28
3	159.02	30.29 QP	43.50	-13.21	1.63 H	82	46.91	-16.62
4	191.67	27.06 QP	43.50	-16.44	1.12 H	133	45.39	-18.33
5	204.10	27.59 QP	43.50	-15.91	1.48 H	96	46.88	-19.29
6	479.25	32.17 QP	46.00	-13.83	1.32 H	113	43.06	-10.89

REMARKS:

1. Emission level (dBuV/m) = Raw Value (dBuV) + Correction Factor (dB/m).
2. Correction Factor (dB/m) = Antenna Factor (dB/m) + Cable Factor (dB).
3. The emission levels of other frequencies were greater than 20dB margin.
4. 9KHz~30MHz have been test and test data more than 20dB margin.
5. Margin value = Emission level – Limit value.

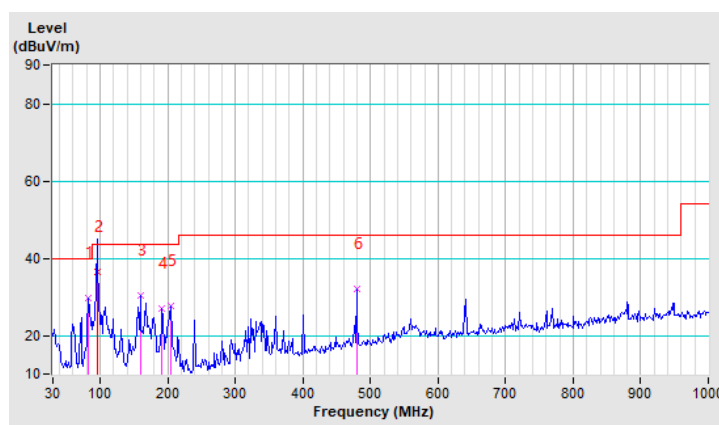

CHANNEL	TX Channel 1	DETECTOR FUNCTION	Quasi-Peak (QP)
FREQUENCY RANGE	9KHz ~ 1GHz		

ANTENNA POLARITY & TEST DISTANCE: VERTICAL AT 3 M								
NO.	FREQ. (MHz)	EMISSION LEVEL (dBuV/m)	LIMIT (dBuV/m)	MARGIN (dB)	ANTENNA HEIGHT (m)	TABLE ANGLE (Degree)	RAW VALUE (dBuV)	CORRECTION FACTOR (dB/m)
1	59.54	34.83 QP	40.00	-5.17	1.58 V	180	53.04	-18.21
2	95.29	31.51 QP	43.50	-11.99	1.78 V	199	52.84	-21.33
3	131.04	29.65 QP	43.50	-13.85	1.94 V	215	47.30	-17.65
4	155.91	27.86 QP	43.50	-15.64	1.99 V	229	44.47	-16.61
5	322.24	28.84 QP	46.00	-17.16	2.00 V	245	43.65	-14.81
6	479.25	30.43 QP	46.00	-15.57	2.00 V	260	41.32	-10.89

REMARKS:

1. Emission level (dBuV/m) = Raw Value (dBuV) + Correction Factor (dB/m).
2. Correction Factor (dB/m) = Antenna Factor (dB/m) + Cable Factor (dB).
3. The emission levels of other frequencies were greater than 20dB margin.
4. 9KHz~30MHz have been test and test data more than 20dB margin.
5. Margin value = Emission level – Limit value.

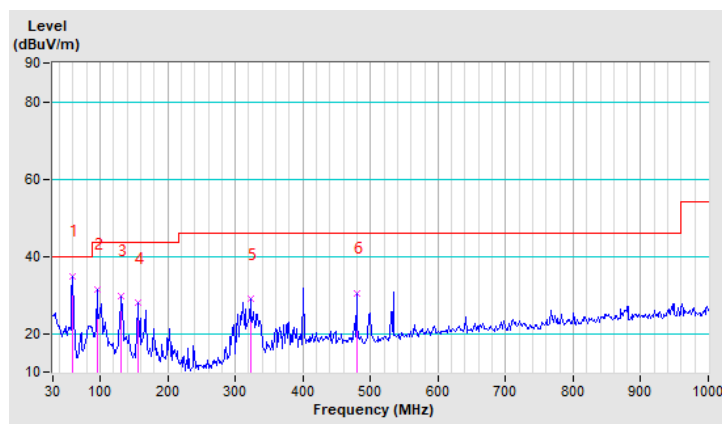

ABOVE 1GHZ DATA

802.11b

CHANNEL	TX Channel 1	DETECTOR FUNCTION	Peak (PK)
FREQUENCY RANGE	1GHz ~ 25GHz		Average (AV)

ANTENNA POLARITY & TEST DISTANCE : HORIZONTAL AT 3 M

NO.	FREQ. (MHz)	EMISSION LEVEL (dBuV/m)	LIMIT (dBuV/m)	MARGIN (dB)	ANTENNA HEIGHT (m)	TABLE ANGLE (Degree)	RAW VALUE (dBuV)	CORRECTION FACTOR (dB/m)
1	2390.00	51.67 PK	74.00	-22.33	1.00 H	221	48.68	2.99
2	2390.00	41.68 AV	54.00	-12.32	1.00 H	221	38.69	2.99
3	*2412.00	111.31 PK			1.00 H	221	108.27	3.04
4	*2412.00	102.31 AV			1.00 H	221	99.27	3.04
5	4824.00	52.44 PK	74.00	-21.56	1.50 H	210	44.57	7.87
6	4824.00	42.44 AV	54.00	-11.56	1.50 H	210	34.57	7.87
7	#7236.00	52.66 PK	74.00	-21.34	1.50 H	52	42.22	10.44
8	#7236.00	42.72 AV	54.00	-11.28	1.50 H	52	32.28	10.44

ANTENNA POLARITY & TEST DISTANCE : VERTICAL AT 3 M

NO.	FREQ. (MHz)	EMISSION LEVEL (dBuV/m)	LIMIT (dBuV/m)	MARGIN (dB)	ANTENNA HEIGHT (m)	TABLE ANGLE (Degree)	RAW VALUE (dBuV)	CORRECTION FACTOR (dB/m)
1	2390.00	55.98 PK	74.00	-18.02	2.81 V	116	52.99	2.99
2	2390.00	45.10 AV	54.00	-8.90	2.81 V	116	42.11	2.99
3	*2412.00	111.88 PK			2.81 V	116	108.84	3.04
4	*2412.00	102.12 AV			2.81 V	116	99.08	3.04
5	4824.00	52.18 PK	74.00	-21.82	1.00 V	360	44.31	7.87
6	4824.00	41.70 AV	54.00	-12.30	1.00 V	360	33.83	7.87
7	#7236.00	53.12 PK	74.00	-20.88	1.55 V	65	42.68	10.44
8	#7236.00	43.29 AV	54.00	-10.71	1.55 V	65	32.85	10.44

REMARKS:

1. Emission level (dBuV/m) = Raw Value (dBuV) + Correction Factor (dB/m).
2. Correction Factor (dB/m) = Antenna Factor (dB/m) + Cable Factor (dB).
3. The emission levels of other frequencies were greater than 20dB margin.
4. Margin value = Emission level – Limit value.
5. " * " : Fundamental frequency.
6. " # " : The radiated frequency is out of the restricted band.

CHANNEL	TX Channel 6	DETECTOR FUNCTION	Peak (PK)
FREQUENCY RANGE	1GHz ~ 25GHz		Average (AV)

ANTENNA POLARITY & TEST DISTANCE : HORIZONTAL AT 3 M								
NO.	FREQ. (MHz)	EMISSION LEVEL (dBuV/m)	LIMIT (dBuV/m)	MARGIN (dB)	ANTENNA HEIGHT (m)	TABLE ANGLE (Degree)	RAW VALUE (dBuV)	CORRECTION FACTOR (dB/m)
1	*2437.00	111.23 PK			1.33 H	52	108.14	3.09
2	*2437.00	102.49 AV			1.33 H	52	99.40	3.09
3	4874.00	51.29 PK	74.00	-22.71	1.03 H	65	43.30	7.99
4	4874.00	41.20 AV	54.00	-12.80	1.03 H	65	33.21	7.99
5	7311.00	52.10 PK	74.00	-21.90	1.45 H	41	41.41	10.69
6	7311.00	41.20 AV	54.00	-12.80	1.45 H	41	30.51	10.69
ANTENNA POLARITY & TEST DISTANCE : VERTICAL AT 3 M								
NO.	FREQ. (MHz)	EMISSION LEVEL (dBuV/m)	LIMIT (dBuV/m)	MARGIN (dB)	ANTENNA HEIGHT (m)	TABLE ANGLE (Degree)	RAW VALUE (dBuV)	CORRECTION FACTOR (dB/m)
1	*2437.00	112.08 PK			1.33 V	52	108.99	3.09
2	*2437.00	102.37 AV			1.33 V	52	99.28	3.09
3	4874.00	52.29 PK	74.00	-21.71	1.63 V	52	44.30	7.99
4	4874.00	42.10 AV	54.00	-11.90	1.63 V	52	34.11	7.99
5	7311.00	53.26 PK	74.00	-20.74	1.22 V	35	42.57	10.69
6	7311.00	43.10 AV	54.00	-10.90	1.22 V	35	32.41	10.69

REMARKS:

1. Emission level (dBuV/m) = Raw Value (dBuV) + Correction Factor (dB/m).
2. Correction Factor (dB/m) = Antenna Factor (dB/m) + Cable Factor (dB).
3. The emission levels of other frequencies were greater than 20dB margin.
4. Margin value = Emission level – Limit value.
5. " * ": Fundamental frequency.

CHANNEL	TX Channel 11	DETECTOR FUNCTION	Peak (PK)
FREQUENCY RANGE	1GHz ~ 25GHz		Average (AV)

ANTENNA POLARITY & TEST DISTANCE : HORIZONTAL AT 3 M								
NO.	FREQ. (MHz)	EMISSION LEVEL (dBuV/m)	LIMIT (dBuV/m)	MARGIN (dB)	ANTENNA HEIGHT (m)	TABLE ANGLE (Degree)	RAW VALUE (dBuV)	CORRECTION FACTOR (dB/m)
1	*2462.00	109.35 PK			3.17 H	211	106.21	3.14
2	*2462.00	100.13 AV			3.17 H	211	96.99	3.14
3	2483.50	48.49 PK	74.00	-25.51	3.17 H	211	45.32	3.17
4	2483.50	39.11 AV	54.00	-14.89	3.17 H	211	35.94	3.17
5	4924.00	52.16 PK	74.00	-21.84	1.46 H	55	44.04	8.12
6	4924.00	42.19 AV	54.00	-11.81	1.46 H	55	34.07	8.12
7	7386.00	52.19 PK	74.00	-21.81	1.44 H	47	41.24	10.95
8	7386.00	42.70 AV	54.00	-11.30	1.44 H	47	31.75	10.95
ANTENNA POLARITY & TEST DISTANCE : VERTICAL AT 3 M								
NO.	FREQ. (MHz)	EMISSION LEVEL (dBuV/m)	LIMIT (dBuV/m)	MARGIN (dB)	ANTENNA HEIGHT (m)	TABLE ANGLE (Degree)	RAW VALUE (dBuV)	CORRECTION FACTOR (dB/m)
1	*2462.00	112.96 PK			1.83 V	234	109.82	3.14
2	*2462.00	103.17 AV			1.83 V	234	100.03	3.14
3	2483.50	52.04 PK	74.00	-21.96	1.83 V	234	48.87	3.17
4	2483.50	41.58 AV	54.00	-12.42	1.83 V	234	38.41	3.17
5	4924.00	50.29 PK	74.00	-23.71	1.45 V	40	42.17	8.12
6	4924.00	41.20 AV	54.00	-12.80	1.45 V	40	33.08	8.12
7	7386.00	52.30 PK	74.00	-21.70	1.00 V	95	41.35	10.95
8	7386.00	43.00 AV	54.00	-11.00	1.00 V	95	32.05	10.95

REMARKS:

1. Emission level (dBuV/m) = Raw Value (dBuV) + Correction Factor (dB/m).
2. Correction Factor (dB/m) = Antenna Factor (dB/m) + Cable Factor (dB).
3. The emission levels of other frequencies were greater than 20dB margin.
4. Margin value = Emission level – Limit value.
5. "*" : Fundamental frequency.

802.11g

CHANNEL	TX Channel 1	DETECTOR FUNCTION	Peak (PK)
FREQUENCY RANGE	1GHz ~ 25GHz		Average (AV)

ANTENNA POLARITY & TEST DISTANCE : HORIZONTAL AT 3 M								
NO.	FREQ. (MHz)	EMISSION LEVEL (dBuV/m)	LIMIT (dBuV/m)	MARGIN (dB)	ANTENNA HEIGHT (m)	TABLE ANGLE (Degree)	RAW VALUE (dBuV)	CORRECTION FACTOR (dB/m)
1	2390.00	66.18 PK	74.00	-7.82	2.62 H	230	63.19	2.99
2	2390.00	50.36 AV	54.00	-3.64	2.62 H	230	47.37	2.99
3	*2412.00	111.21 PK			2.62 H	230	108.17	3.04
4	*2412.00	100.73 AV			2.62 H	230	97.69	3.04
5	4824.00	51.29 PK	74.00	-22.71	1.55 H	42	43.42	7.87
6	4824.00	42.26 AV	54.00	-11.74	1.55 H	42	34.39	7.87
7	#7236.00	52.19 PK	74.00	-21.81	1.44 H	54	41.75	10.44
8	#7236.00	41.80 AV	54.00	-12.20	1.44 H	54	31.36	10.44
ANTENNA POLARITY & TEST DISTANCE : VERTICAL AT 3 M								
NO.	FREQ. (MHz)	EMISSION LEVEL (dBuV/m)	LIMIT (dBuV/m)	MARGIN (dB)	ANTENNA HEIGHT (m)	TABLE ANGLE (Degree)	RAW VALUE (dBuV)	CORRECTION FACTOR (dB/m)
1	2390.00	67.16 PK	74.00	-6.84	2.14 V	271	64.17	2.99
2	2390.00	50.14 AV	54.00	-3.86	2.14 V	271	47.15	2.99
3	*2412.00	111.13 PK			2.14 V	271	108.09	3.04
4	*2412.00	99.92 AV			2.14 V	271	96.88	3.04
5	4824.00	52.39 PK	74.00	-21.61	1.44 V	54	44.52	7.87
6	4824.00	42.61 AV	54.00	-11.39	1.44 V	54	34.74	7.87
7	#7236.00	50.12 PK	74.00	-23.88	1.44 V	360	39.68	10.44
8	#7236.00	41.70 AV	54.00	-12.30	1.44 V	360	31.26	10.44

REMARKS:

1. Emission level (dBuV/m) = Raw Value (dBuV) + Correction Factor (dB/m).
2. Correction Factor (dB/m) = Antenna Factor (dB/m) + Cable Factor (dB).
3. The emission levels of other frequencies were greater than 20dB margin.
4. Margin value = Emission level – Limit value.
5. " * " : Fundamental frequency.
6. " # " : The radiated frequency is out of the restricted band.

CHANNEL	TX Channel 6	DETECTOR FUNCTION	Peak (PK)
FREQUENCY RANGE	1GHz ~ 25GHz		Average (AV)

ANTENNA POLARITY & TEST DISTANCE : HORIZONTAL AT 3 M								
NO.	FREQ. (MHz)	EMISSION LEVEL (dBuV/m)	LIMIT (dBuV/m)	MARGIN (dB)	ANTENNA HEIGHT (m)	TABLE ANGLE (Degree)	RAW VALUE (dBuV)	CORRECTION FACTOR (dB/m)
1	*2437.00	108.29 PK			1.45 H	41	105.20	3.09
2	*2437.00	98.29 AV			1.45 H	41	95.20	3.09
3	4874.00	49.26 PK	74.00	-24.74	1.44 H	41	41.27	7.99
4	4874.00	40.39 AV	54.00	-13.61	1.44 H	41	32.40	7.99
5	7311.00	52.10 PK	74.00	-21.90	1.44 H	54	41.41	10.69
6	7311.00	41.29 AV	54.00	-12.71	1.44 H	54	30.60	10.69
ANTENNA POLARITY & TEST DISTANCE : VERTICAL AT 3 M								
NO.	FREQ. (MHz)	EMISSION LEVEL (dBuV/m)	LIMIT (dBuV/m)	MARGIN (dB)	ANTENNA HEIGHT (m)	TABLE ANGLE (Degree)	RAW VALUE (dBuV)	CORRECTION FACTOR (dB/m)
1	*2437.00	111.03 PK			1.44 V	54	107.94	3.09
2	*2437.00	100.20 AV			1.44 V	54	97.11	3.09
3	4874.00	52.39 PK	74.00	-21.61	1.44 V	41	44.40	7.99
4	4874.00	41.20 AV	54.00	-12.80	1.44 V	41	33.21	7.99
5	7311.00	52.30 PK	74.00	-21.70	1.00 V	65	41.61	10.69
6	7311.00	42.19 AV	54.00	-11.81	1.00 V	65	31.50	10.69

REMARKS:

1. Emission level (dBuV/m) = Raw Value (dBuV) + Correction Factor (dB/m).
2. Correction Factor (dB/m) = Antenna Factor (dB/m) + Cable Factor (dB).
3. The emission levels of other frequencies were greater than 20dB margin.
4. Margin value = Emission level – Limit value.
5. " * ": Fundamental frequency.

CHANNEL	TX Channel 11	DETECTOR FUNCTION	Peak (PK)
FREQUENCY RANGE	1GHz ~ 25GHz		Average (AV)

ANTENNA POLARITY & TEST DISTANCE : HORIZONTAL AT 3 M								
NO.	FREQ. (MHz)	EMISSION LEVEL (dBuV/m)	LIMIT (dBuV/m)	MARGIN (dB)	ANTENNA HEIGHT (m)	TABLE ANGLE (Degree)	RAW VALUE (dBuV)	CORRECTION FACTOR (dB/m)
1	*2462.00	108.57 PK			2.50 H	231	105.43	3.14
2	*2462.00	99.10 AV			2.50 H	231	95.96	3.14
3	2483.50	61.00 PK	74.00	-13.00	2.50 H	231	57.83	3.17
4	2483.50	41.81 AV	54.00	-12.19	2.50 H	231	38.64	3.17
5	4924.00	51.29 PK	74.00	-22.71	1.45 H	41	43.17	8.12
6	4924.00	41.18 AV	54.00	-12.82	1.45 H	41	33.06	8.12
7	7386.00	52.39 PK	74.00	-21.61	1.44 H	54	41.44	10.95
8	7386.00	42.55 AV	54.00	-11.45	1.44 H	54	31.60	10.95
ANTENNA POLARITY & TEST DISTANCE : VERTICAL AT 3 M								
NO.	FREQ. (MHz)	EMISSION LEVEL (dBuV/m)	LIMIT (dBuV/m)	MARGIN (dB)	ANTENNA HEIGHT (m)	TABLE ANGLE (Degree)	RAW VALUE (dBuV)	CORRECTION FACTOR (dB/m)
1	*2462.00	108.83 PK			2.45 V	228	105.69	3.14
2	*2462.00	99.06 AV			2.45 V	228	95.92	3.14
3	2483.50	63.61 PK	74.00	-10.39	1.44 V	54	60.44	3.17
4	2483.50	48.61 AV	54.00	-5.39	1.44 V	54	45.44	3.17
5	4924.00	52.19 PK	74.00	-21.81	1.00 V	21	44.07	8.12
6	4924.00	40.10 AV	54.00	-13.90	1.00 V	21	31.98	8.12
7	7386.00	53.19 PK	74.00	-20.81	1.44 V	60	42.24	10.95
8	7386.00	42.79 AV	54.00	-11.21	1.44 V	60	31.84	10.95

REMARKS:

1. Emission level (dBuV/m) = Raw Value (dBuV) + Correction Factor (dB/m).
2. Correction Factor (dB/m) = Antenna Factor (dB/m) + Cable Factor (dB).
3. The emission levels of other frequencies were greater than 20dB margin.
4. Margin value = Emission level – Limit value.
5. " * " : Fundamental frequency.

802.11n HT20

CHANNEL	TX Channel 1	DETECTOR FUNCTION	Peak (PK)
FREQUENCY RANGE	1GHz ~ 25GHz		Average (AV)

ANTENNA POLARITY & TEST DISTANCE : HORIZONTAL AT 3 M								
NO.	FREQ. (MHz)	EMISSION LEVEL (dBuV/m)	LIMIT (dBuV/m)	MARGIN (dB)	ANTENNA HEIGHT (m)	TABLE ANGLE (Degree)	RAW VALUE (dBuV)	CORRECTION FACTOR (dB/m)
1	2390.00	58.71 PK	74.00	-15.29	1.00 H	152	55.72	2.99
2	2390.00	45.67 AV	54.00	-8.33	1.00 H	152	42.68	2.99
3	*2412.00	107.86 PK			1.00 H	152	104.82	3.04
4	*2412.00	98.40 AV			1.00 H	152	95.36	3.04
5	4824.00	51.29 PK	74.00	-22.71	1.54 H	51	43.42	7.87
6	4824.00	41.37 AV	54.00	-12.63	1.54 H	51	33.50	7.87
7	#7236.00	52.12 PK	74.00	-21.88	1.44 H	54	41.68	10.44
8	#7236.00	41.37 AV	54.00	-12.63	1.44 H	54	30.93	10.44
ANTENNA POLARITY & TEST DISTANCE : VERTICAL AT 3 M								
NO.	FREQ. (MHz)	EMISSION LEVEL (dBuV/m)	LIMIT (dBuV/m)	MARGIN (dB)	ANTENNA HEIGHT (m)	TABLE ANGLE (Degree)	RAW VALUE (dBuV)	CORRECTION FACTOR (dB/m)
1	2390.00	64.70 PK	74.00	-9.30	2.94 V	220	61.71	2.99
2	2390.00	49.62 AV	54.00	-4.38	2.94 V	220	46.63	2.99
3	*2412.00	108.79 PK			2.94 V	220	105.75	3.04
4	*2412.00	97.58 AV			2.94 V	220	94.54	3.04
5	4824.00	51.20 PK	74.00	-22.80	1.55 V	241	43.33	7.87
6	4824.00	40.37 AV	54.00	-13.63	1.55 V	241	32.50	7.87
7	#7236.00	52.19 PK	74.00	-21.81	1.44 V	51	41.75	10.44
8	#7236.00	40.10 AV	54.00	-13.90	1.44 V	51	29.66	10.44

REMARKS:

1. Emission level (dBuV/m) = Raw Value (dBuV) + Correction Factor (dB/m).
2. Correction Factor (dB/m) = Antenna Factor (dB/m) + Cable Factor (dB).
3. The emission levels of other frequencies were greater than 20dB margin.
4. Margin value = Emission level – Limit value.
5. " * ": Fundamental frequency.
6. " # ": The radiated frequency is out of the restricted band.

CHANNEL	TX Channel 6	DETECTOR FUNCTION	Peak (PK)
FREQUENCY RANGE	1GHz ~ 25GHz		Average (AV)

ANTENNA POLARITY & TEST DISTANCE : HORIZONTAL AT 3 M								
NO.	FREQ. (MHz)	EMISSION LEVEL (dBuV/m)	LIMIT (dBuV/m)	MARGIN (dB)	ANTENNA HEIGHT (m)	TABLE ANGLE (Degree)	RAW VALUE (dBuV)	CORRECTION FACTOR (dB/m)
1	*2437.00	106.21 PK			1.44 H	55	103.12	3.09
2	*2437.00	97.25 AV			1.44 H	55	94.16	3.09
3	4874.00	51.29 PK	74.00	-22.71	1.44 H	54	43.30	7.99
4	4874.00	41.20 AV	54.00	-12.80	1.44 H	54	33.21	7.99
5	7311.00	52.29 PK	74.00	-21.71	1.44 H	54	41.60	10.69
6	7311.00	41.20 AV	54.00	-12.80	1.44 H	54	30.51	10.69
ANTENNA POLARITY & TEST DISTANCE : VERTICAL AT 3 M								
NO.	FREQ. (MHz)	EMISSION LEVEL (dBuV/m)	LIMIT (dBuV/m)	MARGIN (dB)	ANTENNA HEIGHT (m)	TABLE ANGLE (Degree)	RAW VALUE (dBuV)	CORRECTION FACTOR (dB/m)
1	*2437.00	107.29 PK			1.00 V	210	104.20	3.09
2	*2437.00	99.20 AV			1.00 V	210	96.11	3.09
3	4874.00	50.19 PK	74.00	-23.81	3.32 V	21	42.20	7.99
4	4874.00	41.20 AV	54.00	-12.80	3.32 V	21	33.21	7.99
5	7311.00	52.23 PK	74.00	-21.77	1.00 V	210	41.54	10.69
6	7311.00	41.26 AV	54.00	-12.74	1.00 V	210	30.57	10.69

REMARKS:

1. Emission level (dBuV/m) = Raw Value (dBuV) + Correction Factor (dB/m).
2. Correction Factor (dB/m) = Antenna Factor (dB/m) + Cable Factor (dB).
3. The emission levels of other frequencies were greater than 20dB margin.
4. Margin value = Emission level – Limit value.
5. " * " : Fundamental frequency.

CHANNEL	TX Channel 11	DETECTOR FUNCTION	Peak (PK)
FREQUENCY RANGE	1GHz ~ 25GHz		Average (AV)

ANTENNA POLARITY & TEST DISTANCE : HORIZONTAL AT 3 M								
NO.	FREQ. (MHz)	EMISSION LEVEL (dBuV/m)	LIMIT (dBuV/m)	MARGIN (dB)	ANTENNA HEIGHT (m)	TABLE ANGLE (Degree)	RAW VALUE (dBuV)	CORRECTION FACTOR (dB/m)
1	*2462.00	105.85 PK			2.50 H	195	102.71	3.14
2	*2462.00	95.15 AV			2.50 H	195	92.01	3.14
3	2483.50	60.17 PK	74.00	-13.83	2.50 H	195	57.00	3.17
4	2483.50	43.02 AV	54.00	-10.98	2.50 H	195	39.85	3.17
5	4924.00	51.29 PK	74.00	-22.71	1.44 H	54	43.17	8.12
6	4924.00	41.20 AV	54.00	-12.80	1.44 H	54	33.08	8.12
7	7386.00	51.29 PK	74.00	-22.71	1.89 H	54	40.34	10.95
8	7386.00	41.26 AV	54.00	-12.74	1.89 H	54	30.31	10.95
ANTENNA POLARITY & TEST DISTANCE : VERTICAL AT 3 M								
NO.	FREQ. (MHz)	EMISSION LEVEL (dBuV/m)	LIMIT (dBuV/m)	MARGIN (dB)	ANTENNA HEIGHT (m)	TABLE ANGLE (Degree)	RAW VALUE (dBuV)	CORRECTION FACTOR (dB/m)
1	*2462.00	108.28 PK			3.00 V	227	105.14	3.14
2	*2462.00	99.34 AV			3.00 V	227	96.20	3.14
3	2483.50	65.74 PK	74.00	-8.26	1.65 V	52	62.57	3.17
4	2483.50	47.92 AV	54.00	-6.08	1.65 V	52	44.75	3.17
5	4924.00	51.25 PK	74.00	-22.75	1.55 V	42	43.13	8.12
6	4924.00	40.20 AV	54.00	-13.80	1.55 V	42	32.08	8.12
7	7386.00	52.16 PK	74.00	-21.84	3.00 V	54	41.21	10.95
8	7386.00	41.00 AV	54.00	-13.00	3.00 V	54	30.05	10.95

REMARKS:

1. Emission level (dBuV/m) = Raw Value (dBuV) + Correction Factor (dB/m).
2. Correction Factor (dB/m) = Antenna Factor (dB/m) + Cable Factor (dB).
3. The emission levels of other frequencies were greater than 20dB margin.
4. Margin value = Emission level – Limit value.
5. "*" : Fundamental frequency.

802.11n HT40

CHANNEL	TX Channel 3	DETECTOR FUNCTION	Peak (PK)
FREQUENCY RANGE	1GHz ~ 25GHz		Average (AV)

ANTENNA POLARITY & TEST DISTANCE : HORIZONTAL AT 3 M								
NO.	FREQ. (MHz)	EMISSION LEVEL (dBuV/m)	LIMIT (dBuV/m)	MARGIN (dB)	ANTENNA HEIGHT (m)	TABLE ANGLE (Degree)	RAW VALUE (dBuV)	CORRECTION FACTOR (dB/m)
1	2390.00	60.21 PK	74.00	-13.79	2.81 H	257	57.22	2.99
2	2390.00	45.79 AV	54.00	-8.21	2.81 H	257	42.80	2.99
3	*2422.00	104.75 PK			2.81 H	254	101.70	3.05
4	*2422.00	94.96 AV			2.81 H	254	91.91	3.05
5	4844.00	52.19 PK	74.00	-21.81	1.00 H	219	44.27	7.92
6	4844.00	41.20 AV	54.00	-12.80	1.00 H	219	33.28	7.92
7	7266.00	53.20 PK	74.00	-20.80	1.46 H	95	42.66	10.54
8	7266.00	42.10 AV	54.00	-11.90	1.46 H	95	31.56	10.54
ANTENNA POLARITY & TEST DISTANCE : VERTICAL AT 3 M								
NO.	FREQ. (MHz)	EMISSION LEVEL (dBuV/m)	LIMIT (dBuV/m)	MARGIN (dB)	ANTENNA HEIGHT (m)	TABLE ANGLE (Degree)	RAW VALUE (dBuV)	CORRECTION FACTOR (dB/m)
1	2390.00	62.08 PK	74.00	-11.92	2.50 V	229	59.09	2.99
2	2390.00	50.61 AV	54.00	-3.39	2.50 V	229	47.62	2.99
3	*2422.00	106.67 PK			2.50 V	229	103.62	3.05
4	*2422.00	94.95 AV			2.50 V	229	91.90	3.05
5	4844.00	51.29 PK	74.00	-22.71	1.00 V	21	43.37	7.92
6	4844.00	41.34 AV	54.00	-12.66	1.00 V	21	33.42	7.92
7	7266.00	51.26 PK	74.00	-22.74	1.00 V	210	40.72	10.54
8	7266.00	40.10 AV	54.00	-13.90	1.00 V	210	29.56	10.54

REMARKS:

1. Emission level (dBuV/m) = Raw Value (dBuV) + Correction Factor (dB/m).
2. Correction Factor (dB/m) = Antenna Factor (dB/m) + Cable Factor (dB).
3. The emission levels of other frequencies were greater than 20dB margin.
4. Margin value = Emission level – Limit value.
5. " * ": Fundamental frequency.

CHANNEL	TX Channel 6	DETECTOR FUNCTION	Peak (PK)
FREQUENCY RANGE	1GHz ~ 25GHz		Average (AV)

ANTENNA POLARITY & TEST DISTANCE : HORIZONTAL AT 3 M								
NO.	FREQ. (MHz)	EMISSION LEVEL (dBuV/m)	LIMIT (dBuV/m)	MARGIN (dB)	ANTENNA HEIGHT (m)	TABLE ANGLE (Degree)	RAW VALUE (dBuV)	CORRECTION FACTOR (dB/m)
1	*2437.00	105.26 PK			2.45 H	41	102.17	3.09
2	*2437.00	95.10 AV			2.45 H	41	92.01	3.09
3	4874.00	52.79 PK	74.00	-21.21	1.44 H	54	44.80	7.99
4	4874.00	42.10 AV	54.00	-11.90	1.44 H	54	34.11	7.99
5	7311.00	52.10 PK	74.00	-21.90	1.45 H	41	41.41	10.69
6	7311.00	41.20 AV	54.00	-12.80	1.45 H	41	30.51	10.69
ANTENNA POLARITY & TEST DISTANCE : VERTICAL AT 3 M								
NO.	FREQ. (MHz)	EMISSION LEVEL (dBuV/m)	LIMIT (dBuV/m)	MARGIN (dB)	ANTENNA HEIGHT (m)	TABLE ANGLE (Degree)	RAW VALUE (dBuV)	CORRECTION FACTOR (dB/m)
1	*2437.00	106.70 PK			1.44 V	54	103.61	3.09
2	*2437.00	97.25 AV			1.44 V	54	94.16	3.09
3	4874.00	53.20 PK	74.00	-20.80	1.45 V	60	45.21	7.99
4	4874.00	41.20 AV	54.00	-12.80	1.45 V	60	33.21	7.99
5	7311.00	53.35 PK	74.00	-20.65	1.45 V	44	42.66	10.69
6	7311.00	42.25 AV	54.00	-11.75	1.45 V	44	31.56	10.69

REMARKS:

1. Emission level (dBuV/m) = Raw Value (dBuV) + Correction Factor (dB/m).
2. Correction Factor (dB/m) = Antenna Factor (dB/m) + Cable Factor (dB).
3. The emission levels of other frequencies were greater than 20dB margin.
4. Margin value = Emission level – Limit value.
5. " * ": Fundamental frequency.

CHANNEL	TX Channel 9	DETECTOR FUNCTION	Peak (PK)
FREQUENCY RANGE	1GHz ~ 25GHz		Average (AV)

ANTENNA POLARITY & TEST DISTANCE : HORIZONTAL AT 3 M								
NO.	FREQ. (MHz)	EMISSION LEVEL (dBuV/m)	LIMIT (dBuV/m)	MARGIN (dB)	ANTENNA HEIGHT (m)	TABLE ANGLE (Degree)	RAW VALUE (dBuV)	CORRECTION FACTOR (dB/m)
1	*2452.00	104.31 PK			3.00 H	258	101.20	3.11
2	*2452.00	94.12 AV			3.00 H	258	91.01	3.11
3	2483.50	58.87 PK	74.00	-15.13	3.00 H	258	55.70	3.17
4	2483.50	46.77 AV	54.00	-7.23	3.00 H	258	43.60	3.17
5	4904.00	51.29 PK	74.00	-22.71	1.44 H	201	43.22	8.07
6	4904.00	40.14 AV	54.00	-13.86	1.44 H	201	32.07	8.07
7	7356.00	52.39 PK	74.00	-21.61	1.44 H	55	41.55	10.84
8	7356.00	41.26 AV	54.00	-12.74	1.44 H	55	30.42	10.84
ANTENNA POLARITY & TEST DISTANCE : VERTICAL AT 3 M								
NO.	FREQ. (MHz)	EMISSION LEVEL (dBuV/m)	LIMIT (dBuV/m)	MARGIN (dB)	ANTENNA HEIGHT (m)	TABLE ANGLE (Degree)	RAW VALUE (dBuV)	CORRECTION FACTOR (dB/m)
1	*2452.00	105.24 PK			3.00 V	224	102.13	3.11
2	*2452.00	95.07 AV			3.00 V	224	91.96	3.11
3	2483.50	61.17 PK	74.00	-12.83	3.00 V	224	58.00	3.17
4	2483.50	48.75 AV	54.00	-5.25	3.00 V	224	45.58	3.17
5	4904.00	52.15 PK	74.00	-21.85	1.55 V	360	44.08	8.07
6	4904.00	40.30 AV	54.00	-13.70	1.55 V	360	32.23	8.07
7	7356.00	52.10 PK	74.00	-21.90	1.47 V	54	41.26	10.84
8	7356.00	41.26 AV	54.00	-12.74	1.47 V	54	30.42	10.84

REMARKS:

1. Emission level (dBuV/m) = Raw Value (dBuV) + Correction Factor (dB/m).
2. Correction Factor (dB/m) = Antenna Factor (dB/m) + Cable Factor (dB).
3. The emission levels of other frequencies were greater than 20dB margin.
4. Margin value = Emission level – Limit value.
5. " * " : Fundamental frequency.

4.3 6dB BANDWIDTH MEASUREMENT

4.3.1 LIMITS OF 6dB BANDWIDTH MEASUREMENT

The minimum of 6dB Bandwidth Measurement is 0.5 MHz.

4.3.2 TEST INSTRUMENTS

Equipment	Manufacturer	Model No.	Serial No.	Next Cal.
Power Sensor	Keysight	U2021XA	MY57320002	Jan. 11, 24
Power Meter	Anritsu	ML2495A	1139001	Aug. 22, 24
Power Sensor	Anritsu	MA2411B	1531155	Aug. 22, 24
Digital Multimeter	FLUKE	15B	A1220010DG	N/A
Humid & Temp Programmable Tester	Haida	HD-225T	110807201	Nov. 02, 23
Oscilloscope	Agilent	DSO9254A	MY51260160	Jul. 27, 24
Signal and Spectrum Analyzer	Rohde&Schwarz	FSV40	101094	Jan. 11, 24
Signal Generator	Agilent	N5183A	MY50140980	Jul. 20, 24
MXG-B RF Vector Signal Generator	Keysight	N5182B	MY56200288	Jul. 20, 24
BLUETOOTH TESTER	Rohde&Schwarz	CBT32	100811	N/A
Attenuator	MINI	BW-S10W2+	S130129FGE2	N/A
DC Source	Keysight	E3642A	MY56146098	N/A
Test software	ADT	ADT_RF Test Software V6.6.5.3	N/A	N/A

NOTES: 1. The test was performed in RF Oven room.

2. The calibration interval of the above test instruments is 12 months and the calibrations are traceable to CEPREI/CHINA, GRGT/CHINA and NIM/CHINA.

4.3.3 TEST PROCEDURE

1. Set resolution bandwidth (RBW) = 100KHz
2. Set the video bandwidth (VBW) $\geq 3 \times$ RBW, Detector = Peak.
3. Trace mode = max hold.
4. Sweep = auto couple.
5. Measure the maximum width of the emission that is constrained by the frequencies associated with the two amplitude points (upper and lower) that are attenuated by 6 dB relative to the maximum level measured in the fundamental emission.

4.3.4 DEVIATION FROM TEST STANDARD

No deviation.

4.3.5 TEST SETUP

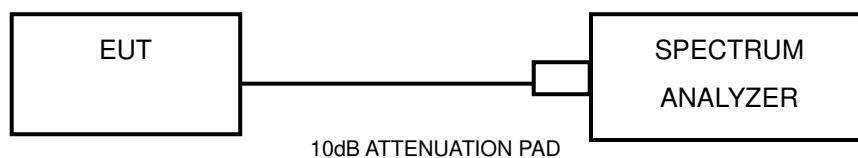

4.3.6 EUT OPERATING CONDITIONS

The software provided by client to enable the EUT under transmission condition continuously at lowest, middle and highest channel frequencies individually.

4.3.7 TEST RESULTS

802.11b

CHANNEL	CHANNEL FREQUENCY (MHz)	6dB BANDWIDTH (MHz)	MINIMUM LIMIT (MHz)	PASS / FAIL
1	2412	8.74	0.5	PASS
6	2437	8.75	0.5	PASS
11	2462	8.74	0.5	PASS

802.11g

CHANNEL	CHANNEL FREQUENCY (MHz)	6dB BANDWIDTH (MHz)	MINIMUM LIMIT (MHz)	PASS / FAIL
1	2412	16.47	0.5	PASS
6	2437	16.47	0.5	PASS
11	2462	16.47	0.5	PASS

802.11n HT20

CHANNEL	CHANNEL FREQUENCY (MHz)	6dB BANDWIDTH (MHz)	MINIMUM LIMIT (MHz)	PASS / FAIL
1	2412	17.16	0.5	PASS
6	2437	17.12	0.5	PASS
11	2462	17.15	0.5	PASS

802.11n HT40

CHANNEL	CHANNEL FREQUENCY (MHz)	6dB BANDWIDTH (MHz)	MINIMUM LIMIT (MHz)	PASS / FAIL
3	2422	36.54	0.5	PASS
6	2437	36.53	0.5	PASS
9	2452	36.52	0.5	PASS

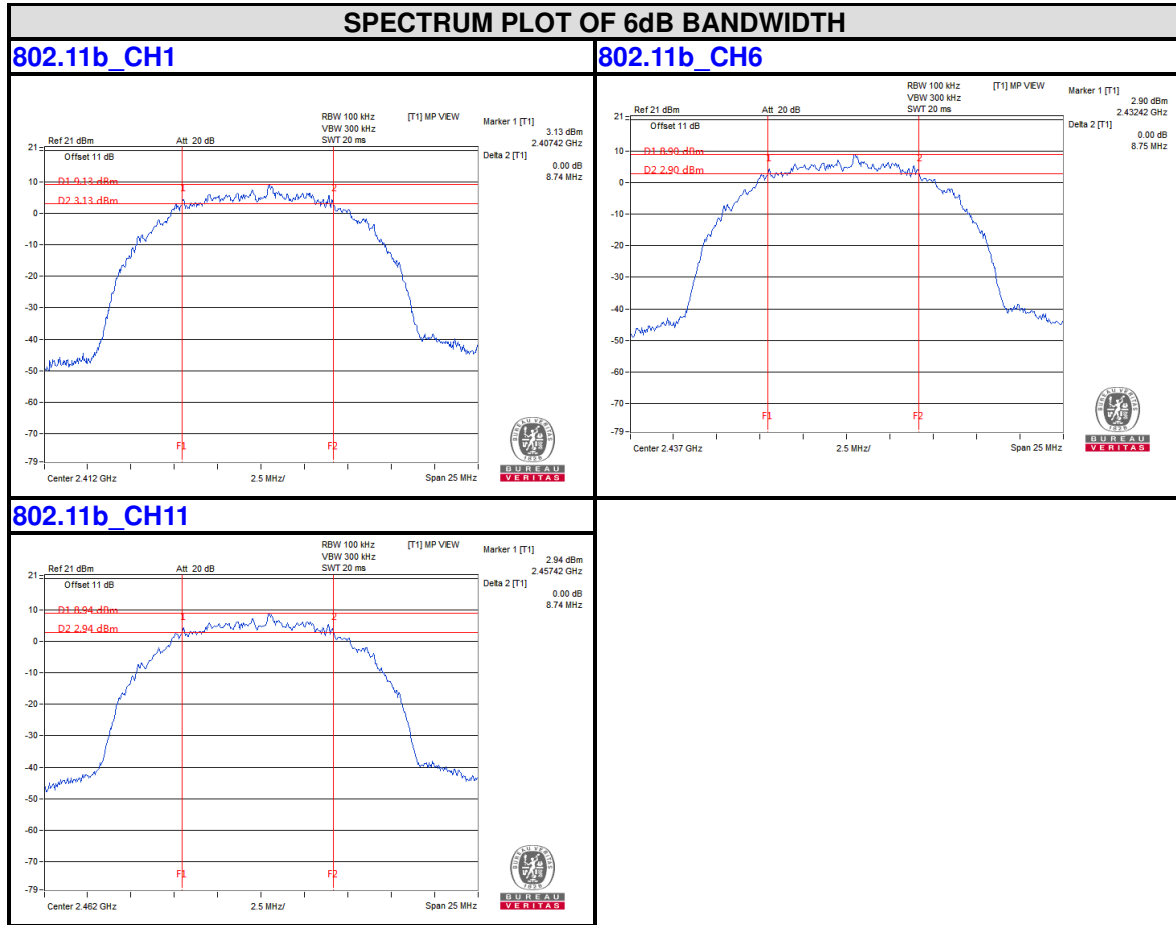

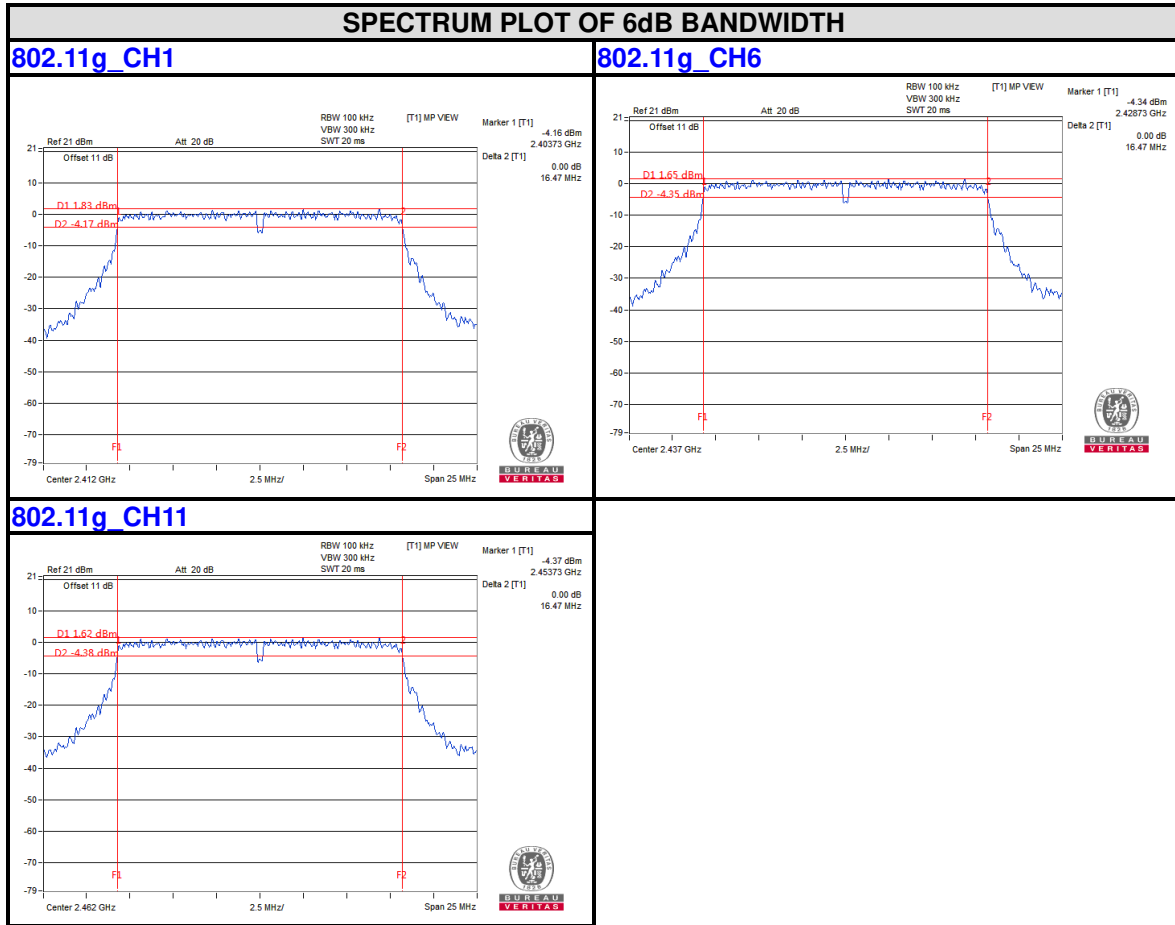

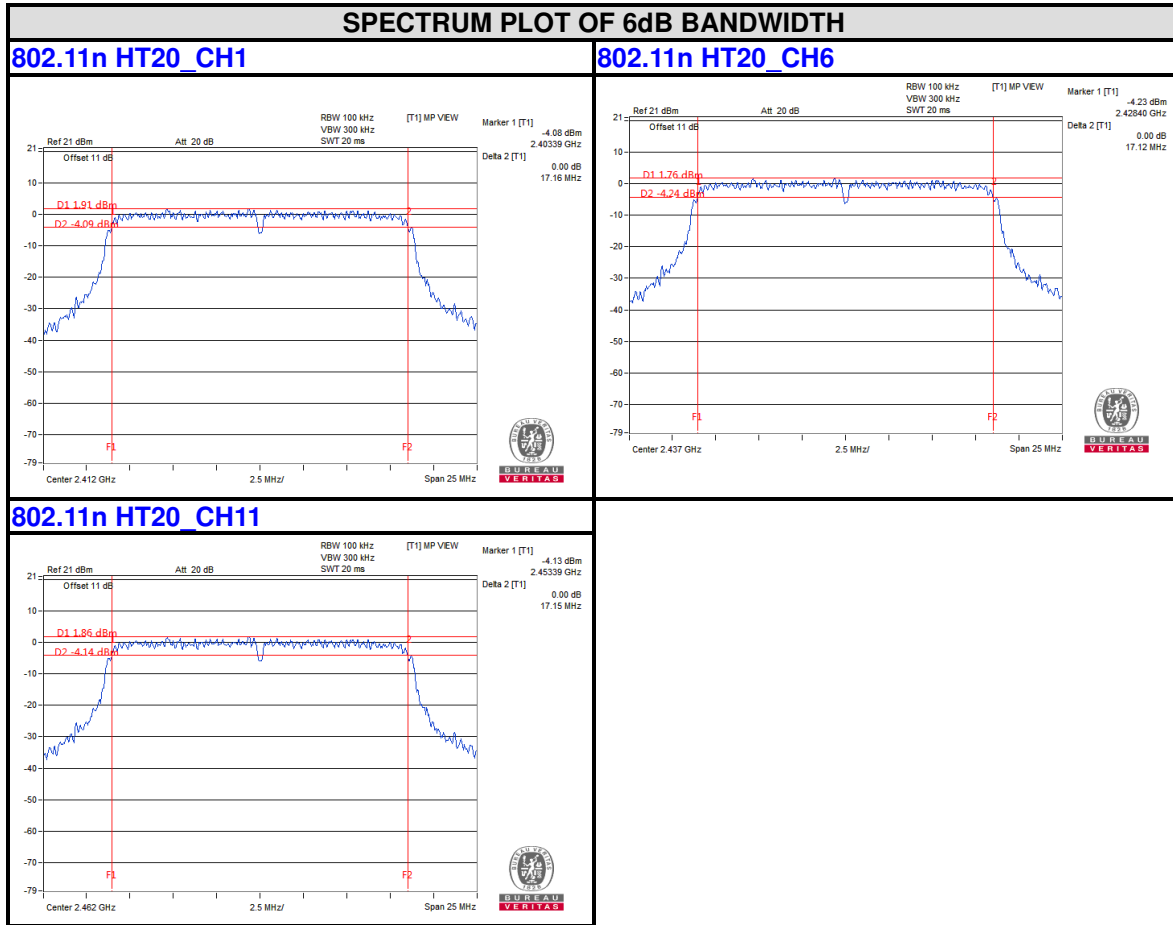

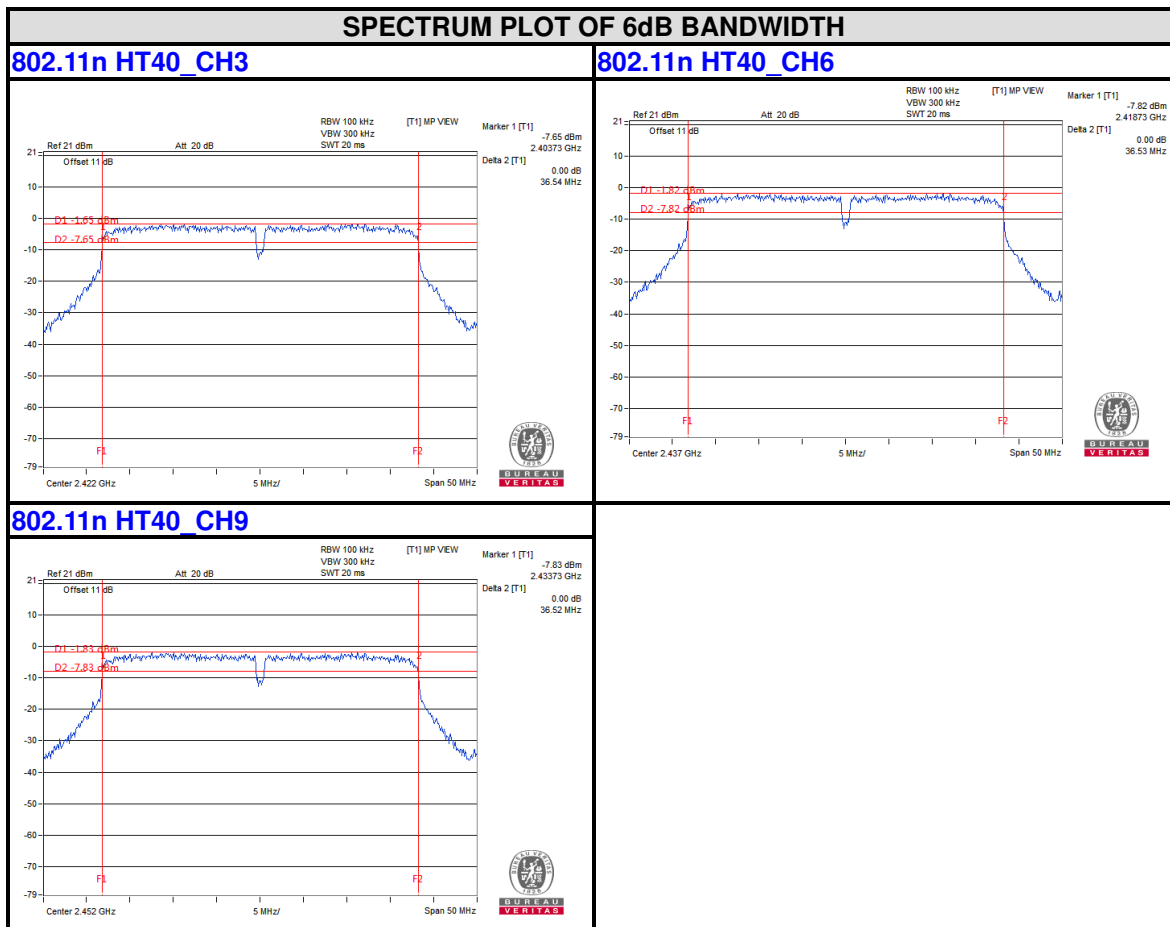

4.4 CONDUCTED OUTPUT POWER

4.4.1 LIMITS OF CONDUCTED OUTPUT POWER MEASUREMENT

For systems using digital modulation in the 2400–2483.5 MHz band: 1 Watt (30dBm).

4.4.2 TEST SETUP

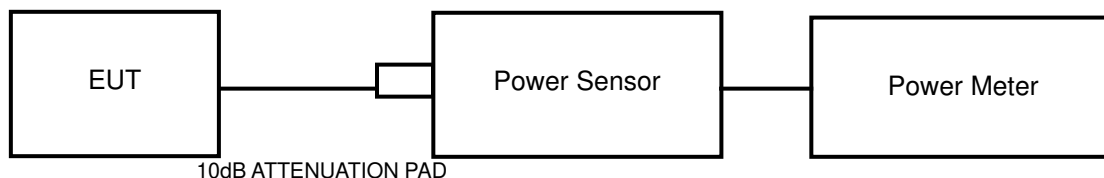

4.4.3 TEST INSTRUMENTS

Equipment	Manufacturer	Model No.	Serial No.	Next Cal.
Power Sensor	Keysight	U2021XA	MY57320002	Jan. 11, 24
Power Meter	Anritsu	ML2495A	1139001	Aug. 22, 24
Power Sensor	Anritsu	MA2411B	1531155	Aug. 22, 24
Digital Multimeter	FLUKE	15B	A1220010DG	N/A
Humid & Temp Programmable Tester	Haida	HD-225T	110807201	Nov. 02, 23
Oscilloscope	Agilent	DSO9254A	MY51260160	Jul. 27, 24
Signal and Spectrum Analyzer	Rohde&Schwarz	FSV40	101094	Jan. 11, 24
Signal Generator	Agilent	N5183A	MY50140980	Jul. 20, 24
MXG-B RF Vector Signal Generator	Keysight	N5182B	MY56200288	Jul. 20, 24
BLUETOOTH TESTER	Rohde&Schwarz	CBT32	100811	N/A
Attenuator	MINI	BW-S10W2+	S130129FGE2	N/A
DC Source	Keysight	E3642A	MY56146098	N/A
Test software	ADT	ADT_RF Test Software V6.6.5.3	N/A	N/A

NOTES:

1. The test was performed in RF Oven room.
2. The calibration interval of the above test instruments is 12 months and the calibrations are traceable to CEPREI/CHINA, GRGT/CHINA and NIM/CHINA.



4.4.4 TEST PROCEDURES

A peak power sensor was used on the output port of the EUT. A peak power meter was used to read the response of the peak power sensor. Record the peak power level.

4.4.5 DEVIATION FROM TEST STANDARD

No deviation.

4.4.6 EUT OPERATING CONDITIONS

The software provided by client to enable the EUT under transmission condition continuously at lowest, middle and highest channel frequencies individually.

4.4.7 TEST RESULTS

MAXIMUM PEAK OUTPUT POWER

802.11b

CHANNEL	CHANNEL FREQUENCY (MHz)	PEAK POWER (dBm)	PEAK POWER (mW)	PEAK POWER LIMIT (W)	PASS/FAIL
1	2412	25.91	389.942	1	PASS
6	2437	25.75	375.837	1	PASS
11	2462	25.56	359.749	1	PASS

802.11g

CHANNEL	CHANNEL FREQUENCY (MHz)	PEAK POWER (dBm)	PEAK POWER (mW)	PEAK POWER LIMIT (W)	PASS/FAIL
1	2412	24.35	272.270	1	PASS
6	2437	24.19	262.422	1	PASS
11	2462	24.21	263.633	1	PASS

802.11n HT20

CHANNEL	CHANNEL FREQUENCY (MHz)	PEAK POWER (dBm)	PEAK POWER (mW)	PEAK POWER LIMIT (W)	PASS/FAIL
1	2412	24.56	285.759	1	PASS
6	2437	24.31	269.774	1	PASS
11	2462	24.26	266.686	1	PASS

02.11n HT40

CHANNEL	CHANNEL FREQUENCY (MHz)	PEAK POWER (dBm)	PEAK POWER (mW)	PEAK POWER LIMIT (W)	PASS/FAIL
3	2422	24.25	266.073	1	PASS
6	2437	23.88	244.343	1	PASS
9	2452	23.85	242.661	1	PASS

AVERAGE OUTPUT POWER (FOR REFERENCE)

The average power sensor was used on the output port of the EUT. A power meter was used to read the response of the power sensor. Record the power level.

802.11b

CHANNEL	CHANNEL FREQUENCY (MHz)	AVERAGE POWER (dBm)	AVG. POWER (mW)
1	2412	18.76	75.162
6	2437	18.46	70.146
11	2462	18.38	68.865

802.11g

CHANNEL	CHANNEL FREQUENCY (MHz)	AVERAGE POWER (dBm)	AVG. POWER (mW)
1	2412	16.58	45.499
6	2437	16.42	43.853
11	2462	16.38	43.451

802.11n HT20

CHANNEL	CHANNEL FREQUENCY (MHz)	AVERAGE POWER (dBm)	AVG. POWER (mW)
1	2412	16.51	44.771
6	2437	16.22	41.879
11	2462	16.21	41.783

802.11n HT40

CHANNEL	CHANNEL FREQUENCY (MHz)	AVERAGE POWER (dBm)	AVG. POWER (mW)
3	2422	15.84	38.371
6	2437	15.45	35.075
9	2452	15.42	34.834

Note: The above power values include duty cycle factors.

4.5 POWER SPECTRAL DENSITY MEASUREMENT

4.5.1 LIMITS OF POWER SPECTRAL DENSITY MEASUREMENT

The Maximum of Power Spectral Density Measurement is 8dBm/3KHz.

4.5.2 TEST SETUP

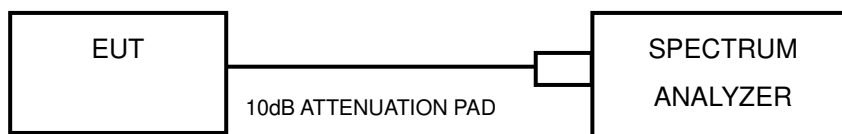

4.5.3 TEST INSTRUMENTS

Refer to section 4.3.2 to get information of above instrument.

4.5.4 TEST PROCEDURE

- a) Set instrument center frequency to DTS channel center frequency.
- b) Set span to 1.5 times the DTS bandwidth.
- c) Set RBW to: 3KHz
- d) Set VBW $\geq 3 \times$ RBW.
- e) Detector = peak
- f) Ensure that the number of measurement points in the sweep $\geq 2 \times$ span/RBW.
- g) Sweep time = auto couple.
- h) Use the peak marker function to determine the maximum amplitude level.

4.5.5 DEVIATION FROM TEST STANDARD

No deviation.

4.5.6 EUT OPERATING CONDITION

Same as item 4.3.6.

4.5.7 TEST RESULTS

802.11b

Channel	FREQ. (MHz)	PSD (dBm/3kHz)	Limit (dBm/3kHz)	PASS /FAIL
1	2412	-7.12	8.00	PASS
6	2437	-7.29	8.00	PASS
11	2462	-7.25	8.00	PASS

802.11g

Channel	FREQ. (MHz)	PSD (dBm/3kHz)	Limit (dBm/3kHz)	PASS /FAIL
1	2412	-13.31	8.00	PASS
6	2437	-13.51	8.00	PASS
11	2462	-13.33	8.00	PASS

802.11n HT20

Channel	FREQ. (MHz)	PSD (dBm/3kHz)	Limit (dBm/3kHz)	PASS /FAIL
1	2412	-12.91	8.00	PASS
6	2437	-12.83	8.00	PASS
11	2462	-13.40	8.00	PASS

802.11n HT40

Channel	FREQ. (MHz)	PSD (dBm/3kHz)	Limit (dBm/3kHz)	PASS /FAIL
3	2422	-15.19	8.00	PASS
6	2437	-14.64	8.00	PASS
9	2452	-14.59	8.00	PASS

Note: The above PSD values include duty cycle factors.

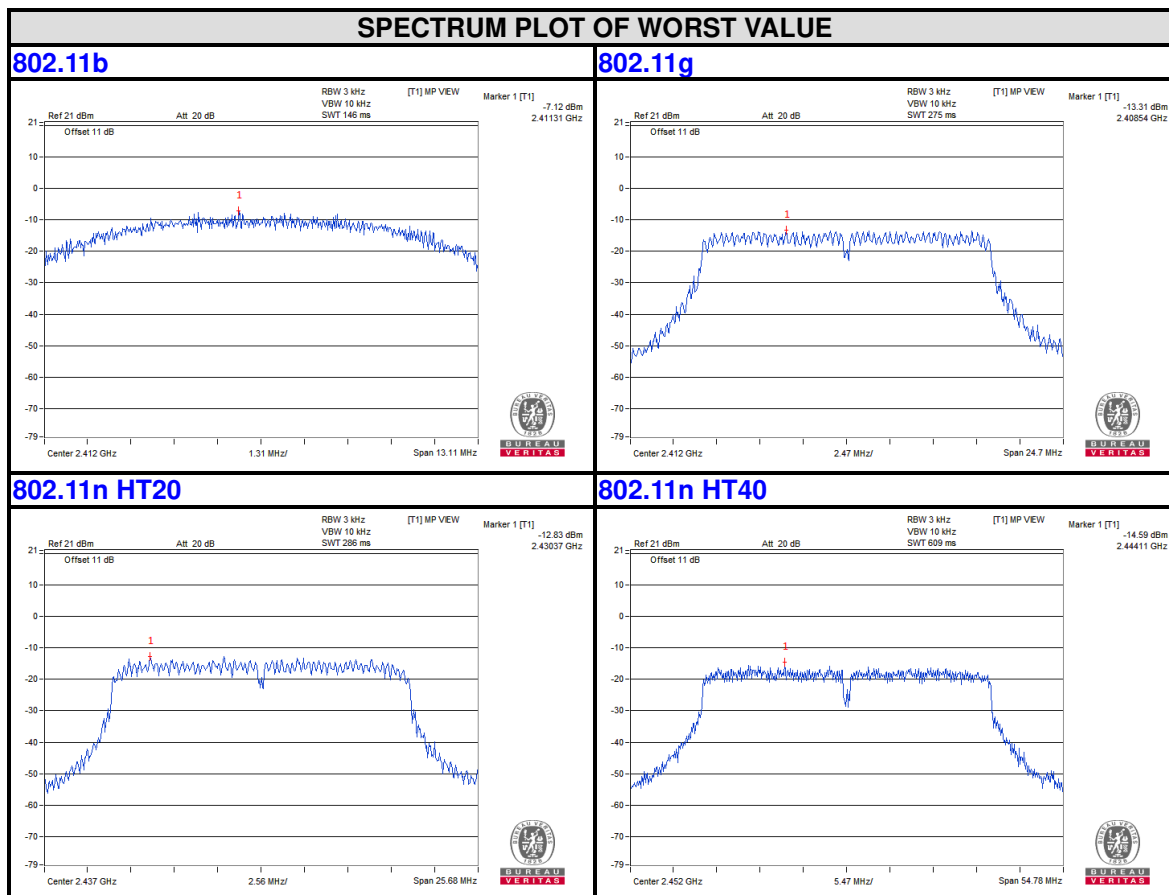

4.6 OUT OF BAND EMISSION MEASUREMENT

4.6.1 LIMITS OF OUT OF BAND EMISSION MEASUREMENT

Below -20dB of the highest emission level of operating band (in 100kHz Resolution Bandwidth).

4.6.2 TEST SETUP



4.6.3 TEST INSTRUMENTS

Refer to section 4.3.2 to get information of above instrument.

4.6.4 TEST PROCEDURE

Measurement Procedure - Reference Level

1. Set the RBW = 100 kHz.
2. Set the VBW \geq 300 kHz.
3. Detector = peak.
4. Sweep time = auto couple.
5. Trace mode = max hold.
6. Allow trace to fully stabilize.
7. Use the peak marker function to determine the maximum power level in any 100 kHz band segment within the fundamental EBW.

Measurement Procedure –Unwanted Emission Level

1. Set RBW = 100 kHz.
2. Set VBW \geq 300 kHz.
3. Set span to encompass the spectrum to be examined
4. Detector = peak.
5. Trace Mode = max hold.
6. Sweep = auto couple.

4.6.5 DEVIATION FROM TEST STANDARD

No deviation.

4.6.6 EUT OPERATING CONDITION

Same as item 4.3.6

4.6.7 TEST RESULTS

802.11b

CH 1

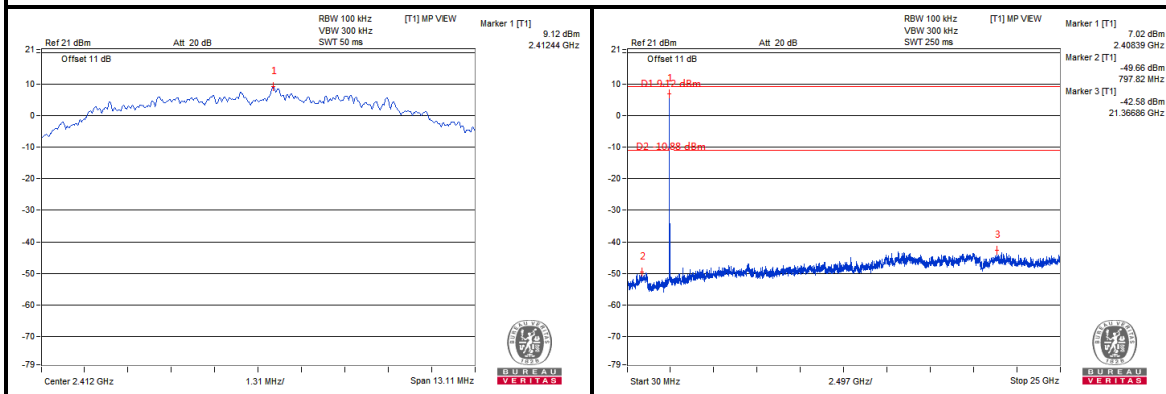

CH 6

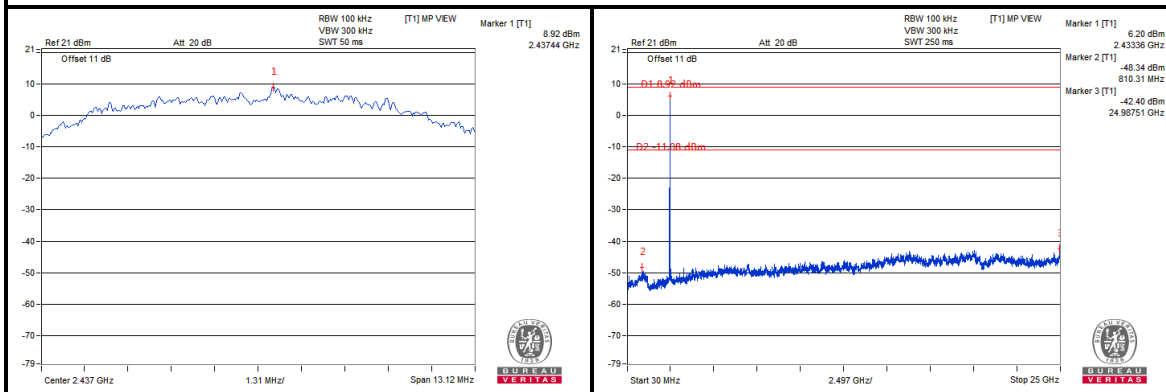

CH 11

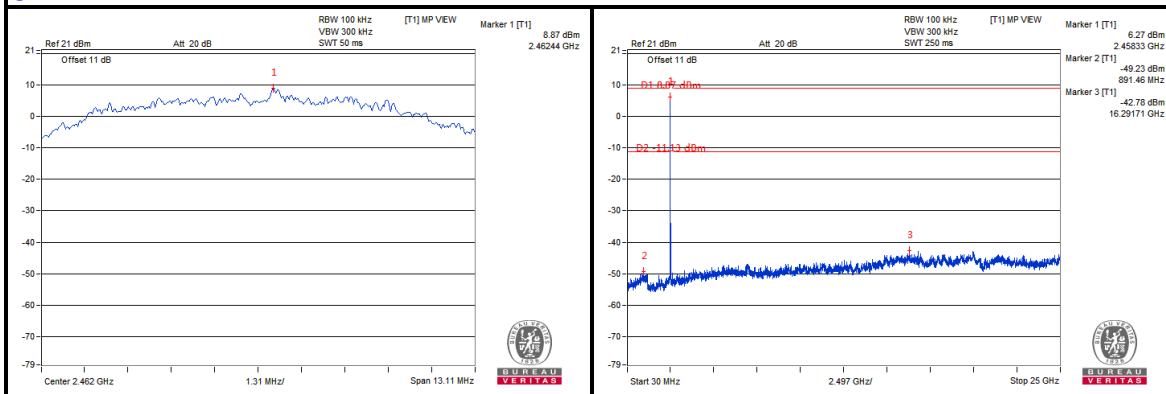

802.11g

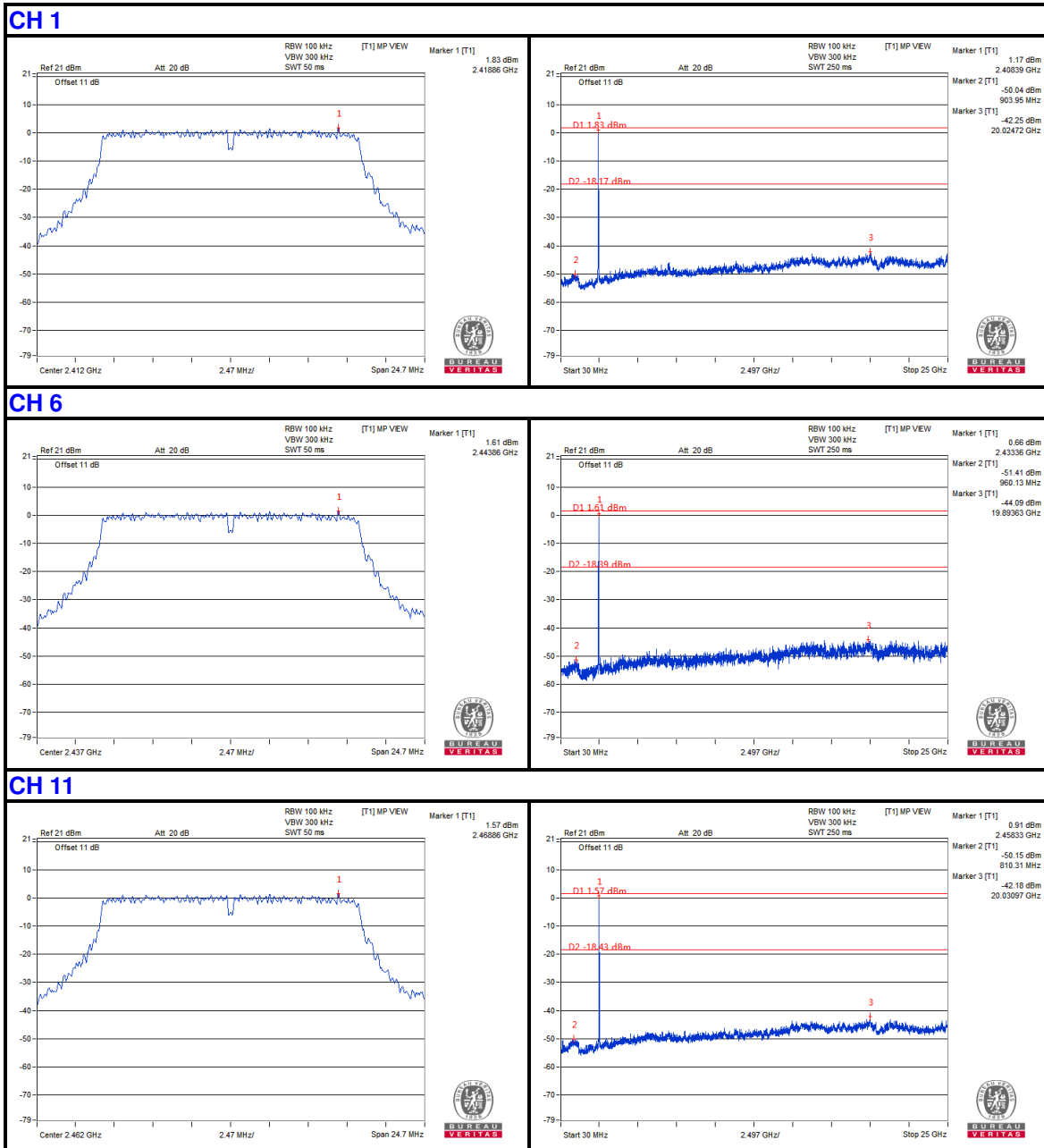

802.11n HT20

CH 1

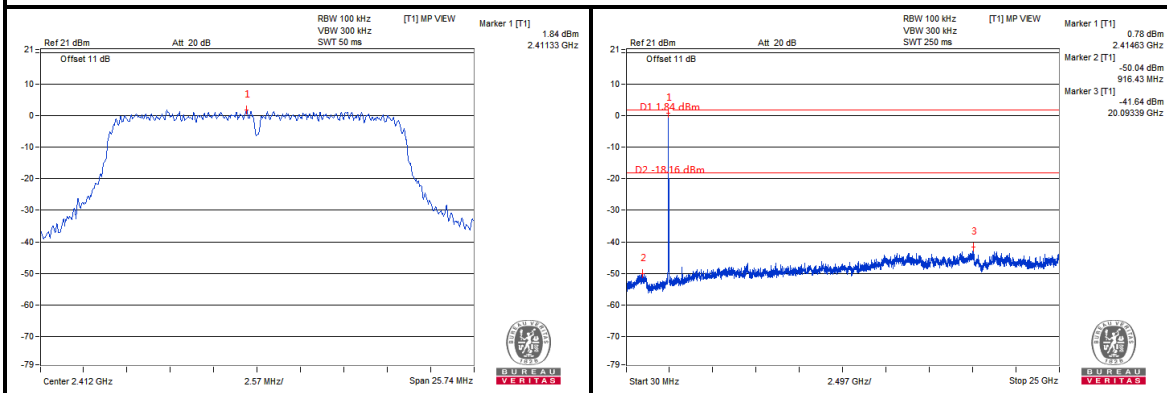

CH 6

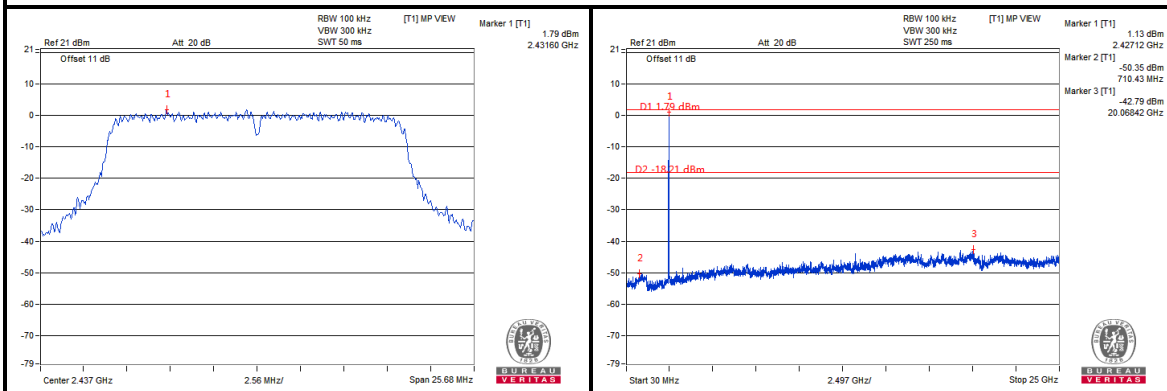

CH 11

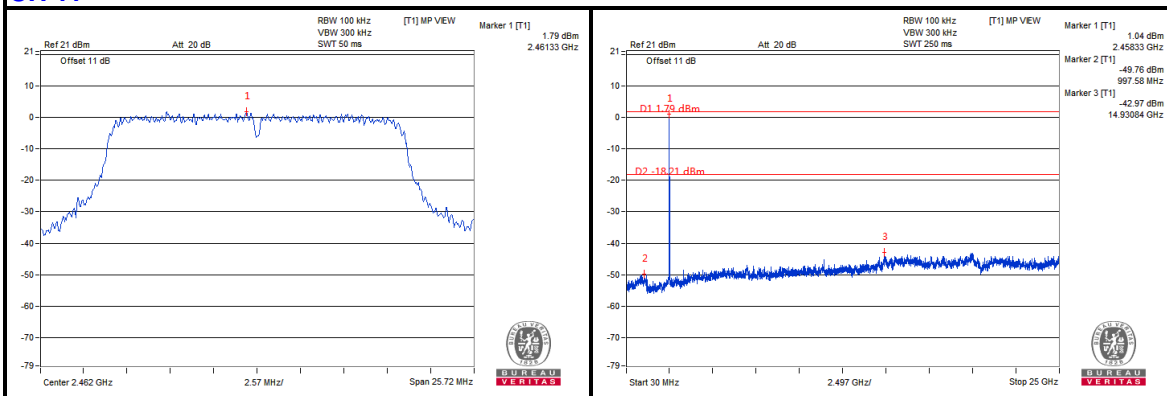

802.11n HT40

CH 3

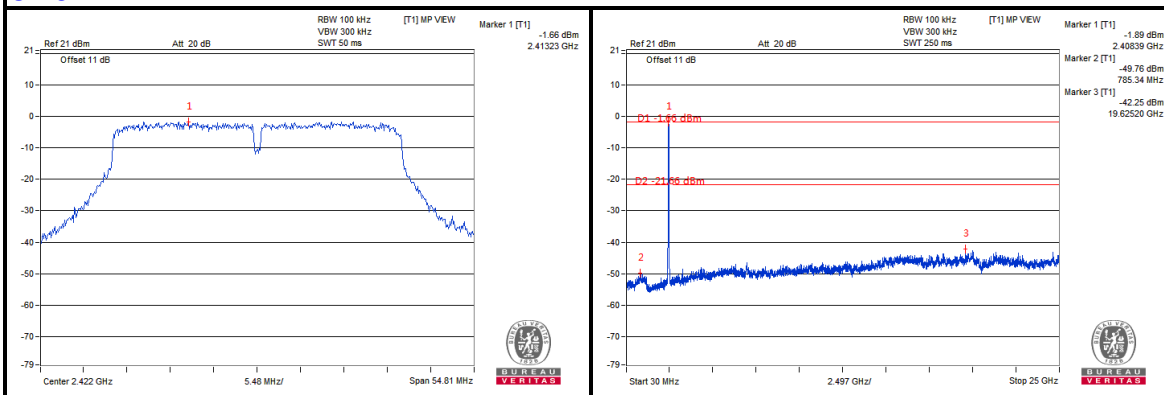

CH 6

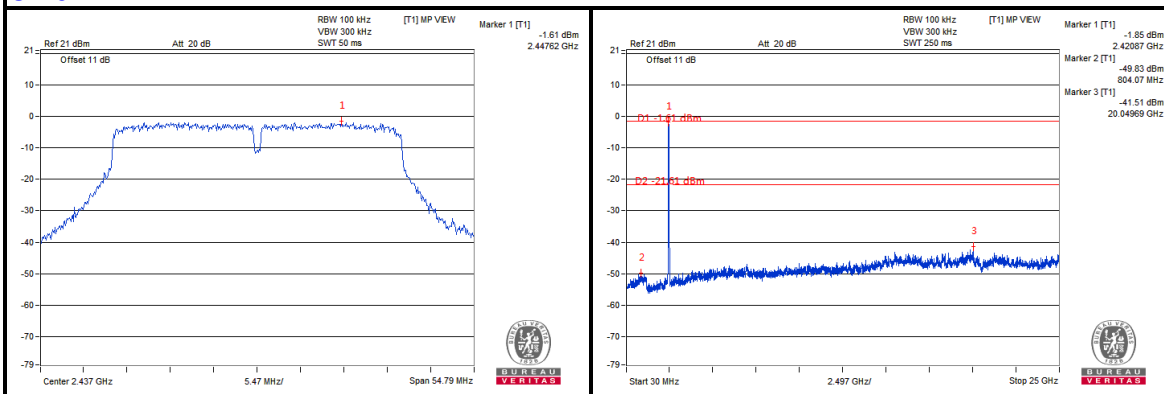

CH 9

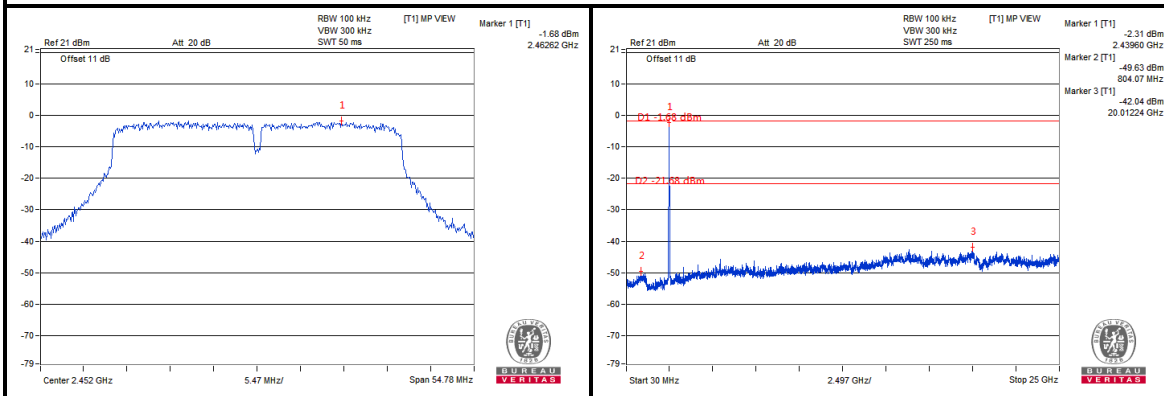

802.11b

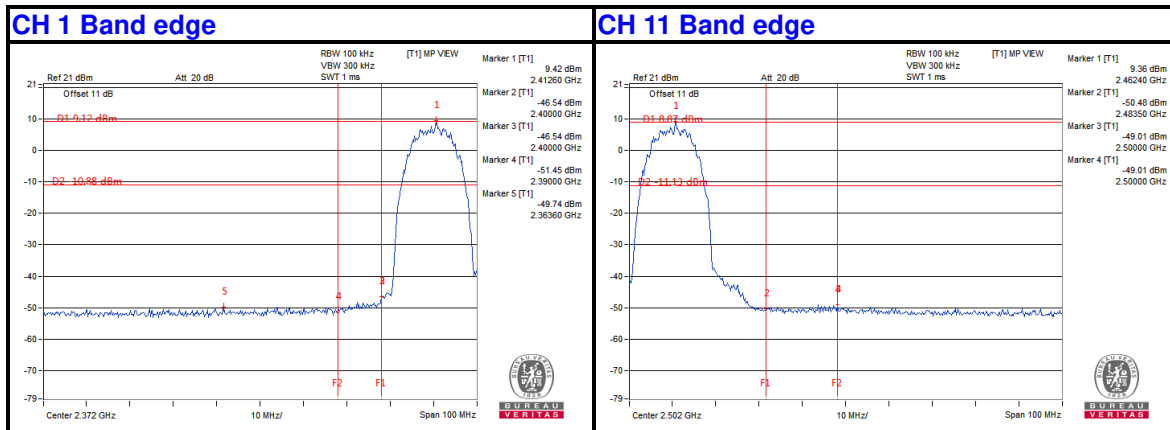

802.11g

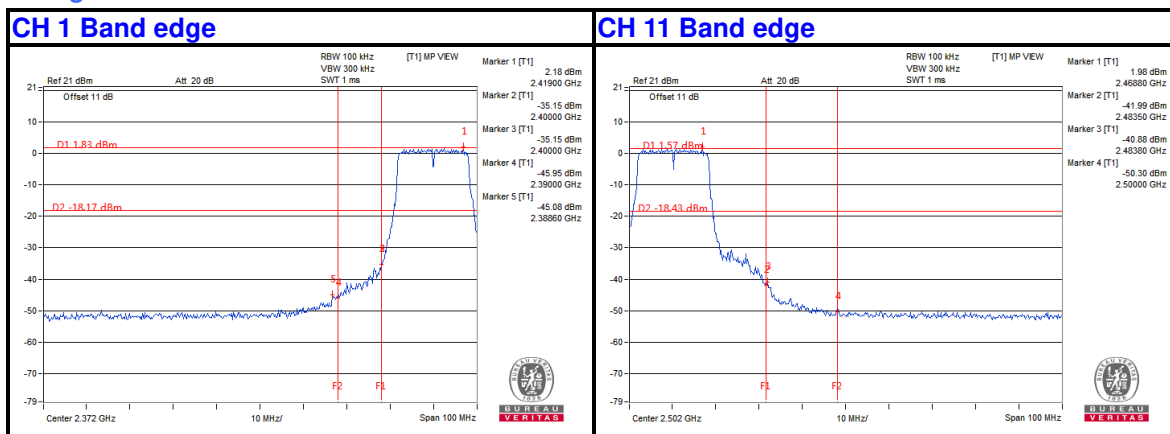

802.11n HT20

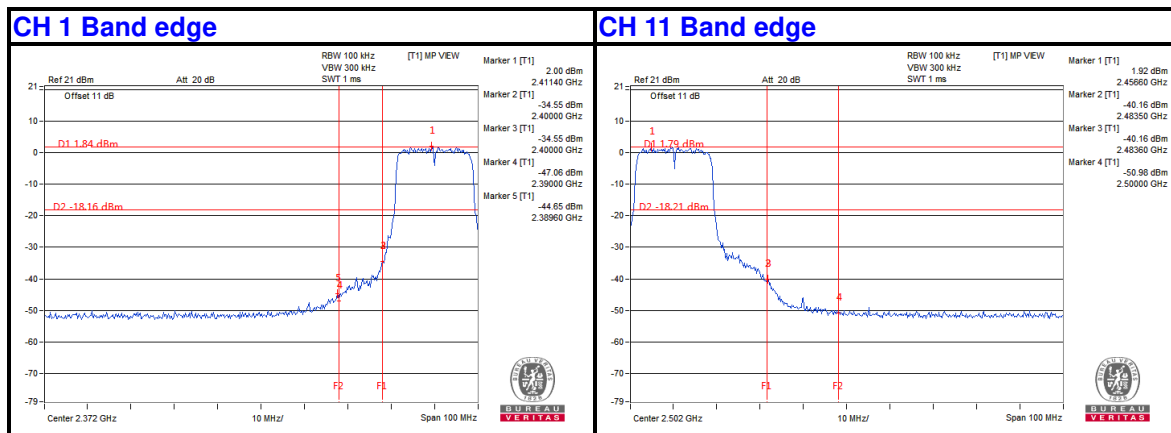

802.11n HT40

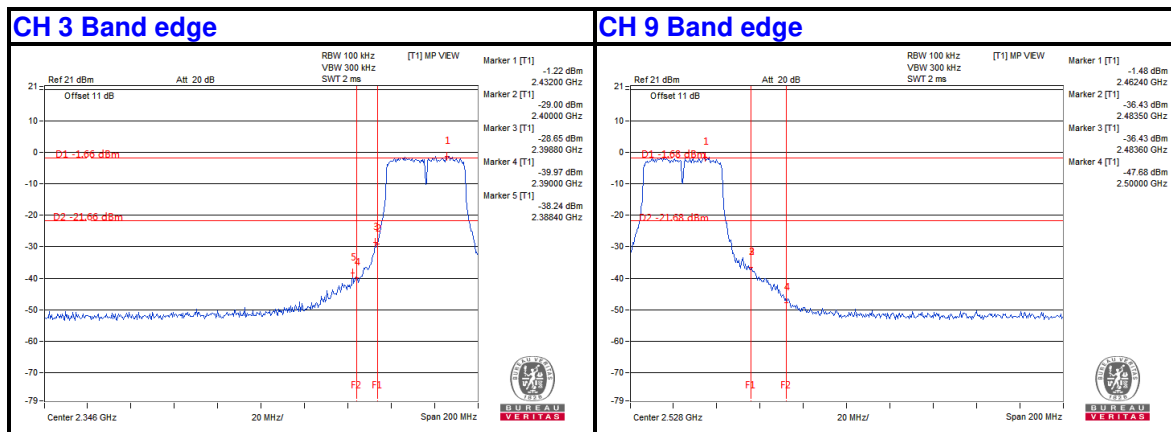



Test Report No.: RF2309WDG0199-1

5 PHOTOGRAPHS OF THE TEST CONFIGURATION

Please refer to the attached file (Test Setup Photo).



Test Report No.: RF2309WDG0199-1

6 APPENDIX A - MODIFICATIONS RECORDERS FOR ENGINEERING CHANGES TO THE EUT BY THE LAB

No any modifications are made to the EUT by the lab during the test.

---END---